

Food intake disorders - part I: Pathophysiology of obesity, insulin resistance, concept of metabolic syndrome

Body weight
Adipose tissue
Regulation of food intake
Adipokines
Overweight/obesity
Metabolic syndrome



Body weight

- adipose tissue
 - males ~10–20% of body weight
 - females 20–30% of body weight
- body weight **increases with age** in both genders
- it is a **continuous trait**, establishing a normal range is arbitrary to a certain extent
 - ideal weight is associated with the longest life- expectancy
- body weight is viewed also in the cultural, geographical and historical context
- obesity is one of many symptoms in some diseases – especially of endocrine ones, e.g.
 - hypothyroidism
 - Cushing syndrome
 - hypogonadism
- however, the majority of obese subjects are affected by “common” obesity of multifactorial origin

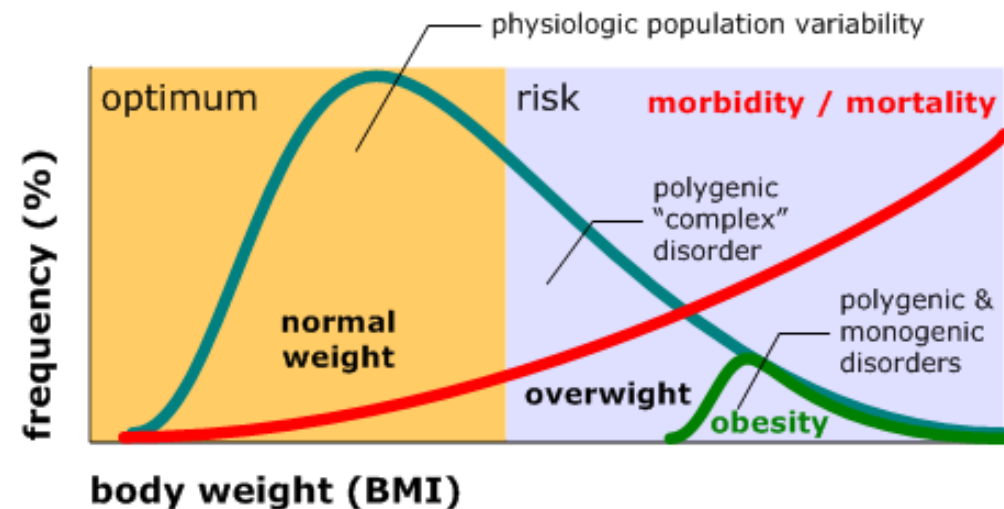

Measurement of body weight & body composition

- **BMI** (body mass index)
 - malnutrition BMI <18.5
 - normal weight 20 – 24.9
 - overweight 25 – 29.9
 - obesity BMI >30 (mild 30 – 34.9, moderate 35 - 40, morbid >40)
 - BMI unfortunately doesn't indicate the distribution of fat = android (male pattern, apple) and gynoid (female pattern, pear)
 - the male pattern has more health-risks
- fat distribution is more precisely reflected in **WHR index** (waist-hip ratio)
- nowadays it's common to measure just **waist circumference**
 - females: mild risk > 80 cm, high risk > 88 cm
 - males >94 and >102 cm, respectively
- the thickness of **skin fold**
- exact measurement of body fat content
 - underwater weighing
 - conductance (bioimpedance)
 - computer tomography and magnetic resonance
 - DEXA (dual-energy X-ray absorptiometry)
 - isotopes



Adipocyte = cell specialised to accumulate lipids

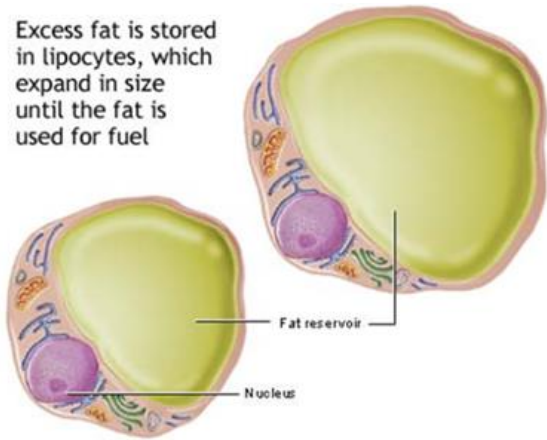

- function of adipocytes

- mechanical support / protection
- thermoinsulation
- energy store

- **endocrine organ** ($\sim 1 \times 10^9$ of cells = **by far the largest!!!**)

- insulin-sensitizing factors (negatively correlating with the number of adipocytes)
 - **few adipocytes = muscle has to be very insulin sensitive in order to utilize Glc?**
- insulin-desensitizing factors (positively correlating with the number of adipocytes)
 - when NEFA plentiful utilization of Glc in the muscle does not need to be efficient?
- pro-inflammatory factors (cytokines) → **low-grade inflammation**

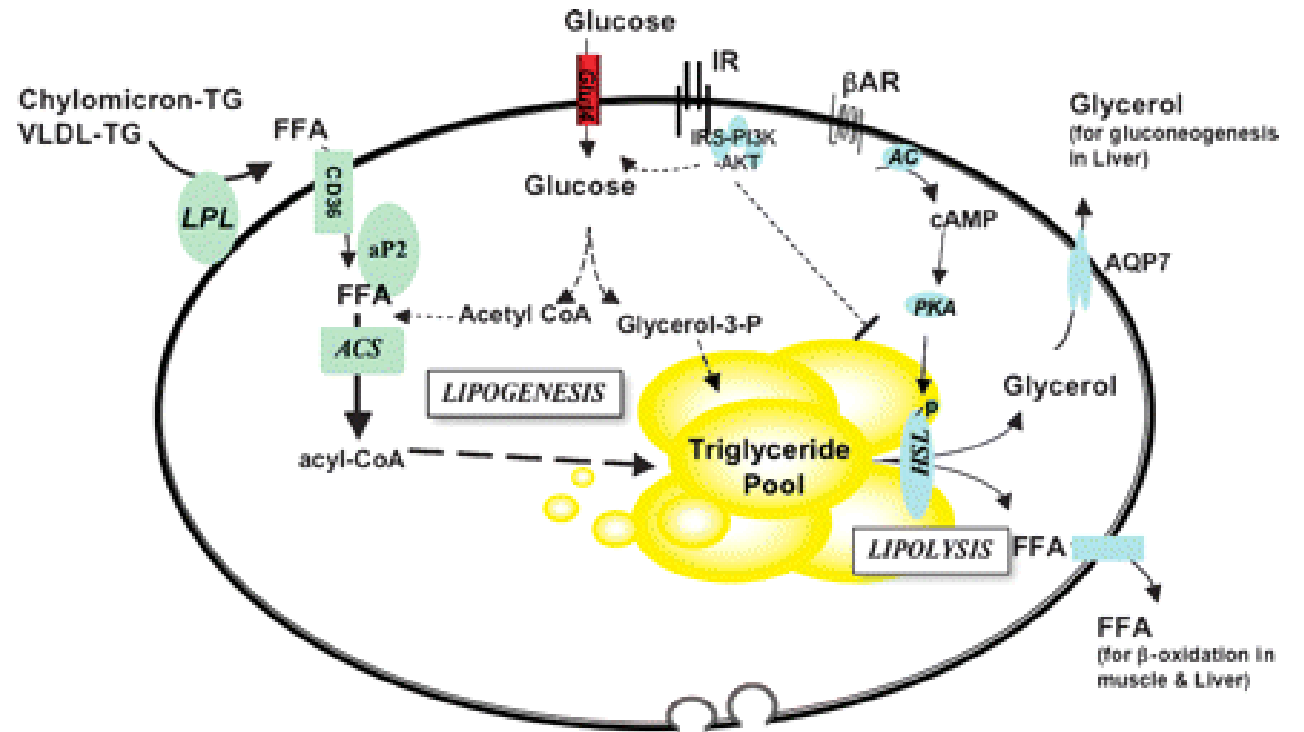

Formation and utilization of lipid stores

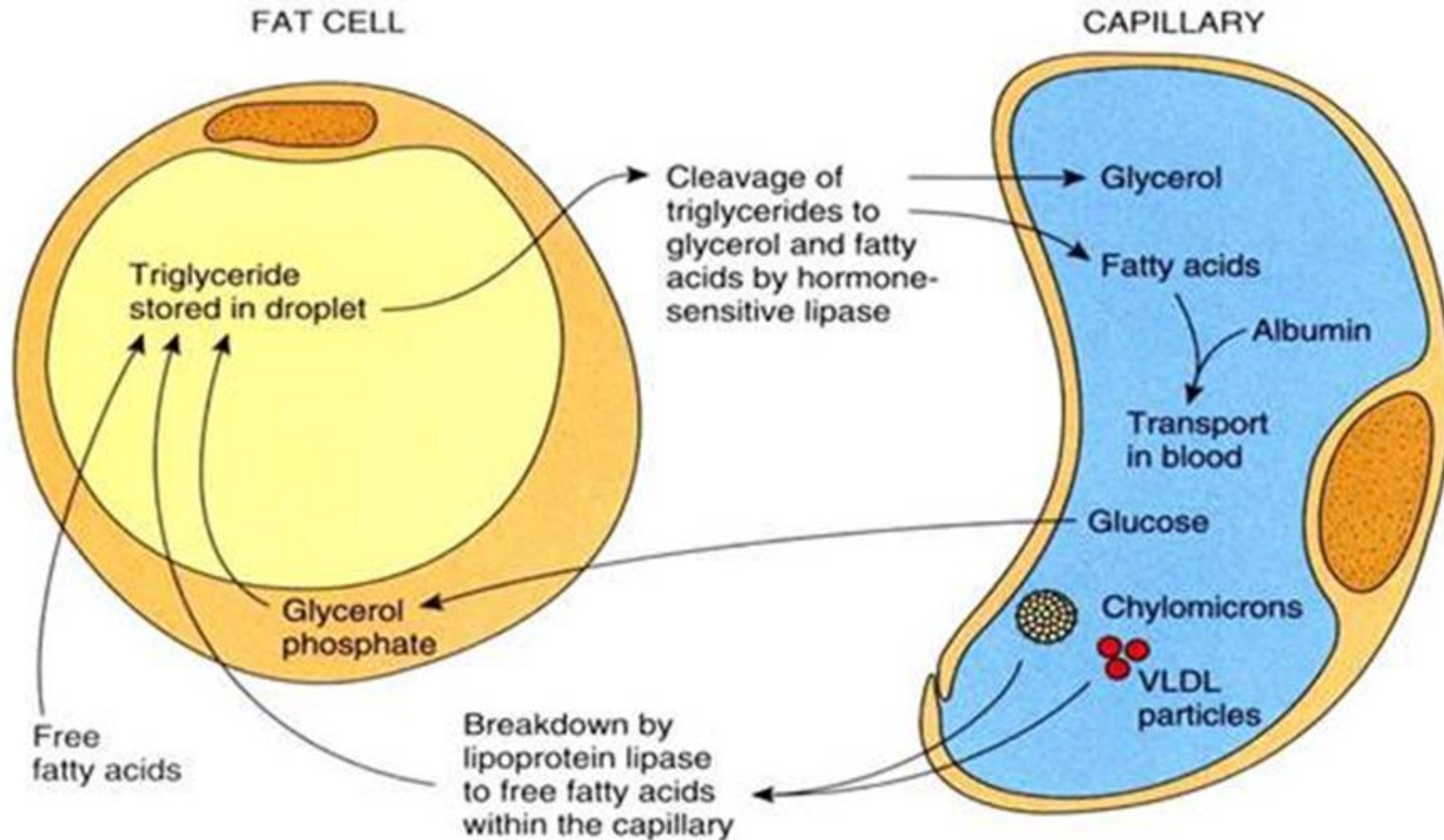

Evolution of obesity and inflammation



- ability to store energy for periodical fasting was equally important as the ability to fight infection
 - **biologically interconnected systems for energy storage and immune reaction developed**
 - single system in lower organisms (e.g. fat body in insects)
 - separate systems in higher organisms (liver, adipose tissue, bone marrow), but dynamic cooperation
 - hormones of adipose tissue and nutrients regulate immunity (e.g. via Toll-like receptors)
 - the interaction exists even within organs
 - e.g. liver: hepatocytes/adipocytes/Kupffer cells
- two periodically changing situations required the redistribution of energy
 - fasting (or danger) → stress reaction → decline of immunity
 - ↑ glucocorticoids / ↓ lymphocytes
 - storage of energy → production of humoral factors in fat tissue with pro-inflammatory effect → removal of pathogens

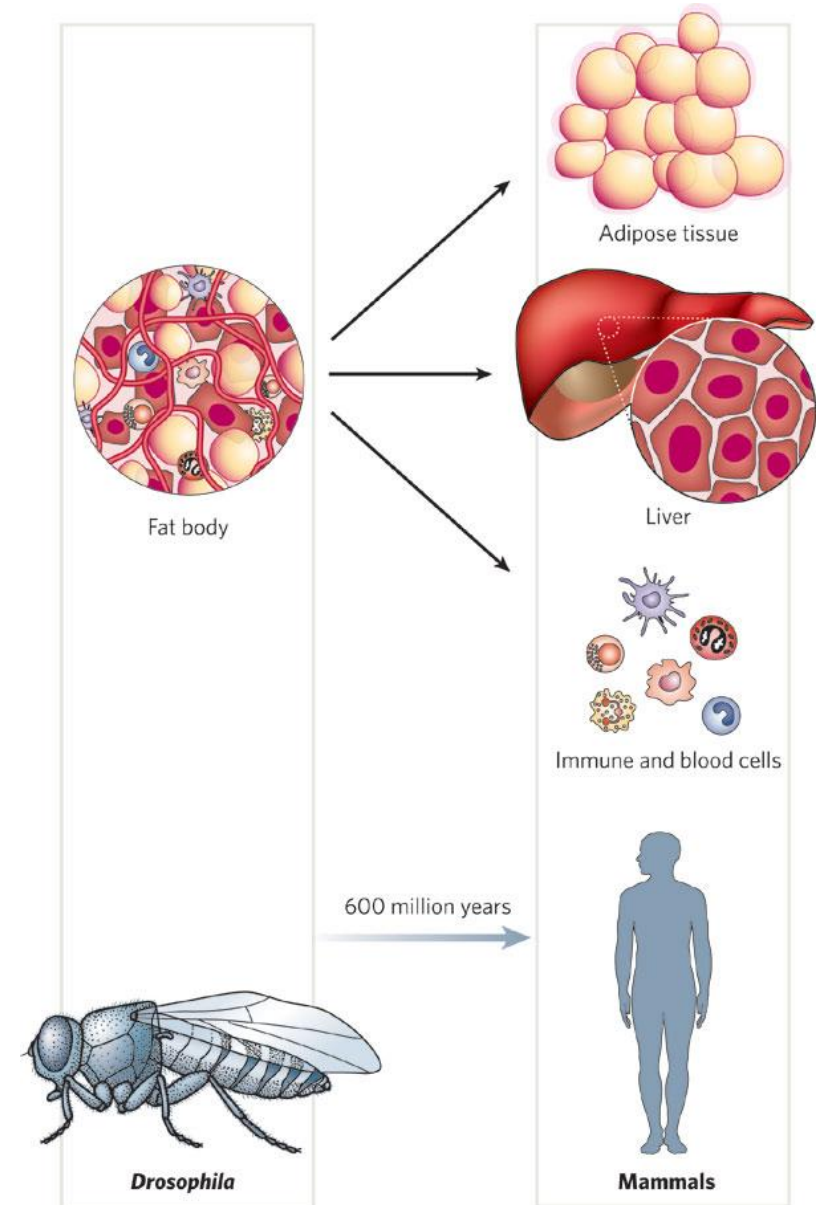

Fat distribution

- “**brown**” adipose tissue (BAT) – newborns
 - neck, back, around large vessels = thermoregulation
 - mitochondrial “uncoupling” of oxidation of FFA and ATP synthesis
- “**white**” (WAT) stored at
 - **subcutaneous** adipose tissue
 - aesthetic but not metabolic catastrophe
 - **visceral** adipose tissue
 - intra-abdominally – e.g. omentum, mesenterium
 - retroperitoneally
 - others
 - epicardium
 - local source of FFA?
 - possible paracrine effect of secreted factors on the heart
 - orbital, joints, synovia
 - **ectopic intra-organ** in muscles and liver
 - two important organs influencing insulin sensitivity
 - ↑ NEFA
 - ↑ adipokines

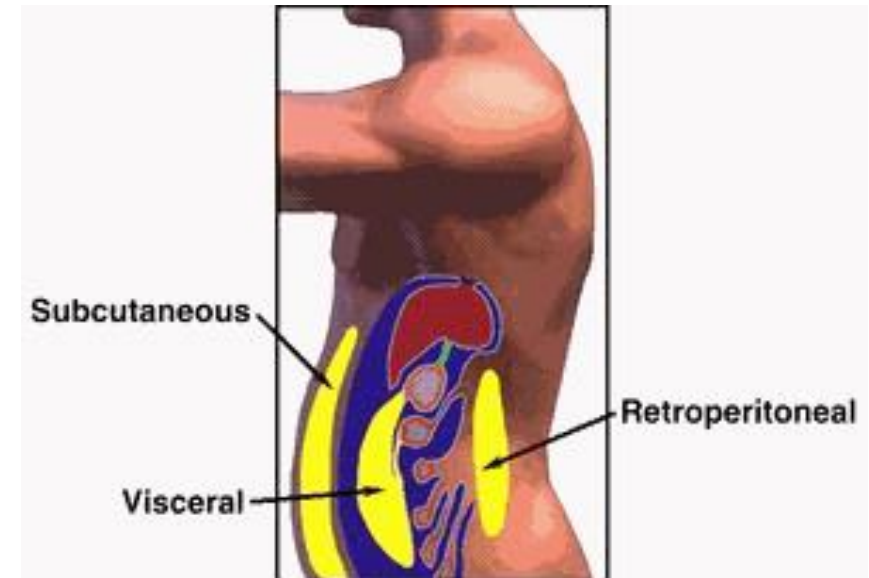
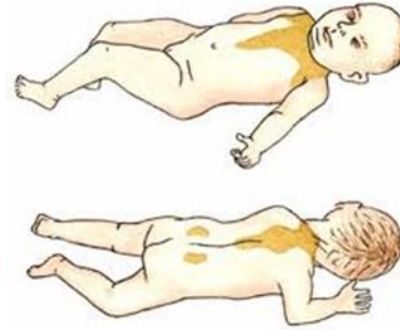

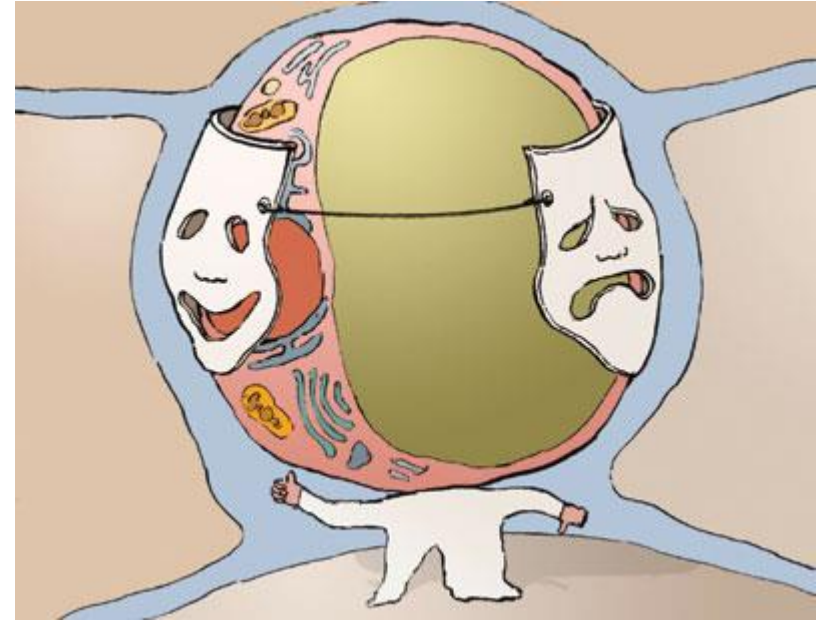

CHARACTERISTICS OF DIFFERENT TYPES OF ADIPOSE TISSUE

(1) Brown adipose tissue (BAT)

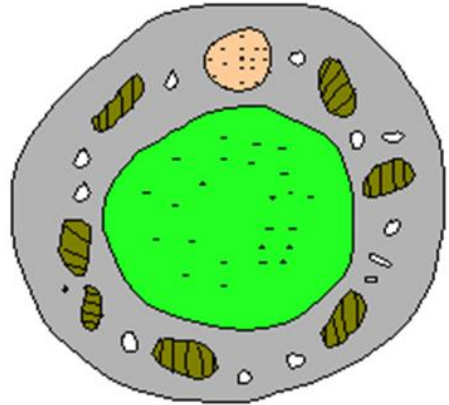

white fat cell

- well-known role in non-shiver thermogenesis in newborns and small mammals
- but adults have still some metabolically active BAT!
 - dispersed in white adipose tissue
- initial mass and ability to differentiate new BAT can influence interindividual predisposition to obesity or metabolic syndrome
 - genetics?

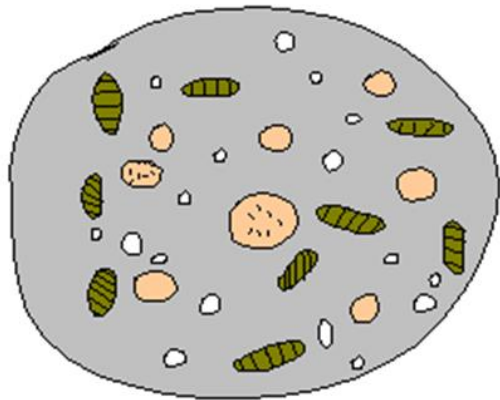

brown fat cell

| | WAT | BAT |
|-----------------|--|--|
| function | energy storage | production of heat |
| morphology | single droplet of triglycerides, variable amount of mitochondria | multiple droplets of triglycerides, large amount of mitochondria |
| typ. protein | leptin | UCP-1 |
| origin | Myf5-negat. progenitor. cells | Myf5-posit. progenitor. cells |
| humans | ↑ mass associated with health risks | ↑ mass associated with benefits |
| during the life | ↑ mass | ↓ mass |

BAT

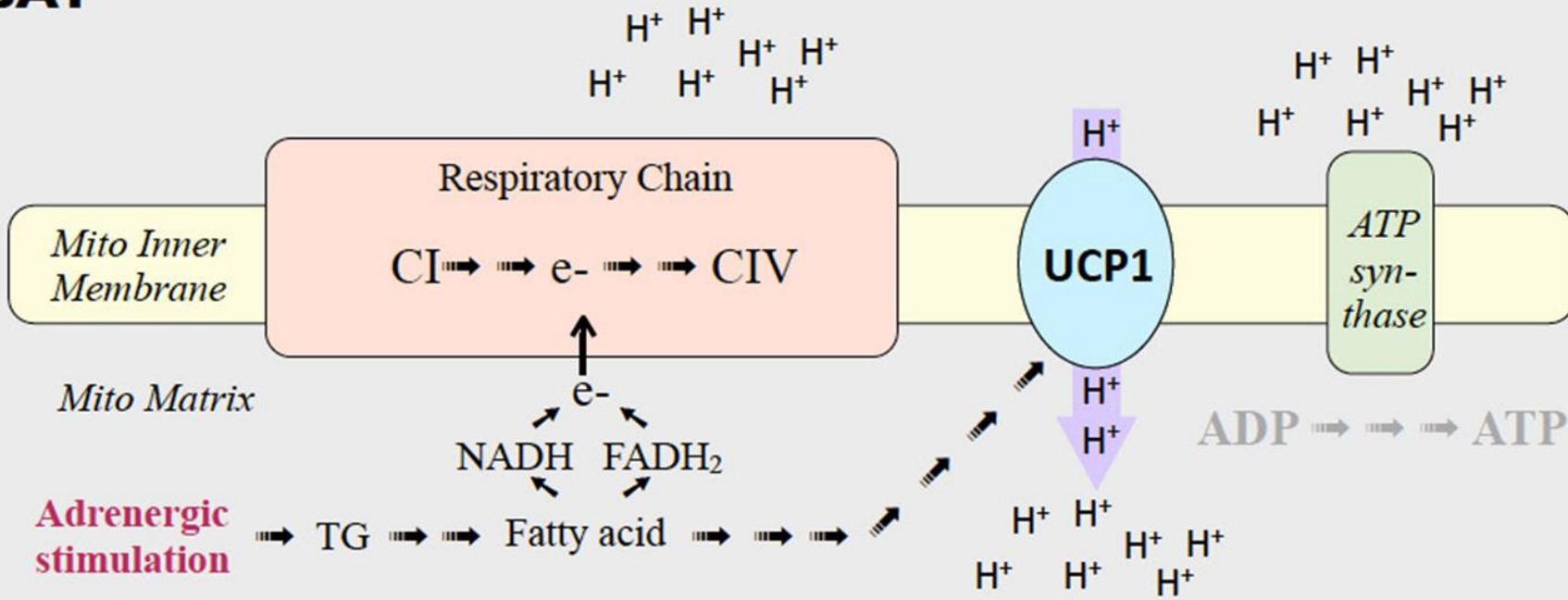

Most tissues

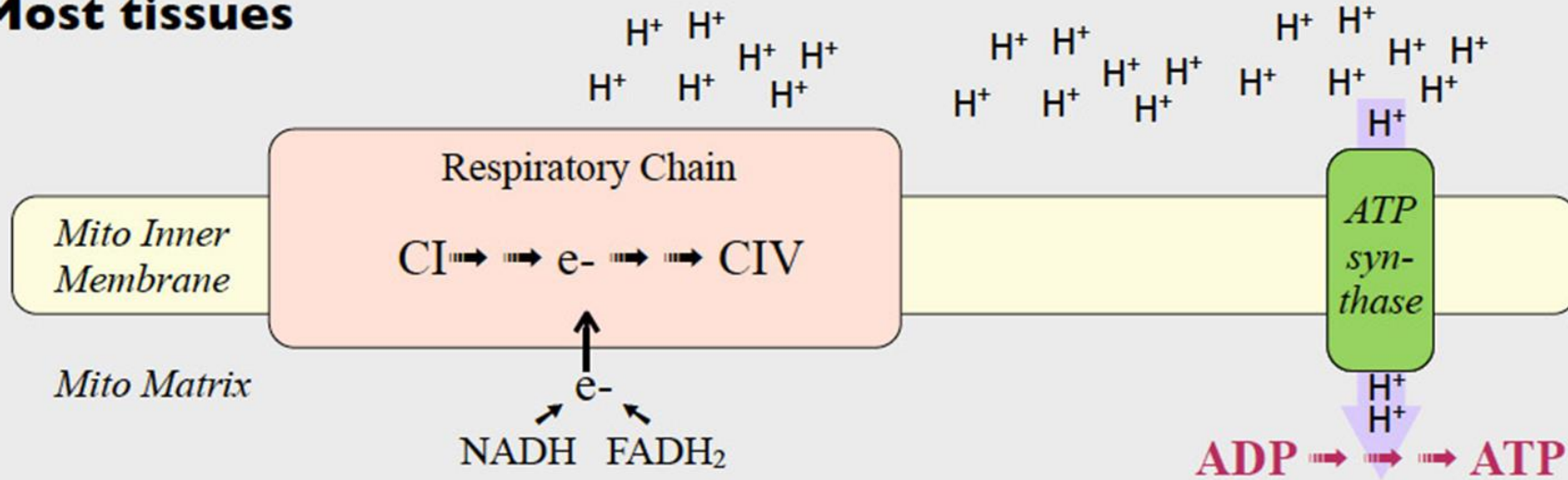

Mitochondrial Electron Transport Chain

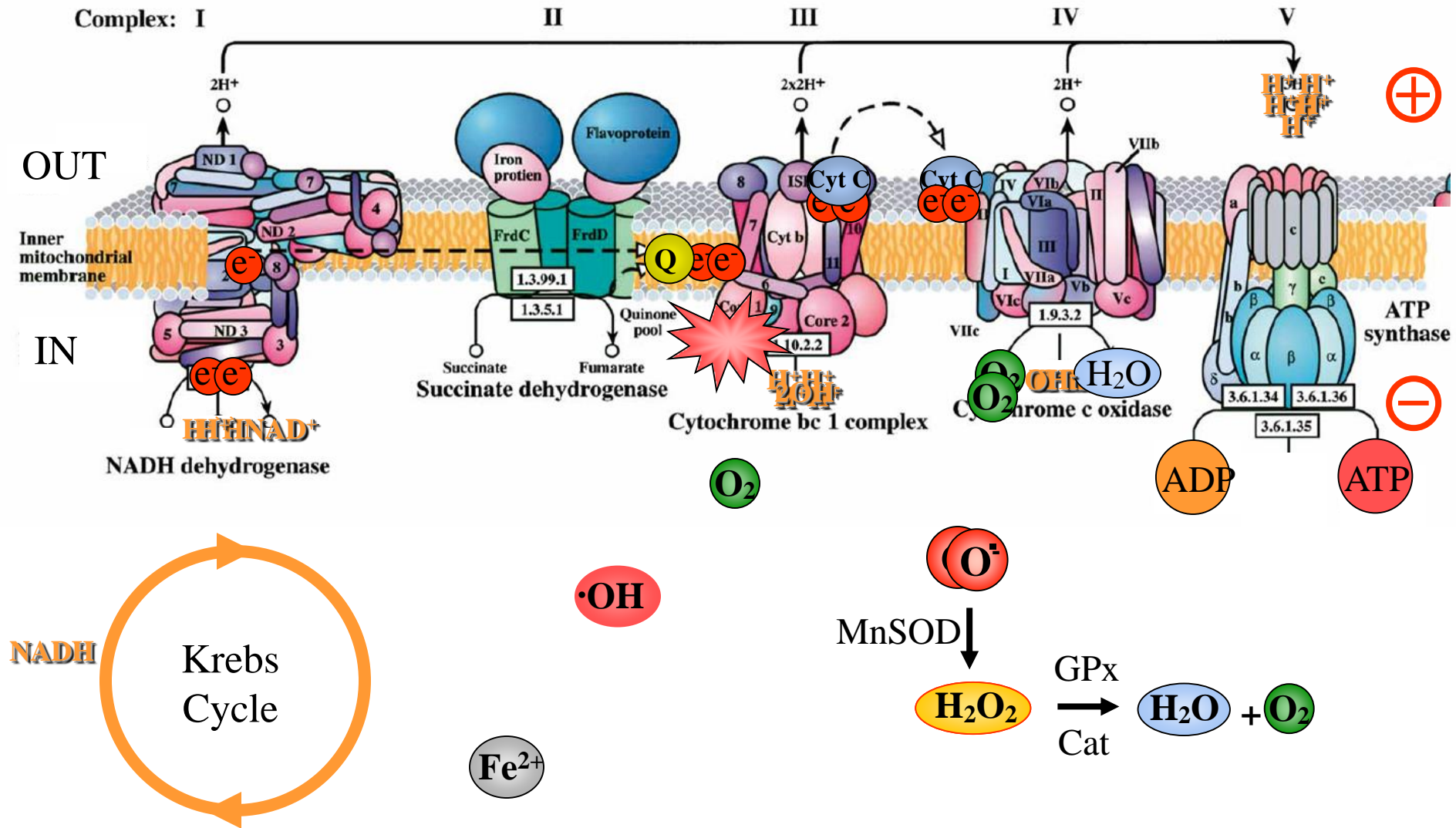

Differentiation of BAT (compared to WAT)

- common precursor of muscle cells and BAT (Myf5⁺)
 - + PRDM16 → BAT
 - in classical localizations (Myf5⁺ BAT)
 - - PRDM16 → muscles
- BAT also dispersed in WAT (Myf5⁻)
 - trans-differentiation from WAT???

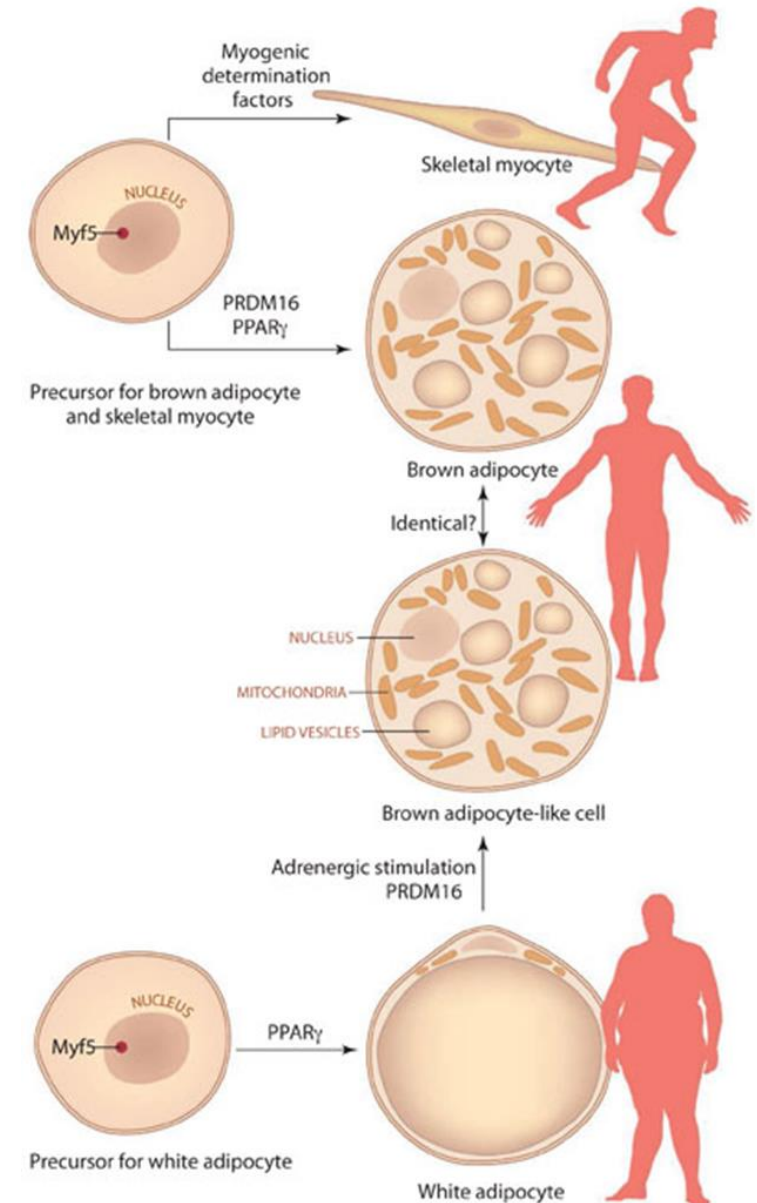
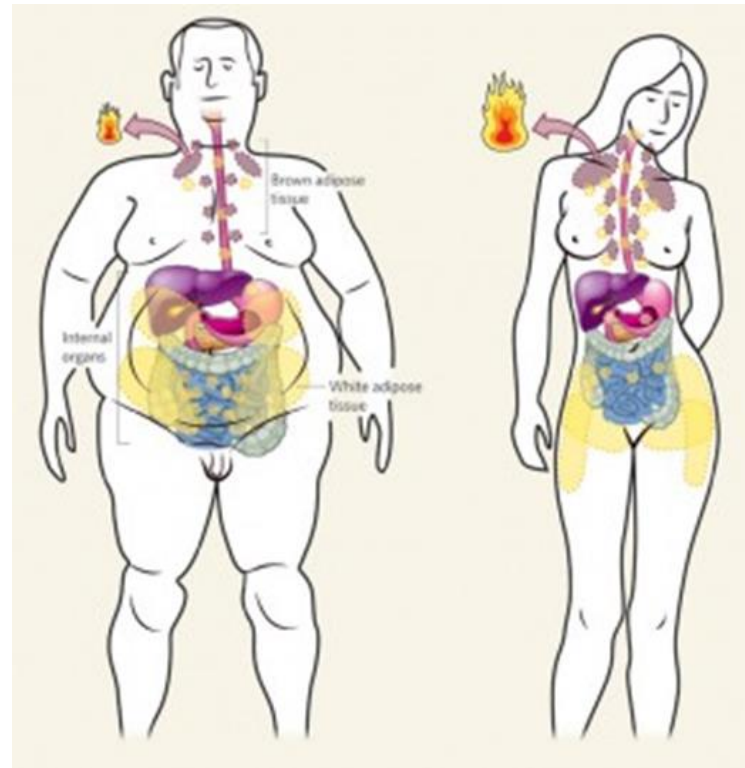

(2) White adipose tissue (WAT)

- (a) **subcutaneous** adipose tissue
 - aesthetic but not metabolic catastrophe
- (b) **visceral** adipose tissue
 - intra-abdominally – e.g. omentum, mesenterium
 - retroperitoneally
- (c) others
 - epicardium
 - local source of FFA?
 - possible paracrine effect of secreted factors on the heart
 - orbital, joints, synovia

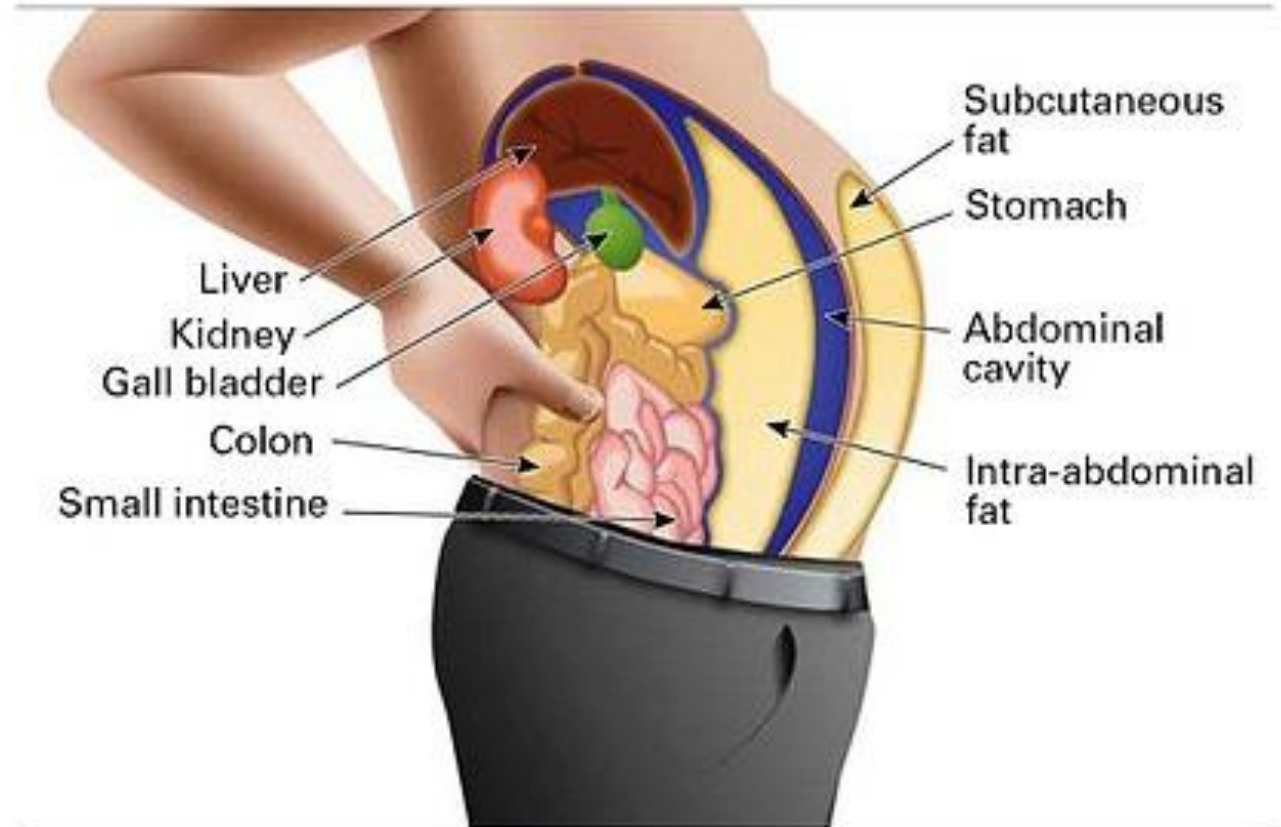

(2b) Visceral (intra-abdominal) fat tissue

- localization
 - omentum, mesenterium, retroperitoneum
- visceral adipocytes are different from s.c. !!!!
 - lower LPL activity
 - higher HSL activity compared to subcutaneous fat
 - higher 11β HSD1 activity = higher local production of cortisol
 - different density of receptors for GC, $\beta 3$ adr., Ins, ...
 - lower leptin synthesis, higher production of pro-diabetogenic adipokines (e.g. resistin and RBP)
- in summary: **higher sensitivity to lipolytic effect of catecholamines and GC, lower sensitivity to anti-lipolytic effect of insulin and higher tendency to GC-stimulated differentiation of adipocytes**
- drained by v. portae = direct effect on liver
 - glycerol is a substrate for gluconeogenesis = **diabetes/IGT/IFG**
 - esterification and synthesis of VLDL = **dyslipidaemia**
 - induction of hepatic lipase - -> modification of LDL and HDL to small dense particles = **atherogenesis**

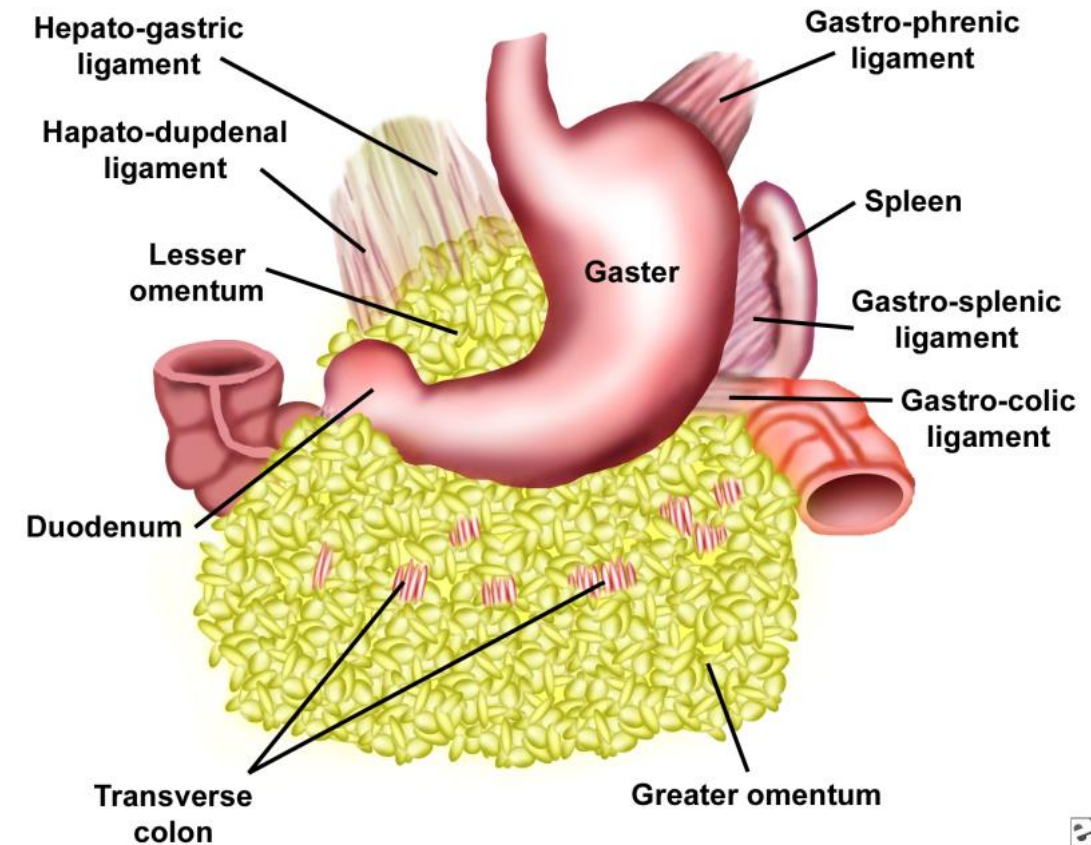

Ratio of SC and V fat tissue

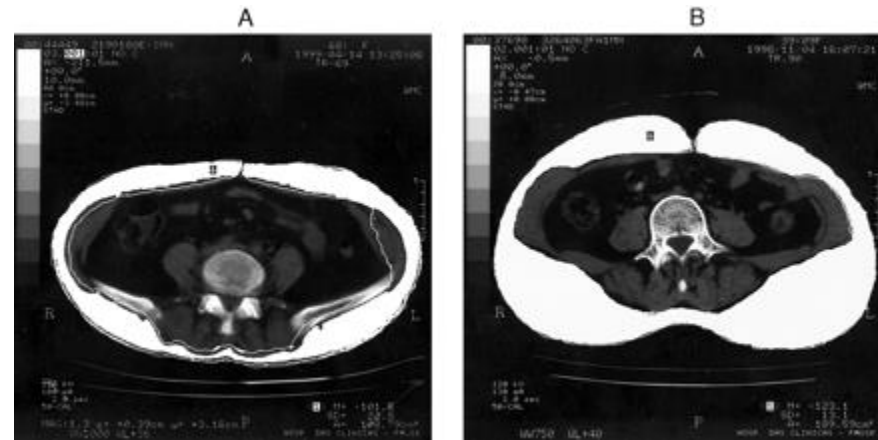
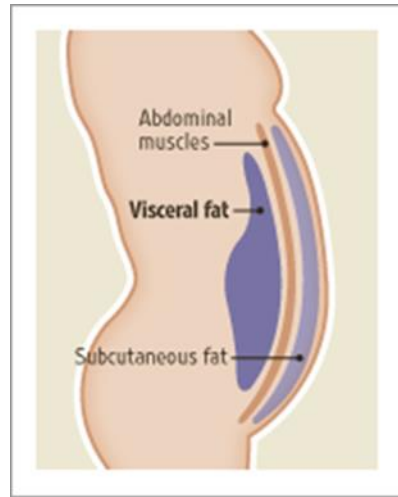

- CT cross-sectional abdominal areas at umbilicus level in two patients demonstrating variation in fat distribution
 - A: Visceral type (49-yr-old female, **23.1 of BMI**, visceral fat area: 146 cm²; subcutaneous fat area, 115 cm²; **V/S ratio, 1.27**)
 - B: Subcutaneous type (40-yr-old female, **24.0 of BMI**, visceral fat area: 60 cm²; subcutaneous fat area, 190 cm²; **V/S ratio, 0.31**)
- cut-off of metabolic a CV risk >0.4

Cushing syndrome as an example of redistribution of s.c. into visceral

- (1) regional differences in intensity of lipogenesis vs. lipolysis between s.c. and v. adipose tissue
 - suppression of LPL in s.c.
 - activation of ATGL/HSL in both, but more in v.
 - however, results of studies are controversial (acute vs. long-term, animal vs. humane, the contribution of hyperinsulinemia, ...)
- (2) preferential differentiation of v. adipocytes
 - higher availability of cortisol due to \uparrow activity of 11β HSD1
- (3) lower central effect on the control of appetite
- end result is **central obesity** with all the components of **metabolic syndrome**

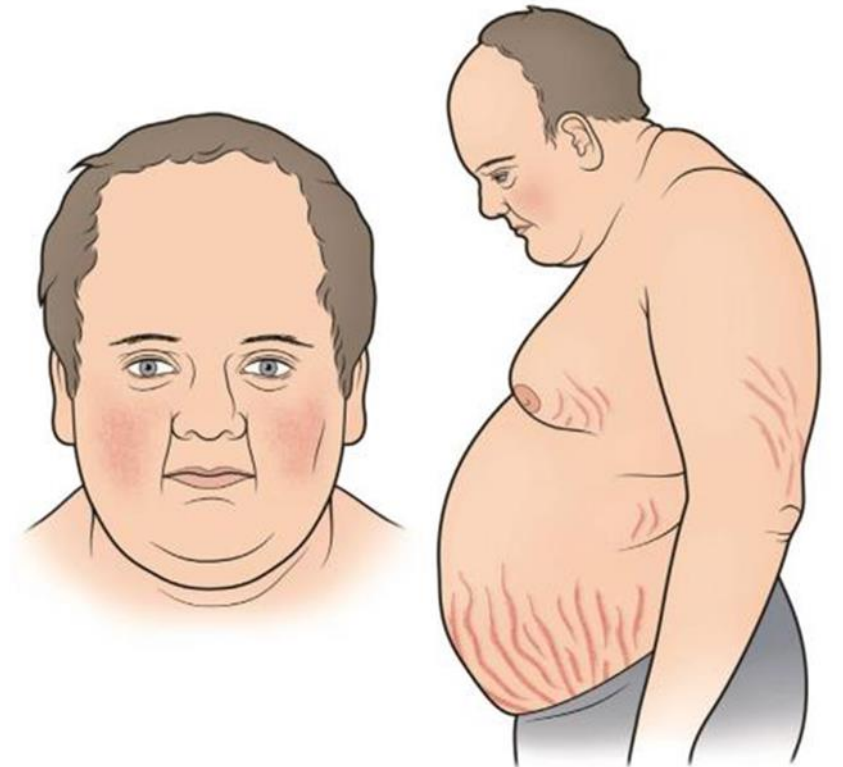

(2a) WAT - adipocyte differentiation

- in positive energy balance **fat tissue does not expand passively** = regulation of **adipocyte differentiation**
- pluripotent mesenchymal cell (MSC) → adipoblast → pre-adipocyte → adipocyte
- control (transcription factors)
 - peroxisome proliferator-activated receptor γ (PPAR γ)
 - expressed mainly in fat tissue
 - stimulates adipocyte differentiation, lipogenesis and fat storage
 - CCAAT regulatory enhancer binding protein α (CREBP α)
 - sterol-regulatory element binding protein 1c (SREBP1c)
 - others (Wnt signalling pathway)
- hyperplastic but small adipocytes store fat relatively “safely”
- „lipid overflow“ or „reduced adipose expandability“ hypothesis of obesity
 - limited differentiation plasticity of adipose tissue (mainly subcutaneous) leads to **hypertrophy** of existing adipocytes
 - interindividual variability in the capacity of differentiation (genetics?)

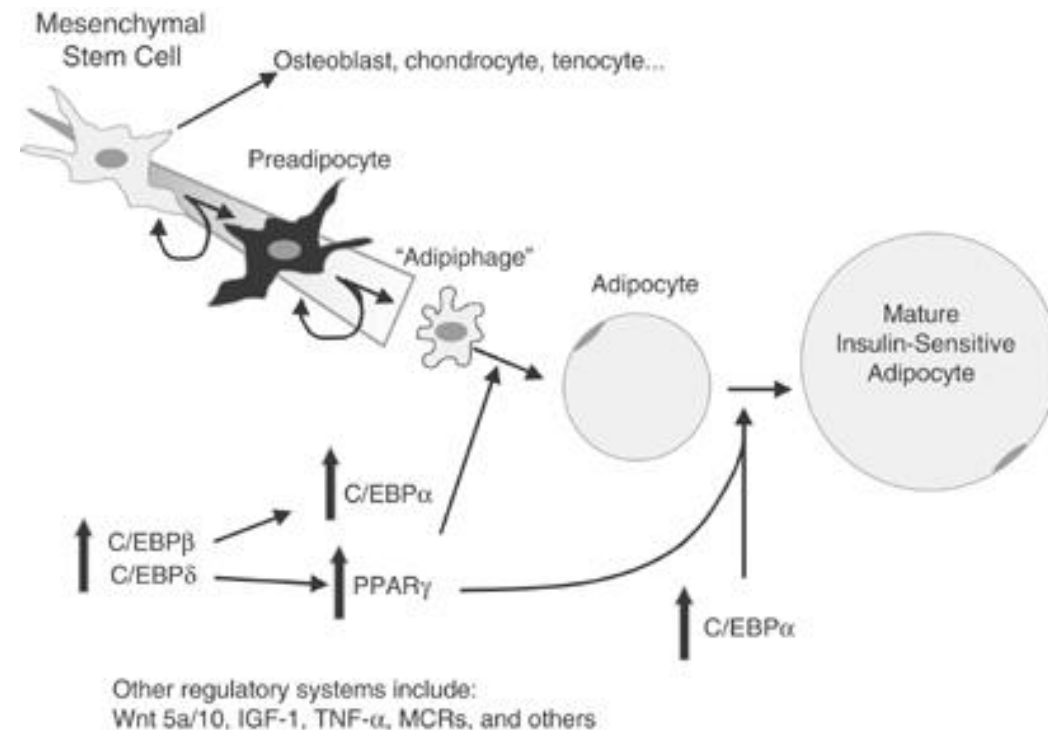

Hypertrophic, overloaded adipocyte

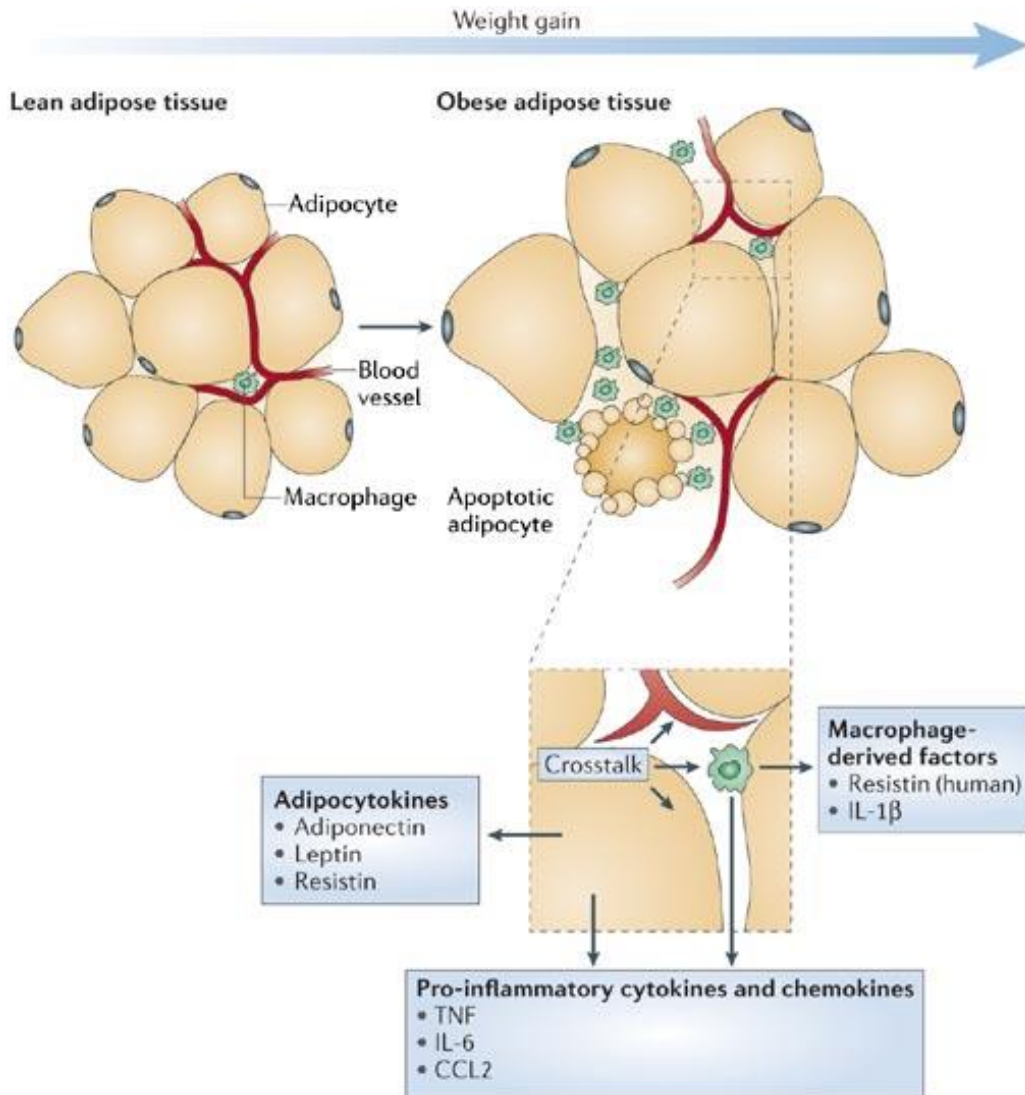

Copyright © 2006 Nature Publishing Group
Nature Reviews | Immunology

- overloaded adipocytes secrete **cytokines** attracting monocytes
 - hypoxia (HIF-1)
 - ER stress
 - \uparrow leptin/adiponectin ratio (i.e. \uparrow pro-/ \downarrow anti-inflammatory signaling)
- upon their differentiation into macrophages further production of pro-inflammatory cytokines affecting insulin sensitivity
 - competition of Tyr- and Ser/Thr-kinases (signalization of TNF- α vs. insulin for IRS-1)
- **"low-grade inflammation"**
 - responsible for the development of co-morbidities associated with obesity, esp. T2DM, atherosclerosis, carcinogenesis, ...

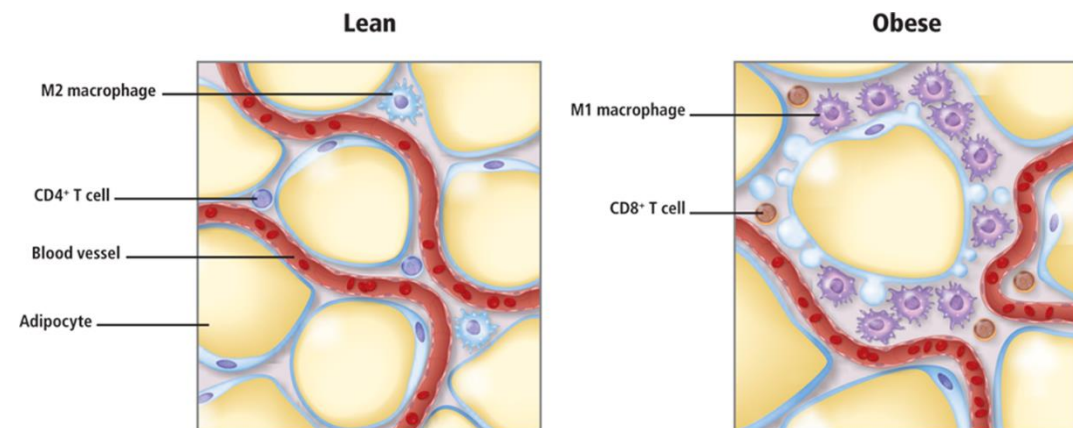

(3) Ectopic fat

- upon reaching maximum of saturation of WAT additional nutrients are „redirected“ towards other organs not specialized for storage of lipids, therefore sensitive to **lipotoxicity**
- inability to store unlimited amount of nutrients and limited expandability of subcutaneous a. tissue leads to progressive inflammation and production of pro-inflammatory adipokines
 - apoptosis of hypertrophic adipocytes
 - saturation of visceral fat
 - NEFA “spillover”
 - interferes with utilization of glucose in muscle (\downarrow ins. sensitivity)
 - ectopic storage of fat in organs
 - skeletal muscle
 - insulin resistance
 - myocardium
 - cardiomyopathies
 - arrhythmias
 - apoptosis
 - systolic dysfunction
 - liver
 - NAFLD/NASH
 - pancreas (B-cells)
 - apoptosis

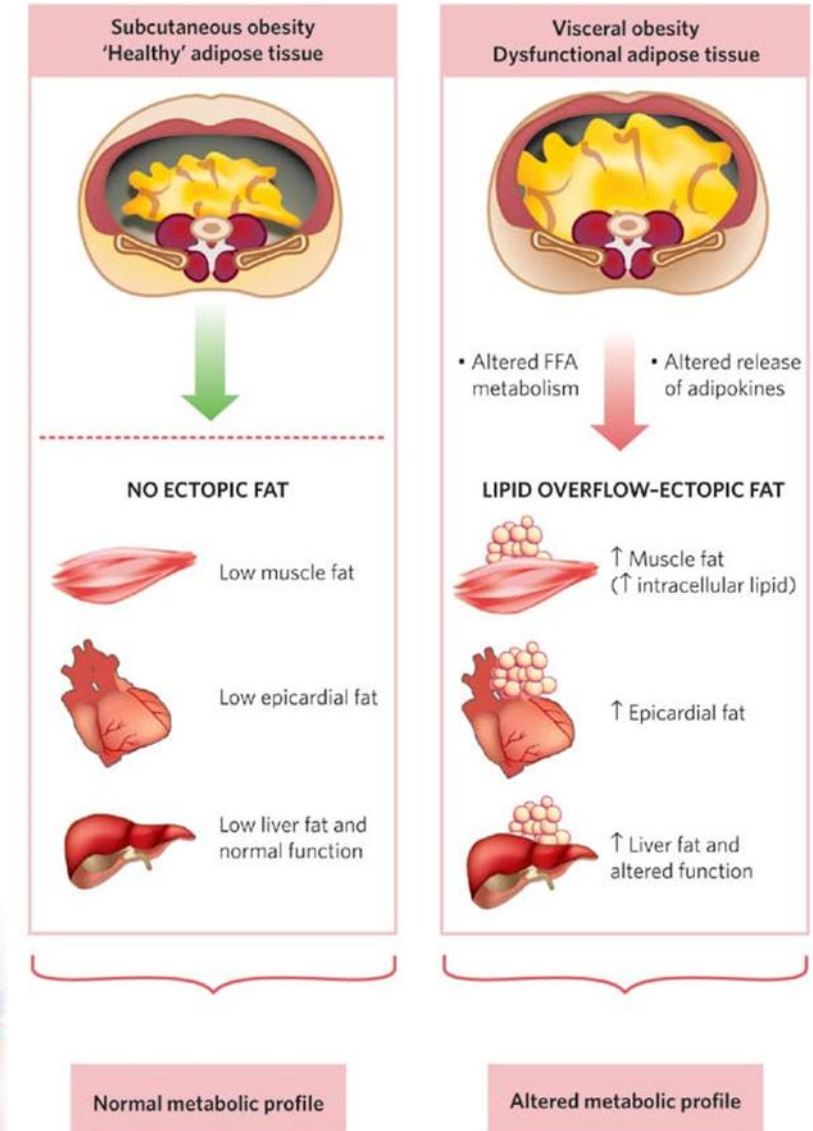
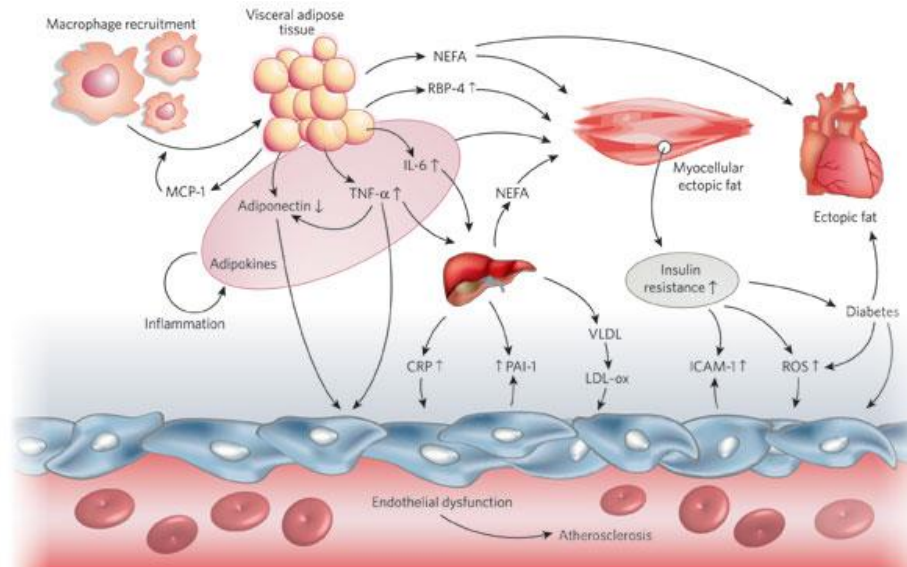

Lipodystrophy as an extreme example of dysfunctional subcutaneous fat tissue with metabolic consequences

- inherited (AR or AD) or acquired
 - generalized
 - localized
- similar to metabolic syndrome
 - dyslipidaemia
 - hypertriglyceridemia and hypercholesterolemia, low HDL
 - impaired Glc tolerance
 - visceral obesity
 - liver steatosis
 - ...





Obesity

Overweight / obesity

- defined as an excessive deposition of fat in the body with concurrent **hyperplasia** and **hypertrophy** of adipose tissue
 - ↑ differentiation of pre-adipocytes
 - ↑ deposition of lipids in adipocytes
- obesity is, first of all, consequence of **abnormal long-term regulation of energy homeostasis**
- risks connected with obesity
 - cardiovascular
 - metabolic syndrome (diabetes, hypertension, dyslipidaemia) → atherosclerosis
 - tumors
 - ovary
 - endometrial
 - breast
 - colorectal
 - kidney cancers
 - musculoskeletal system
 - arthrosis of lower limb joints
 - infertility
 - polycystic ovary syndrome
 - biliary calculosis (all bladder stones)
 - respiratory insufficiency (morbid obesity – Pickwick syndrome)
 - sleep apnoea

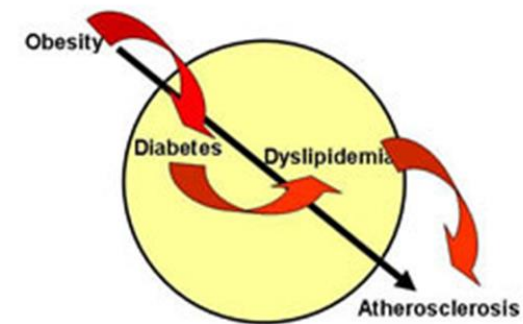

The Metabolic "Axis of Evil"

Etiopathogenesis of obesity

- obesity develops as a consequence of long-term positive energy balance, i.e. imbalance between
 - \uparrow energy intake
 - theoretically
 - young healthy physically working man requiring ~14 000kJ
 - older sedentary woman ~7 000kJ
 - in reality
 - average consumption 10 - 12 000kJ
 - \downarrow energy expenditure
 - combination of both
- however, there is no "static" state *in vivo* (i.e. energy storage = energy intake – energy expenditure) but "dynamic" because decreased intake decreases **resting energy expenditure (REE)**
 - creates a problem how to lose weight by diet after once gaining it
- but why this is possible?
 - is there any feedback loop between adipose tissue and central and peripheral organs influencing metabolism and food intake in order to prevent the increase of body weight over the threshold necessary for the optimal functioning of an organism? **ENERGY HOMEOSTASIS????**



Energetic homeostasis of the single cell

- 5' AMP-activated protein kinase (AMPK) expressed in most energetically relevant organs, e.g. liver, muscle and brain
- activation of AMPK during energy depletion (\uparrow AMP/ATP ratio)
 - activation of catabolic pathways
 - \uparrow liver FFA oxidation and ketogenesis
 - \uparrow muscle FFA oxidation and transport of GLC
 - inhibition of anabolic pathways
 - \downarrow liver synthesis of CH and protein synthesis
 - \downarrow lipolysis and lipogenesis in adipocytes
 - \downarrow synthesis of TAG and de novo lipogenesis
- the activity of AMPK is regulated by
 - „upstream“ kinases (e.g. calmodulin-dependent k. or LKB1)
 - adipokines (adiponectin, leptin)
 - pharmacologically (metformin)

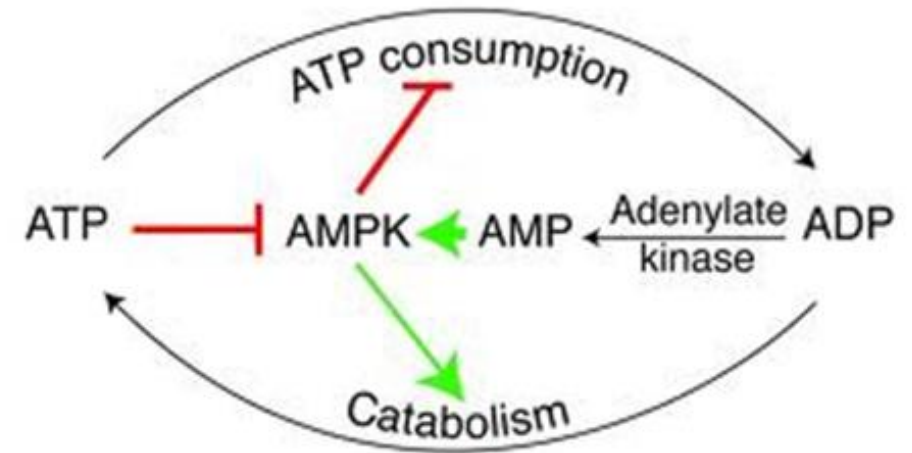

That is why metformin is a first-line antidiabetic drug (insulin-sensitiser)

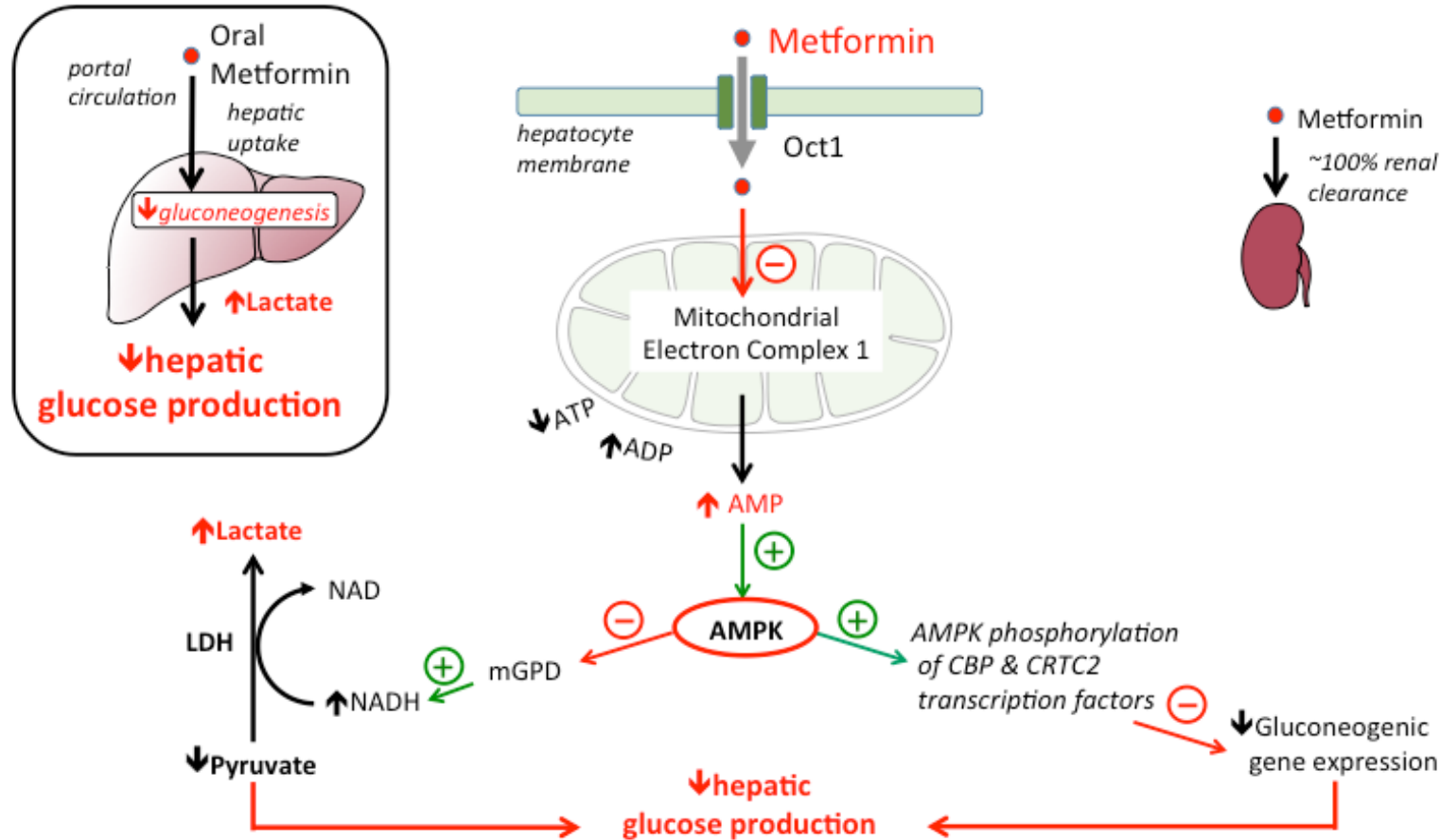

- Metformin acts primarily to suppress glucose production in the liver. While metformin's mechanism(s) of action remain controversial, current evidence indicates that metformin's most important effect in treating diabetes is to **lower the hepatic production of glucose** (as summarized in the top left box).
- Current evidence suggests that results from a **combination of intracellular effects in the liver**. When metformin is taken orally, it is absorbed into hepatocytes from the portal vein through plasma membrane transporters, including the organic cation transporter 1 (OCT1).
- Inside the cell metformin inhibits mitochondrial respiratory-chain complex 1, resulting in reduced ATP levels and increased AMP. Increased AMP levels **activate Adenosine Monophosphate-Activated Protein Kinase (AMPK)**, which contributes to the lowering of glucose production by at least 2 pathways:
 - i) increased AMPK phosphorylates CBP & CRTC2 transcription factors, which inhibits genes involved in the production of glucose ("gluconeogenic genes");
 - ii) increased AMPK also inhibits mitochondrial glycerol-3-phosphate dehydrogenase (mGPD), leading to an increase in cytosolic NADH, which both stimulates the conversion of pyruvate to lactate, and simultaneously decreases gluconeogenesis. An accumulation of lactate to dangerous levels (lactic acidosis) can occur when metformin is taken by patients with other conditions resulting in metabolic acidosis (liver disease, heart failure, sepsis, alcohol abuse), or kidney disease (as indicated by elevated creatinine levels) because metformin is eliminated by renal excretion) (He & Wondisford, 2015; Nolte Kennedy & Masharani, 2015).

Pathogenesis of obesity

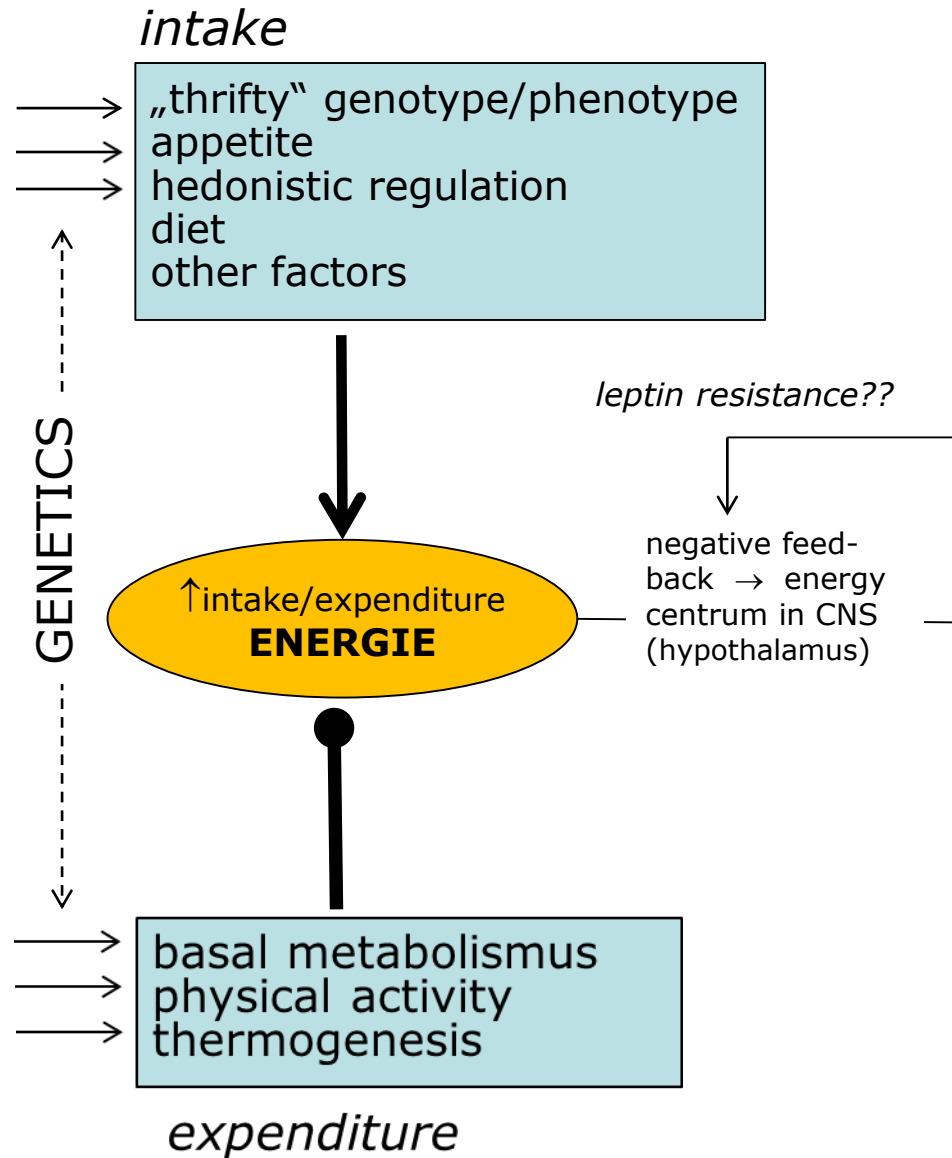

- endogenous and exogenous factors likely contribute equally:
 - endogenous
 - genetic
 - REE – measured by indirect calorimetry (RQ)
 - foetal programming
 - exogenous
 - physical activity
 - exercise energy expenditure
 - non-exercise activity thermogenesis (daily chores, posture, fidgeting)
 - diet (amount, frequency, quality)
 - others
 - education, social class, psychological factors (personality), stress
- the recent change of behavioral and environmental (not genetic!) factors is responsible for the current epidemic of obesity in developed countries (and its growing prevalence in developing ones)
 - although genetic predisposition plays probably an important role it isn't genes that would change rapidly recently!

Genetics of obesity

- **heritability** of body weight ~60%
- methods
 - association case-control studies with **candidate genes** = genetic polymorphism in genes encoding products involved in
 - regulation appetite/satiety
 - peripheral and central orexigenic / anorexigenic mediators and their receptors
 - endocannabinoid system
 - adipose tissue differentiation and metabolism
 - PPARs, enzymes, adipokines and their receptors
 - carbohydrate metabolism
 - insulin receptor signalling cascade
 - post-receptor sensitivity
 - thermogenesis
 - uncoupling proteins
 - **genome-wide association studies** (GWAS)
 - search for genes without a priori hypothesis/known pathophysiological role
 - FTO (fat-mass and obesity-associated) – hypothalamic food intake regulation
 - MCR4 (melanocortin receptor) - anorexigenic
 - tens of others
 - **next generation sequencing**

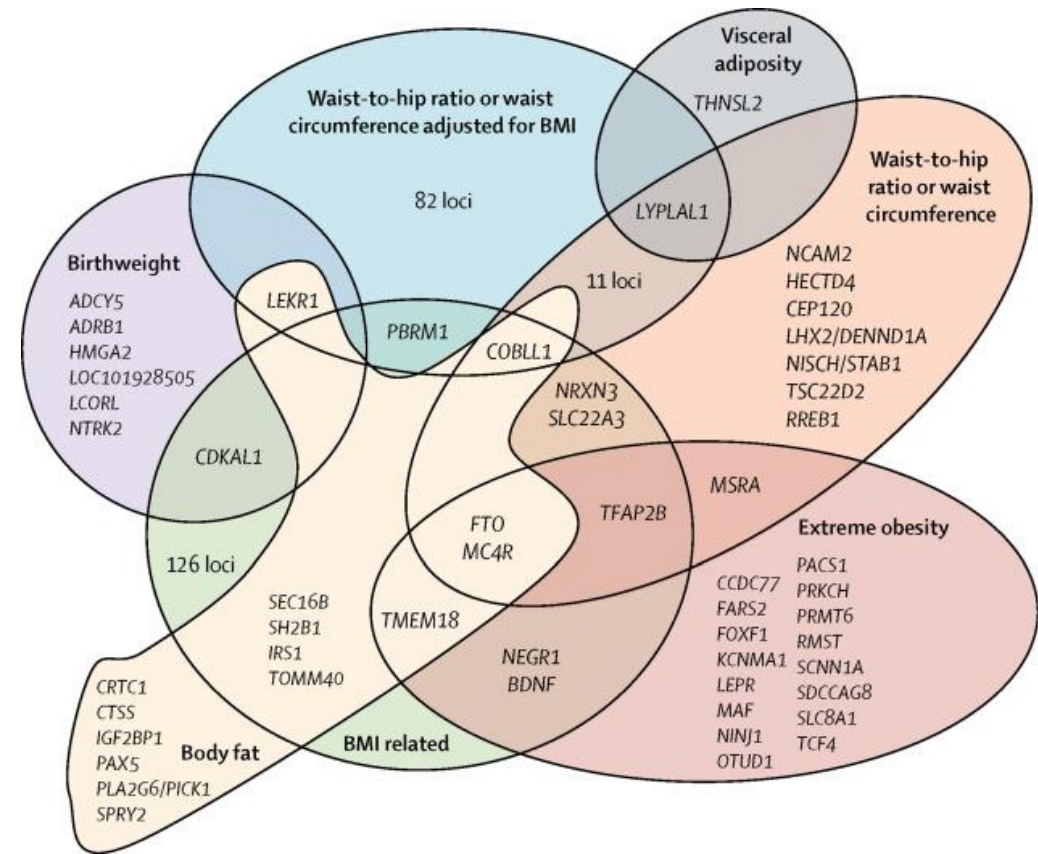
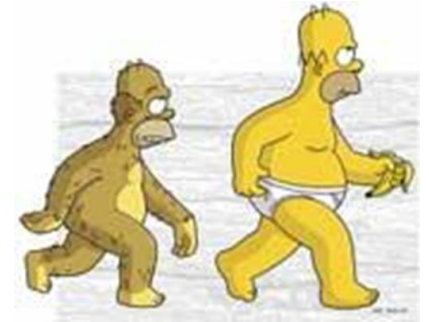

Environmental factors

- lack of physical activity
- change of diet
 - lipid-rich diet brings twice as much energy in the same amount compared to carbohydrates and proteins
 - lipids mediate the satiety much later than saccharides (→ insulin)
- national cuisine traditions
- family habits
- educational and social status
- consumption of alcohol can play a role too
 - non-negligible energy content
- gut microflora

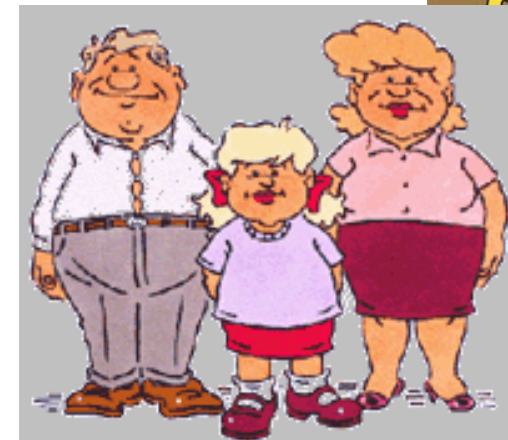
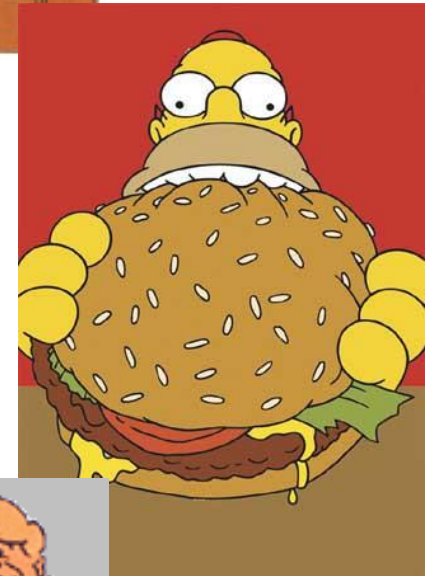

Gut microbiome vs. obesity

- $\sim 10^{14}$ microorganisms in the intestine (~ 1000 species), 60% of stool volume represent bacteria
 - G⁺ Firmicutes 60%
 - Lactobacillus, Mycoplasma, Clostridium, ...
 - G⁺ Actinobacteria 10%
 - G⁻ Bacteroides 10%
 - others
- experimental findings support the role of gut microflora in body weight
 - germ-free animals have 40% lower body weight despite comparable food intake in conventional animals
 - following bacterial colonization of the energetic yield of the food, body weight and hepatic lipid production is increased, conversely, insulin sensitivity is decreased
- obesity, resp. high-calorie food intake (i.e. high fat/high sugar Western diet) is associated with a shift of the microflora composition
 - Firmicutes > Bacteroides
- apart from the effect of diet, the composition of gut microflora shows significant similarity in families (twins, siblings, mother-offspring pairs)
- putative pathogenic mechanisms of bact. gut colonization contribution to changes in body weight
 - the variable energetic yield of the food
 - low-grade endotoxemia
 - LPS → CD14 (TLR-4) → Kupffer cells → metabolic consequences in liver
 - altered secretion of intestinal paracrine hormones (peptides) by entero-endocrine cells
 - slowing down intestinal motility and allowing thorough digestion and absorption

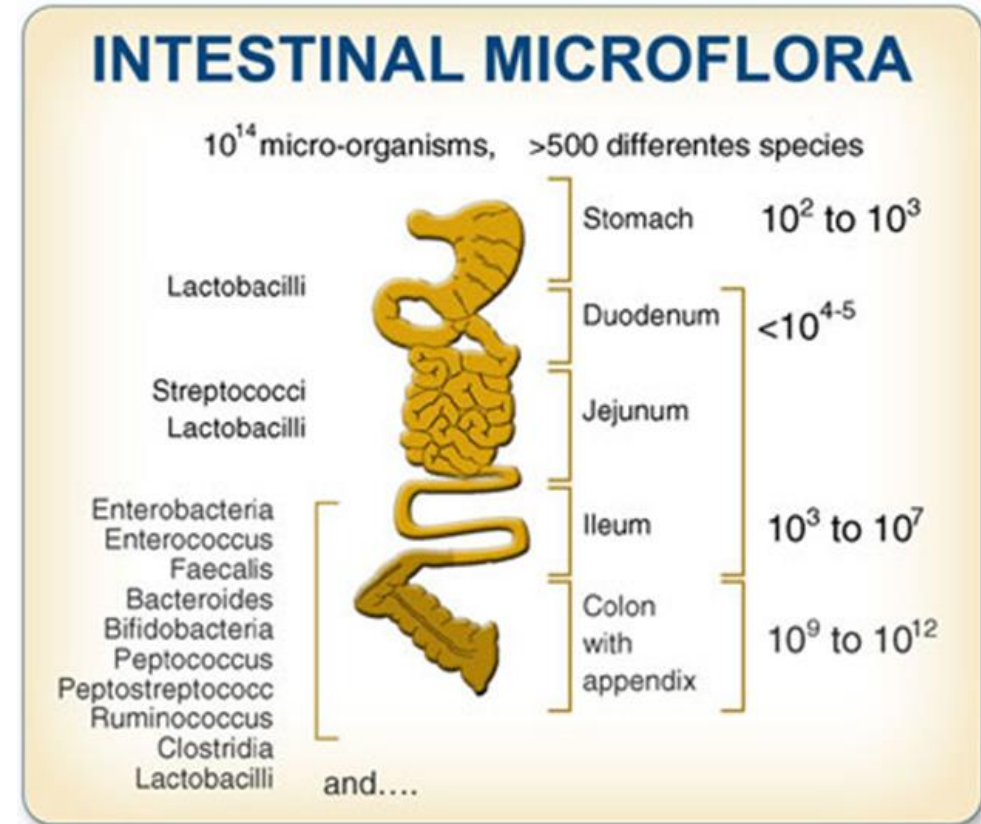

Other less common causes of obesity/hyperphagia

- tumors and lesions of ventromedial hypothalamus
 - mostly craniopharyngeoma
- monogenic genetic syndromes
 - Prader-Willi syndrome
 - deletion or alteration of expression of group of genes on the proximal part of long arm of paternal chromosome 15
 - abnormally increased appetite (hyperphagia) and subsequent morbid obesity, muscular hypotonia, mental retardation, low height, hypogonadism and acromicria (small hands and feet)
 - high levels of ghrelin are common in PW patients - consequence of primary genetic defect?

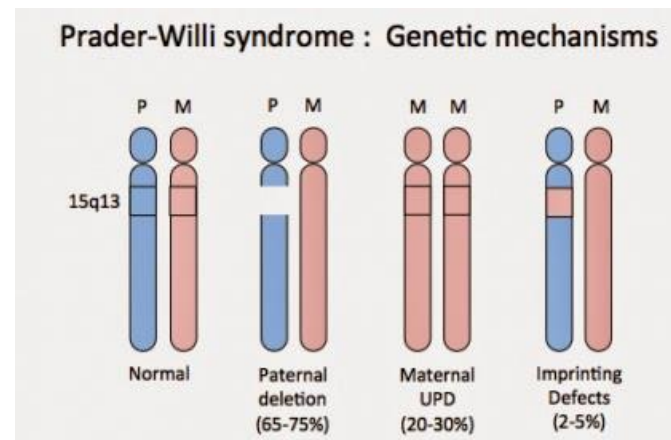

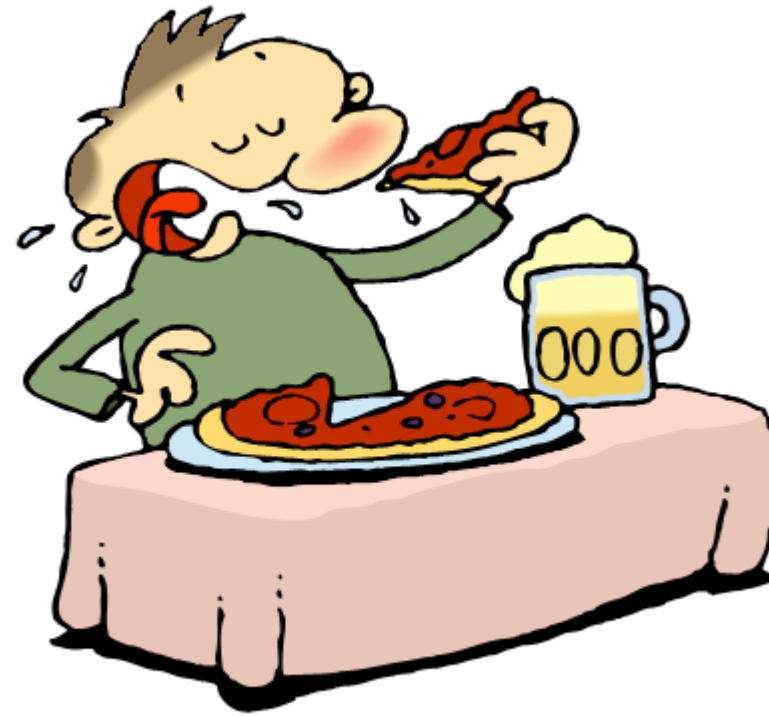

REGULATION OF FOOD INTAKE

Food intake is a periodical event

- main stimuli regulating the timing of meals are
 - **appetite** respectively **hunger**
 - appetite = natural desire to eat which changes behaviour in order to get access to food
 - hunger = feeling of the imperative need of food associated with various objective symptoms, esp. negatively perceived stomach contractions
 - **satiety**
 - satiety = opposite of hunger, follows after adequate meal
- frequency of meals, portion size, quality, and type of processing is influenced by various exogenous and endogenous factors
 - social, psychogenic, emotional, habitual, daily regimen, cost, season etc.
- regardless of these short-term physiological fluctuations **energy balance should be balanced in a healthy man in long-term** so that energy intake equals expenditure
- however, the regulation of food intake (and body weight) is not purely homeostatic but quite a complex process involving neural and hormonal regulation
 - **(A) homeostatic regulation**
 - afferent signals are so far much better understood than efferent signals
 - **(B) hedonistic regulation**
 - satisfaction after meal



(A) Homeostatic regulation

- **afferent signals (= appetite vs. satiety):**

- **peripheral signals** via systemic humoral factors and sensitive information from GIT informing about gastric distension and motility (via n. vagus and n. tractus solitarii)
 - the most important humoral factors are:
 - **insulin** – postprandial release paralleling the glycemia
 - **leptin** – adipose tissue hormone, likely involved in long-term modulation of sensitivity to peripheral “satiety” signals from GIT (cholecystokinin (CCK), glucagon-like peptide 1 (GLP-1) and peptide YY)
 - **ghrelin** – a hormone released from the stomach whose concentration rises during fasting („hunger mediator“)
 - the concentration of leptin (and indirectly of insulin) is proportional to the adipose tissue mass and the intensity of their signals in CNS (via their receptors) is related to their plasma levels
 - meal composition (amount of carbohydrates, proteins and lipids) is reflected in afferent signalization – changes of insulinemia after a meal containing sugar („glycemic index) and proteins, dietary lipids influence insulinemia and thus satiety minimally
- **central** integration of signals takes place in **the hypothalamic nuclei** (nucleus arcuatus) by local neurotransmitters:
 - orexigenic mediators (neurotransmitters)
 - **neuropeptide Y** (NPY)
 - **agouti-related peptide** (AgRP)
 - anorexigenic mediators (neurotransmitters)
 - **proopiomelanocortine** (POMC)
 - **cocaine-amphetamine-regulated transcript** (CART)

- **efferent signals:**

- events initiated by primary centers in the hypothalamus are not entirely known yet but they evidently involve a complex cooperation network among various CNS regions which influence behavior in order to seek food
- secondary mediators
 - orexigens - orexin A and B, galanin and norepinephrine
 - anorexigens – melanocyte-stimulating hormone (α -MSH), corticoliberin (CRH), thyrotropin-releasing hormone (TRH) and serotonin

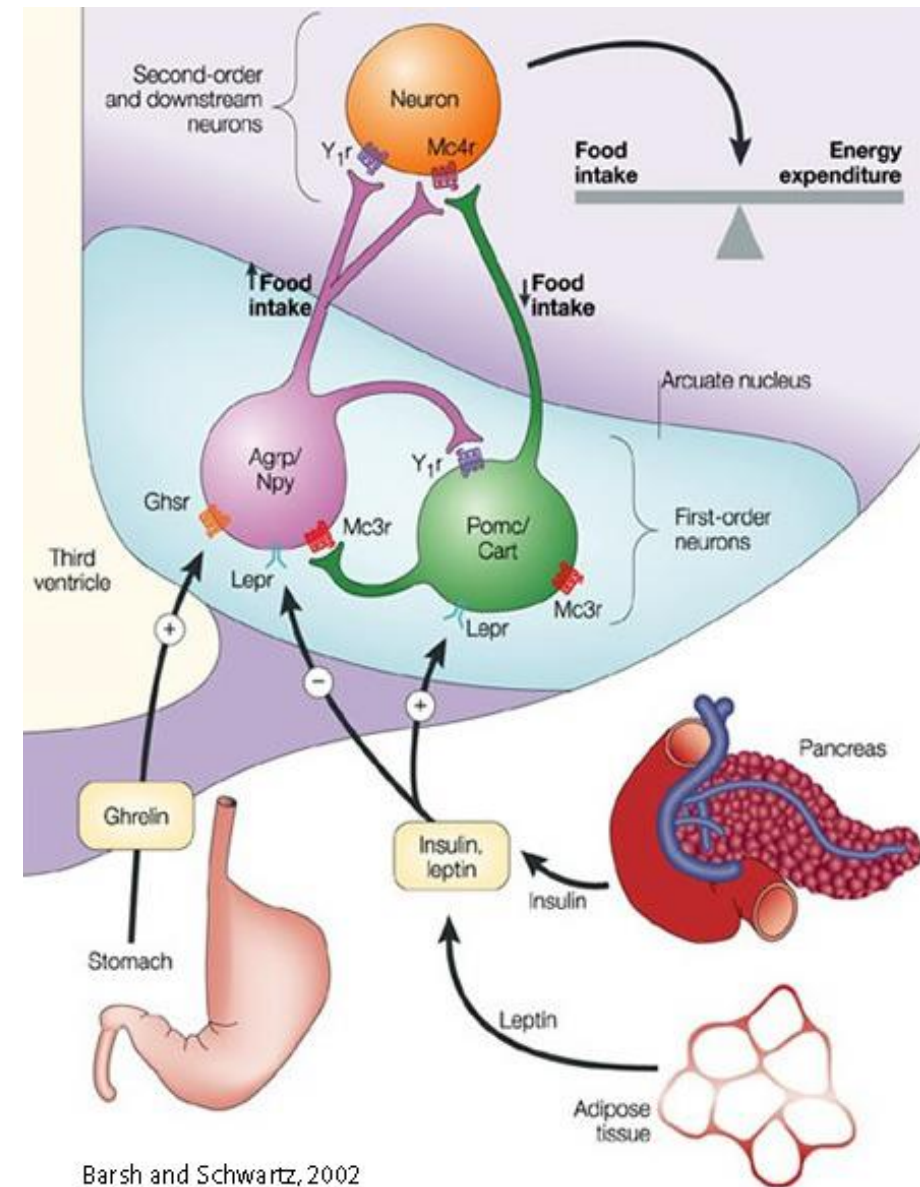

Peripheral and central signalling in regulation of food intake

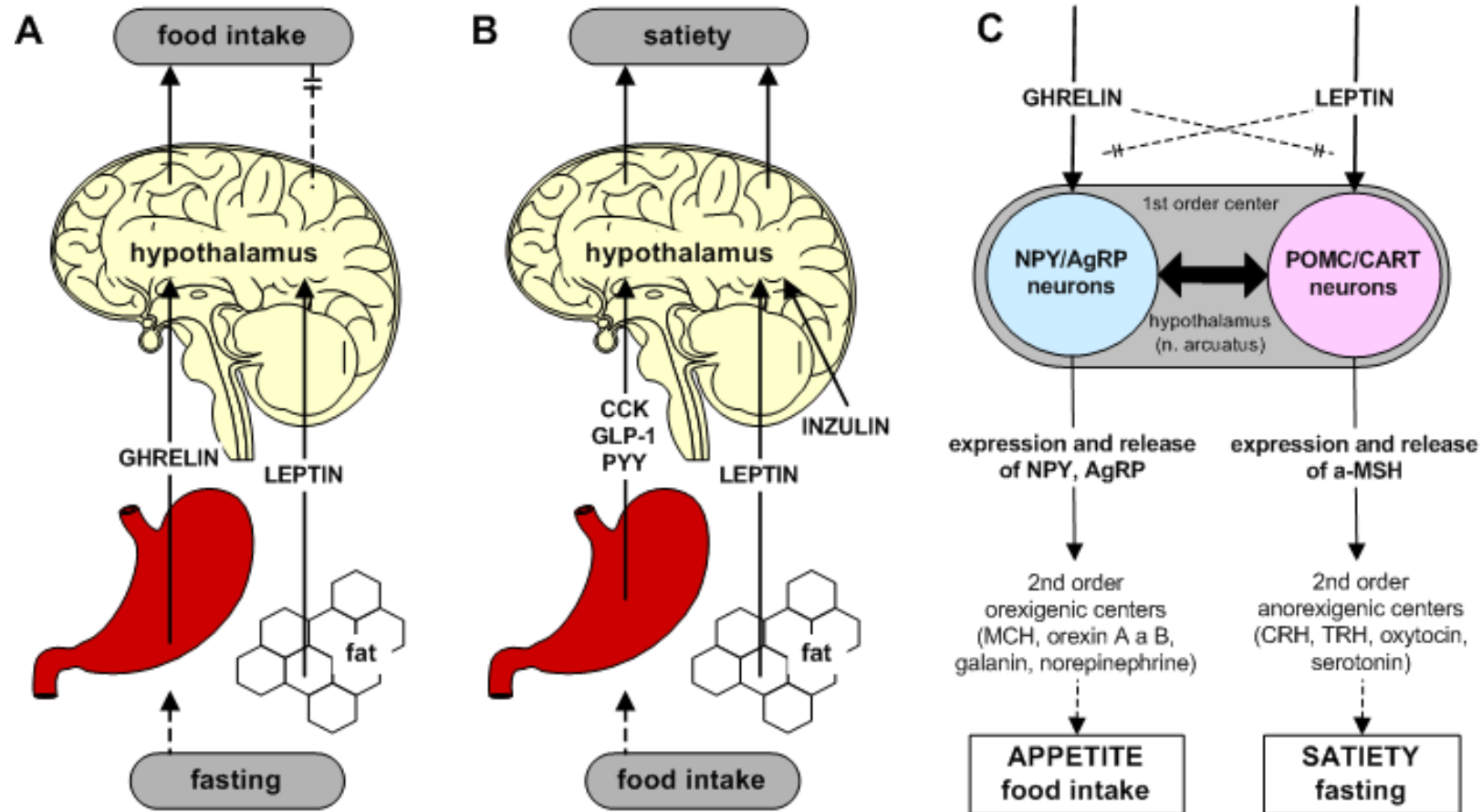

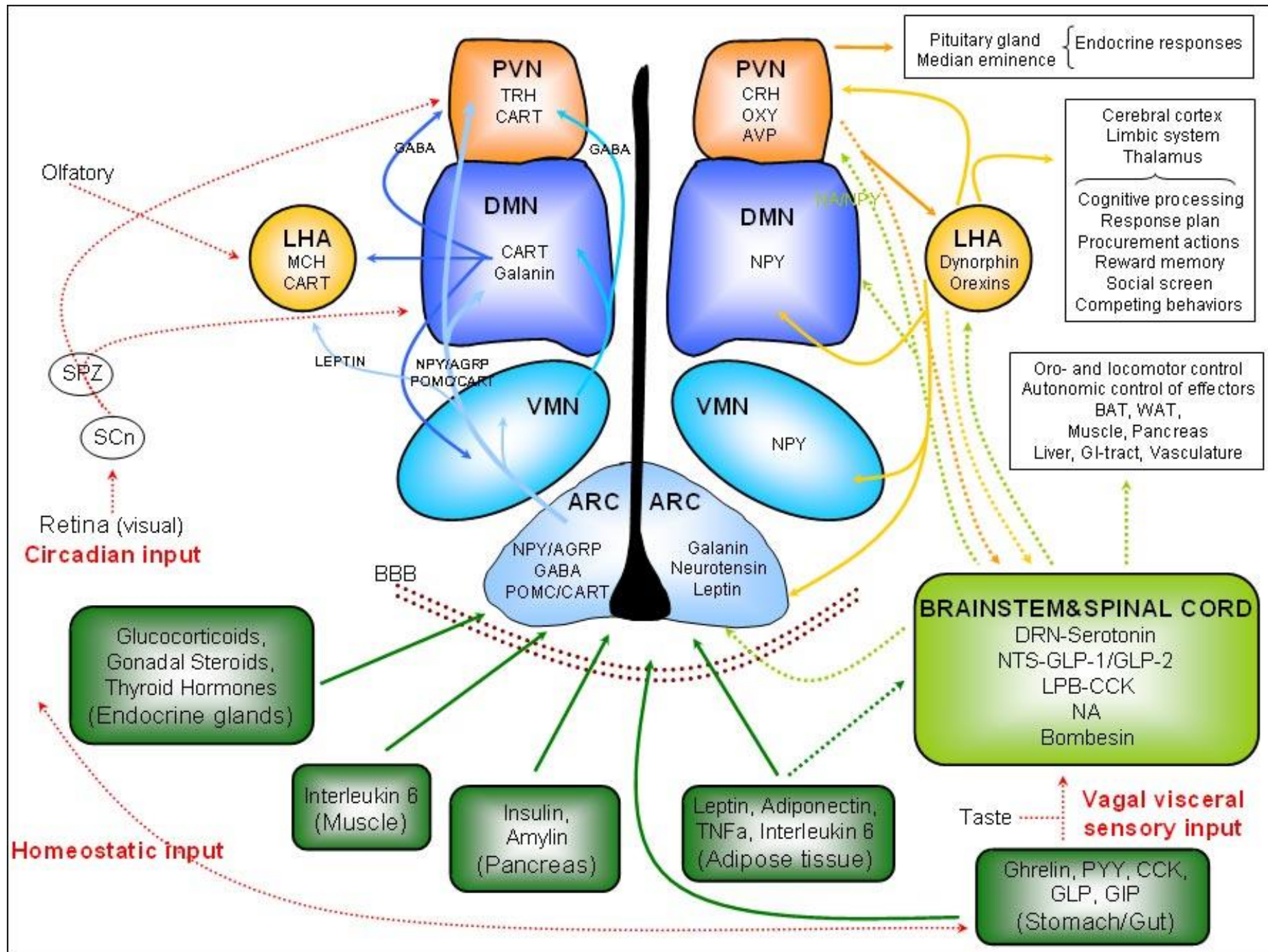

Leptin ["leptos" = lean]

- spontaneously obese strains of mouse
 - mutations in Ob or Db genes
 - Jackson laboratory (USA) from 1950
 - identified by J. M. Friedman in 1994
- the central hormone in the regulation of energy homeostasis and food intake (thermogenesis?)
- central and peripheral action
- obesity is associated with hyperleptinemia
 - **leptin resistance???** (parallel to insulin resistance) is hypothesized to play a role in the pathogenesis of obesity
- endogenous highly set "adipostat" might be also a problem of relapses in obese subjects after losing weight

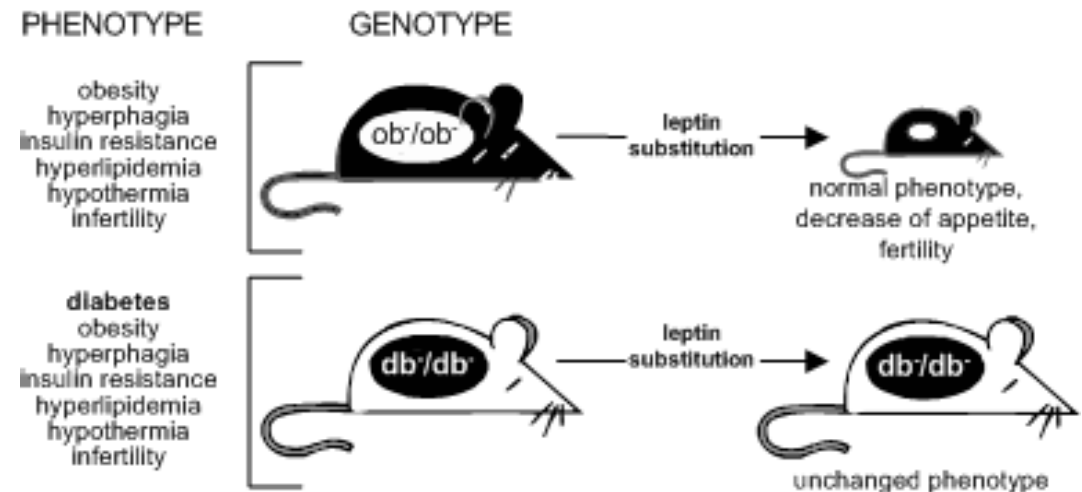

Regulation of hypothal. centers by leptin

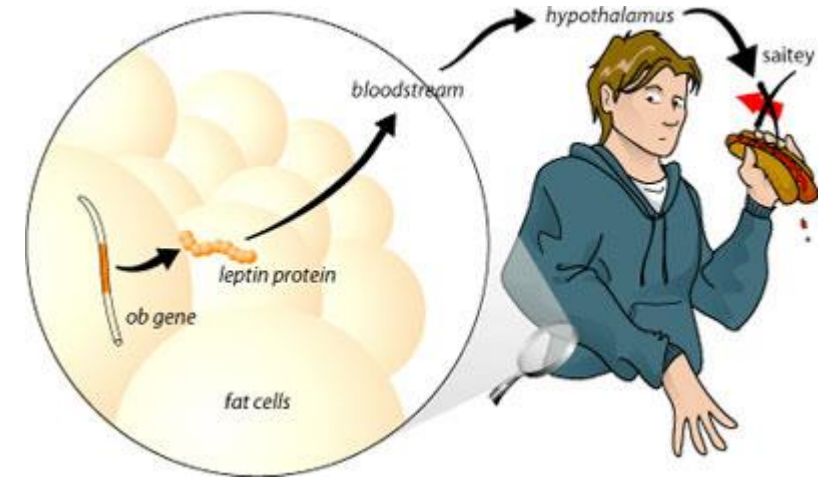
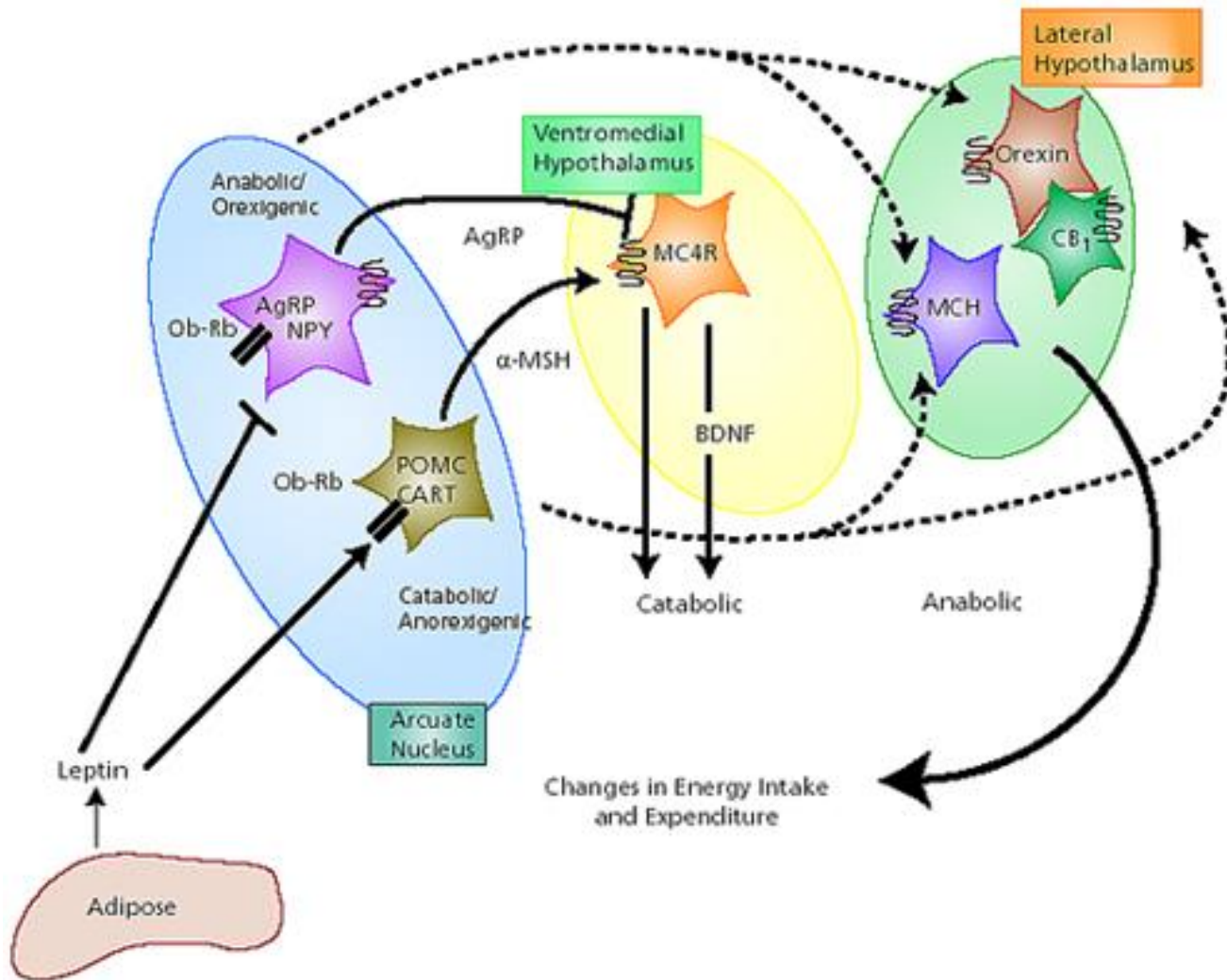

(B) Hedonistic regulation

- = sensations connected with meal (e.g. palatability, vision, reward, ...)
- afferent signals
 - gustatory and olfactory pathways into particular centres
 - cortical regions (prim. and associated centers)
 - ventral tegmental area (VTA) – dopaminergic stimulation
 - sub-cortical regions - limbic system (amygdala)
 - they mediate the “good” feeling
 - neuro-modulators are **endocannabinoids** binding to CB1 and 2 receptors
 - anandamide (arachidonoyl ethanolamide, AEA)
 - 2-arachidonoylglycerol (2-AG)
 - basal ganglia (n. accumbens and pallidum)
 - prefrontal cortex
- **homeostatic and hedonistic regulations are largely independent**
 - therefore, unfortunately, the type and amount of meal very often do not correspond with metabolic needs

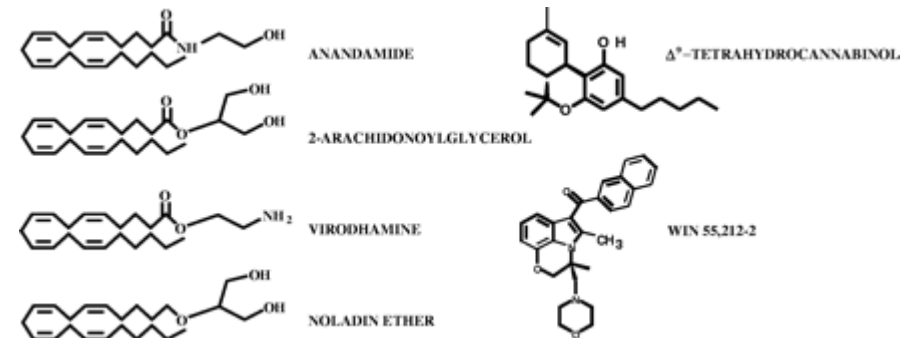
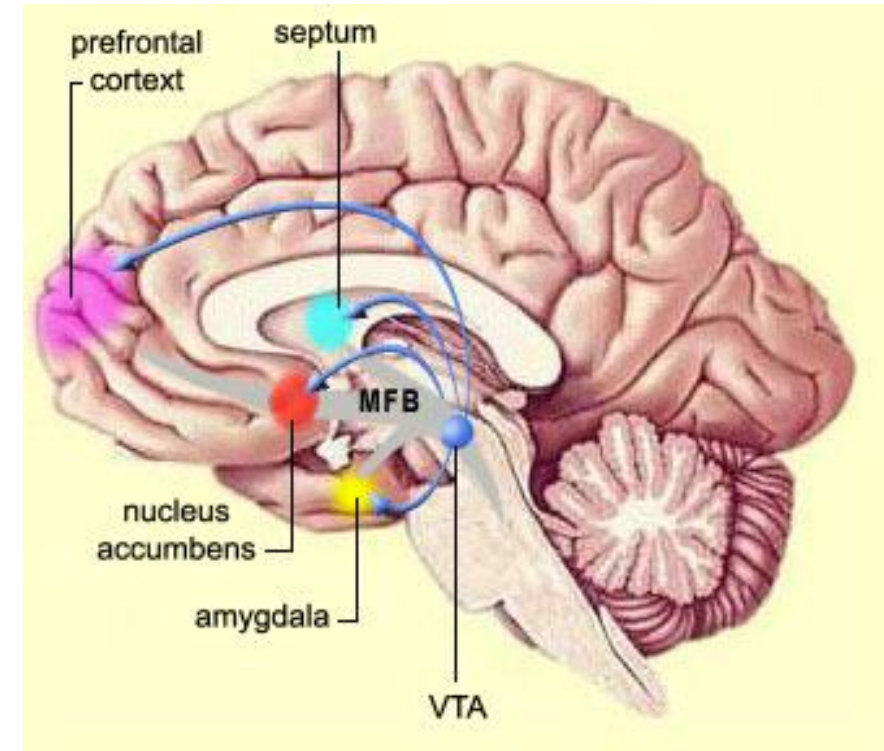

Retrograde signaling by EC

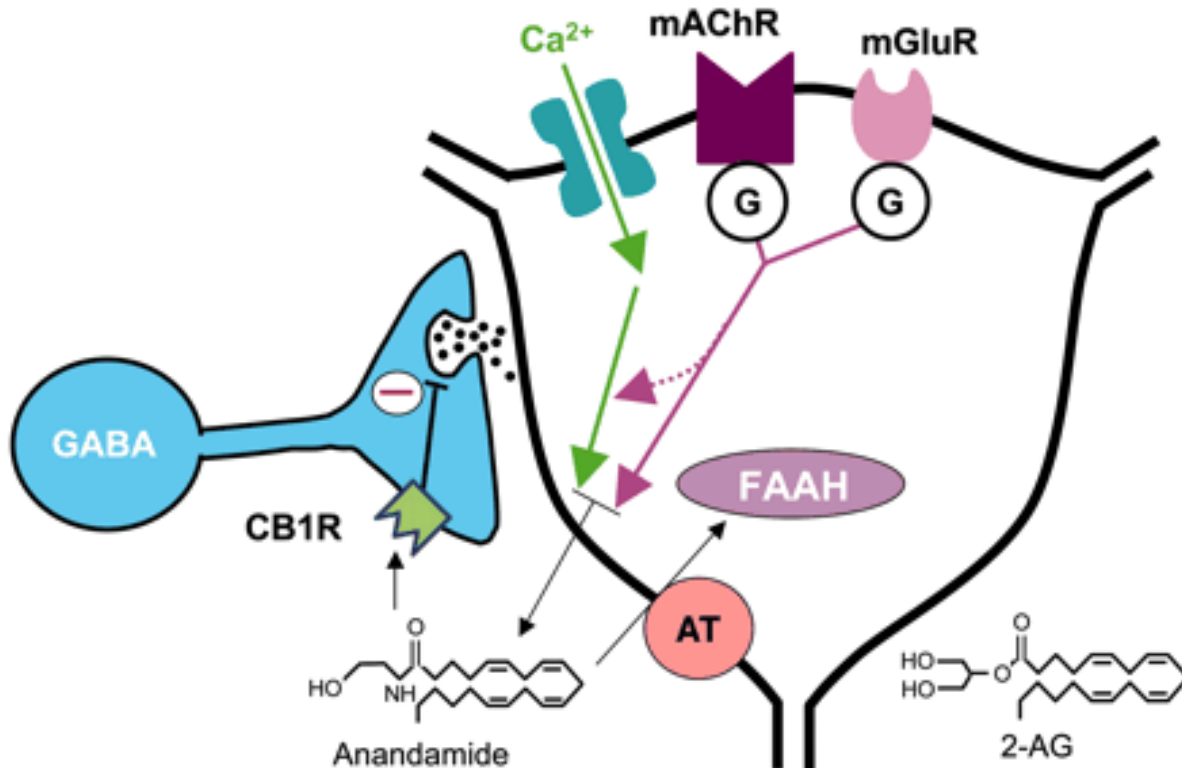

- The endocannabinoids (EC) anandamide and 2-AG are synthesized in postsynaptic target cells such as hippocampal pyramidal cells (right). Synthesis is initiated by calcium influx through voltage-gated calcium channels, or by the activation of G protein-coupled neurotransmitter receptors, including type I metabotropic glutamate receptors (mGluR) or muscarinic acetylcholine receptors (mAChR)
- The EC gain access to the extracellular space and activate CB1 cannabinoid receptors found concentrated on certain nerve terminals, e.g., of cholecystinin-containing GABAergic interneurons in hippocampus
- CB1 activation causes presynaptic inhibition of GABA or glutamate release by inhibiting calcium channels, interfering with vesicle release, and activating potassium channels
- The EC are taken up into postsynaptic or presynaptic cells by the anandamide transporter (AT). The degradative enzyme FAAH is present in postsynaptic cells, and monoglyceride lipase (not shown), which degrades 2-AG, is found in presynaptic terminals.

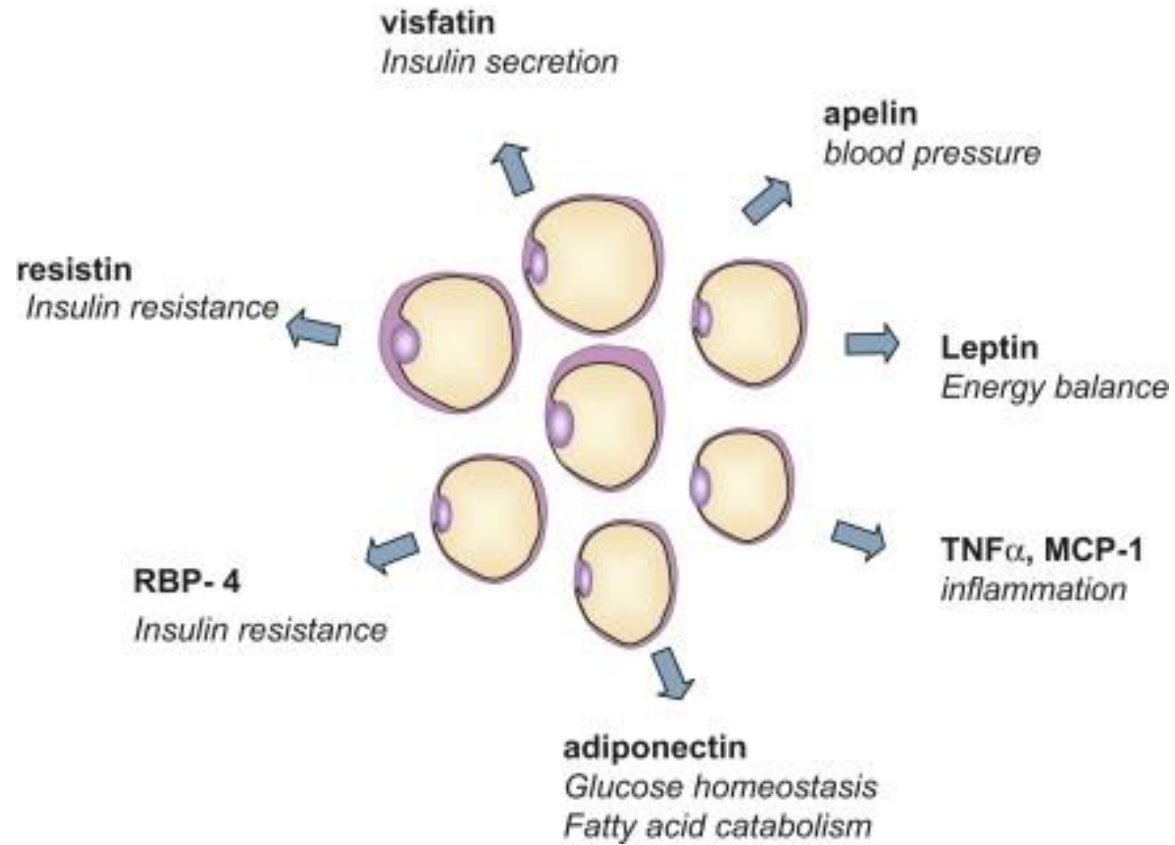

ADIPOSE TISSUE AS AN ENDOCRINE ORGAN

Adipokines (vs. insulin sensitivity)

| HORMONE | TARGET TISSUE/ORGAN | PLASMA LEVELS | METABOLIC EFFECT |
|-----------------|--|---|--|
| Leptin | CNS (hypothalamus), muscle, ovary) | positive correlation with BMI | central – long-term ↓ of appetite and ↑ of sympathetic activity; peripheral - ↑ insulin sensitivity and lipid metabolism |
| Adiponectin | insulin-dependent tissues (muscle!) | negative correlation with BMI | ↑ of insulin sensitivity, ↑ NEFA oxidation, antiinflammatory |
| Resistin | insulin-dependent tissues (muscle!) | positive correlation with BMI in rodents | ↑ insulin resistance, pro-inflammatory |
| TNF- α | insulin-dependent tissues (muscle!) | positive correlation with BMI | interferes with insulin receptor signalling (phosphorylation of serin residues) – ↑ insulin resistance |
| IL-6 | ? | positive correlation with BMI | ? (pro-inflammatory?) |
| Angiotensinogen | adipose tissue (para- and autocrine action), endocrine as a part of systemic RAAS? | expression in adipose tissue positively correlates with BMI | influence adipocyte differentiation, ↑ lipogenesis, circulatory effect of obesity ij systemic circulation? |

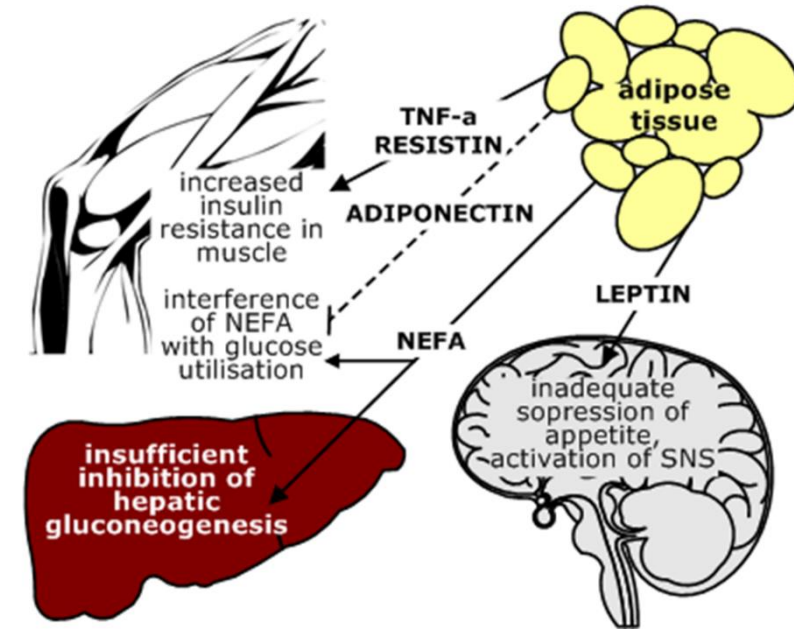

... others (omentin, visfatin, apelin, ...)

- many adipokines interfere with insulin signaling
 - on the receptor level
 - post-receptor interference

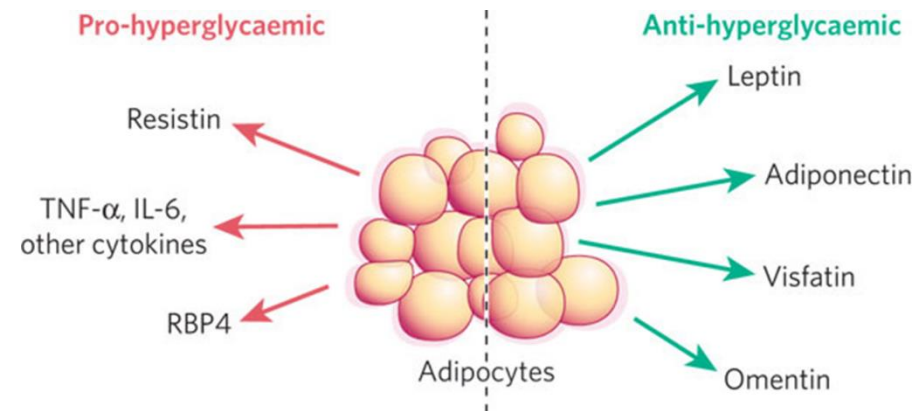



CONSEQUENCES OF OBESITY – METABOLIC SYNDROME

Summary

- **unlimited storage of fat is not metabolically „safe“!!!**
 - as to why is not clear?
- critically limited energy resources in adverse living conditions were likely evolutionary much more important factor than eventual consequences of affluence
 - selection of **“thrifty genotype”** in the hunter-gather period enabled its carriers to make the most from minimal resources and represented **selective advantage**
 - the very same metabolic regulatory tools preventing us from life-threatening energy depletion form basis of metabolic diseases nowadays
 - esp. insulin and leptin resistance
- humoral products of adipose tissue actively participate in multiple regulations negatively affecting
 - carbohydrate and lipid metabolism
 - vascular homeostasis and circulation
 - ↑ ICAM, ↓ NO
 - immunity
 - ↑ some cytokines and RAF
 - fibrinolysis
 - ↑ PAI-1
 - reproduction



METABOLIC SYNDROME

nature
medicine

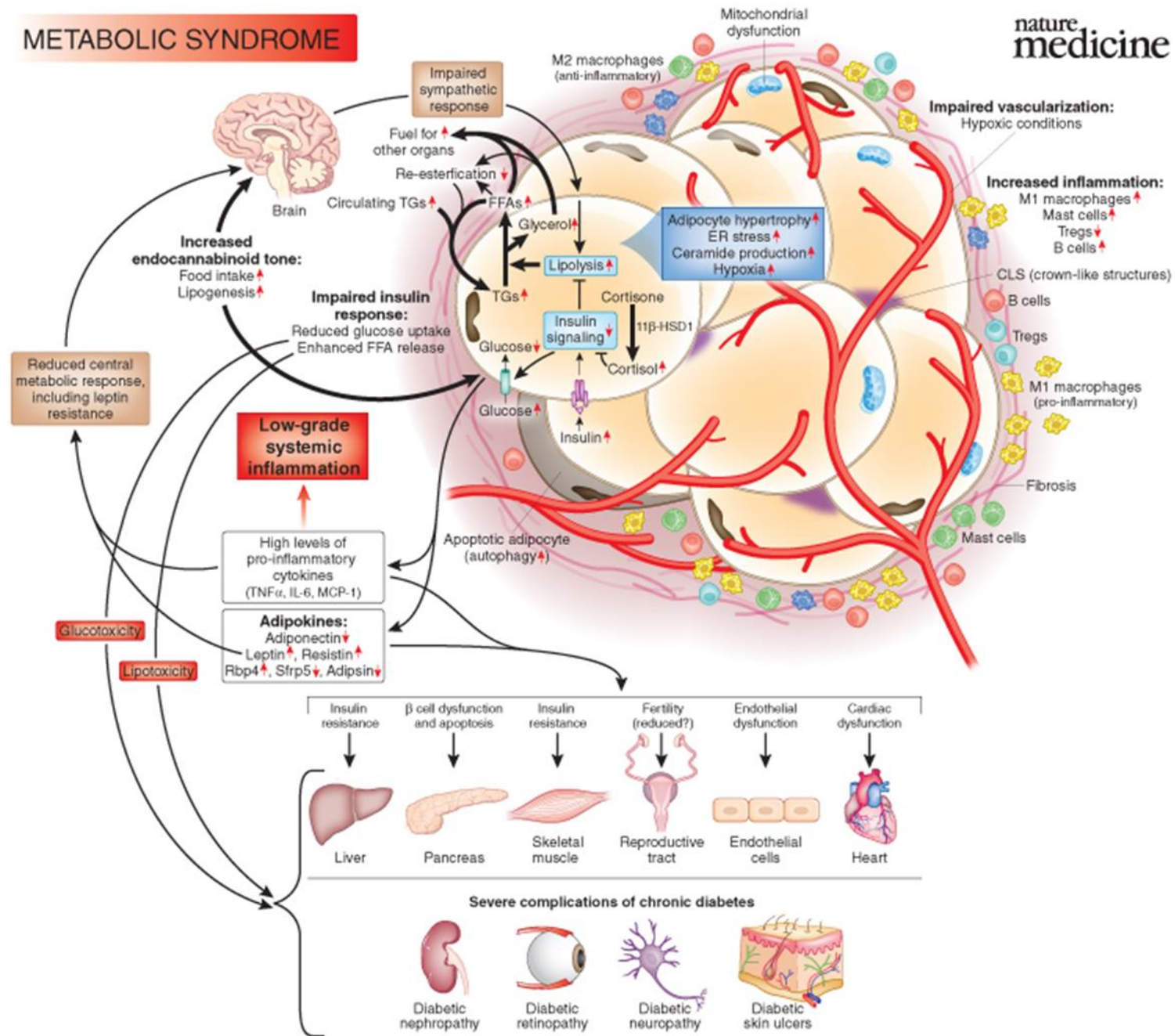

How technology changes us ...

