

INTERNAL MRI COURSE

Mgr. Ing. Marek Dostál, Ph.D. – DRNM UHB + Biophys. FacMed. Masaryk Uni.

Translation from Czech was done by automatic PowerPoint translator without human control, so the language quality can be poor. Sorry for that.

WHY KNOW THE BASICS OF MRI



Skin touch



Thermoflect blanket lined with aluminum



2nd degree burn caused by silver microfiber in the shirt



Tattoo burns



Leads burns



3rd degree burn caused by direct contact with RF coil

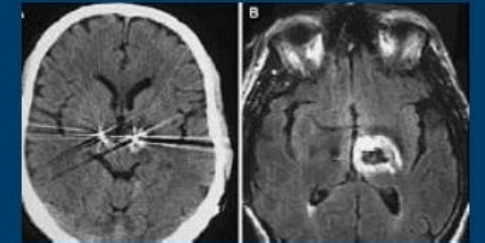

Hemorrhage due to heating at an electrode tip of a neurostimulator

HISTORY OF MRI

- 1921 – Discovery of electron spin (A. Compton).
- 1924 – Discovery of nuclear spin (W. Pauli).
- 1938 – Confirmation of the Magnetic Quantum Phenomenon (NMR) (I.I. Rabi).
- 1945 – Improvement of the Rabi instrument (birth of NMR spectroscopy) (F. Bloch and E. Purcell).
- 1949 – Discovery of chemical shift.
- 1971 – Different tissues have different relaxation periods (R. Damadian).
- 1973 – the beginnings of tomographic MRI (P. Lauterbur).
- 1977 – First full-body MRI (R. Damadian).
- 1987 – birth of MR angiography (blood flow imaging).
- 1992 – Birth of functional MRI (fMRI).
-

MAGNETIC FIELD

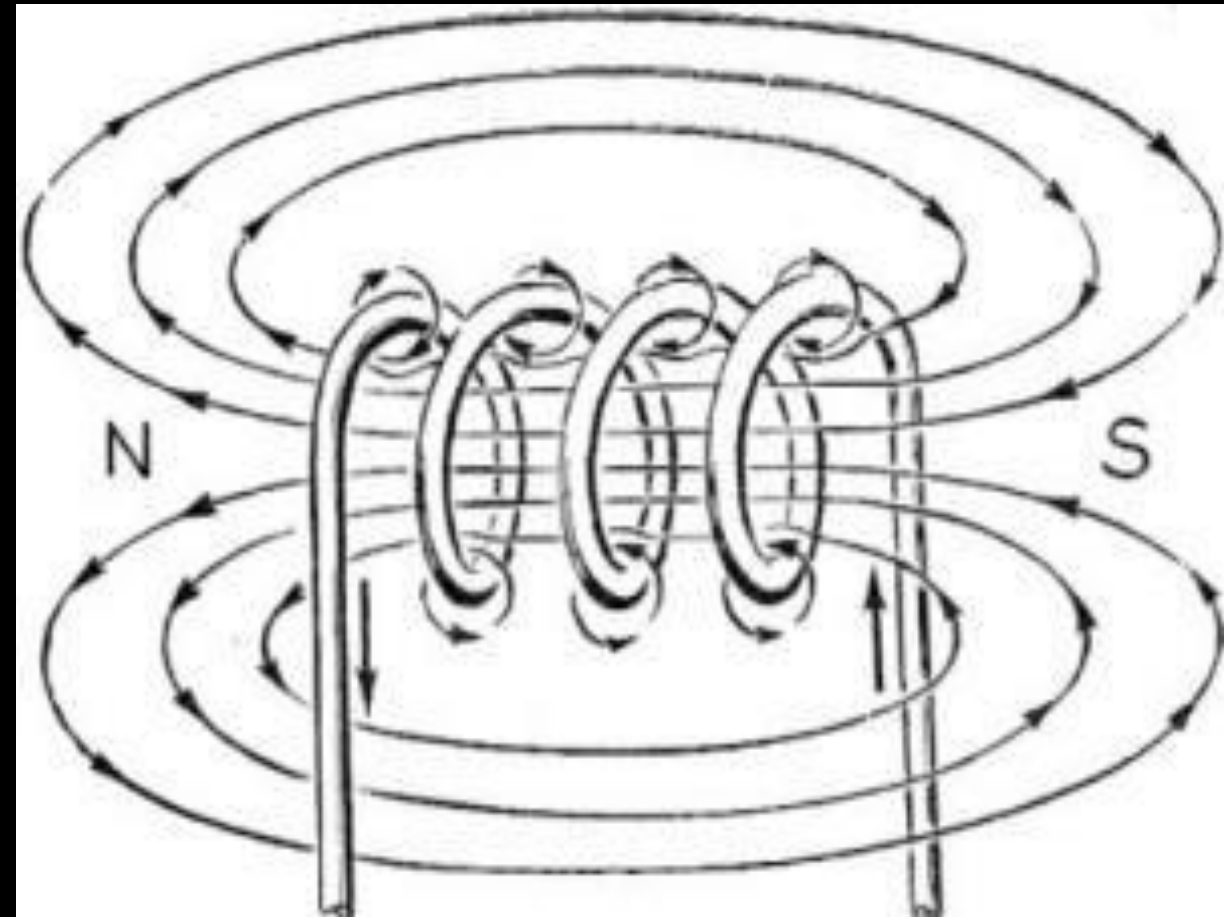
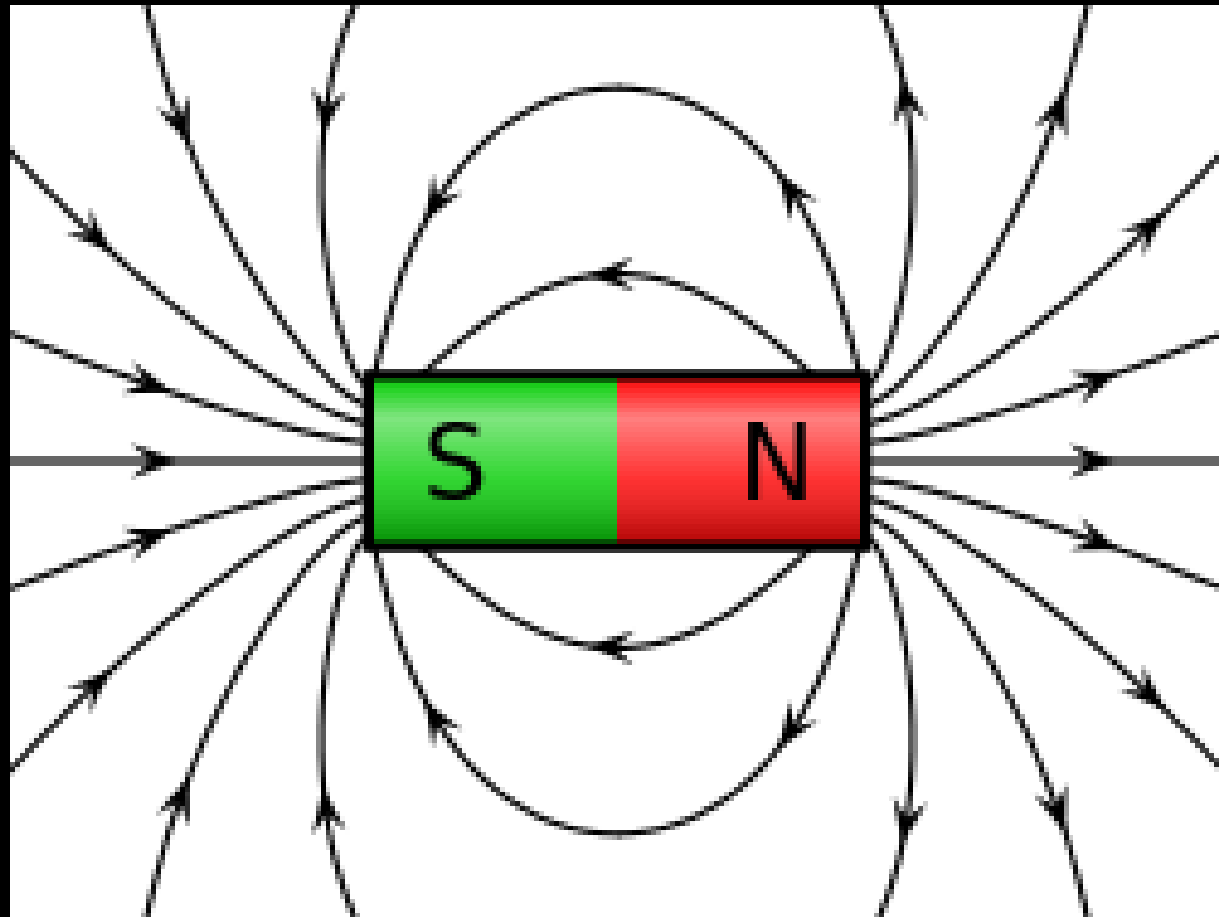

MAGNETIC FIELD

- Homogeneity of mag. Field
- Coils
-

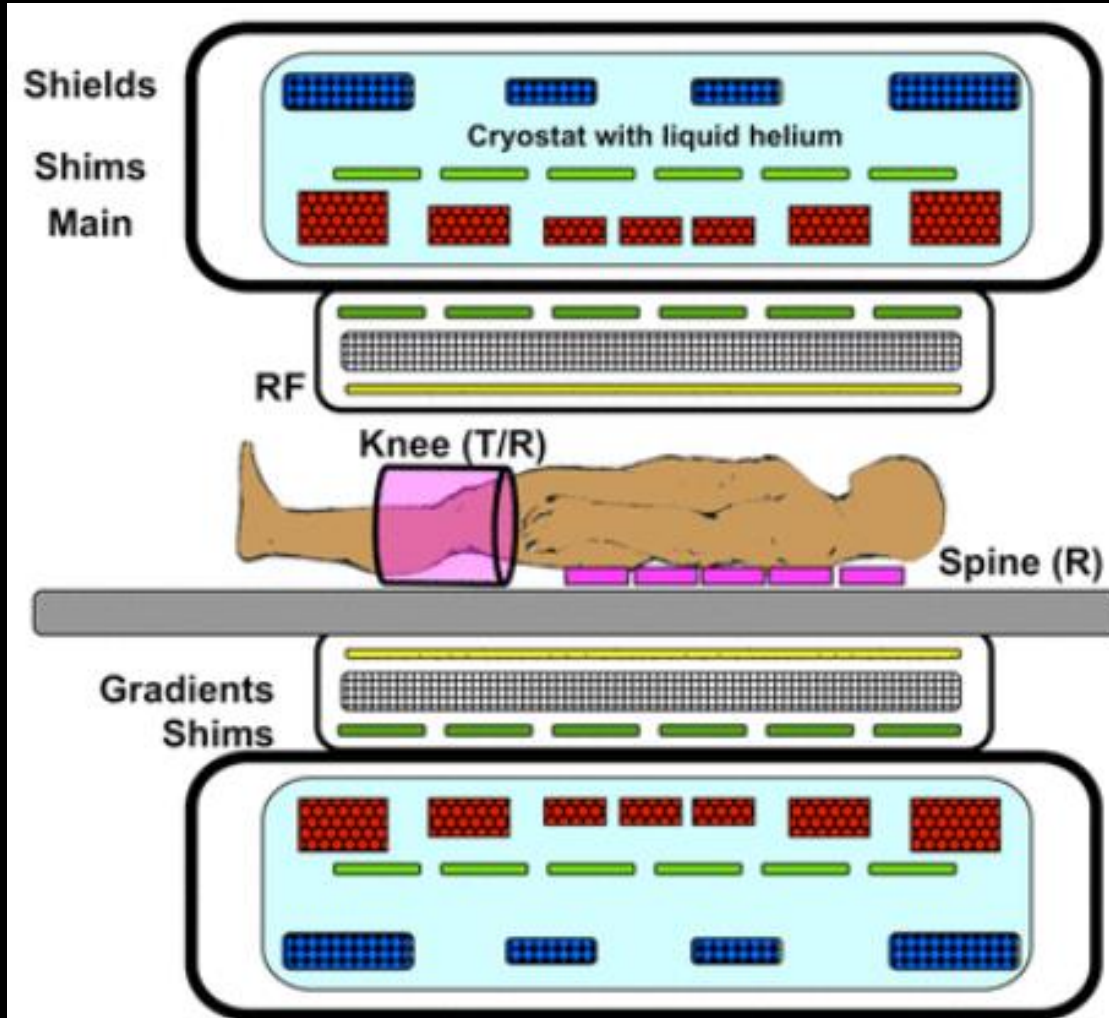
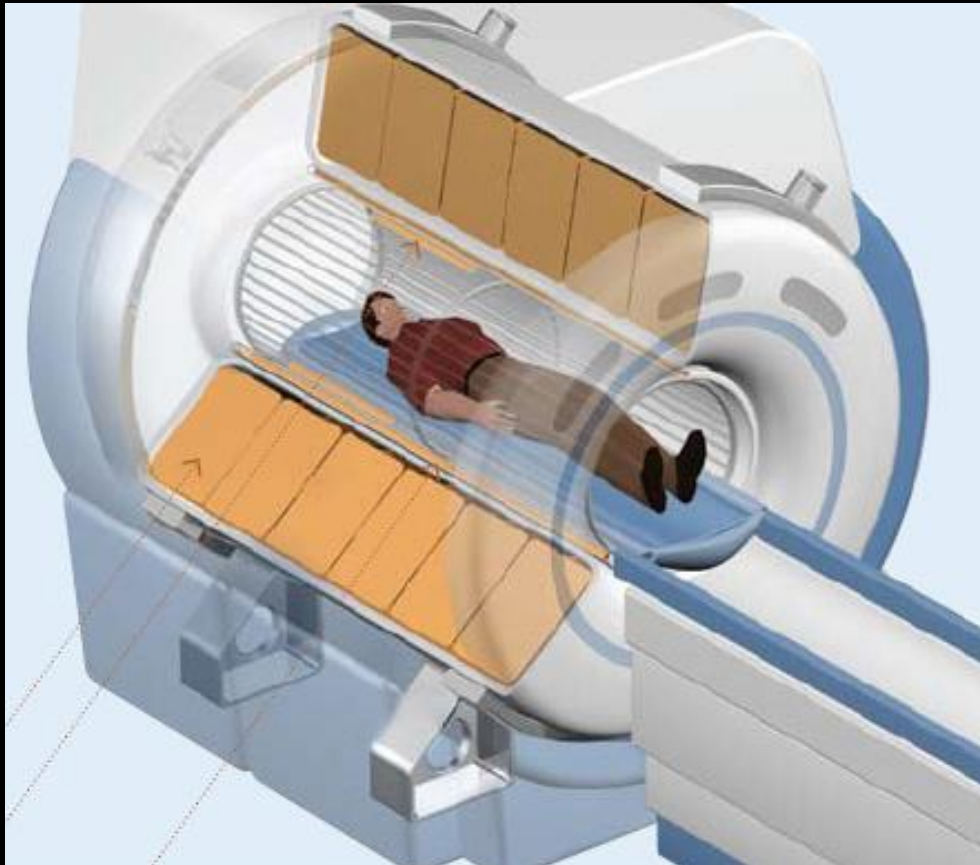

MAGNETIC FIELD

- Magnetic moment (μ)
- It characterizes the source of the magnetic field.
- Vector quantity.
- What does this have to do with MR?
-



MAGNETIC FIELD

- Electrons "orbit" around the nucleus (analogy with a coil).
- Orbital mag. torque (μ_L)
- Electrons have an internal angular momentum ("rotation around an axis").
- Spin mag. torque (μ_S)
- Nucleons have an internal angular momentum ("rotation around an axis").
- Nuclear mag. moment
-

MAGNETIZATION

N = počet částic v látce
 V = objem látky

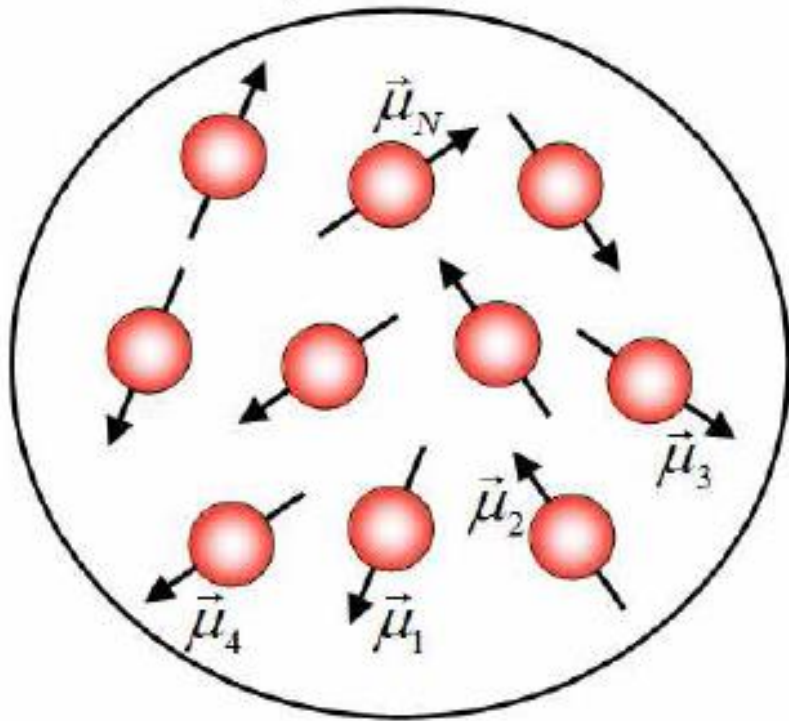

$$\vec{M} = \frac{1}{V} \sum_{i=1}^N \vec{\mu}_i$$

$\vec{\mu}_1 \dots \vec{\mu}_N$

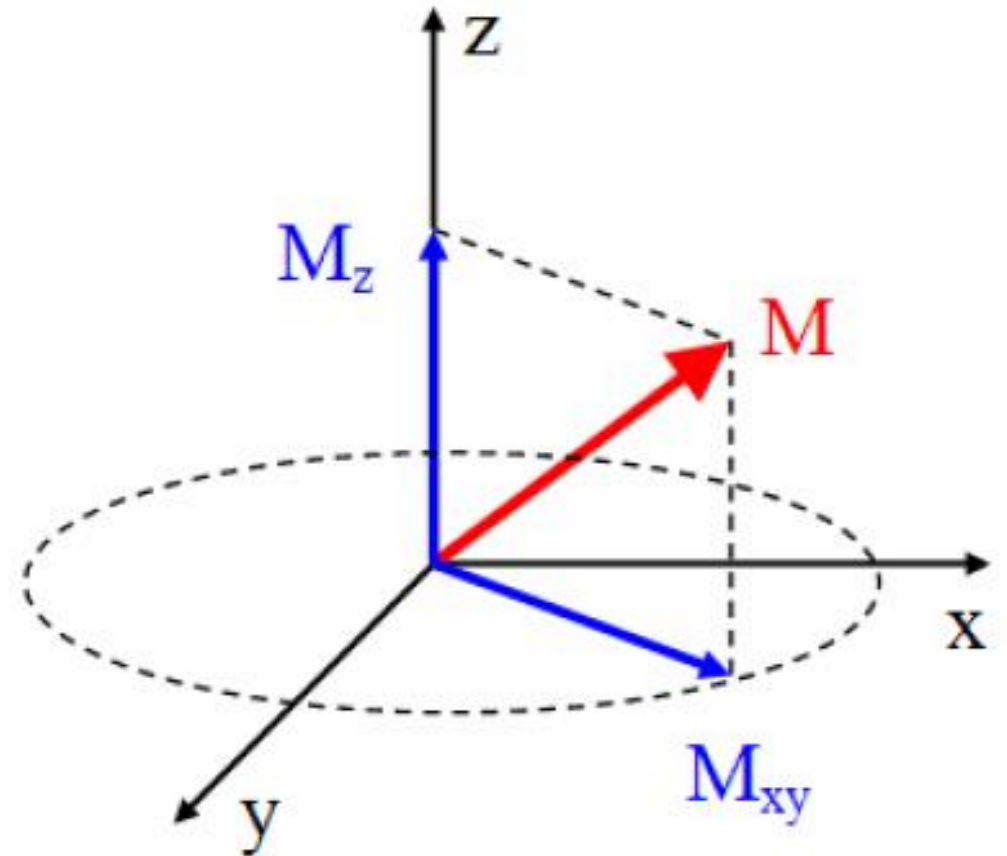

MAGNETIZATION

- As a result of the non-zero temperature ($T > 0$ K), the particles move completely randomly, and also the orientation of the magnetic moments is completely random.
- Therefore, the mean value of the magnetization vector is zero $\langle \vec{M} \rangle = 0$.
- Orientation mag. moments in a strong external static mag. Field.
- Compass needle
-

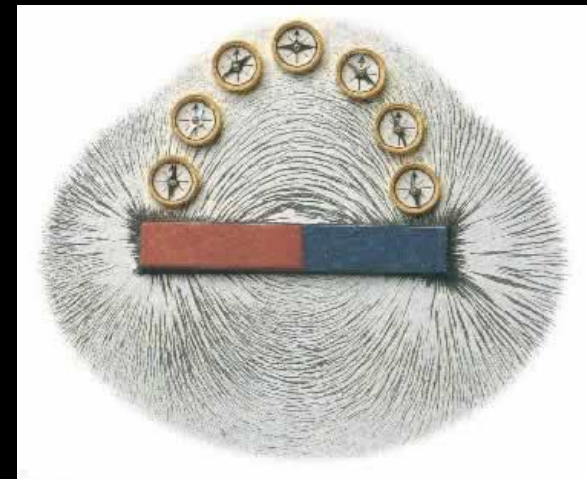

MAGNETIZATION

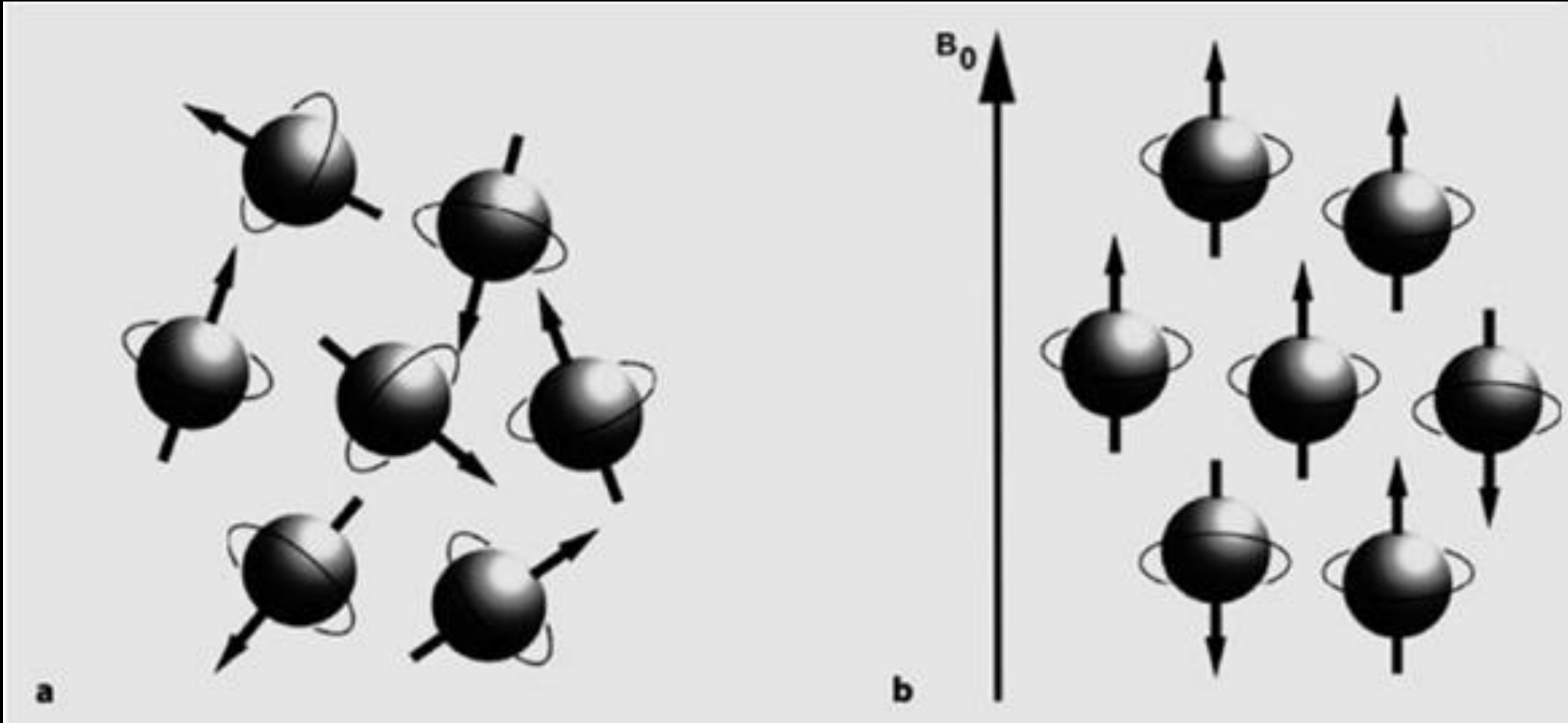

MAGNETIZATION

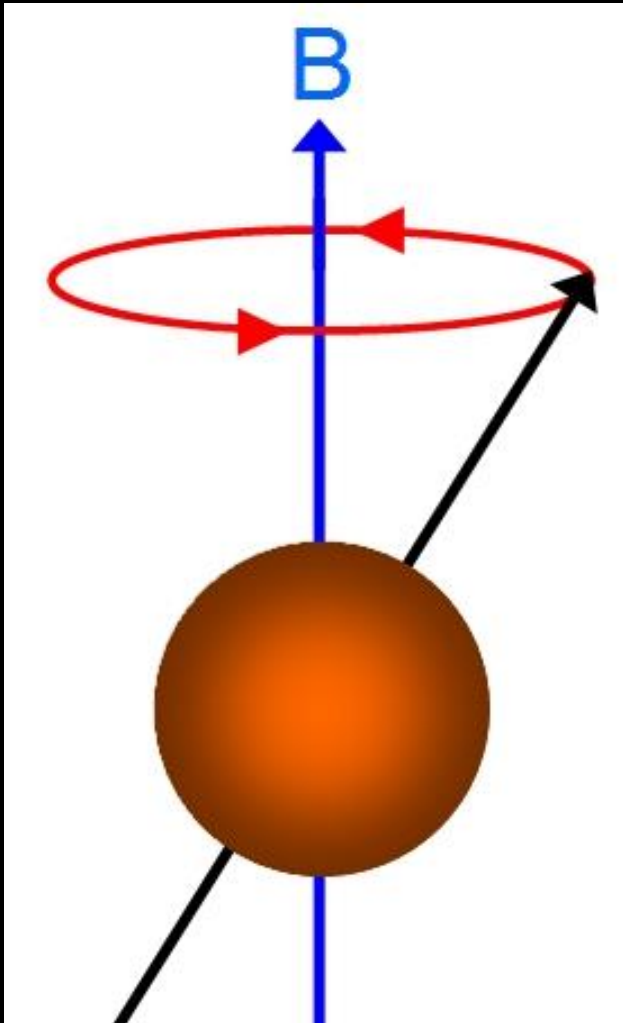

$$f_L = \frac{\gamma}{2\pi} B_0$$

$$E = hf$$

Atom	Isotop	f_L [MHz] v B=1T
Vodík	^1H	42,7
Uhlík	^{13}C	10,7
Dusík	^{14}N	6,1
Fosfor	^{31}P	17,2

Velikost mag. pole

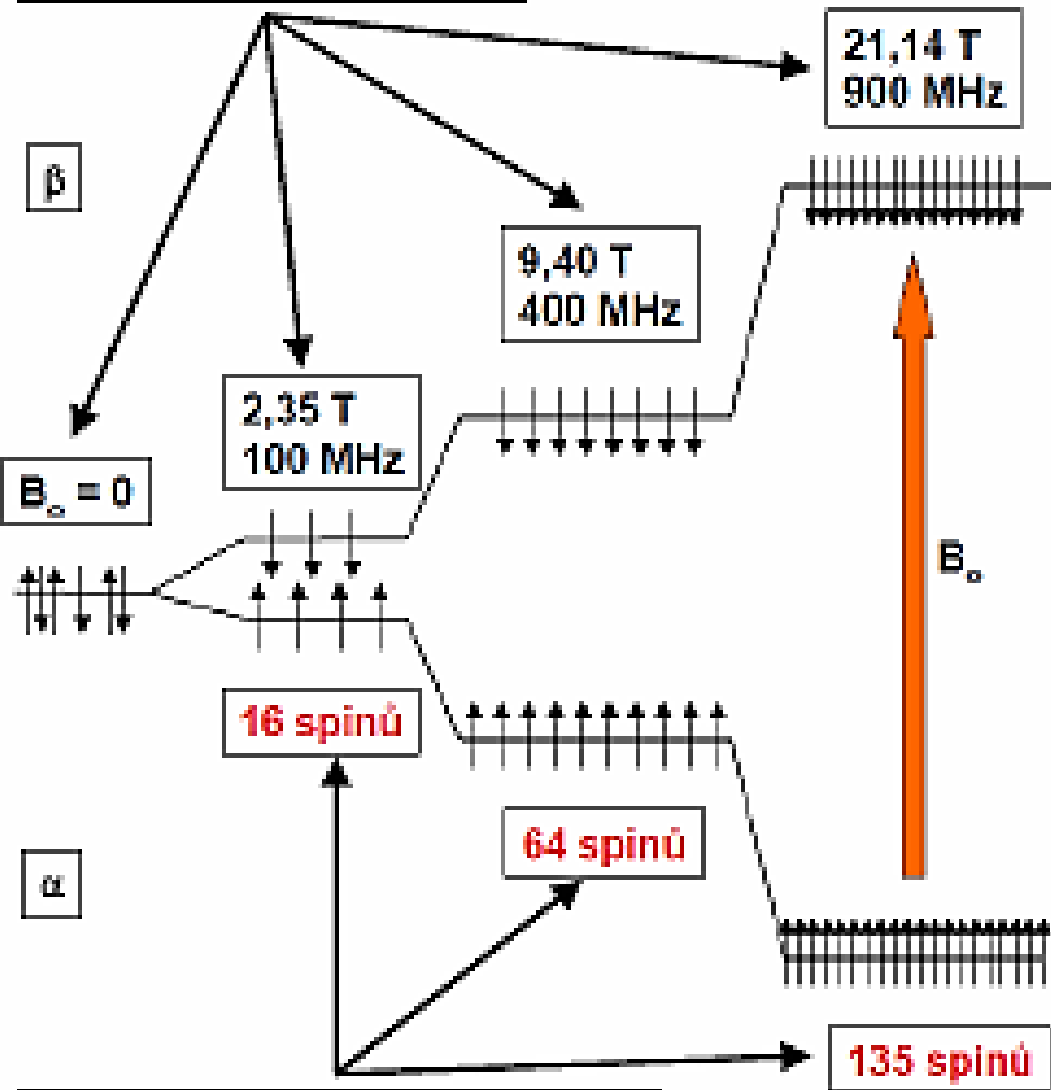

Přebytek spinů na nižší energetické hladině

MAGNETIZATION

$$\frac{N_\alpha}{N_\beta} = e^{\left(\frac{\Delta E}{k_B T}\right)}$$

$$\Delta E = \gamma \hbar B_0$$

RELAXATION

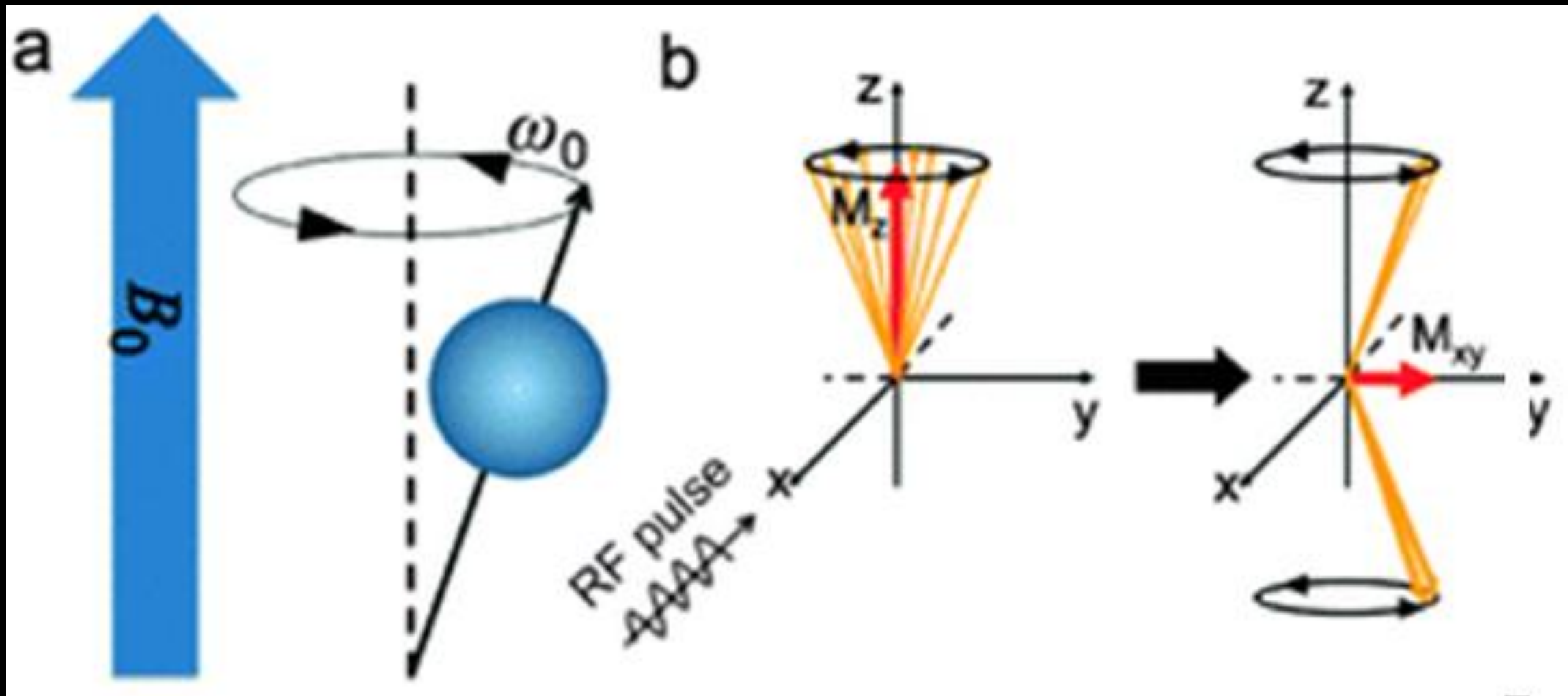

RELAXATION

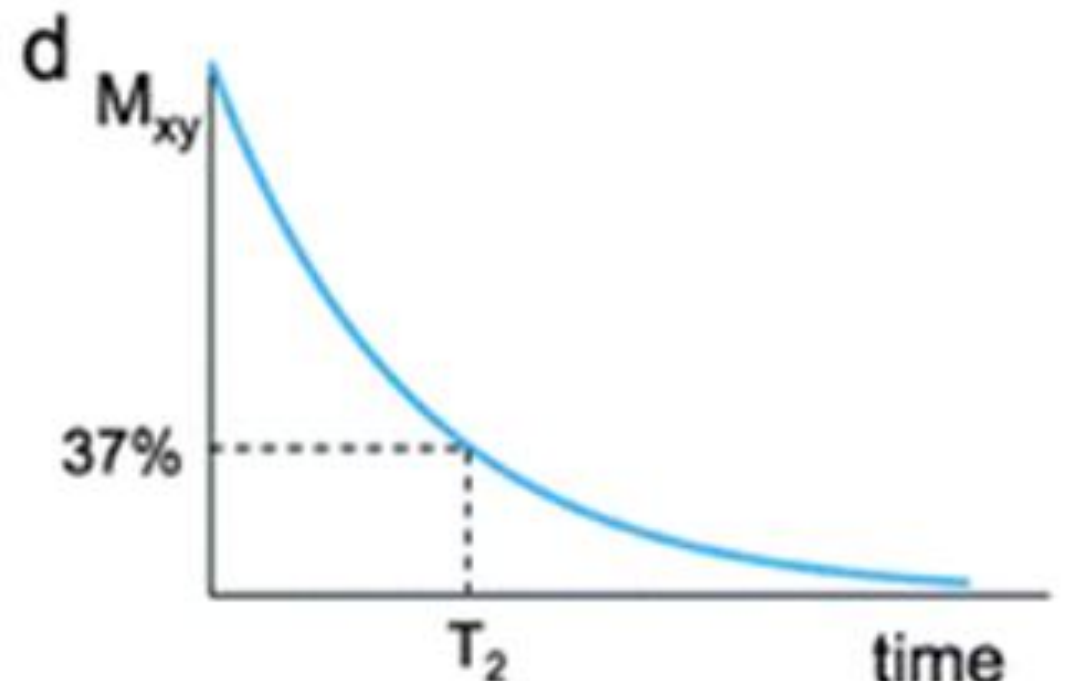
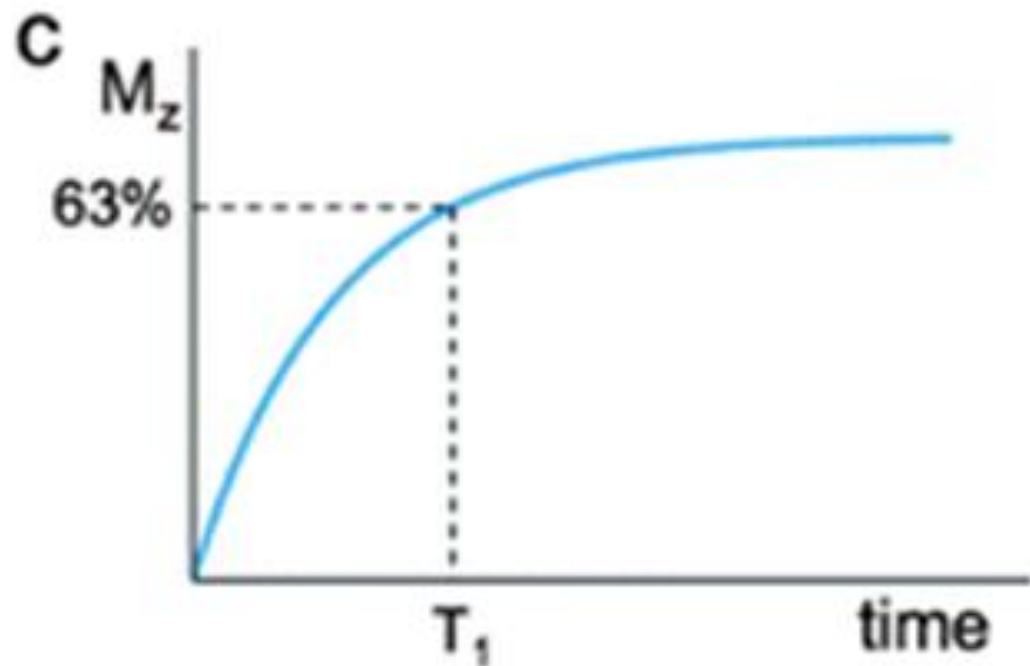
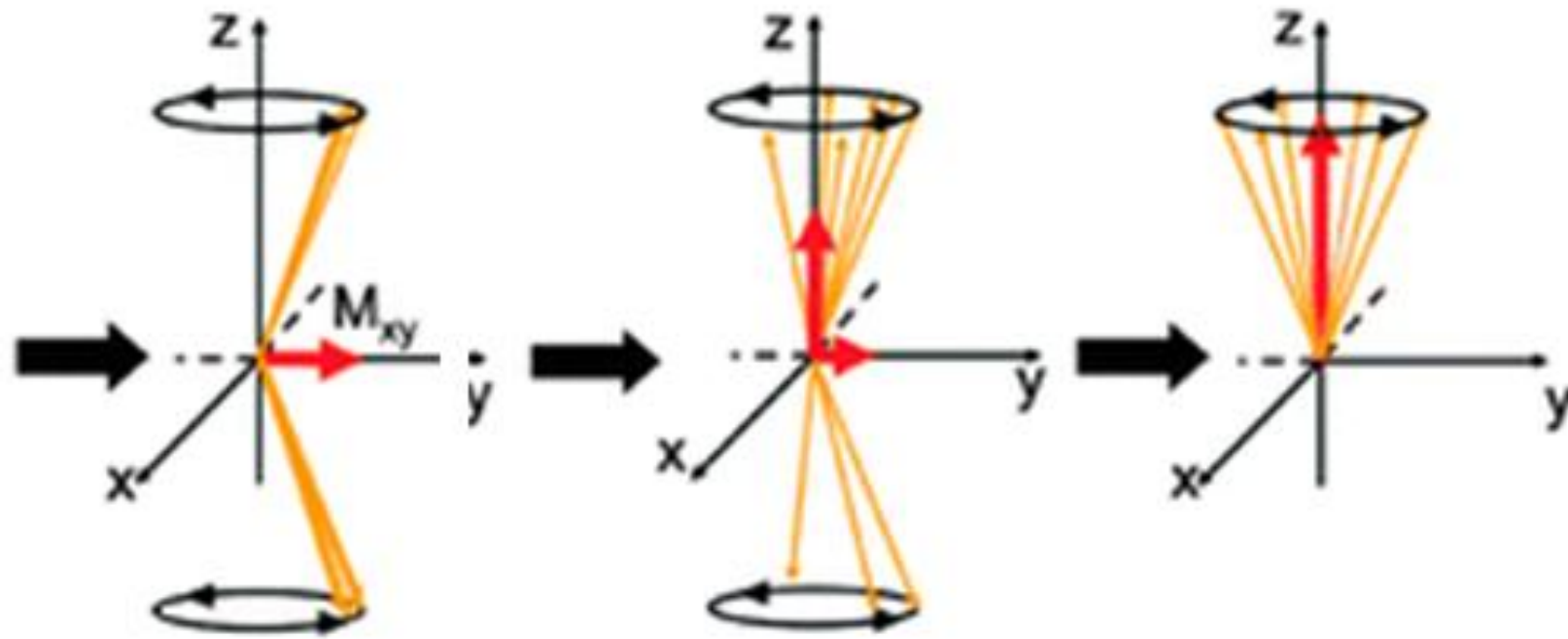

RELAXATION

Typ látky	T ₁ [ms]	T ₂ [ms]
tuk	250	60
sval	900	50
krev	1400	100-200
Mozek		
šedá hmota (GM)	950	100
bílá hmota (WM)	600	80
cerebrospinální tekutina (CSF)	2000	250

RELAXATION

Spin-nířžková interakce (T1)

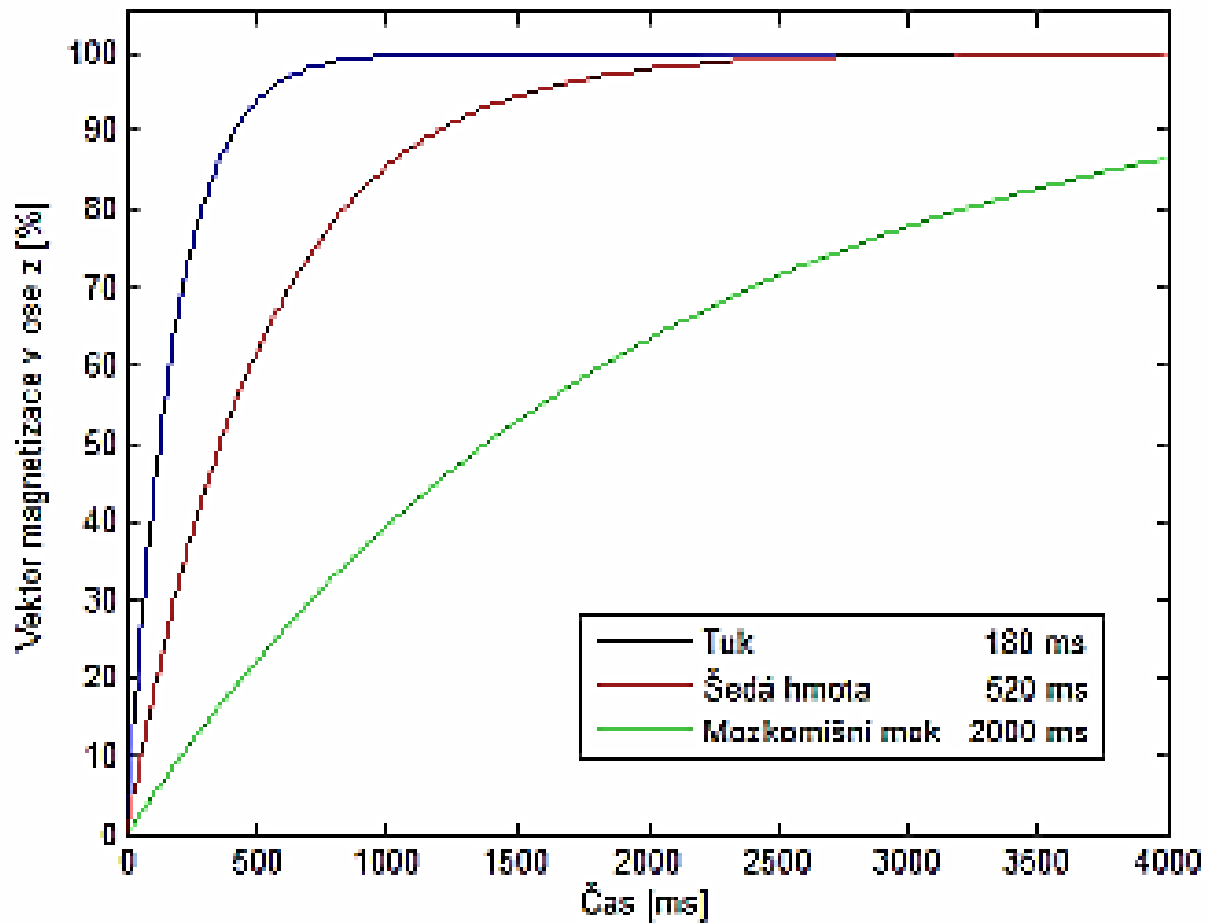

Spin-spinová interakce (T2)

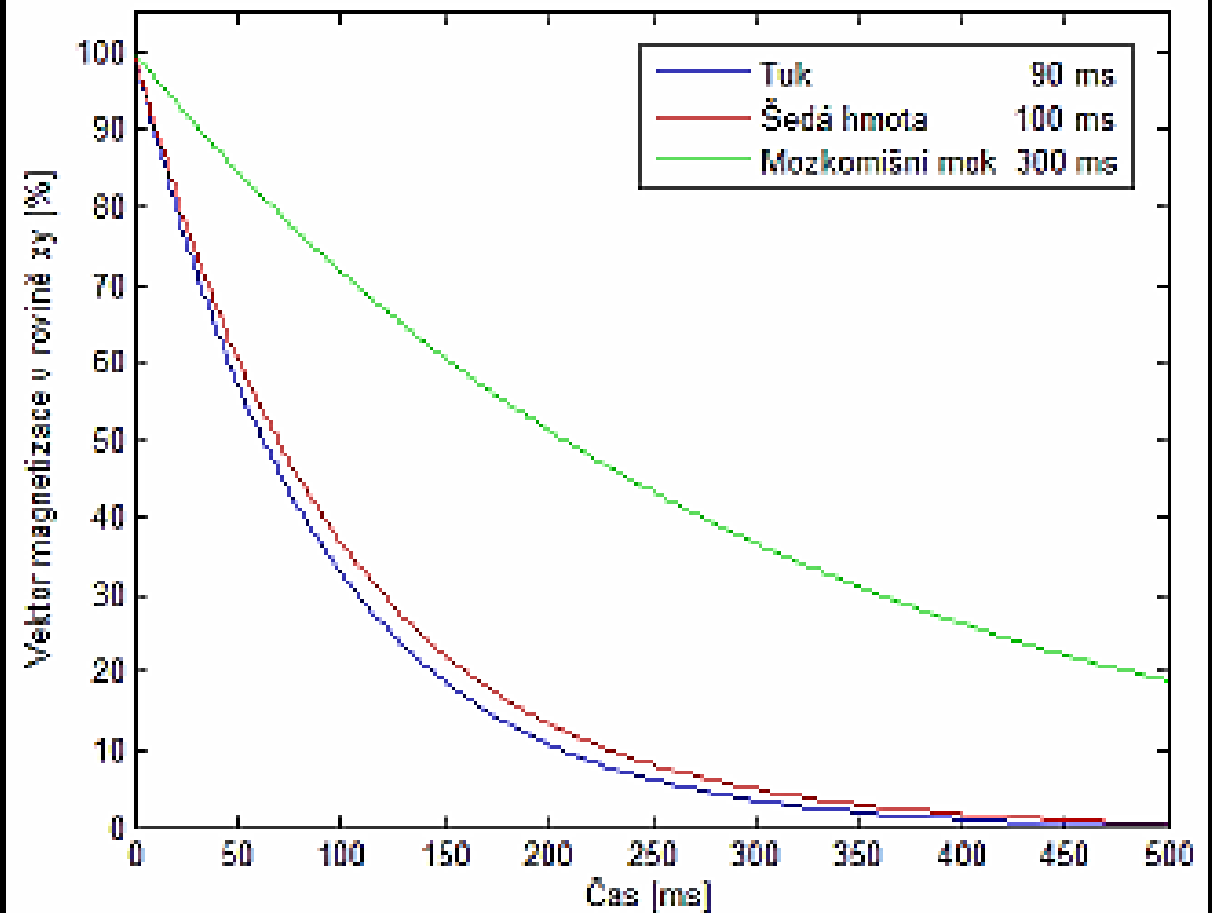

SIGNAL

- Signal detection is based on electromagnetic induction:
- If the magnetic induction flux changes through the coil, the induced electromotive voltage is induced in it.
- When the magnetization changes, the magnetic induction flux changes, and an alternating current of Larmor frequency is induced in the detection coils.
- The amplitude of the voltage is proportional to the magnetization and therefore the density of the nuclei.
- Free Induction Decay FID is a periodic damped function.

$$FID = M_0 \cos(\omega_0 t) e^{-\frac{t}{T_2^*}}$$

SIGNAL

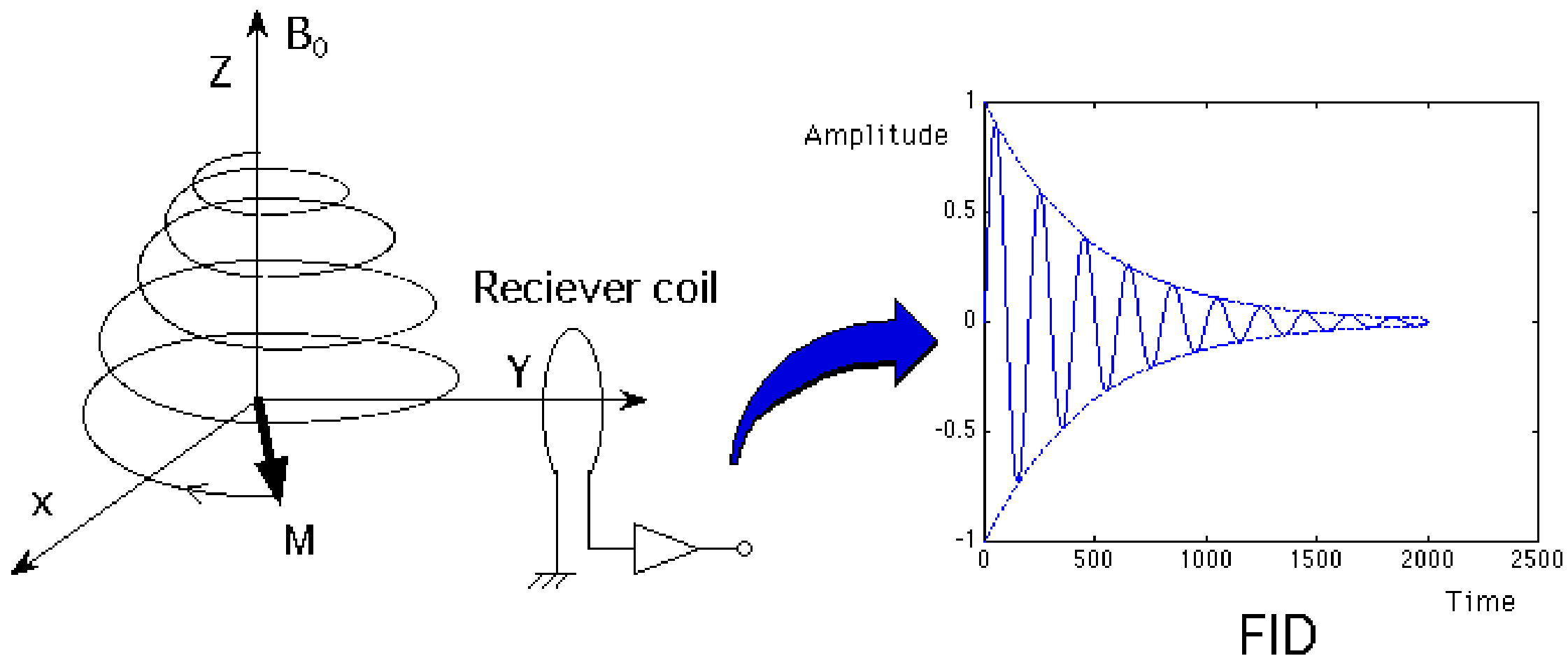

SIGNAL

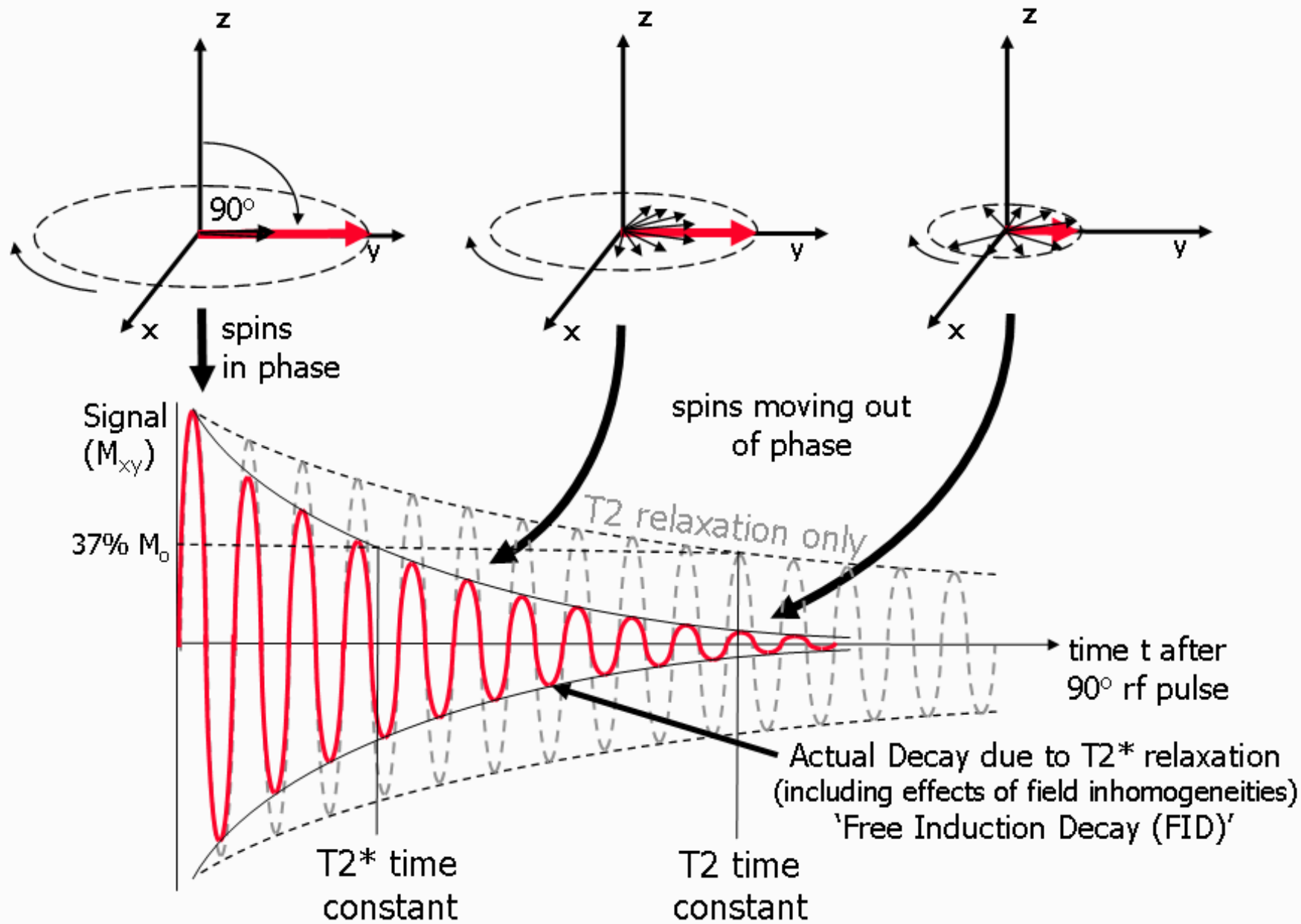

SIGNAL

MR Signal with
Sampled Raw Data



Re -1.028

Im +0.913

Each data point is a

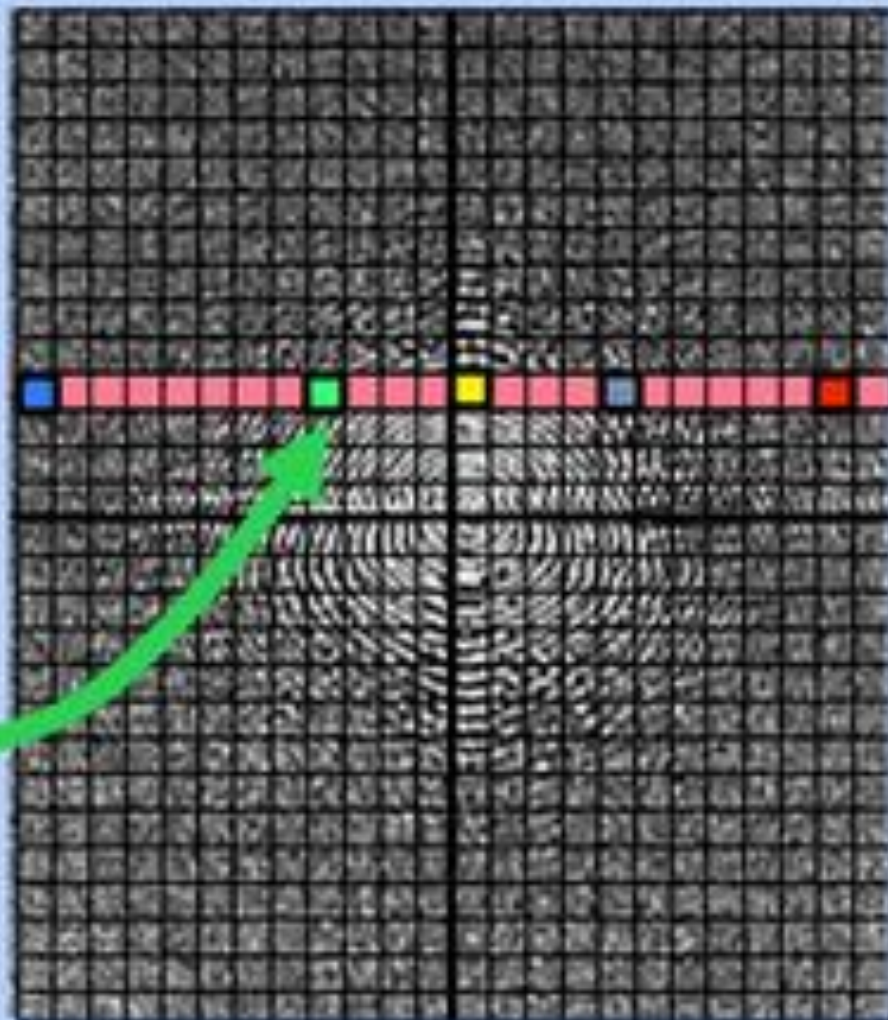

BANDWIDTH

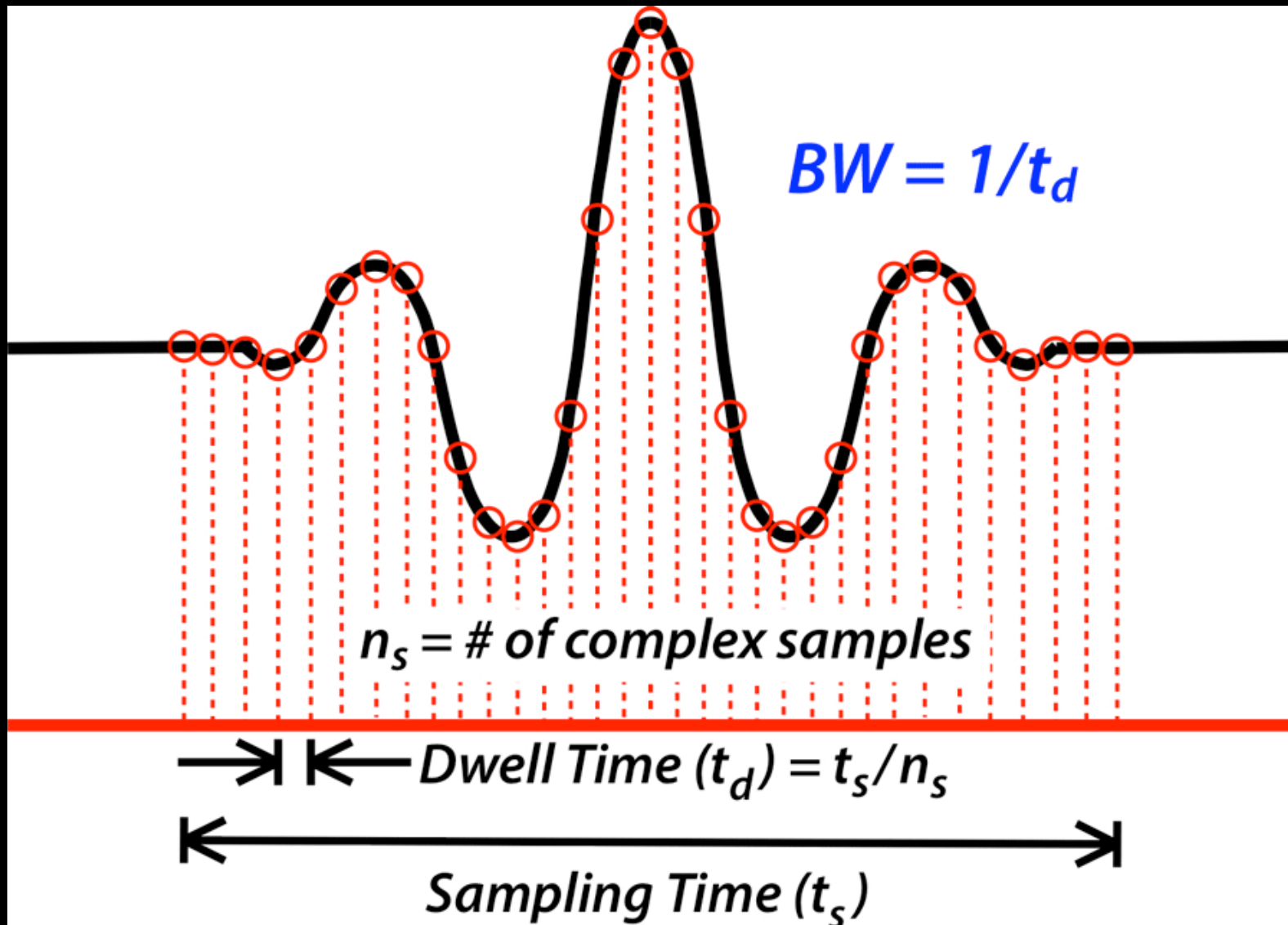

FOURIER TRANSFORM

- A Fourier transform is applied to the signal.
- What does the Fourier transform do?
- Converts a signal from the time domain to the frequency domain.
-

$$S(\omega) = \int_{-\infty}^{\infty} s(t)e^{-i\omega t} dt$$

FOURIER TRANSFORM

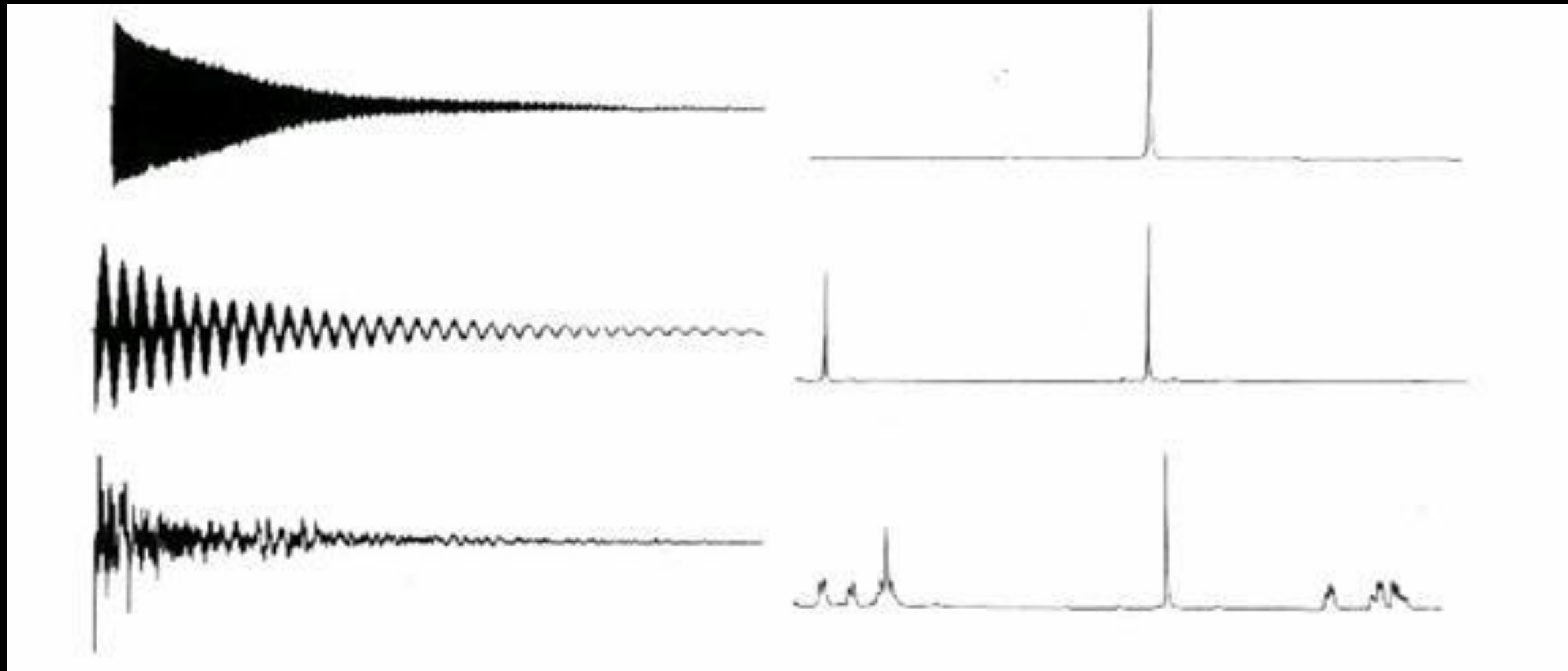

POSITIONAL CODING

- But how do we know exactly where we are detecting the signal from?
- Because we detect the signal from the entire investigated area at the same time, the spatial information in the FID signal is lost.
- We need to include information about the location of the signal source artificially in the signal.
- For this we use three gradient coils.
- We place these gradient coils so that they produce a variable but time-constant magnetic field in space.
- The magnetic induction of this field is significantly smaller than the outer field B_0 .
- The variability (gradient) of these fields is determined exactly for the needs of the experiment (knowledge of the gradient in the x, y, z axes is essential).

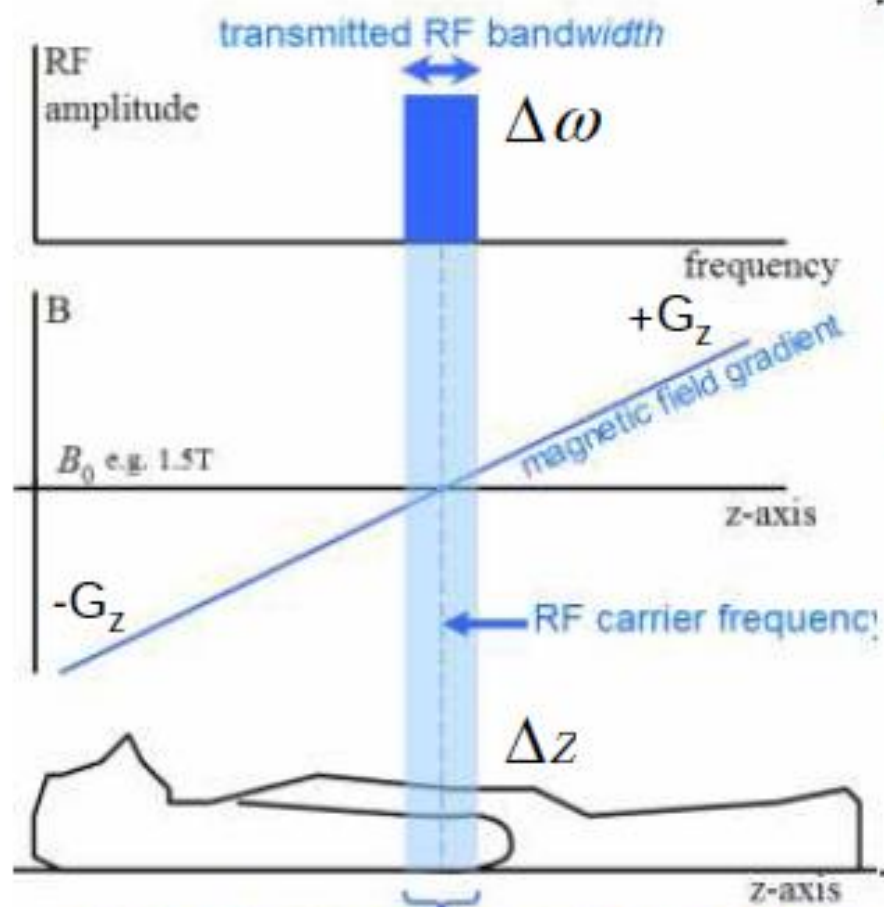

Larmor equation applies here: the image slice



Nižší

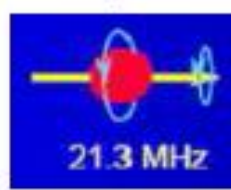

Vyšší

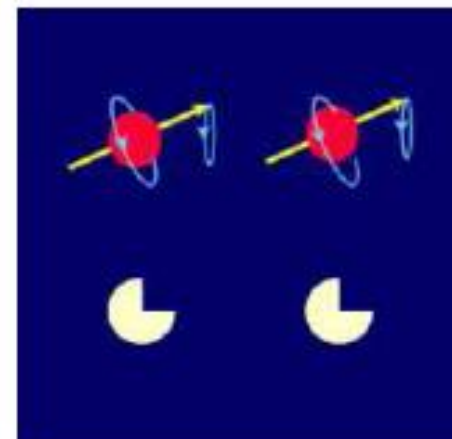
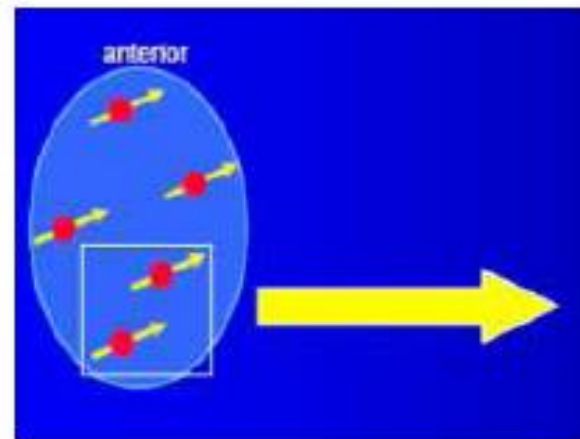

Všechna jádra uvnitř zvolené tomografie precesují se stejnou frekvencí i fází.

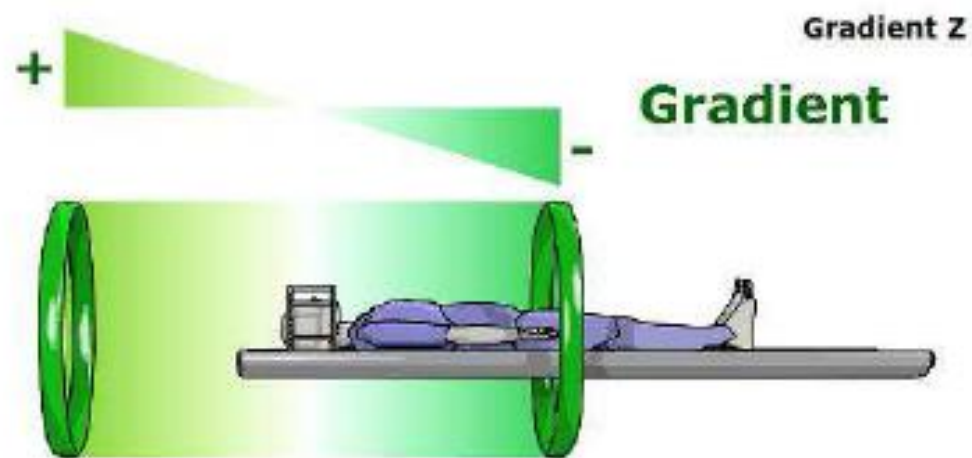

$$\Delta\omega = \gamma \cdot G_z \cdot \Delta z$$

Gradient Y



Gradient

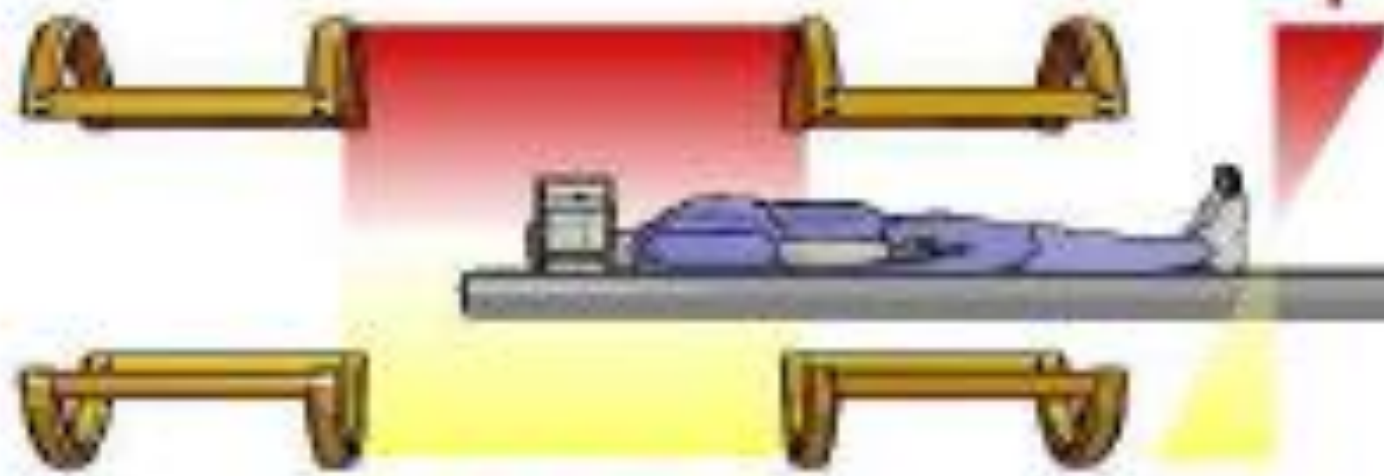

$B_0 +$
Gradient

-



+
Gradient



$B_0 +$
Gradient
Gradient X

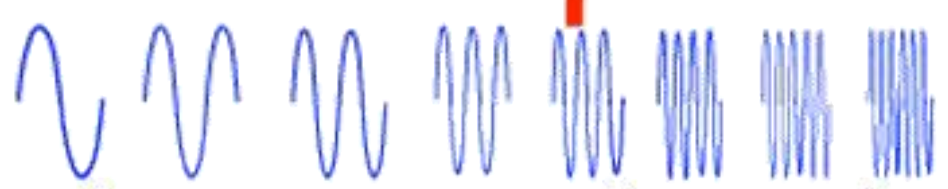
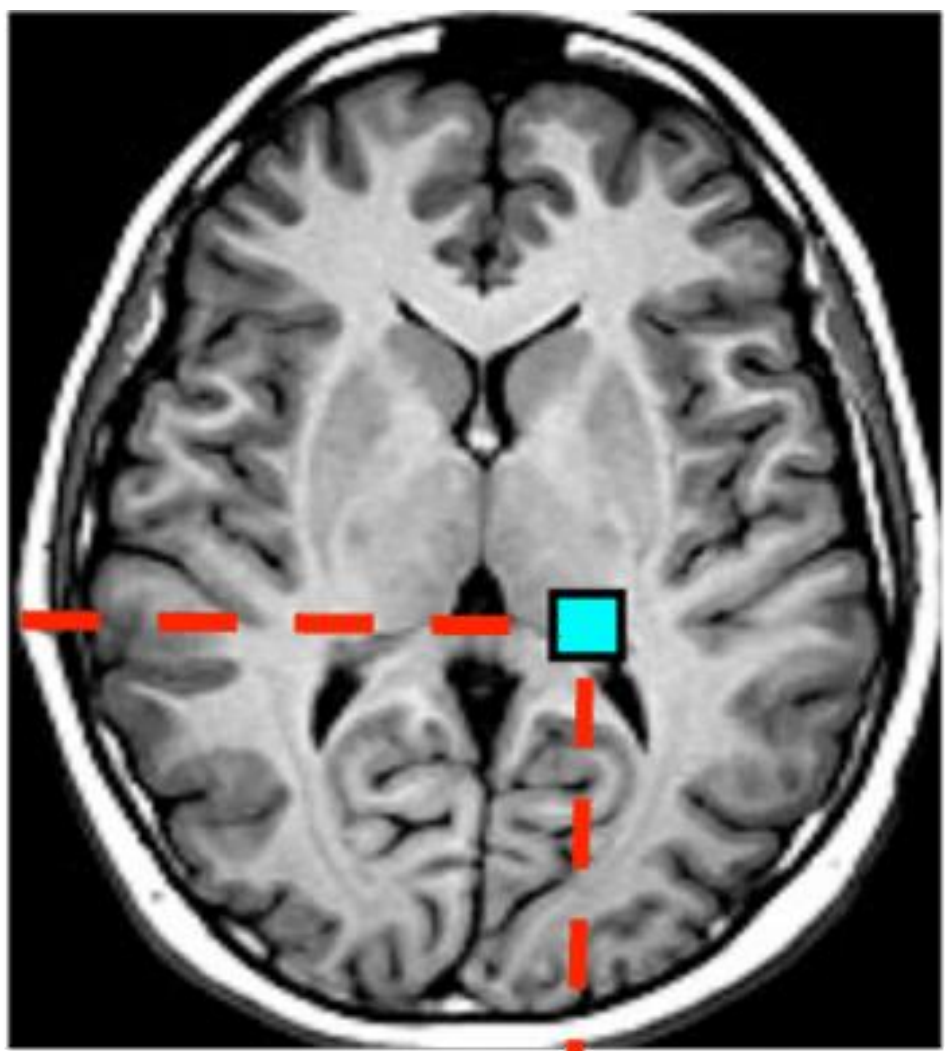

PULSE SEQUENCE

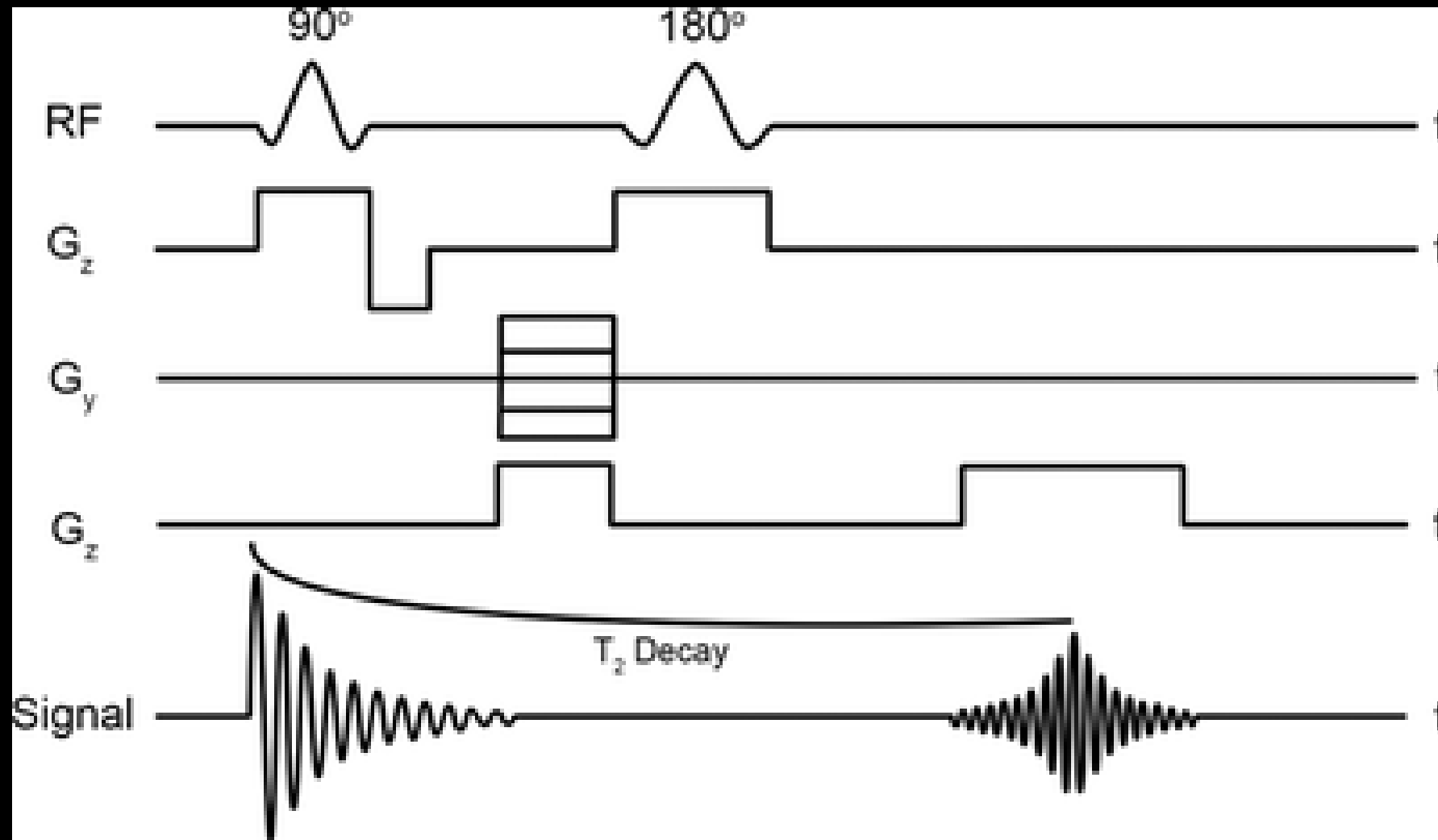

MR Signal with
Sampled Raw Data



Re -1.028
Im +0.913

Each data point is a

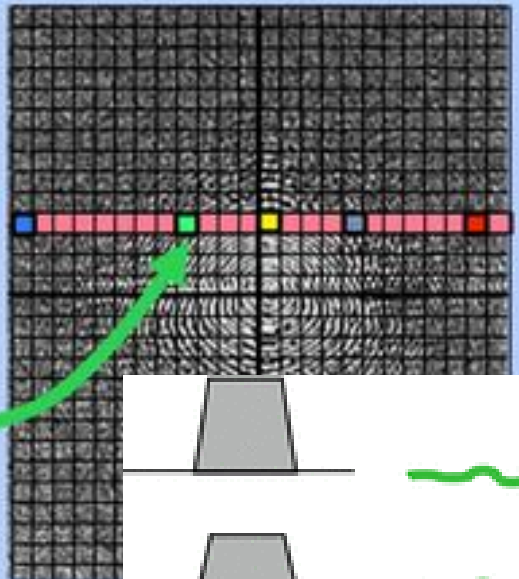

PULSE SEQUENCE

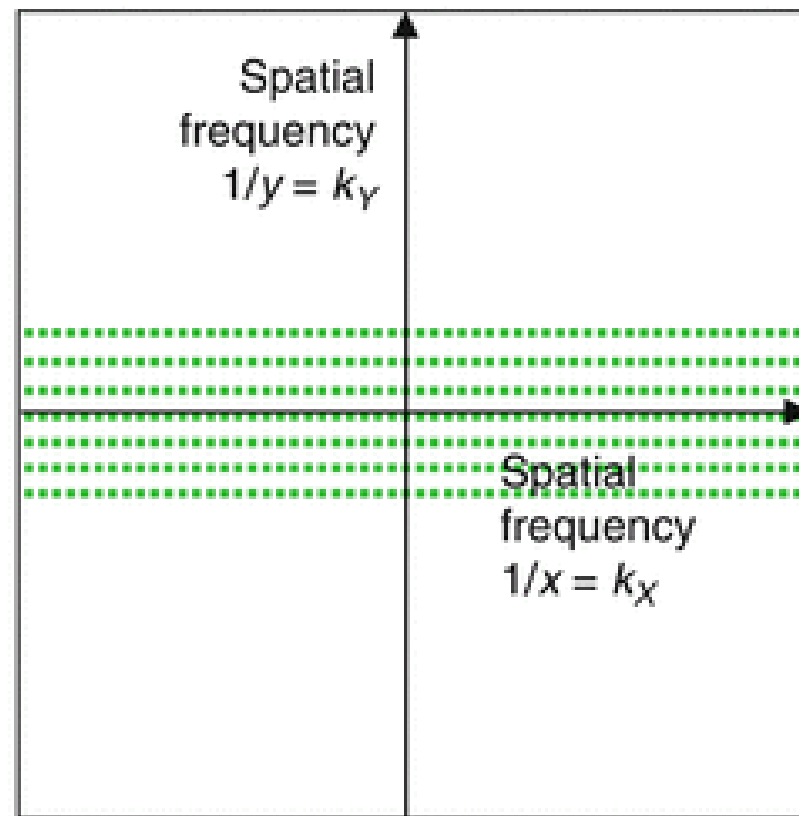
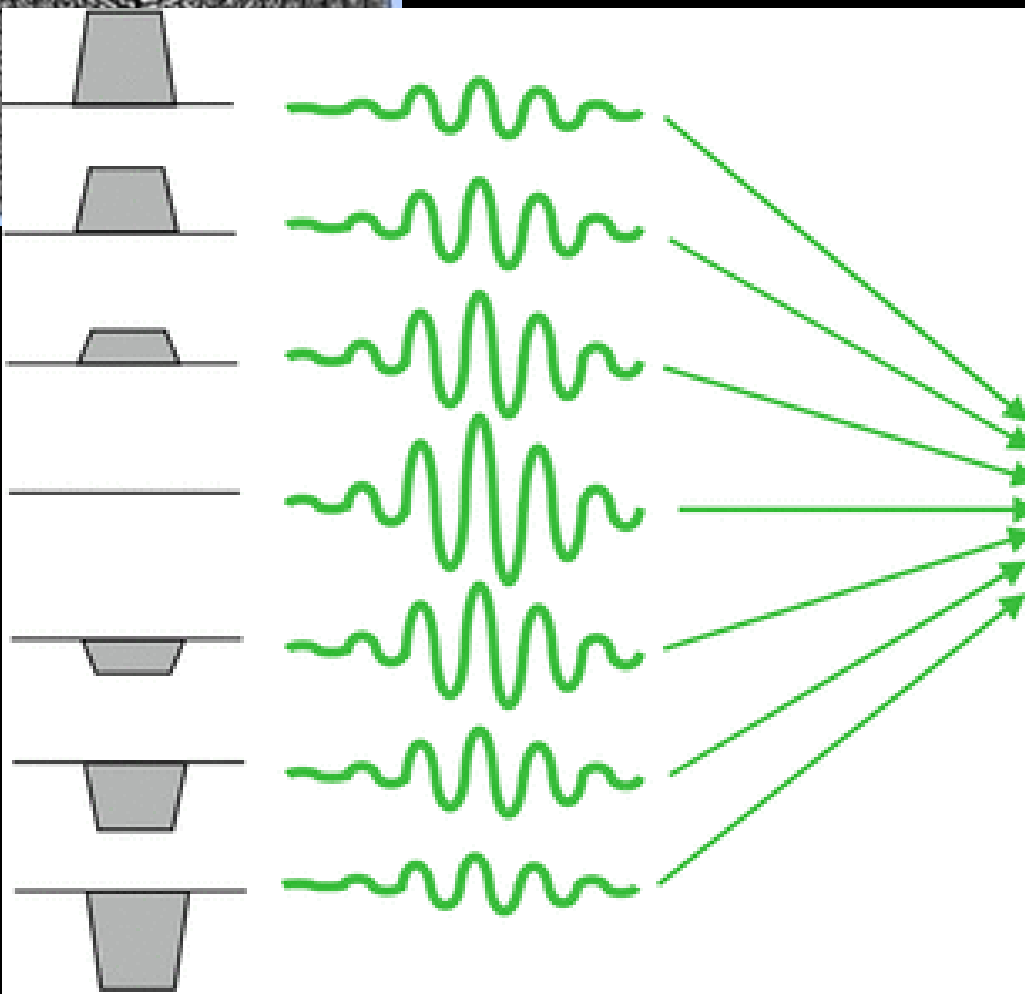

k-space filled line by line
'Cartesian' data acquisition

SPATIAL RESOLUTION

- FOV (x*y)
- Number of frequencies in k-space
- Number of phases in k-space

-

$$Roz_x = \frac{FOV_x}{\#frek} ; Roz_y = \frac{FOV_y}{\#fází}$$

$$Roz_x = \frac{240}{256} = 0,93 \text{ mm} ; Roz_y = \frac{240}{192} = 1,25 \text{ mm}$$

$$Roz_x = \frac{480}{324} = 1,48 ; Roz_y = \frac{280}{160} = 1,75 \text{ mm}$$

SNR

- Voxel size
-

SNR ~ *V*

$$SNR (0,93 ; 1,25; 4) \sim 0,93 * 1,25 * 4 = 4,65$$

$$SNR (0,93 ; 1,25; 3) \sim 0,93 * 1,25 * 3 = 3,48$$

$$SNR (0,8 ; 1; 4) \sim 0,8 * 1 * 4 = 3,20$$

SIGNAL AVERAGING

NEX 1

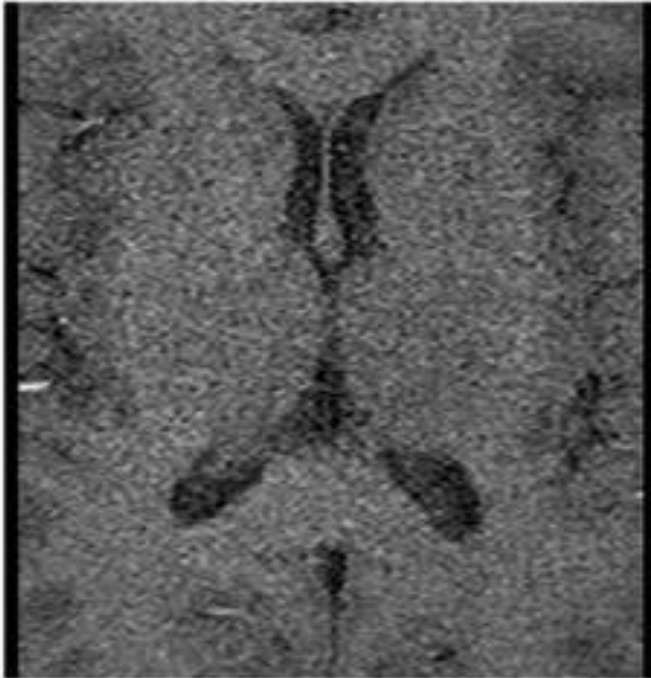

NEX 4

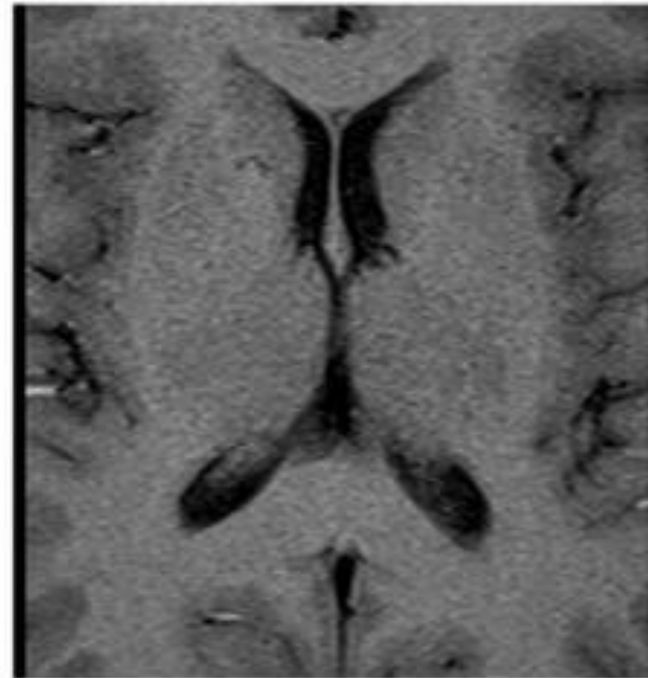

$$SNR \sim \sqrt{NEX} ; t \sim NEX$$

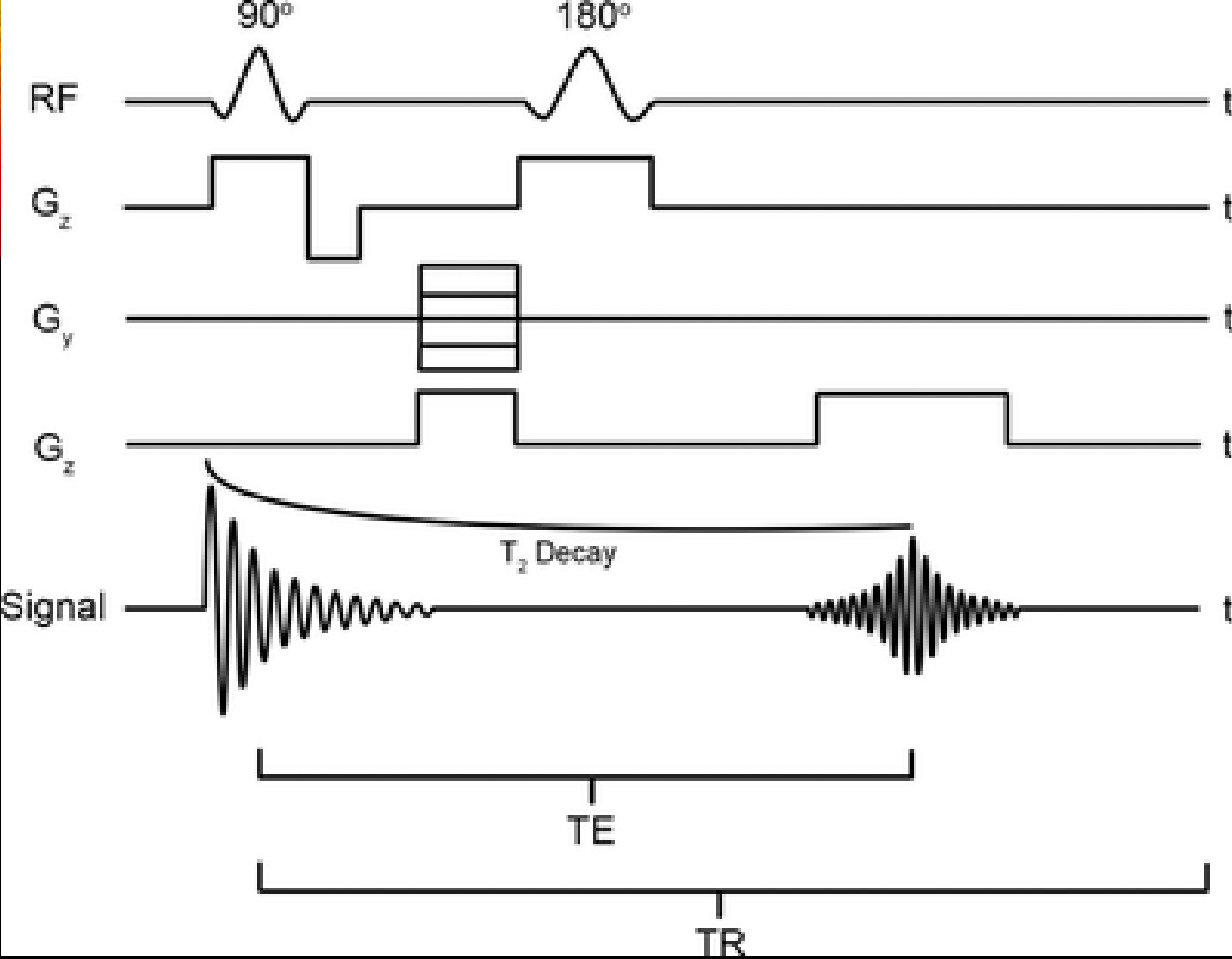

SPIN ECHO (SE)

$$S \sim PD \left(1 - e^{-\frac{TR}{T_1}} \right) e^{-\frac{TE}{T_2}}$$

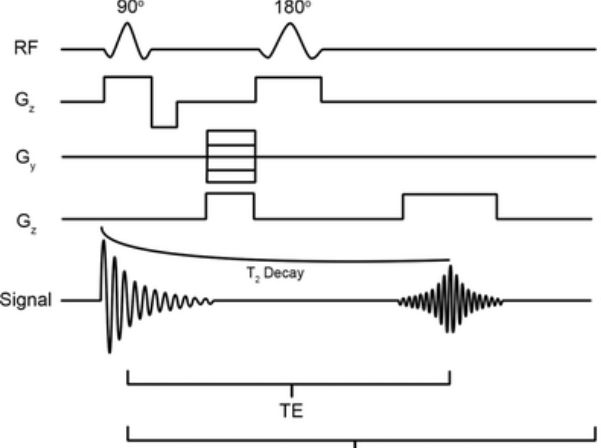

$$S \sim PD \left(1 - e^{-\frac{TR}{T_1}} \right) e^{-\frac{TE}{T_2}}$$

SPIN ECHO

Spin-spinová interakce (T2)

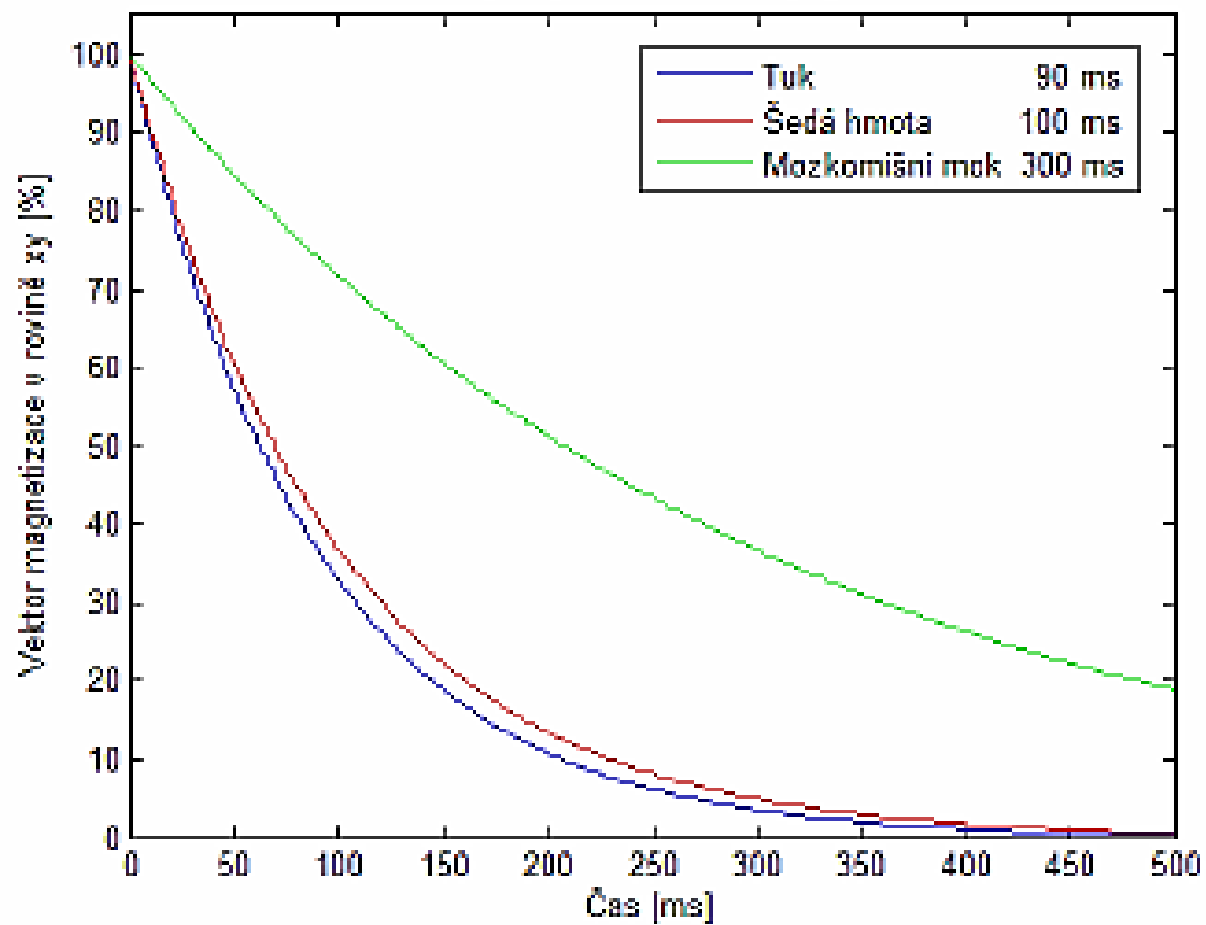

Spin-mřížková interakce (T1)

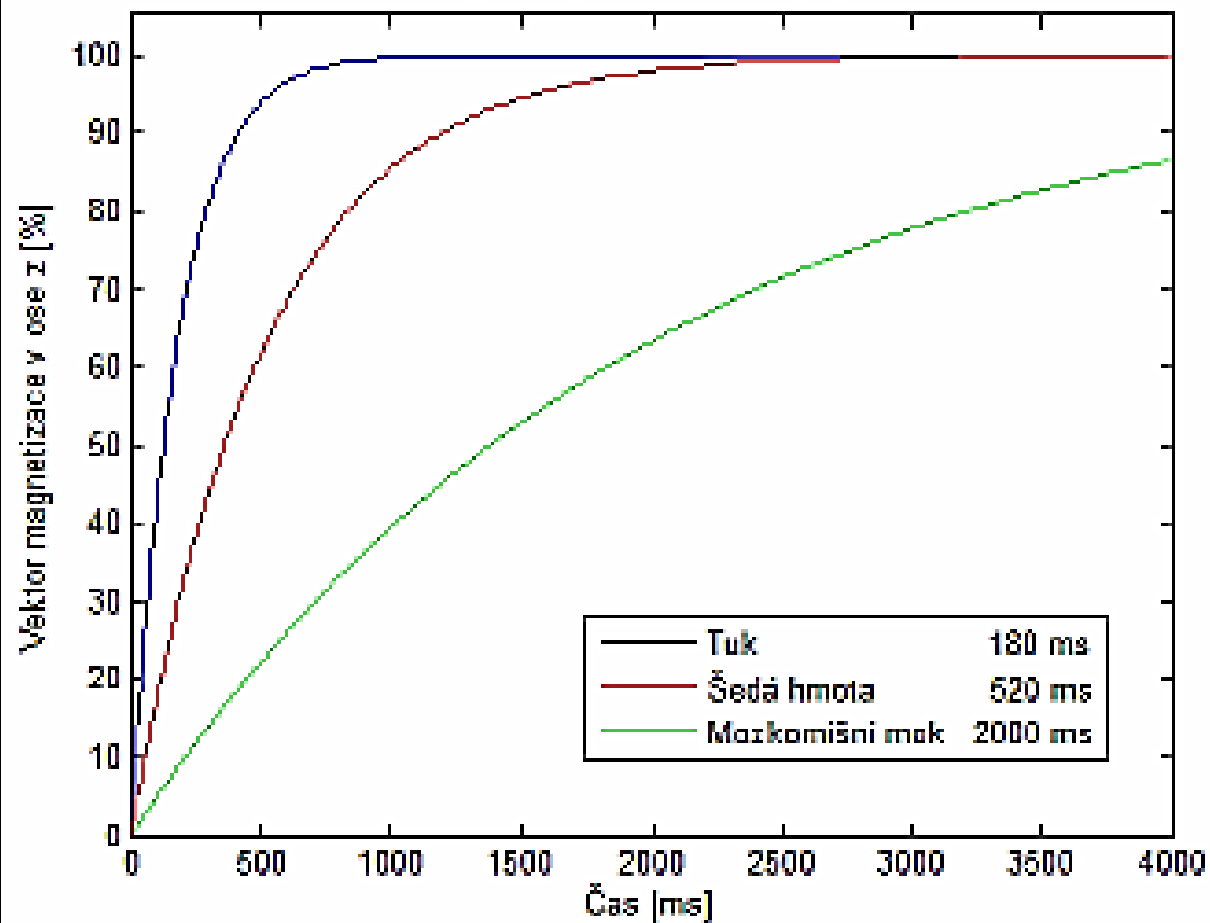

$$S \sim PD \left(1 - e^{-\frac{TR}{T_1}} \right) e^{-\frac{TE}{T_2}}$$

SPIN ECHO T1-W

	CSF	GM	Tuk	
TE	8	8	8	
TR	600	600	600	
T1	2000	520	180	
T2	300	100	90	
EXP(-TR/T1)	0,7408	0,315	0,0357	
EXP(-TE/T2)	0,9737	0,923	0,9149	
1-EXP(-TR/T1)	0,2592	0,685	0,9643	
Součin	0,2524	0,632	0,8823	

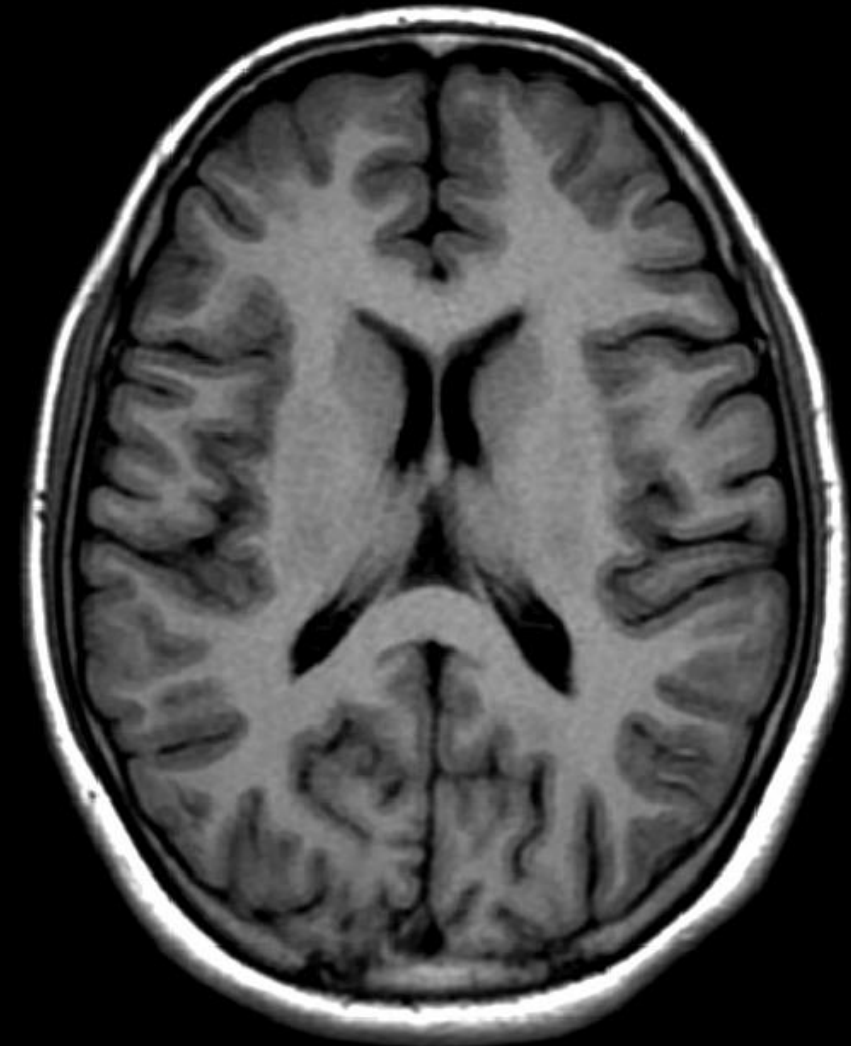

$$S \sim PD \left(1 - e^{-\frac{TR}{T_1}} \right) e^{-\frac{TE}{T_2}}$$

SPIN ECHO T2-W

	CSF	GM	Tuk
TE	120	120	120
TR	6000	6000	6000
T1	2000	520	180
T2	300	100	90
EXP(-TR/T1)	0,0498	1E-05	3E-15
EXP(-TE/T2)	0,6703	0,301	0,2636
1-EXP(-TR/T1)	0,9502	1	1
Součin	0,6369	0,301	0,2636

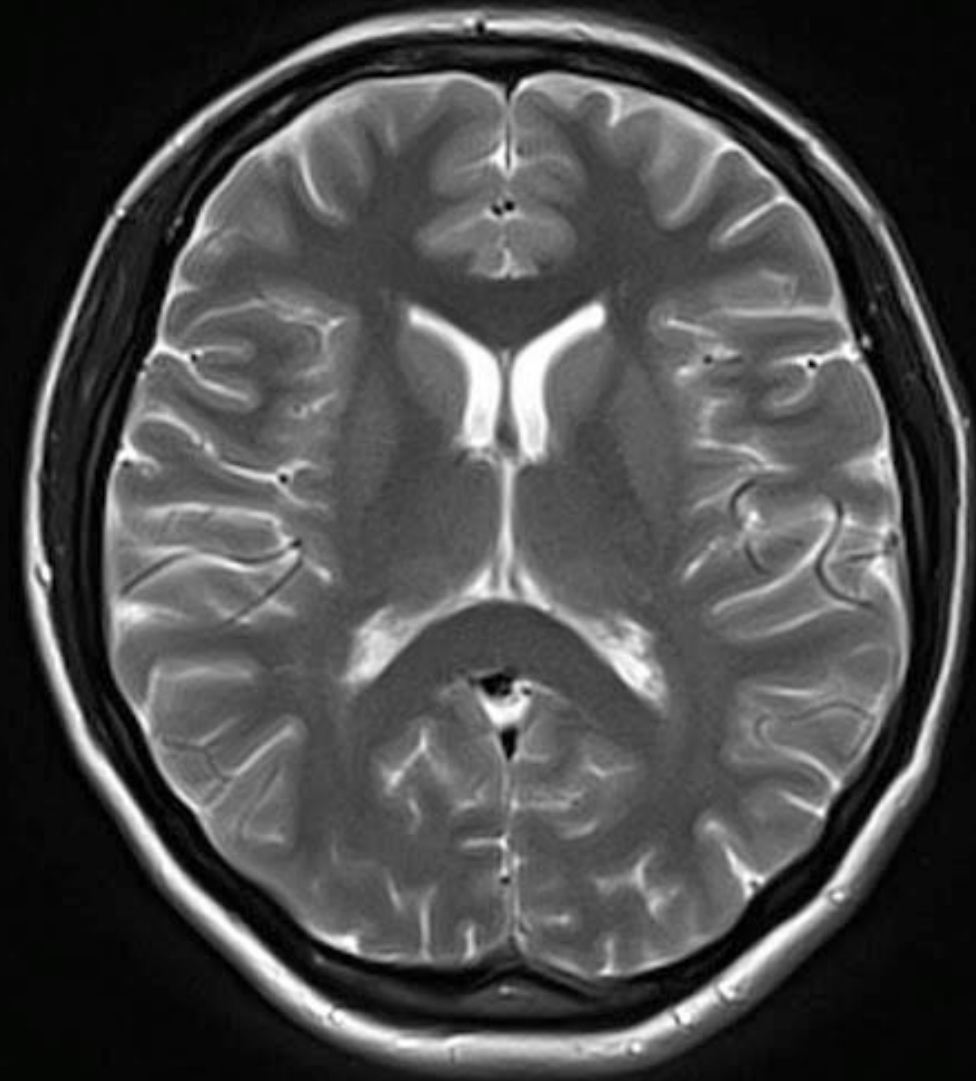

$$S \sim PD \left(1 - e^{-\frac{TR}{T_1}} \right) e^{-\frac{TE}{T_2}}$$

SPIN ECHO PD

	CSF	GM	Tuk
TE	8	8	8
TR	6000	6000	6000
T1	2000	520	180
T2	300	100	90
EXP(-TR/T1)	0,0498	1E-05	3E-15
EXP(-TE/T2)	0,9737	0,923	0,9149
1-EXP(-TR/T1)	0,9502	1	1
Součin	0,9252	0,923	0,9149

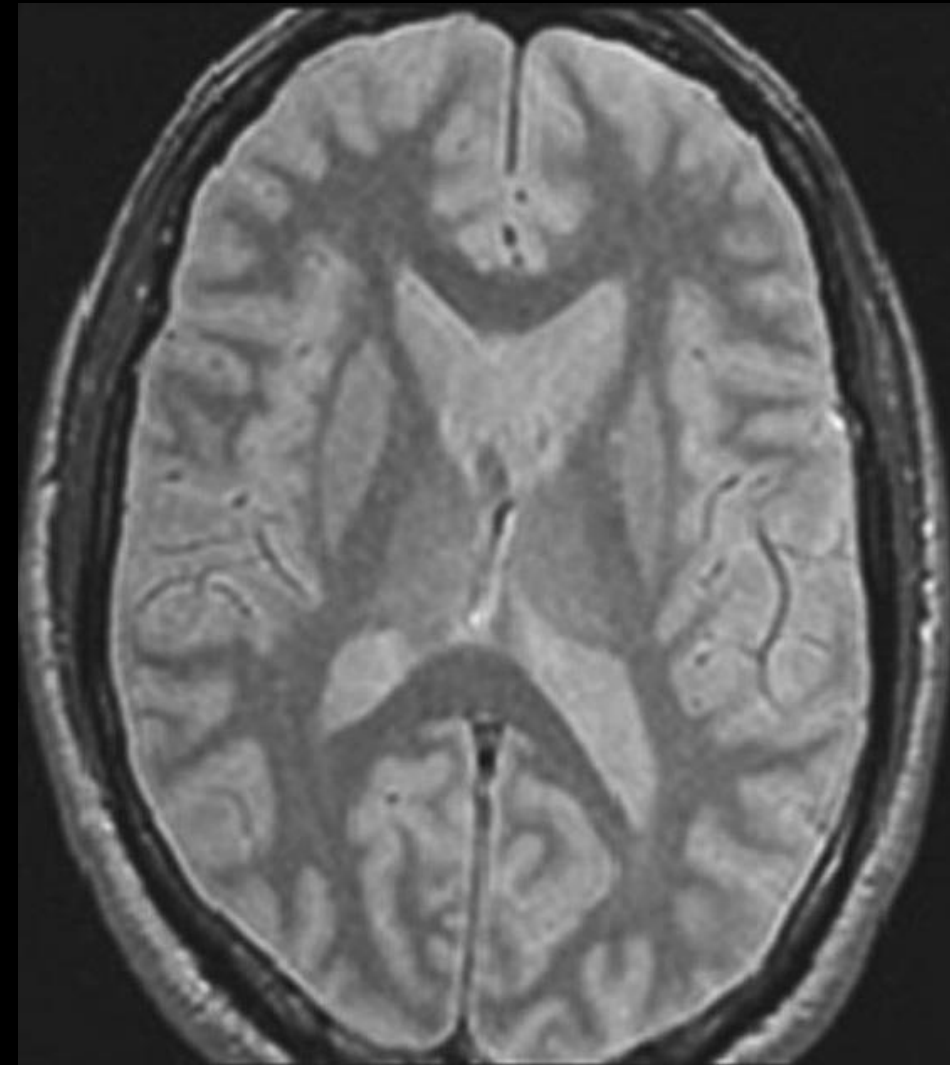

$$S \sim PD \left(1 - e^{-\frac{TR}{T_1}} \right) e^{-\frac{TE}{T_2}}$$

SPIN ECHO

	CSF	GM	Tuk
TE	120	120	120
TR	600	600	600
T1	2000	520	180
T2	300	100	90
EXP(-TR/T1)	0,7408	0,315	0,0357
EXP(-TE/T2)	0,6703	0,301	0,2636
1-EXP(-TR/T1)	0,2592	0,685	0,9643
Součin	0,1737	0,206	0,2542

SPIN ECHO ACQUISITION SPEED

- T_r
- Number of averagings
- Number of rows of k-space
-

$$t = TR * \#phase * NEX$$

$$t(600ms, 256, 1) = 0,6 * 256 * 1 = 153,6s$$

$$t(4000, 256, 1) = 4 * 256 * 1 = 1024 s$$

$$t(500, 512, 4) = 0,5 * 512 * 4 = 1024 s$$

TURBO SPIN ECHO ACQUISITION SPEED

- TR, TF
- Number of averagings
- Number of rows of k-space
- High SAR
-

$$t = TR * \#phase * NEX / TF$$

$$t(600ms, 256, 1, 4) = 0,6 * 256 * 1/4 = 38s$$

$$t(4000, 256, 1, 18) = 4 * 256 * 1 = 56,8 s$$

$$t(500, 512, 4, 4) = 0,5 * 512 * 4 = 256 s$$

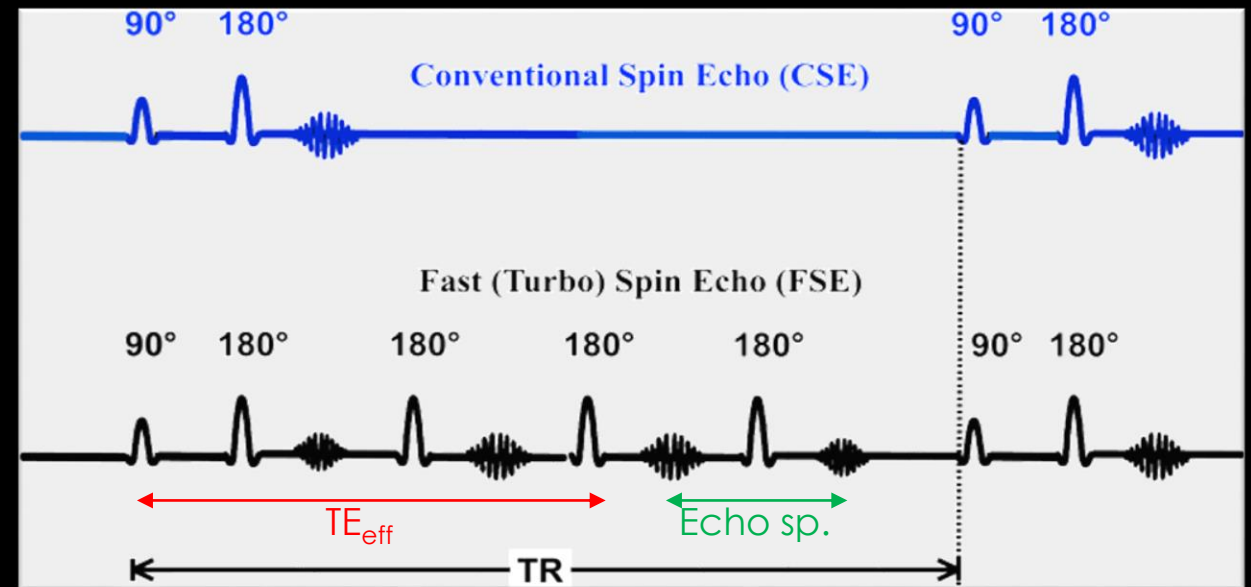

TURBO SPIN ECHO

FSE 4000/102

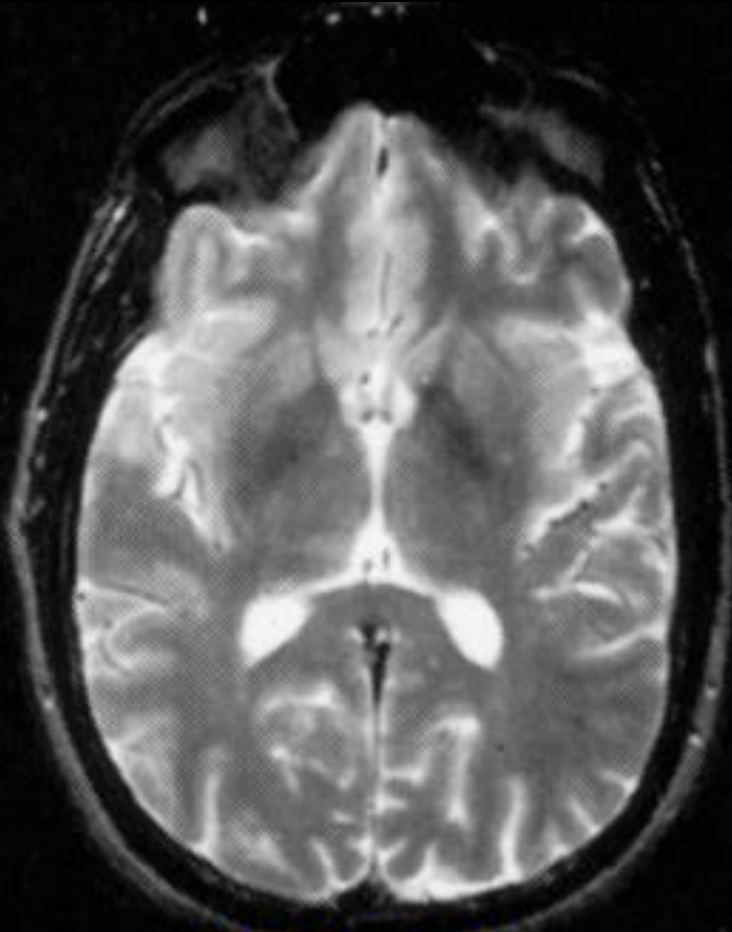

ETL = 4

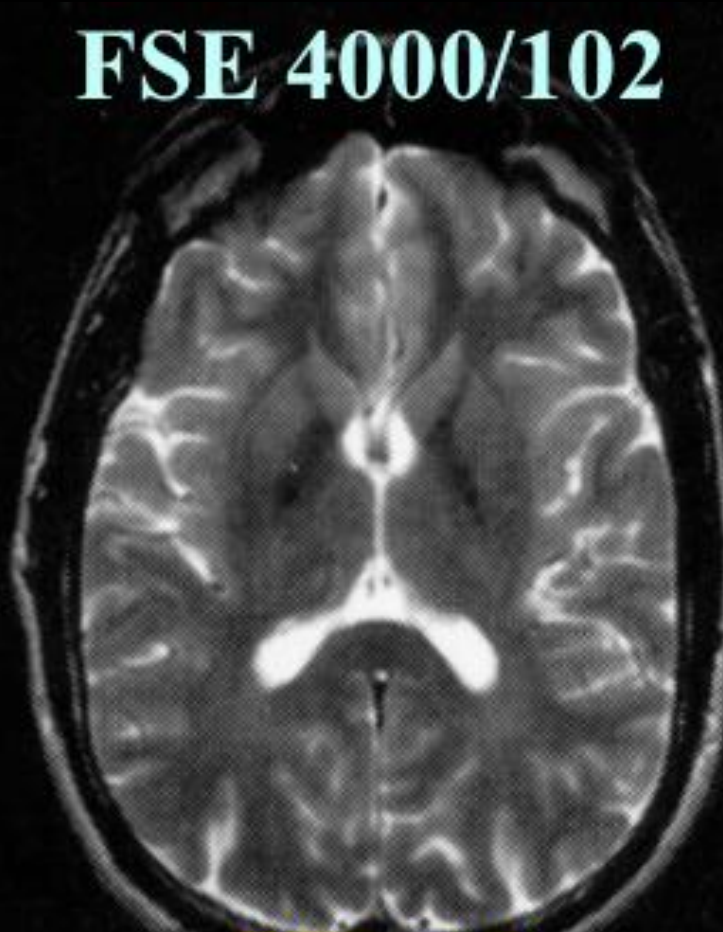

ETL = 8

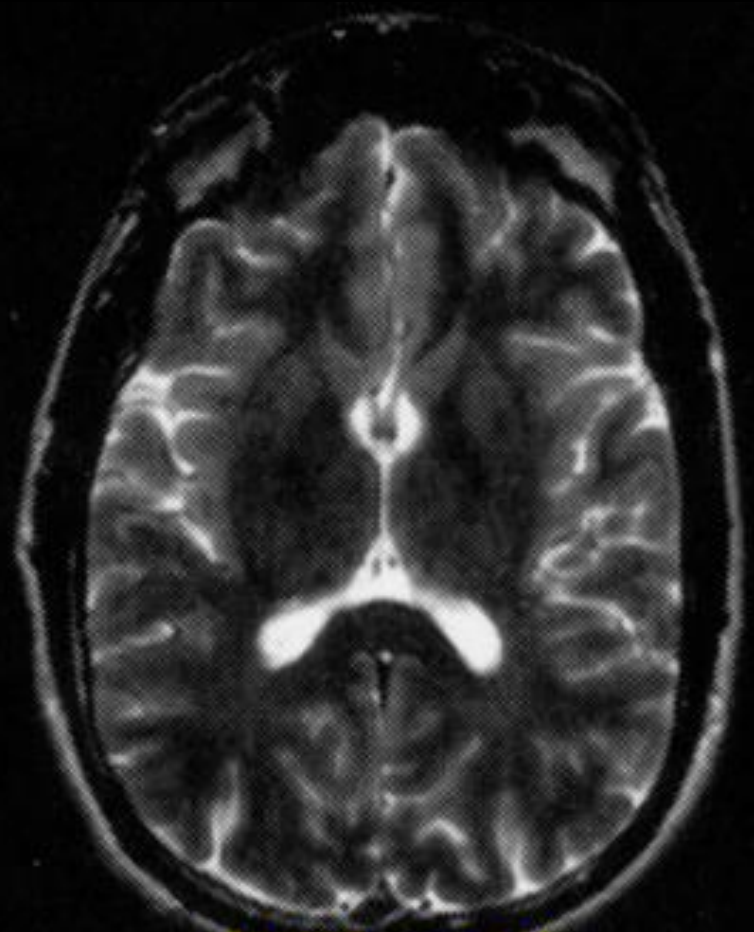

ETL = 16

SE VS TSE

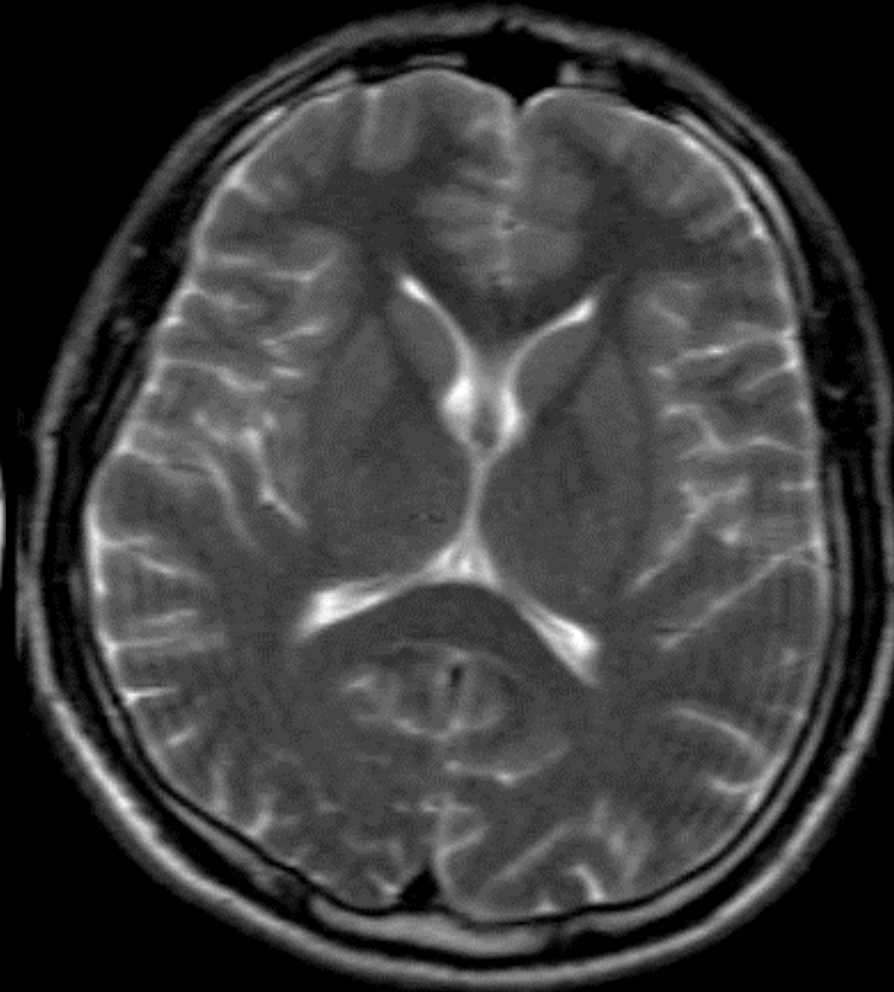
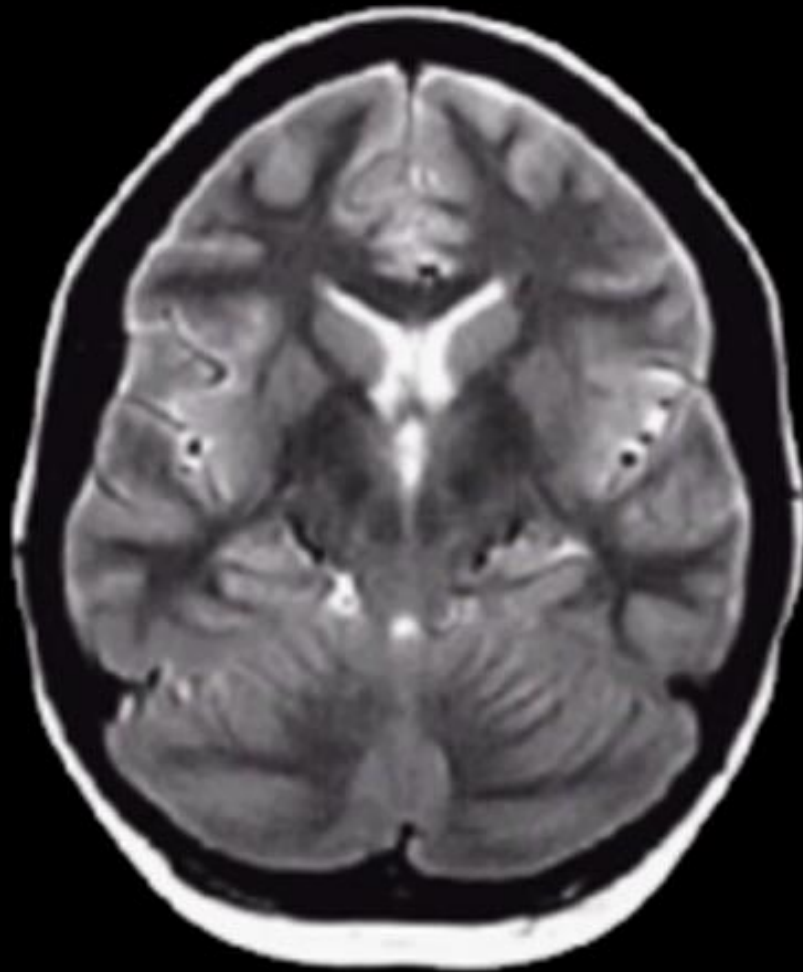
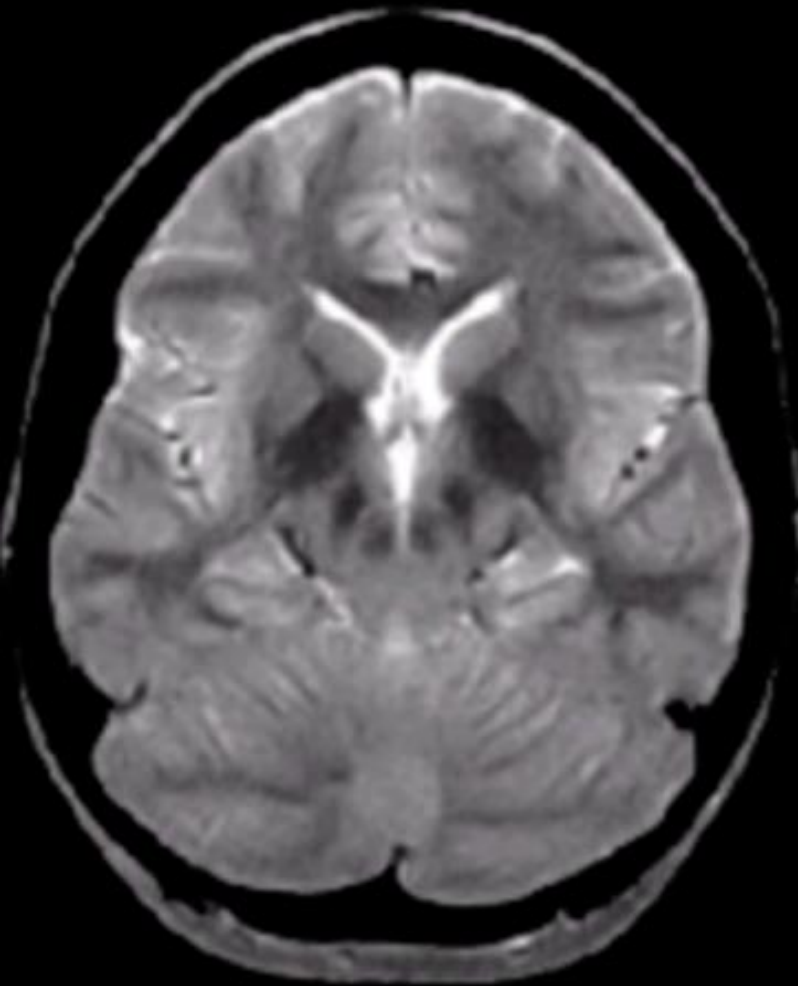

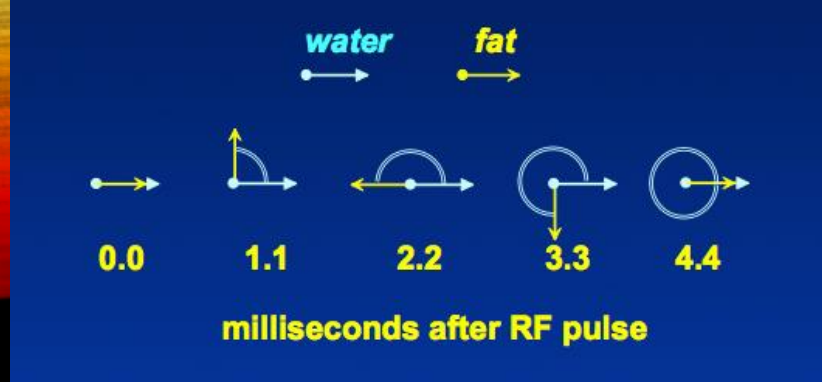

CH SHIFT, J-COUPLING

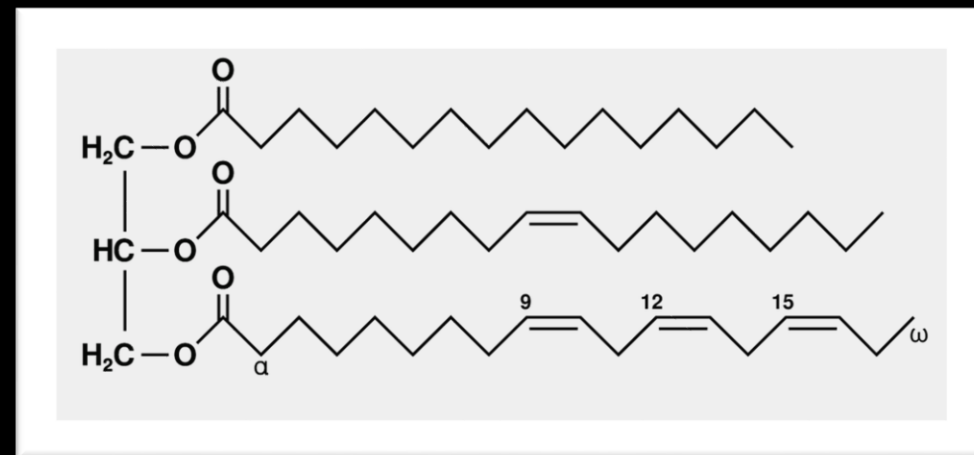
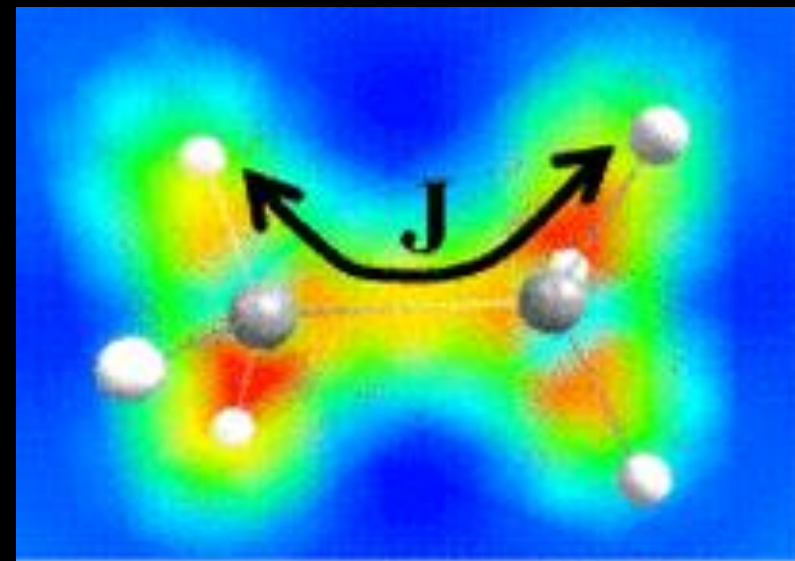
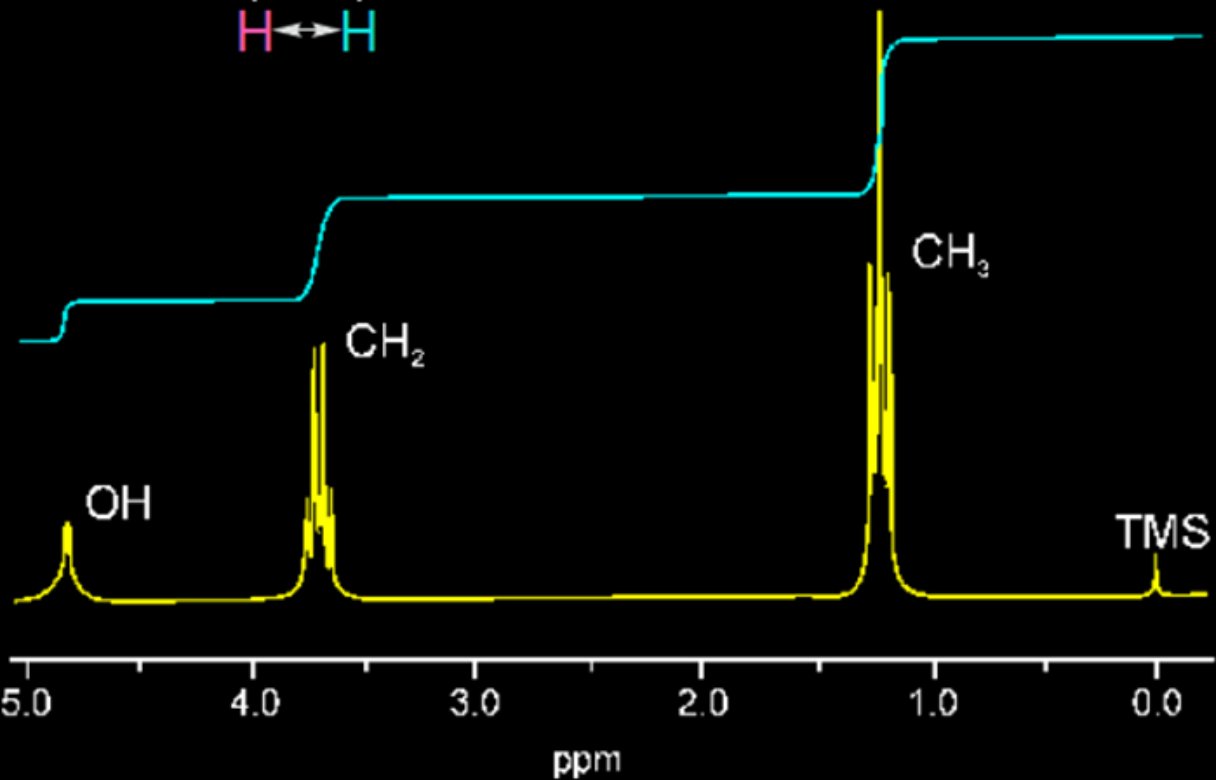
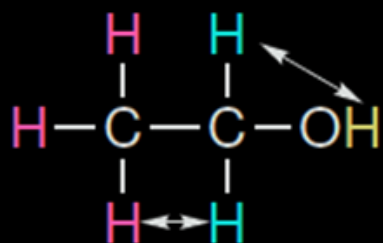

SE VS TSE - SUSCEPTIBILITY

TSE (ETL=15)

TSE (ETL=5)

SE

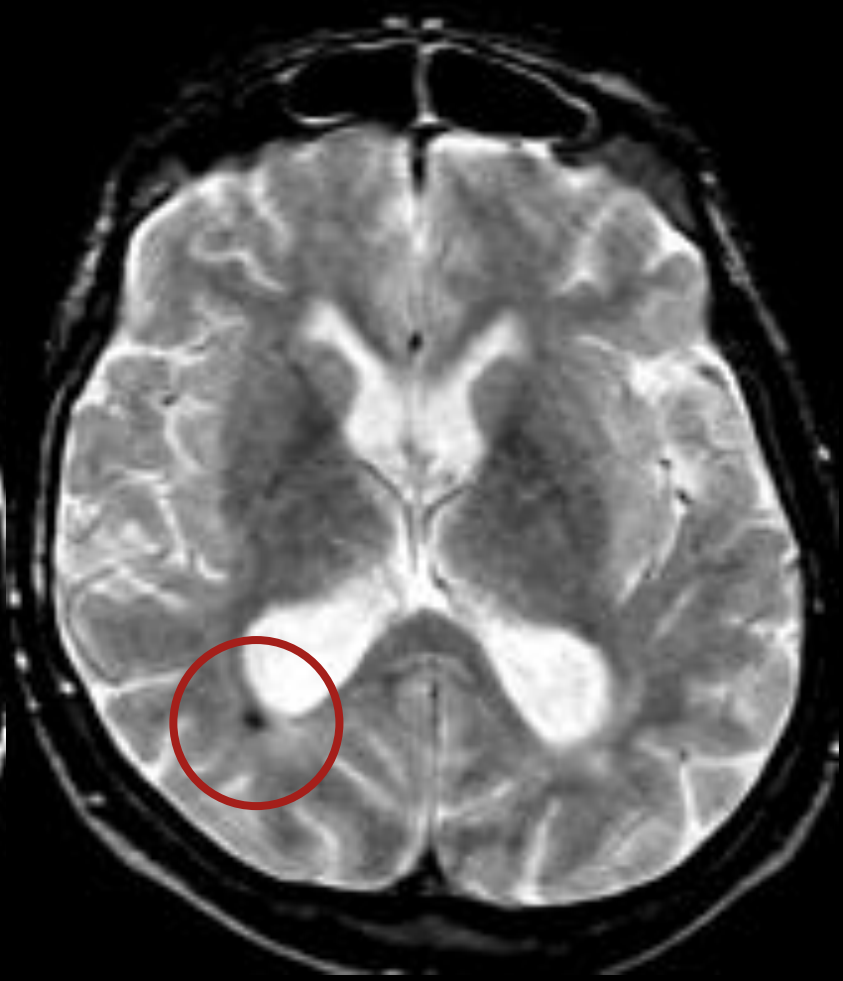
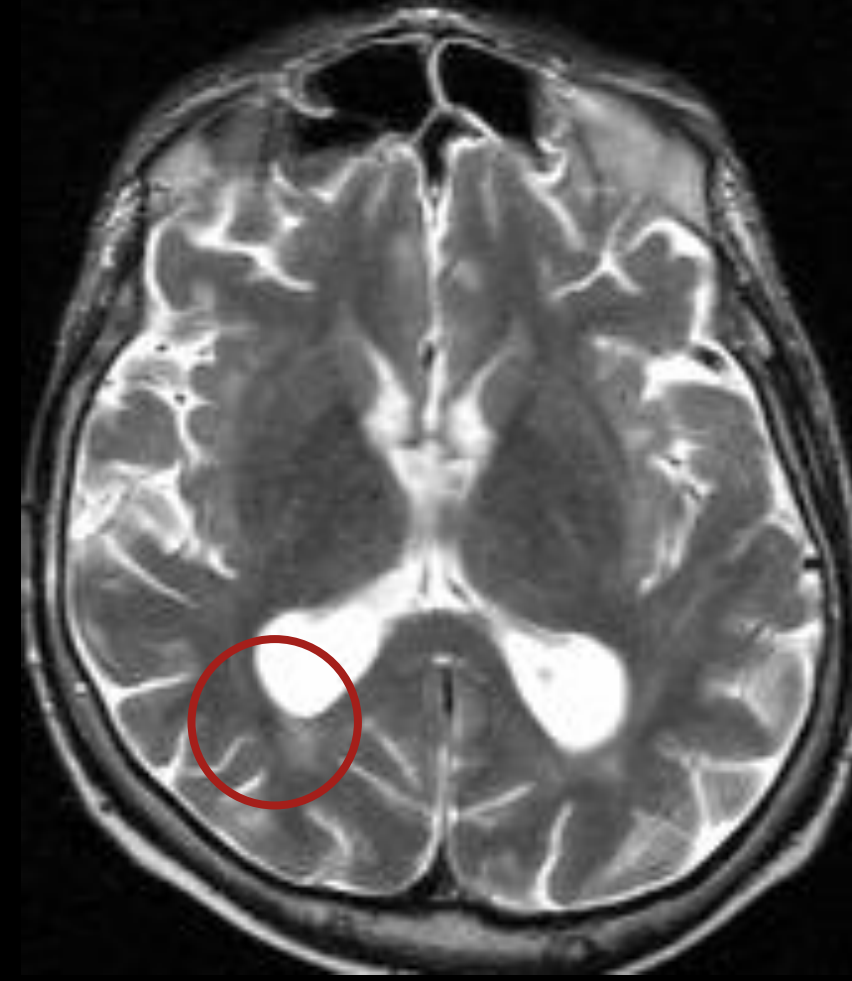

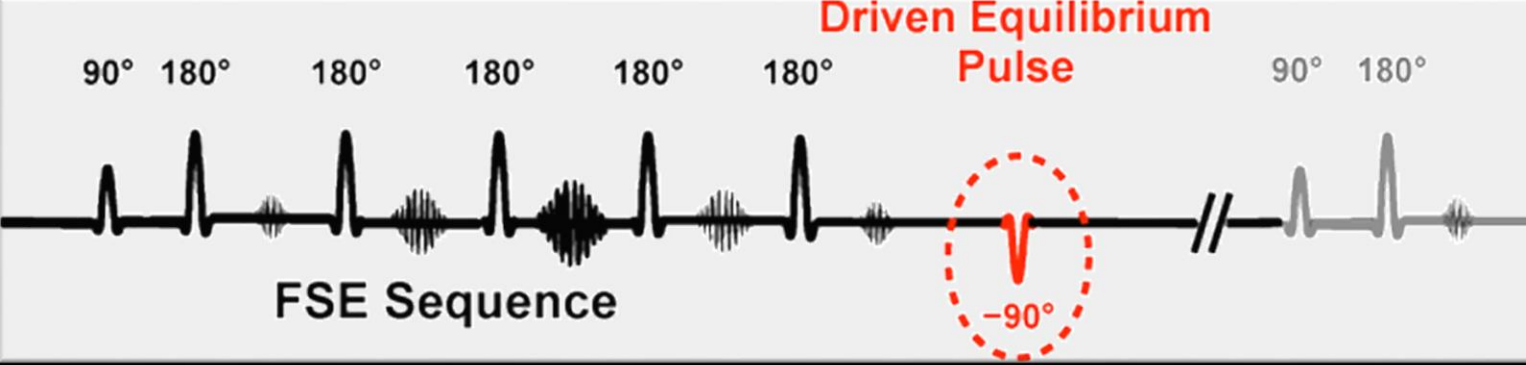

TSE DRIVE/FRFSE

- Additional -90° pulse
- Acceleration of return M
- shorter TR
-

ETL=15

TR = 4000
1:21 min

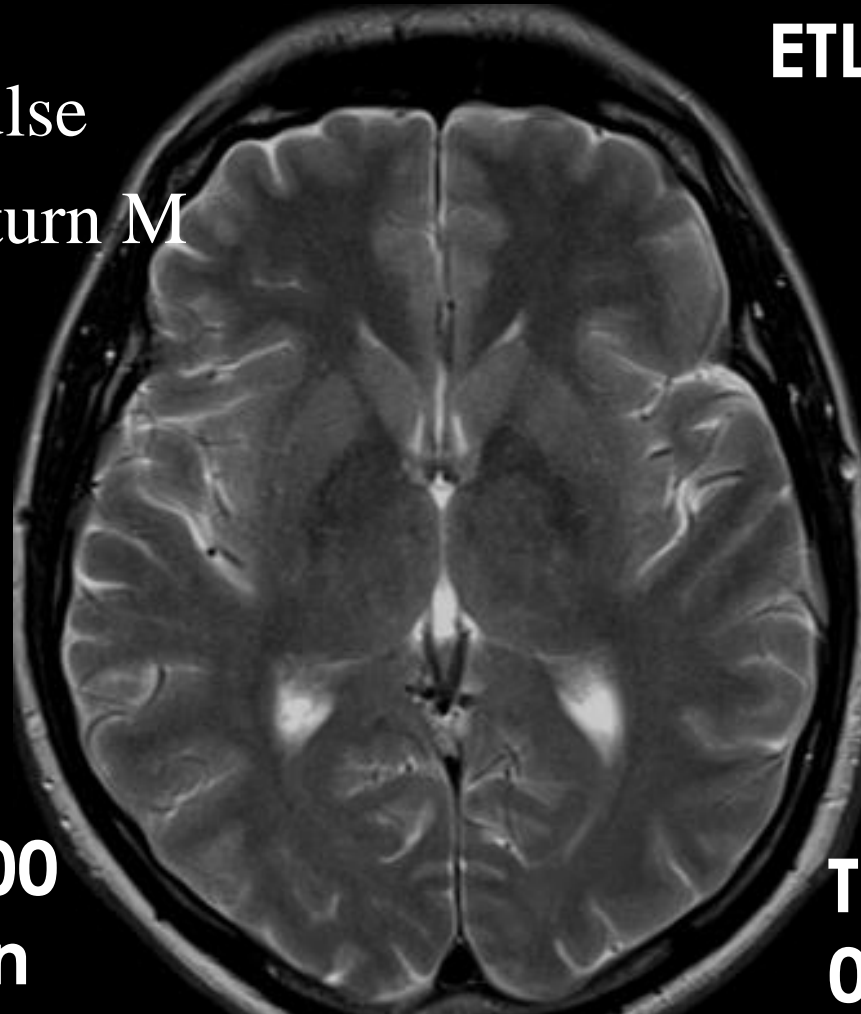

TR = 2300
0:42 min

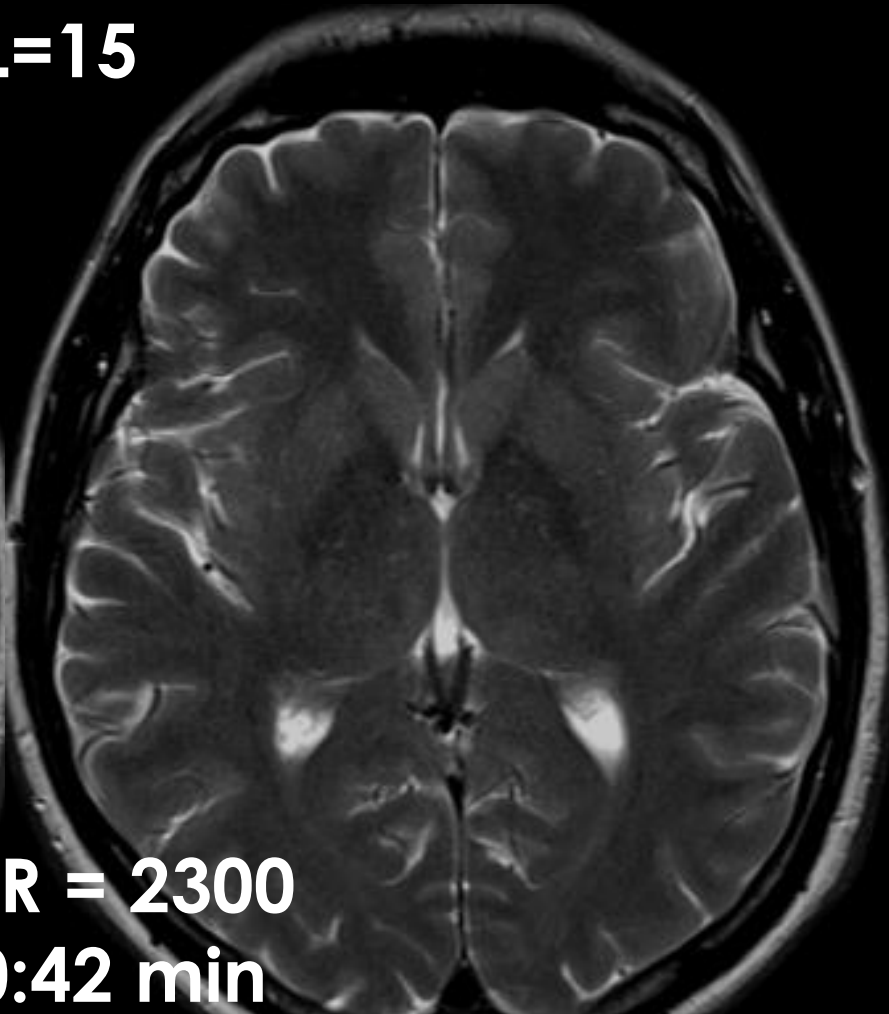

TSE MULTIVANE/PROPELER

- Radial scoop of k-space
- Center resampled
- Margins undersampled
- Less sensitive movement
- Increased blur
- Creation of artifacts
- Longer acquisitions

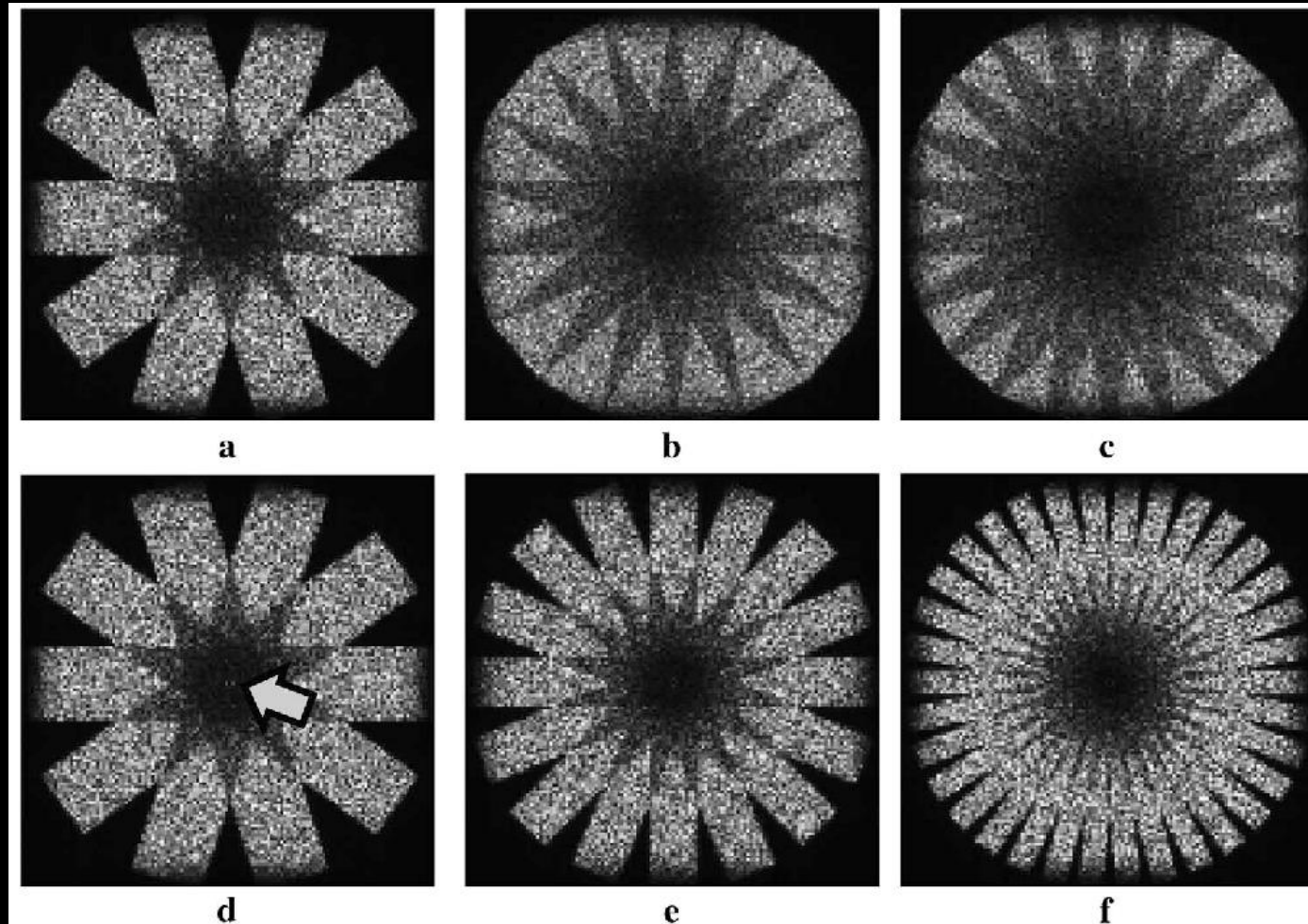

TSE MULTIVANE/PROPELER

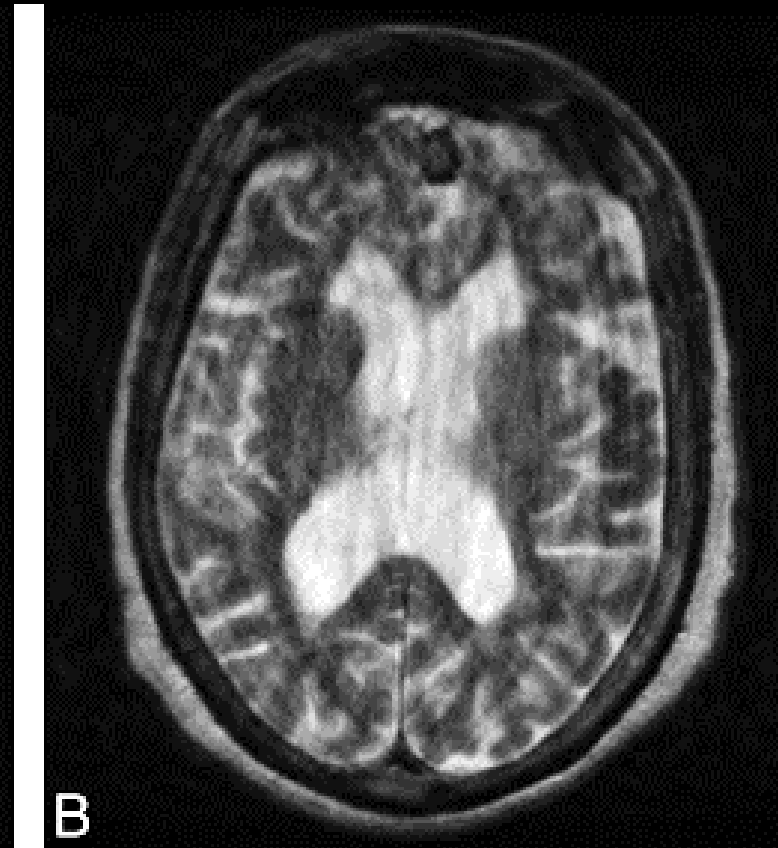
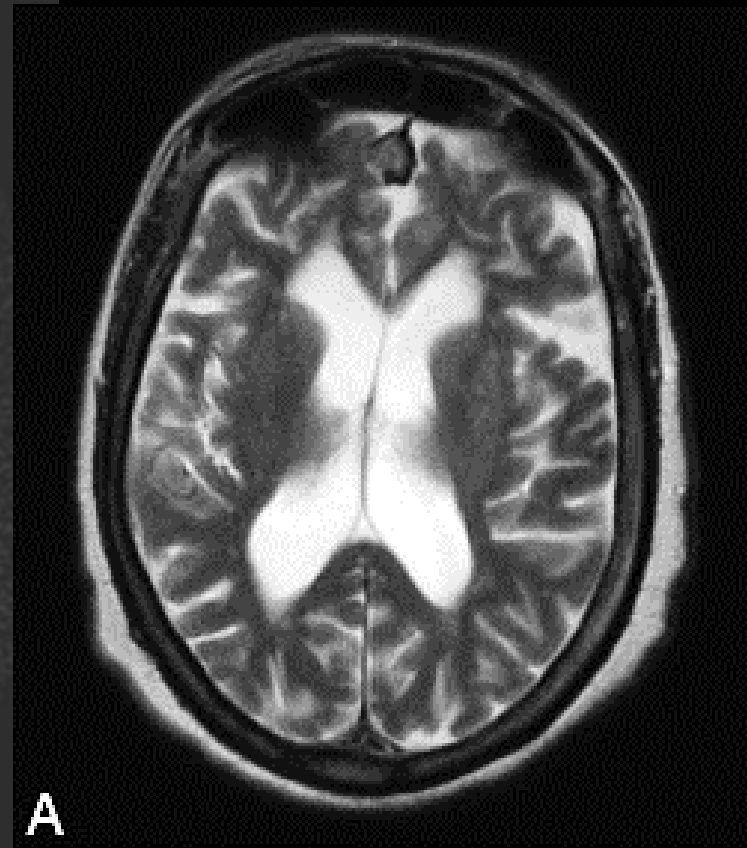
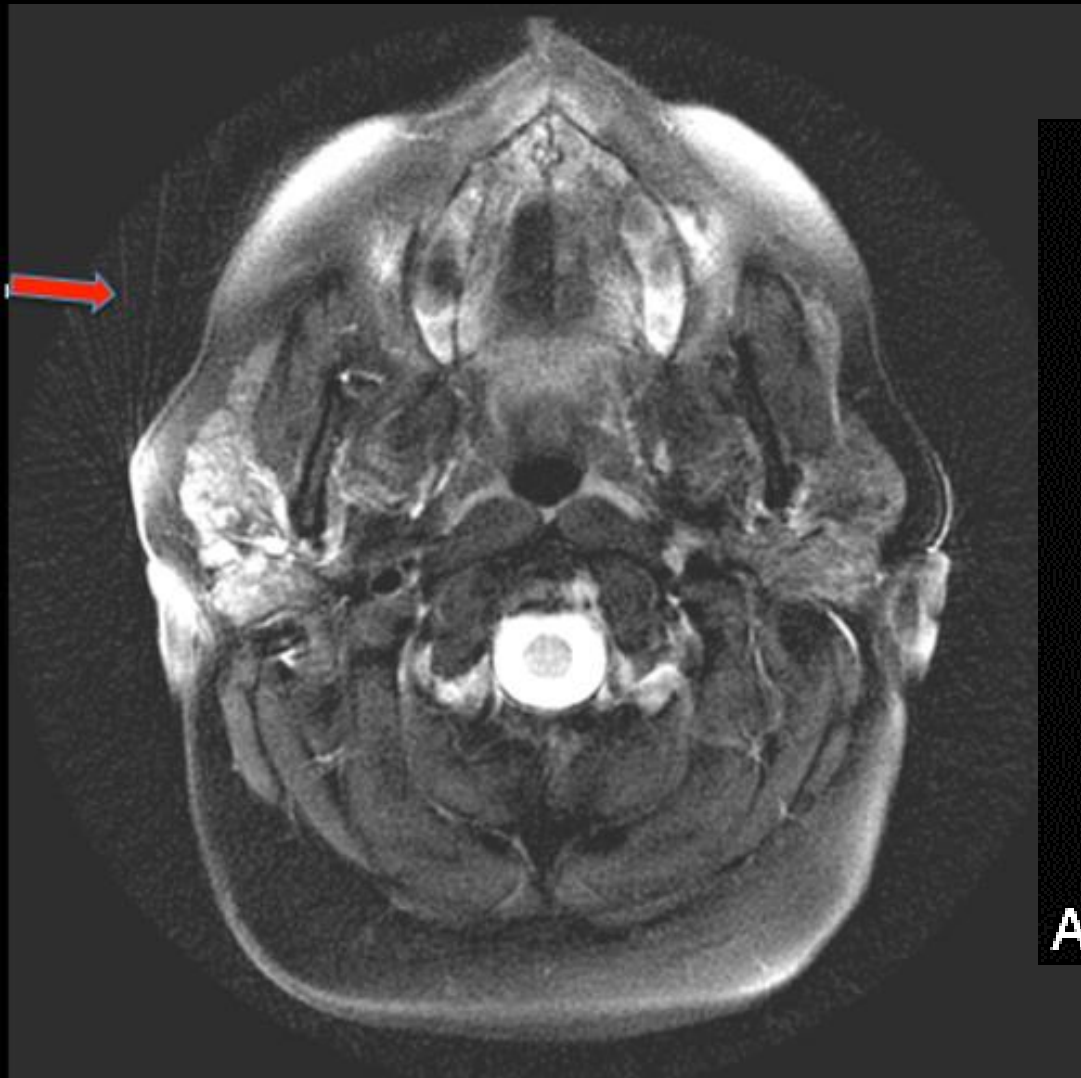

SINGLE SHOT TSE

- High ETL, partial k-space scoop
- High SAR
- Decrease in SNR
- Very fast pick-up (~ 1 s)

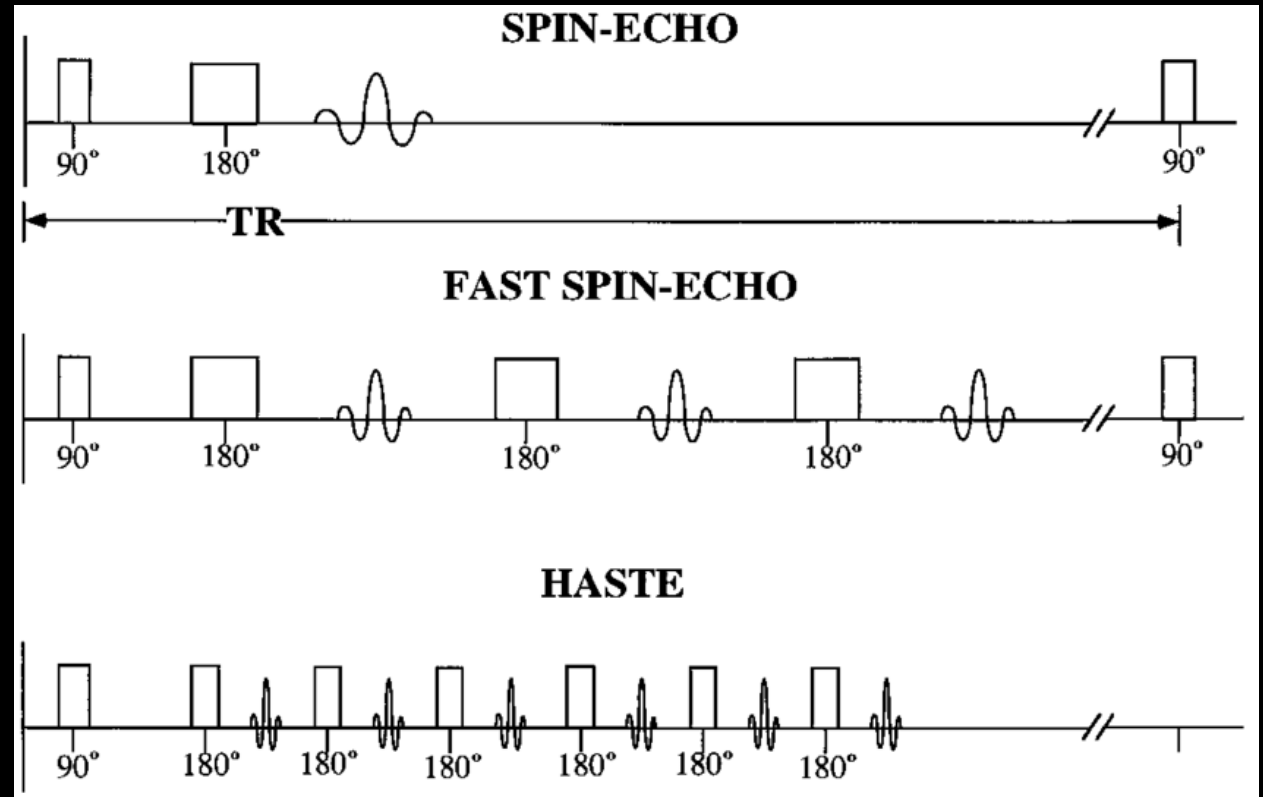
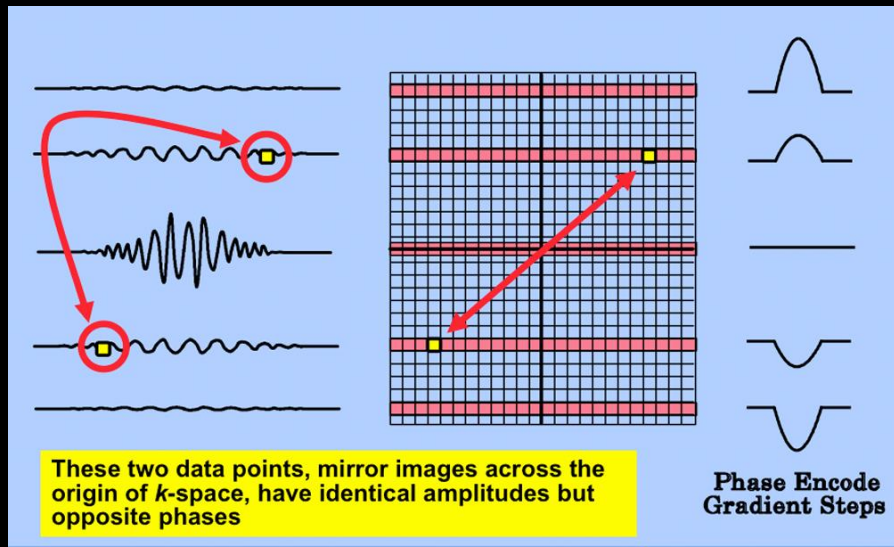

SINGLE SHOT TSE

- Reducing SAR > replacing 180° pulses

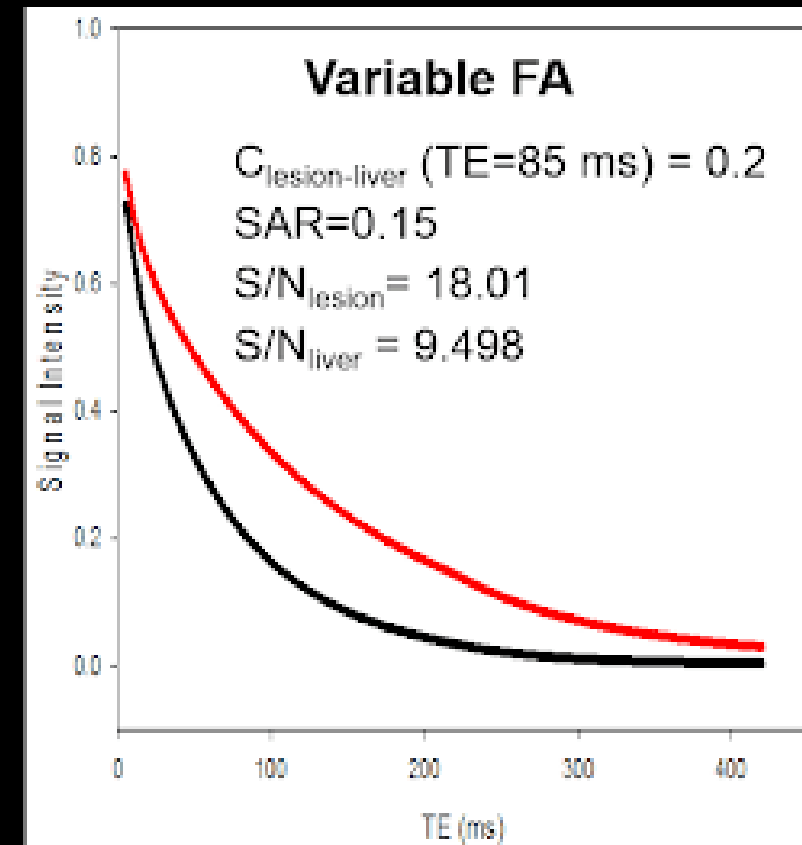
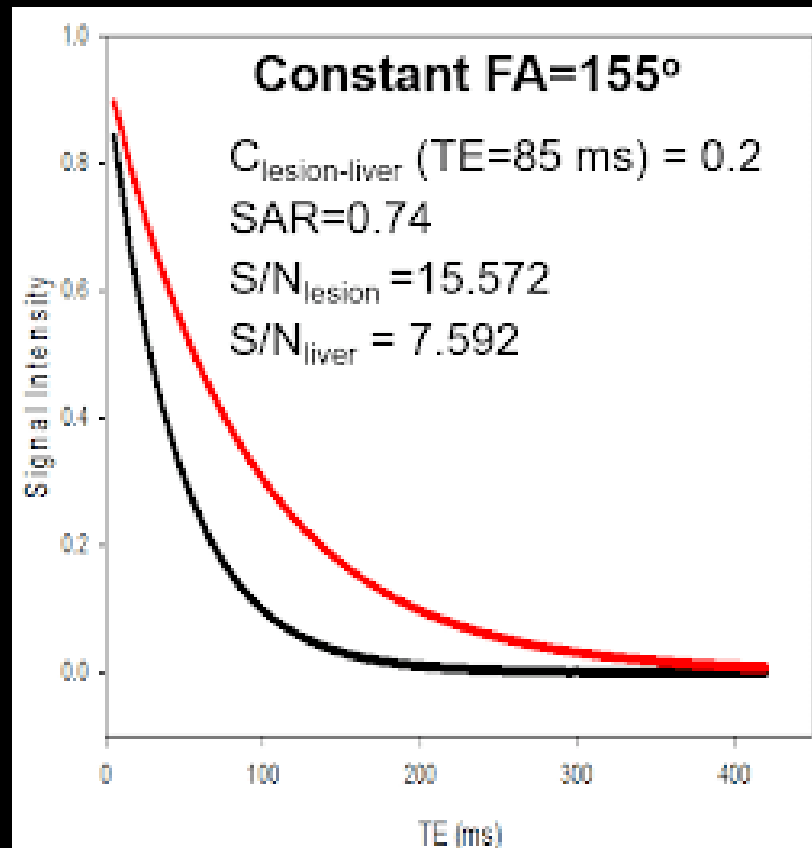

2D VS 3D

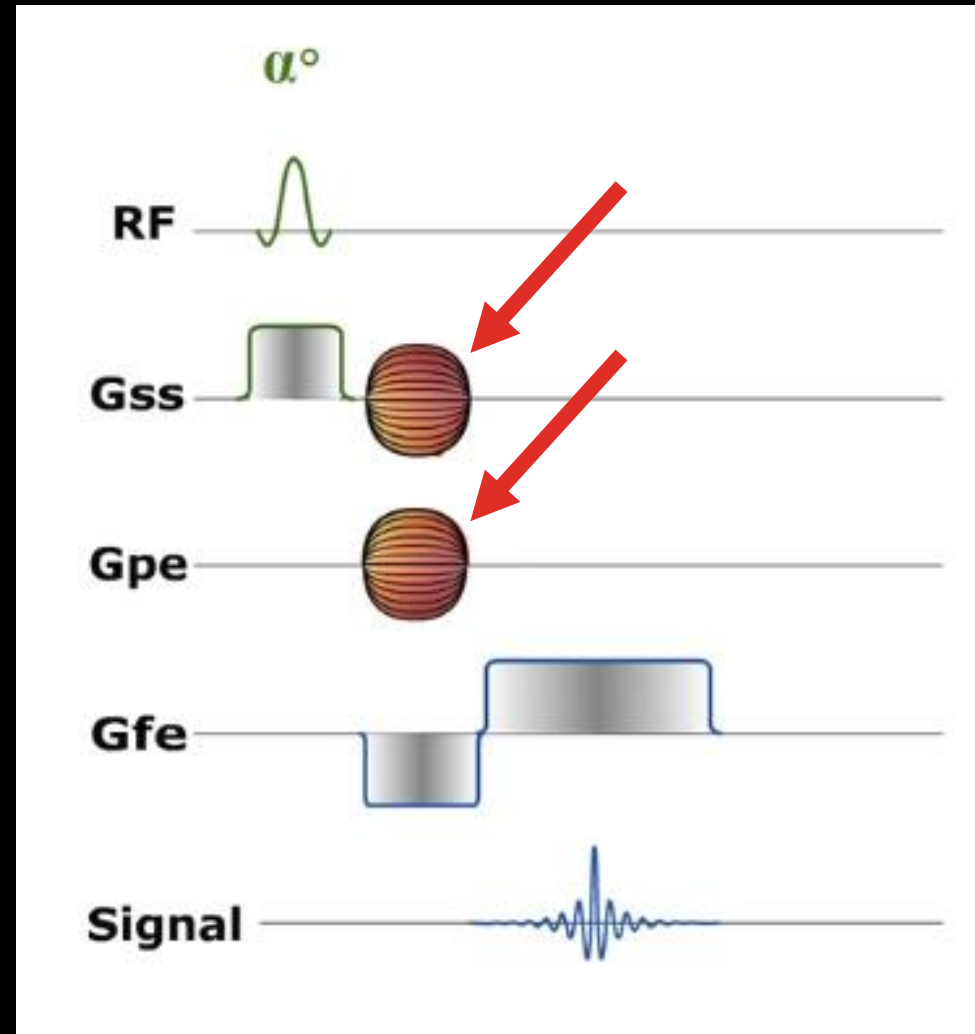
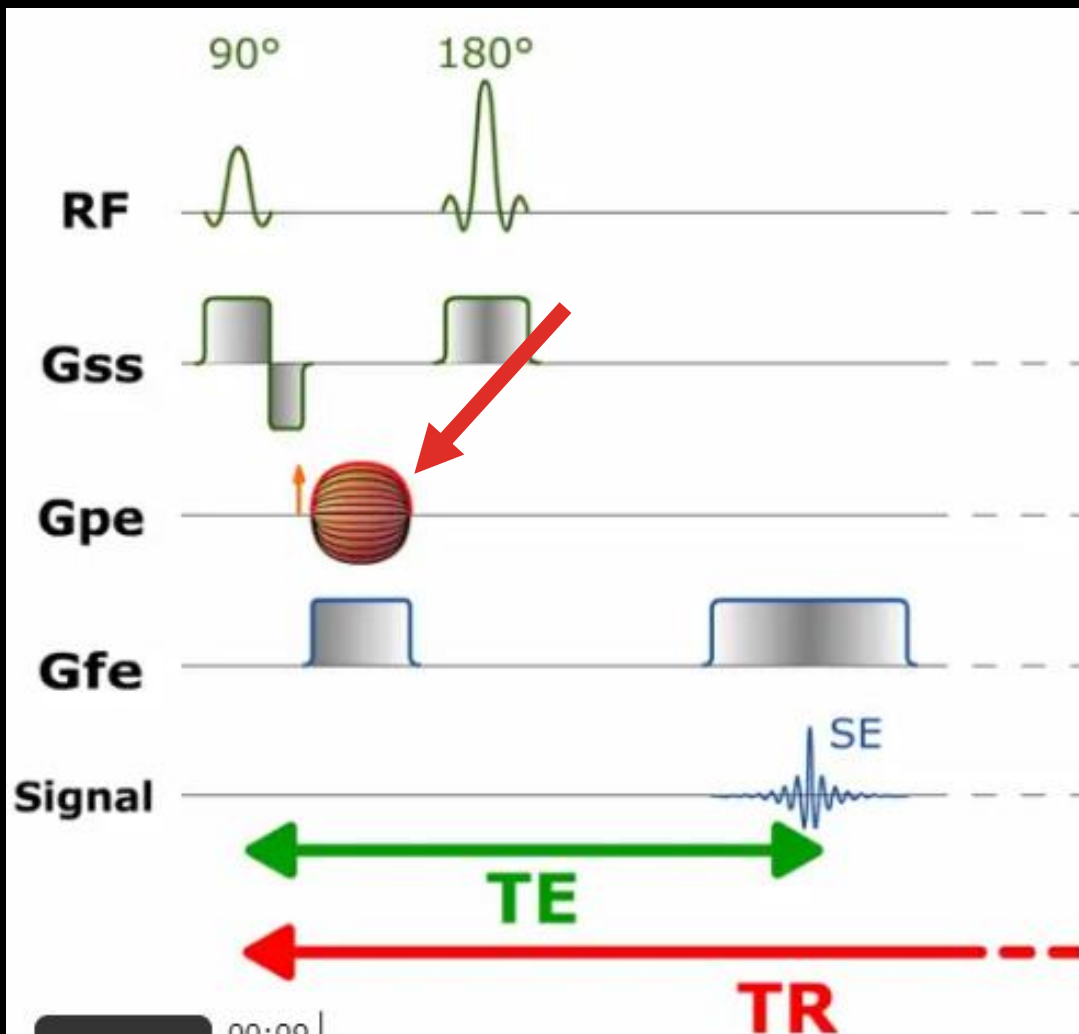

CUBE/VISTA

- 3D sequence
- Variable refoc. angle
- Lower SAR
- High ETL
- High resolution
- Less metal. Artifacts
- Long acquisition. time (>5min)

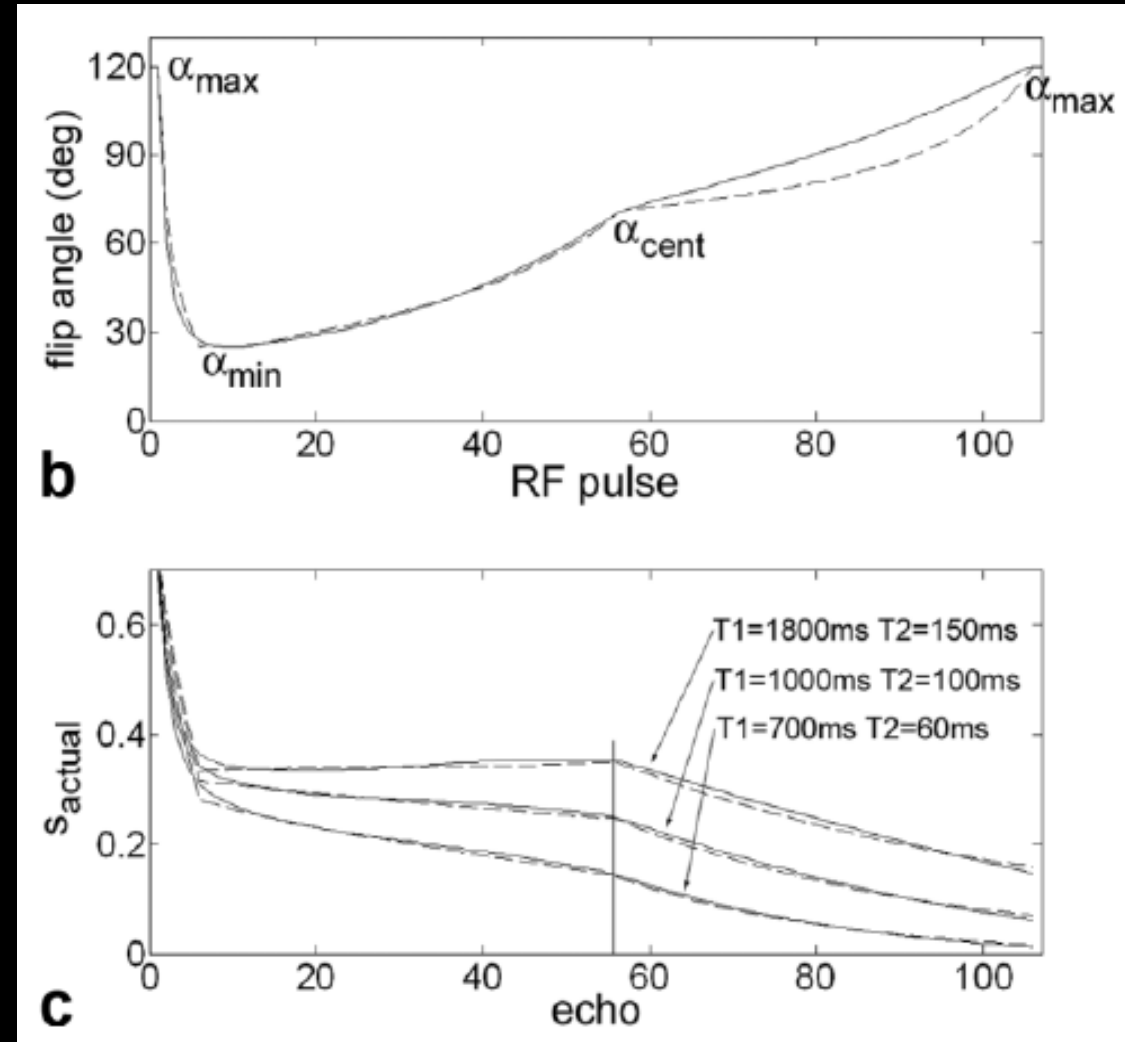

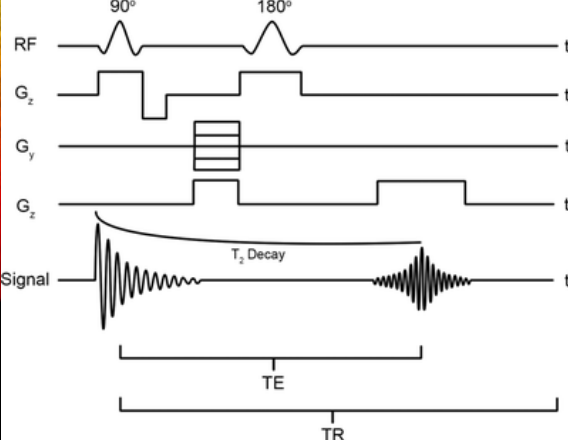

GRADIENT ECHO

- $\alpha < 90^\circ =$ shorter TR
- T2 \rightarrow T2*
- Sensitive to inhomogeneities
- Lower SAR
- Quick acquisition
- 2 basic families
- No/coherent GRE

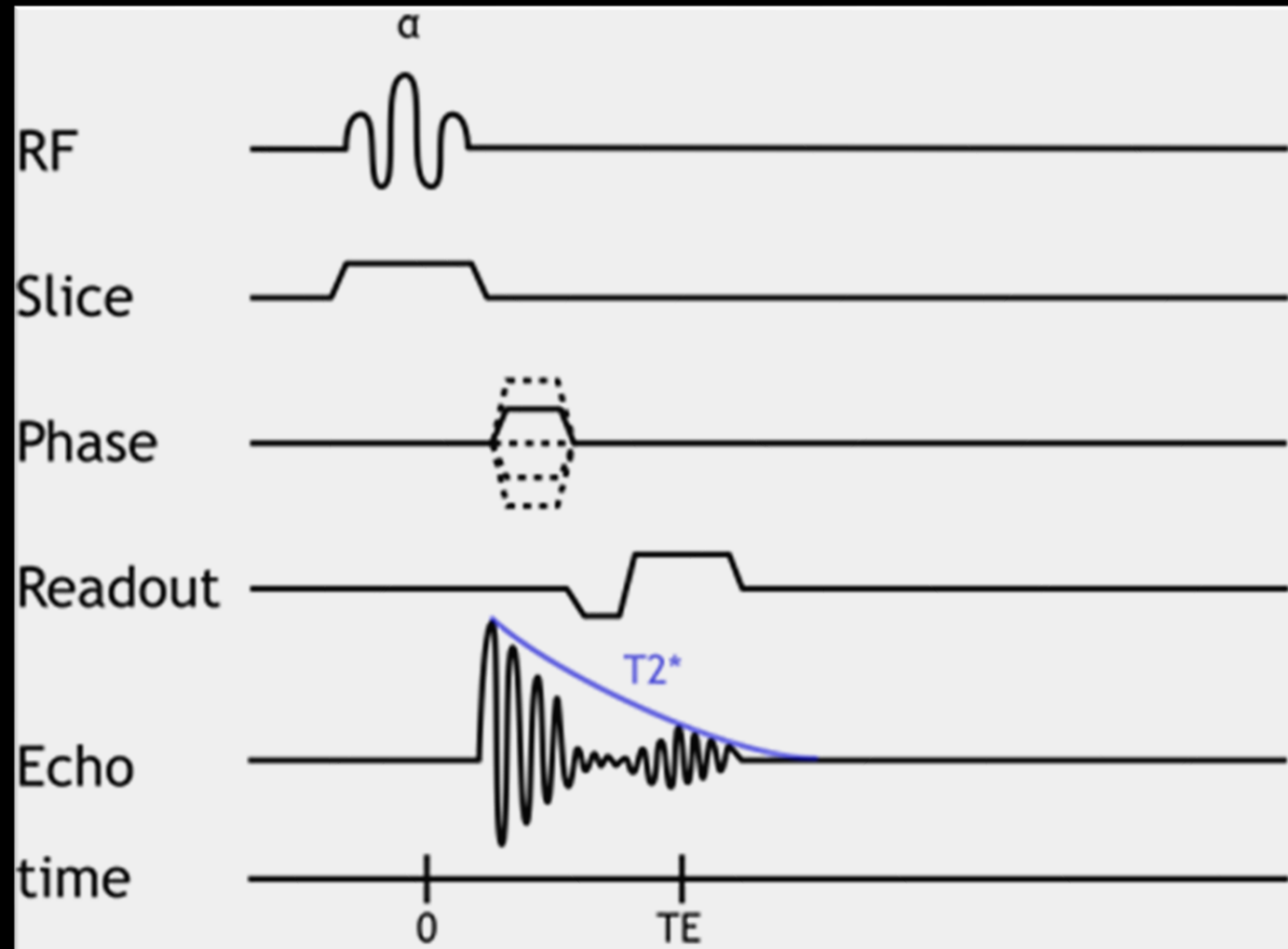

COHERENT GRE (FFE/GRE/FISP)

- Preserves the transverse component M
- Signal T2/T1 weighted
- Low tissue contrast
- Flowing blood high signal
- TOF MRA

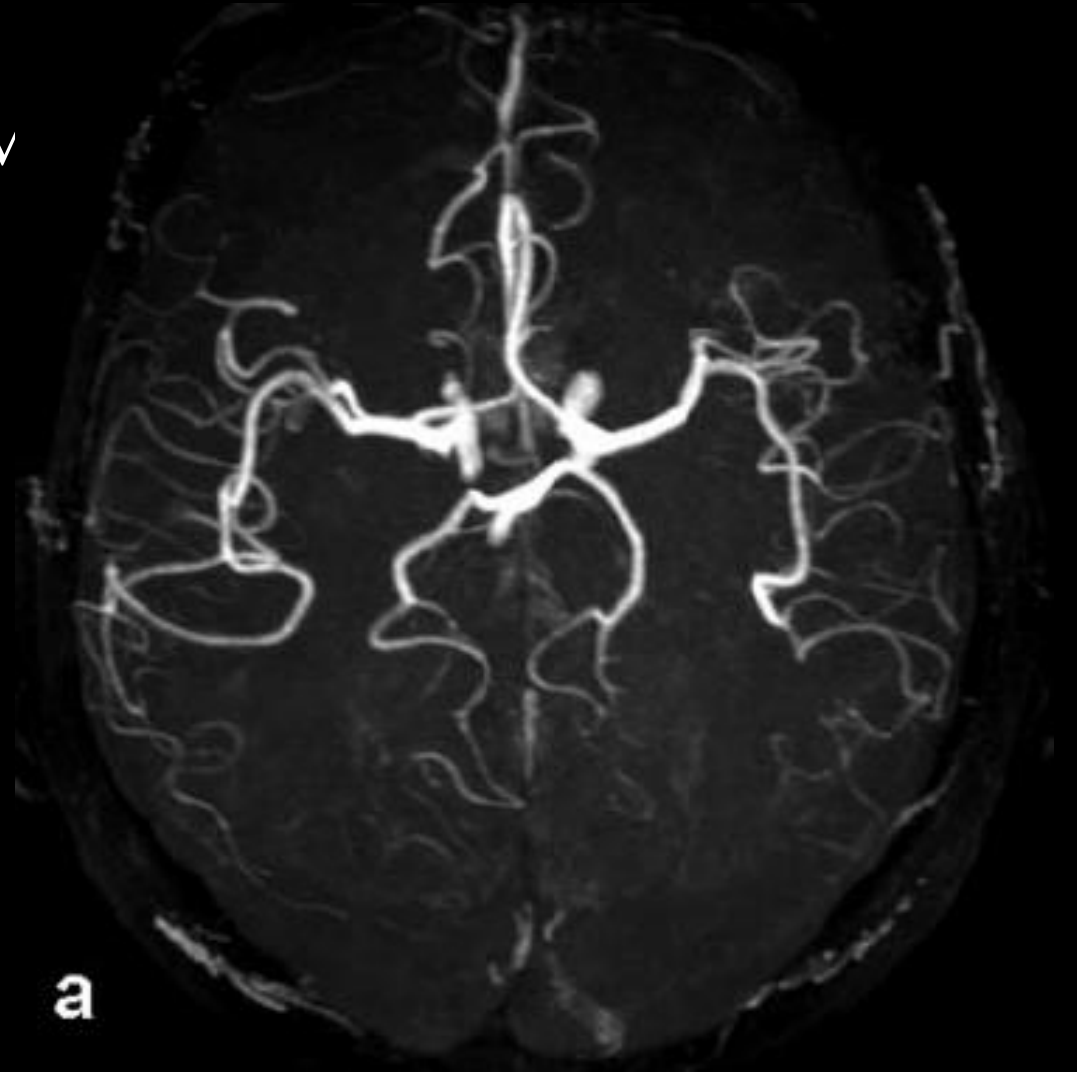

KOH GRE (T2 FFE/FSPGR/PSIF)

- SE sequence generated by GRE
- Sequence of α -pulses and grad.
- $TE > TR$
- Low SNR
- Quick measurement
- Extremely sensitive to the movement of spins in the
-

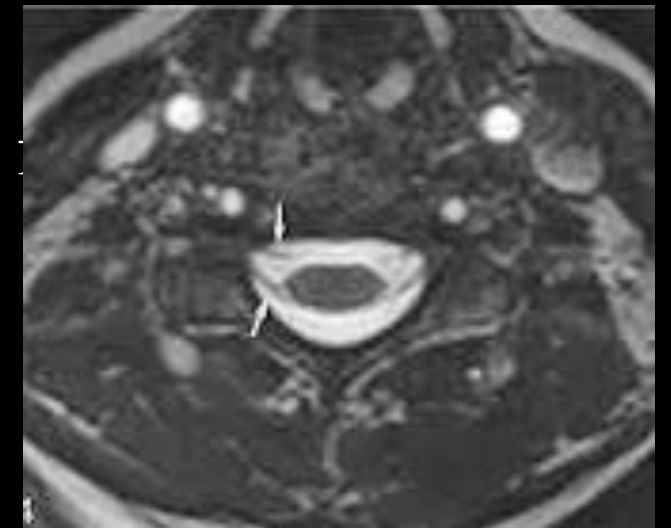
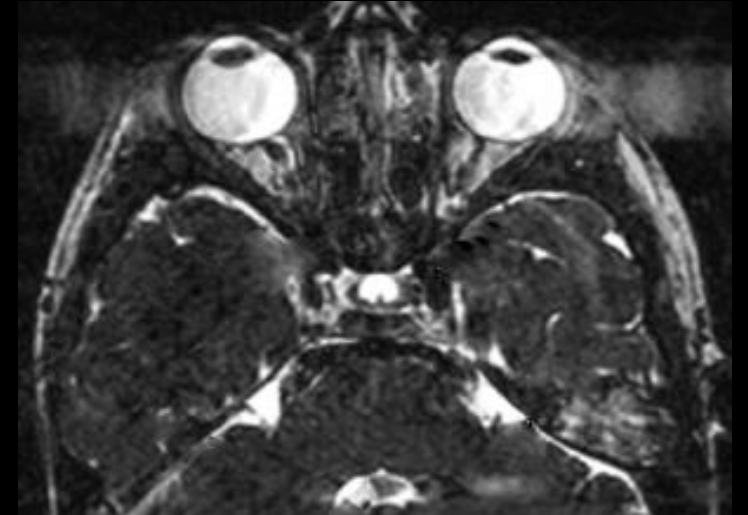

KOH GRE (MENSA/DESS)

- "Sum" of FISP (GRE) and PSIF (SE)
- Unique contrast
- Use in MSK
- Cartilage/fluid/bone
-

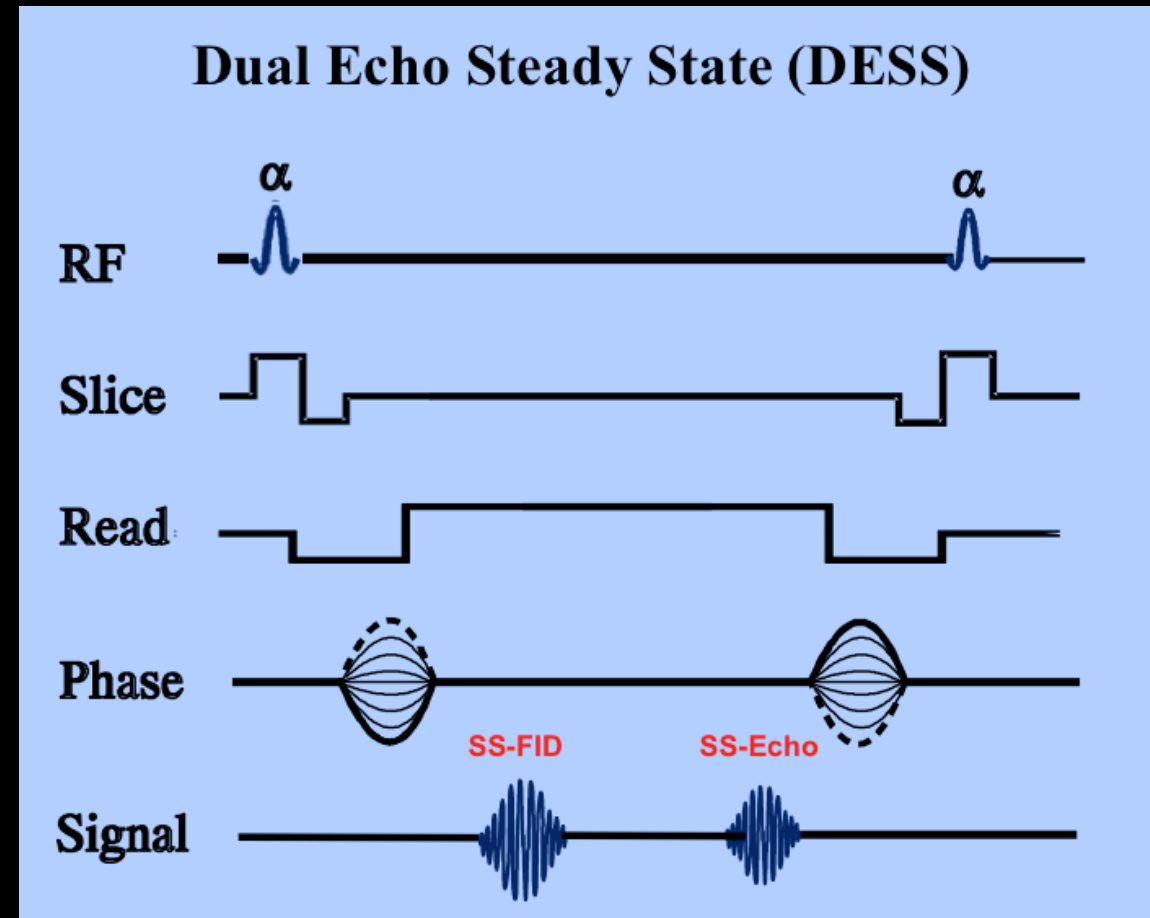

KOH GRE (MENSA/DESS)

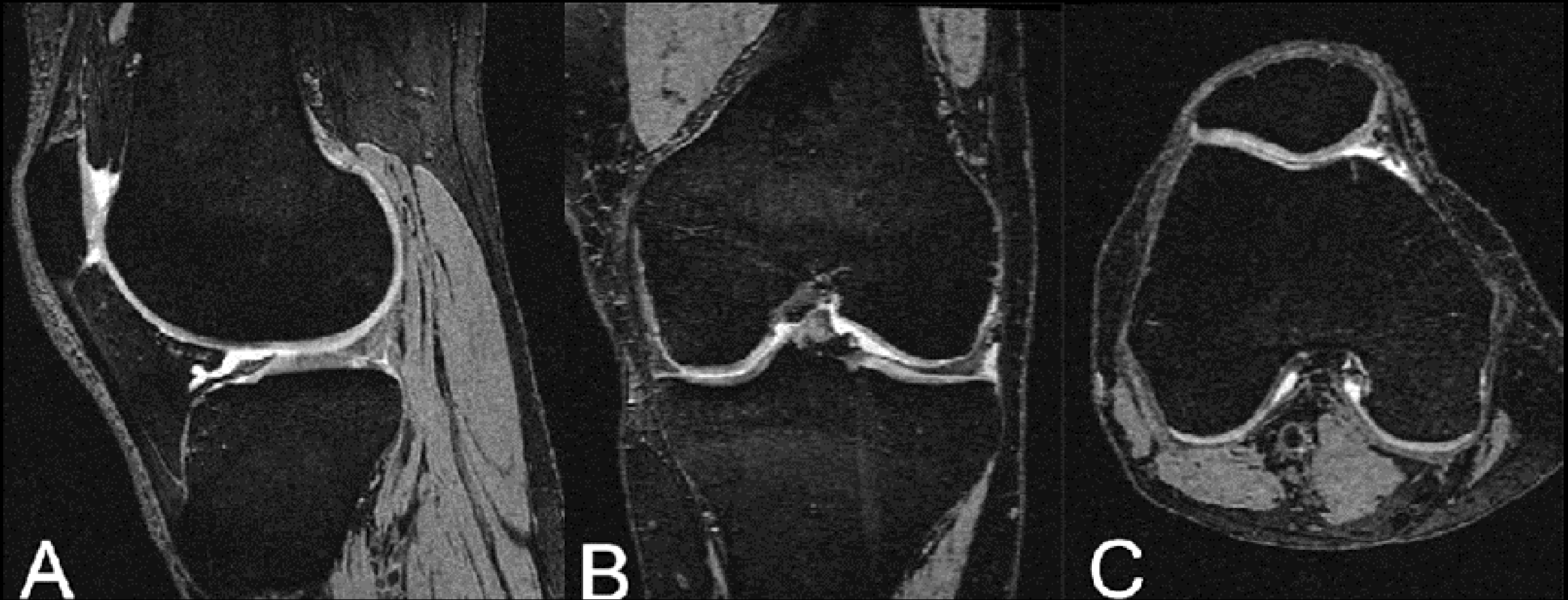

KOH GRE (FIESTA-C/CISS)

- Combination of FISP (GRE) and PSIF (SE)
- $SCISS = (S1 + (-1)^n S2) / 2$
- Neuro-vascular contact
- MR cisternography
-

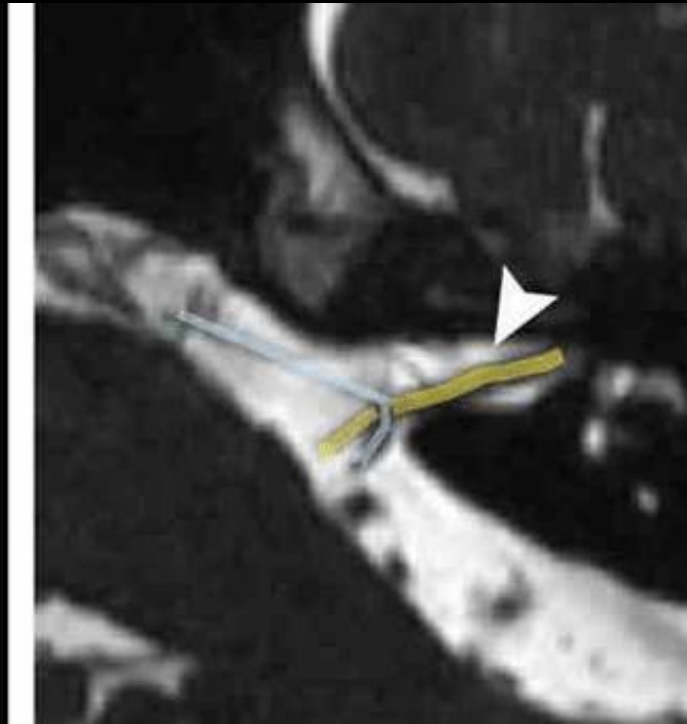
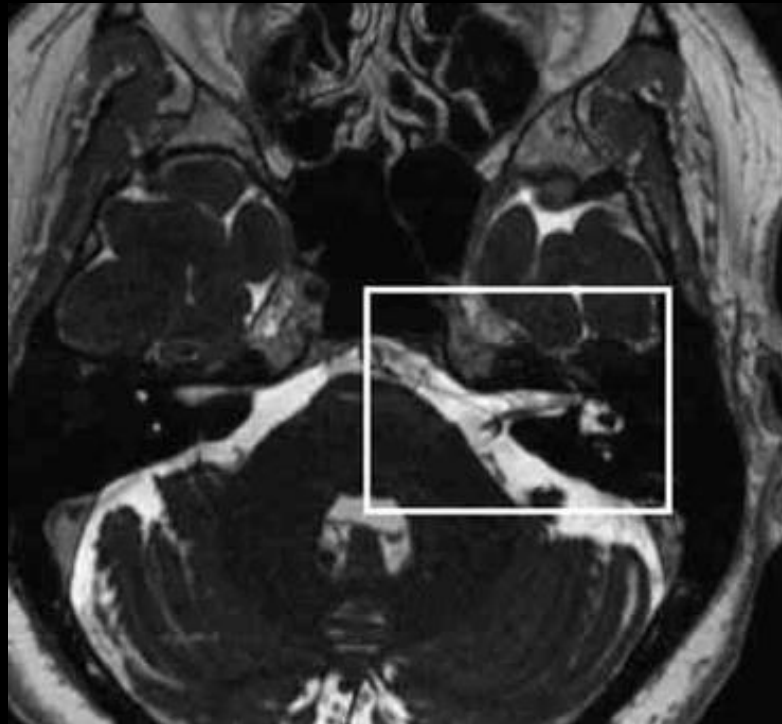

KOH GRE (FIESTA-C/CISS)

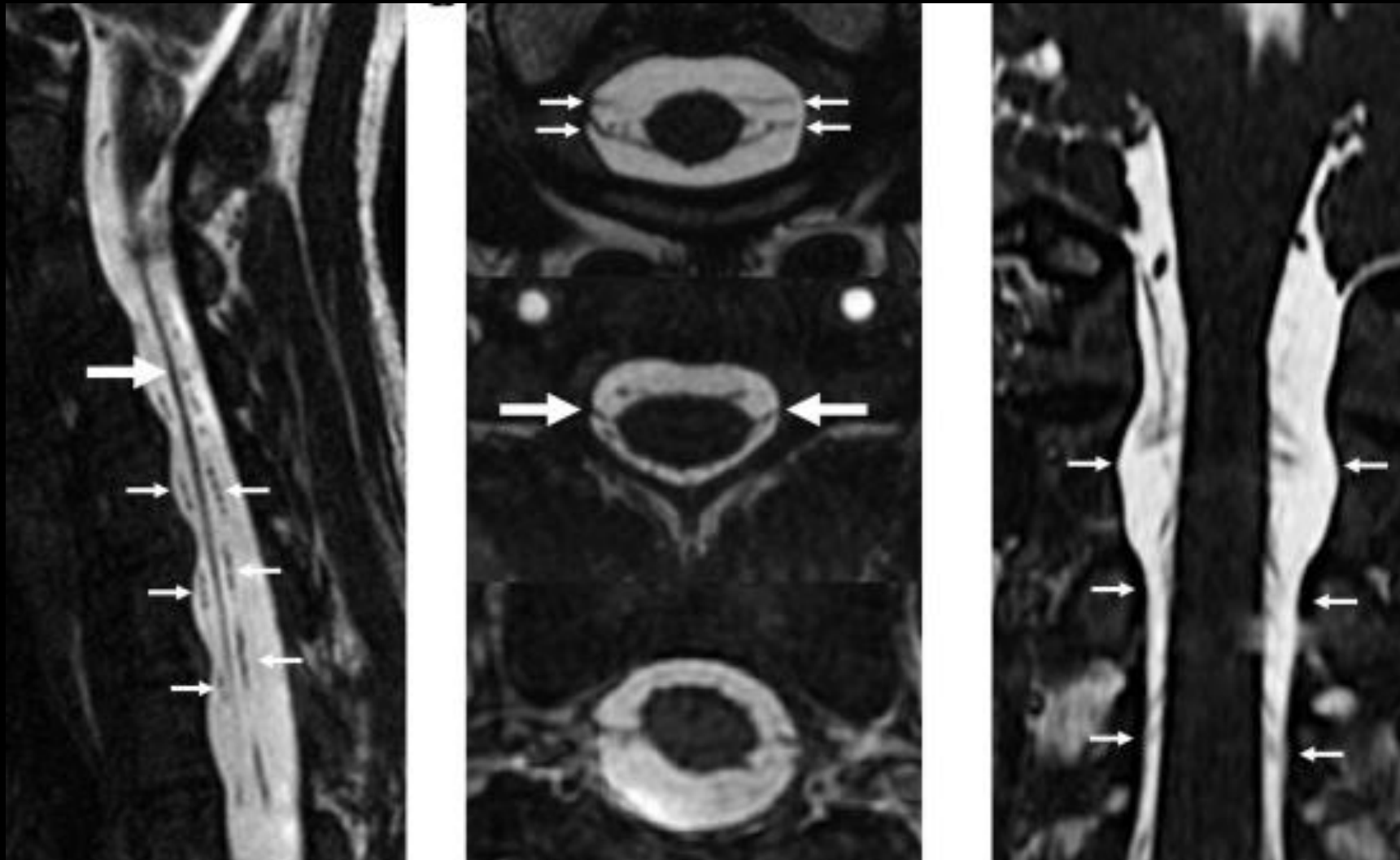

KOH GRE (FIESTA/BFFE)

- Balanced sequence of all GRETs
- Very fast
- Less sensitive to turbulence
- Extremely sensitive to inhomogeneities B_0 ($\sim 1/TR$)
- Stronger field = bigger problem
- Cardio
- Quick display of the abdomen
-

KOH GRE (FIESTA/BFFE)

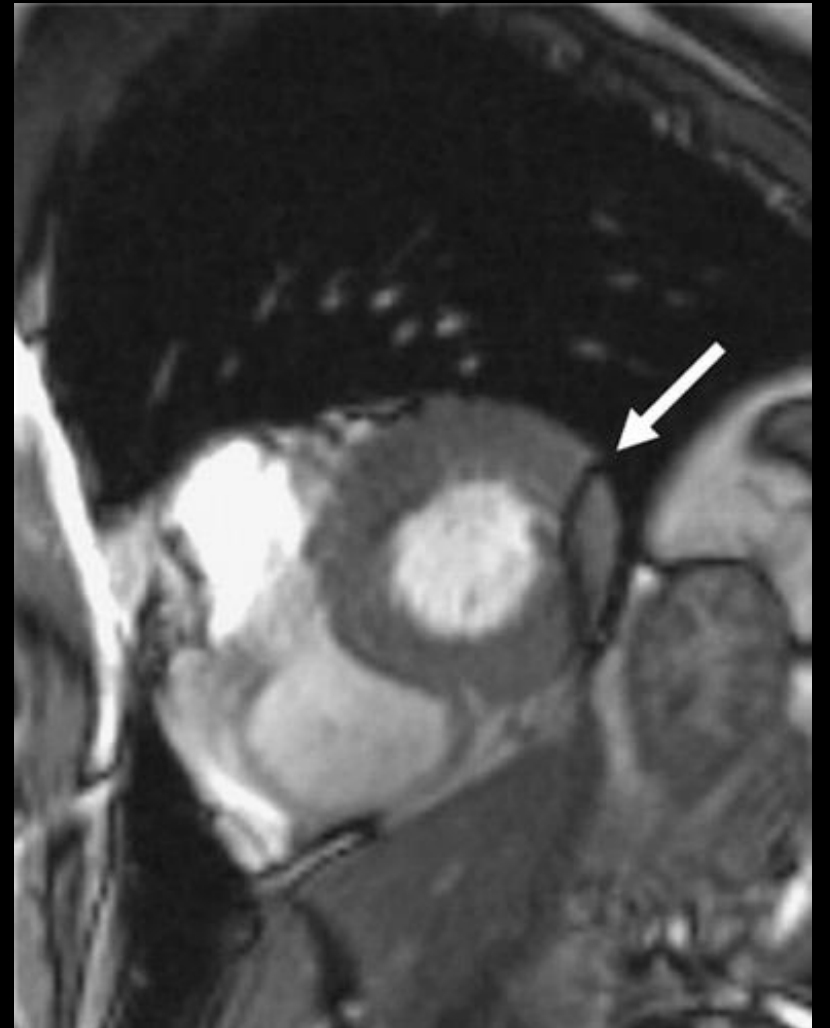
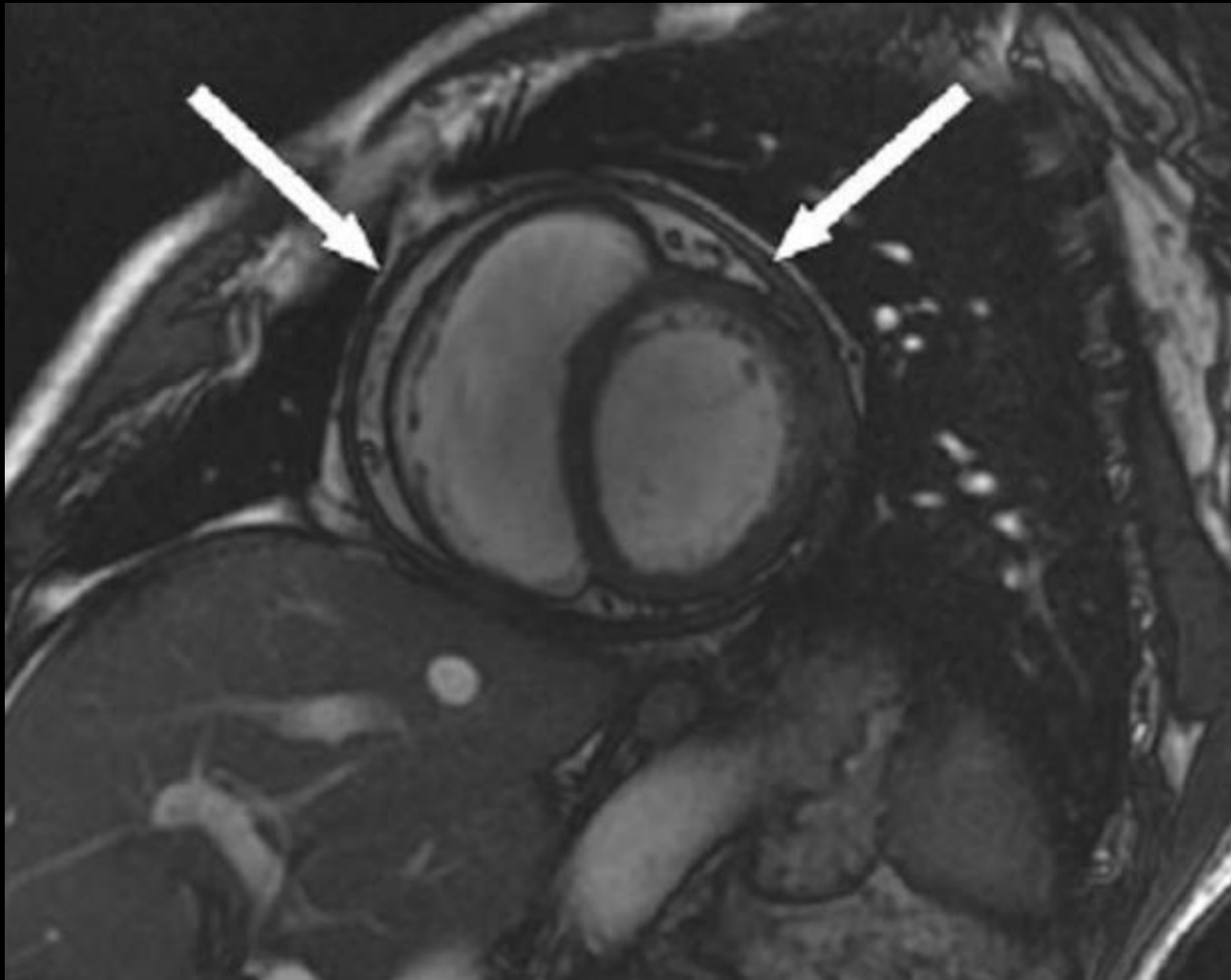

KOH GRE (FIESTA/BFFE)



NEKOH GRE (FSPGR/T1FFE)

- Does not preserve the transverse component M^{\perp}
- Signal T1 or T2* weighted
- Quick Sequence
- Detection of haemosiderin/calcification
- Contrast MRA
- T2* significantly shorter than T2
- Very sensitive to mag. inhomogeneities
- Suscept. art. increase in size with a larger TE
-

Vážení	TE	TR	α
PD	Min	300-600 ms	10-20°
T1	Min	100-300 ms	30-70°
T2*	15-50 ms	300 – 600 ms	10-20°

NEKOH GRE (FSPGR/T1FFE)

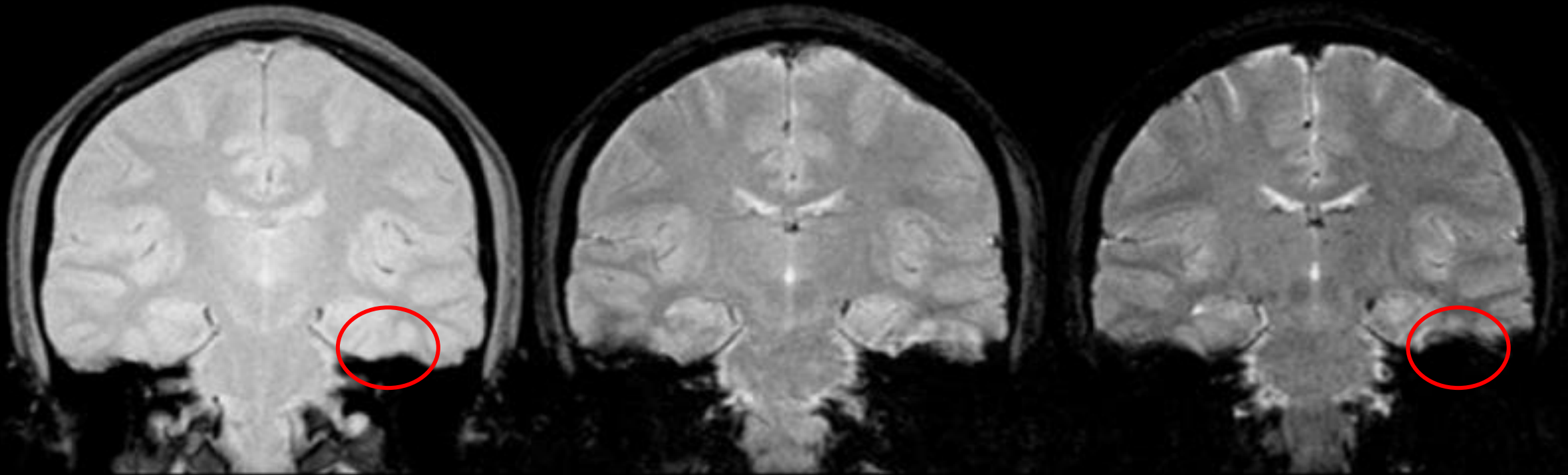

TE = 10

TE = 30

TE = 50



More T2* Weighting

NEKOH GRE (FSPGR/T1FFE)

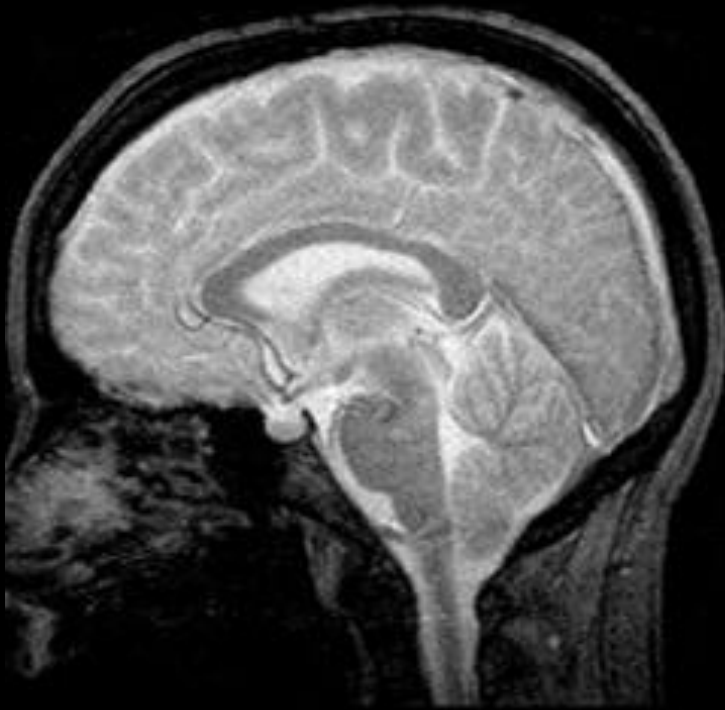

$\alpha = 10^\circ$

[H] and T2* Weighting

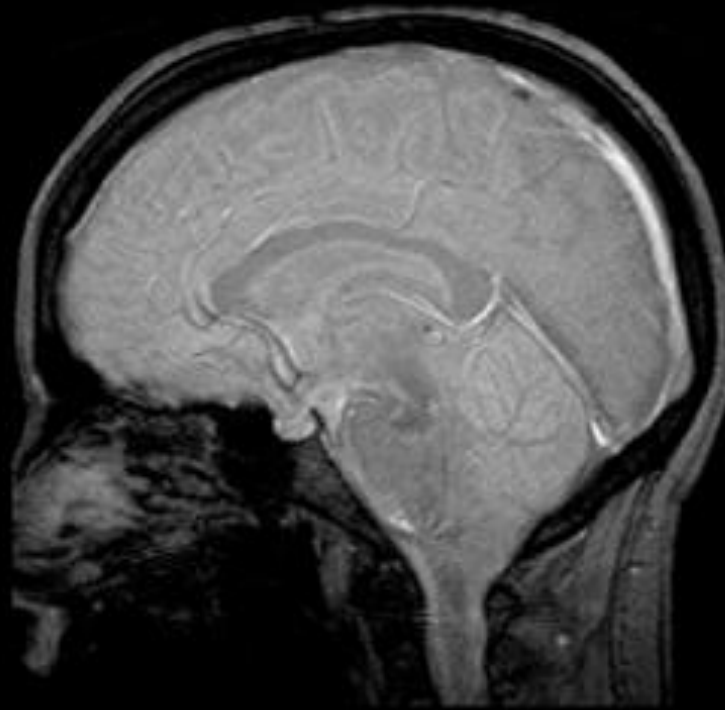

$\alpha = 30^\circ$

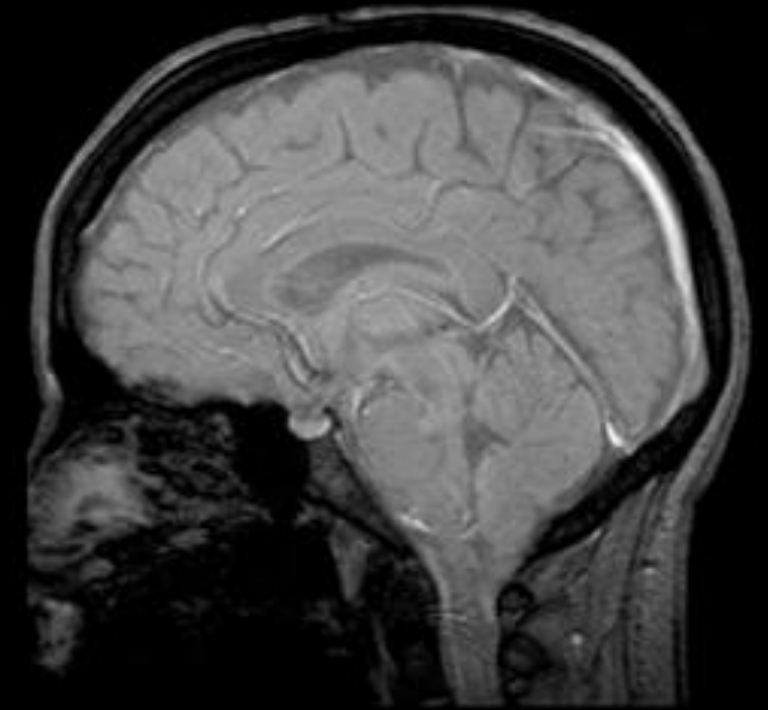

$\alpha = 50^\circ$

More T1 Weighting

NEKOH GRE (FSPGR/T1FFE)

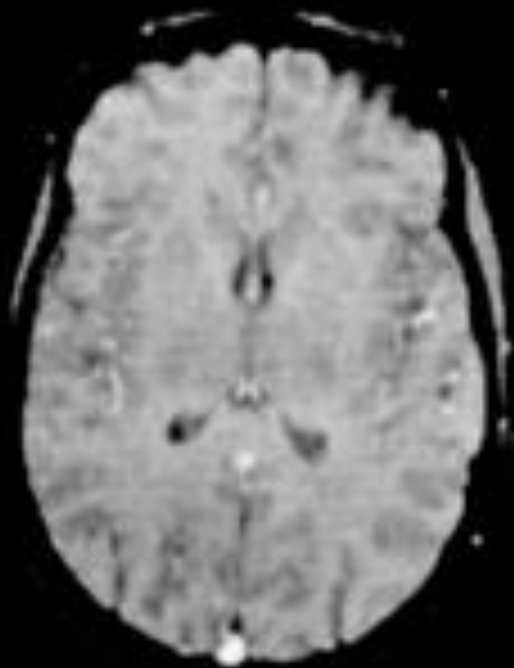

TR = 20

More T1 Weighting

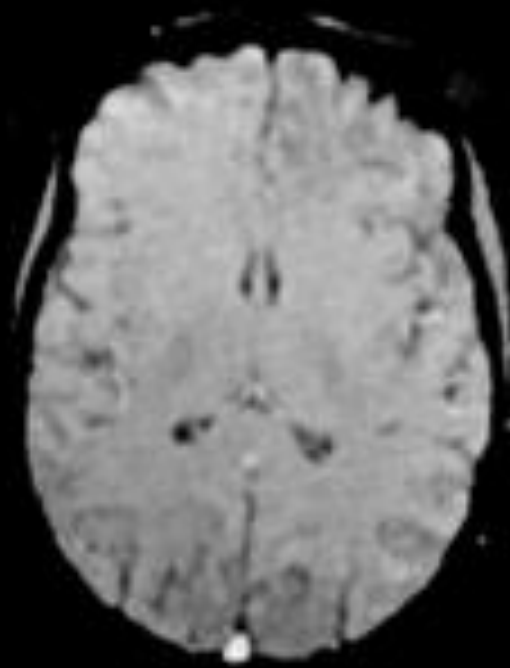

TR = 50

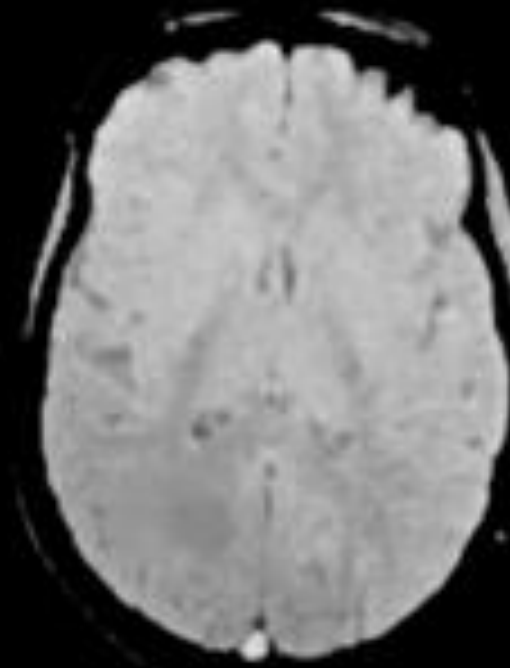

TR = 100

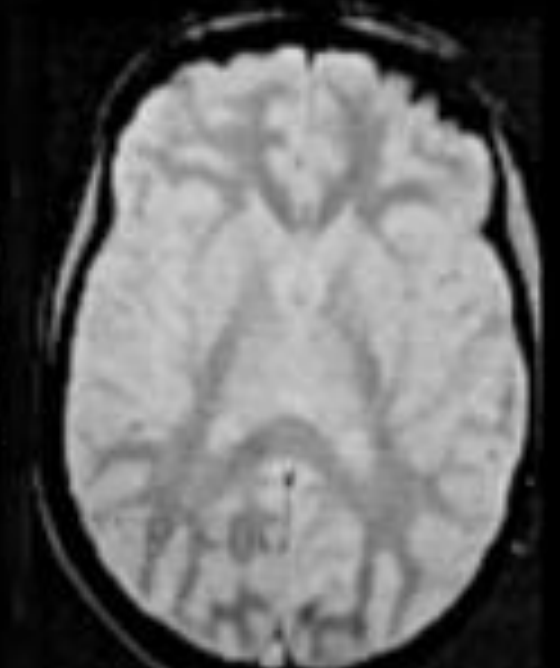

TR = 400

More [H] Weighting



NEKOH GRE (FSPGR/T1FFE)

SE



GRE



NEKOH GRE (SWAN/SWI)

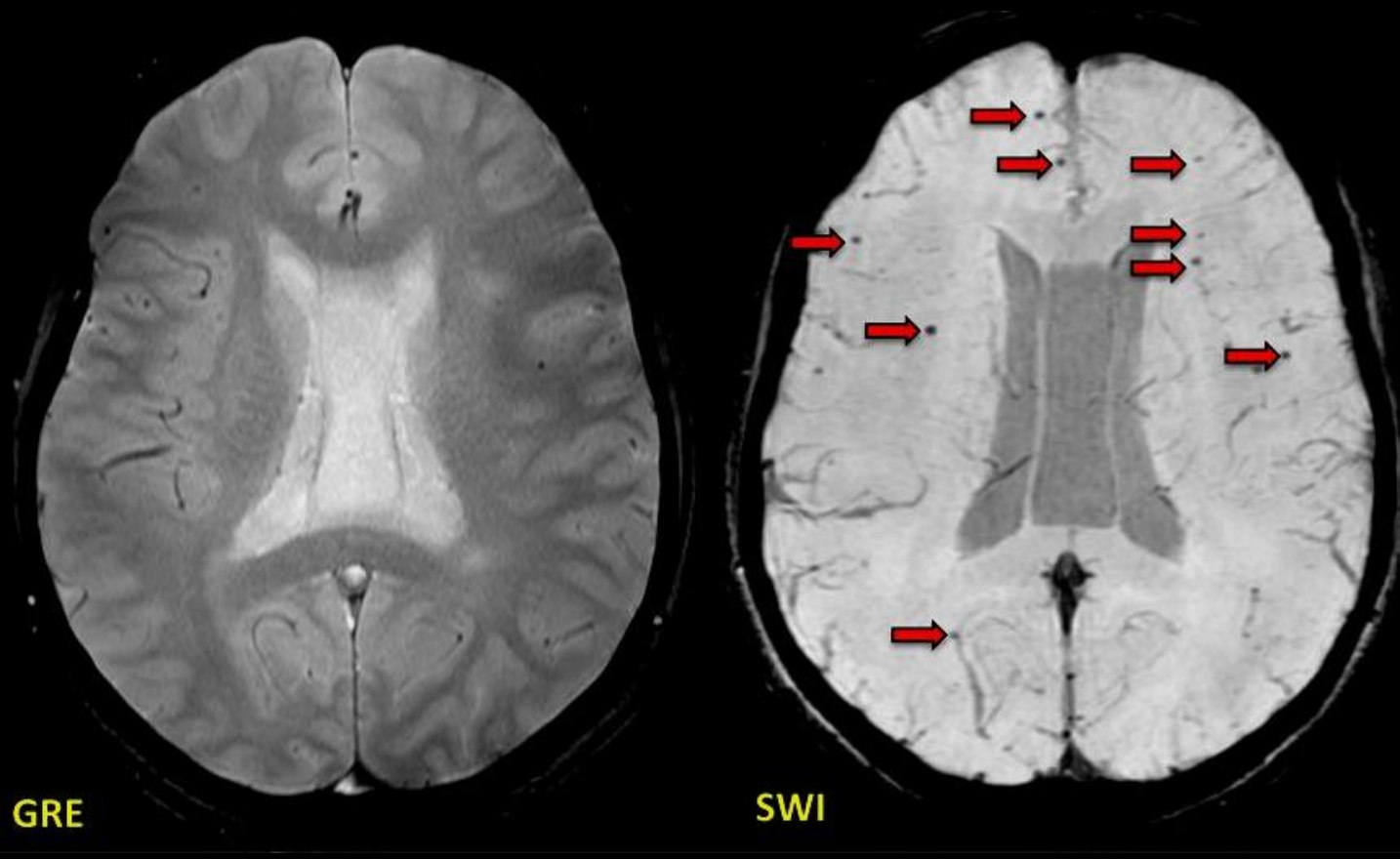
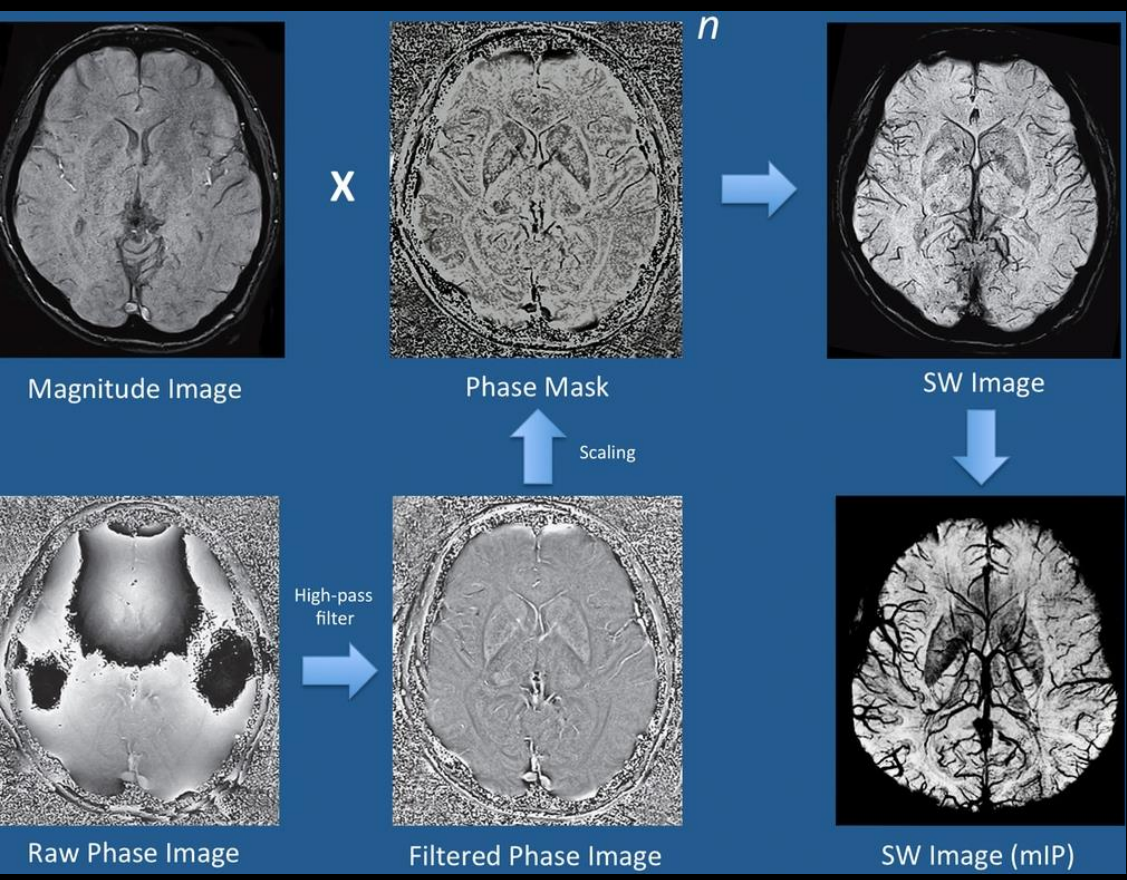

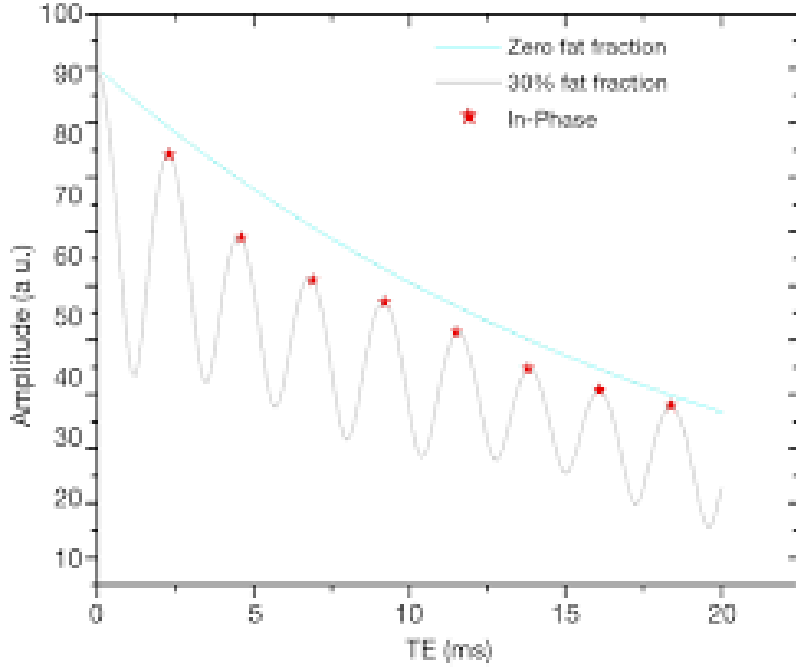

NEKOH GRE (IN/OUT PHASE)

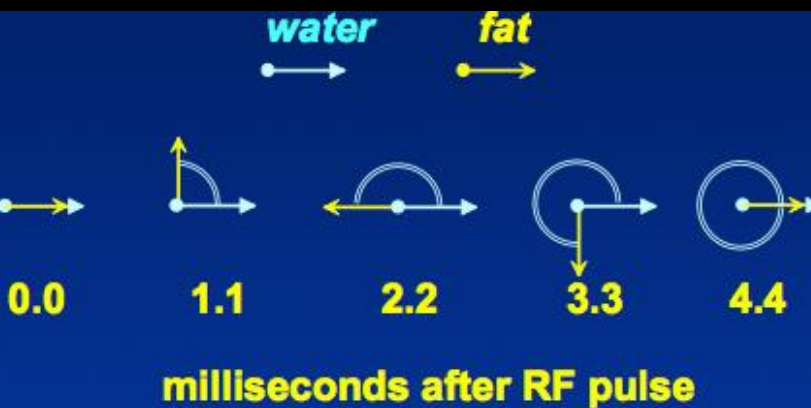

Dependence on B0

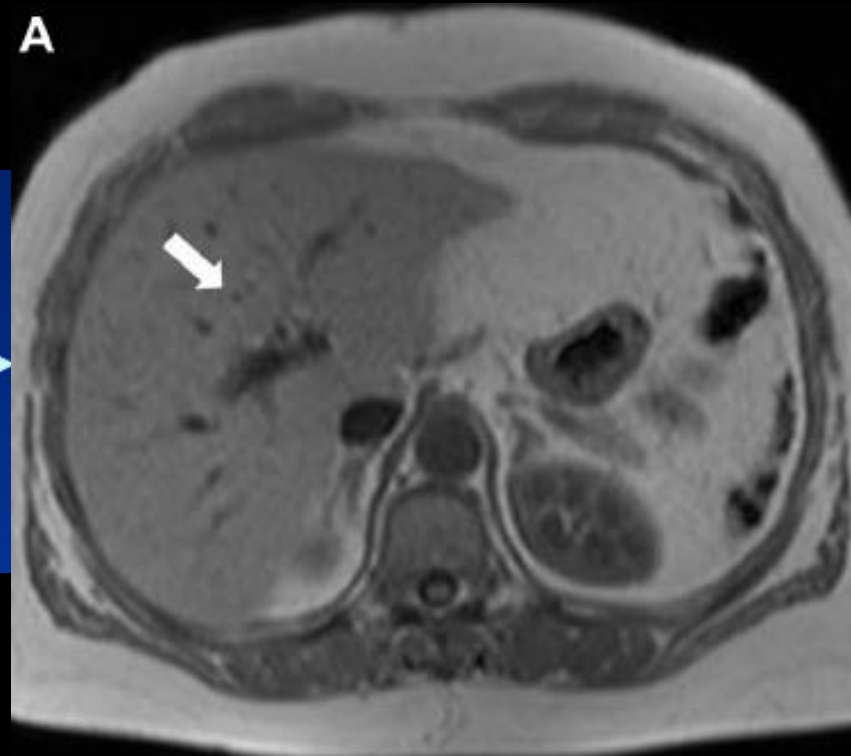

NEKOH GRE (M-FFE/MERGE)

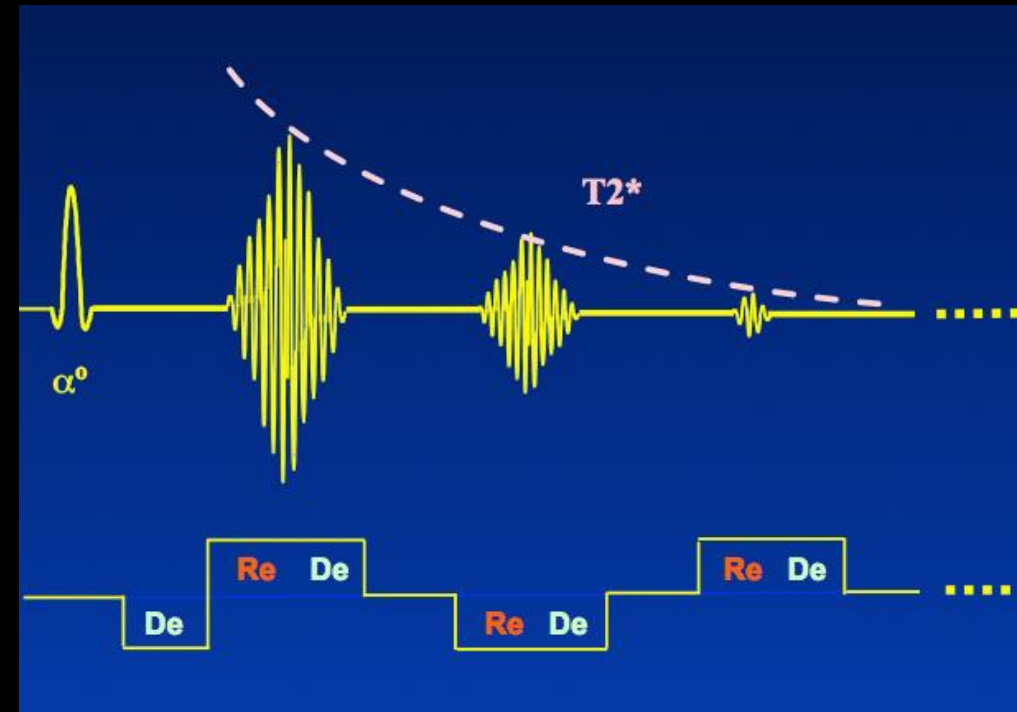
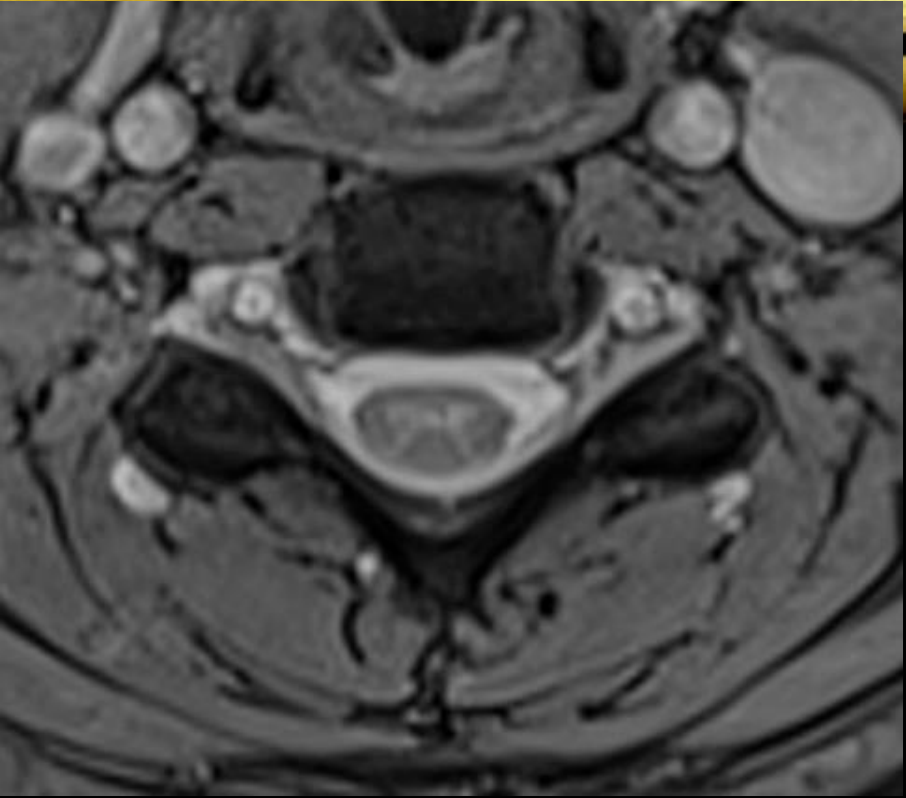

NEKOH GRE (THRIVE/LAVA)

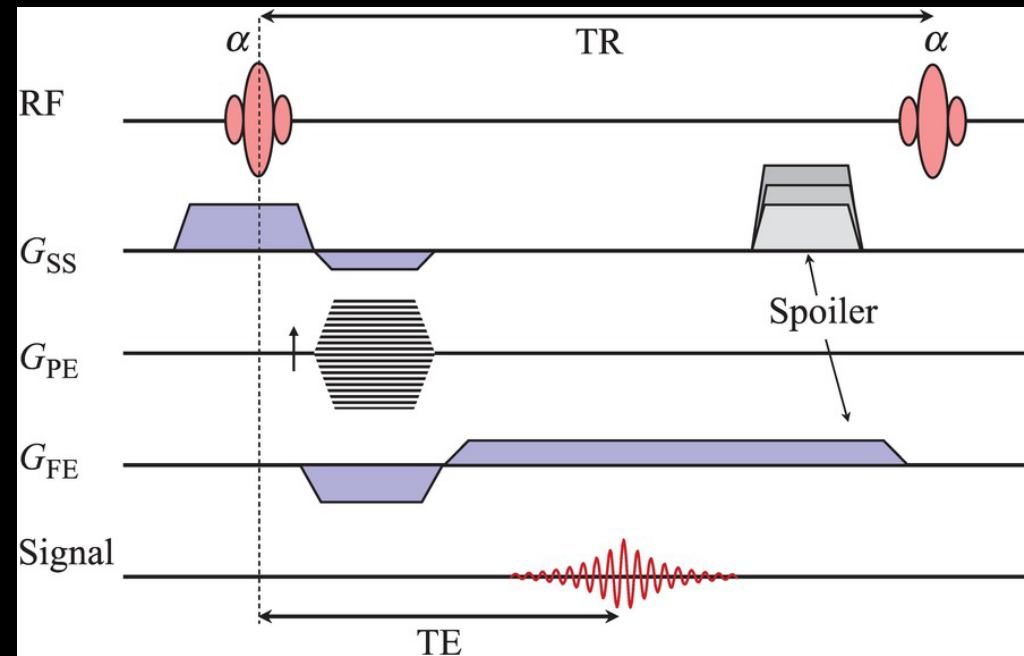
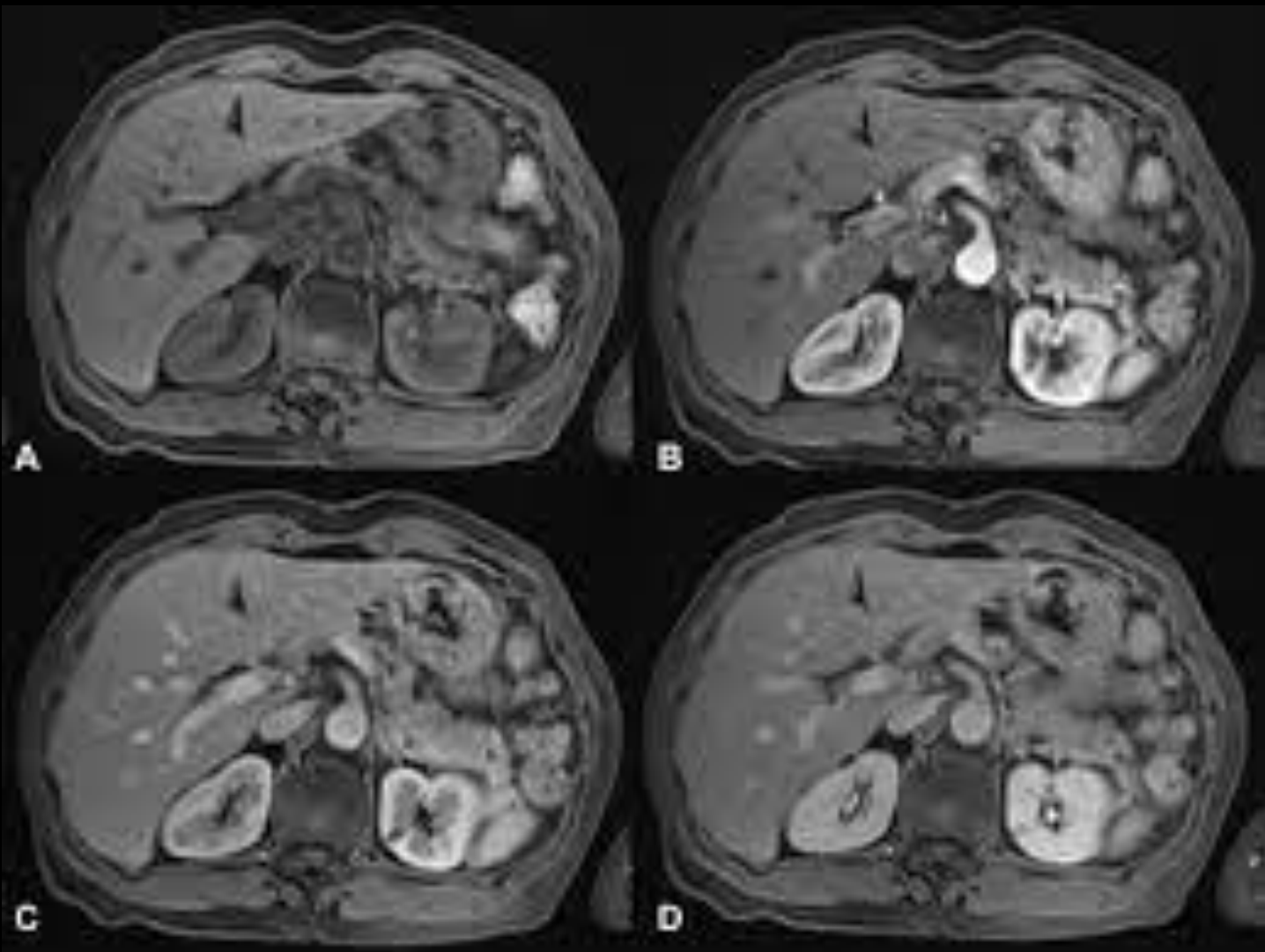

Very short TR (~5 ms) and TE (~1ms)
Fast data collection (~15 s)

Sequence	Siemens	GE	Philips	Hitachi	Toshiba
Generic Gradient Echo	GRE	GRE	FFE	GE	FE
RF-Spoiled GRE	FLASH	SPGR	T1-FFE	RSSG	T1-FFE
Coherent GRE with "FID" Refocusing	FISP	GRASS	FFE	SARGE (SG)	FE
Coherent GRE with "Echo" Refocusing	PSIF	SSFP	T2-FFE	TRSG	SSFP
Coherent GRE with Balanced "FID/Echo" Refocusing	True FISP	FIESTA	Balanced FFE	BASG	True SSFP
Coherent Balanced GRE using Dual-excitation	CISS	FIESTA-C	---	PBSG	---
Coherent Double GRE using Combined "FIDs" & "Echoes"	DESS	MENSA	---	---	---
Spoiled GRE using Combined Multiple FIDs	MEDIC	MERGE	M-FFE	---	---
Ultrafast GRE	TurboFLASH (2D) MP-RAGE (3D)	Fast GRE BRAVO (3D)	TFE 3D T1-TFE	RGE (2D) 3D-GEIR	Fast FE
Spoiled 3D GRE Variants	VIBE	FAME/LAVA	THRIVE	TIGRE	3D QUICK
GRE Plus SE with Combined Signal	TGSE	---	GRASE	---	Hybrid EPI

MR SAFETY

- Strong static and dynamic mag. Field
- According to FDA up to 8T for adults without risk
- Rapid changes $dB/dt = >$ stimulation of the periphery. Nerves not heart muscle
- High-frequency RF pulses
- Most E converted to heat (cumulative)
- Specific Absorption Rate (SAR, [W/kg])
- $SAR < 4 \text{ W/kg} = >$ no temperature increase
- $SAR < 6 \text{ W/kg} = >$ well tolerated
- Greater increase in T on the surface
- Noise
- Small space

MR SAFETY

- Noise
- Grows with B_0 and gradient velocity
- Various noise reduction methods
- There may be a problem in psychiatric patients or pregnancy
- Small space
- Can be suppressed by open magnet design
- Closed magnets with larger gantry (70 cm)
- Calming down with medication or anesthesia

MR SAFETY

- Metal implants
- Dislocation of ferromagnetic due to B_0
- Heating of el. conductive thanks to RF and grad. pulses
- Ferromagnetic material always absolute contraindications
- Non-ferromagnetic = artifacts in the image
- Some implants can only be used under certain conditions (B_0 , grad., SAR...)
-

MR SAFETY - CARDIO STIM.

- The patient must have a certificate with the stamp and signature of the attending physician that his pacemaker (including electrodes) is MR compatible.
- This confirmation must not be older than 3 days. A card about the type of pacemaker is not enough. In case of doubt, it is always necessary to contact the attending physician, it is possible to take an X-ray of the chest, which, however, must be indicated by the attending physician.
- The confirmation must include information that the pacemaker is set in MR compatible mode. The advantage is a direct printout from the calibration of the instrument. This confirmation shall not be older than 24 hours.
- The confirmation must include a statement from the attending physician that the patient does not have any other implants that would be a contraindication to the MR examination. Especially, for example, left electrodes, etc.
- The MR workplace must contain information on the conditions for MR examination in these patients for individual types of stimulators (e.g. the need for centration outside the chest, etc.).
- Either the patient brings them with him or they must already be available at the workplace.
- When measuring, the patient must be monitored using an ECG.

Absolutní kontraindikace	Relativní kontraindikace (potenciálně nebezpečné)	Bezpečné	Není kontraindikace
<u>Implantovaný kardiostimulátor nebo defibrilátor (ICD)</u>	Stenty (cévní výztuže), žilní filtry, kovový embolizační materiál <u>a</u> okludery <u>méně než 6 týdnů</u> po implantaci, pokud není písemně doložena jejich MR kompatibilita	Stenty (cévní výztuže), žilní filtry, kovový embolizační materiál <u>a</u> okludery <u>6 a více týdnů</u> po implantaci	Písemné potvrzení výrobce implantátu o jeho plné MR kompatibilitě (kdekoli v těle pacienta) s písemným potvrzením operátora, který jej implantoval
Ponechané elektrody po deplantaci kardiostimulátoru nebo defibrilátoru	Kloubní náhrady, osteosyntetický materiál a dentální implantáty <u>méně než 6 týdnů</u> po implantaci, pokud není písemně doložena jejich MR kompatibilita	Kloubní náhrady, osteosyntetický materiál a dentální implantáty <u>6 a více týdnů</u> po implantaci, bez známek uvolňování (bez ohledu na použitý materiál)	Nitroděložní tělíska (IUD)
Aneuryzmatické cévní svorky (klipy), pokud není písemně doložena jejich MR kompatibilita	Kloubní náhrady <u>a</u> osteosyntetický materiál se známkami uvolňování	Náhrady srdečních chlopní s výjimkou cíleně udané MR nekompatibility	Stenty (cévní výztuže), žilní filtry, kovový embolizační materiál <u>a</u> okludery, pokud lze písemně doložit plnou MR kompatibilitu (bez ohledu na dobu implantace)
<u>Elektronické implantáty (kochleární, inzulinová pumpa atd.), pokud není písemně doložena MR kompatibilita</u>		Neaneuryzmatické chirurgické cévní svorky (hemostatické klipy) <u>6 a více týdnů</u> po implantaci	
Kovová cizí tělesa z jiného než prokazatelně nemagnetického kovu :- intrakraniálně - intraorbitálně		Svorky na žlučových cestách <u>6 a více týdnů</u> po operaci	

SIGNAL SUPPRESSION/AMPLIFICATION

- Fat suppression
- FatSat
- STIR
- SPAIR
- Water suppression
- FLAIR/DIR
- Magnetizing transfer
- Fat-Water Separation – Dixon
- Water excitation
-

SPIR/FATSAT

- Fat suppression (shift in fat frequency to water, selective RF, gradient pulse reset)
- Significantly does not extend TR
- Does not change the TE
- Does not affect the application of KL
- Very sensitive to field inhomogeneity
- Better separation in higher mags. Fields
-

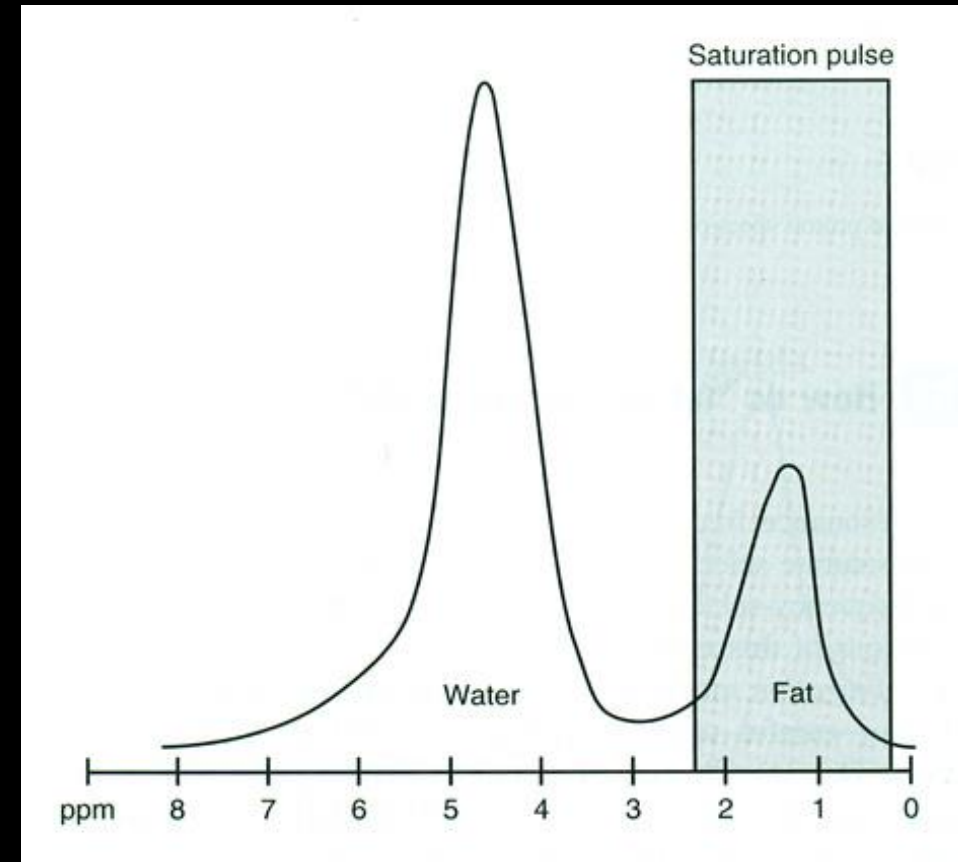

SPIR/FATSAT

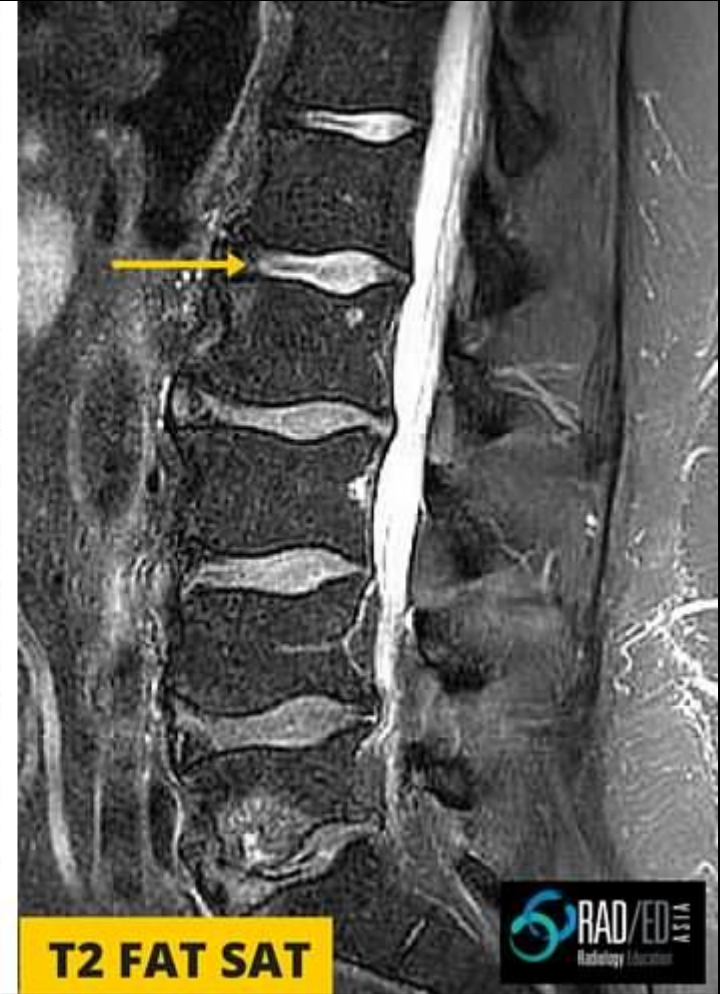
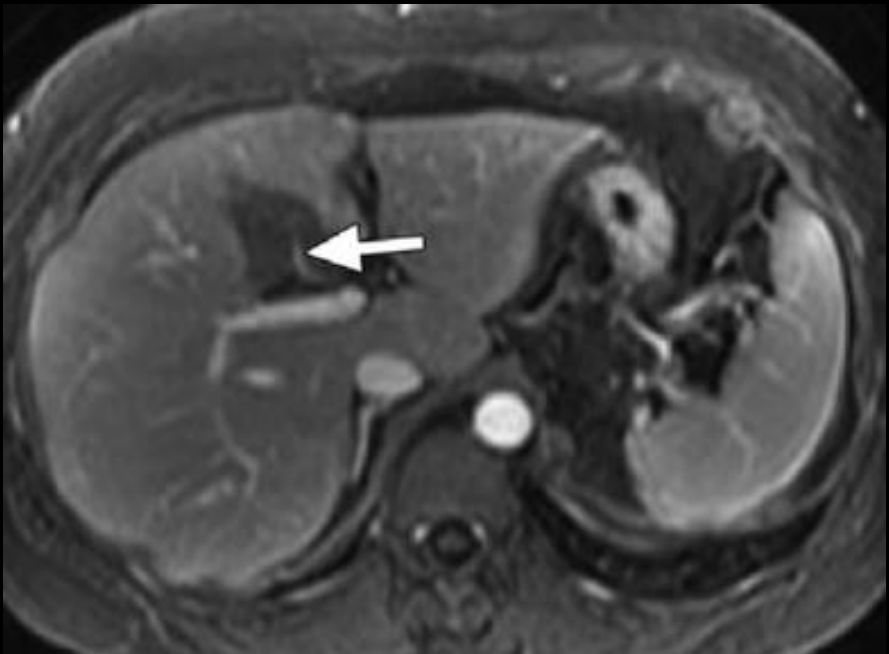
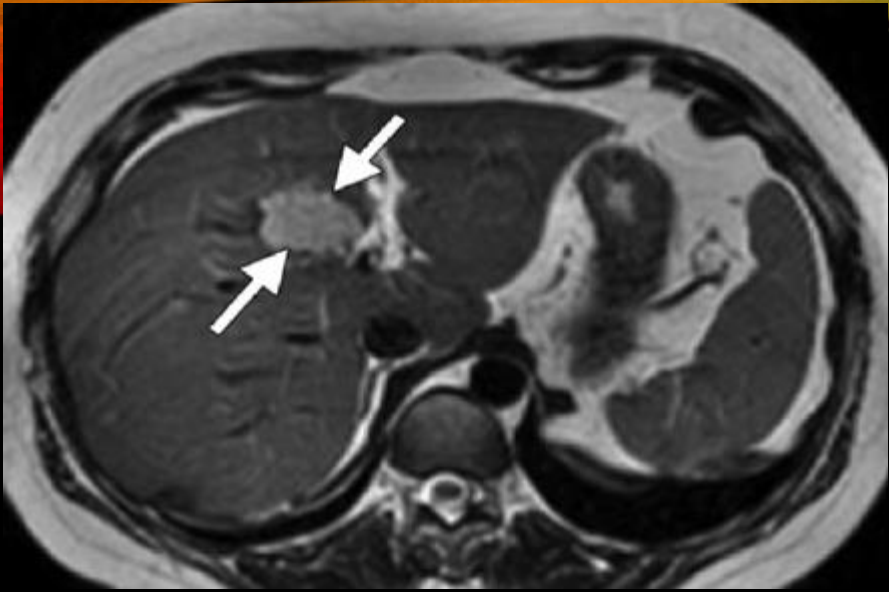

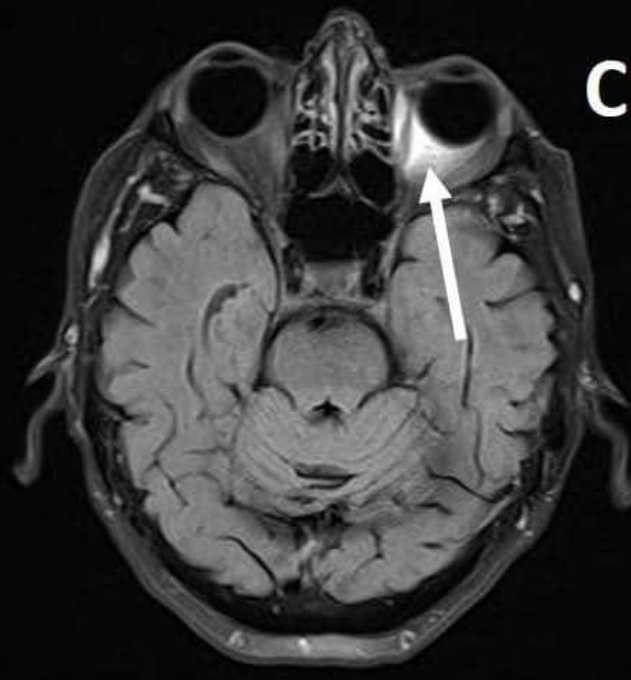

SPIR/FATSAT

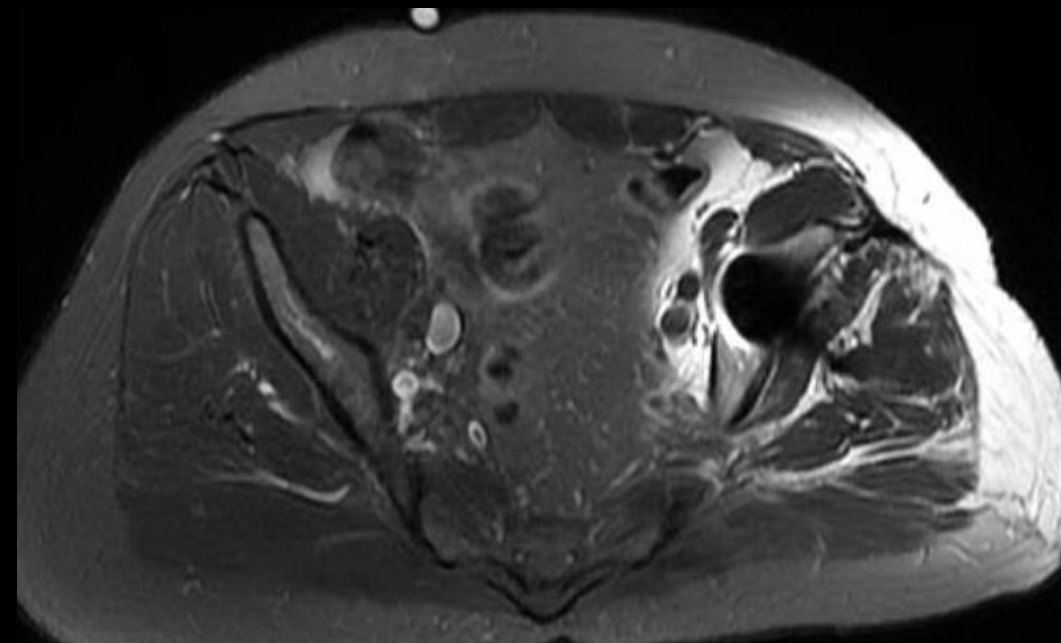
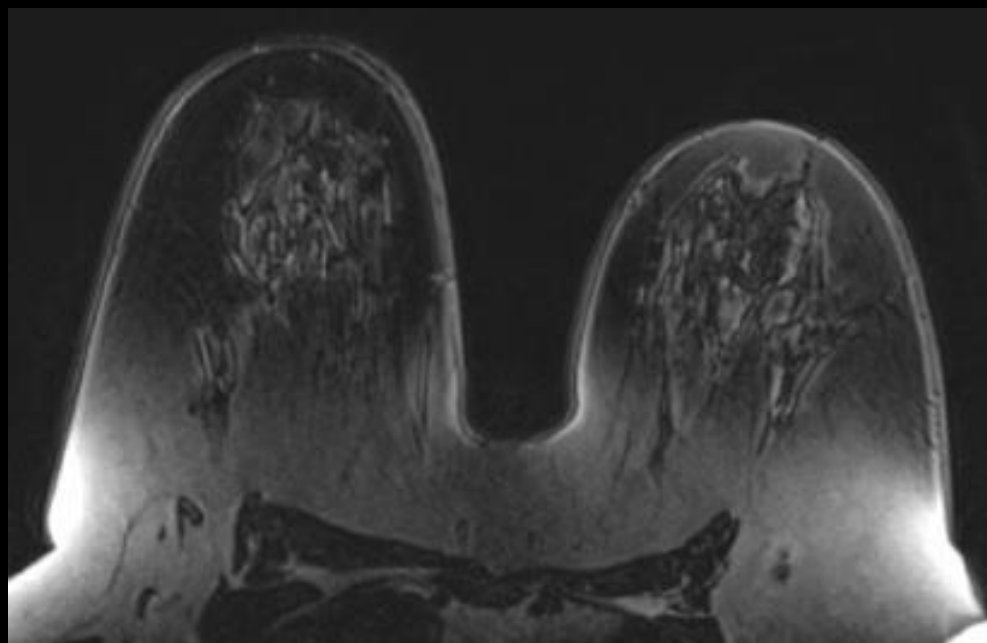

STIR

- Fat suppression based on T1 time by inverse pulse
- Not sensitive to field inhomogeneities
- Can be applied even at lower mags. Fie
- DO NOT use with KL
- Choose longer TR

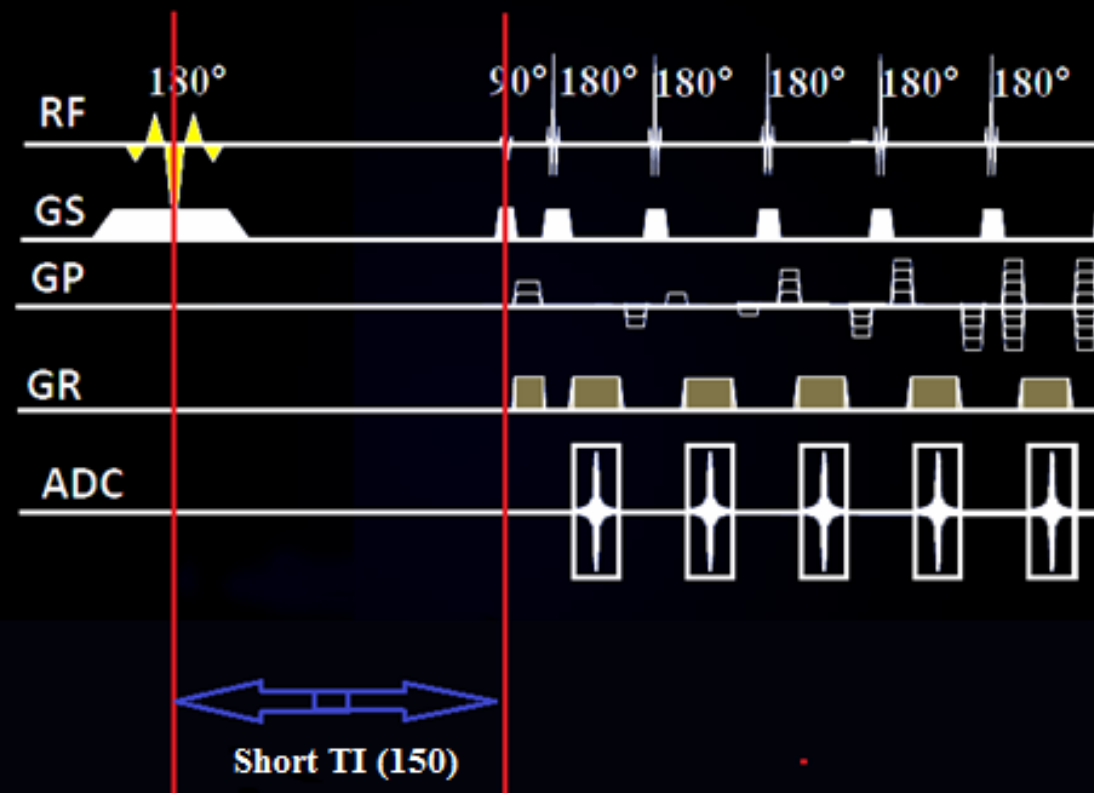
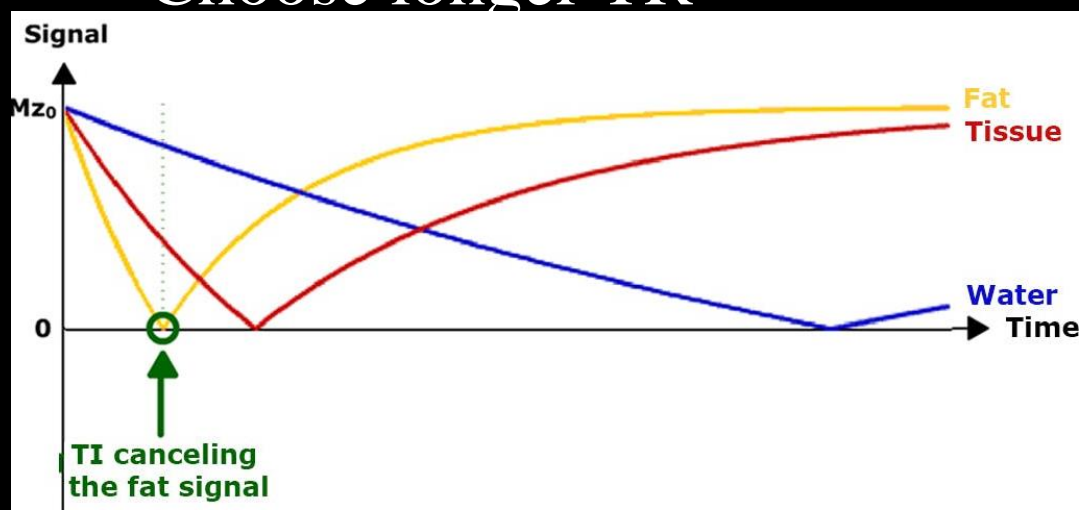

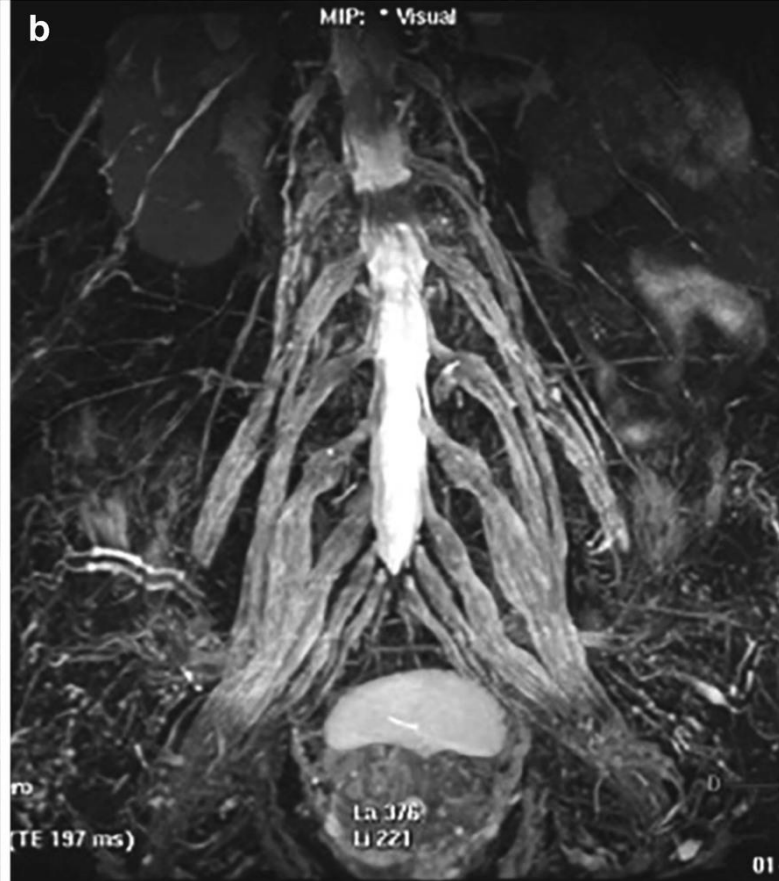
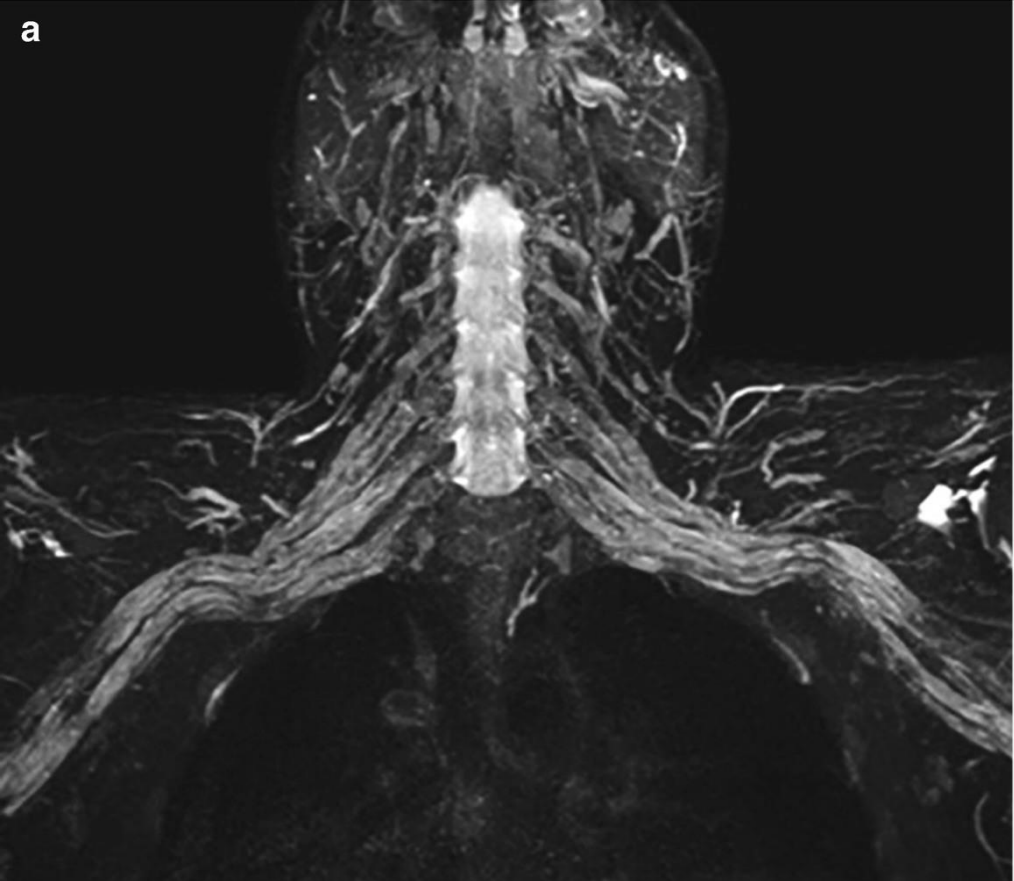

STIR

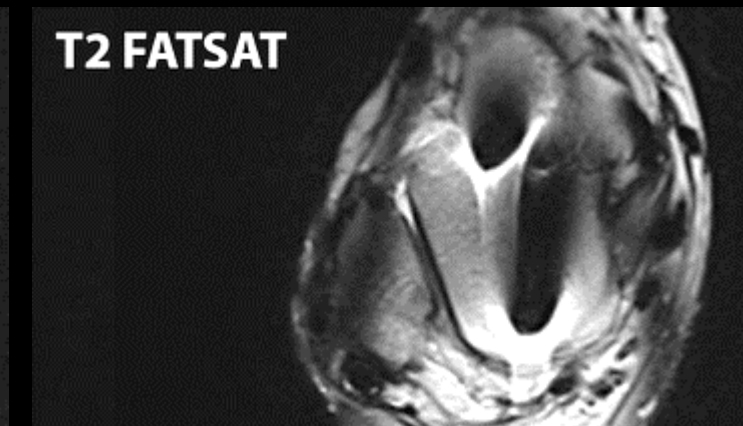
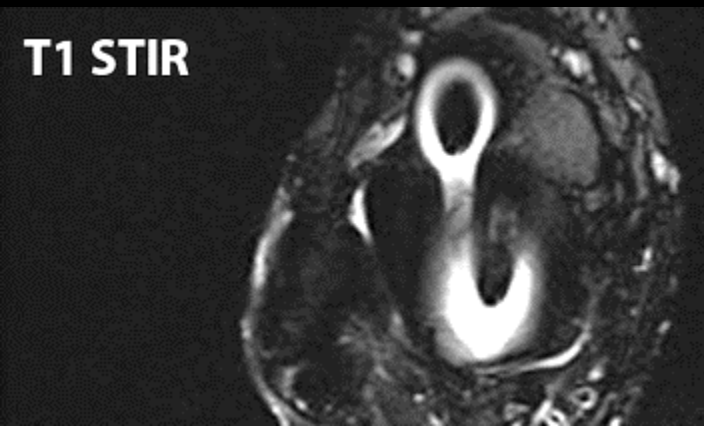

SPAIR/SPECIAL

- Fat suppression based on spectral selection. IR (inverts only fat)
- Less sensitive to field inhomogeneities than FatSat, but more sensitive than STIR
- More signal than STIR
- DO NOT use with KL
-

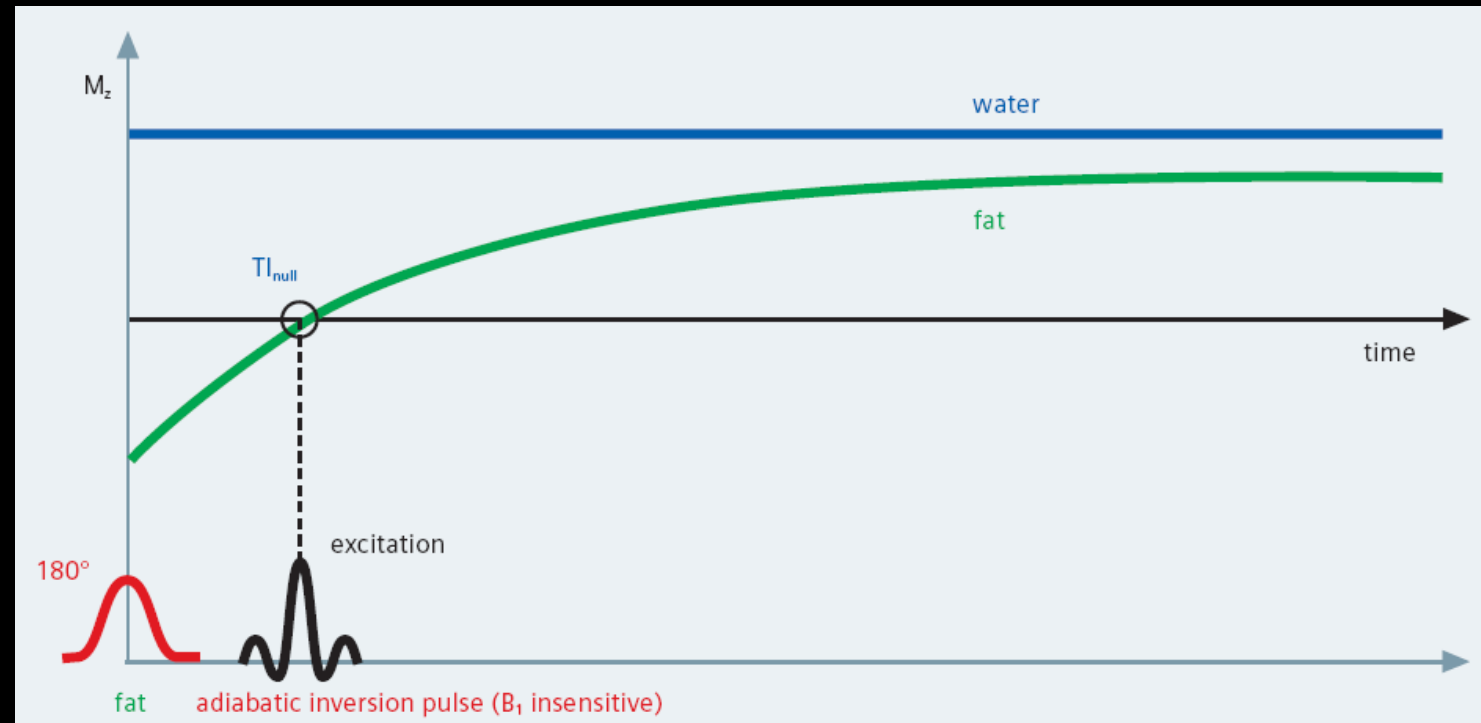

(a)

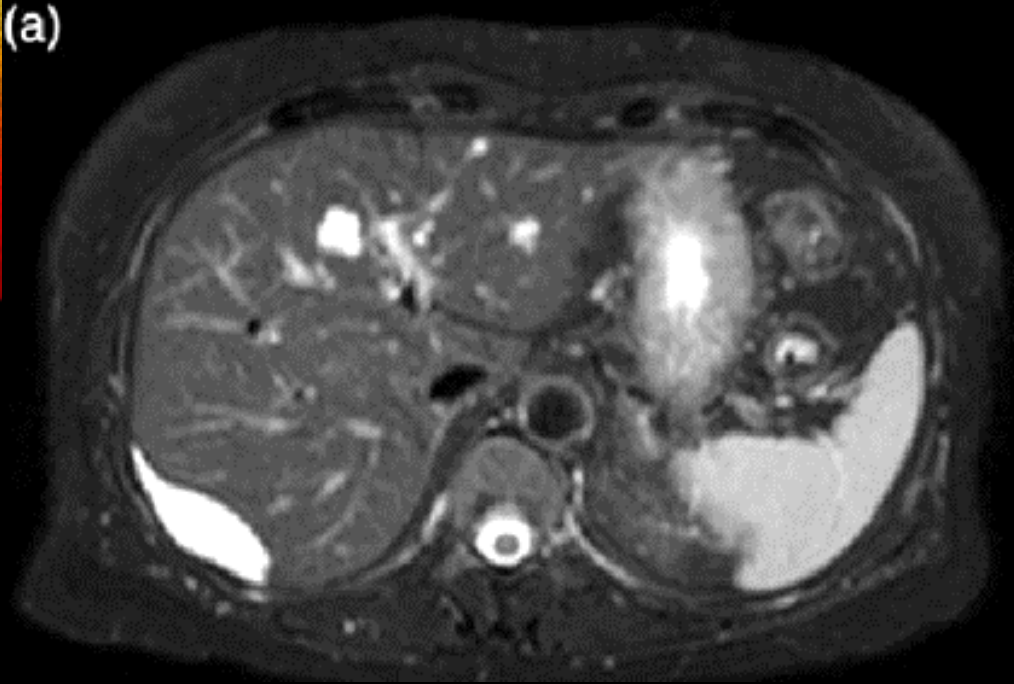

(b)

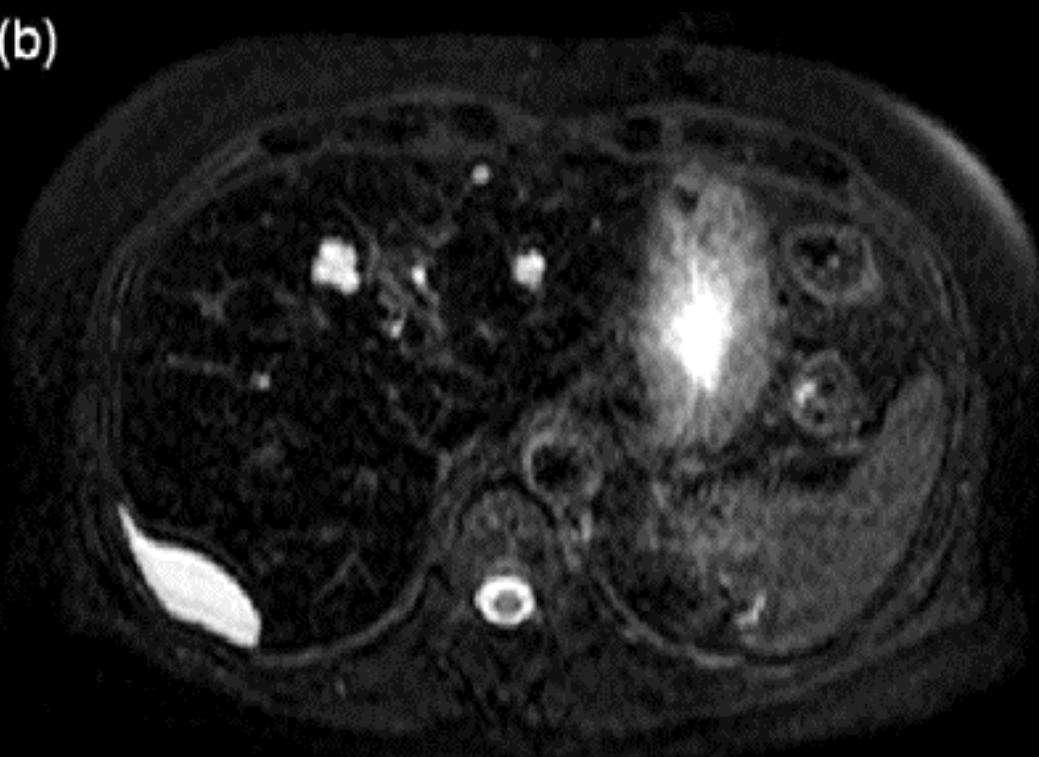

SPAIR/SPECIAL

Fat Sat



SPAIR

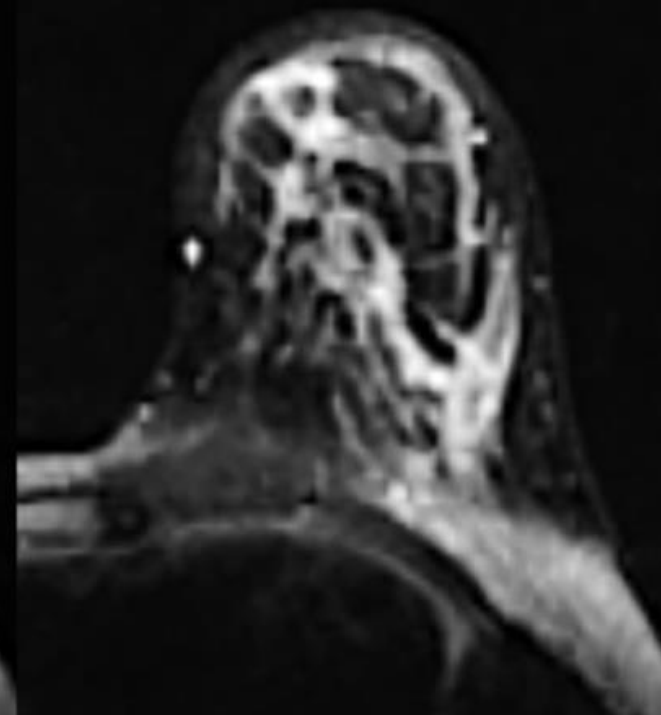

WATER SUPPRESSION (FLAIR)

- IR-based fat suppression
- Long TI = long TR
- TI and TR are tied
- Truncation TR = > TI truncation
- T2-w image (long TE)
- Often together with FatSat
-

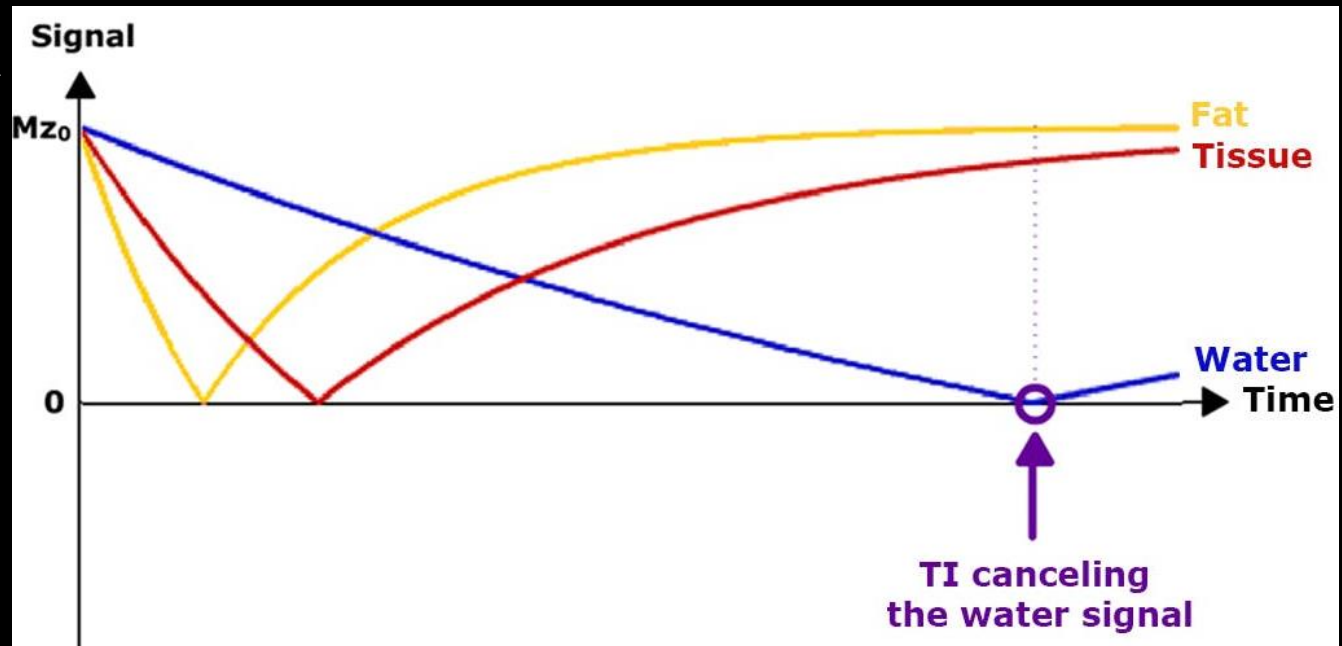

FLAIR

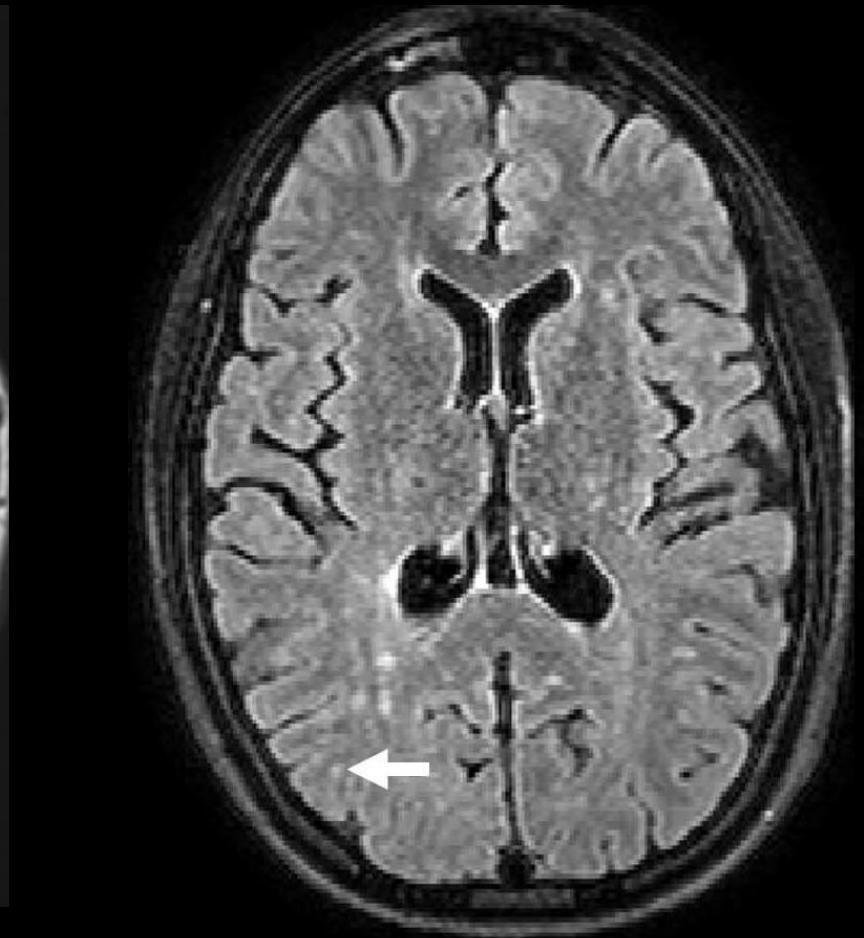
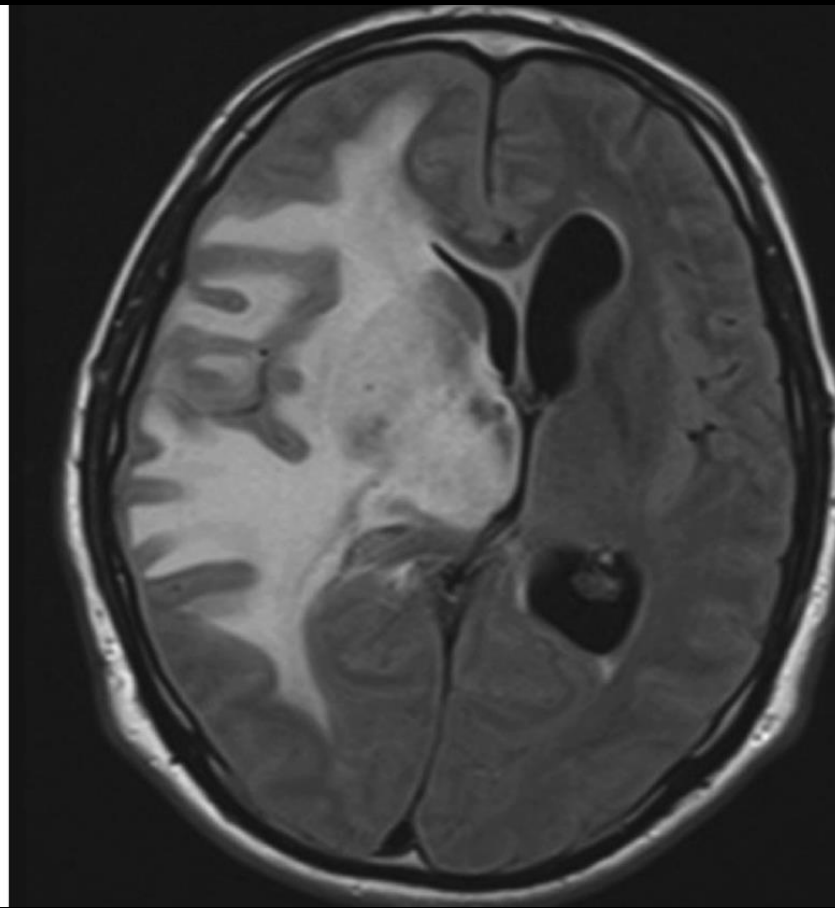
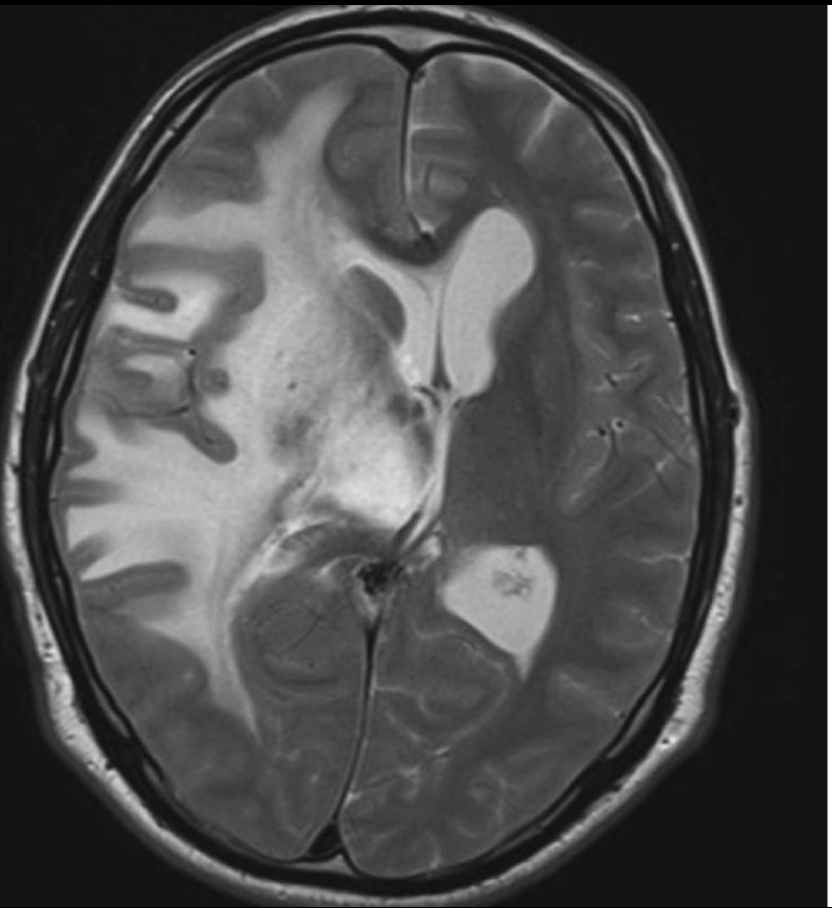



FLAIR/DIR



WATER SUPPRESSION (MAG TR)

- Bound water = very short T2 => does not contribute to the signal
- By saturation of bound water, even free water is saturated
- Exploitation:
- Background signal suppression (KL, TOF MRA)
- Quantification of the free/bound water ratio

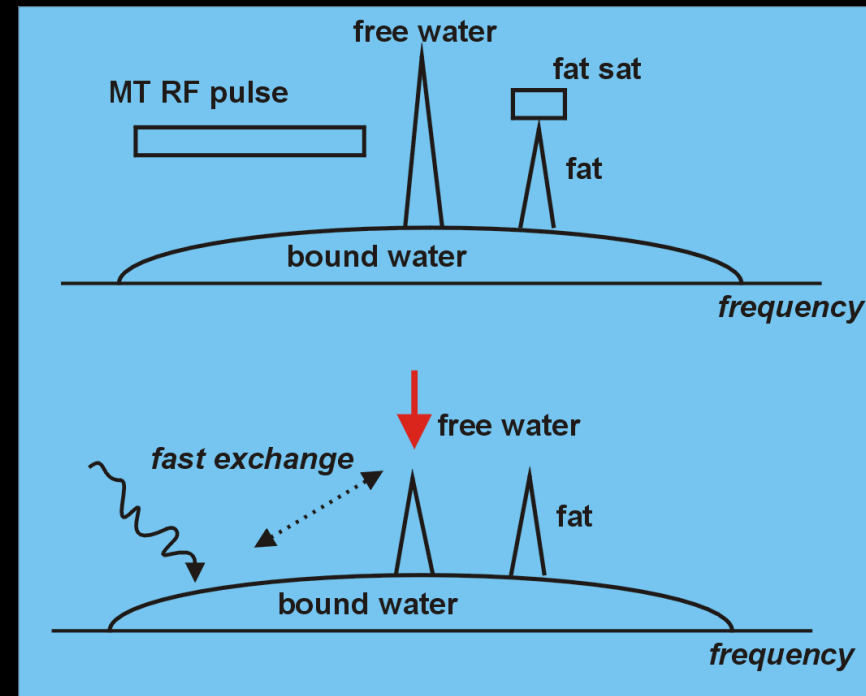

TOF MRA MT

3D TOF

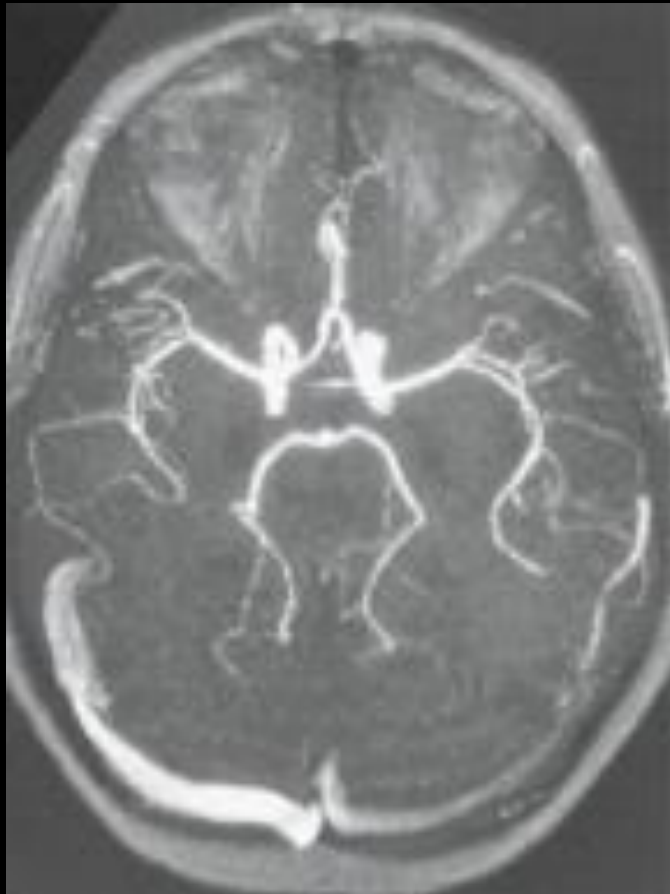

3D TOF + MT

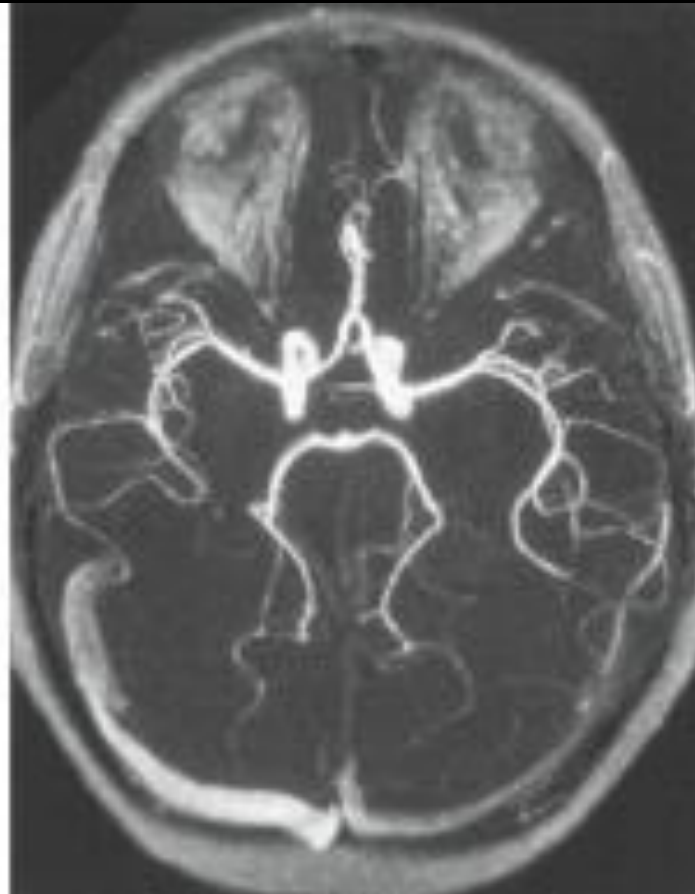

3D TOF + MT + FatSat

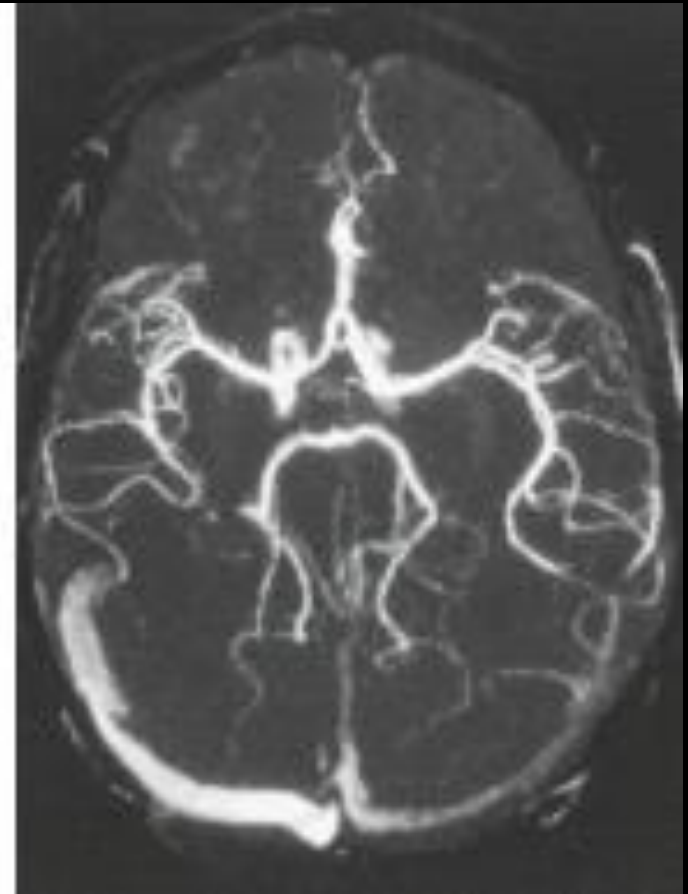

MT + GD KL

A



T1 MTC Gd

B

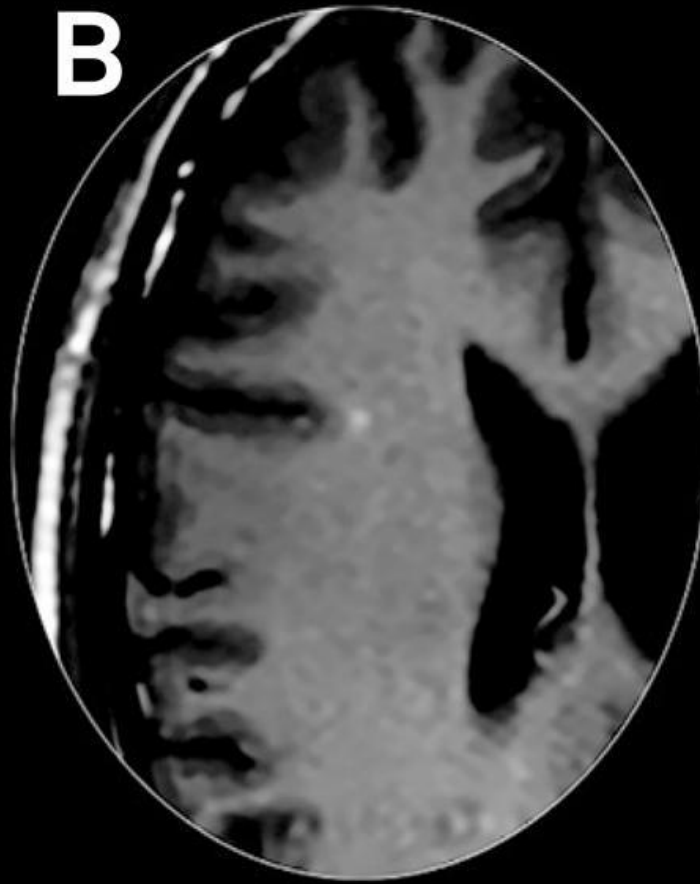

T1 SE Gd

C



T1 MPRAGE Gd

SEPARATION OF WATER AND FAT

- $IP = V + T$
- $OP = V - T$
- $IP + OP = V + T + V - T = 2V$
- $IP - OP = V + T - V + T = 2T$

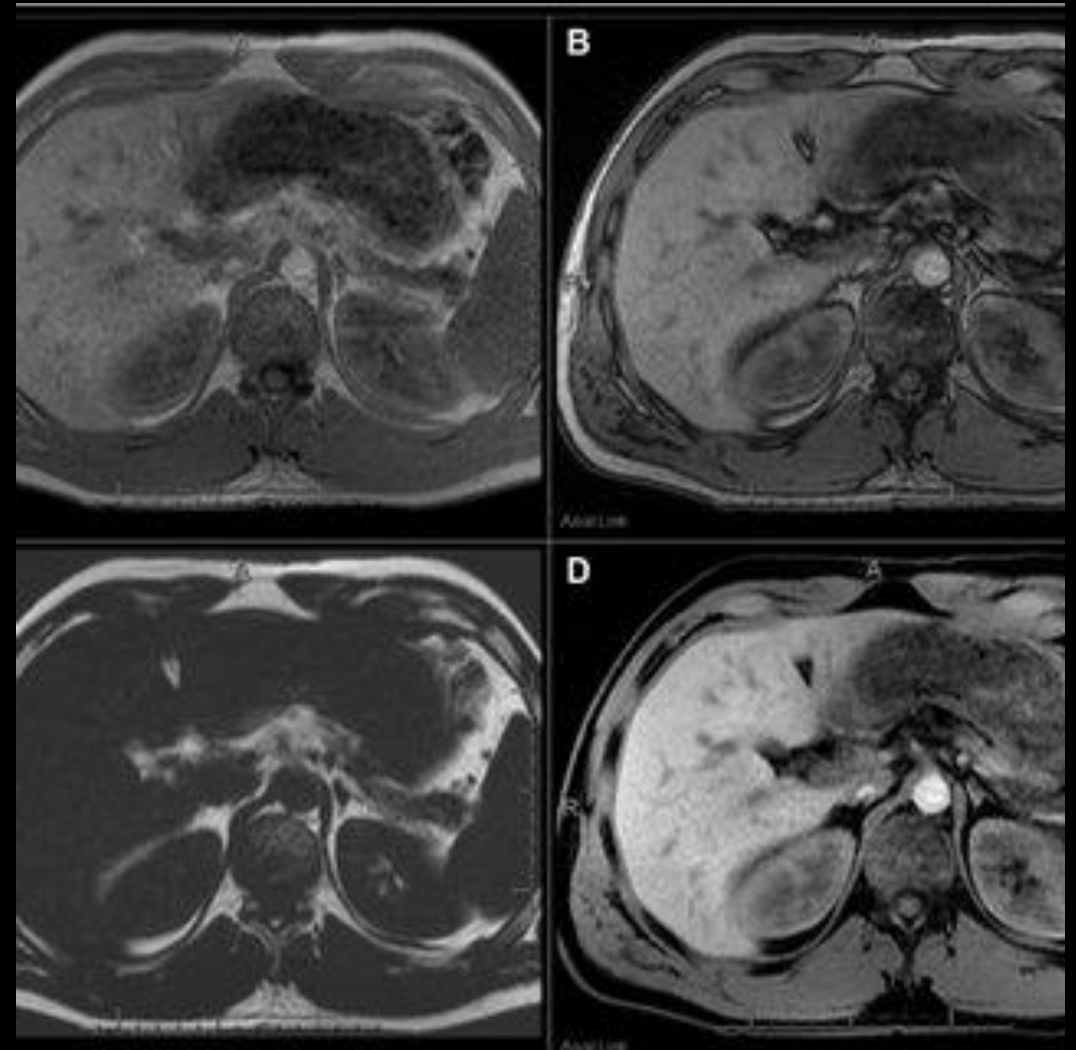
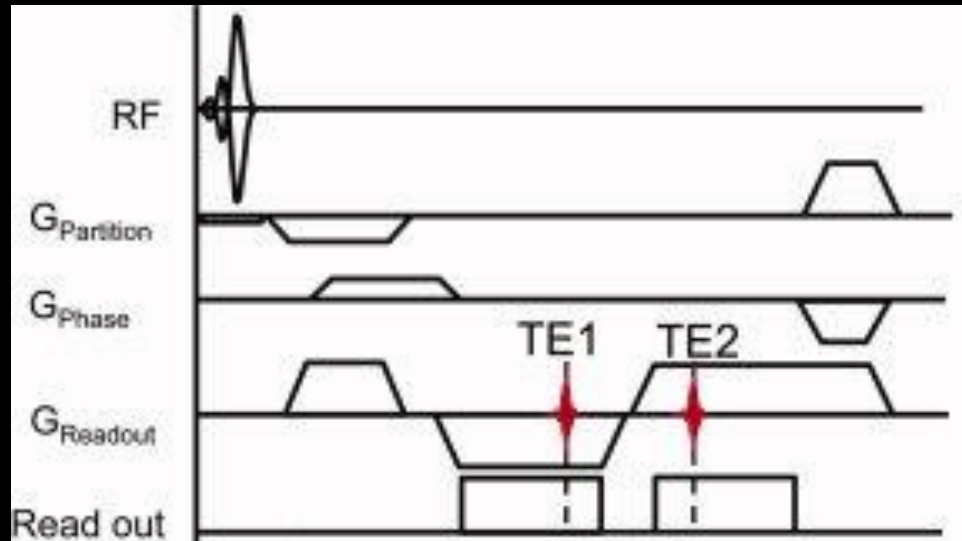

DIXON

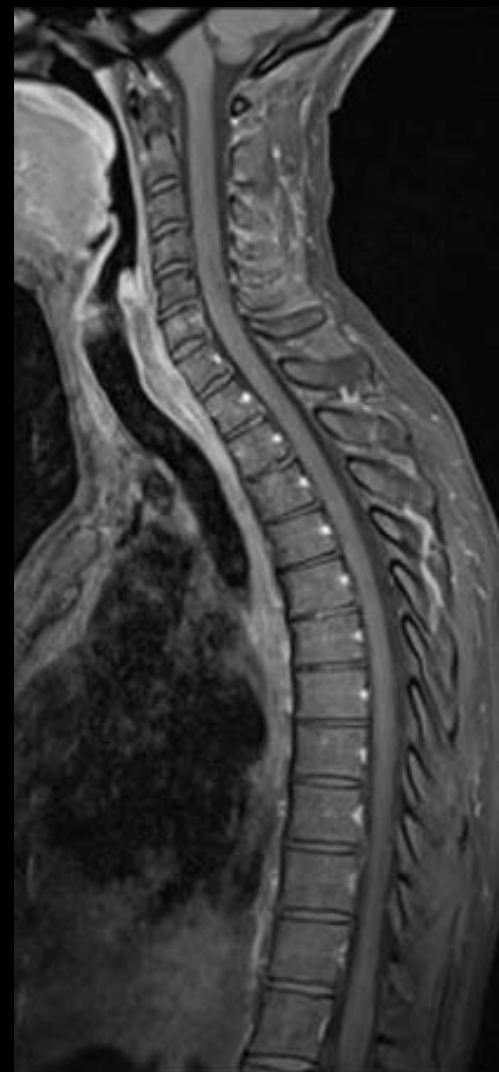
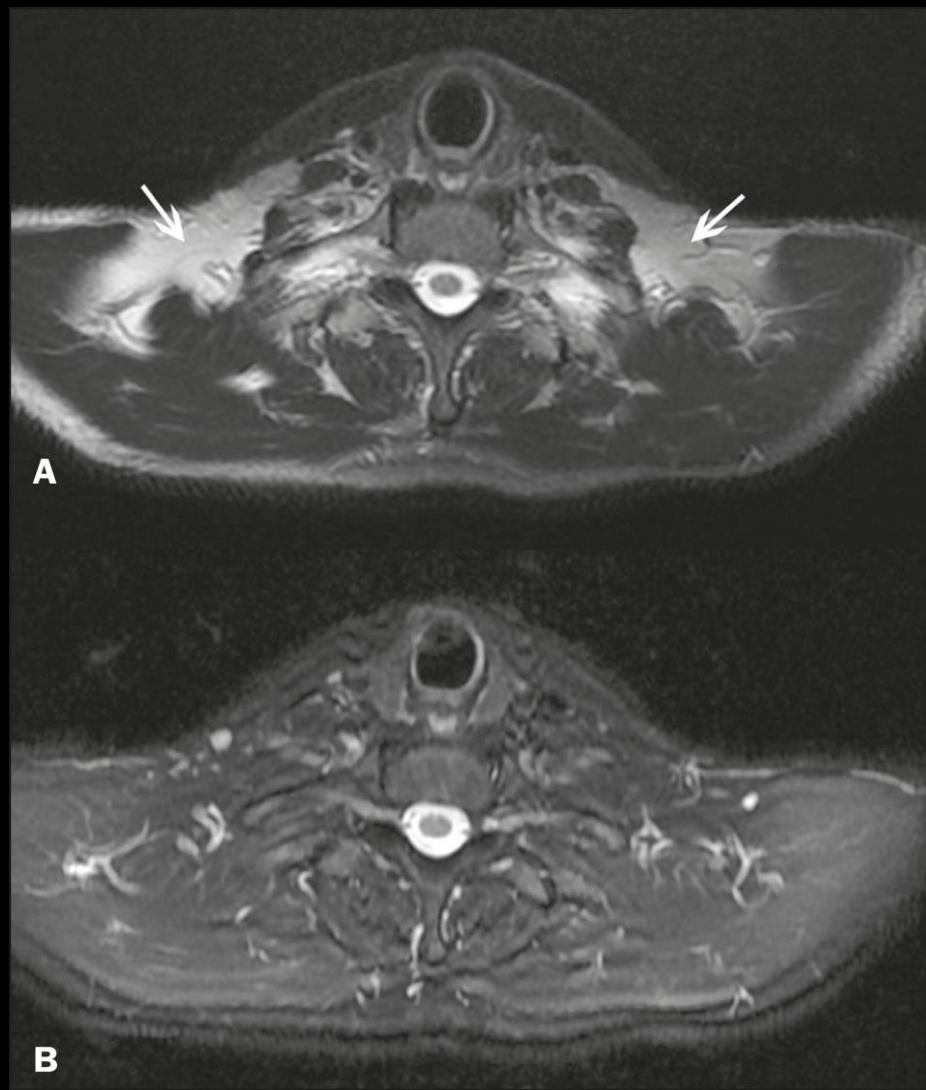

DIXON KVANTIFIKACE

- Multi-echo
- Multi-fat peak correction
- B0 correction
- T2* mapping
- Fat fraction
-

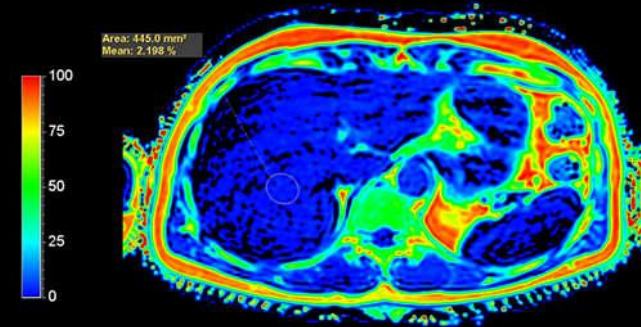

Healthy Volunteer

Fatty Liver

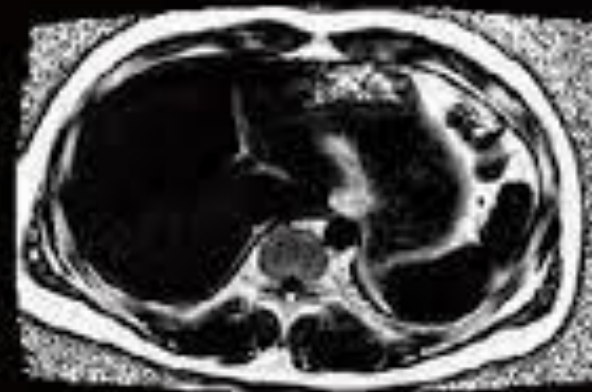

Liver Fat-fraction: 2%

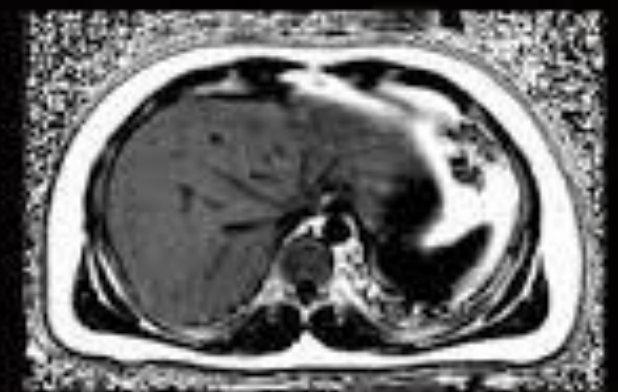

Liver Fat-fraction: 22%

WATER EXCITATION

- Using multiple RFs excites only H of water
- Less sensitive to mag inhomogeneities. fields than FatSat

• Models:

• (1 1) = 45° 45°

• (1 2 1) = 22.5° 45° 22.5°

• (1 3 3 1) = 10° 30° 30° 10°

• Higher model of larger exit

• Can change both TE and TR

•

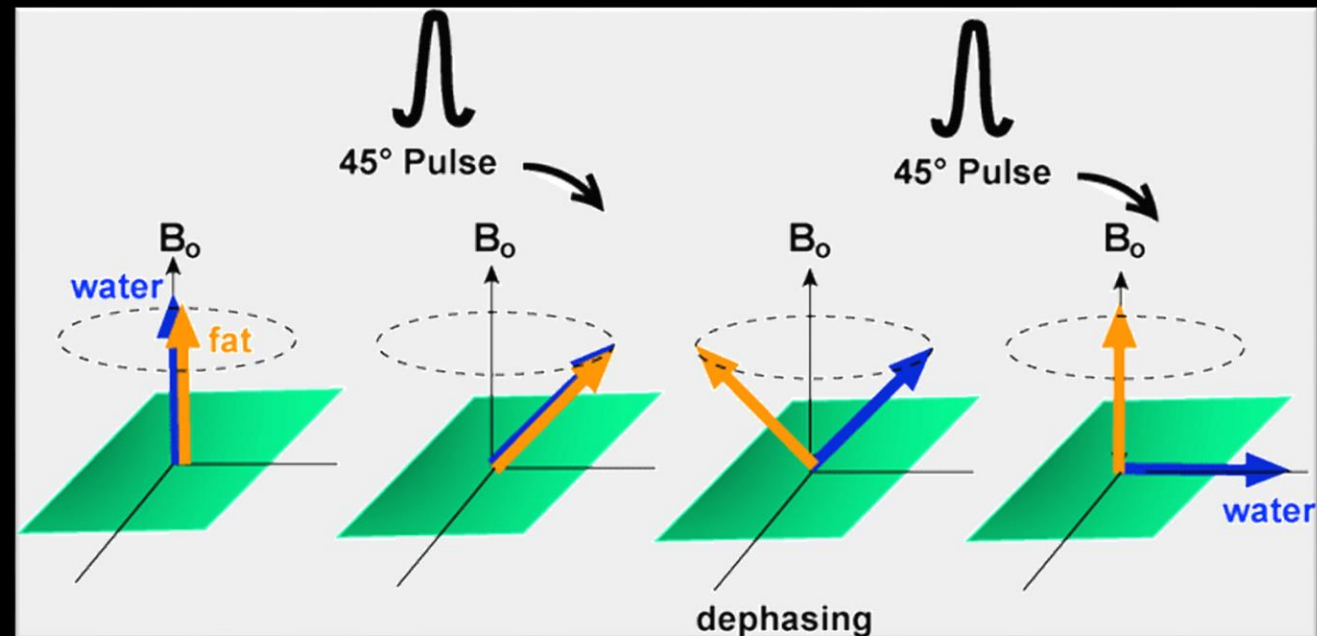

WATER EXCITATION



1 1

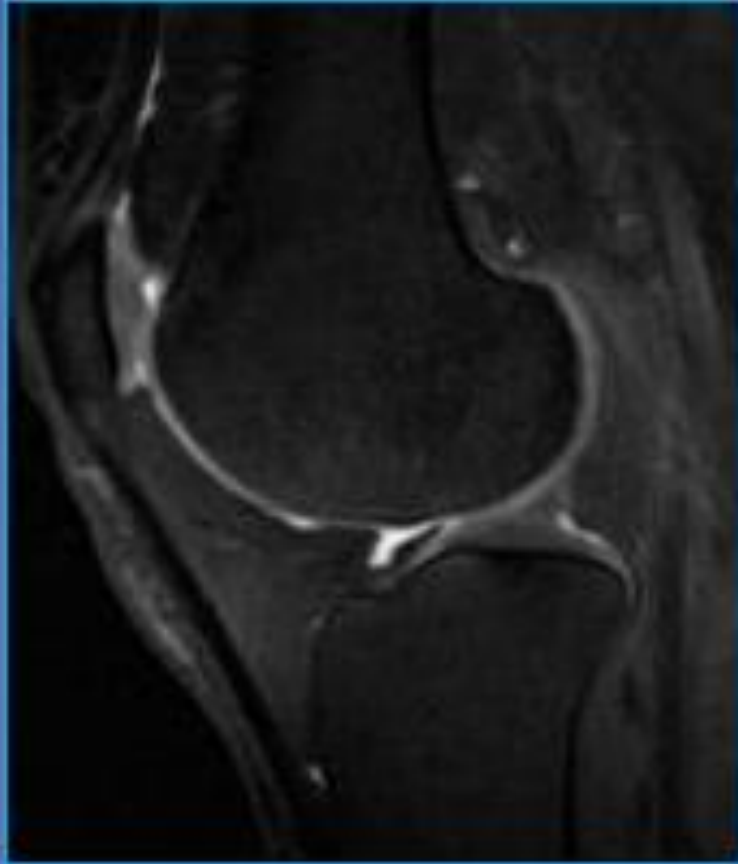

1 2 1

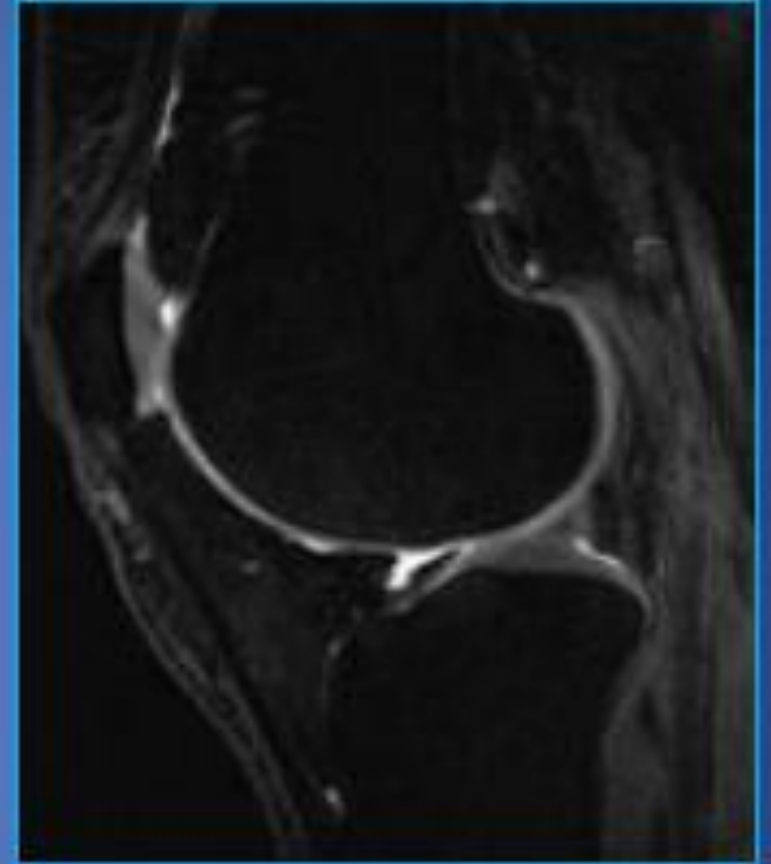

1 3 3 1

HARDWARE

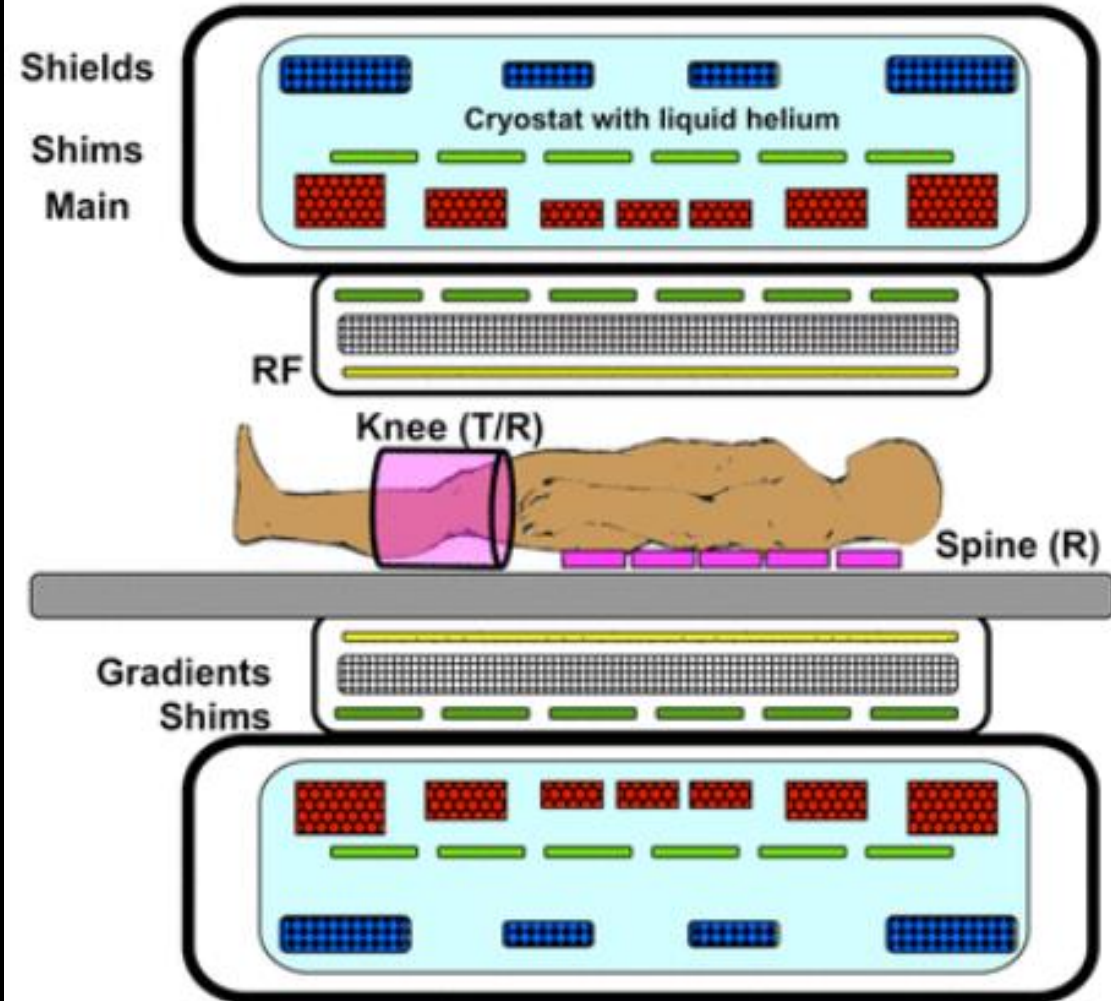
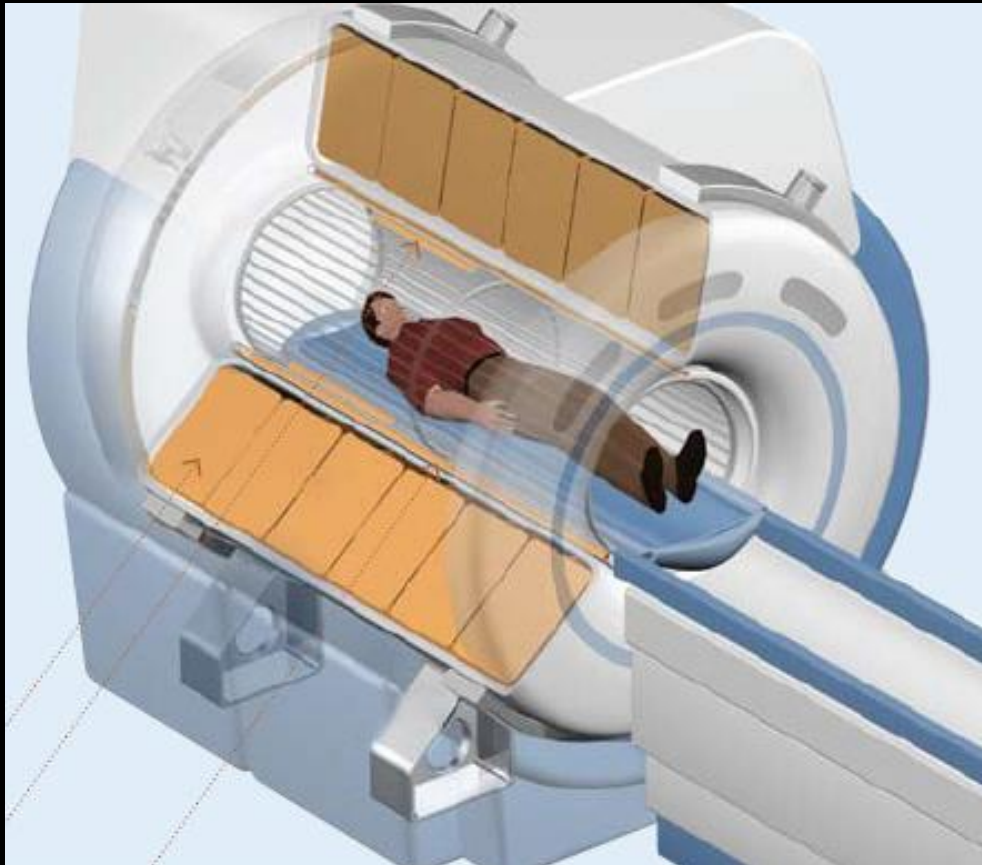



GE Signa 1.5T superconducting scanner

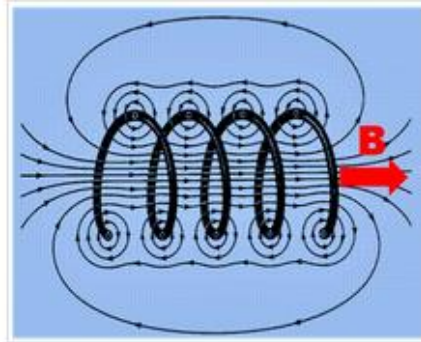

Magnetic field created by solenoid

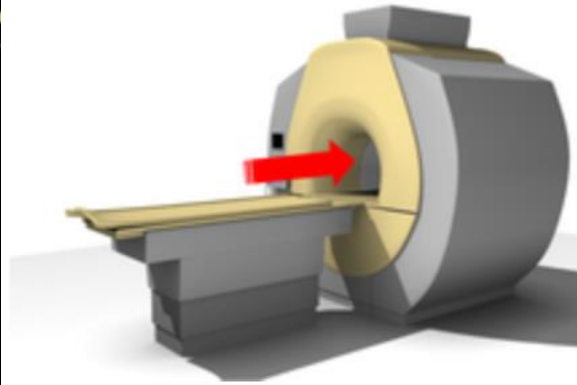

Hitachi Aperto 0.4T permanent magnet scanner

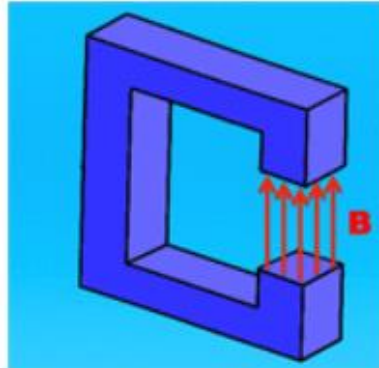

C-shaped permanent magnet

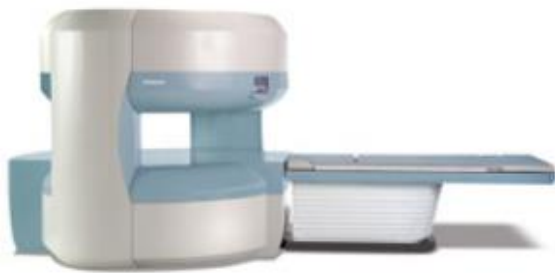

Hitachi Oasis 1.2T HFO superconducting scanner

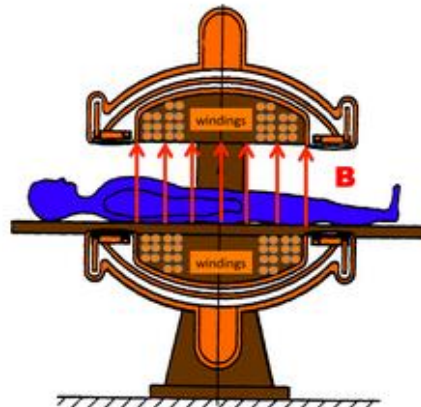

Dipolar electromagnet design



CONSTRUCTION



PERMANENT

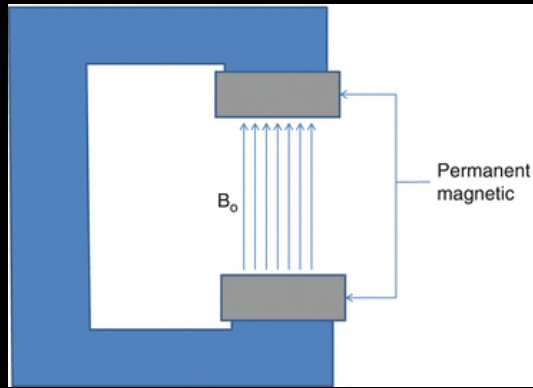

- Metal alloys (Fe77Nd15B8...)
- $B_0 = 0,1 - 0,3 \text{ T}$
- Advantages:
- Low purchase price
- Low operating costs
- Open
- Disadvantages:
- Weight (15 – 70 tons)
- Field stability very sensitive to temperature



- Elmag induction
- $B_0 = 0,1 - 0,4 \text{ T}$
- Advantages:
- Low purchase price
- Low weight
- Open and off
- Disadvantages:
- High power consumption ($\sim 50 \text{ kW}$)
- Field stability very sensitive to temperature

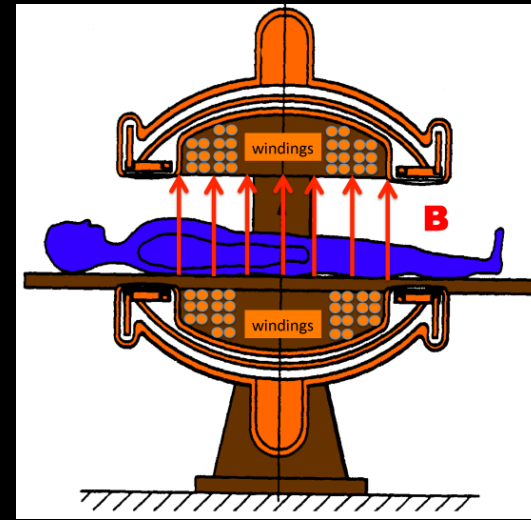

EL.MAG.



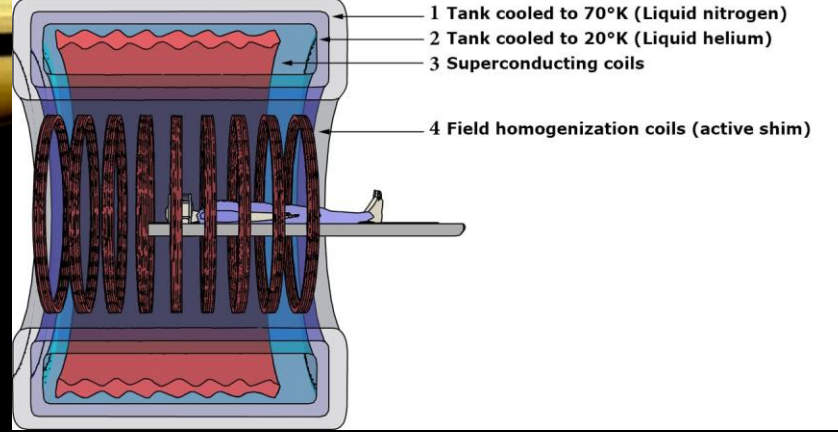

SUPRACOND.

- Elmag induction + liquid he cooling
- $B_0 = 0,5 - 7 \text{ T}$
- Advantages:
- Image quality
- Stability mag. field
- Disadvantages:
- Acquisition costs
- Can't be turned off
-



FIELD STRENGTH

- At a larger B0
- Growing S/W
- Growing T1 time
- Growing SAR (ERF ~ B0²!!!)
- The effect of susceptibility grows
- Growing noise
- Rising price
- Image homogeneity decreases
- Decreasing T2* time

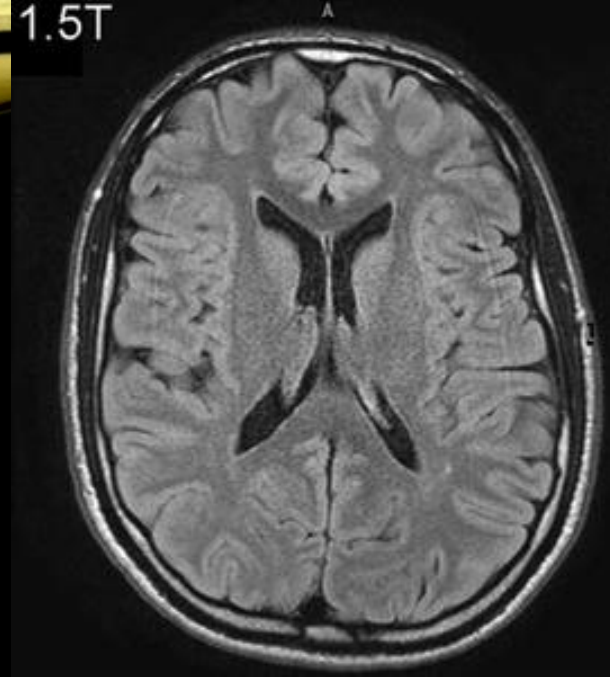

3T

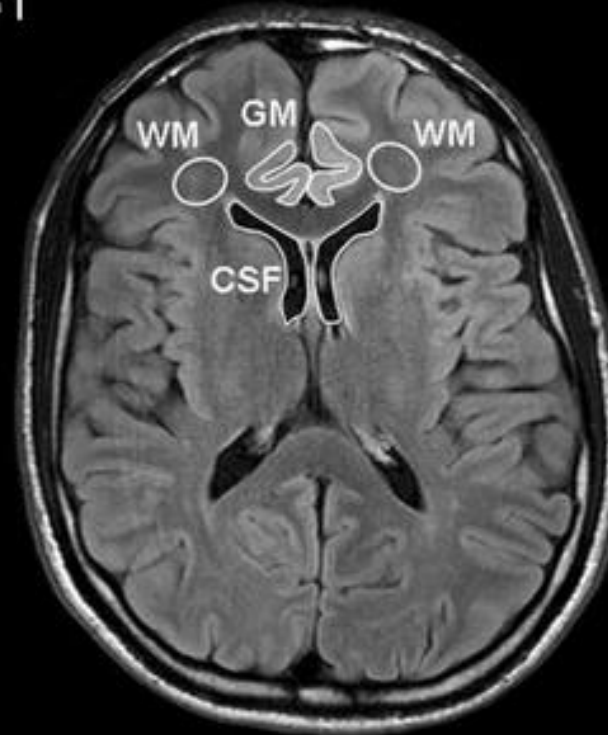

7T

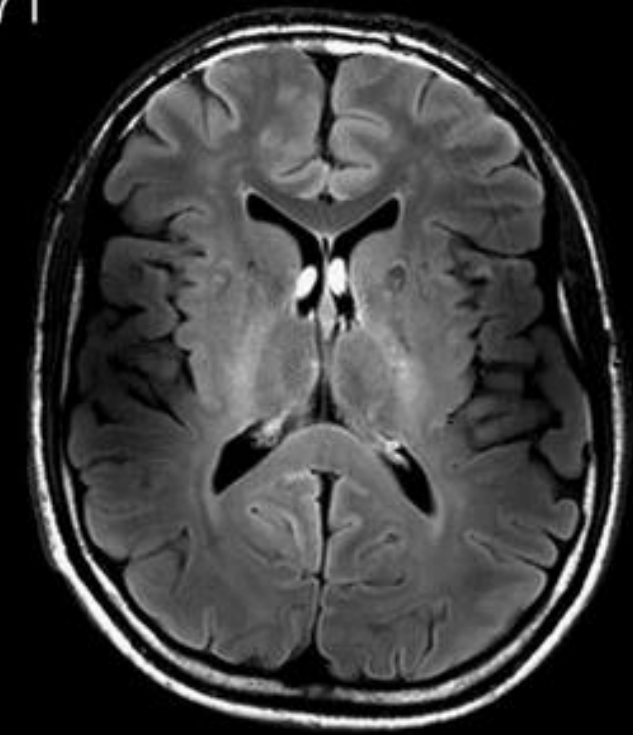

FIELD STRENGTH

1.5T

3T

7T

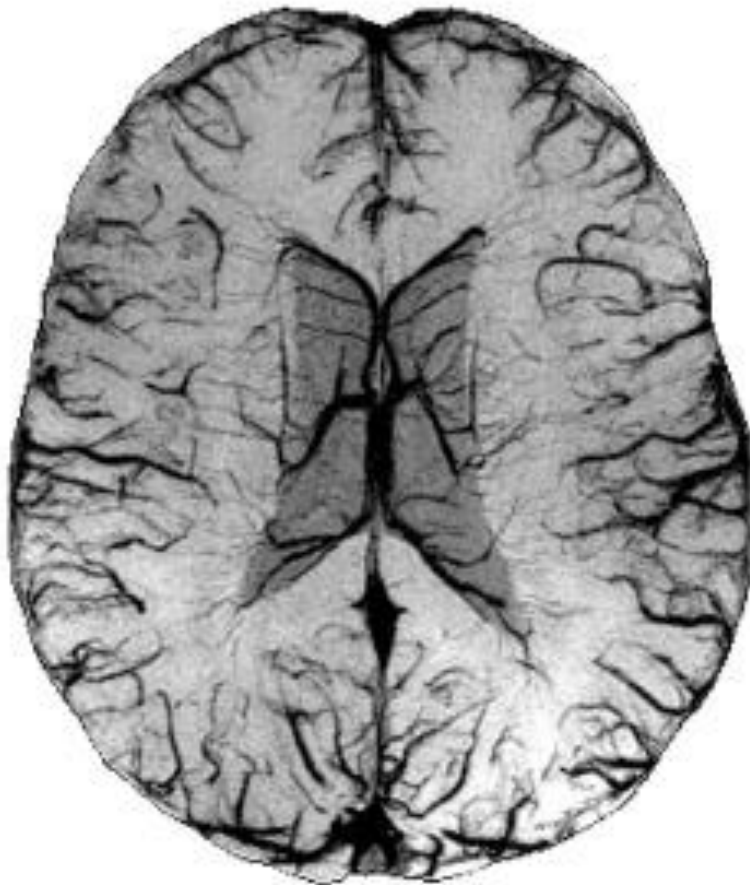

- Spatial information
- Parameters:
- Max. amplitude (20 – 80 mT/m)
- Slew rate (80 – 200 mT/m/ms)
- Linearity
- Amplitude ~ Prost. distinguish
- Slew rate ~ T_{Emin} , T_{Rmin} ...
-

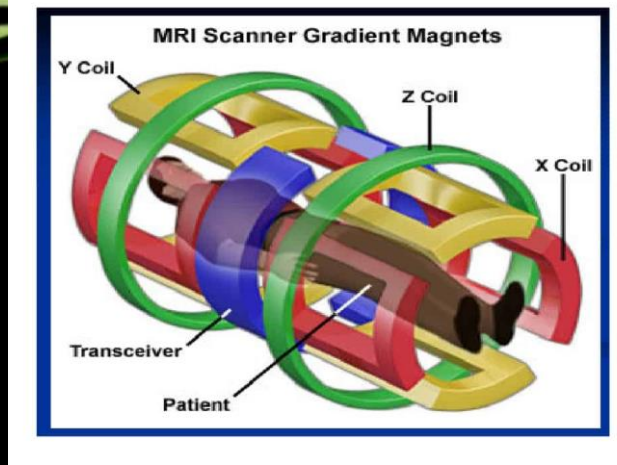

GRADIENTS

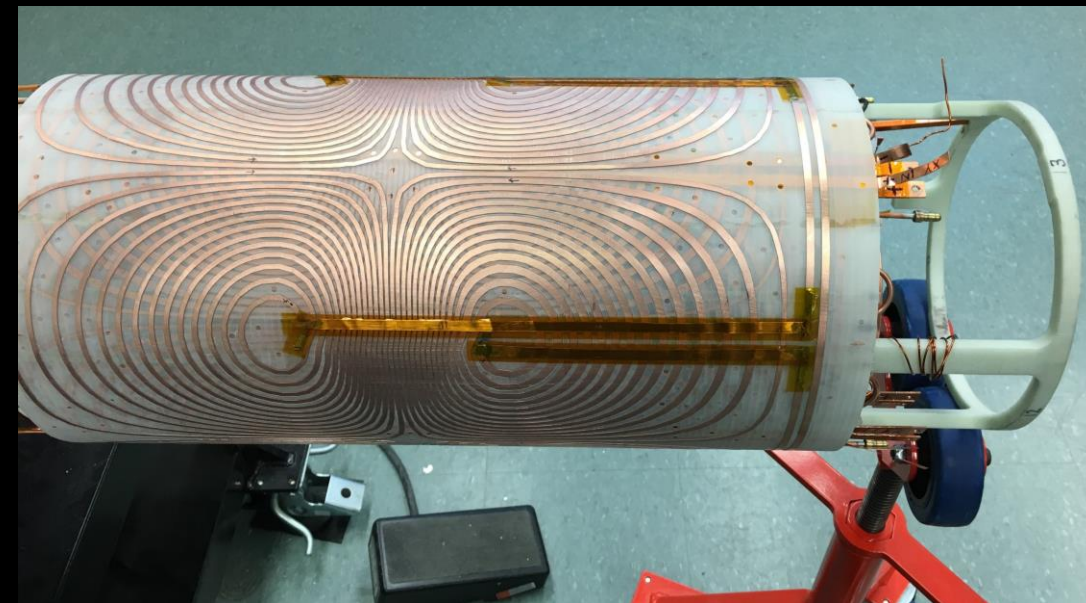
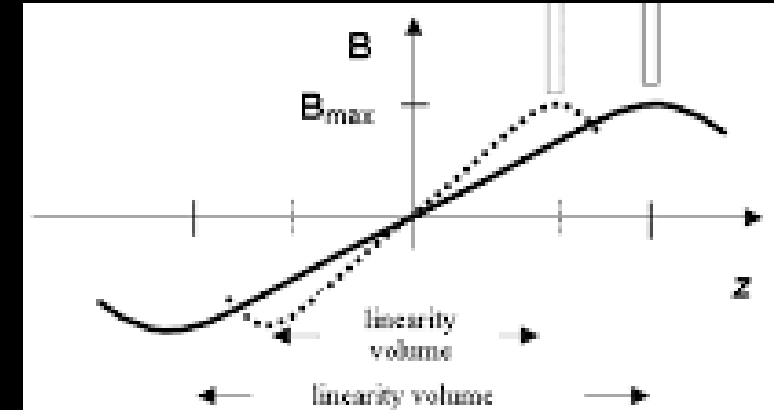

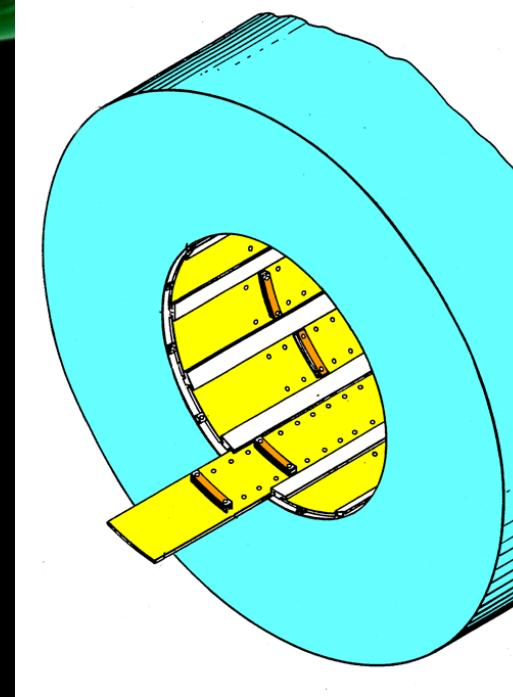

SHIM

- Correction of inhomogeneity mag. field
- Passive/Active
- Minimizing geometric distortion
- Maximizing the signal thanks to the ideal Larmor. frequency
- Better FatSat, MRS, EPI, fMRI...

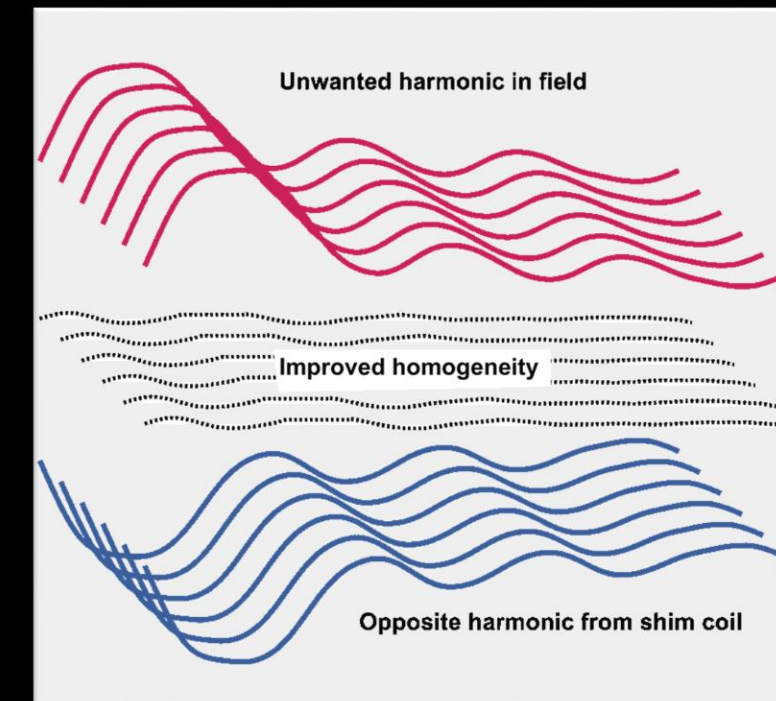

- Broadcast vs Receiving
- Full body
- T/R, worse S/W
- Surface
- Closer to the body => better S/W
- Dedicated according to ant. areas
- Multi-segment
- Multiple coils in one block
- Coverage of larger areas
- Enable advanced techniques
- Greater signal inhomogeneity



RF COILS

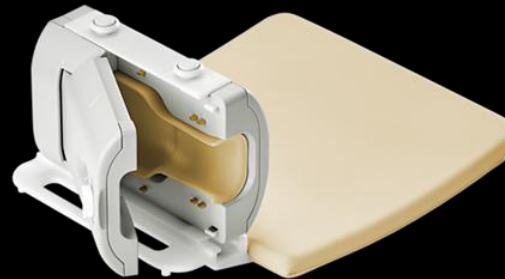

MULTI TRANSMIT

- Larger $B_0 \Rightarrow$ shorter waves. Length \Rightarrow greater signal inhomogeneity

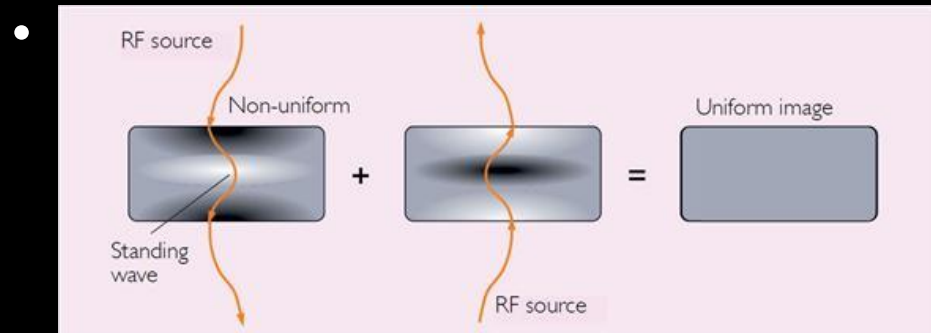

Conventional

Multi Phase Transmit

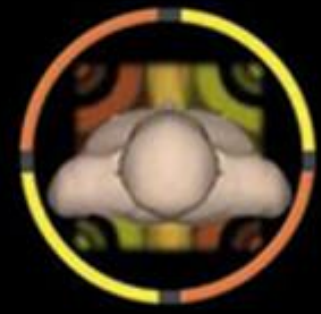
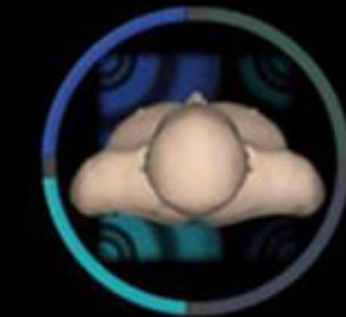

2D EXCITATION

- 2D spatially selective RF
- Display of small/"rectangular" organs

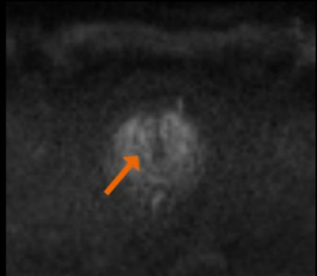

Conventional DWI
b 50, 1000, 1500, ADC
2.1 x 2.1 x 3 mm³
TR/TE 4600 / 79 ms
TA 3:23 min

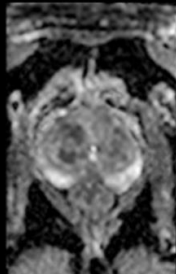
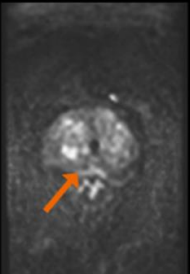

ZOOMit^{PRO1}
b 50, 1000, 1500, ADC
0.95 x 0.95 x 3 mm³
TR/TE 4600 / 79 ms
TA 3:29 min

T2-weighted TSE full-FOV DW-EPI reduced-FOV DW-EPI

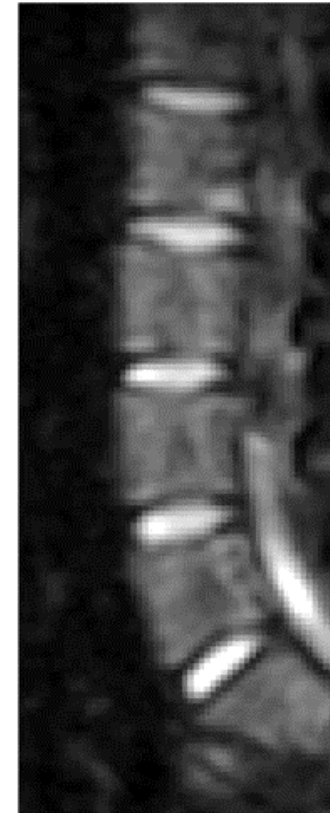
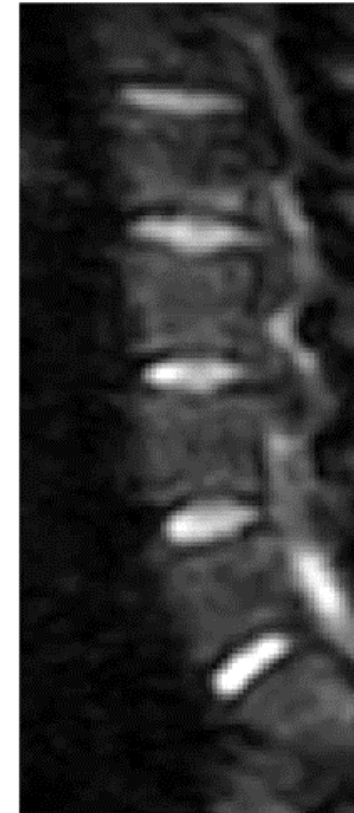

PARALLEL TECHNIQUES

- Discarding k-space rows
-

To gain speed you must reduce the number of phase encoding steps

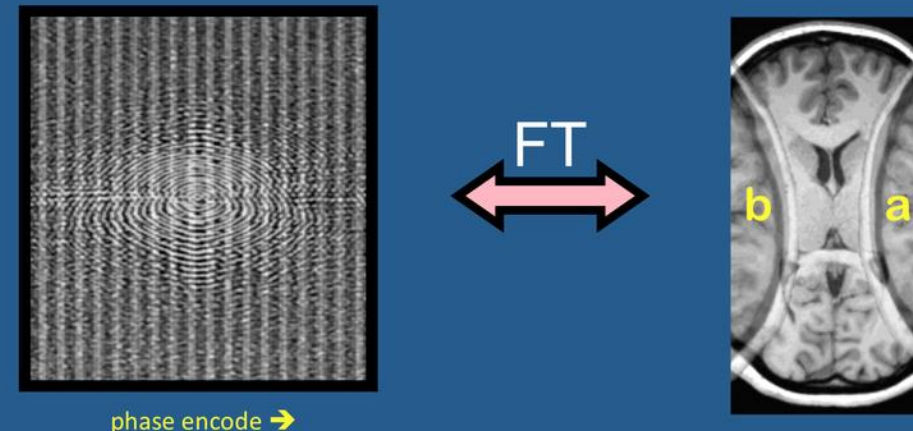
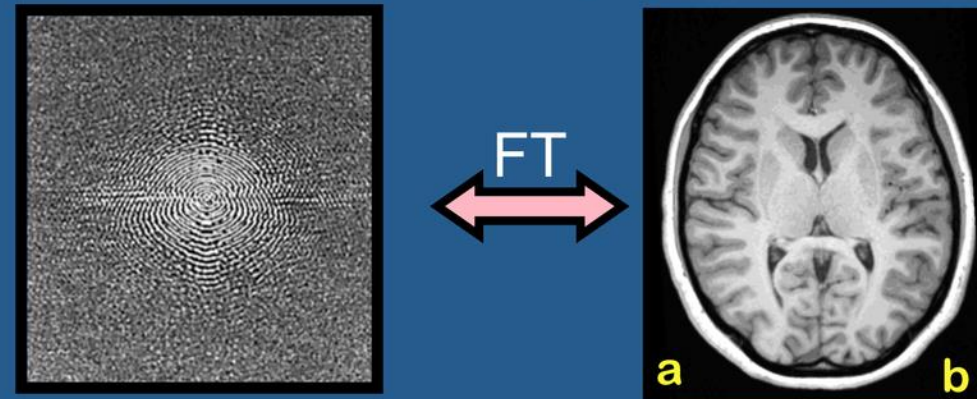

phase encode →

But you then get reduced FOV and wrap-around artifact (aliasing)

SENSE/ASSET

- Requires calibration
- 1. Reconstruction, then correction

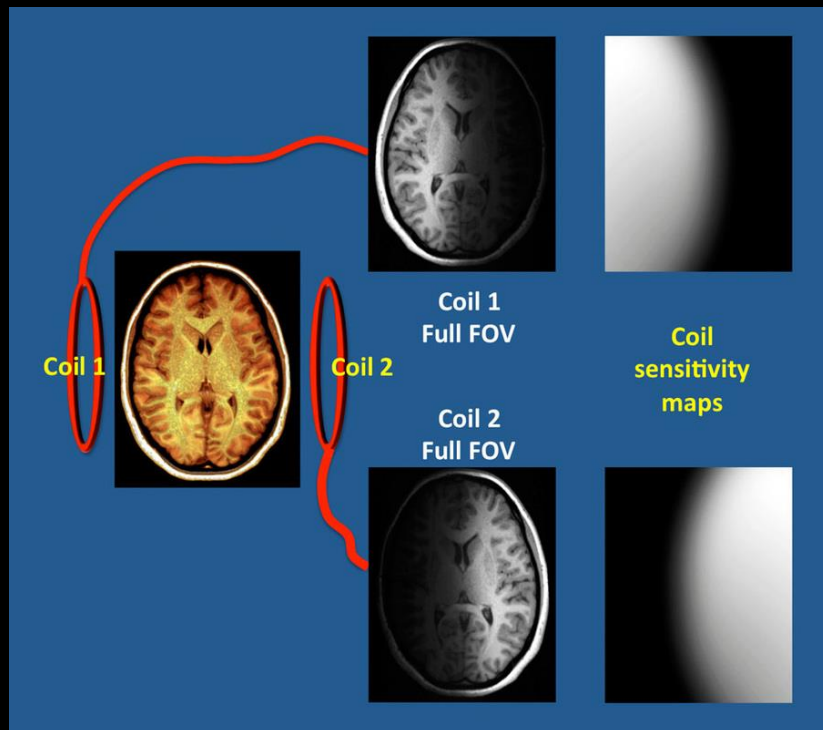
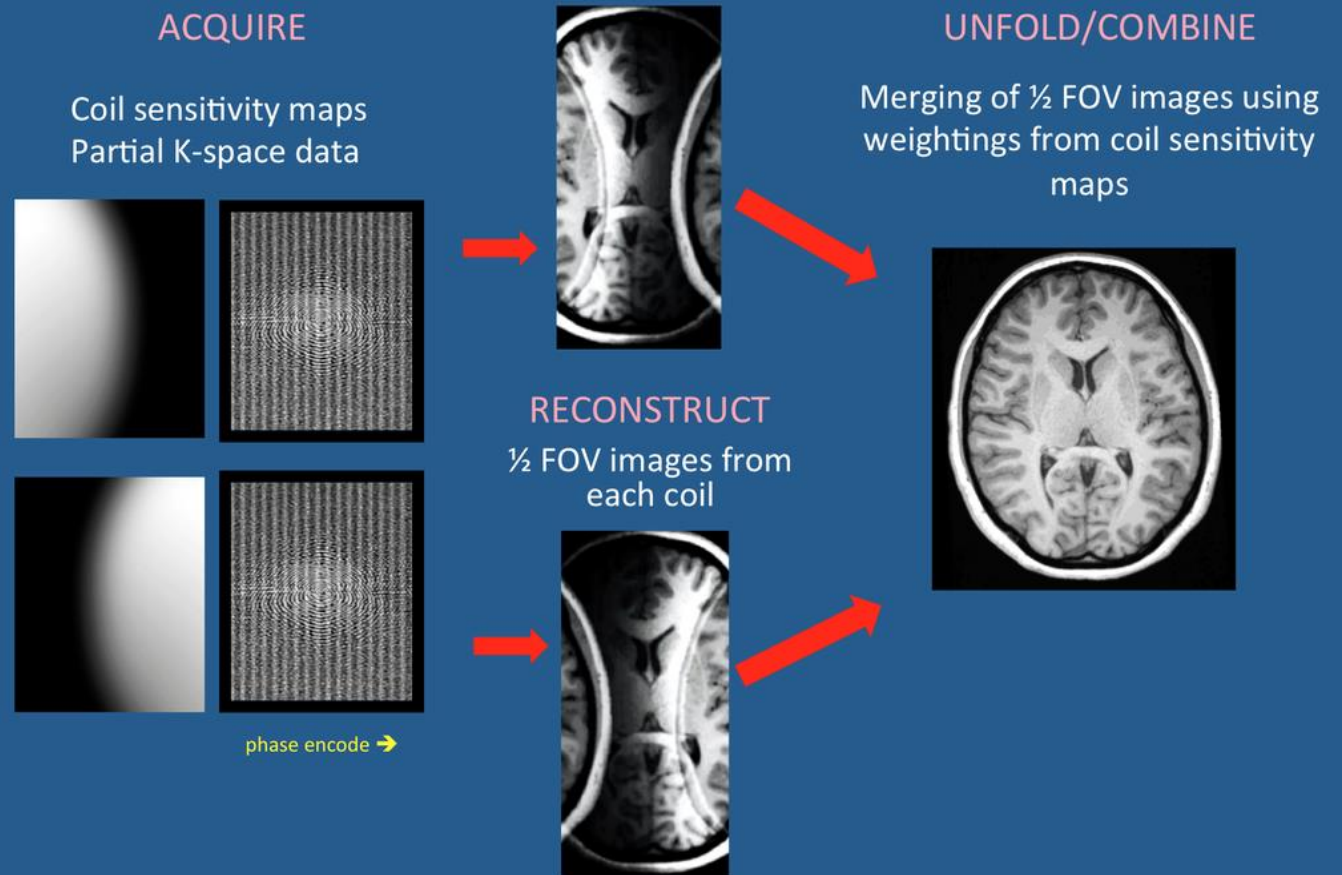
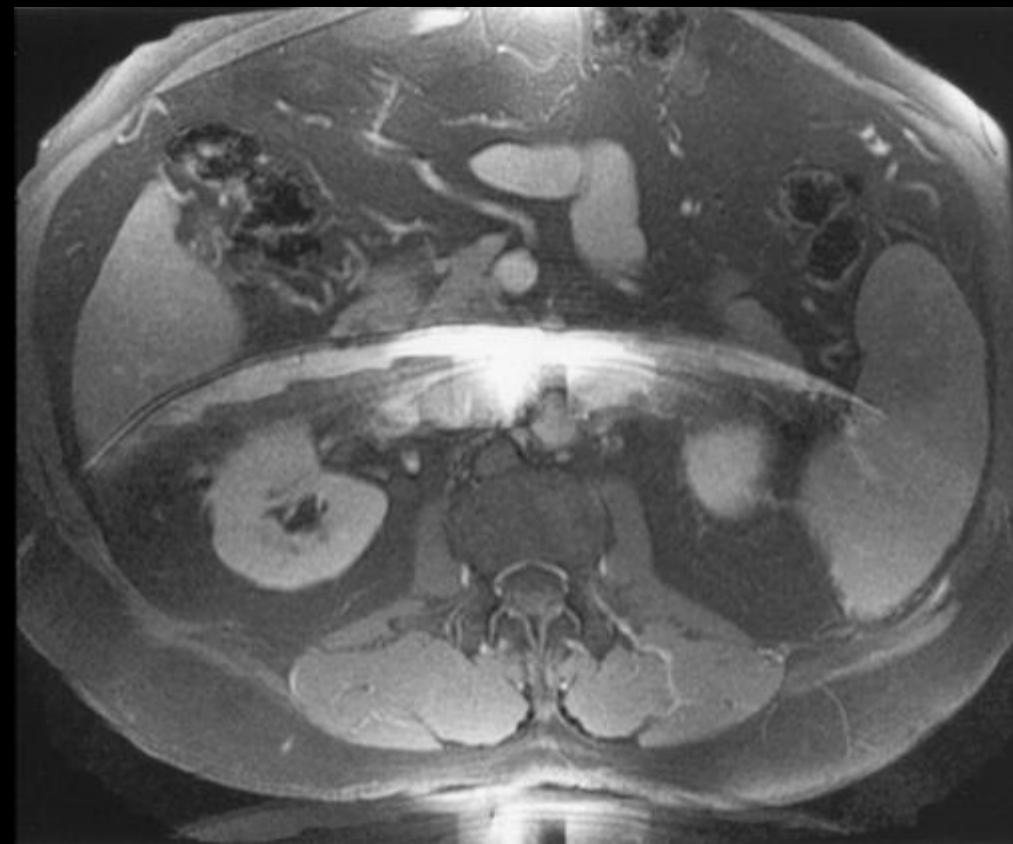
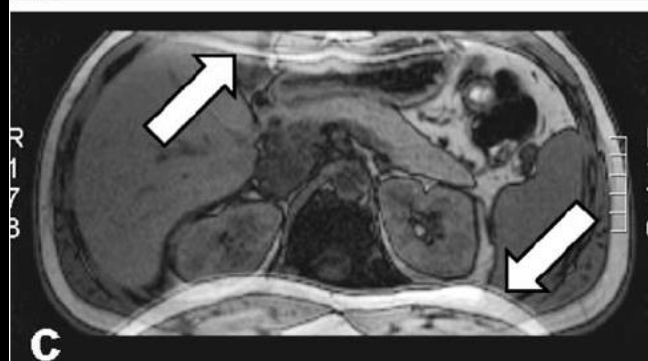
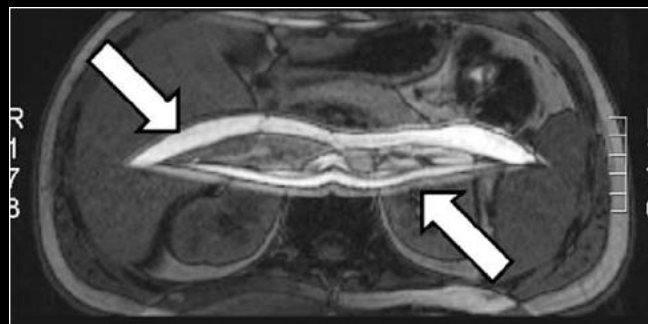

Image-Based PI: SENSE, ASSET



SENSE/ASSET

- Artifact
-



ARC/GRAPPA

- No need for calibration
- 1. Correction, then reconstruction
- Center without deleting columns
-

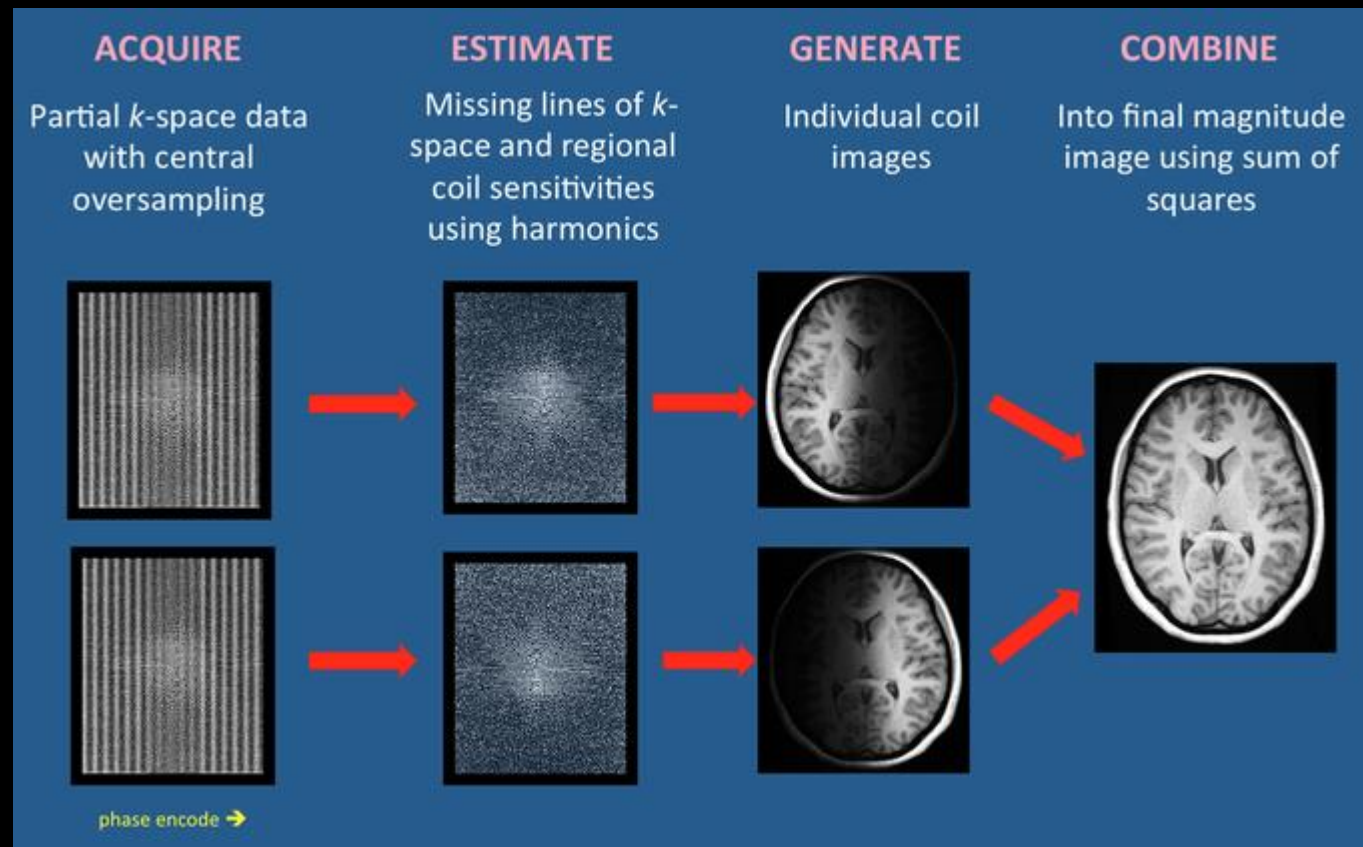

ARTEFACTS

- Inhomogeneity B0
- Misaligned machine
- Metal object
- Difference of susceptibility

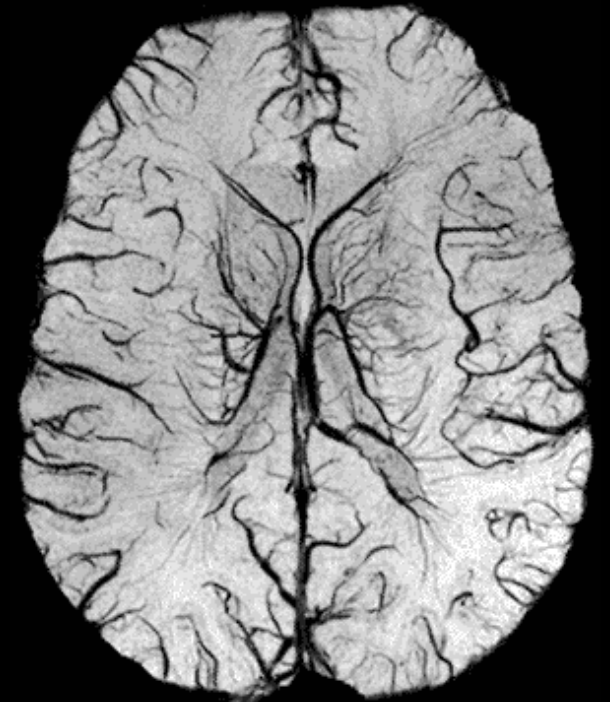
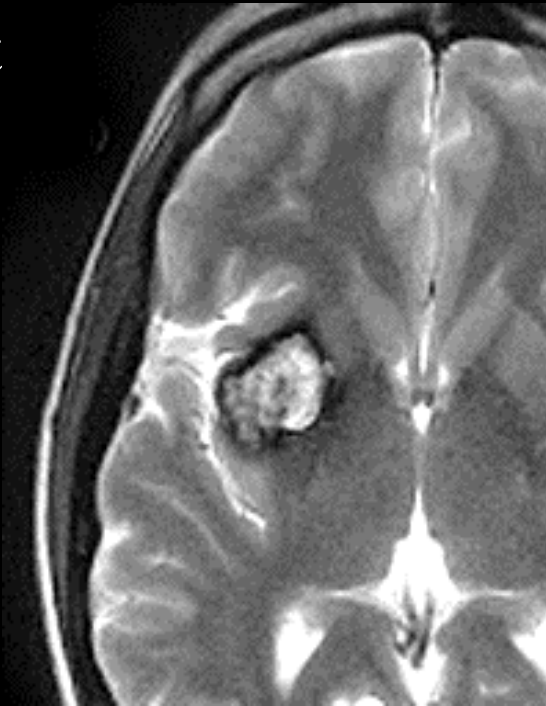
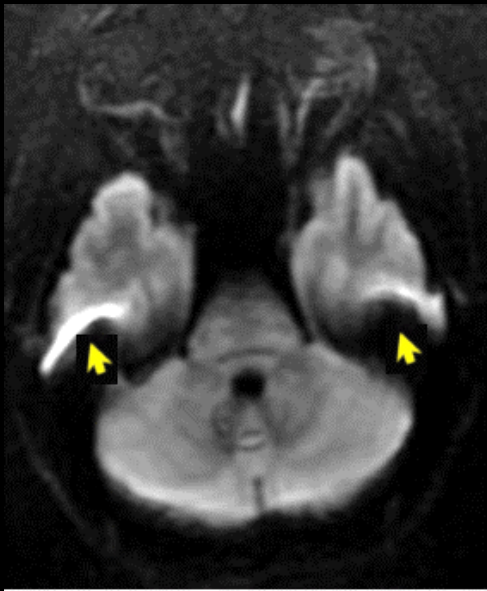
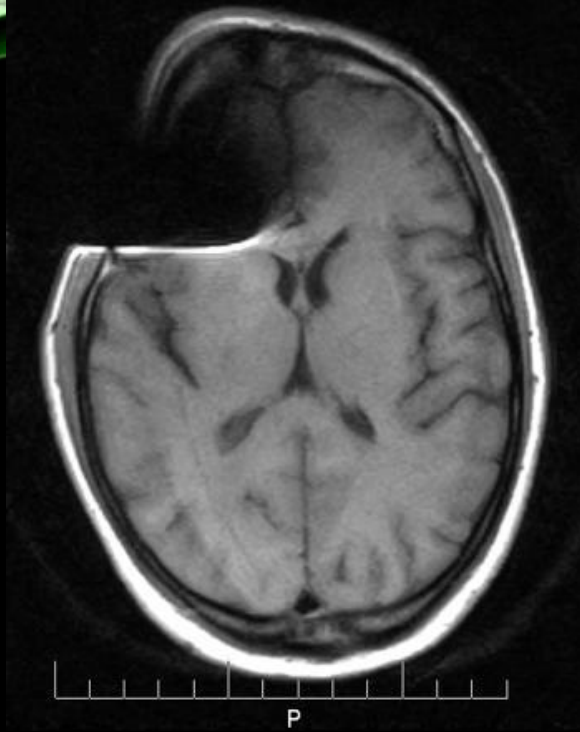

ARTEFACTS

- Inhomogeneity B1
- Local inaccuracy of the RF pulse angle
- Inhomogeneity of the received signal (coil surface)

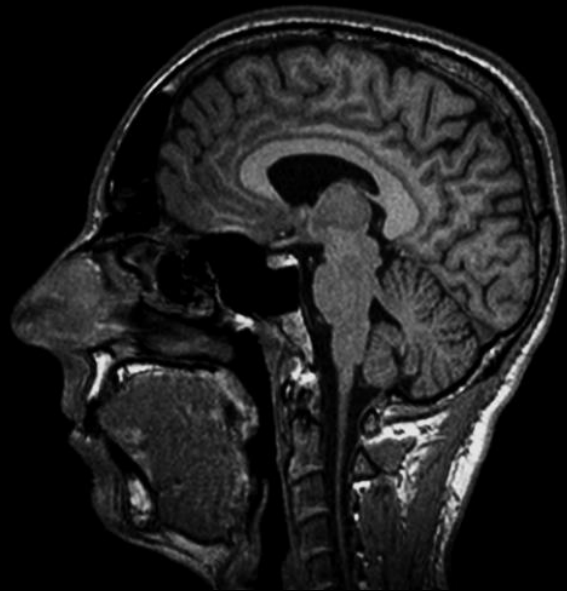

1 kanálová

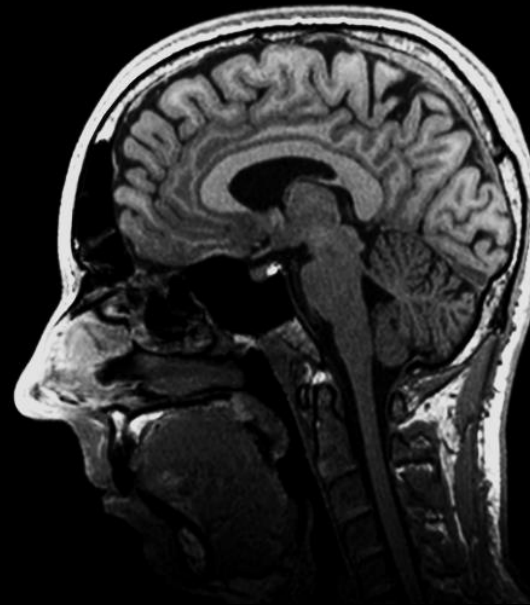

Multi-kanálová

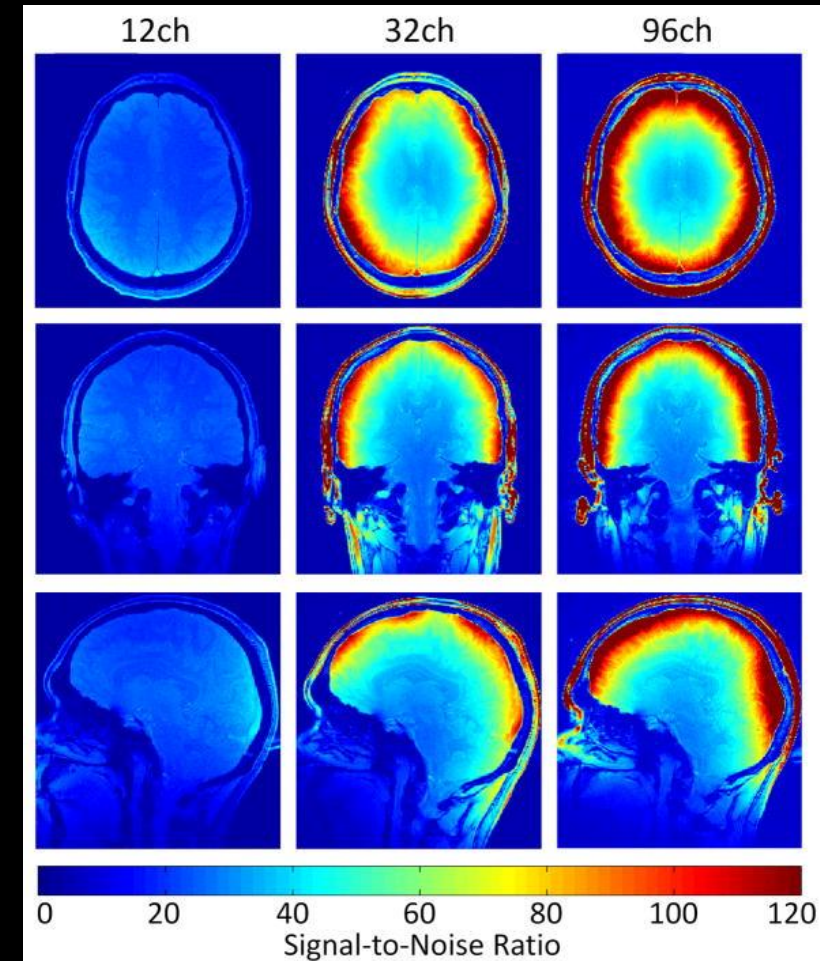

ARTEFACTS

- Inhomogeneity B1
- Dielectric effect
- Wavelength in body ~ 25cm (3T)

Conventional

Multi Phase Transmit

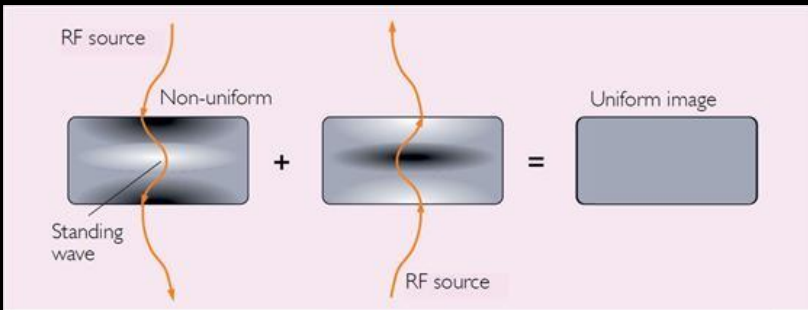
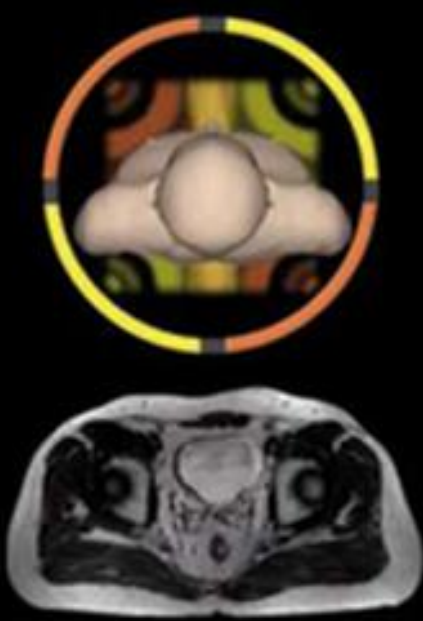
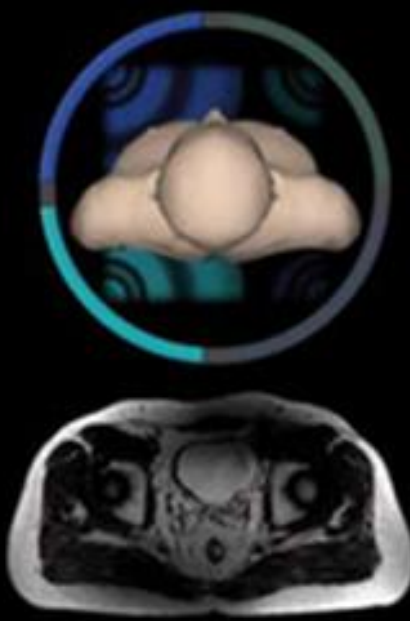

FLAIR 7T

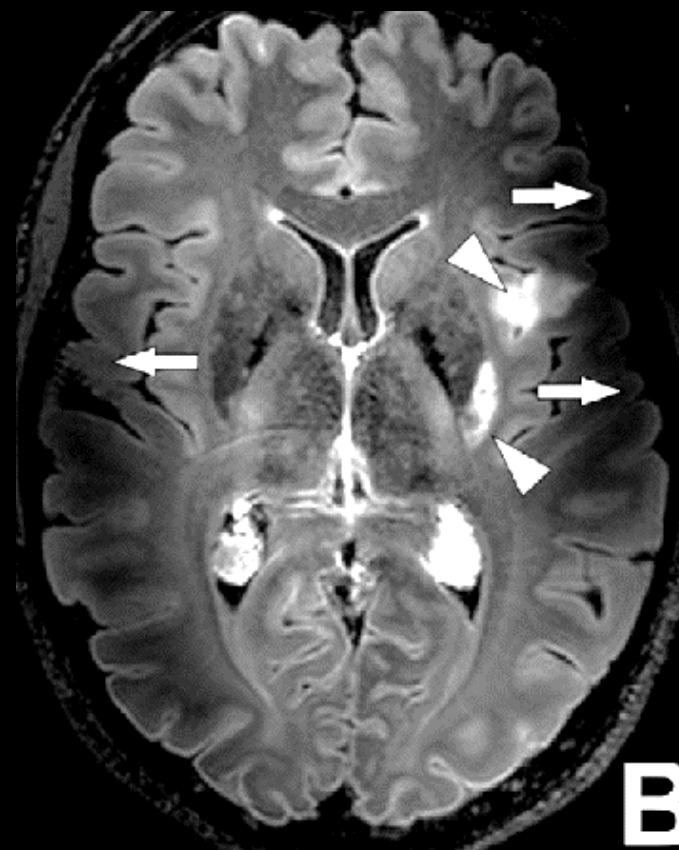

B

ARTEFACTS

- Inhomogeneity B1
- Poor fat saturation

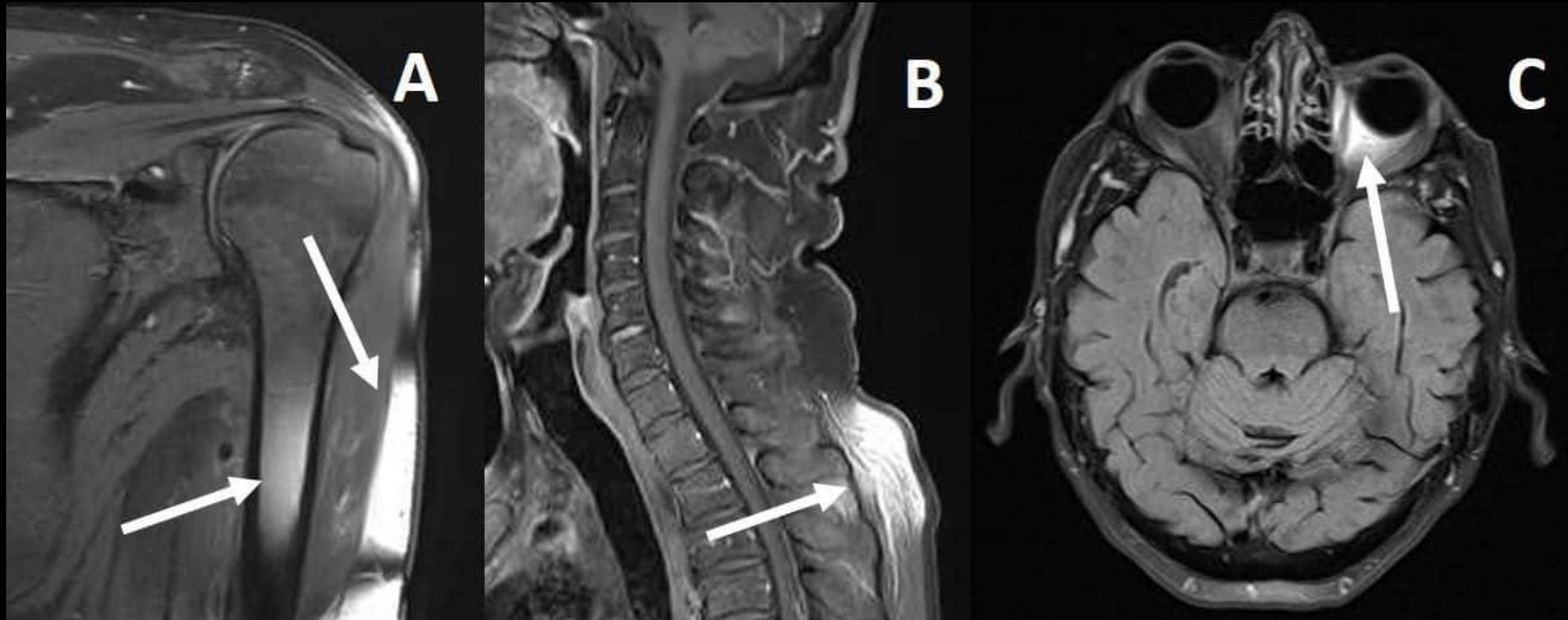

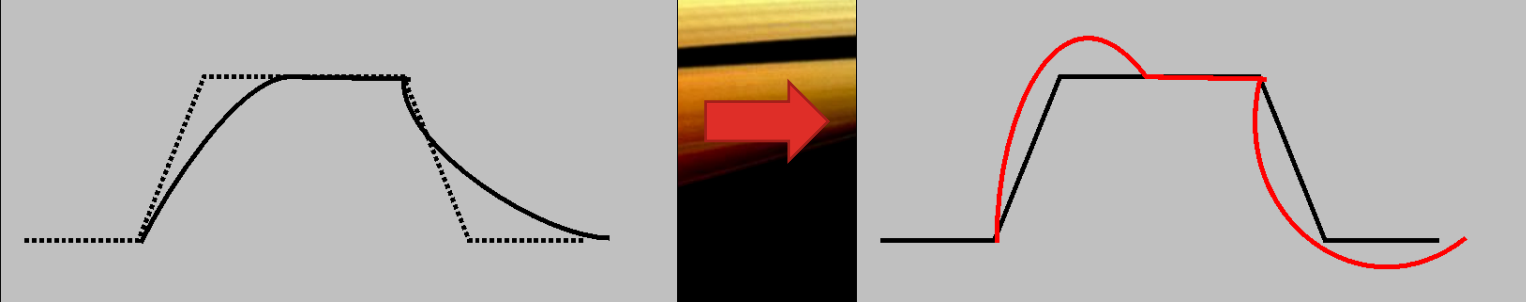

ARTEFACTS

- Imperfection of gradients
- Geometric distortion

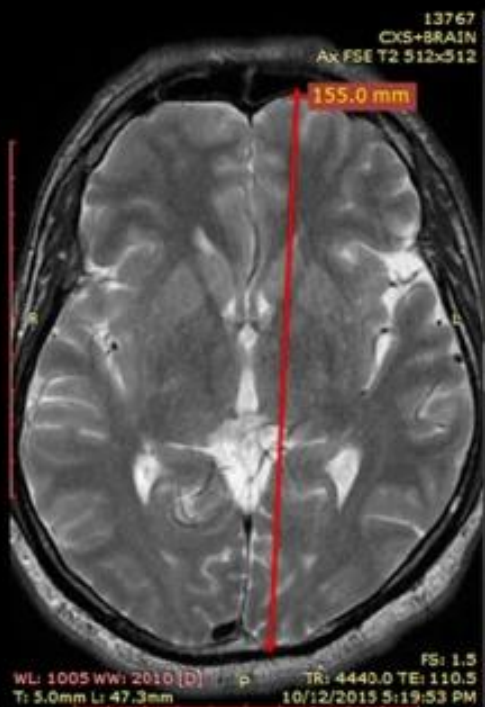

A

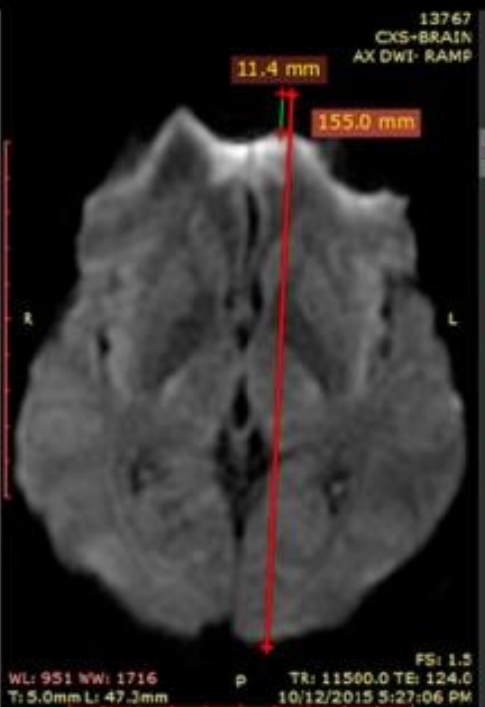

B

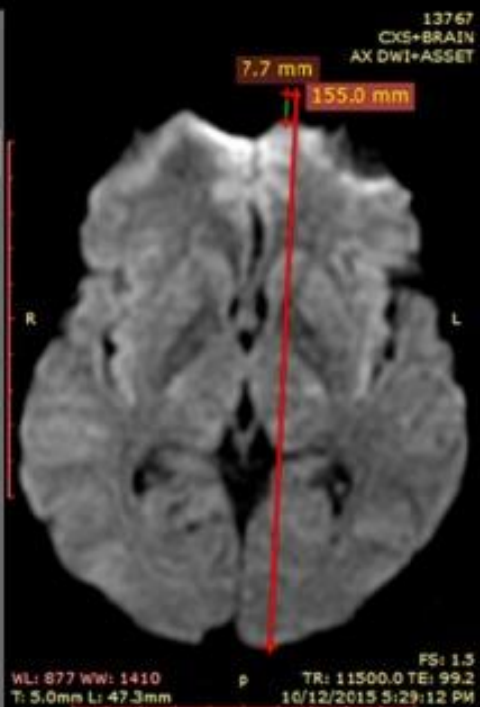

C



ARTEFACTS

- Imperfection of gradients
- Circular artifacts



ARTEFACTS

- Movement, flow
- Poor localization of signal phases
-

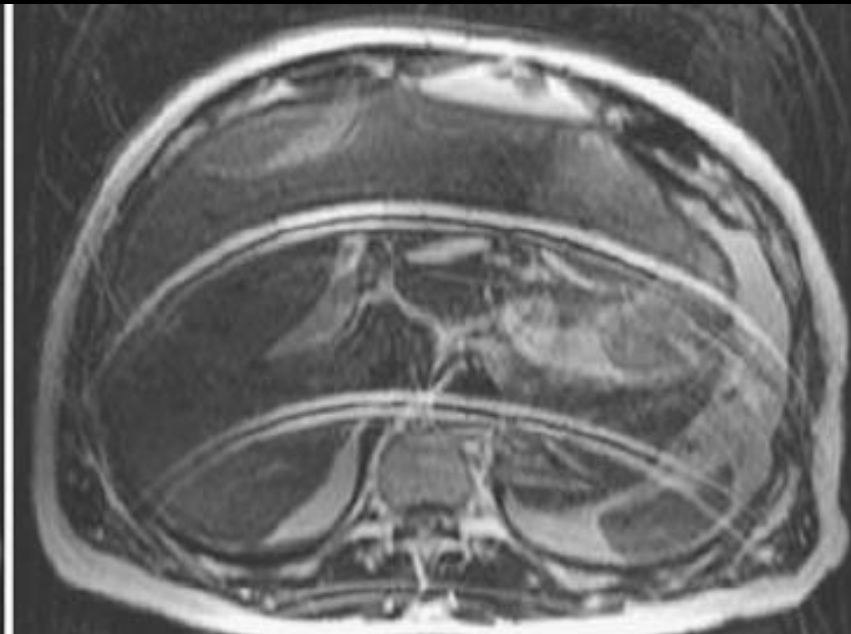
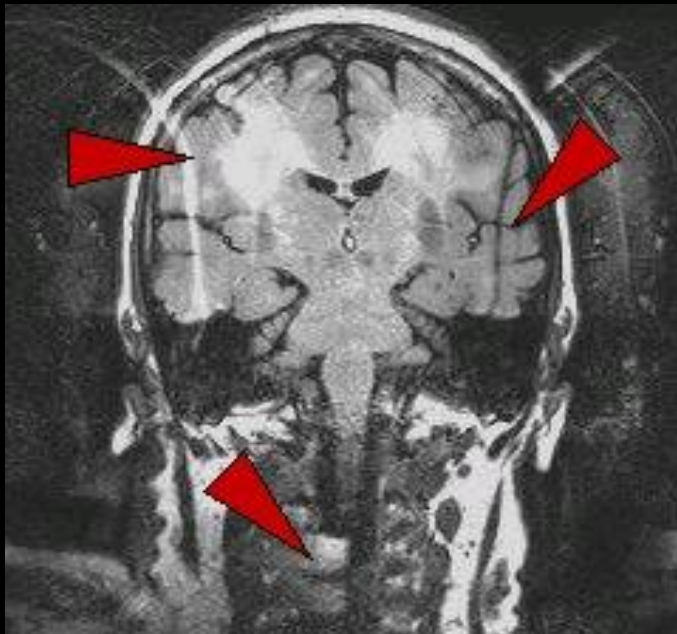
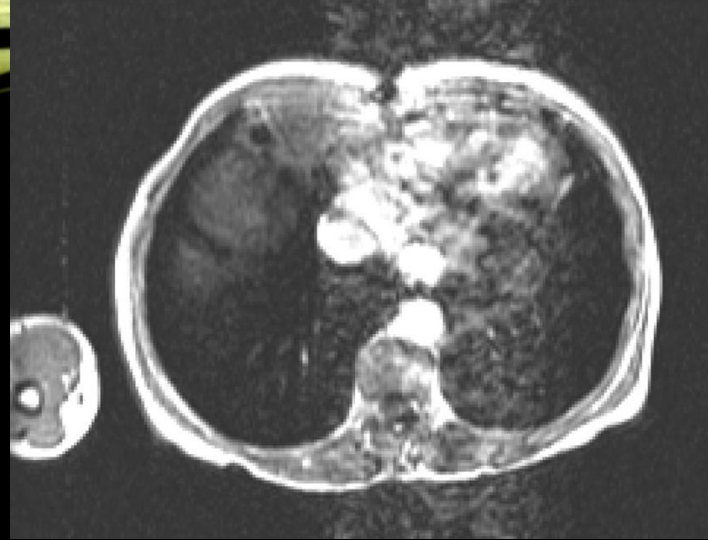

ARTEFACTS

- Movement, flow
- Poor localization of signal phases

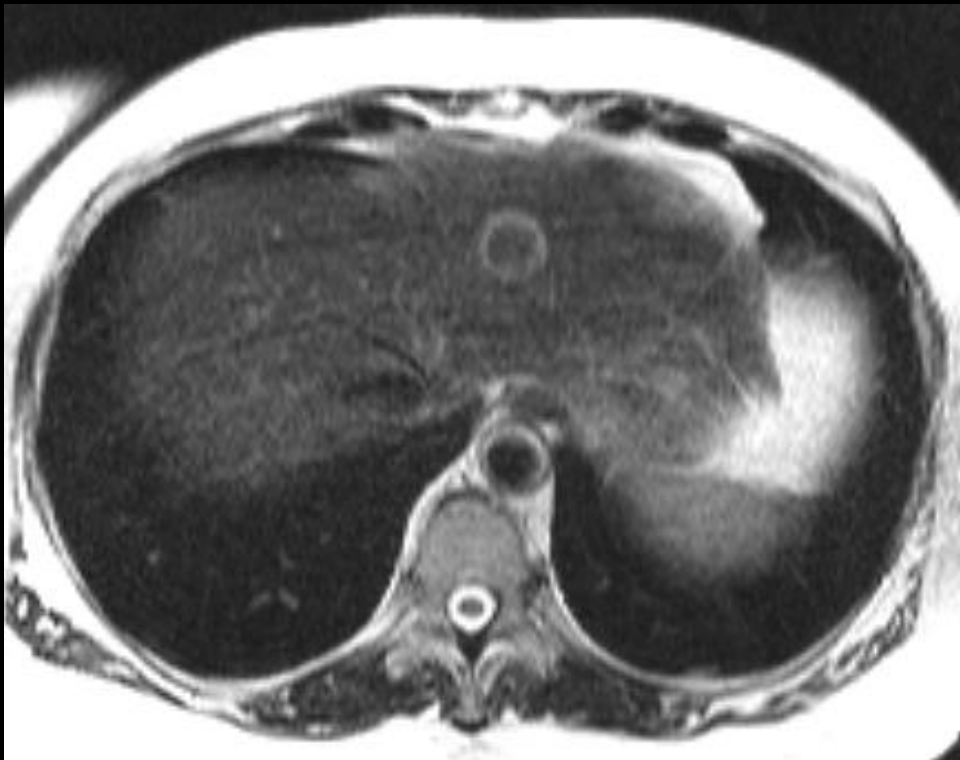
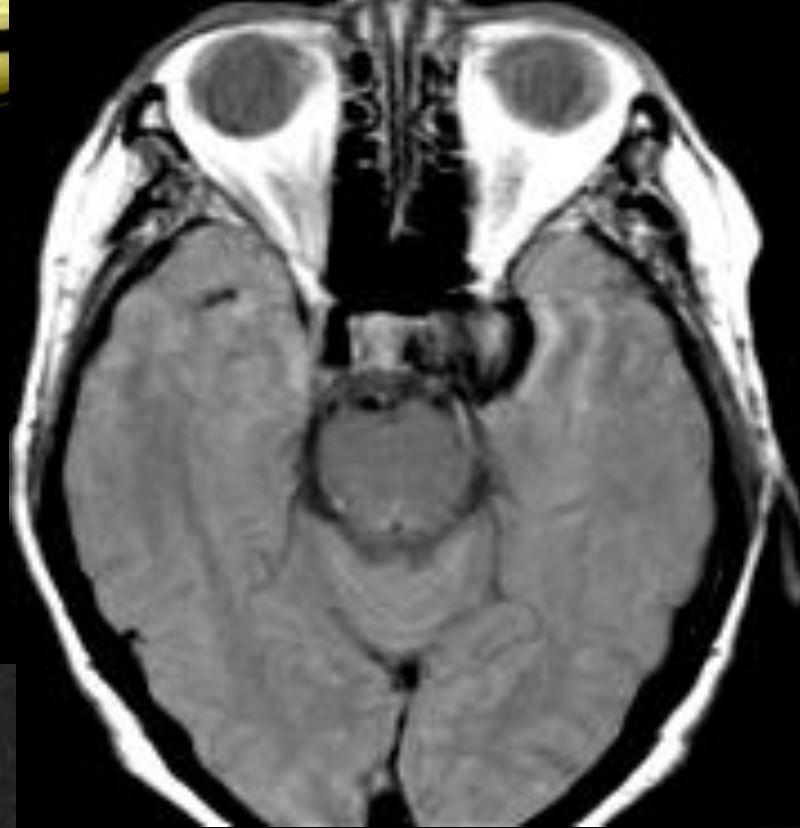

ARTEFACTS

- Motion suppression options
- Breath-hold scoop
- Pickup synchronized with the breathing curve
- Pickup synchronized with diaphragm movement
- Pickup synchronized with ECG
- Change the data pickup type (Propeller/MultiVane)
-

ARTEFACTS

- Flow suppression options
- Suitable direction of phase coding

• **NPW = off**

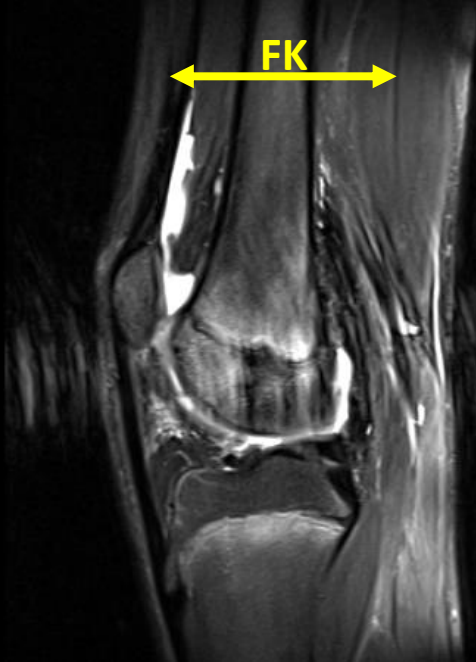

NPW = off

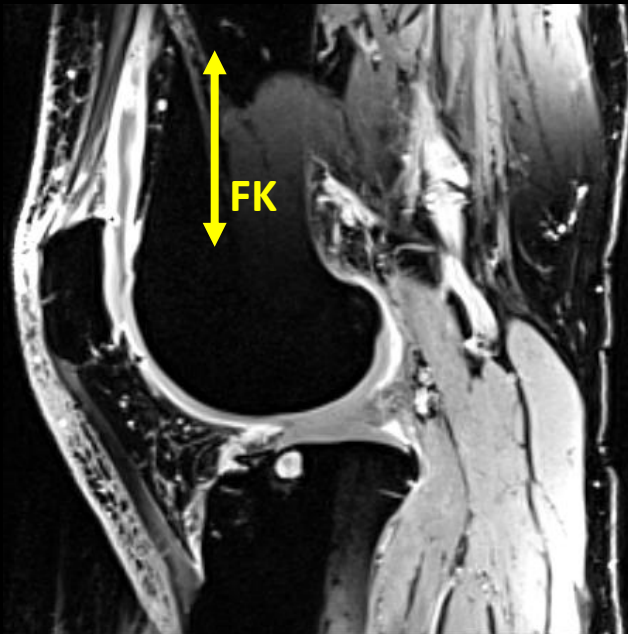

NPW = on



ARTEFACTS

- Flow suppression options
- Add a gradient pulse
-

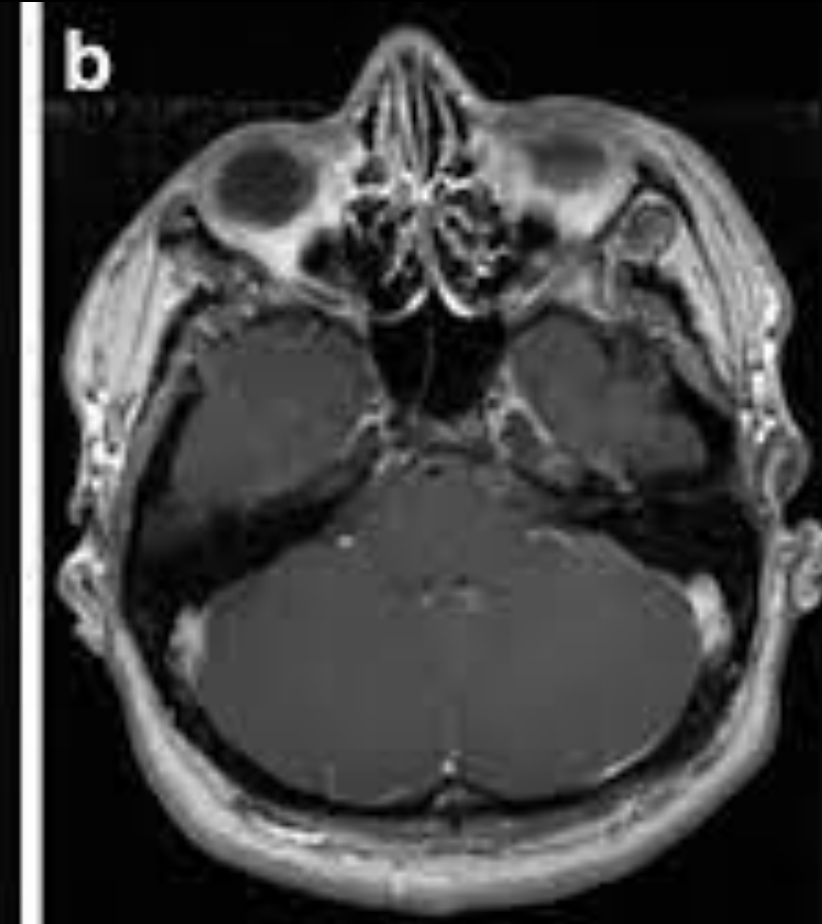
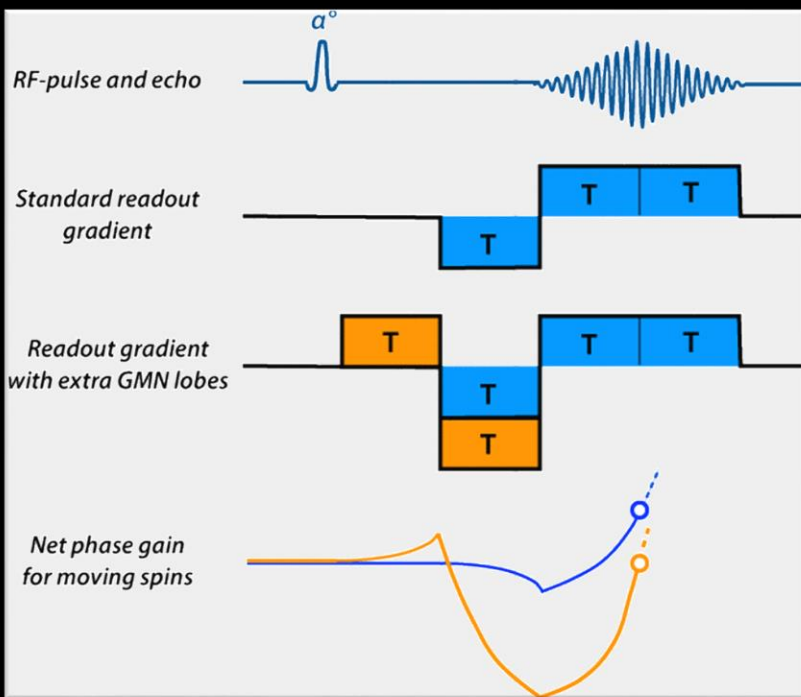

ARTEFACTS

- Flow suppression options
- Spatial saturation

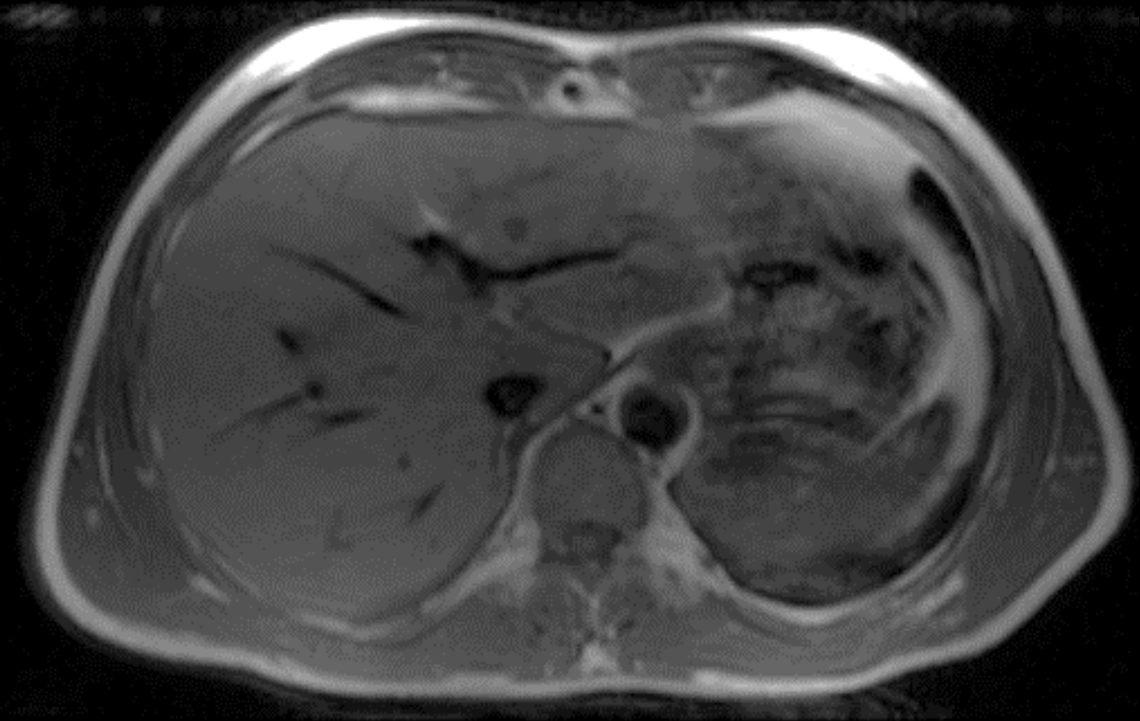
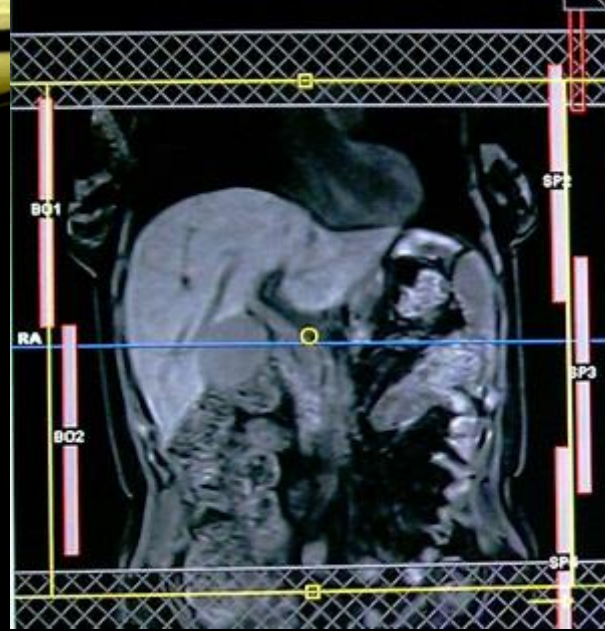

ARTEFACTS

- Signal line failure

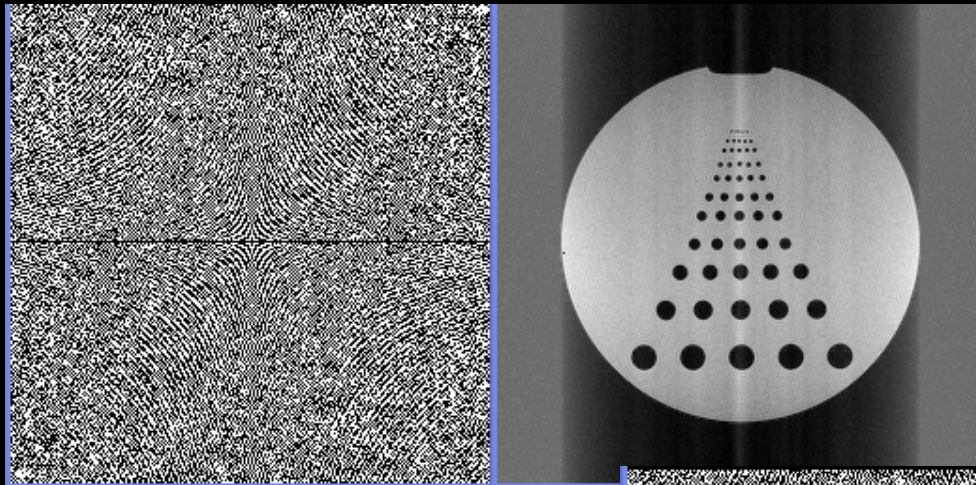

Řádek 0

Řádek 10

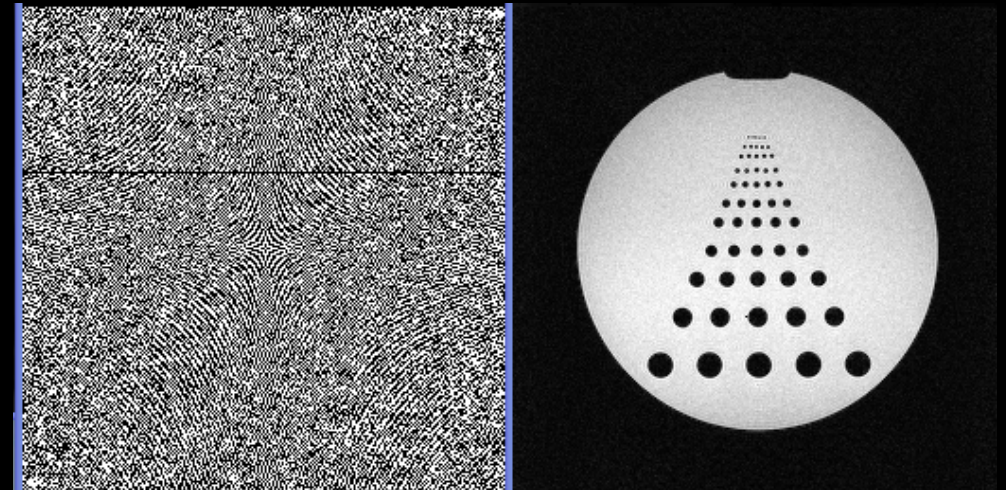

Řádek 40

ARTEFACTS

- Failure of multiple signal points (sparking)

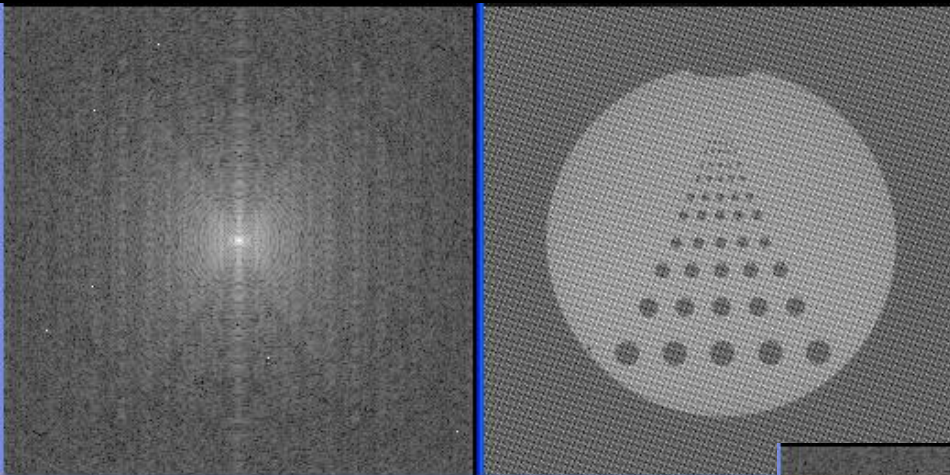

5 jisker

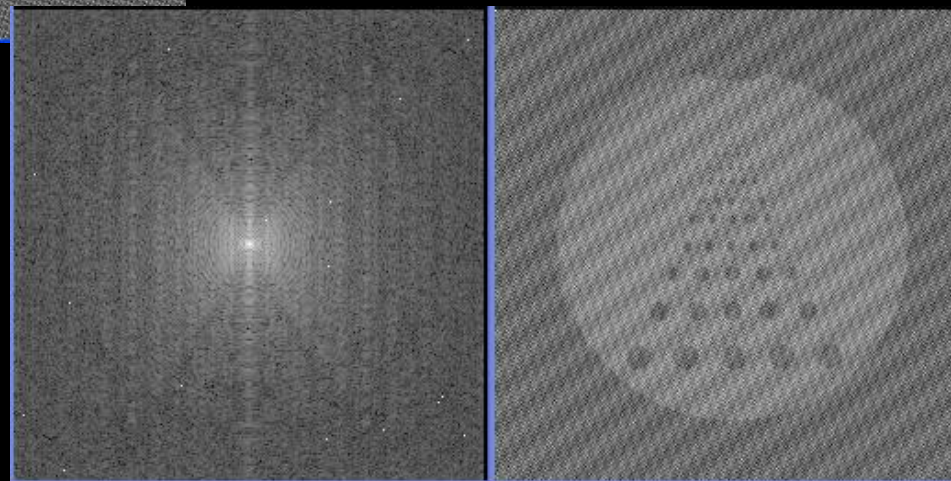

15 jisker

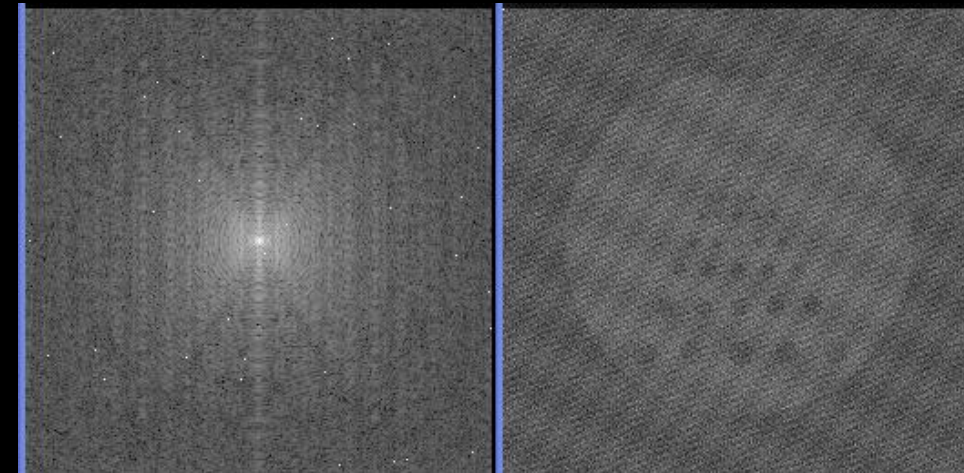

35 jisker

Chemical Shift Artifact

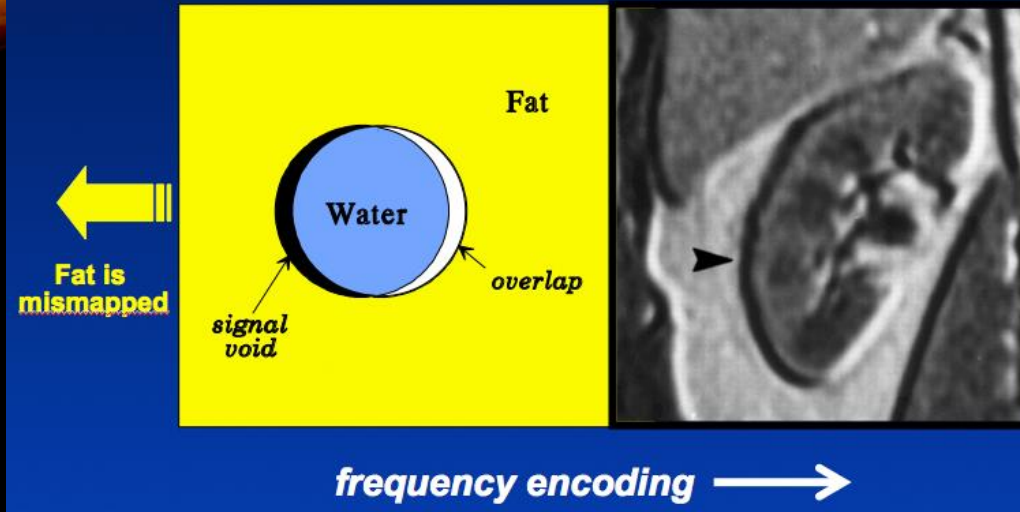

- Chemical shift
-

ARTEFACTS

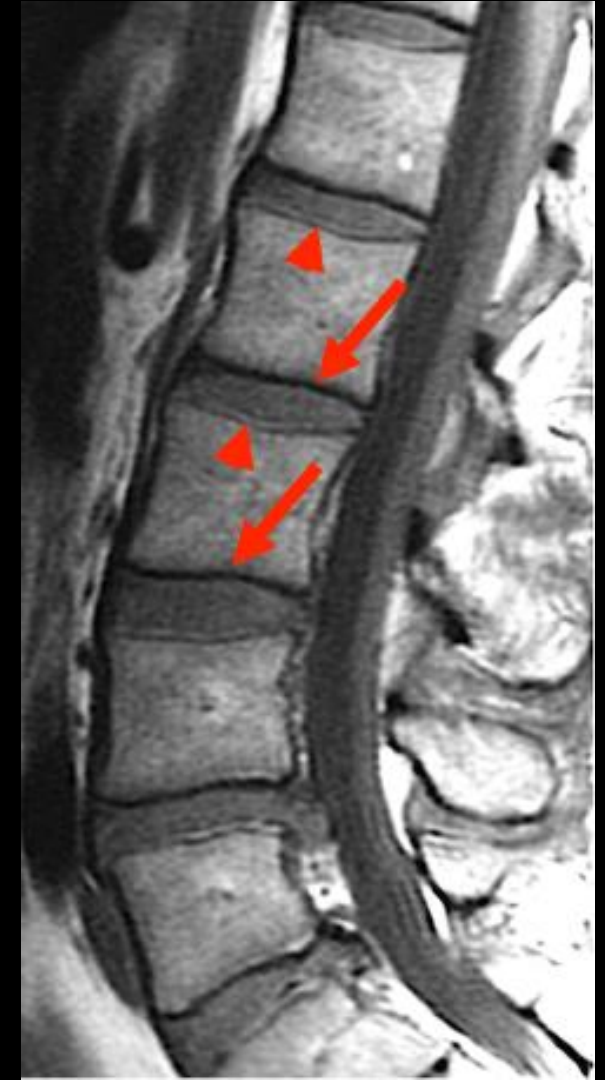

ARTEFACTS

- Chemical shift – increase in BW = decrease in displacement

Bandwidth 130

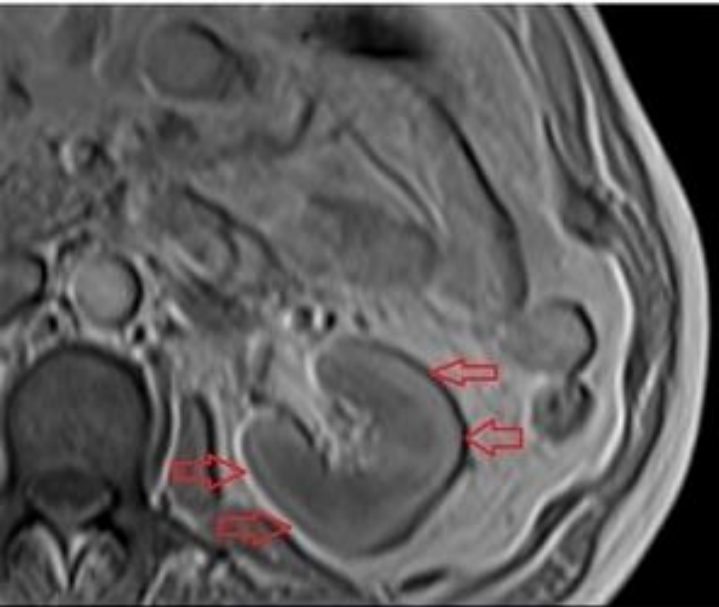

High chemical shift artefacts

Bandwidth 450

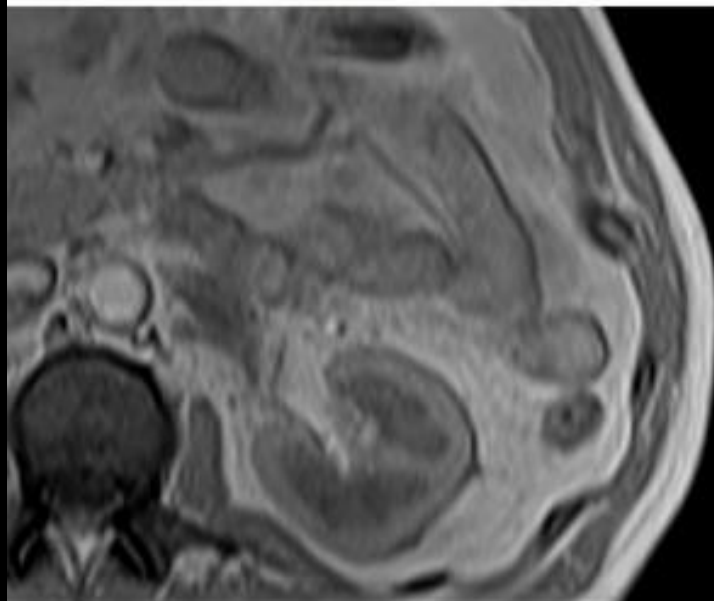

Low chemical shift artefacts

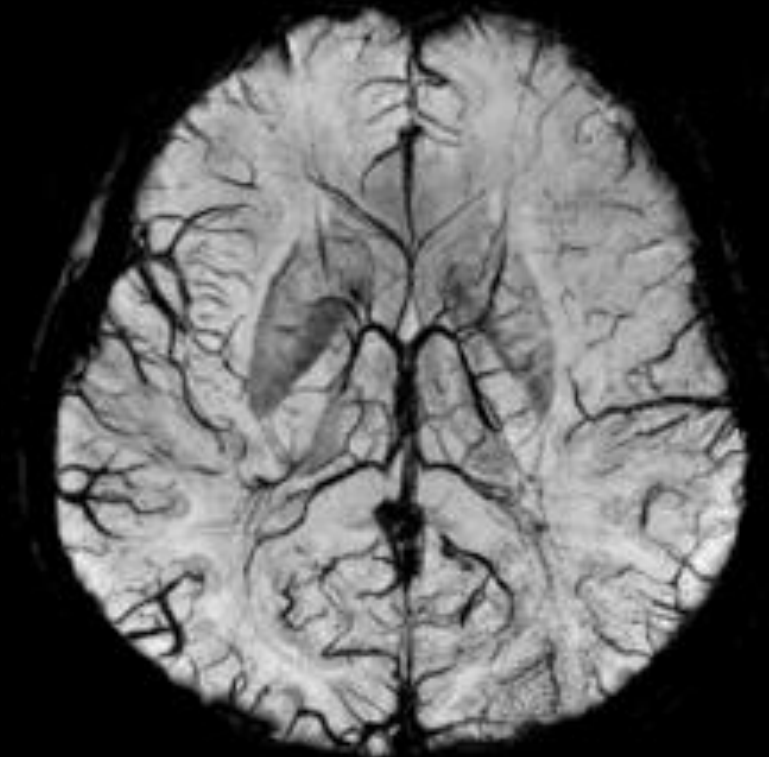

ARTEFACTS

- Partial volume => reduce voxel
-



ARTEFACTS

- Flip
- Larger FOV
- Change of FK
- NPW
-

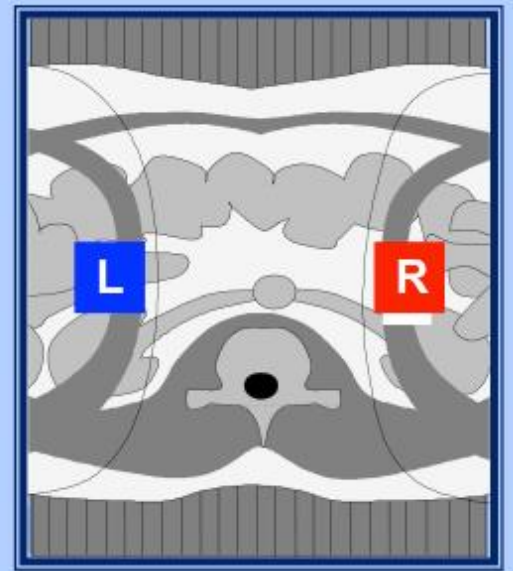
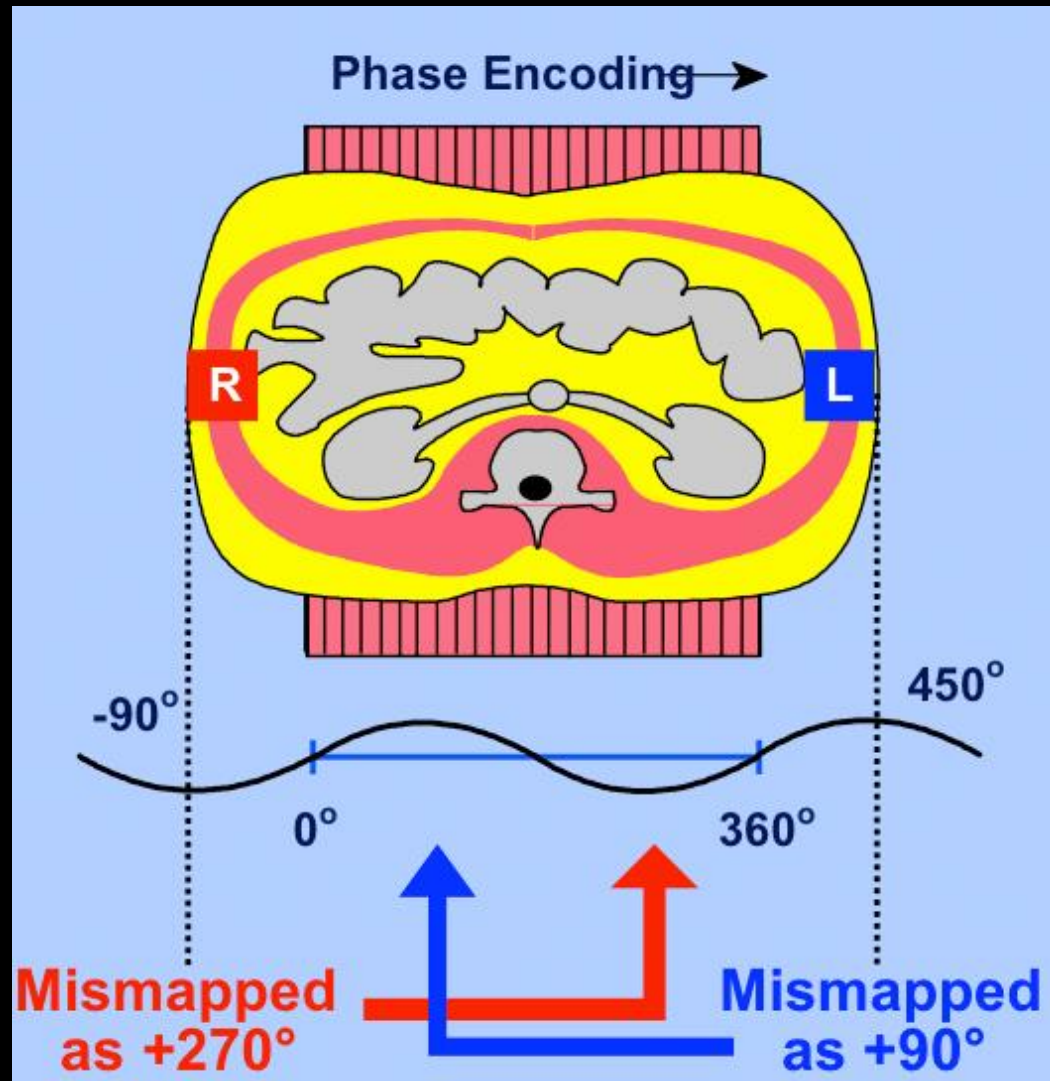
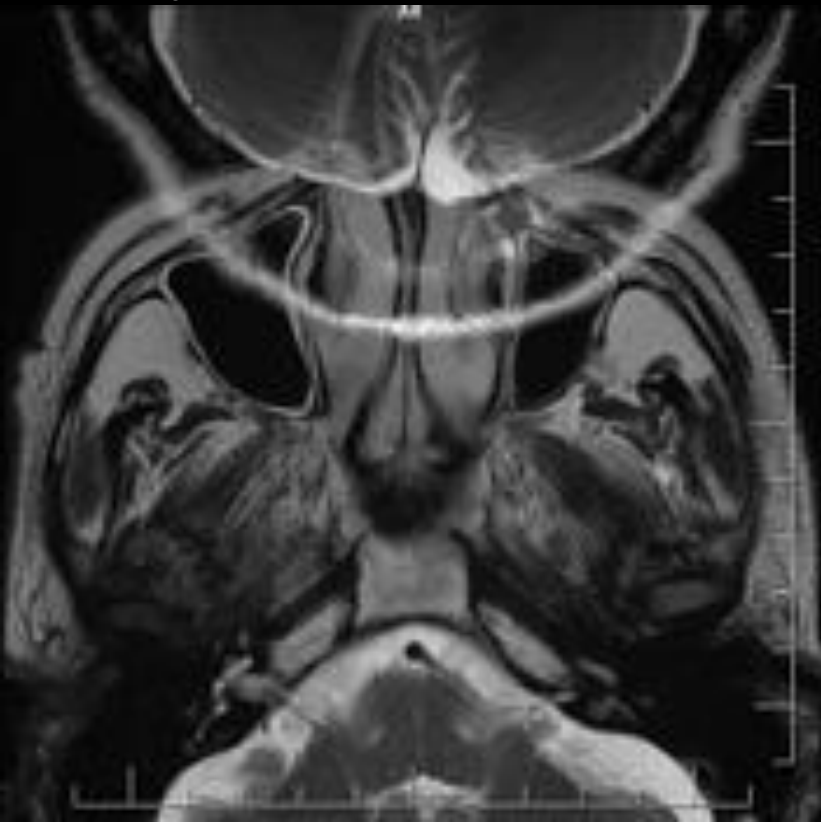

image with phase wrap-around artifact

- Flip

-



ARTEFACTS

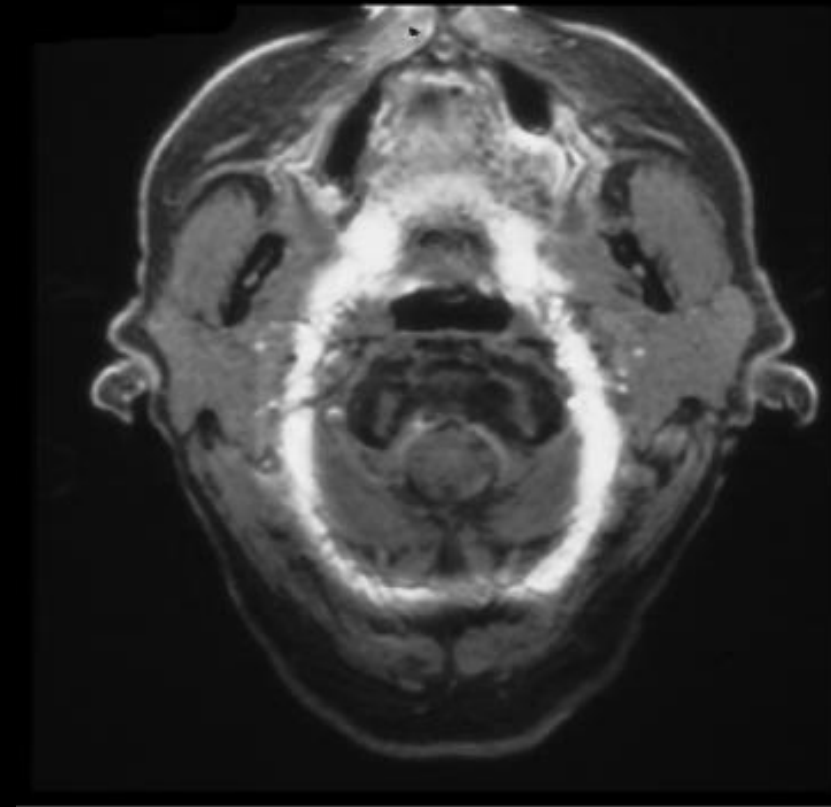

ARTEFACTS

- Flip

Phase Encoding →

FOV_p and N_p both increased

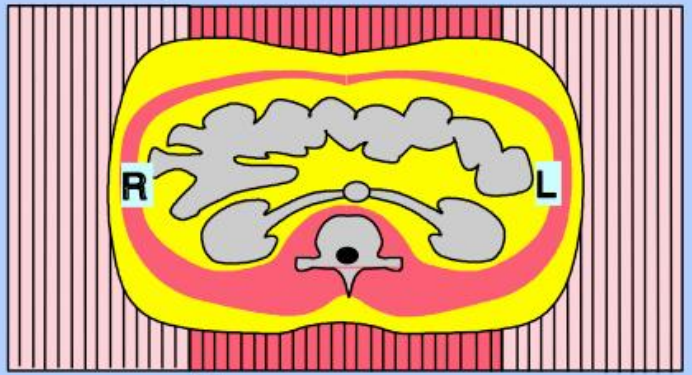

Pixel width = FOV_p / N_p is unchanged

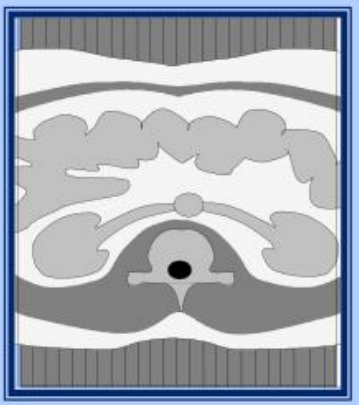

Only central portion of the FOV is reconstructed



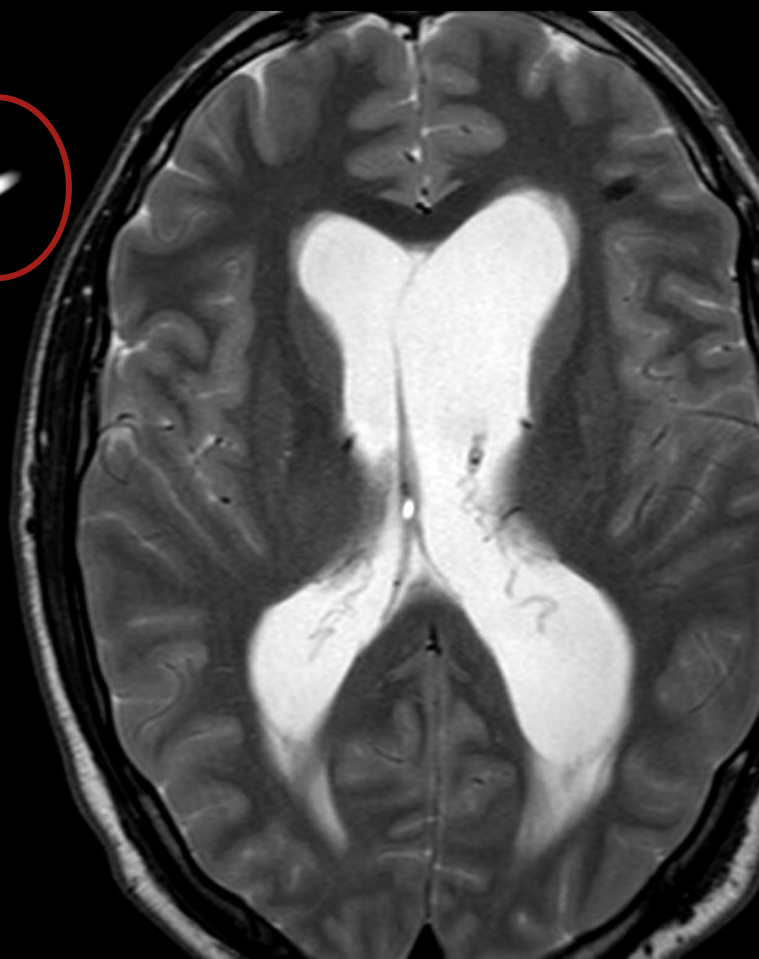

ARTEFACTS

- Flip vs SENSE

-



ARTEFACTS

- Poor SENSE calibration

-

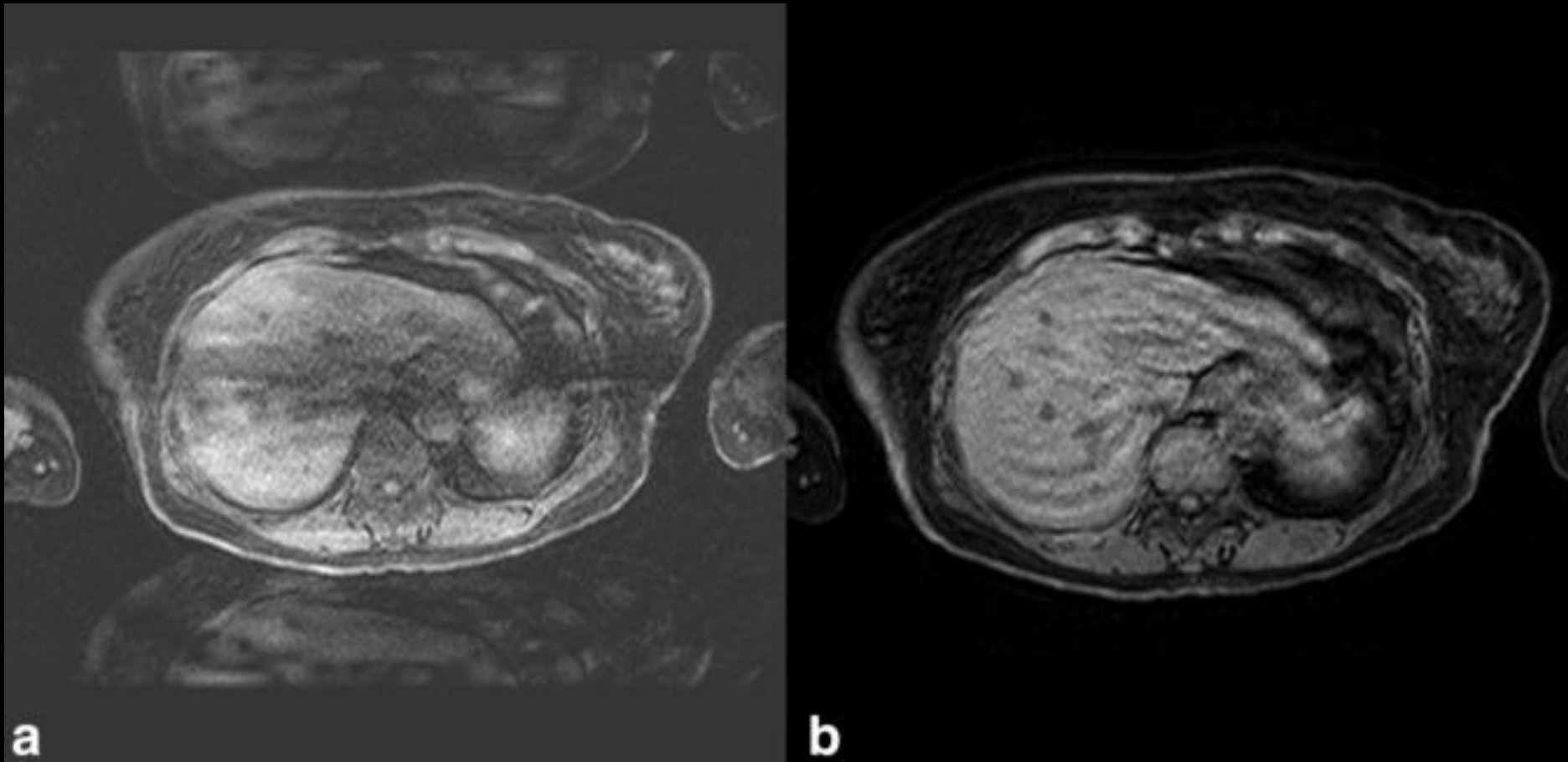

ARTEFACTS

- Dielectric effect

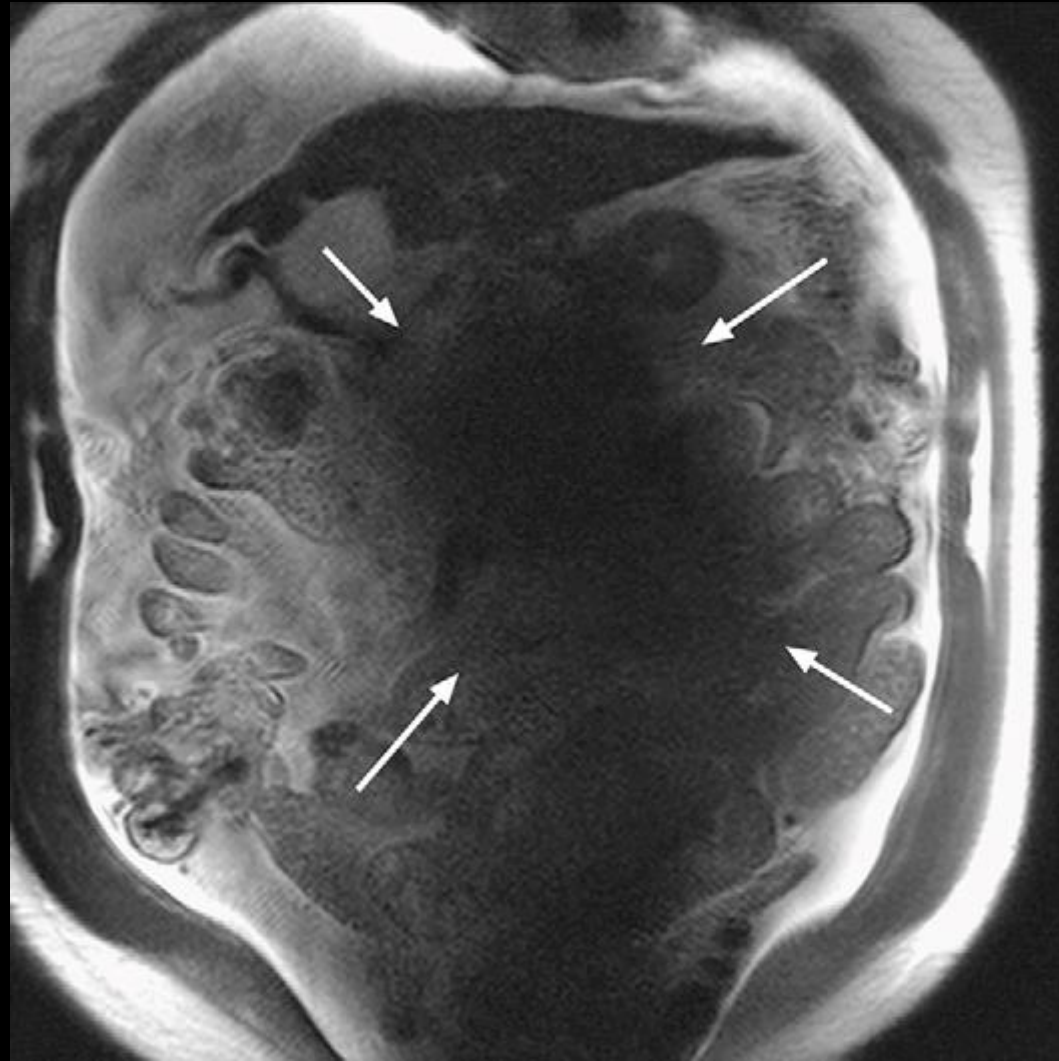
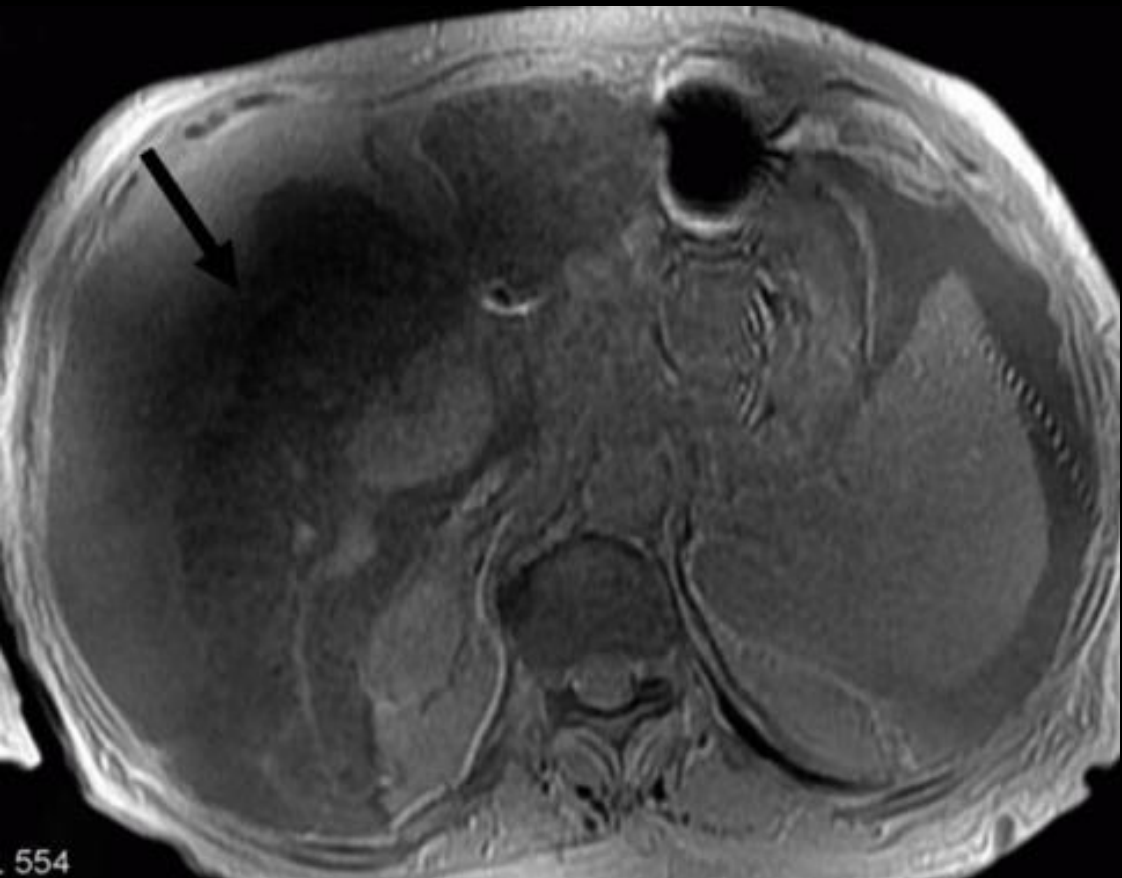

ARTEFACTS

- Gibbs'

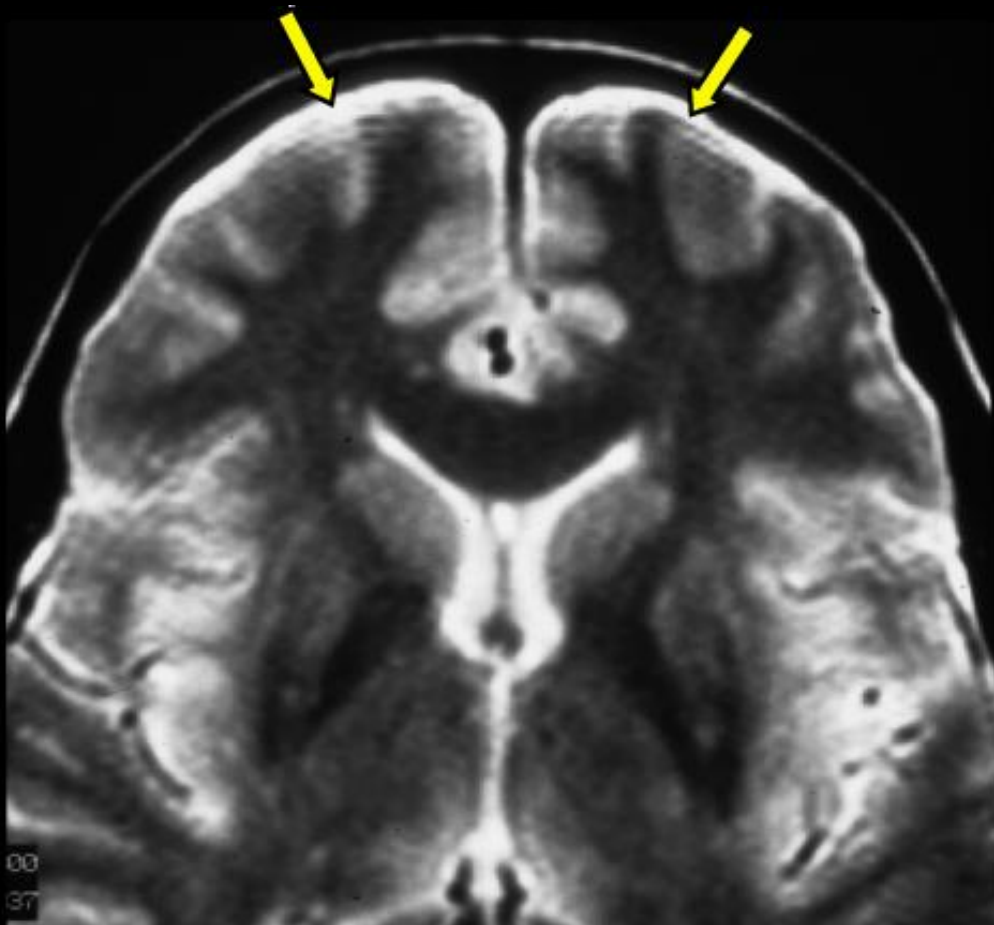

ARTEFACTS

- Dixon

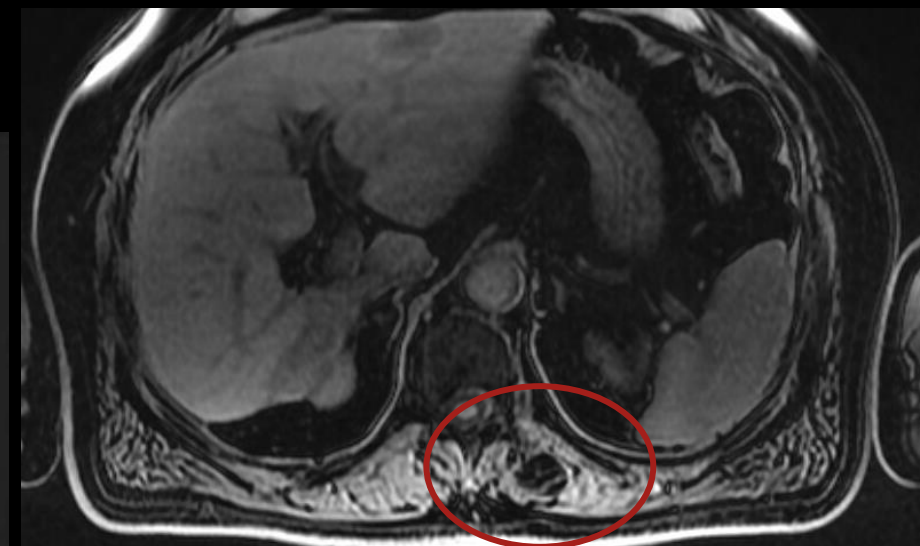
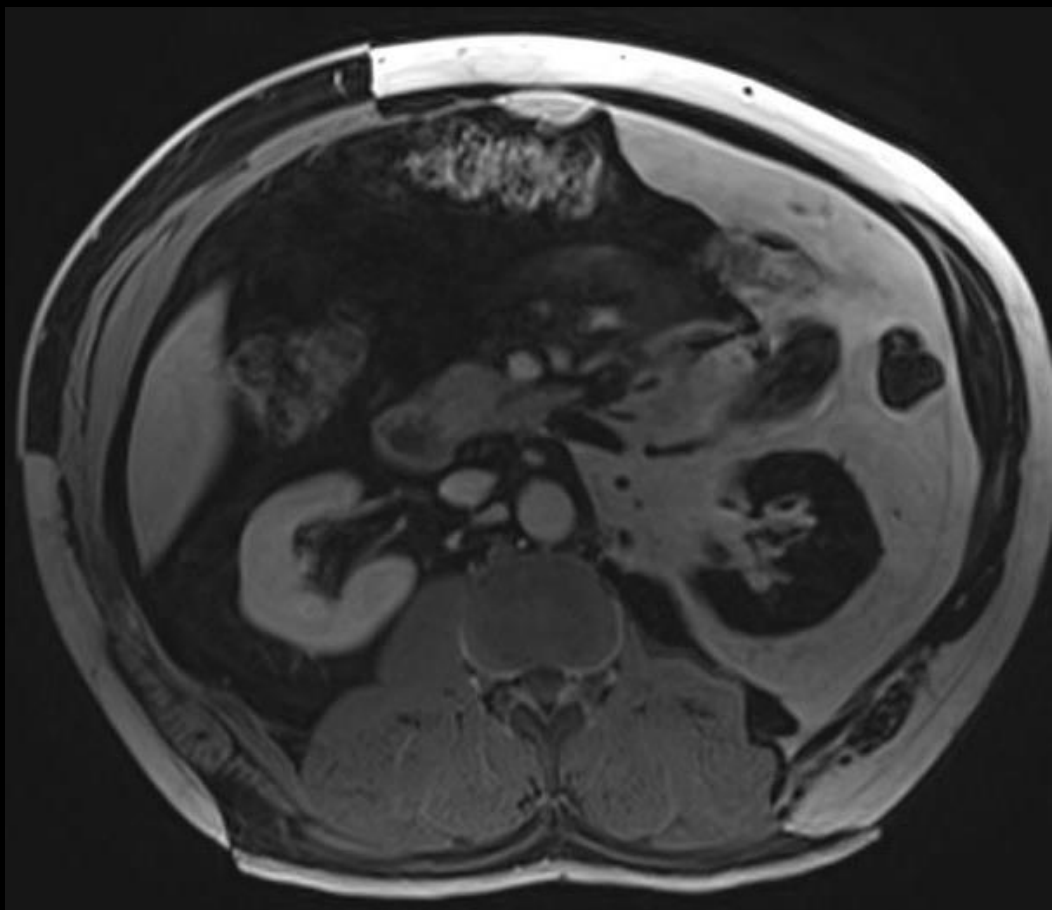

ARTEFACTS

- Human error

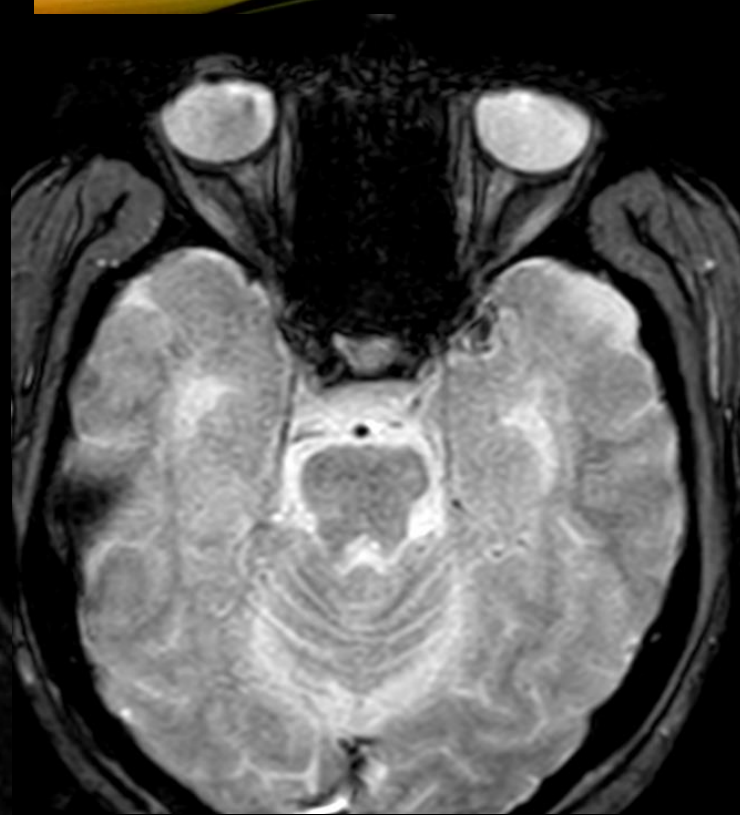
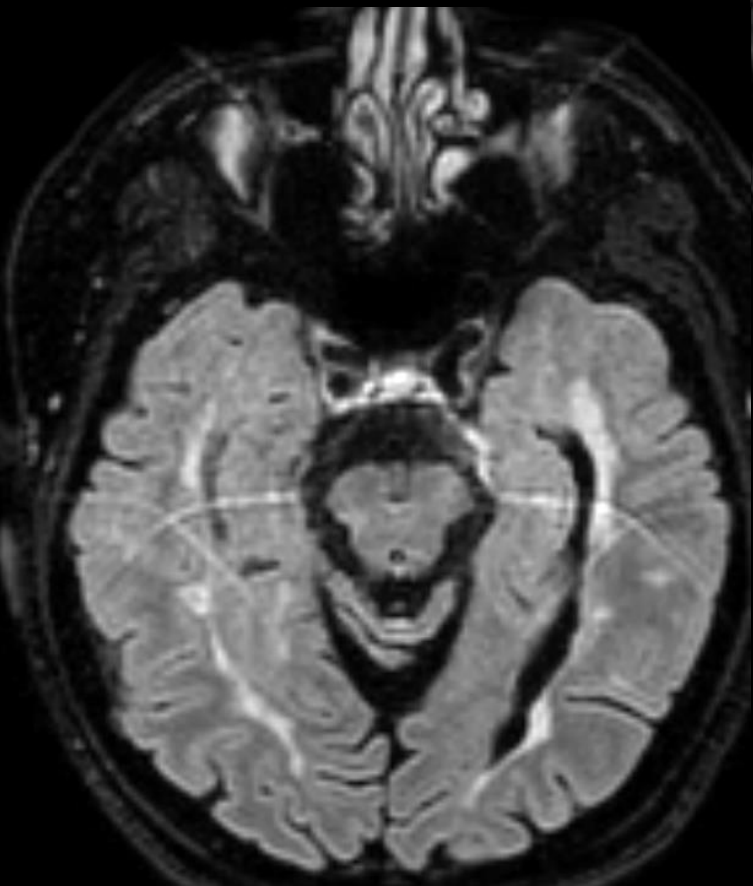

CONTRAST AGENTS

- Positive KL
- Mineral oils
- Sucrose polyesters
- Short T1 times protons =>
- positive signal on T1
-



CONTRAST AGENTS

- Negative KL
- Gases (CO₂, air)
- Kaolin porridge
- Dehydrating agents
- Rectally applied Perflubron
-

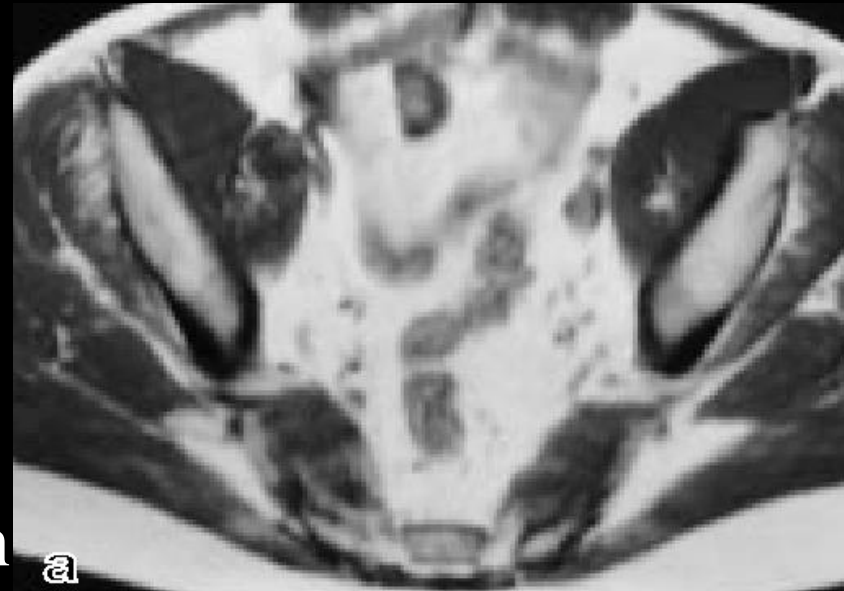

CONTRAST AGENTS

- Natural KL
- High content of Mn (pineapple juice)
-

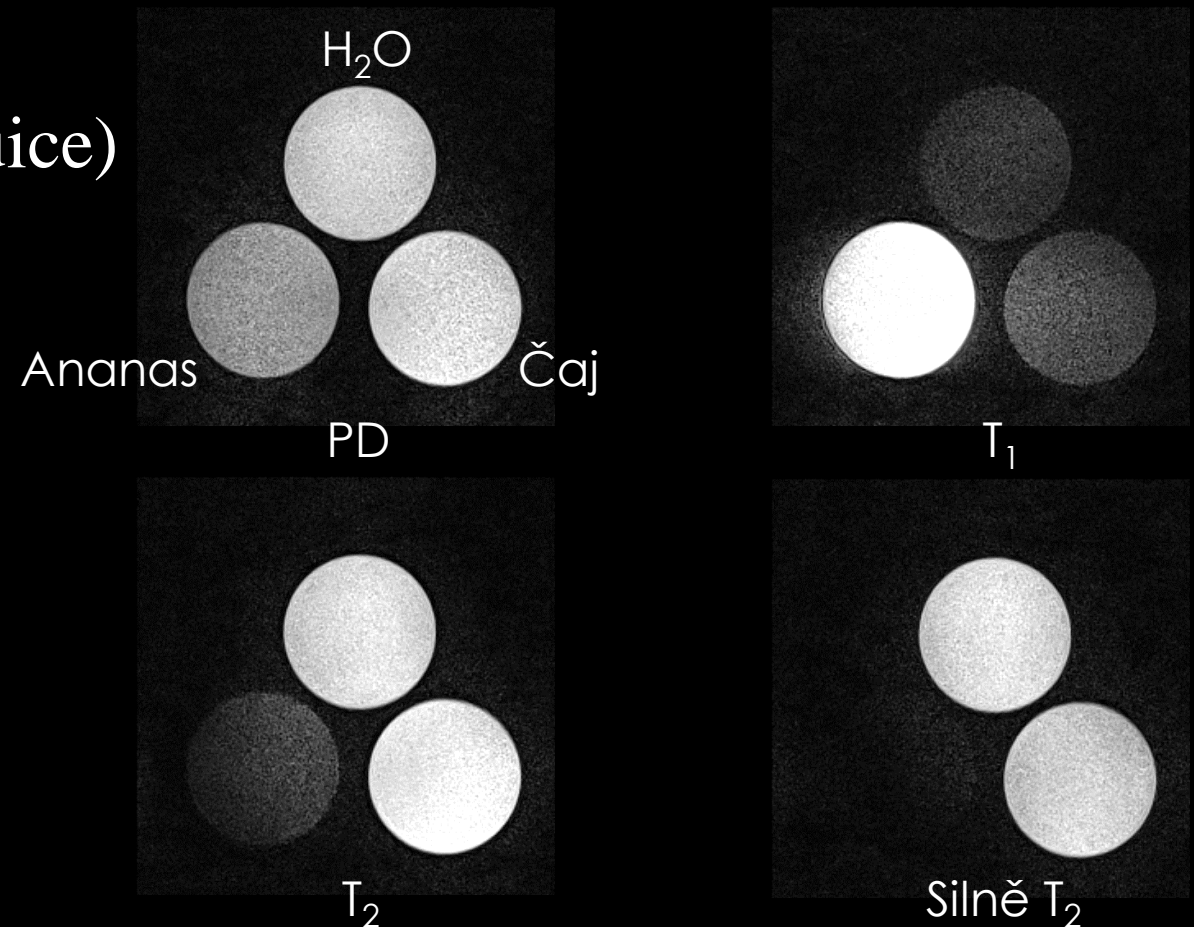

CONTRAST AGENTS

- Paramagnetic KL
- The substance itself is not displayed
- Significantly changes T1 time in its surroundings (Relaxivity)
- Nitrogen dioxide
- Stable free radicals
- Metal cations (Ni^{2+} , Fe^{2+} , Gd^{3+})
- Relaxivity \sim concentration, mag.moment, distance, nepár.e-
-

CONTRAST AGENTS

- Paramagnetic KL
- El. Configuration
- Fe²⁶⁵⁶ [Ar] 4s²3d⁶ – 4 free e⁻
- Gd⁶⁴¹⁵⁸ [Xe] 6s²4f⁷5d¹ – 8 free e⁻
- Need to bind stably to organic substances (toxicity of heavy metals)
- Chelates – coordination links
- E.g. Dotarem
-

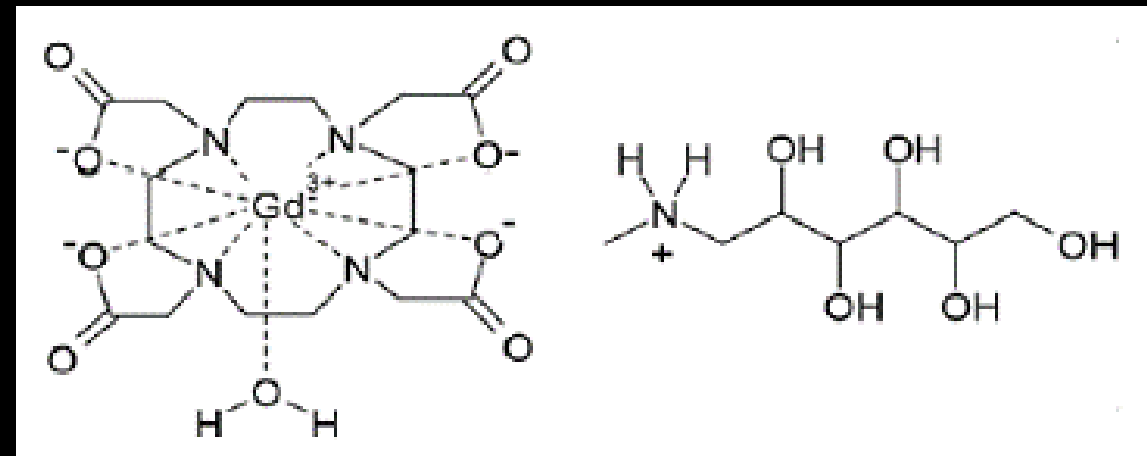

CONTRAST AGENTS

- Contraindication
- Pregnancy
- Breastfeeding
- Kidney disease
- Hypersensitivity to the KL component
- Contraindication
- Significantly less than iodine
- Headache, rashes, difficulty breathing
- Allergic reactions
- Systemic nephrogosis fibrosis
- It is not recommended to use linear non-ionic KL

•	Termodynamická stabilita - pK_{therm}		
•	Dotarem	25.6	(cyklický, iontový)
•	Prohance	23.8	(cyklický, neiontový)
•	Primovist	23.5	(lineární, iontový)
•	Multihance	22.6	(lineární, iontový)
•	Magnevist	22.1	(lineární, iontový)
•	Gadovist	21.8	(cyklický, neiontový)
•	Omniscan	16.9	(lineární, neiontový)
•	Optimark	16.6	(lineární, neiontový)

nízké riziko

vysoké riziko

A**IMAGE LEVEL**

Diffusion-weighted MRI image

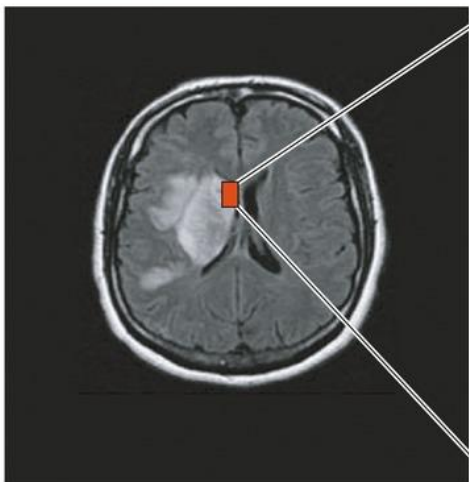
**TISSUE/CELL LEVEL**

- Hindrance
- Restriction
- Barriers

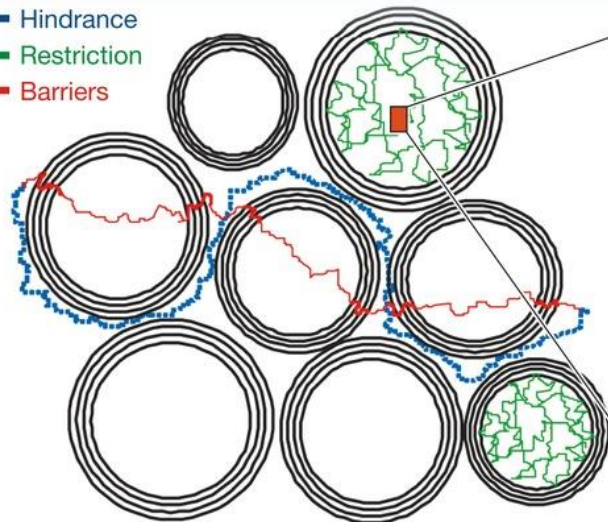
**MOLECULAR LEVEL**

Random walk

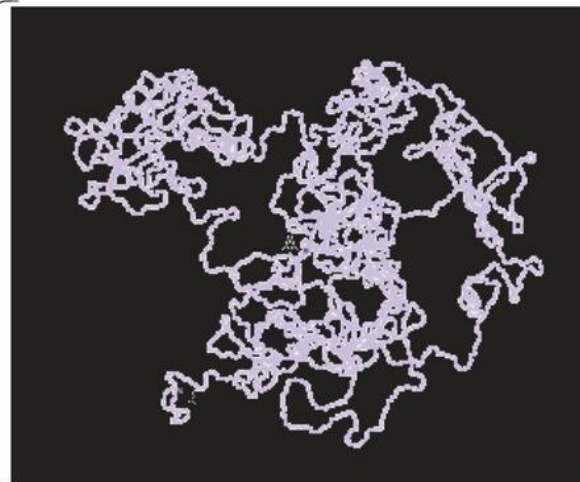

DIFFUSE DISPLAY

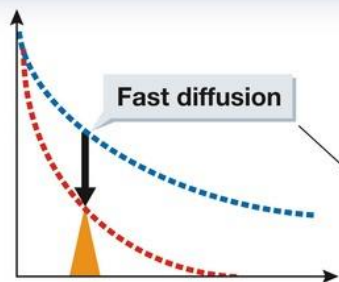
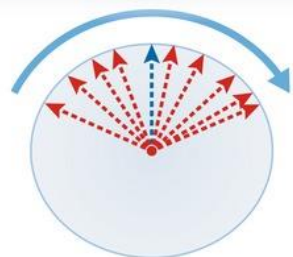
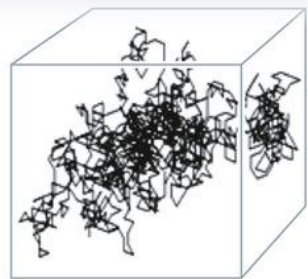
B

Diffusion-weighted MRI image

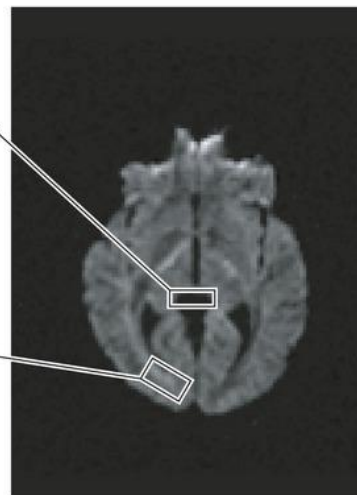

Standard MRI image

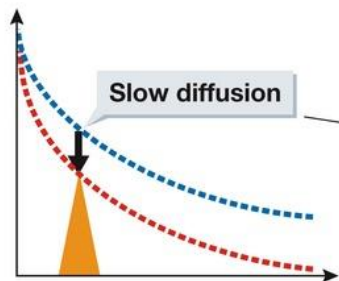
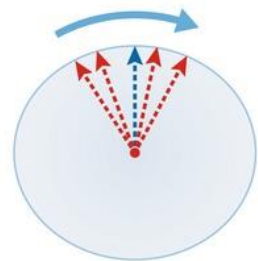
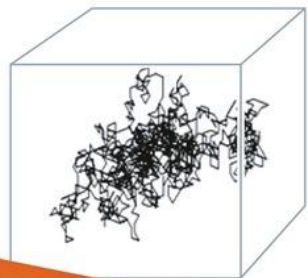
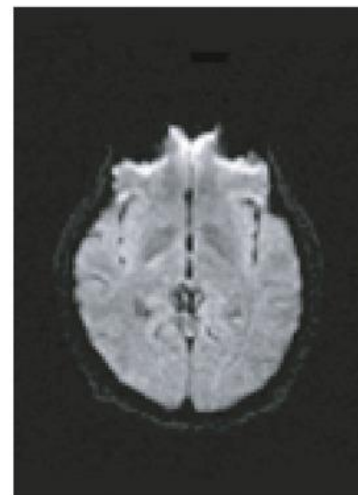

Magnetic field gradient

DWI

- Diffuse weighing with additional gradients
- Quality grad. machine equipment
- Max. amplitude (G) 40-80 mT/m
- Rise speed 80-200 T/m/s
- $b = \gamma^2 G^2 \delta^2 (\Delta - \delta/3)$
- $b = 0 - 1500 \text{ s/mm}^2$ clinical
- $b = 0 - 4000 \text{ s/mm}^2$ scientific
- Quick pickup ($\sim 100 \text{ ms}$)
-

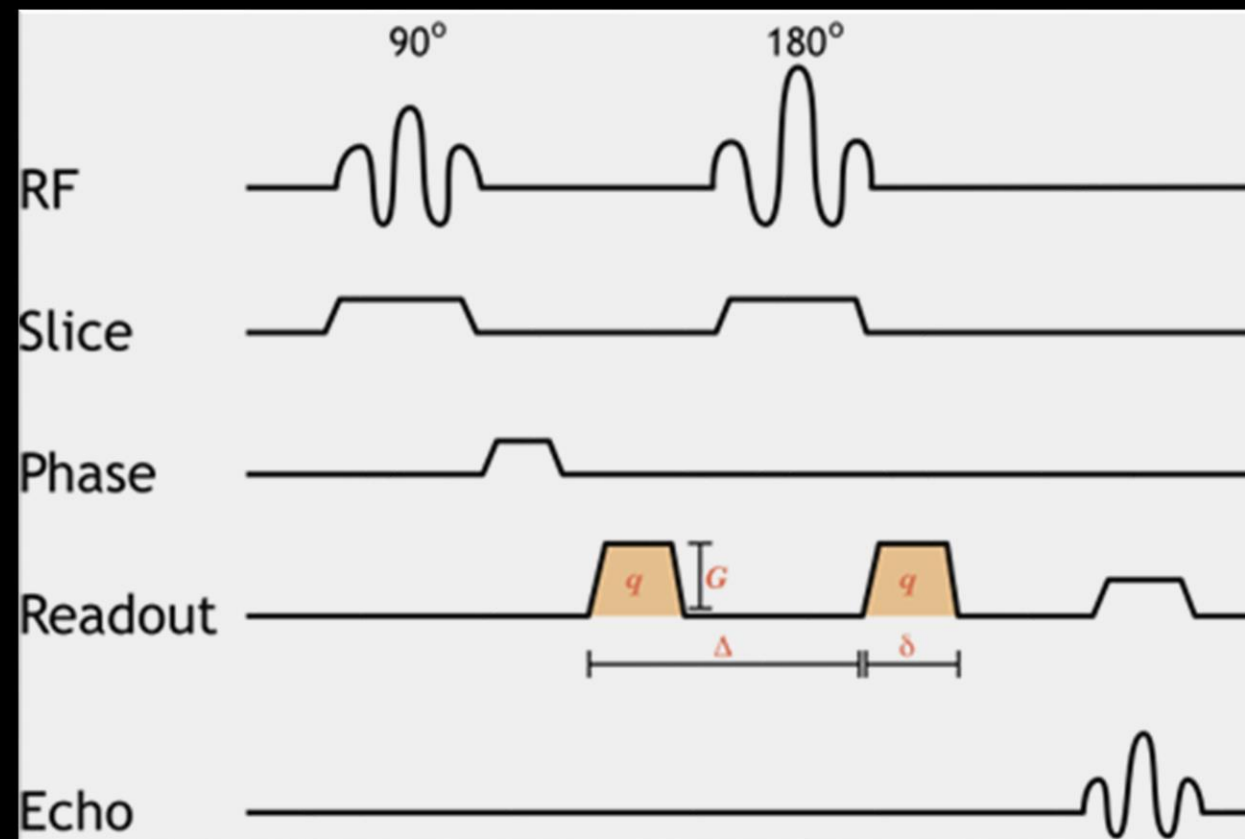

DWI – SS EPI

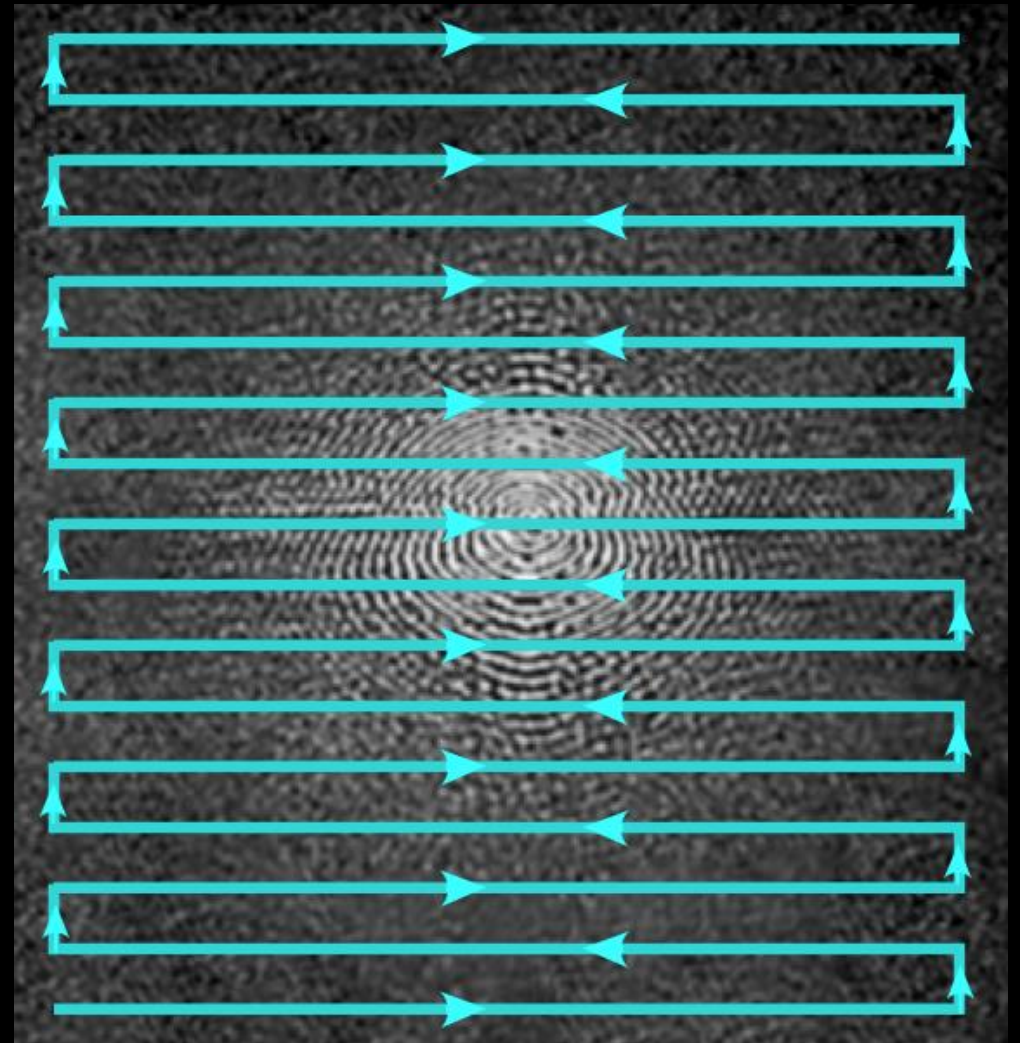

DWI – ADC

b = 0

b = 1000 s/mm²

b = 3000 s/mm²

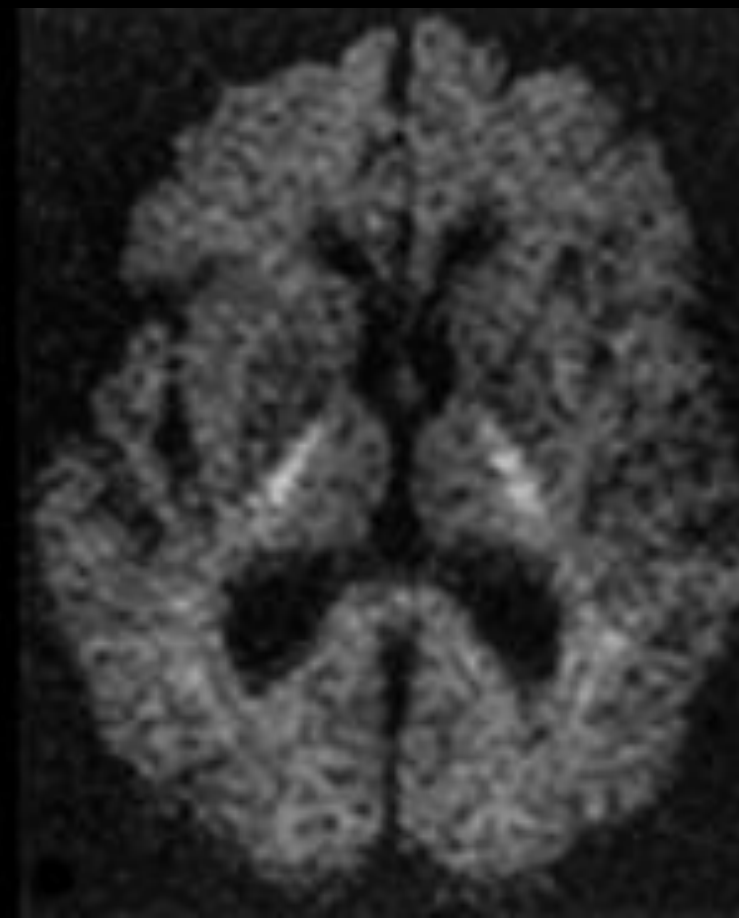
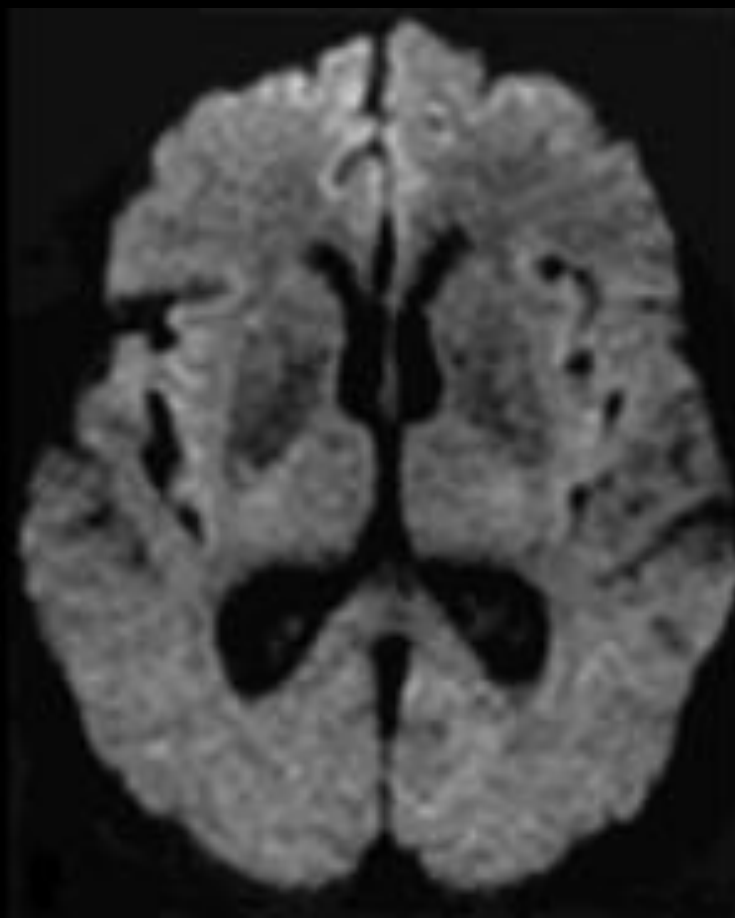
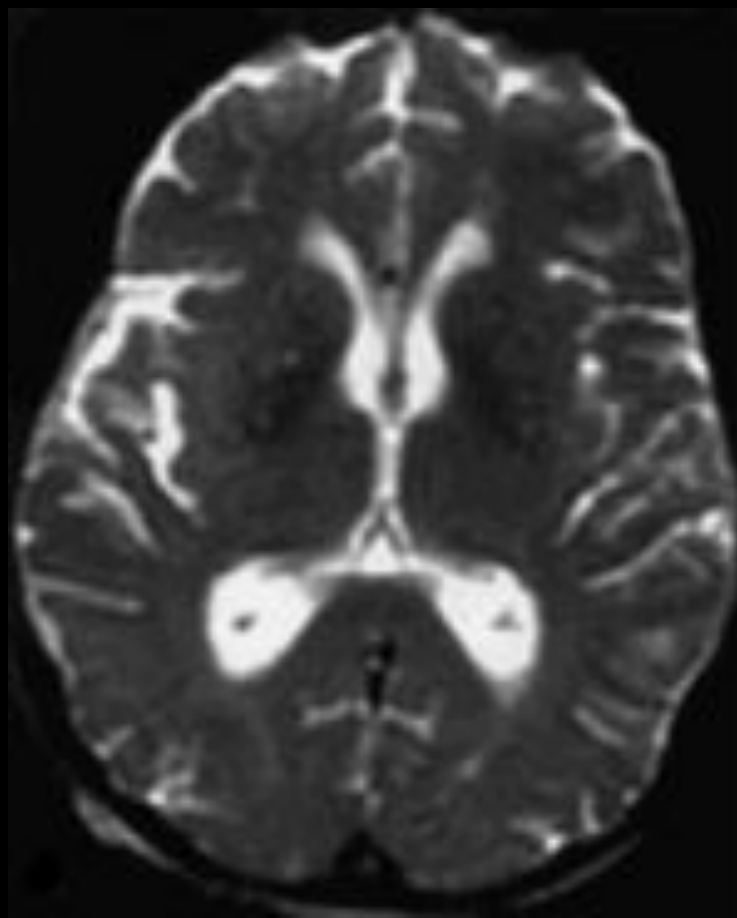

DWI - ADC

- $S = S_0 e^{-b ADC} \Rightarrow -\frac{1}{b} \ln\left(\frac{S}{S_0}\right) = ADC$

- Brain

- $S_0 \Rightarrow b = 0$
- $S \Rightarrow b = 1000$

- Body:

- $S_0 \Rightarrow b = 50$
- $S \Rightarrow b = 800$

- Prostate:

- $S_0 \Rightarrow b = 0$
- $S \Rightarrow b > 1500$

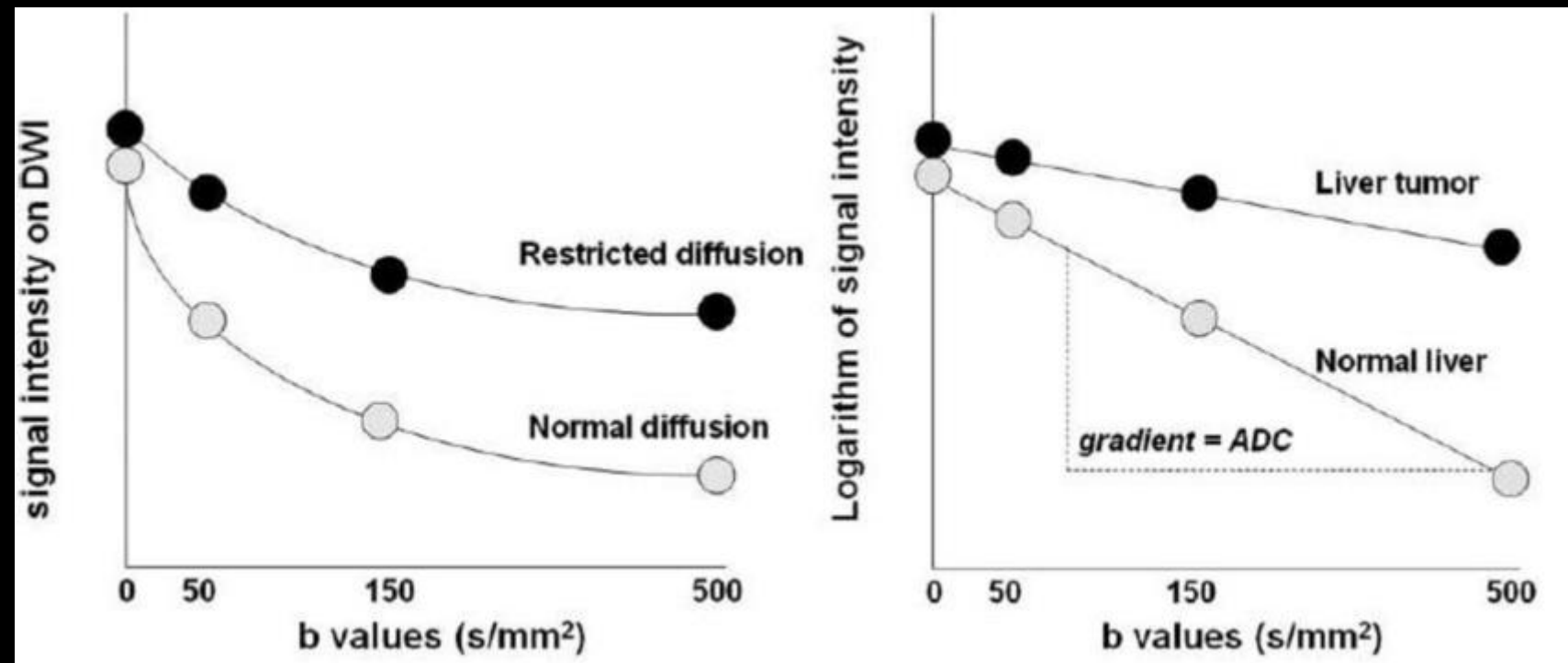

DTI

- Diffusion can be oriented in the same way as diffusion gradients
- Min 6 directions grad.
- Tensor calculation
- Ellipsoid characterization
- For a more accurate estimate of > 16 directions

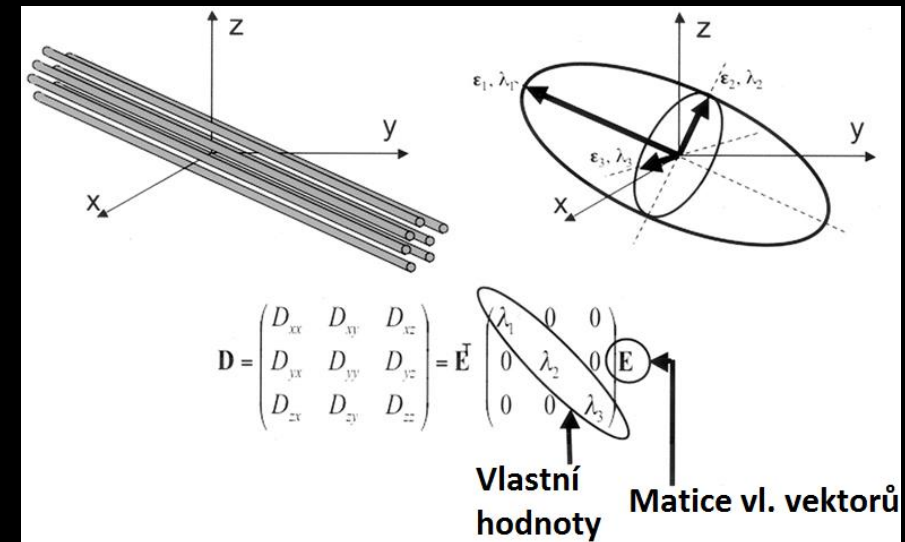

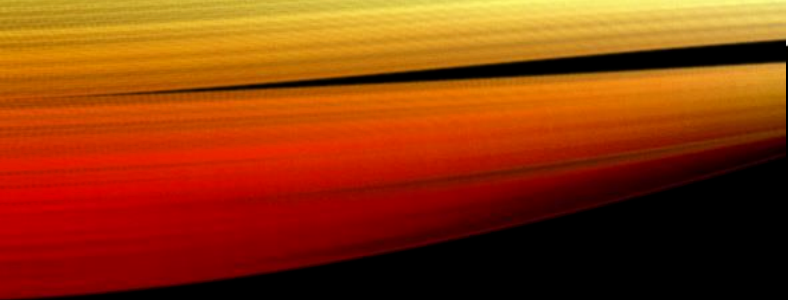

DTI FA

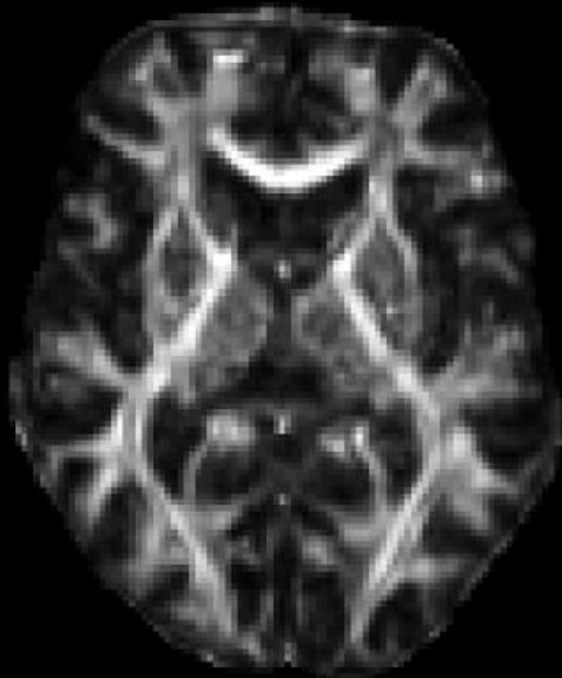

DTI FA color

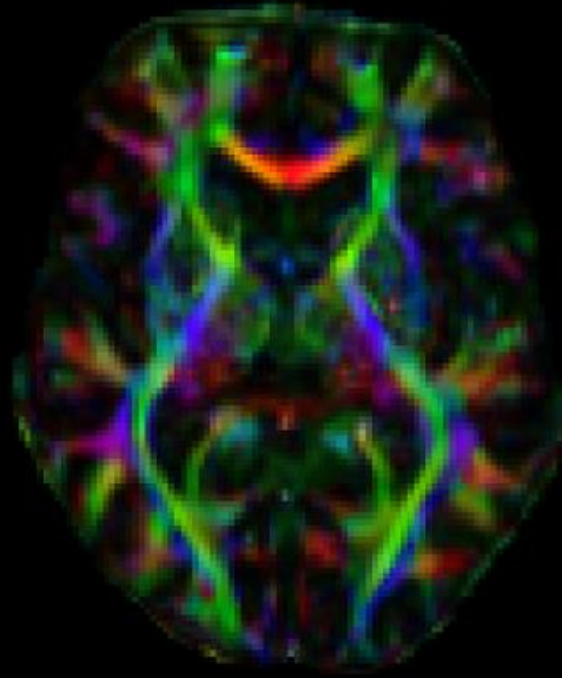

DTI MD

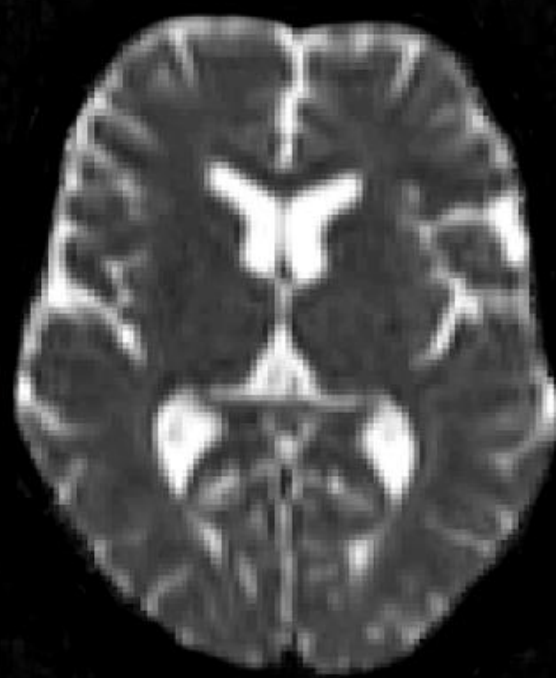

- Scalar parameters
-

	Unit of measure	Formula	Object measured
FA	Scalar value ranging between 0-1	$\frac{\sqrt{1}}{\sqrt{2}} \frac{\sqrt{(\lambda_1 - \lambda_2)^2 + (\lambda_2 - \lambda_3)^2 + (\lambda_3 - \lambda_1)^2}}{\sqrt{\lambda_1^2 + \lambda_2^2 + \lambda_3^2}}$	Fibers directionality/axonal loss
MD	mm ² /sec	$(\lambda_1 + \lambda_2 + \lambda_3)/3$	Amount of water diffusion/myelin loss
AD	mm ² /sec	λ_1	Diffusivity parallel to the fibers/myelin and axonal content
RD	mm ² /sec	$(\lambda_2 + \lambda_3)/2$	Diffusivity perpendicular to the fibers/myelin content

FA: fractional anisotropy; MD: mean diffusivity; AD: axial diffusivity; RD: radial diffusivity; mm: millimeters; sec: second.

- Tractography

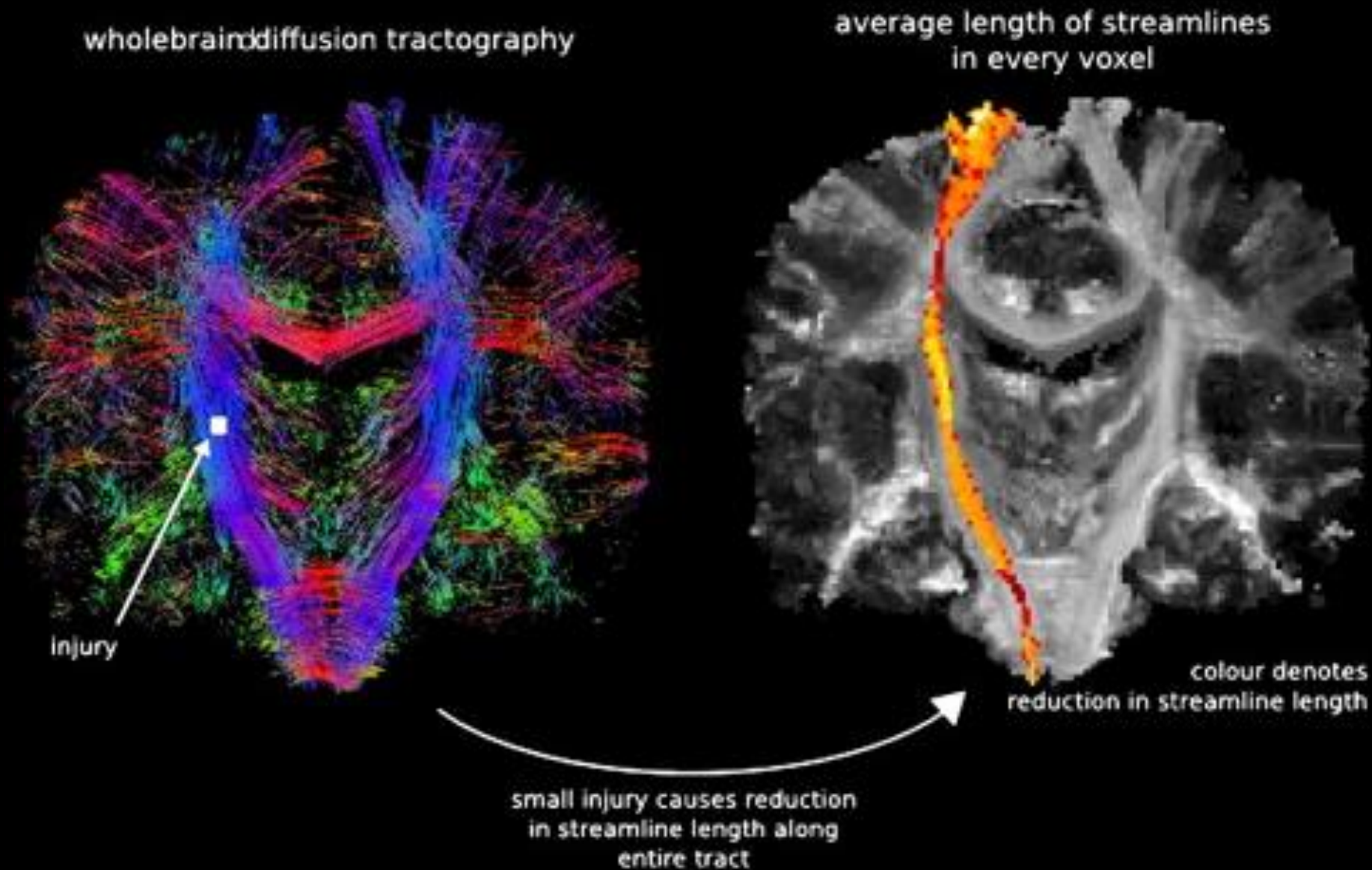

MRA

- Time of flight (TOF)
- Principle:
- 90° and 180° RF applications
- Blood from another layer only 180° RF
- Static tissue suppression
- The size of the signal is growing:
- With speed
- With TR, T1 and α
- The size of the signal decreases:
- Layer thickness
- With layer orientation

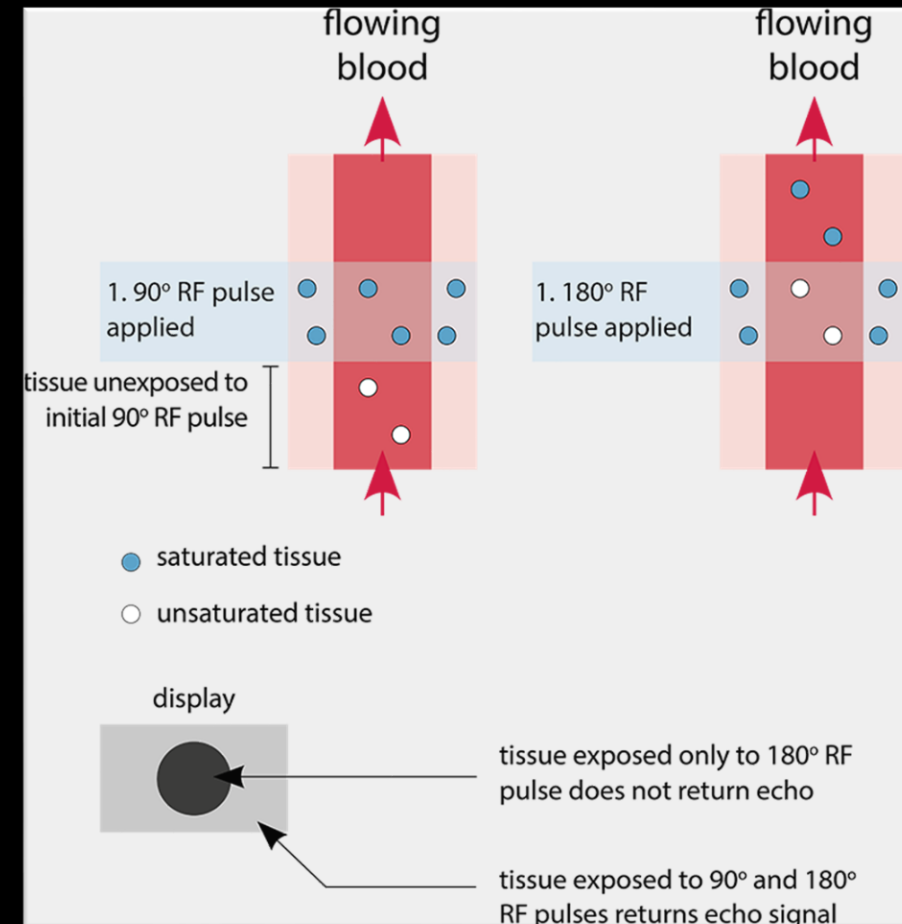

MRA - TOF

- Influence of flow direction

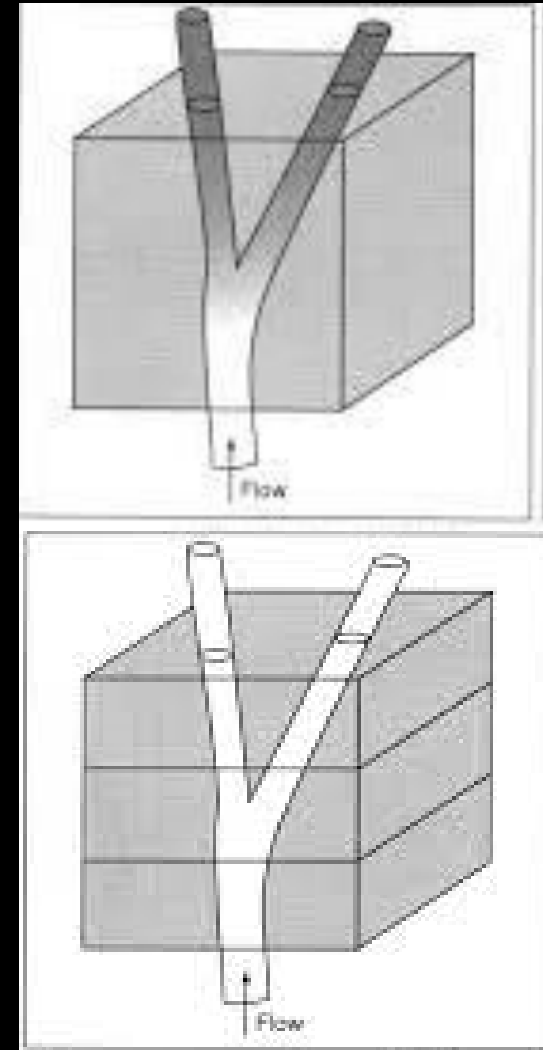
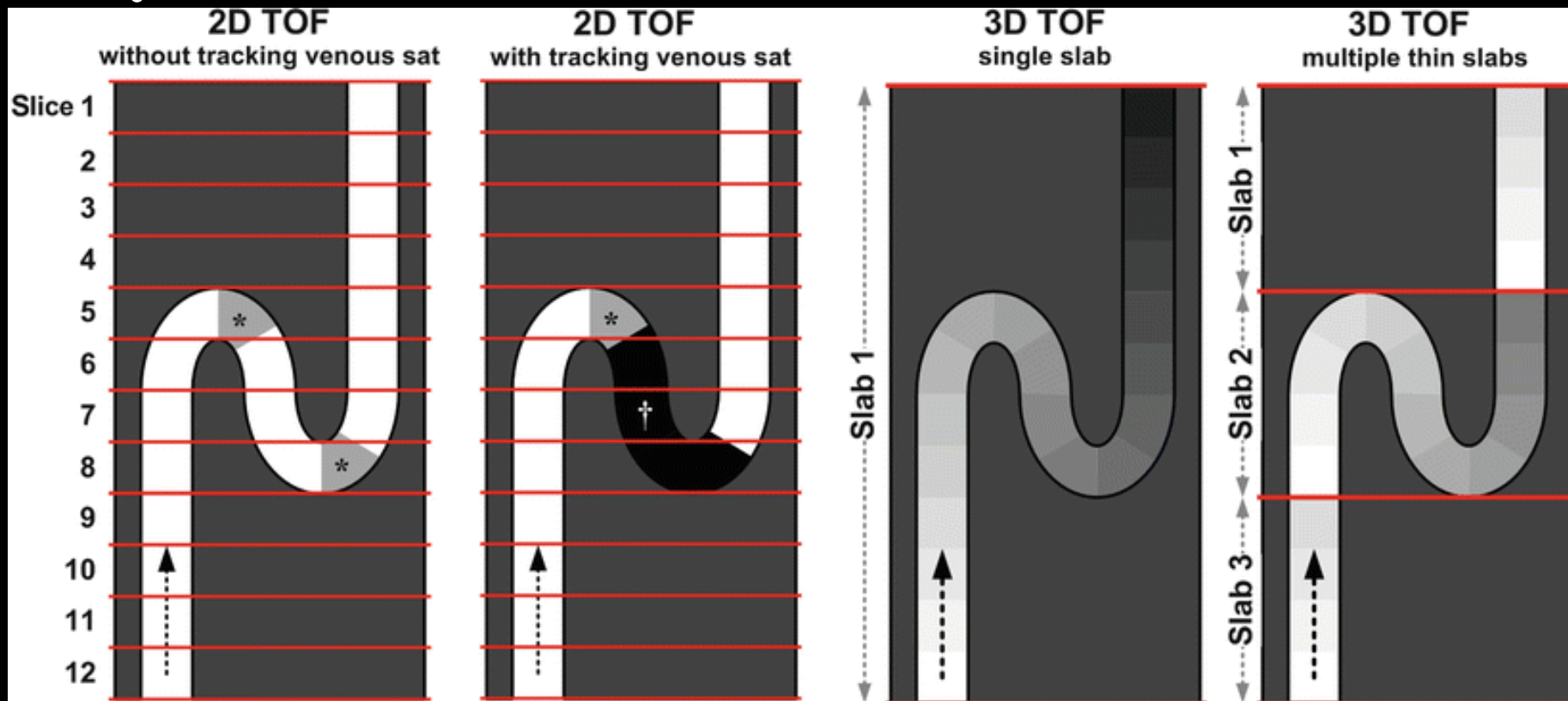

MRA - TOF

- TE = min
- TR 20 – 50 ms
- α 10° - 40°

$\alpha = 10^\circ$



$\alpha = 20^\circ$



$\alpha = 40^\circ$

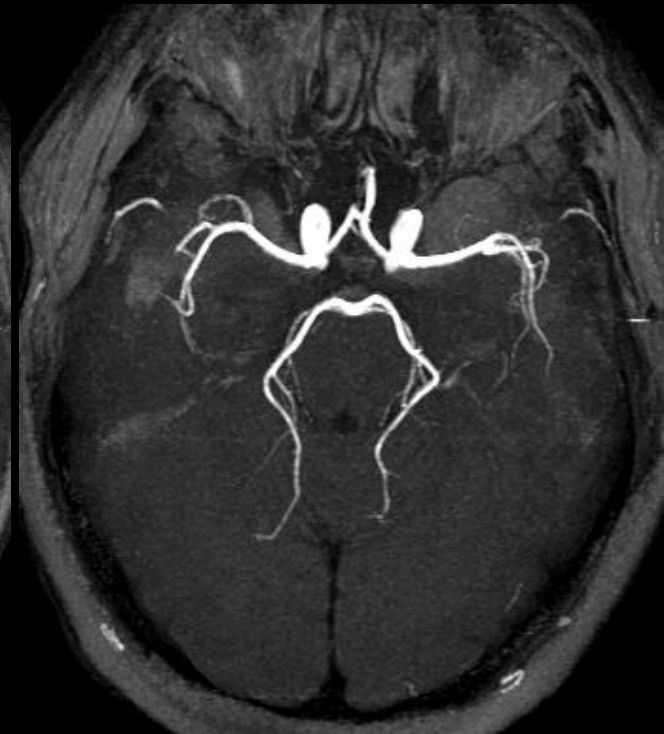

MRA – BFFE/FIESTA

- Selective inverse pulse
- Incoming blood is uninvited
- Quick acquisition required
- Breath triscopy/ECG
-

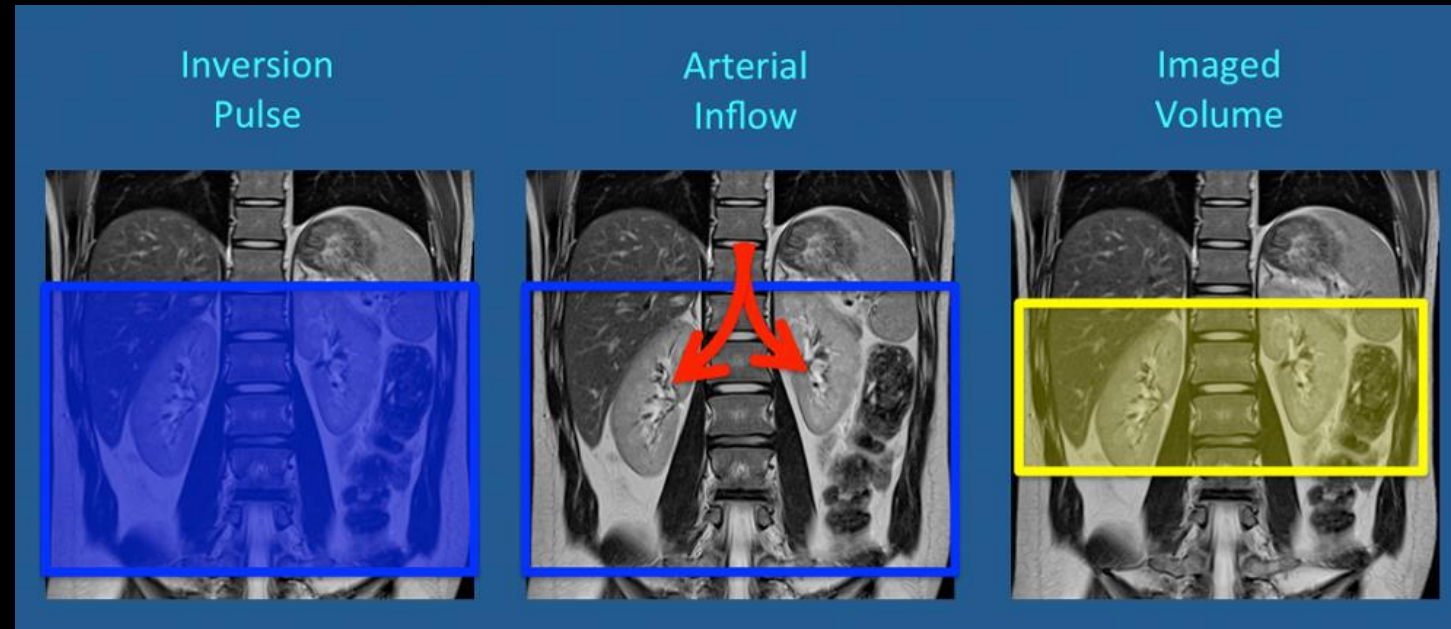
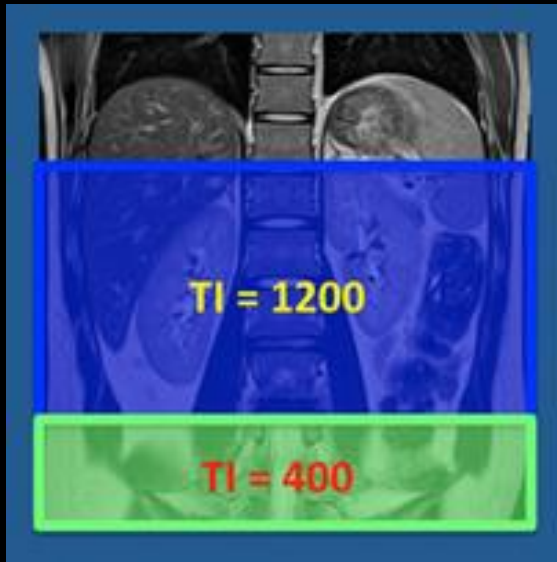
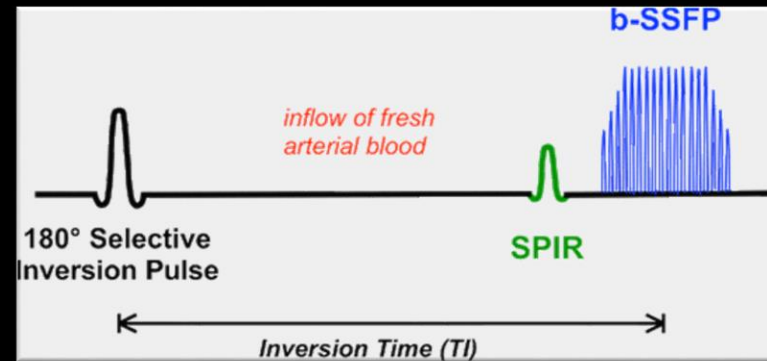

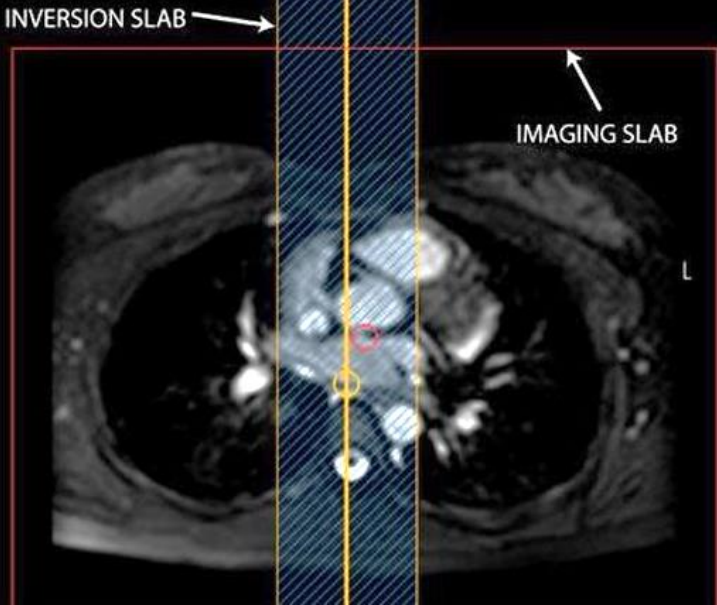

MRA – BFFE/FIESTA

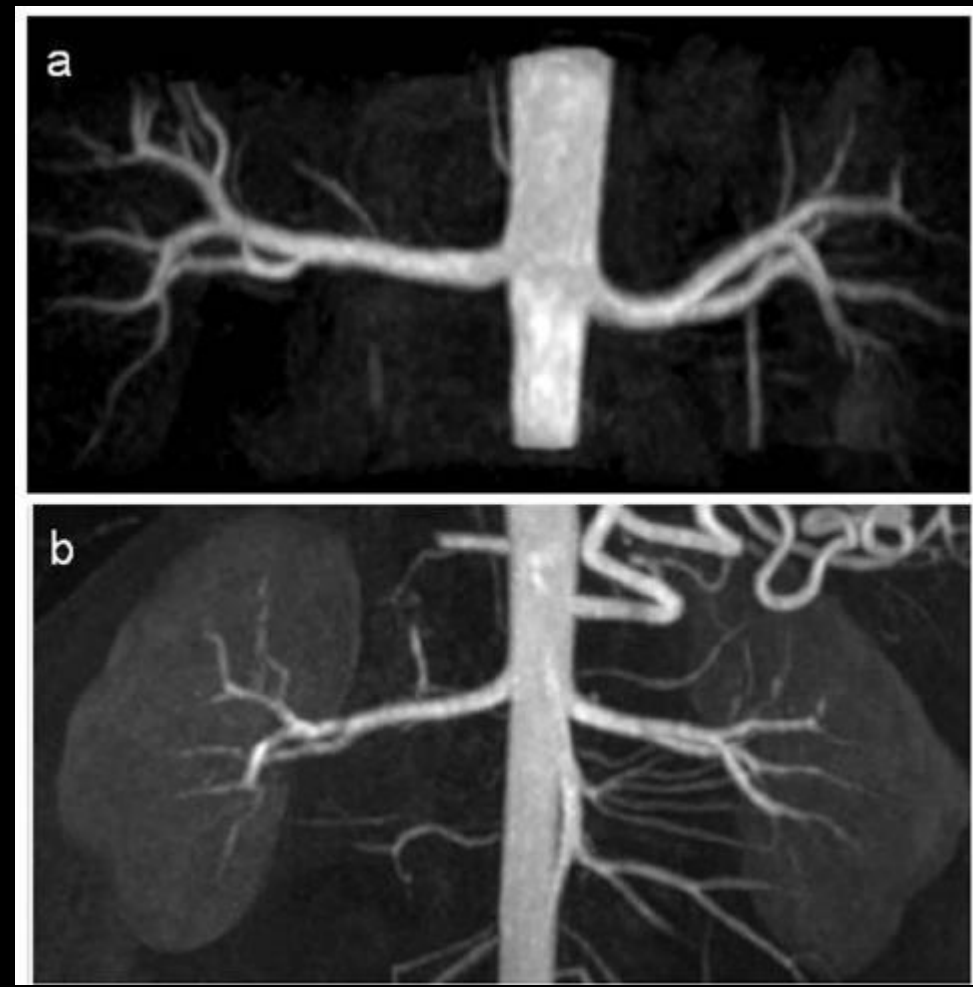
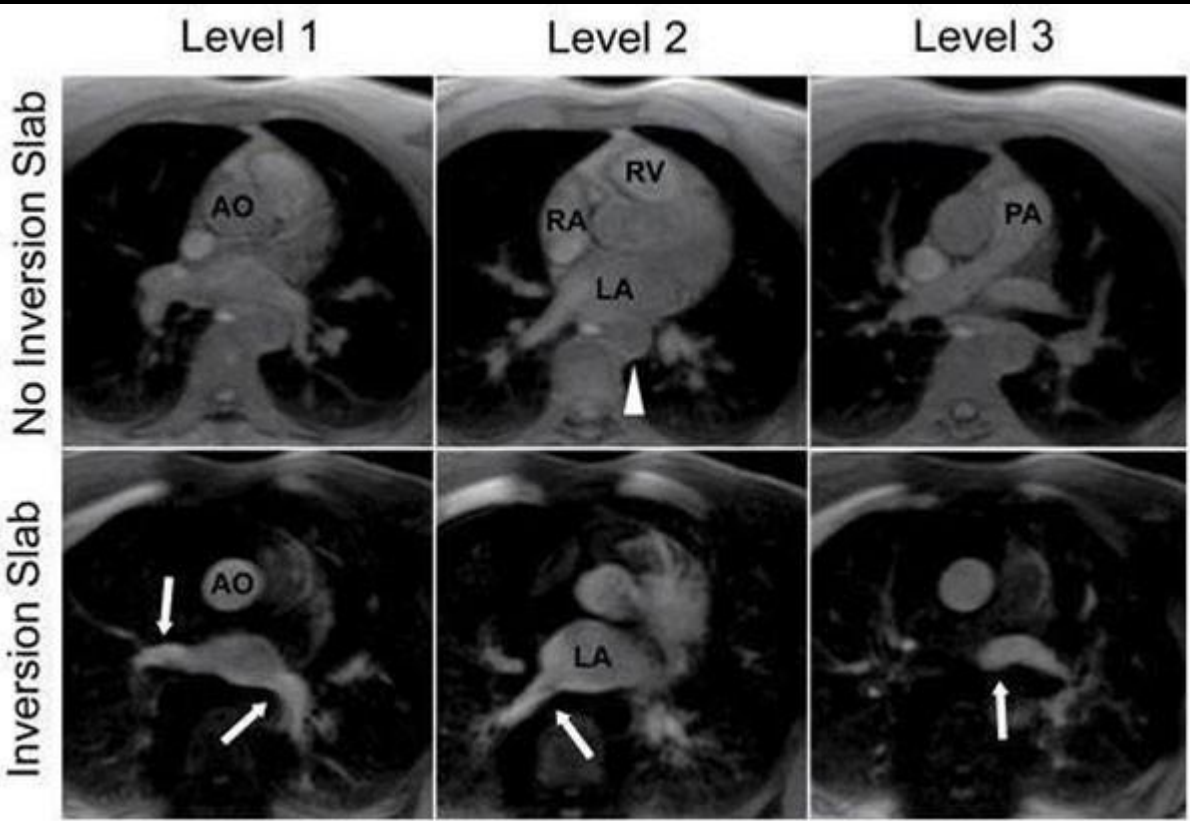

PERIPHERAL MRA

- Blood in the sys. And dias. Different signal
- Subtraction
- EcG tinging
- Pulsation is essential
-

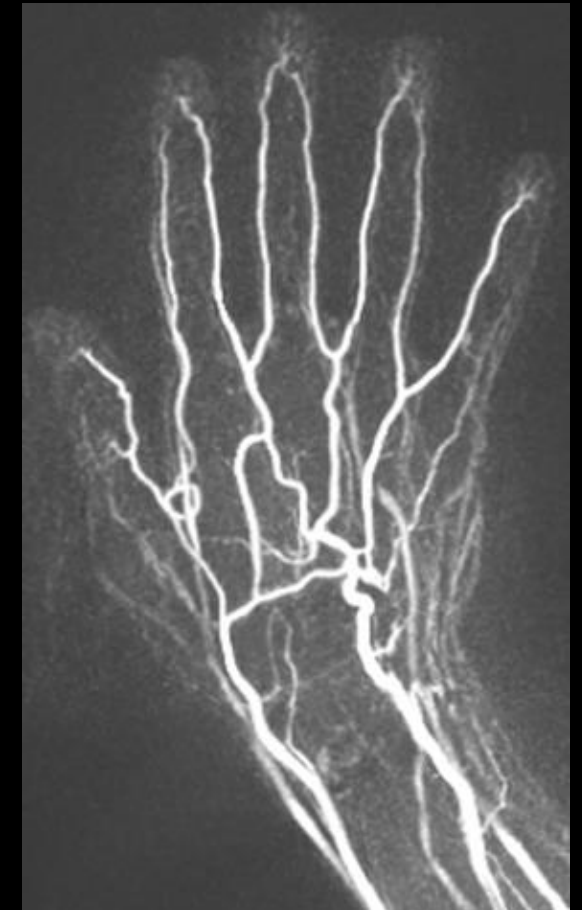
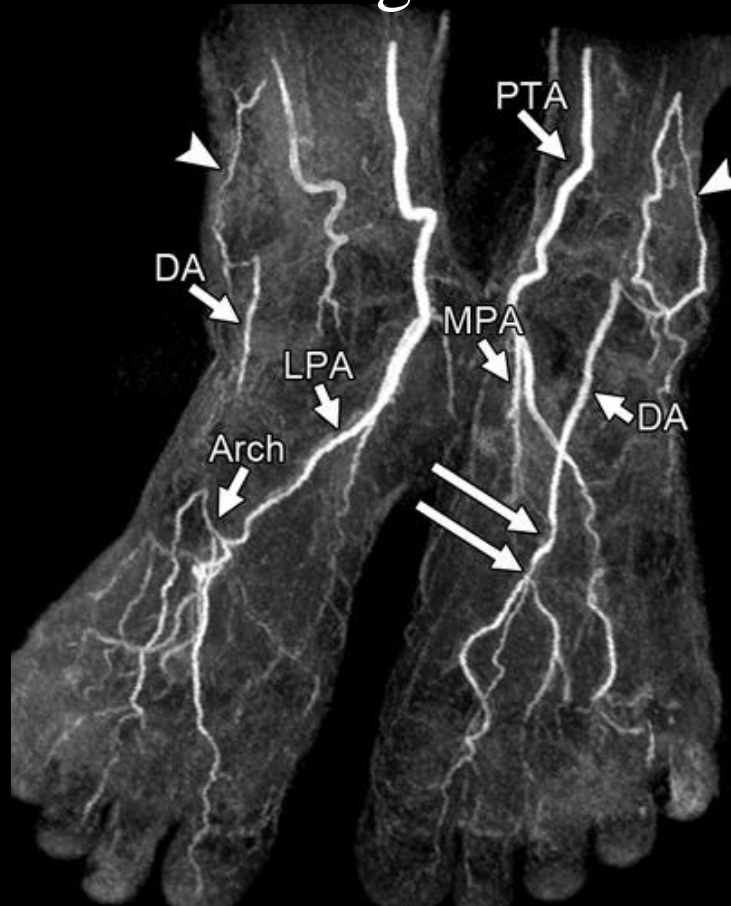
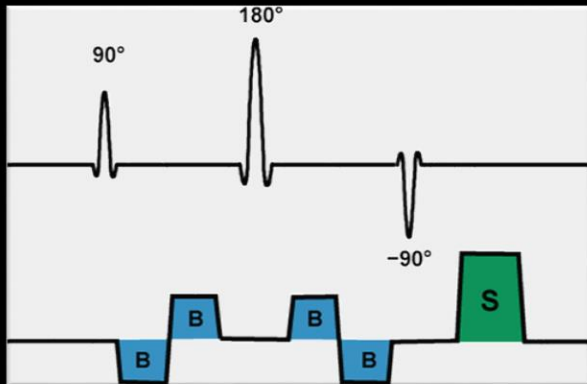

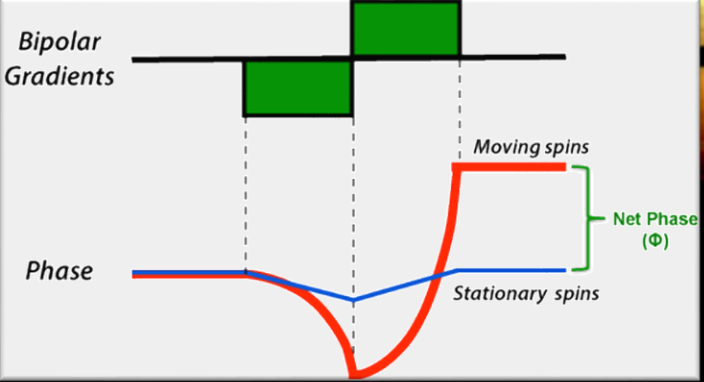

MRA – PHASE CONTRAST

- Bipolar gradient
- Motion = phase shift
- Phase shift velocity \sim
- Encoding in 3 directions
- Quantification
- Determination of $v_{max} = >$ "overflow"
- Pulsation/turbulence artifacts
-

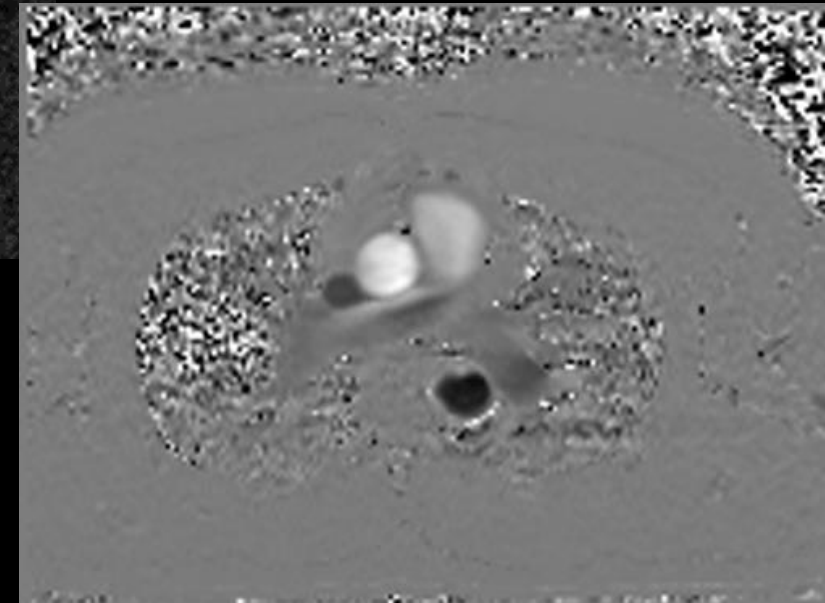

MRA – CONTRAST

- Principle:
- When $TR \ll T1 \Rightarrow$ low signal
- Presence of KL = destruction $T1 =$ higher signal
- The more KL, the greater the shortening
- Quantity optimization
- Application speed optimization
- Optimization TE, TR, α
- Timely start of measurements
- The right choice of data collection
- Use of parallel techniques

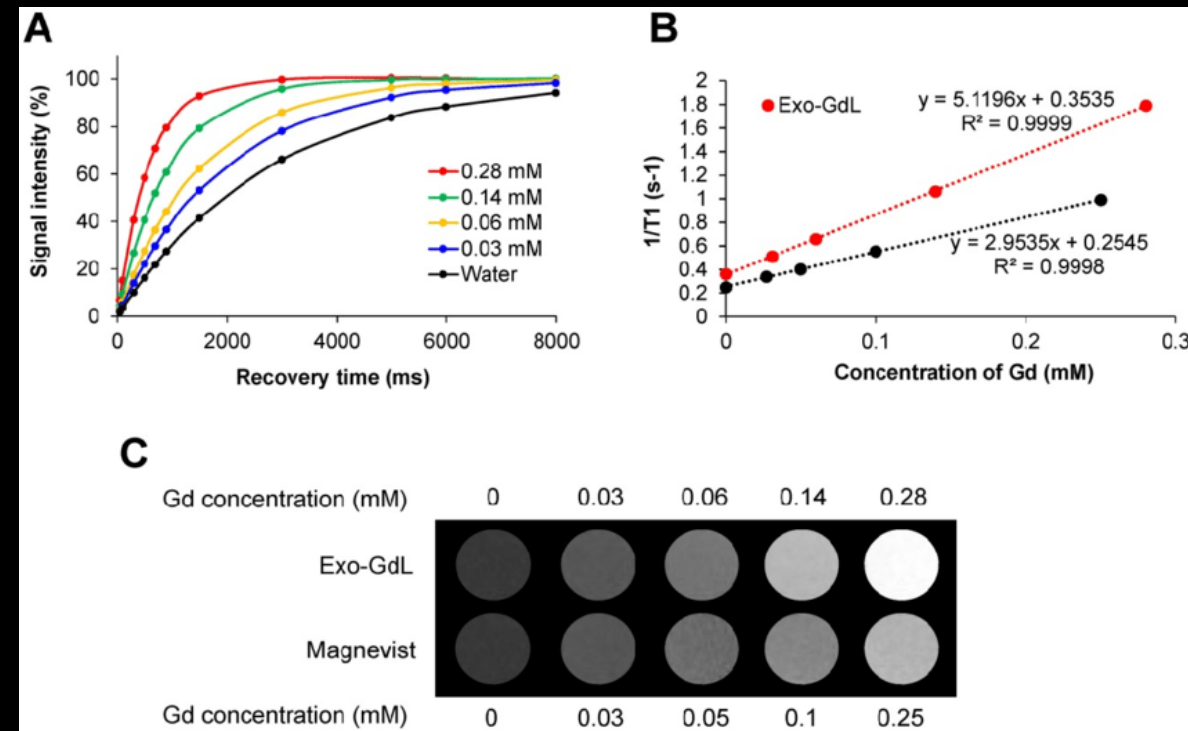

MRA – CE

- Quick Sequence (3D GRE)
- Min TE i TR (~1 resp. ~4 ms)
- Suitable spatial resolution of the given vessel
- Suitable measurement volume
- Both above will affect accruals
- Optimal α ($>$ Ernst angle)
- T1 blood 50 – 150 ms according to KL concentration
-

TR	Ernst angle (T1 = 25 ms)	Ernst angle (T1 = 50 ms)	Ernst angle (T1 = 100 ms)	Ernst angle (T1 = 150 ms)
6	38	28	20	16
5	35	25	18	14
4	32	22	16	13
3	28	20	14	11
2	23	16	11	9
1.5	20	14	10	8

MRA – CE TIMING

- Bolus
- Application ~2ml KL
- Measurement of inflow time
- Then the rest of the KL and measurements
- Advantages
 - Precise determination of the beginning of the measurement
- Disadvantages
 - Part of KL not used
 - Longer measurement
 - Background contamination KL



MRA – CE TIMING

- Fluoro triggering/BolusTrak
- Quick artery scan
- When KL arrives, the measurement starts
- Advantages
- Use of all KL
- Semi/Automatic
- Disadvantages
- A more complex method for RA
-

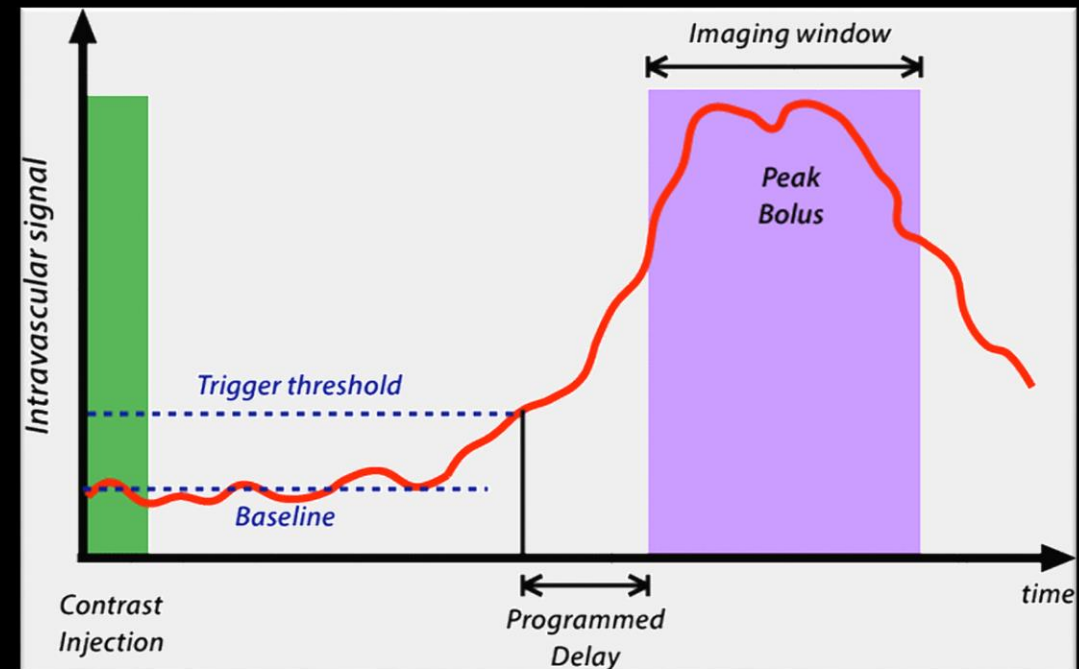

MRA – CE TIMING

- Continuous shooting
- TRICKS/4D-TRAK
- Sensing on before KL administration
- Continuous image formation during KL
- Compromise prost. and time. resolution
- Advantages:
 - No need to time
 - Possibility to display the optimal phase
 - Advanced data collection = possibility to improve time.
- Disadvantages:
 - The necessity of compromise time and simplicity. resolu
 - Max. gradients = > greater stimulus. perif. Nerves

