

Lectures on Medical Biophysics

Structure of living matter

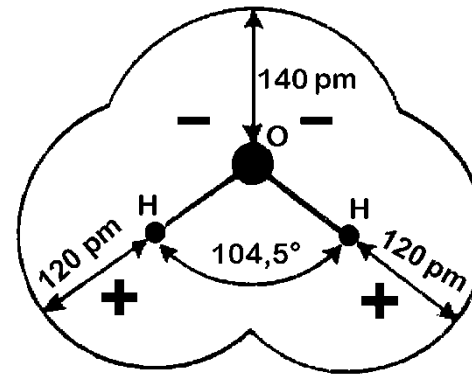

Lecture outline

Water

Properties of colloids

Structure of proteins

Structure of nucleic acids

This lecture deals only with selected components of living matter with distinct biophysical properties. Importance of some other components, e.g. electrolytes will be shown in the lecture on bioelectric phenomena. Check on further information in textbooks of biology and biochemistry.

Water

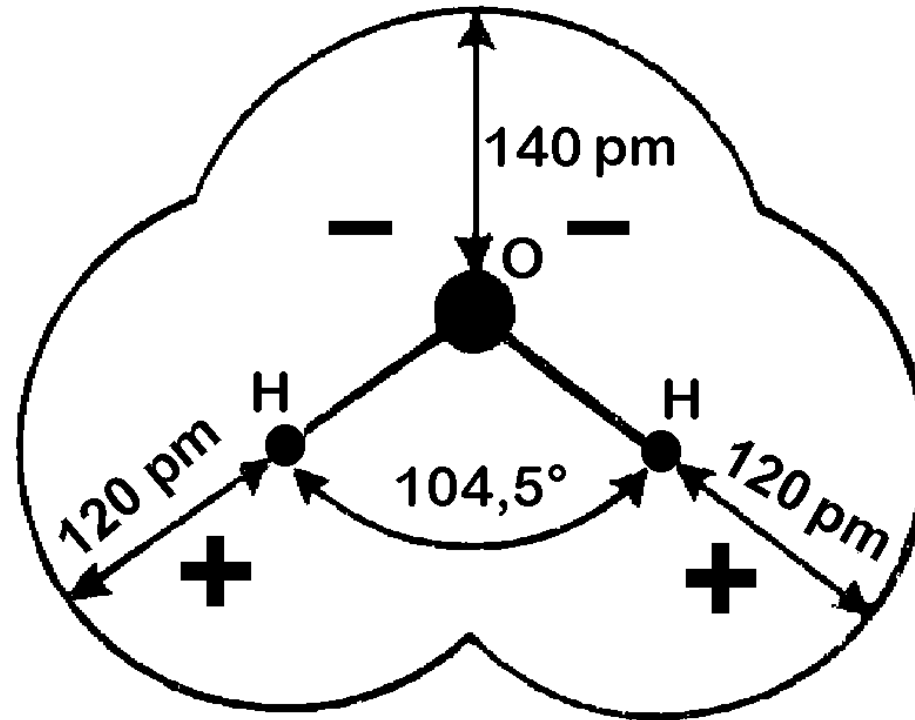

Molecules of water are strongly polar because of oxygen electronegativity. Moreover, between the oxygen and hydrogen atoms of neighbouring molecules, **hydrogen bonds** are formed. They join water molecules in aggregates – clusters.

Hydrogen bonds between water molecules

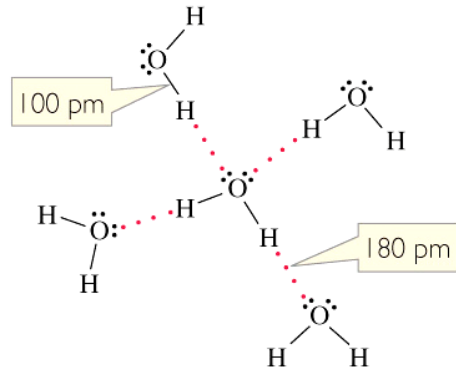

(a)

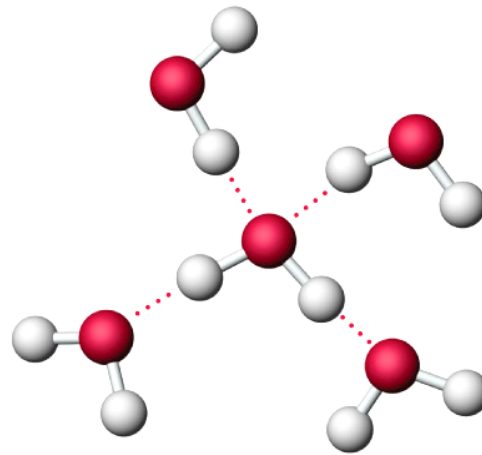

Liquid water

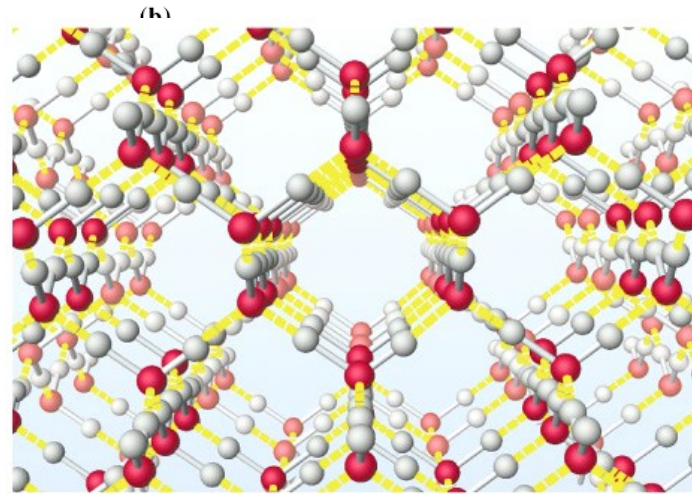

(a)



(b)

Ice

Colloids

Colloids – also known as non-true solutions – the solution consists of solute particles of diameter about 10 – 1000 nm dispersed in the solvent.

We can distinguish two types of colloids according to the type of binding forces:

- Micellar colloids (also associative, small particles are bound together by *van der Waals bonds*)
- Molecular colloids (particles are macromolecules which subunits are bound together by *covalent bonds*)

Weak chemical bonds

Hydrogen bonds
Hydrophobic interaction
van der Waals bonds

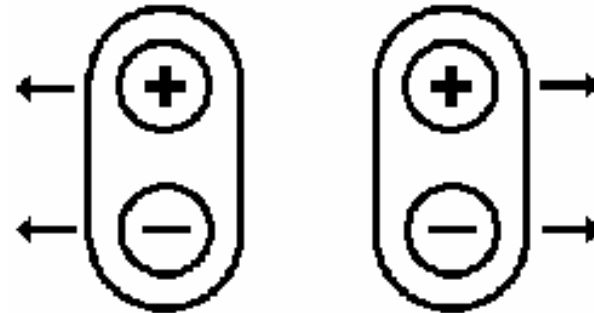

A) dipole - dipole parallel

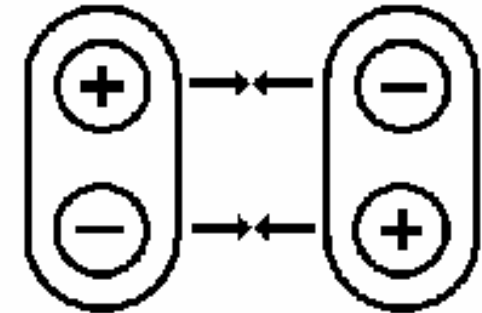

B) dipole - dipole antiparallel

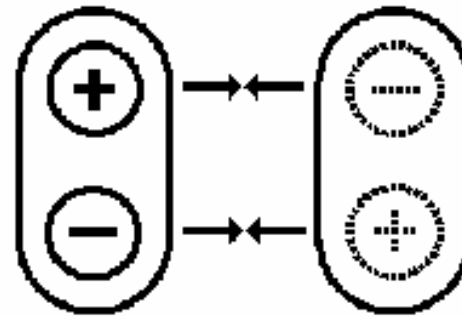

C) dipole - induced dipole

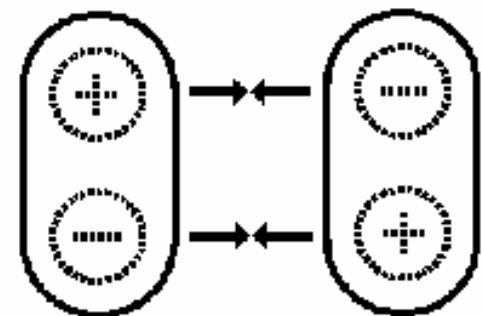

D) dispersion force

Also London forces, sometimes not classified as van der Waals bonds

Properties of colloids

Mechanical: rigidity, elasticity, viscosity – caused by covalent and weak chemical bonds

These properties depend on the form of colloid:

sol (liquid) or gel (solid). Gel formation = gelatinisation

Optical:

Light scatter: Tyndall effect (opalescence). Light can be scattered off the colloid particles. Track of a light beam passing through a colloid is made visible by the light scattered by the colloidal particles.

Optical activity: Colloidal particles can rotate the plane of polarization of plane-polarised light passing through the colloid

Electrical: see lecture on instrumental methods in molecular biophysics

Tyndall effect in micellar and molecular colloids



- In solution of colloidal gold

<http://mrsec.wisc.edu/edetc/cineplex/gold/>

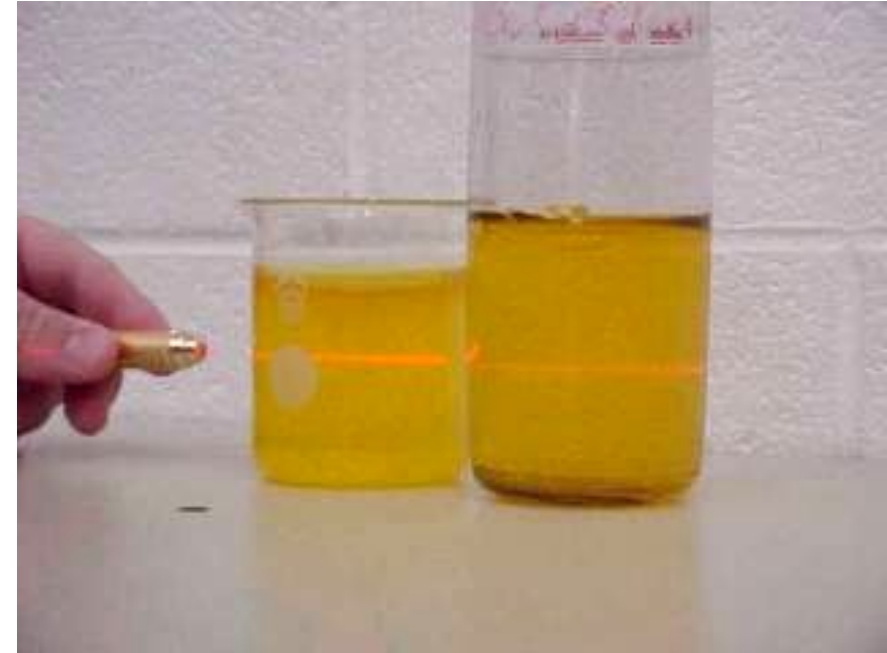

- In solution of gelatin (a protein)

<http://link.springer-ny.com/link/service/journals/00897/papers/0006002/620095mb.htm>

Types of Colloids - Biopolymers

- According to the affinity of the biopolymer to solvent (water)
 - **Lyophilic (hydrophilic)** - form stable solutions
 - **Lyophobic (hydrophobic)** - form unstable solutions
- According to the shape of the biopolymer (the shape is also influenced by the solvent!)
 - **Linear** (fibrillar – DNA, myosin, synthetic polymers.....also scleroproteins, mostly insoluble in pure water)
 - **Spherical** (globular – haemoglobin, glycogen ... also spheroproteins, mostly soluble in pure water)

Chemical composition of proteins

According to the products of hydrolysis:

- simple (only amino acids in hydrolysate)
 - conjugated (not only amino acids in hydrolysate)
 - Nucleoproteins
 - Haemoproteins
 - Flavoproteins
 - Metalloproteins
 - Lipoproteins
 -
- (see Biochemistry)

Structure of proteins

- Structural units of proteins are amino acids (AA), connected by peptide bond:

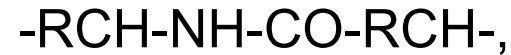

which can hydrolyse:

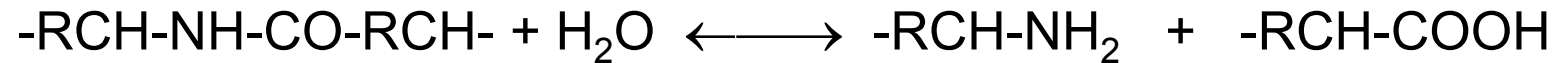

- The carboxylic and amino groups can dissociate or protonise. E.g. the glutamic and asparagic acids have one free carboxylic group:

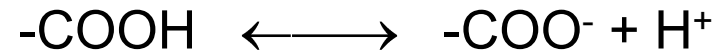

- AA lysine and arginine have one free amino group, which can protonise:

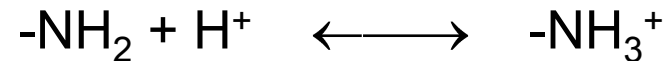

- In proteins, 20 different AA can be found which can be divided into AA with polar and non-polar side chain.
- AA with aromatic ring or heterocycle (phenylalanine, tyrosine, tryptophan) strongly absorb UV light around 280 nm.
- AA cysteine contains sulphhydryl (thiol) group (-SH), which is oxidised by dehydrogenation and connected with dehydrogenated group of another cysteine residue by covalent disulphidic bridge (bond -S-S-).

Structure of proteins

Disulphidic bridges (in yellow) stabilise the protein structure (bovine ribonuclease A)

•http://cwx.prenhall.com/horton/medialib/media_portfolio/text_images/FG04_28a-b.JPG

Molar absorption coefficient, ϵ

Wavelength (nm)

Absorption spectrum of free phenylalanine, tyrosine and tryptophan in UV range

•According to: <http://www.fst.rdg.ac.uk/courses/fs460/lecture6/lecture6.htm>

Structure of proteins

- **Primary** (sequence of covalently bound AA residues)
- **Secondary** (mutual spatial arrangement of neighbouring links of the polypeptide chain – given mainly by hydrogen bonds)
 - α -helix
 - β -structure (pleated sheet)
 - other
- **Tertiary** (spatial arrangement of the polypeptide chain as a whole – given by hydrophobic and hydrogen bonds, stabilised by -S-S-bridges)
- **Quaternary** (a way of non-covalent association of individual polypeptide chains (subunits) in whole of higher order)
 - Homogeneous – all subunits are identical
 - Heterogeneous – subunits of two or more kinds

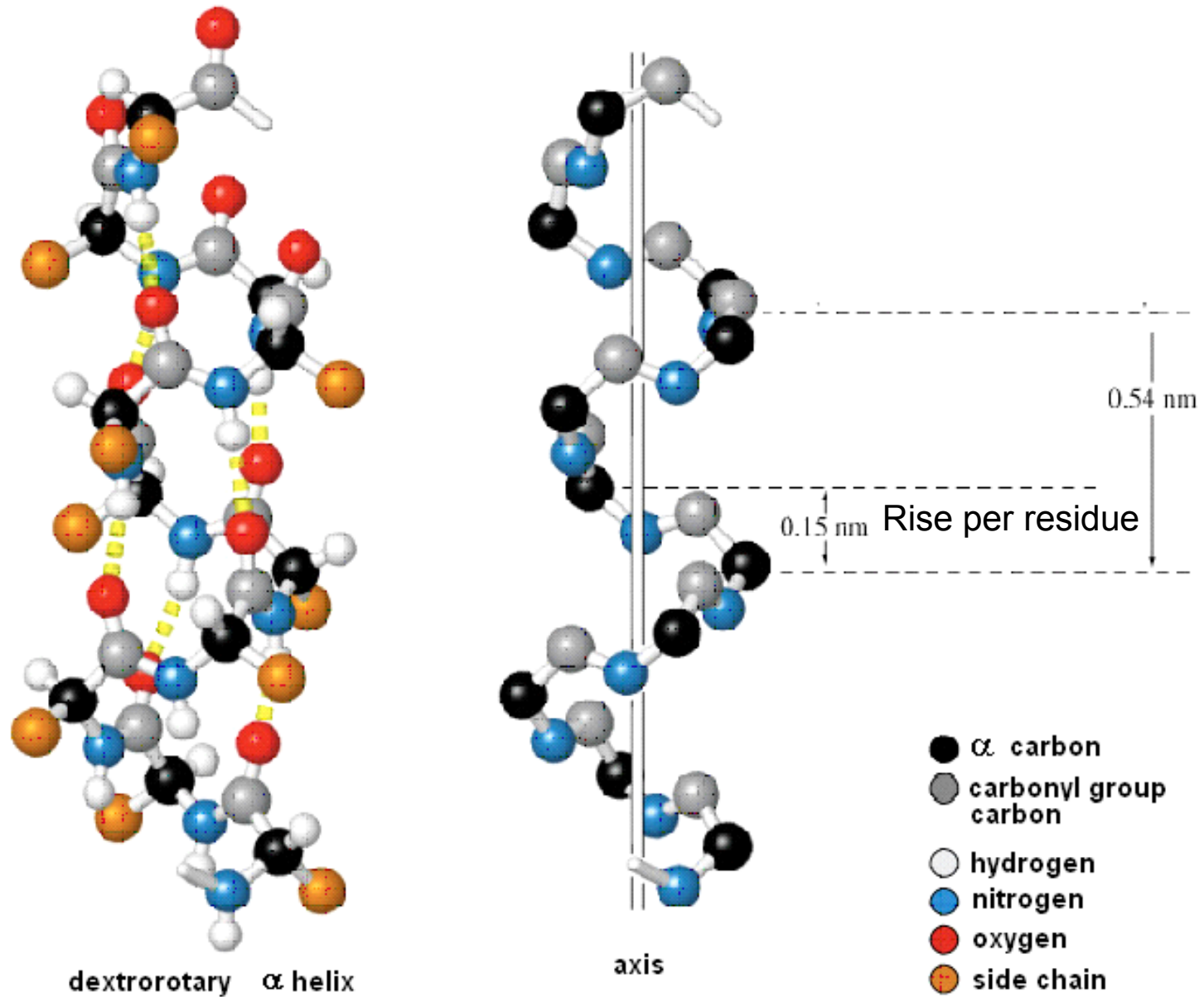

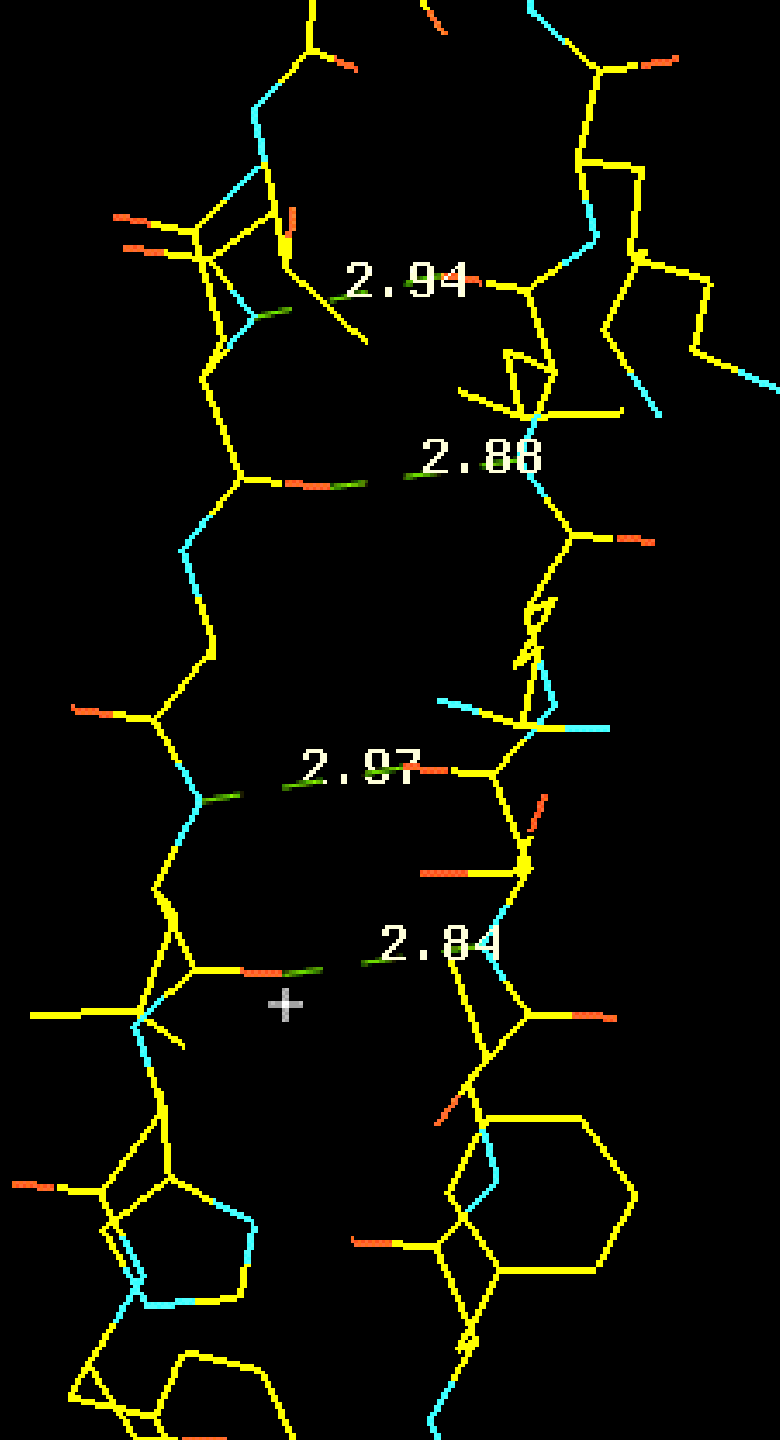

β -structure (pleated sheet – antiparallel model)

[http://www-
structure.llnl.gov/Xray/tutori
al/protein_structure.htm](http://www-structure.llnl.gov/Xray/tutorial/protein_structure.htm)

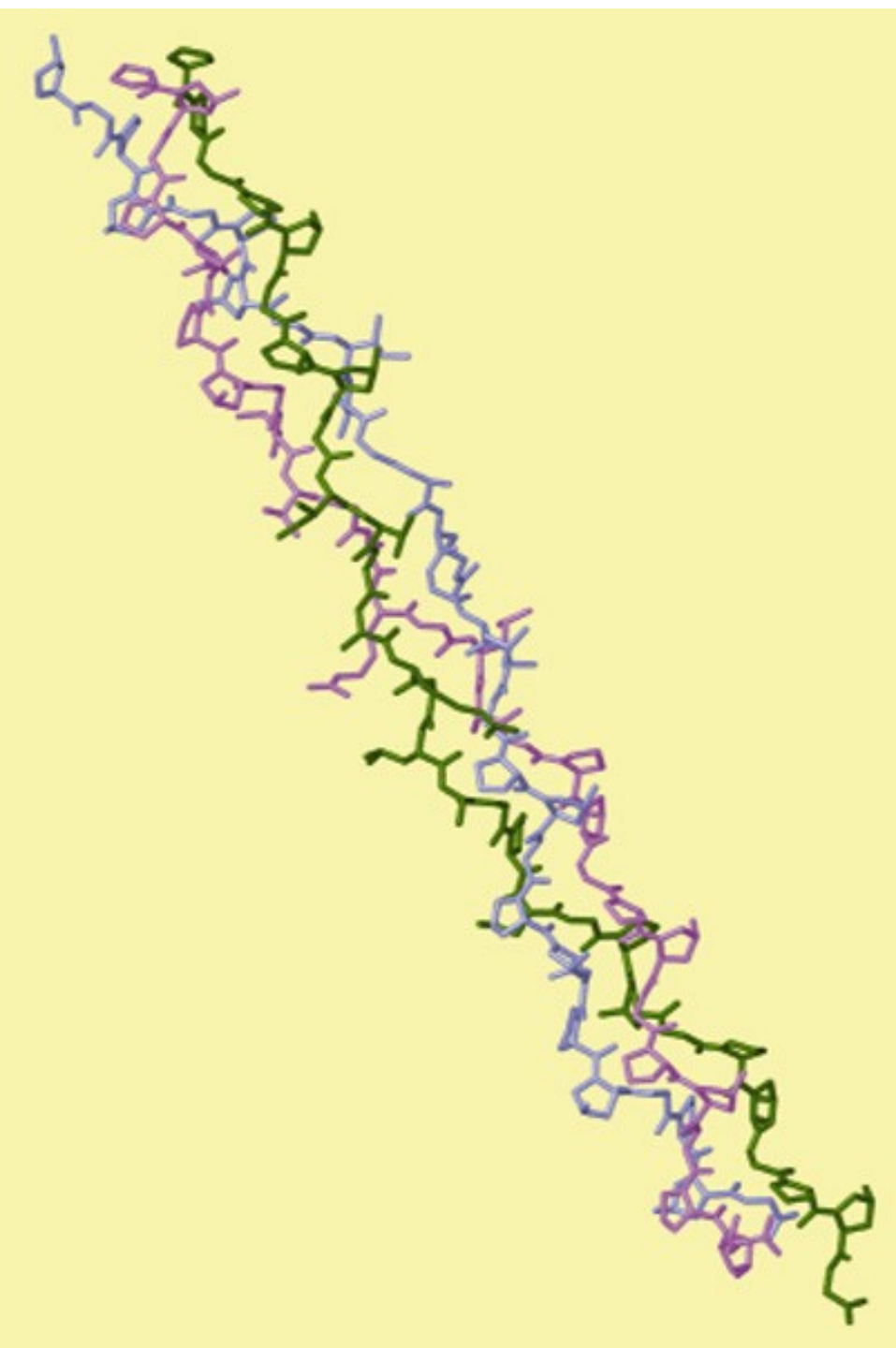

Triple helix of collagen

http://cwx.prenhall.com/horton/medialib/media_portfolio/text_images/FG04_34.JPG

(a) primary structure

–Ala–Glu–Val–Thr–Asp–Pro–Gly–

(b) secondary structure

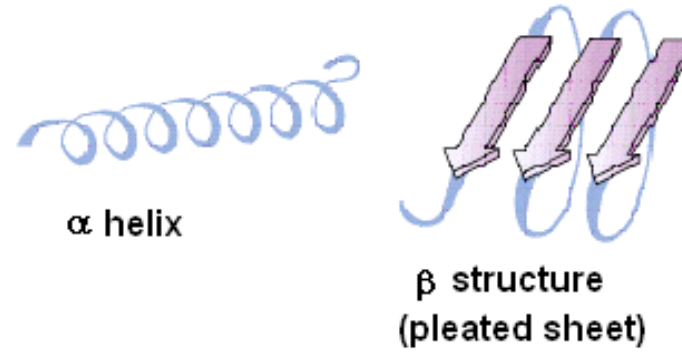

(c) tertiary structure

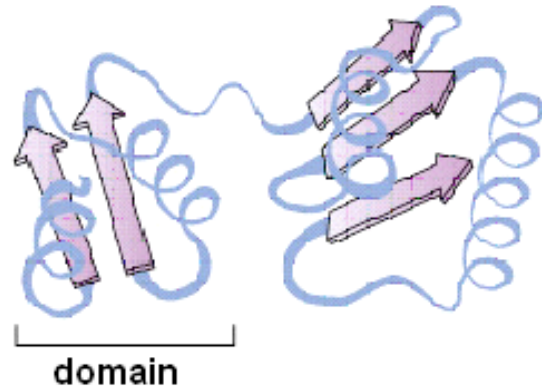

(d) quaternary structure

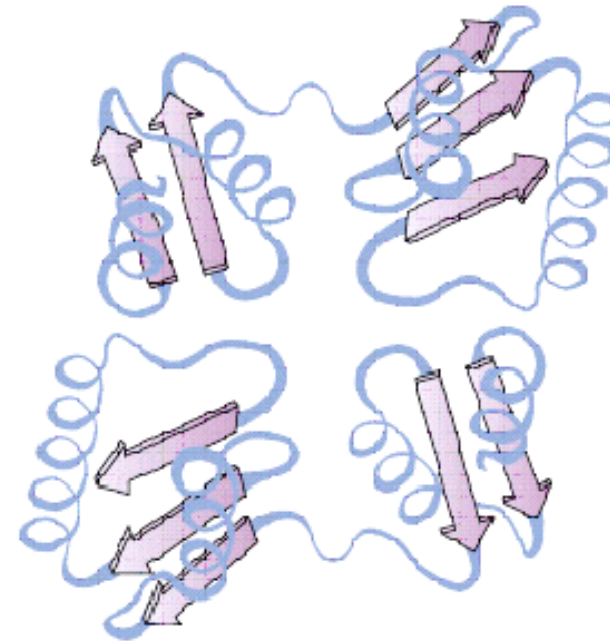

Structure of nucleic acids (NA)

- Mononucleotide (the structural subunit of NA) is formed by:
 - Pyrimidine (C, U, T) or purine (A, G) nitrogen base
 - Sugar (ribose or deoxyribose)
 - Phosphoric acid residue

- DNA: up to hundreds thousands of subunits. M.w. $10^7 - 10^{12}$. Two chains (strands) form antiparallel double helix.
- RNA:
 - m-RNA (mediator, messenger)
 - t-RNA (transfer)
 - r-RNA (ribosomal)
 - (viral RNA, microRNA ?)

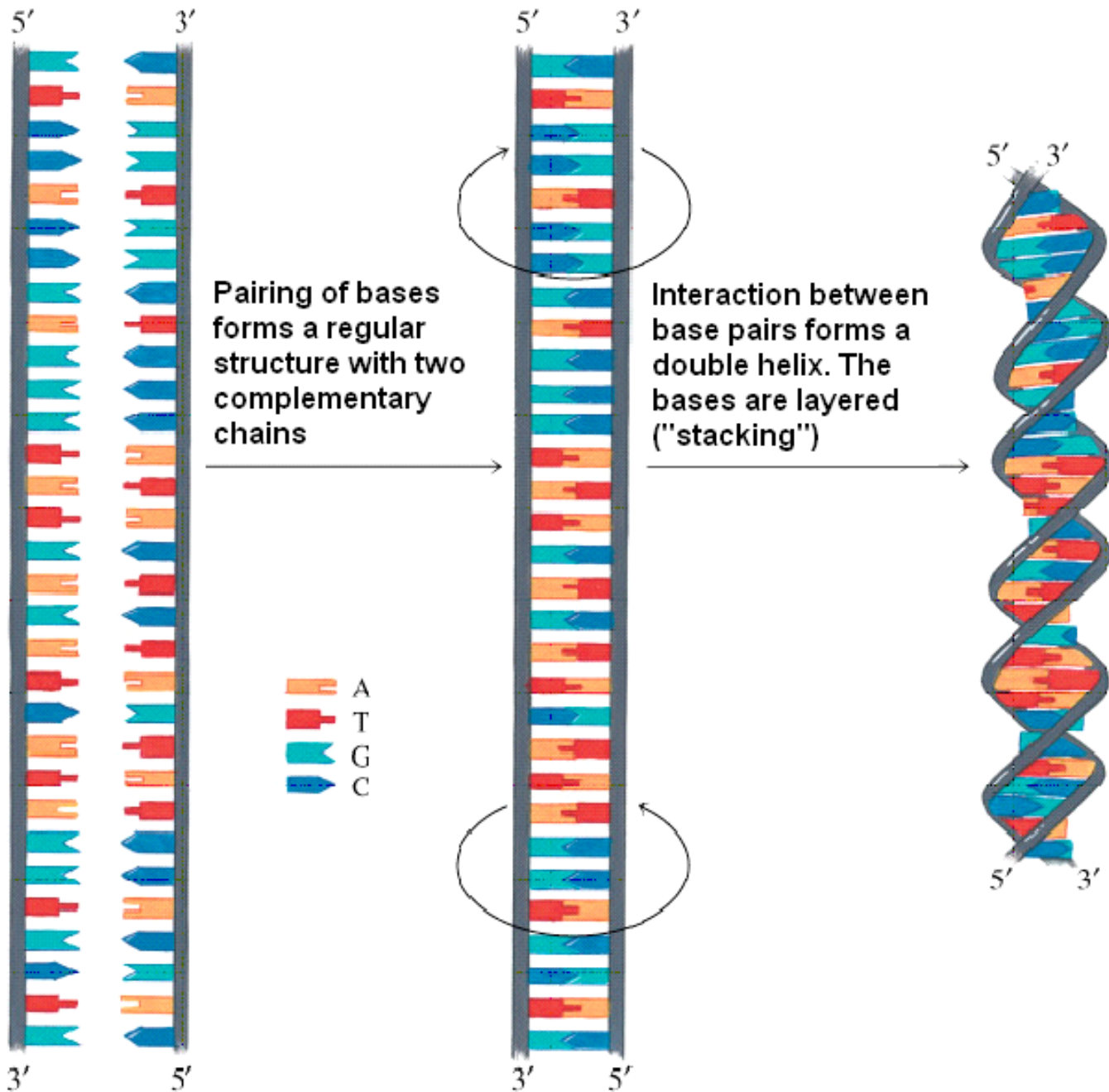

•http://cwx.prenhall.com/horton/media_portfolio/text_images/FG19_13_90035.JPG

(a)

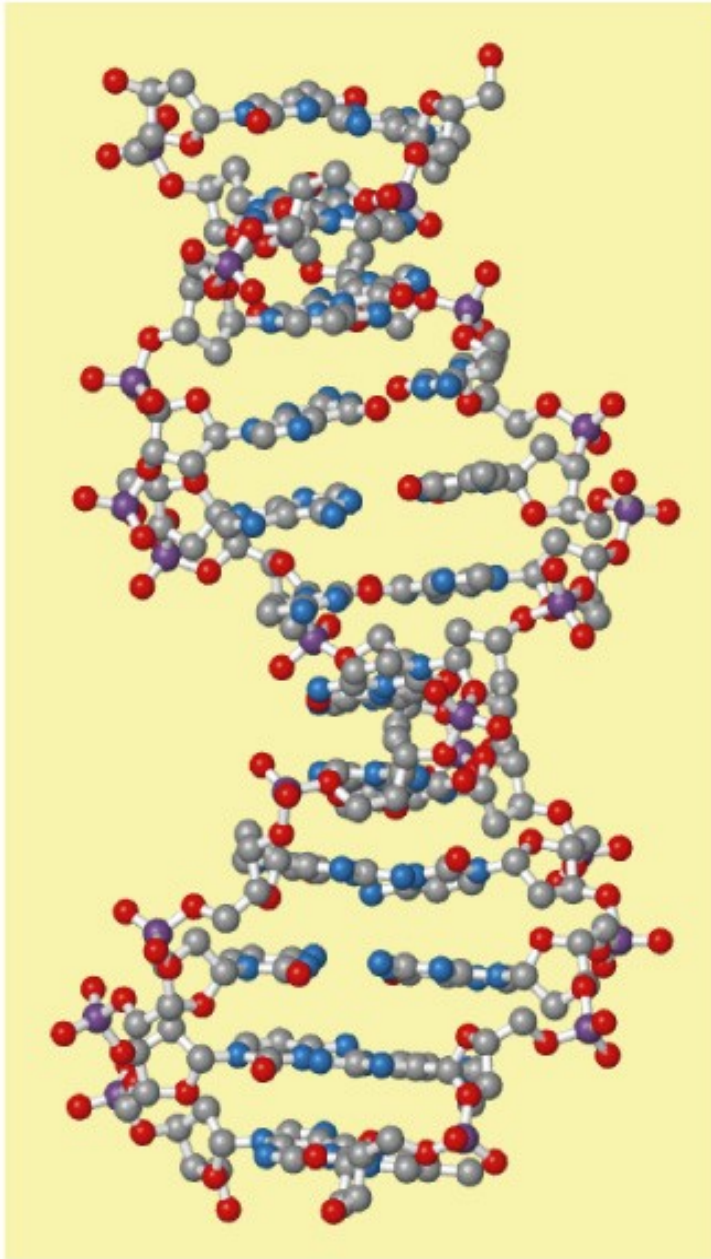

(b)

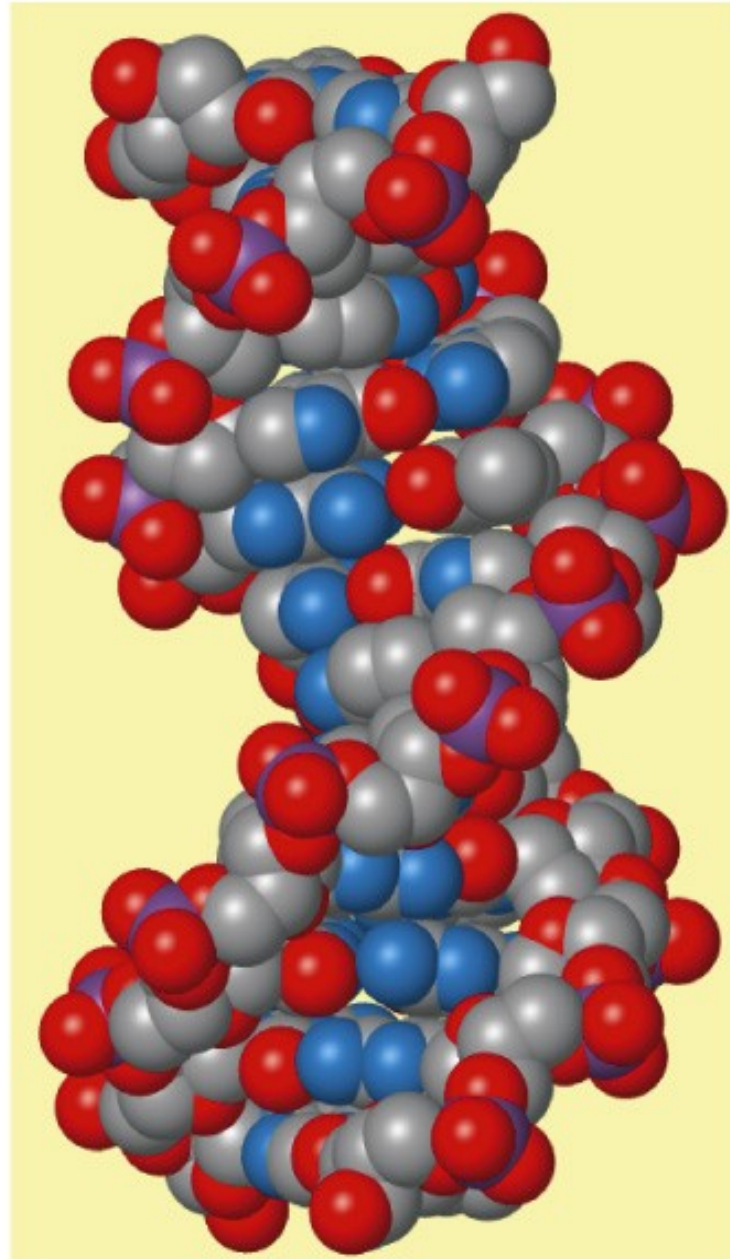

B-DNA

http://cwx.prenhall.com/horton/media_portfolio/text_images/FG19_15aC.JPG

A-DNA – dehydrated, **B-DNA** – commonly present under physiological conditions, **Z-DNA** – in sequences rich on CG pairs

Superhelical structure of circular DNA

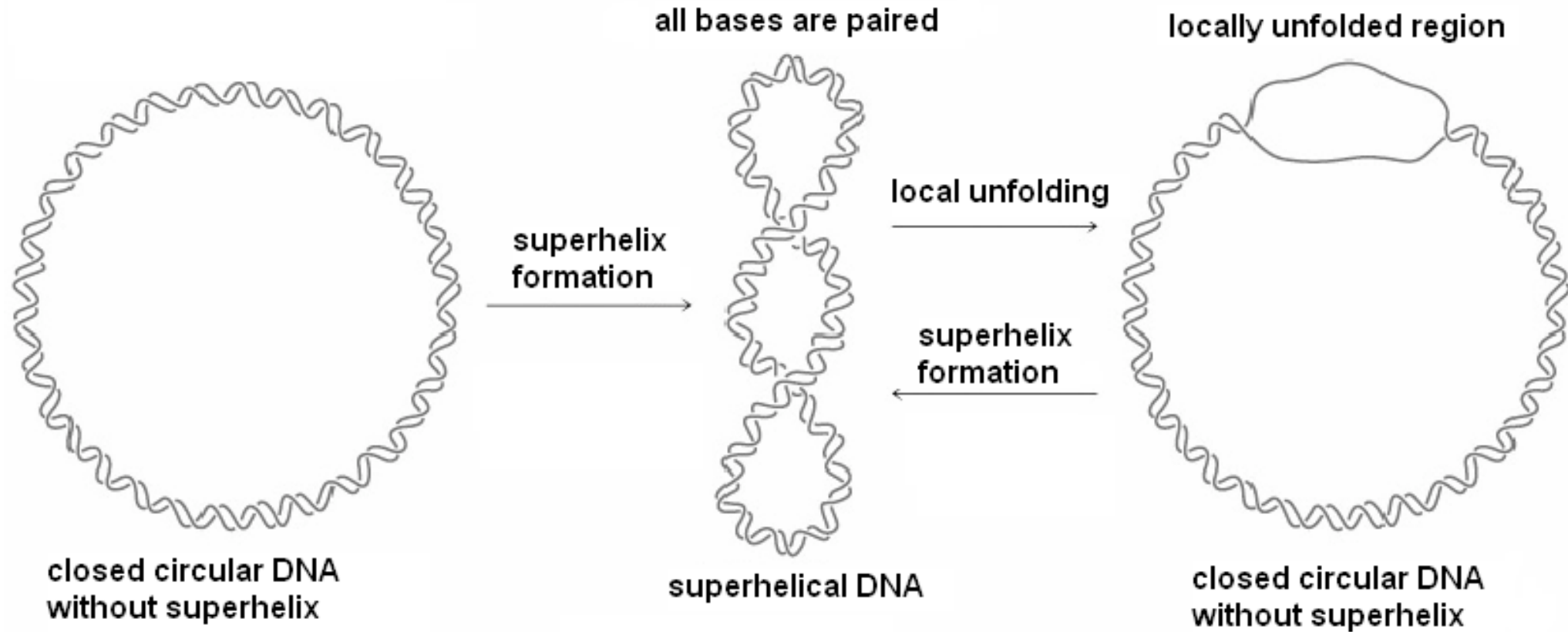

•Podle http://cwx.prenhall.com/horton/medialib/media_portfolio/text_images/FG19_191C.JPG

(a)

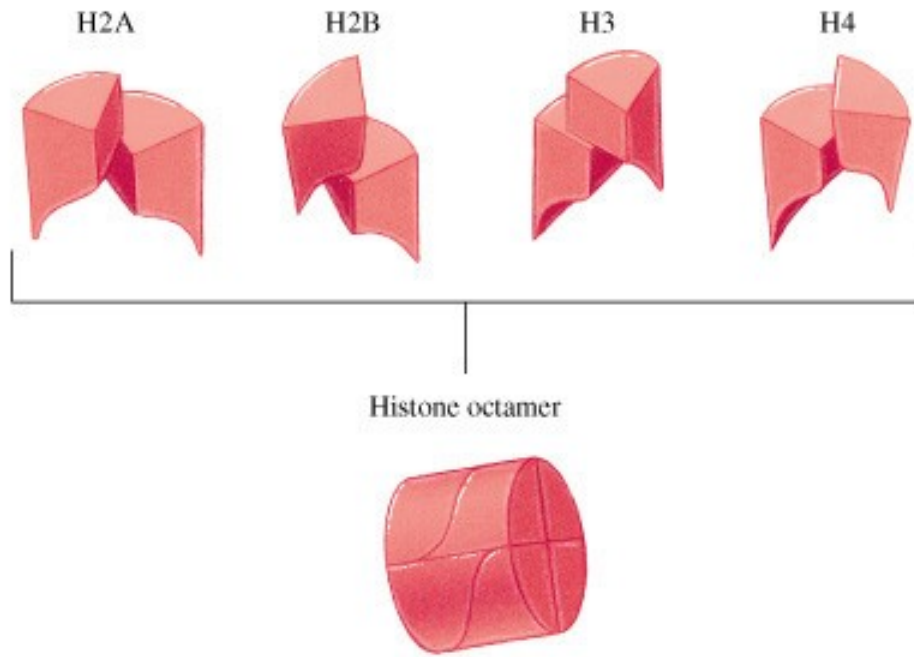

Structure of chromatin

http://cwx.prenhall.com/horton/medialib/media_portfolio/ext_images/FG19_23_00742.JPG,
http://cwx.prenhall.com/horton/medialib/media_portfolio/ext_images/FG19_25_00744.JPG

(b)

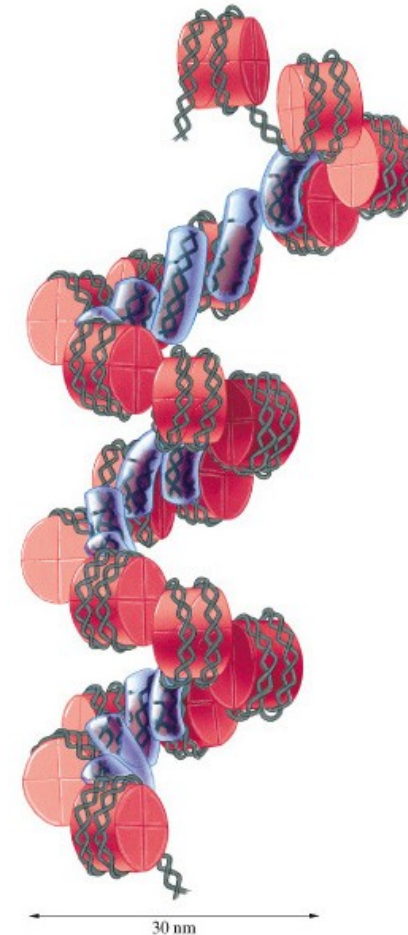
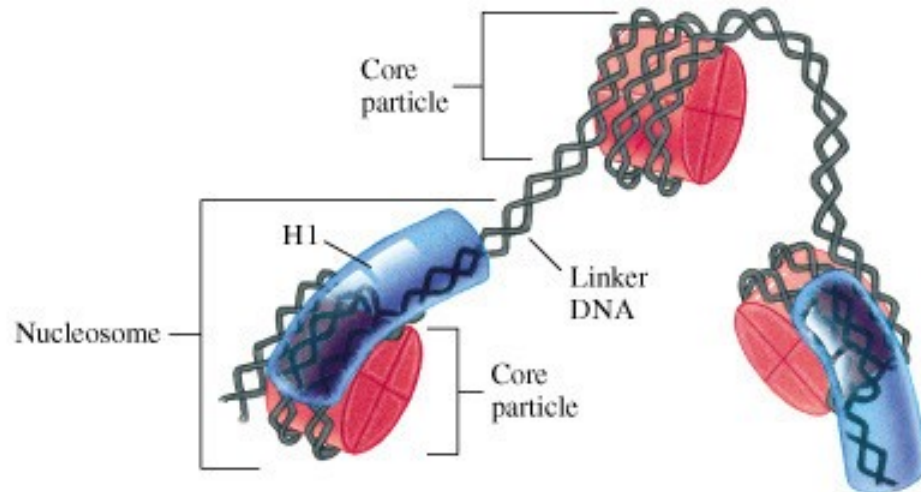

„Clover
leaf
structure“

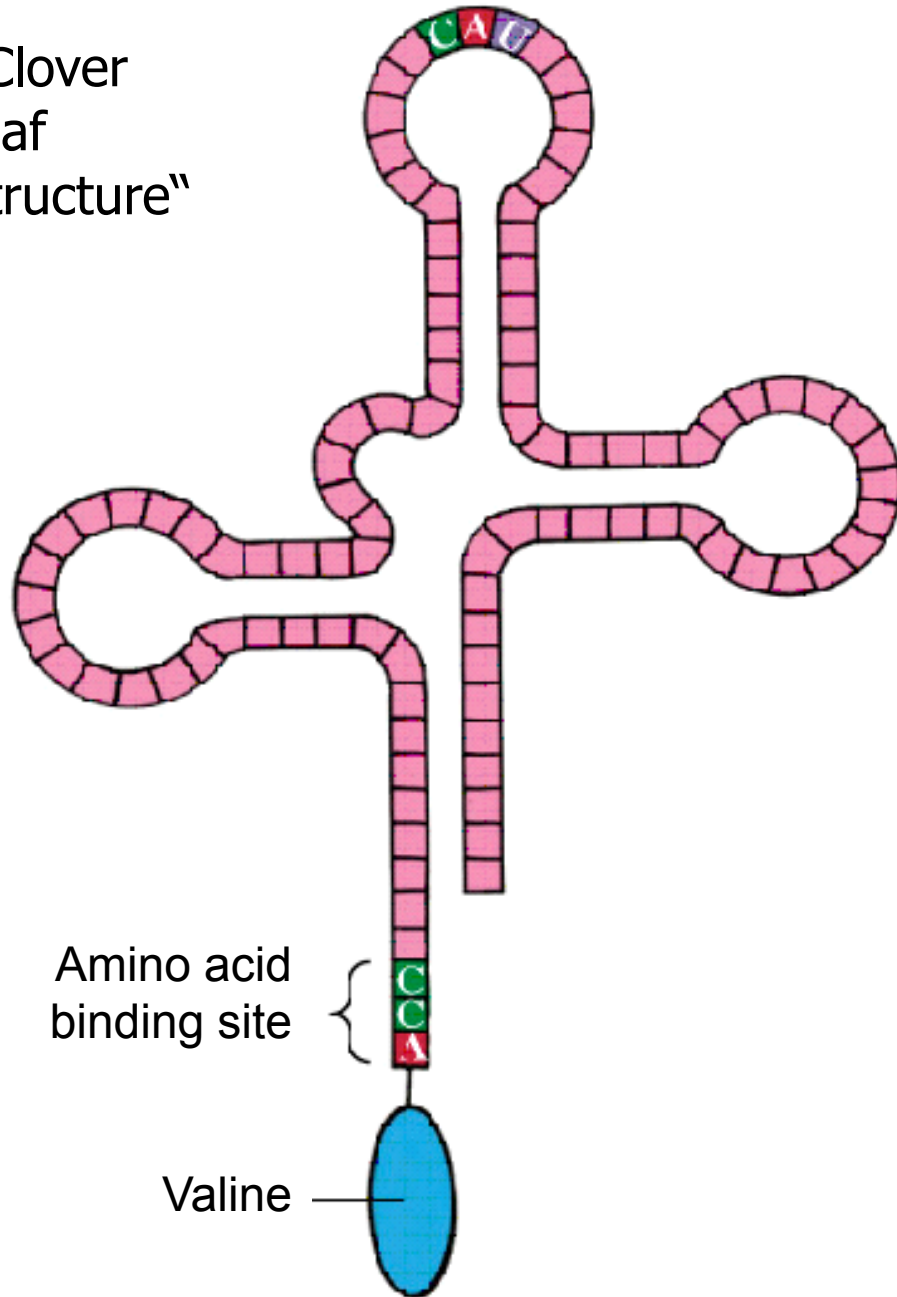

Transfer RNA for valine – schematic t-RNA from yeasts

↓
http://cwx.prenhall.com/bookbind/pubbooks/hillchem3/medialib/media_portfolio/text_images/CH23/FG23_14.JPG, <http://www.imb-jena.de/cgi-bin/ImgLib.pl?CODE=4tra>

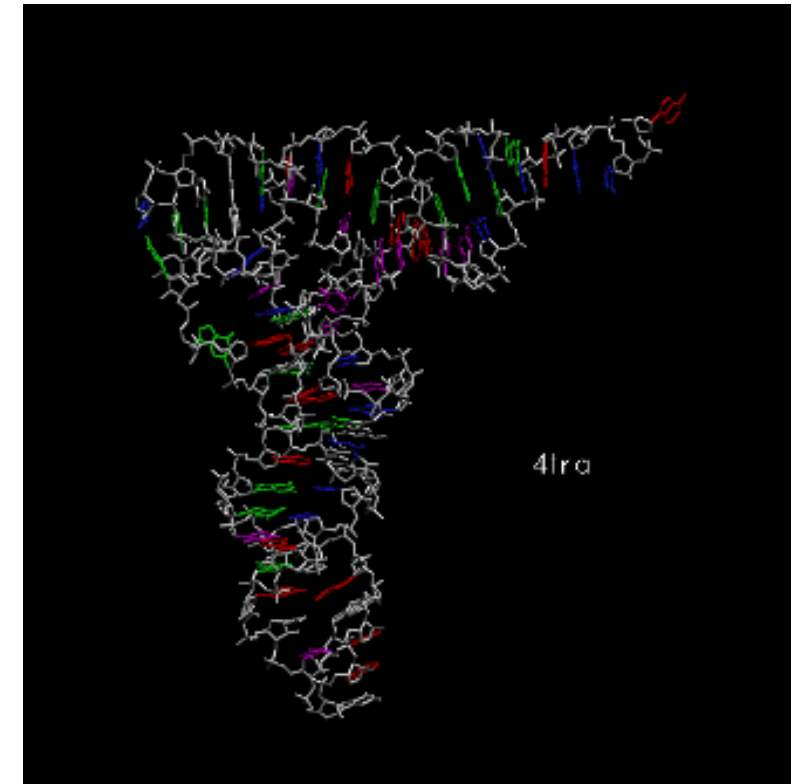

Ribosomal RNA

Next picture was published in: Science 11 February 2011: Vol. 331 no. 6018 pp. 730-736 in the article: **Crystal Structure of the Eukaryotic 40S Ribosomal Subunit in Complex with Initiation Factor 1** (Julius Rabl, Marc Leibundgut, Sandro F. Ataide, Andrea Haag, Nenad Ban)

Description (for those interested in it):

Architecture of the 40S. **(A)** Front and back views of the tertiary structure of the 40S showing the 18S rRNA as spheres and colored according to each domain (5' domain, red; central domain, green; 3' major domain, yellow; 3' minor domain, blue; ESs, magenta), and the proteins as gray cartoons (abbreviations: H, head; Be, beak; N, neck; P, platform; Sh, shoulder; Bo, body; RF, right foot; LF, left foot). **(B)** Secondary structure diagram of the *Tetrahymena thermophila* (a protist) 18S RNA ...showing the rRNA domains and the locations of the ESs. **(C)** Ribosomal proteins of the 40S are shown as cartoons in individual colors; rRNA is shown as gray surface. The 40S is shown as in (A). **(D)** View of the quaternary interactions between ES6 and ES3 at the back of the 40S. The RNA is displayed as a cartoon with the proteins omitted for clarity. ES6 helices are colored in a gradient from light to dark magenta and labeled from A to E... ES3 is highlighted in pink, and the rest of the 18S rRNA is colored in gray. **(E)** The position of helix h16 in bacterial 30S [left...] and in 40S.

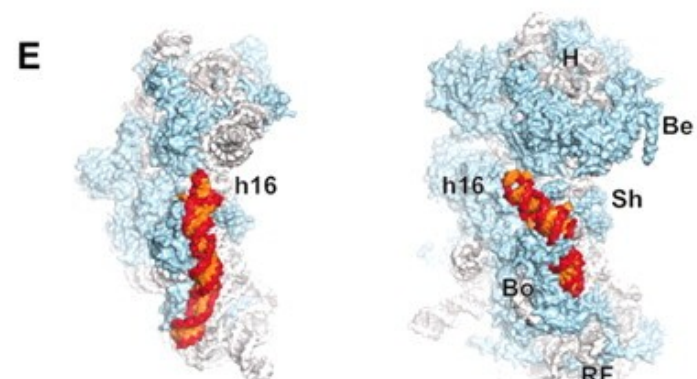
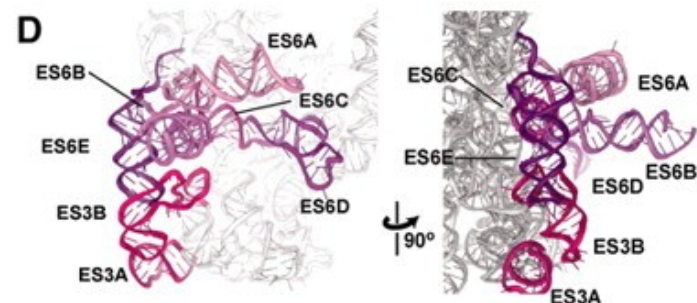
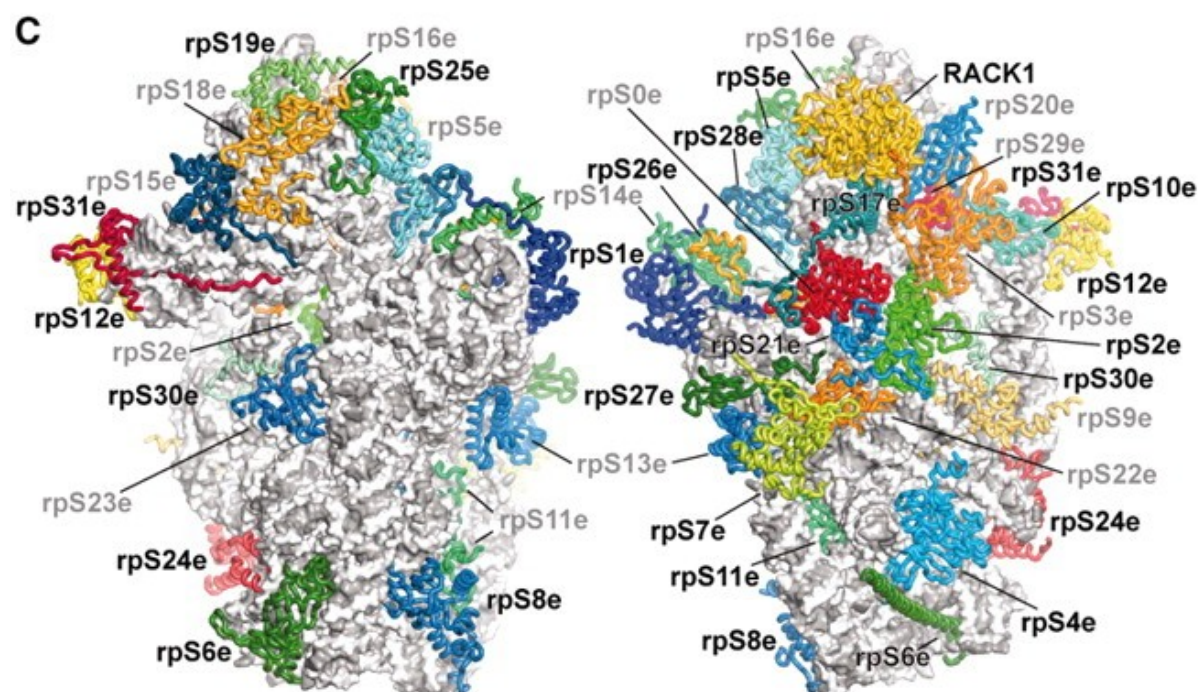
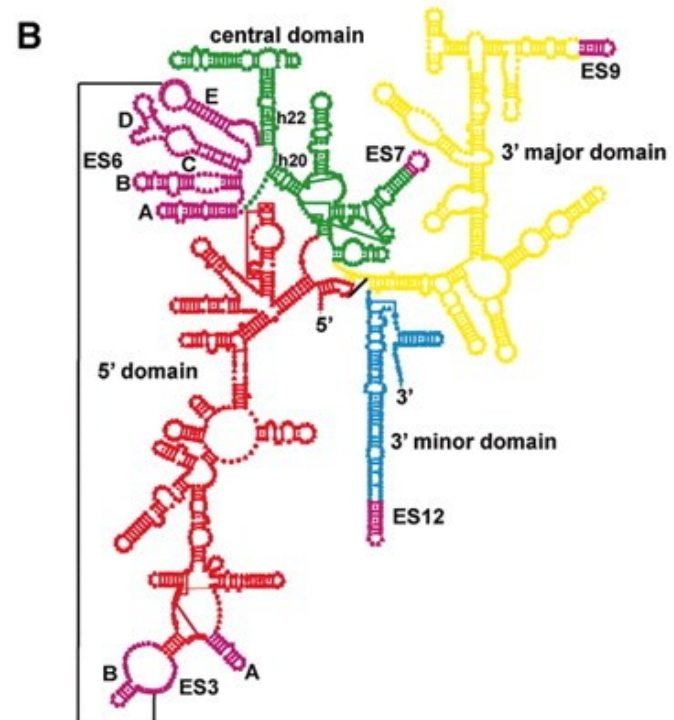
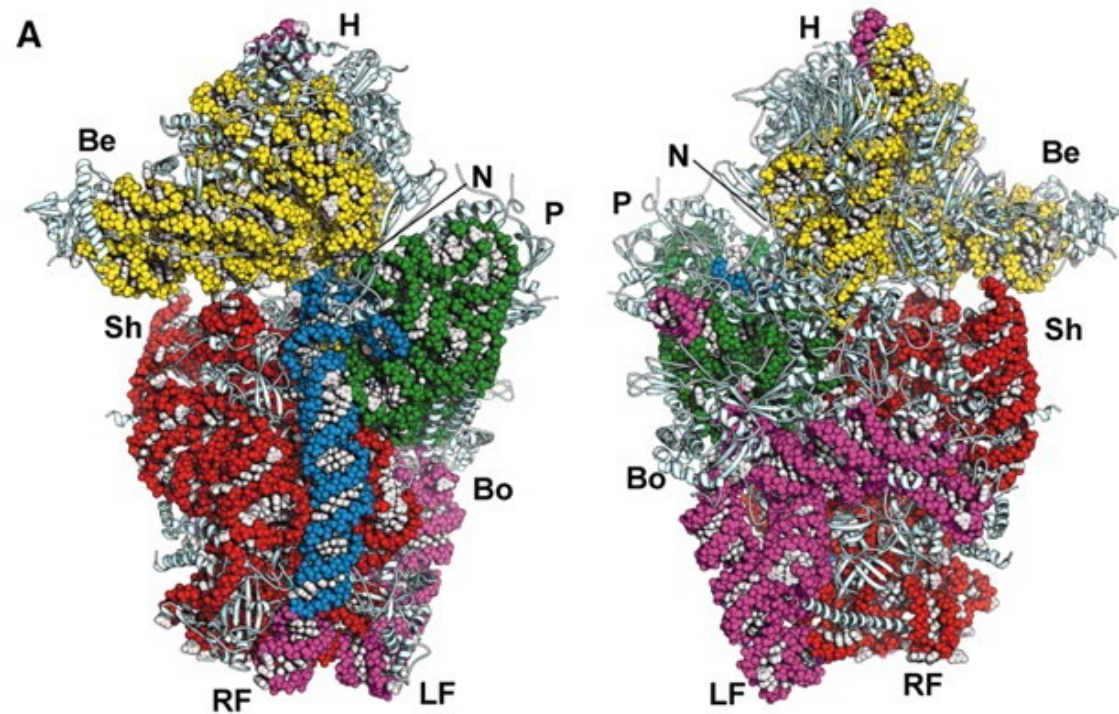

MicroRNA (source: Wikipedia)

MicroRNA or **miRNA** are single strand non-coding RNAs with a typical length of 21-23 nucleotides which take a part in regulation of gene expression. miRNAs are produced by transcription from DNA genes, but they are not translated into proteins.

- After modification by nucleases called „Drosha“ and „Pasha“ the pre-miRNA enters the cytoplasm where can interact with the endonuclease called „Dicer“ forming miRNA. It is bound into the **RISC** complex (RISC = RNA-induced silencing complex). Just the RISC is able to silence the gene expression, which is known as **RNA interference**.

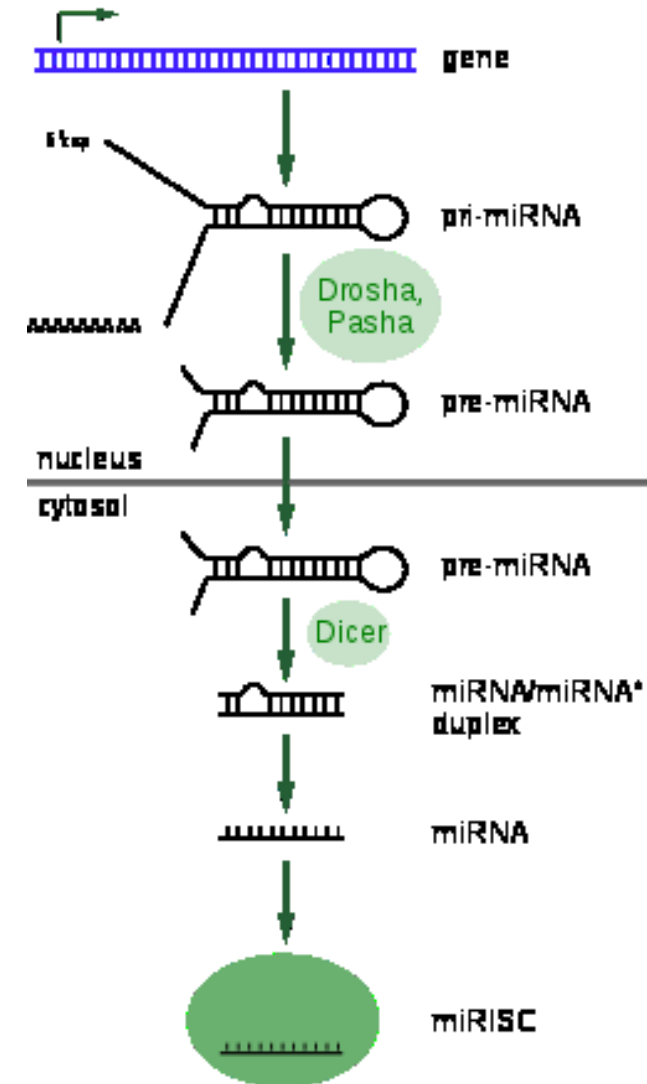

Conformation changes and denaturation of biopolymers

- Changes in secondary, tertiary and quaternary structure of biopolymers are denoted as **conformation changes**.
- They can be both reversible and irreversible.
- **'native'** state of a biopolymer: its **functional** state. Otherwise the biopolymer has been **'denatured'**.

Denaturation factors

□ **Physical:**

- Increased temperature
- Ionising radiation
- Ultrasound
-

□ **Chemical:**

- Changes of pH
- Changes in electrolyte concentration
- Heavy metals
- Denaturation agents destroying hydrogen bonds – urea
-

- Combination of above factors: ionising radiation or ultrasound act directly and/or indirectly (chemically via free radicals)

M U N I

Author:

Vojtěch Mornstein

Content collaboration and language revision:

Carmel J. Caruana, Viktor Brabec

Last revision September 2024