

# MUNI

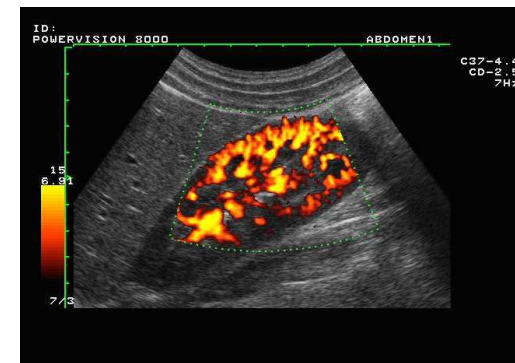

## Lectures on Medical Biophysics

4D

### Ultrasound diagnostics



# Lecture outline

- **Physical properties of ultrasound and acoustic parameters of medium**
- **Ultrasonography**
  - Impulse reflection method
  - A-mode – one-dimensional
  - B-mode – two-dimensional
  - M-mode
  - Basic characteristics of US images
  - Interventional sonography
  - Echocontrast agents
  - Harmonic imaging
  - Principle of 3D imaging
- **Doppler flow measurement**
  - Principle of Doppler effect
  - Principle of blood flow measurement
  - CW Doppler system
  - Systems with pulsed wave – PW Doppler
  - Duplex and Triplex methods
  - Power Doppler method
  - Tissue Doppler Imaging (TDI)
- **Elastography**
- **Ultrasonic densitometry**
- **Patient Safety: reducing Ultrasound ‘Doses’**

# Ultrasound diagnostics

- Ultrasound diagnostics started to develop as a clinical method in early 50' of 20th century. It allows to obtain cross-sectional images of the human body which can also include substantial information about its physiology and pathology.
- Ultrasound diagnostics is based mainly on reflection of ultrasound waves at acoustical interfaces
- We can distinguish:
  - Ultrasonography (A, B and M mode, 3D and 4D imaging)
  - Doppler flow measurement, including Duplex and Triplex methods (Duplex, Colour Doppler, Triplex, Power Doppler)
  - Tissue Doppler imaging
  - Elastography
  - Ultrasound densitometry

# Physical properties of ultrasound

*Before we will deal with diagnostic devices, we need to understand what is ultrasound and what are the main acoustical properties of medium.*

Ultrasound (US) is ***mechanical oscillations with frequency above 20 kHz*** which propagate through an elastic medium.

In liquids and gases, US propagates as longitudinal waves.  
In solids, US propagates *also* as transversal waves.



# Interactions of US with Tissue

- Reflection (smooth homogeneous interfaces of size greater than beam width or the US wavelength, e.g. organ outlines)
- Rayleigh Scatter (small reflector sizes, e.g. blood cells, dominates in non-homogeneous media)
- Refraction (away from normal from less dense to denser medium, note opposite to light, sometimes produces distortion)
- Absorption (sound to heat)
  - absorption increases with  $f$ , note opposite to X-rays
  - absorption high in lungs, less in bone, least in soft tissue, again note opposite to x-rays
- Interference: 'speckles' in US image result of interference between Rayleigh scattered waves. It is an image artefact.
- Diffraction

# Acoustic parameters of medium:

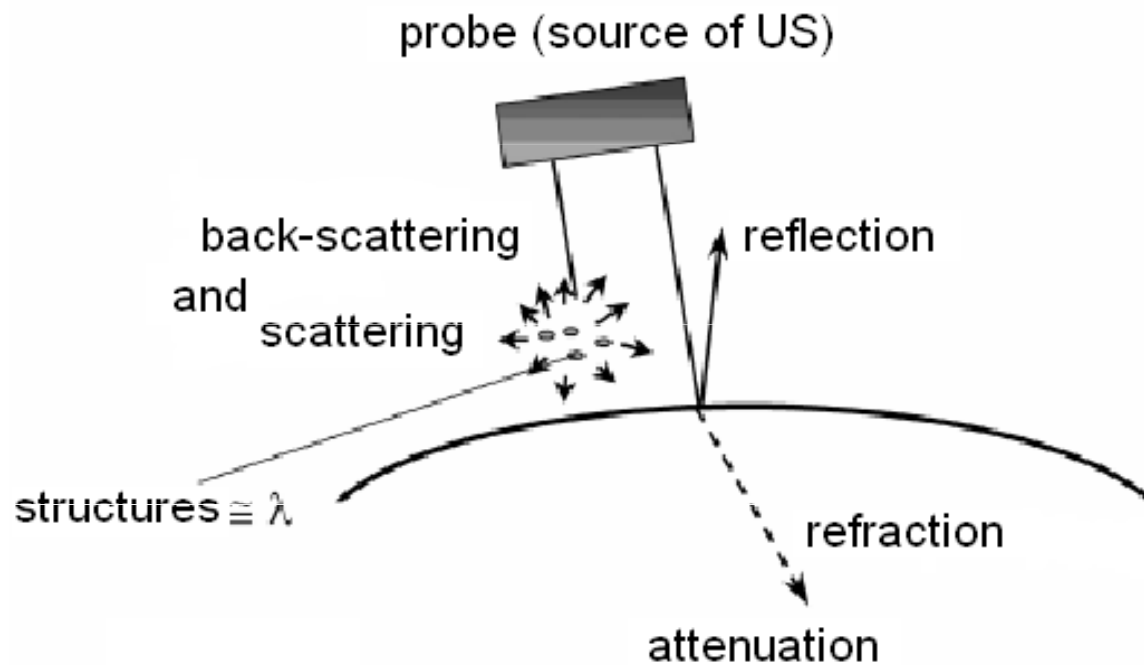

Interaction of US with medium – reflection and back-scattering, refraction, attenuation (scattering and absorption)

# Acoustic parameters of medium

**Speed** of US  $c$  depends on elasticity and density  $\rho$  of the medium:

$K$  - modulus of compression

in water and soft tissues  $c = 1500 - 1600 \text{ m}\cdot\text{s}^{-1}$ , in bones about  $3600 \text{ m}\cdot\text{s}^{-1}$

# Acoustic parameters of medium

**Attenuation** of US expresses decrease of plane wave amplitude along its trajectory. It depends on frequency

$$I_x = I_0 \cdot e^{-2\alpha \cdot x} \qquad \alpha = \alpha' \cdot f^2$$

$I_x$  – final intensity,  $I_0$  – initial intensity,  $2x$  – medium layer thickness (reflected wave travels „to and fro“),  $\alpha$  - linear attenuation coefficient (increases with frequency).

Since

$$\alpha = \log_{10}(I_0/I_x)/2x$$

we can express  $\alpha$  in units **dB/cm**. At 1 MHz: muscle 1.2, liver 0.5, brain 0.9, connective tissue 2.5, bone 8.0

# MUNI

⟨#⟩ Zápětí prezentace

# Acoustic parameters of medium: US reflection and transmission on interfaces

Acoustic impedance: product of US speed  $c$  and medium density  $\rho$

$$Z = \rho \cdot c \quad (\text{Pa}\cdot\text{s}/\text{m})$$

muscles  $1.7 \times 10^6$ , liver  $1.65 \times 10^6$  brain  $1.56 \times 10^6$ , bone  $6.1 \times 10^6$ , water  $1.48 \times 10^6$

We suppose perpendicular incidence of US on an interface between two media with different  $Z$  - a portion of waves will pass through, and a portion will be reflected (the larger the difference in  $Z$ , the higher reflection).

$$R = \frac{P_1}{P} = \frac{Z_2 - Z_1}{Z_2 + Z_1}$$

$$D = \frac{P_2}{P} = \frac{2Z_1}{Z_2 + Z_1}$$

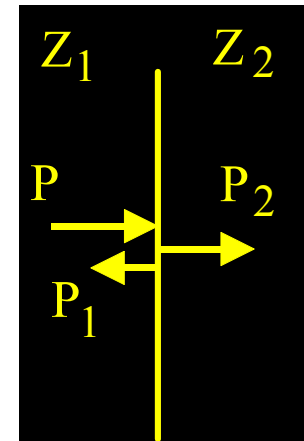

Coefficient of reflection  $R$  – ratio of acoustic pressures of reflected and incident waves

Coefficient of transmission  $D$  – ratio of acoustic pressures of transmitted and incident waves

# Acoustic parameters of medium: Near field and far field (optional)

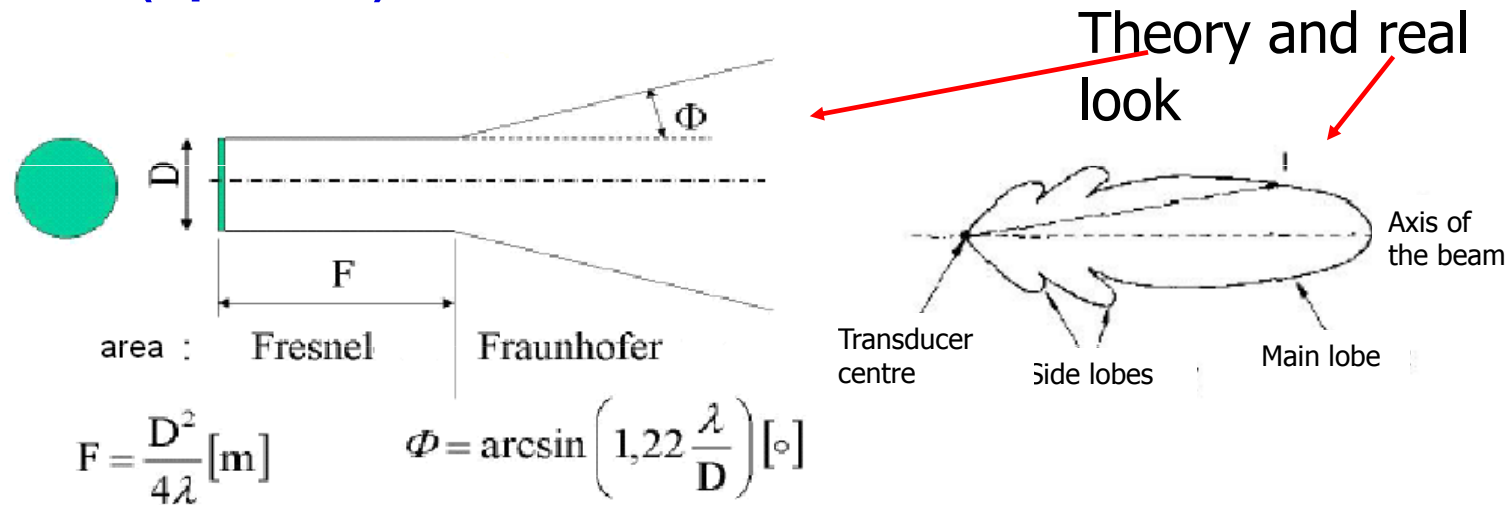

- **Near field (Fresnel area)** – this part of US beam is cylindrical – there are big pressure differences in beam axis
- **Far field (Fraunhofer area)** – US beam is divergent – pressure distribution is more homogeneous
- Increase of frequency of US or smaller probe diameter cause shortening of near field - divergence of far field increases

# Ultrasonography

Passive US – low intensity waves which cannot cause substantial changes of medium.

In US diagnostics (ultrasonography = sonography = echography) - frequencies used are 2 - 40 MHz with (temporal average, spatial peak) intensity of about 1 kW/m<sup>2</sup>

Impulse reflection method: a probe with one transducer which is *source as well as detector* of US impulses. A portion of emitted US energy is *reflected* on the acoustic interfaces and the same probe then receives reflected signal. After processing, the signal is displayed on a screen.



# Ultrasonography: Impulse reflection method

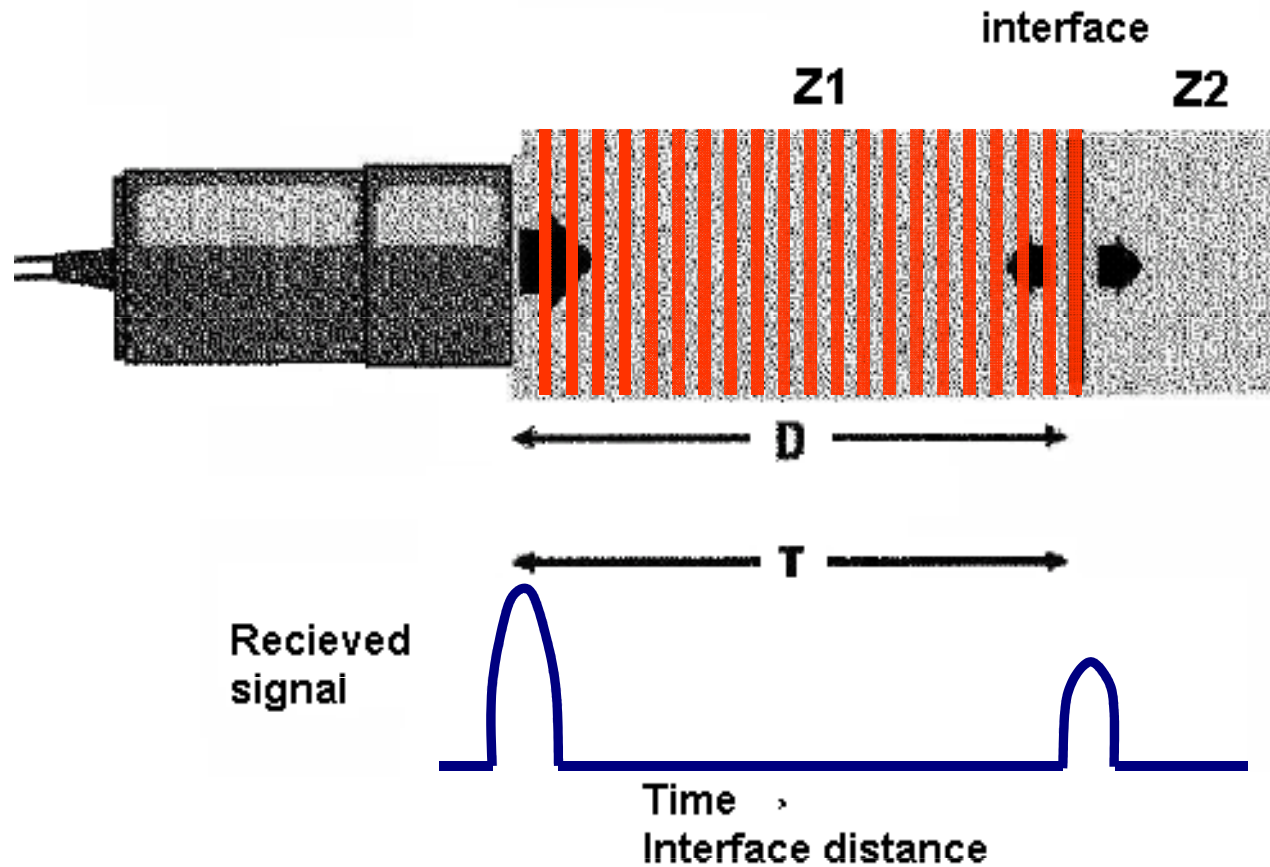

# Ultrasonography: Impulse reflection method

Main parts of the US apparatus:

Common to diagnostics and therapy

- probe with electroacoustic transducer (transducers)
- generator of electric oscillations (continuous, pulsed)

Special parts of *diagnostic apparatus*

- electronic circuits for processing of reflected signal (today A/D converter and respective software)
- display unit
- recording unit

# Ultrasonography: A-mode – one-dimensional

- **Distances** between reflecting interfaces and the probe are shown.
- **Reflections** from individual interfaces (boundaries of media with different acoustic impedances) are represented by *vertical deflections* of base line, i.e. the echoes.

Echo amplitude is proportional to the *intensity of reflected waves* (**A**mplitude modulation)

Distance between echoes shown on the screen is approx. proportional to real distance between tissue interfaces.

Today used mainly in ophthalmology.

# Ultrasonography: A-mode – one-dimensional

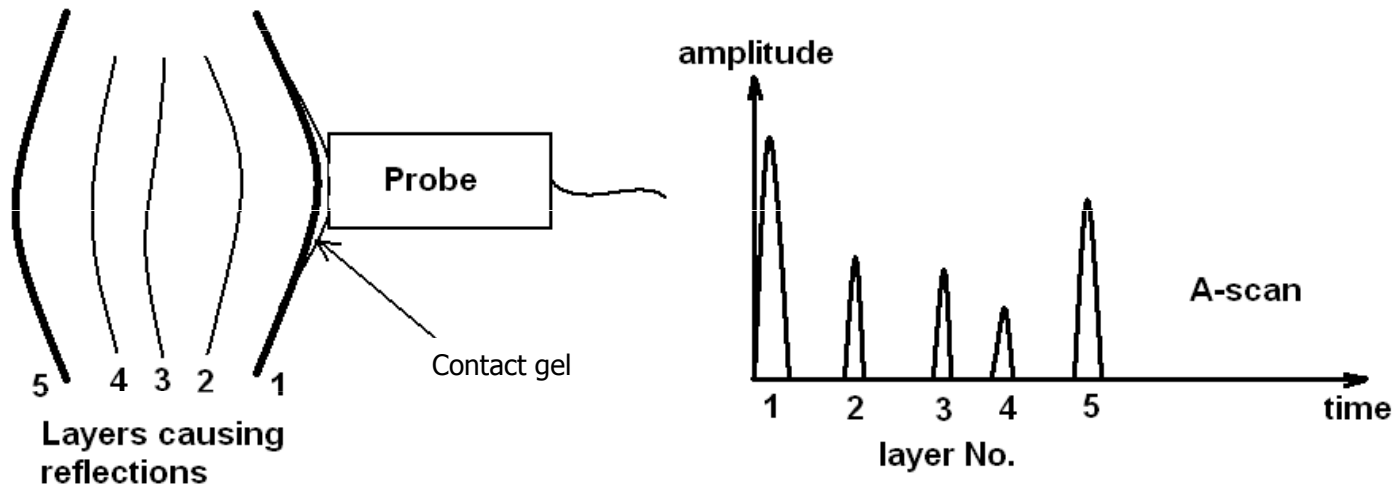
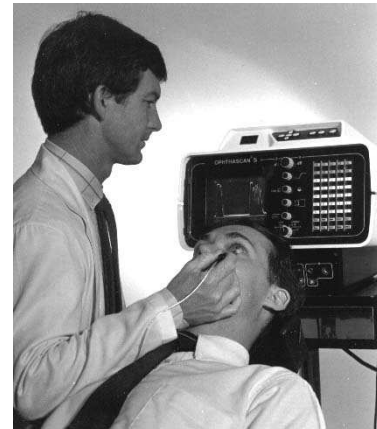
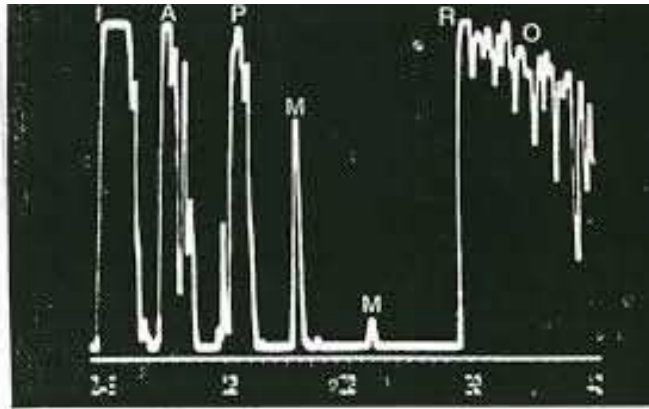

PRINCIPLE OF A-MODE SCAN

# MUNI

⟨#⟩ Zápětí prezentace

# Ultrasonography: M-mode

One-dimensional static B-scan shows movement of reflecting tissues. The second dimension is time in this method.

Static probe detects *reflections* from moving structures. The echoes are represented by *points* moving *vertically* on the screen, *horizontal shifting* of the record is given by slowly running time-base.

Displayed **curves represent movement** of tissue structures

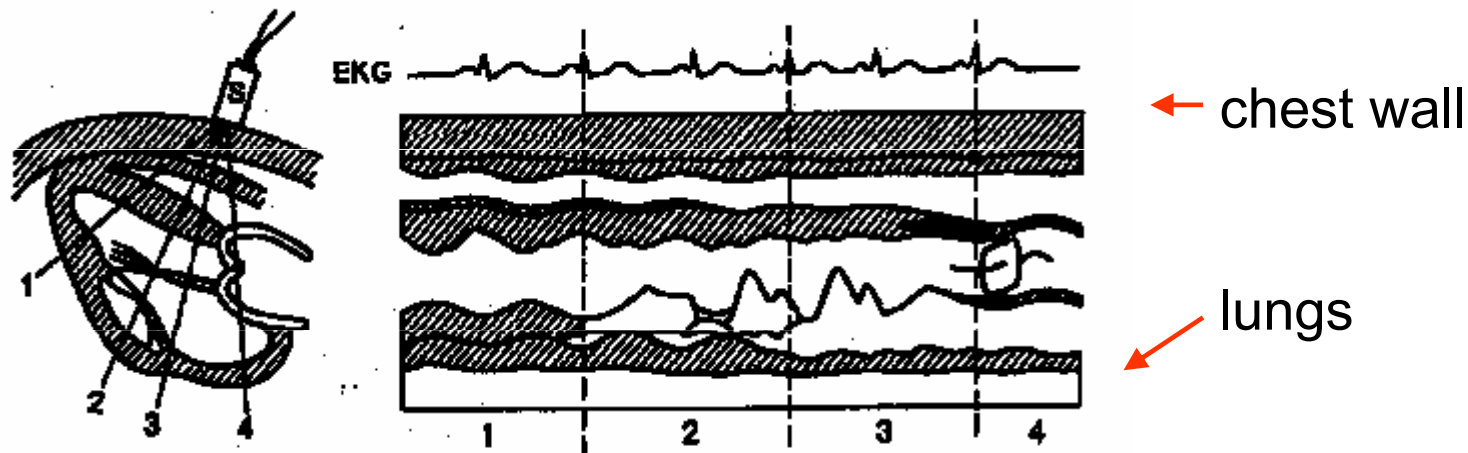

## Ultrasonography: B-mode - dynamic

Repetitive formation of B-mode images of examined area by fast deflection of US beam mechanically (in the past) or electronically „in real time“ today.

**Electronic probes consist of many piezoelectric transducers which are gradually activated.**

# Ultrasonography: B-mode - dynamic

Ultrasound probes for dynamic B-mode: electronic and mechanical (history), sector and linear.

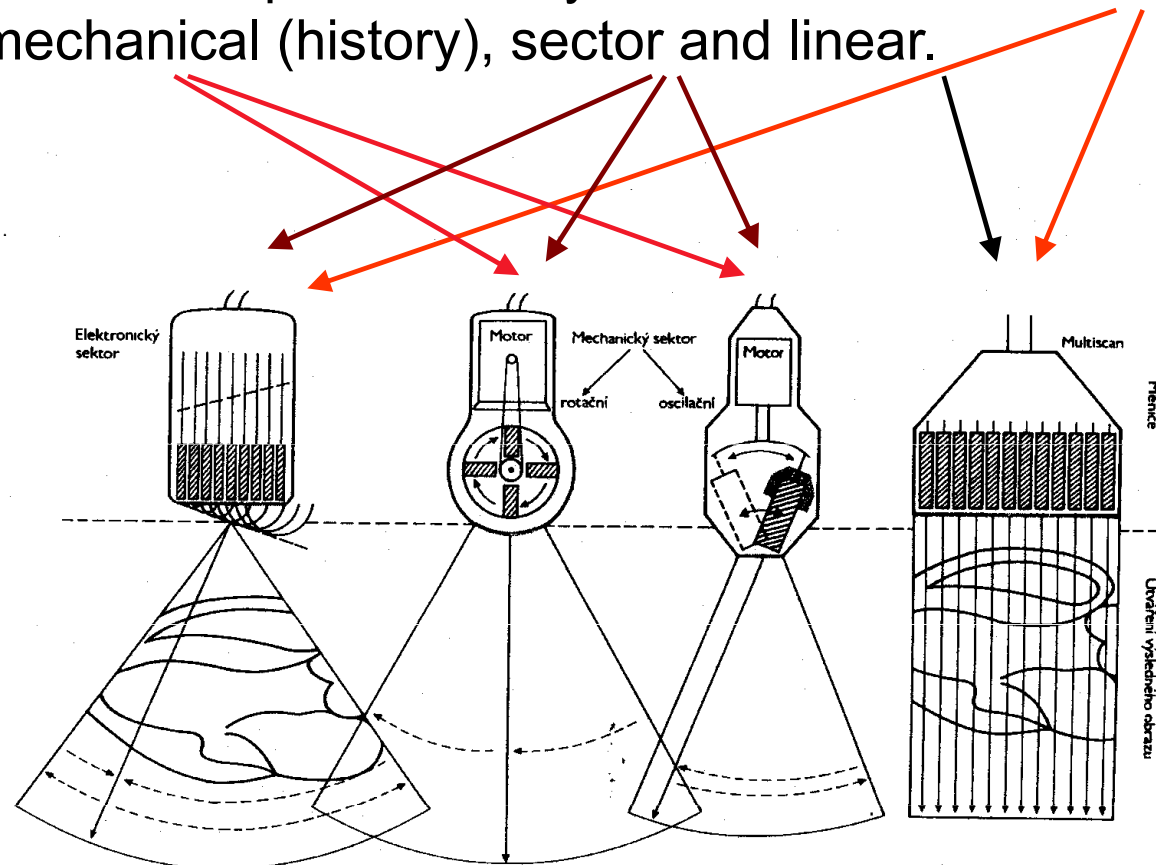

Abdominal cavity is often examined by convex probe – a combination of a sector and linear probe.



# Ultrasonography: B-mode - dynamic

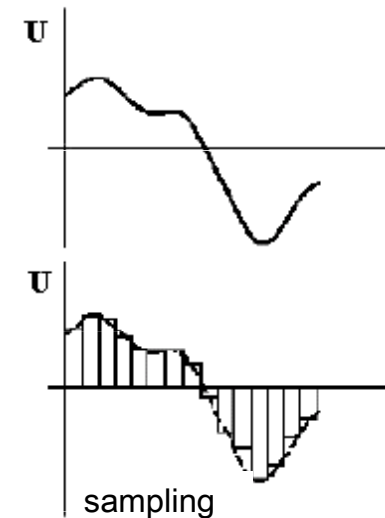
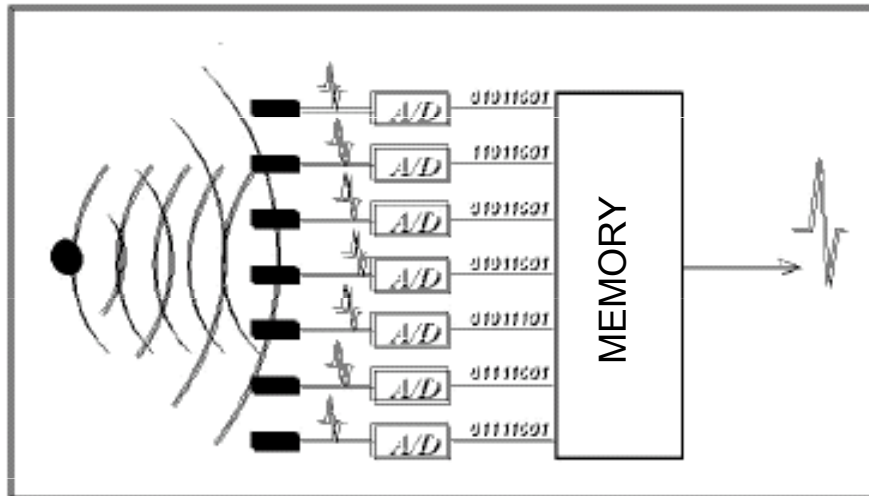

Modern ultrasonography - digital processing of image

- **Analogue part** – detection system
- **Analogue-digital converters (ADC)**
- **Digital processing of signal** – possibility of programming (preprocessing, postprocessing), **image storage** (CD, flash cards etc.)

# Ultrasonography B-mode - dynamic

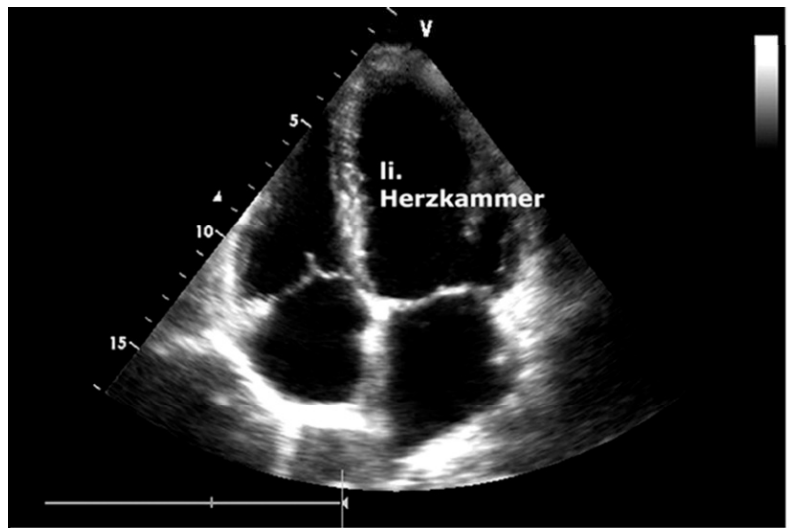

Normal großes Herz

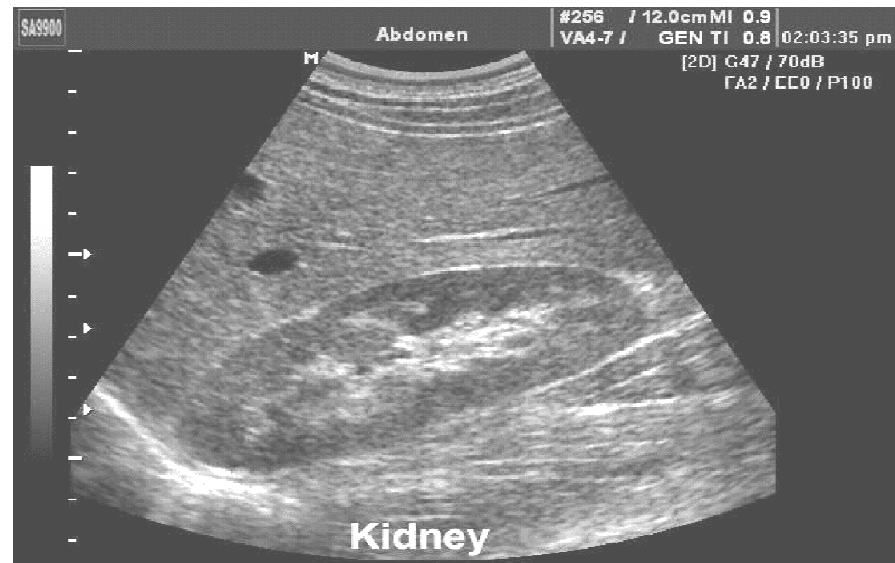

# Ultrasonography: Basic characteristics of US images

**Degree of reflectivity – echogenicity.** The images of cystic (liquid-filled) and solid structures are different. According to the intensity of reflection *in the tissue bulk* we can distinguish structures:

**hyperechogenic, izoechogenic, hypoechogenic, anechogenic.**

- **Solid structures – acoustic shadow** (caused by absorption and reflection of US)
- **Air bubbles and other strongly reflecting interfaces cause repeating reflections** (reverberation, „comet tail“).

# Ultrasonography

Acoustic shadow caused by absorption and reflection of US by a kidney stone (arrow)

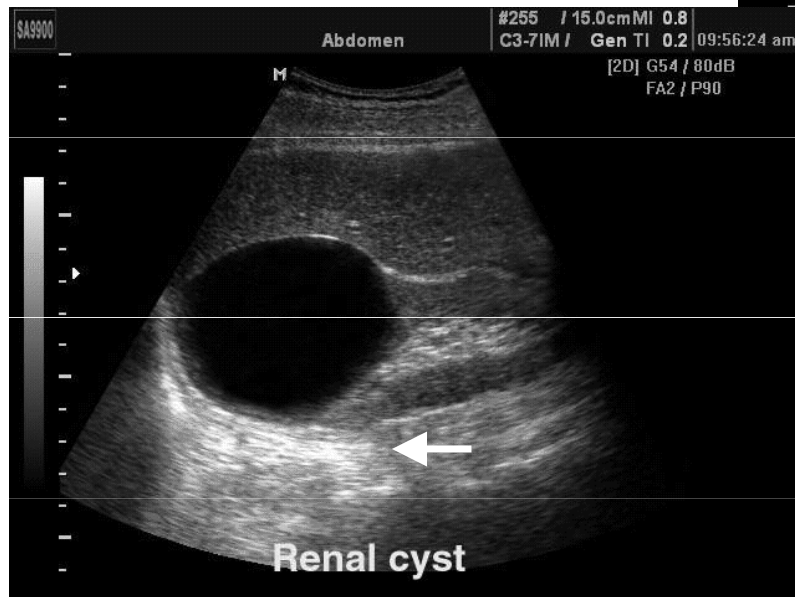
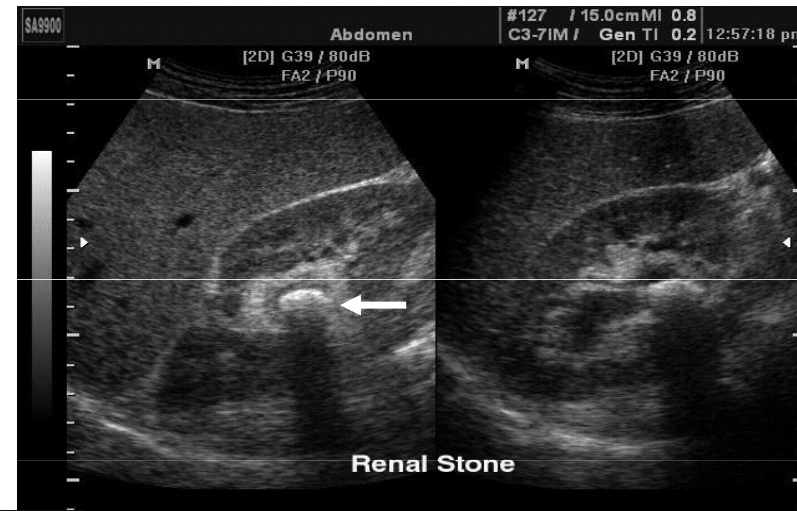

Hyperechogenic area below a cyst (low attenuation of US during passage through the cyst compared with the surrounding tissues – arrow)

# Ultrasonography

**Spatial resolution** of US imaging system is determined by the wavelength of the US. When the object dimension is smaller than this wavelength only scattering occurs. Hence higher spatial resolution requires higher frequencies

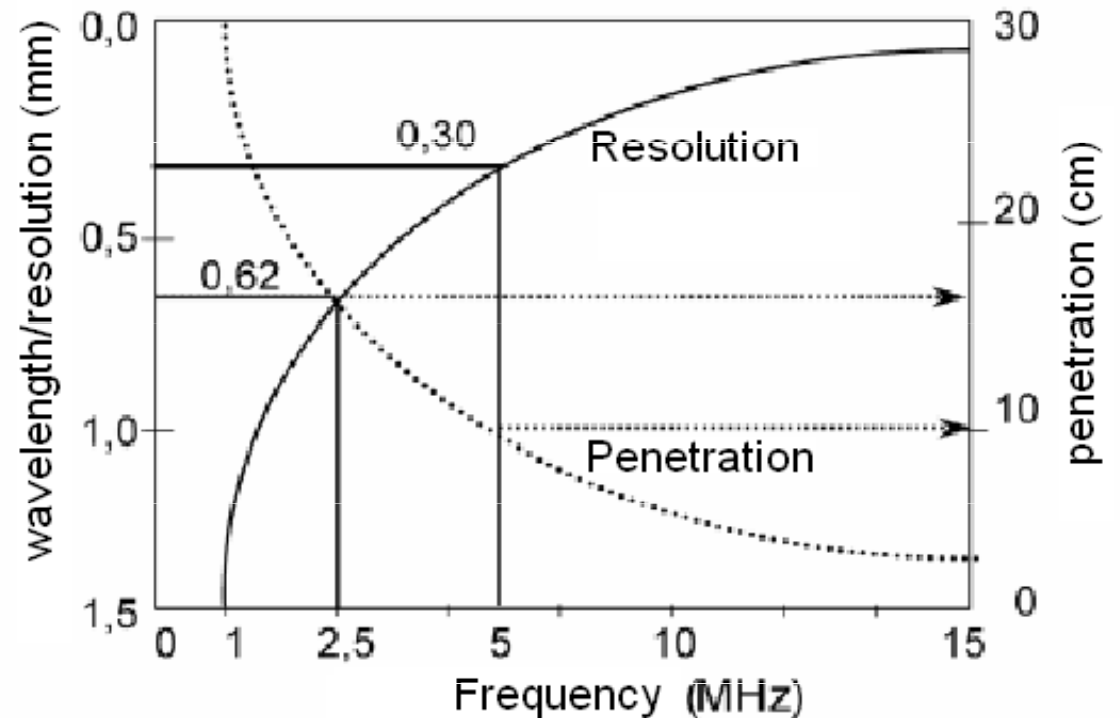

Limitation! – absorption of US increases with frequency of ultrasound = smaller penetration depth

*Compromise frequency 3-5 MHz – penetration in depth of about 20 cm*

# Ultrasonography: Spatial Resolution

Optional!

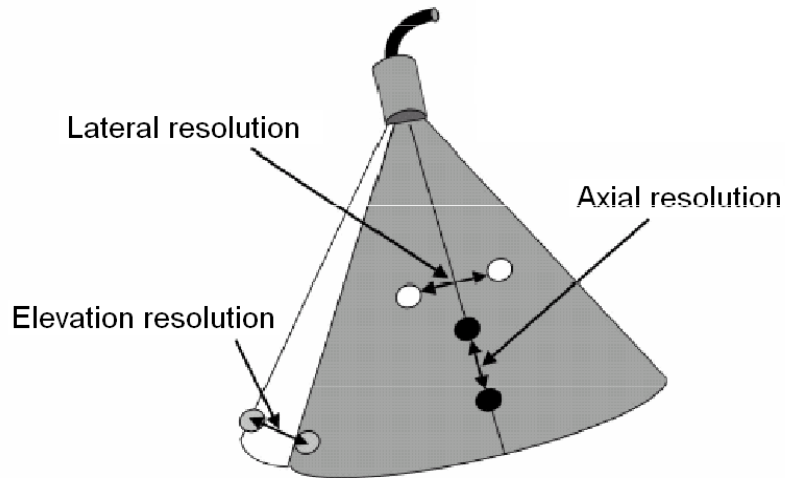

- **Axial spatial resolution** - it is given by the shortest distance of two distinguishable structures lying in the beam axis – it depends mainly on frequency (at 3.5 MHz about 0.5 mm)
- **Lateral spatial resolution** - it is given by the shortest distance of two distinguishable structures perpendicularly to the beam axis – depends on the beam width
- **Elevation** – ability to distinguish two planes (sections) lying behind or in front of the depicted tomographic plane – it depends on frequency and beam geometry

# Ultrasonography: Spatial Resolution

Optional!

The best resolving power can be found in the narrowest part of the US beam profile.

**Focusing** – US beam is converged at the examined structure by means of acoustic lenses (shapes of the layer covering the transducer) or electronically.

- The probes can be universal or specially designed for different purposes with different focuses.
- The position of focus can be changed in most sector probes).

# Ultrasonography: Interventional sonography

- **Interventional sonography is used mainly for guiding punctures**
  - **diagnostic** – thin needle punctures to take tissue samples for histology
  - **therapeutic** – for aspiration of a cyst or an abscess content or an exudate etc.
- 
- Puncture can be done by „free hand“
    - the probe is next to the puncture site
    - or the puncture needle is guided by a special probe attachment.



<https://theultrasoundsite.co.uk/region-specific-ultrasound-guided-injections/ultrasound-guided-injections-wrist-hand/>



# Ultrasonography: Echocontrast agents

- increase echogenicity of streaming blood

Gas microbubbles

(mainly air or volatile hydrocarbons)

- Free or enclosed in a biopolymer envelope

A SEM micrograph of encapsulated echocontrast agent

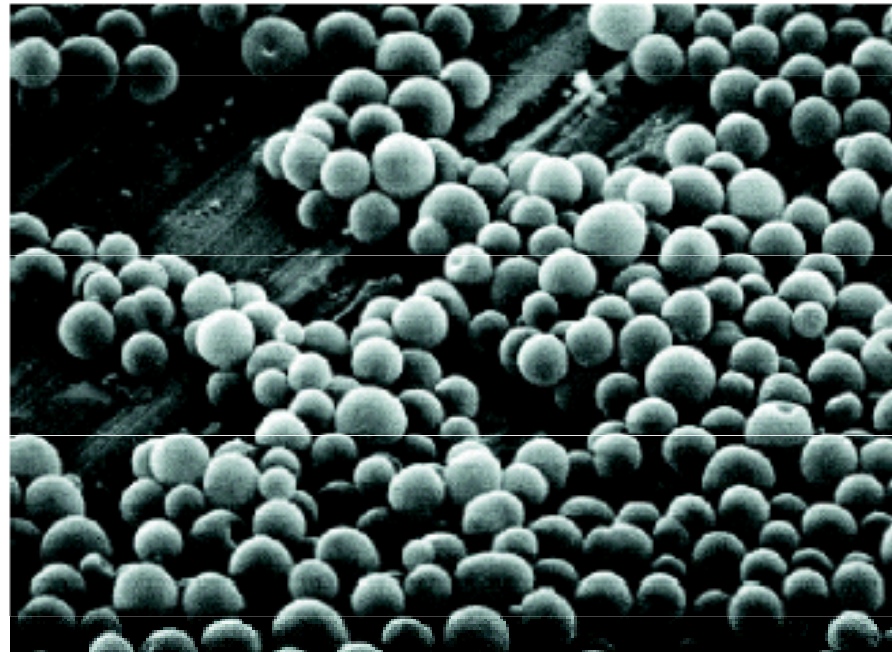

# Ultrasonography: Echocontrast agents - application

Enhancement of contrast by microbubbles in liver and kidney



VesselMax (Improved vessel visualization)



FlowMax (Improved blood flow visualization)

<http://www.medicalimagingtech.com/us-rs80a>

Echocontrast image of Focal Nodular Hyperplasia of the Liver

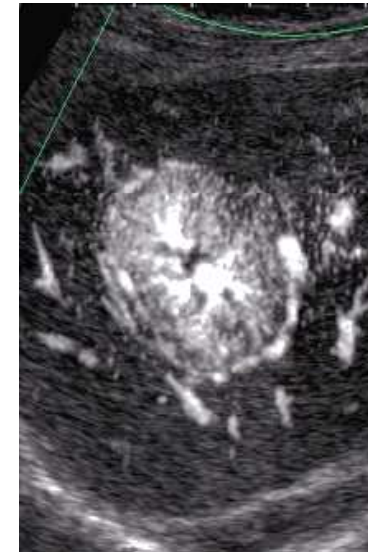

18 s after intravenous application of the echocontrast agent

**MUNI**

# Ultrasonography: Harmonic imaging

An impulse with basic frequency  $f_0$  is emitted into the tissue. The receiver, however, does not detect the reflected US with this same frequency but with the second harmonic frequency  $2f_0$ . Its source is tissue itself (advantage in patients „difficult to examine“). The method is also used with echocontrast agents – source of the second harmonic are oscillating bubbles. Advantageous when displaying blood supply of some lesions.

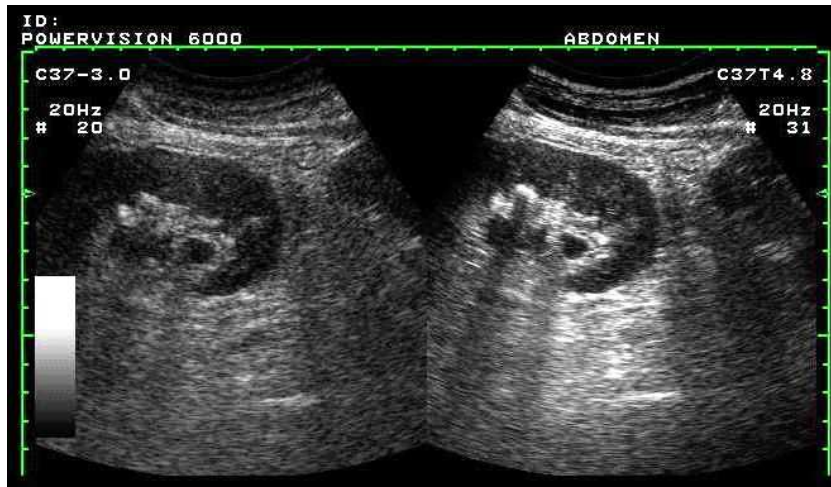

Conventional (left) and harmonic (right) images of a kidney with a stone.

## Ultrasonography:

- ✦ Purpose of this method is a **continuous image record of a tissue or organ in desired plane (direction)**. Panoramic image enables assessment of dimensions and morphology of the whole-body portion.
- ✦ This method is a supplement to the conventional imaging.

## Panoramic imaging

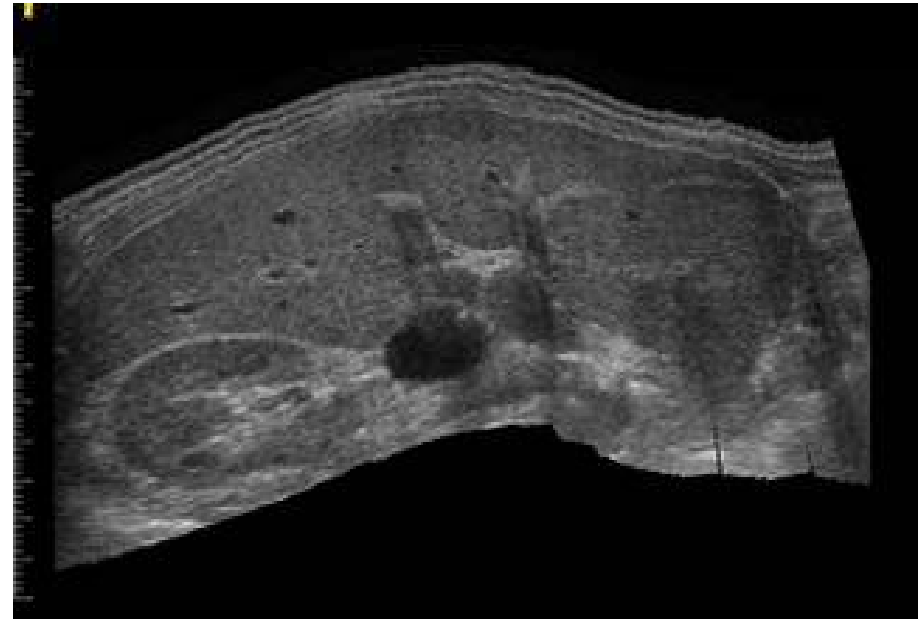

Panoramic image of epigastrium

From left right kidney, right liver lobe,  
gallbladder, left liver lobe, spleen

# Ultrasonography

## Principle of three-dimensional (3D) imaging

- The probe is linearly shifted, tilted or rotated.

The data about reflected signals in individual planes are stored in memory of a powerful PC which consequently performs mathematical reconstruction of the image. Disadvantages of some 3D imaging systems: relatively long time needed for mathematical processing, price.

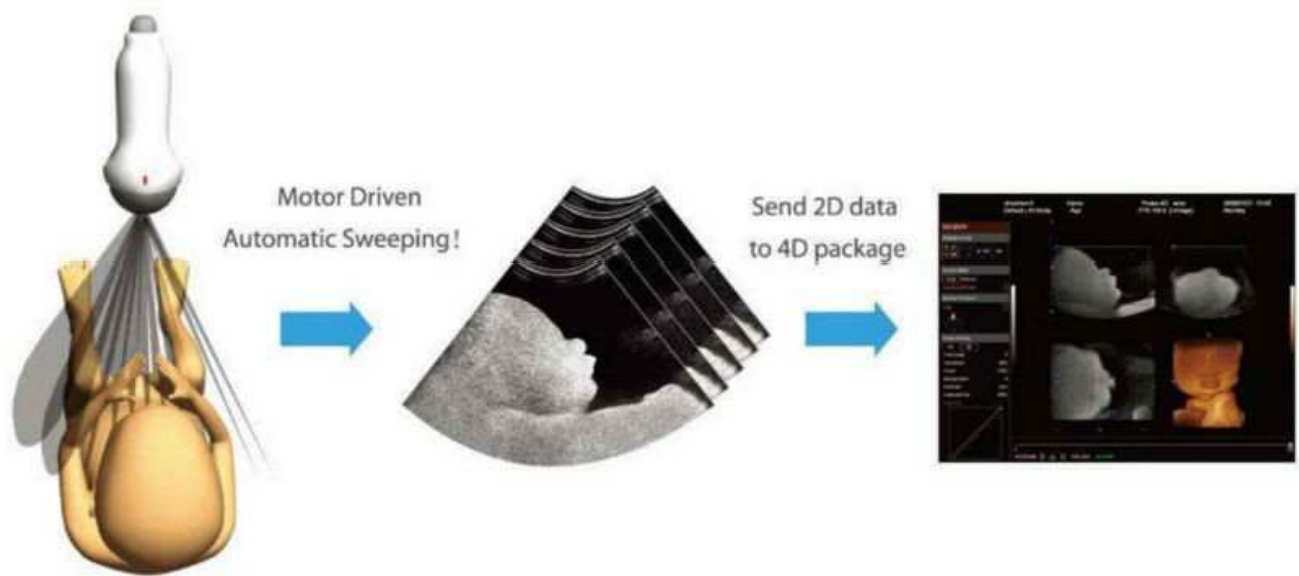

# Four-dimensional (4D) image

The fourth dimension is time

4D



<https://giphy.com/gifs/4d-14jU1PuglaN1v2>

MUNI



# Doppler flow measurement

Christian. A. Doppler (1803-1853), Austrian physicist and mathematician, formulated his theory in 1842 during his stay in Prague.



**The Doppler effect (frequency shift of waves formed or reflected at a moving object) can be used for detection and measurement of blood flow, as well as, for detection and measurement of movements of some acoustical interfaces inside the body (heart, blood vessel walls)**

Perceived frequency corresponds with source frequency in rest.

Perceived frequency is higher when approaching it.

Perceived frequency is lower when moving away it.

# Doppler flow measurement: Principle of Doppler effect

Application of Doppler effect  
in blood flow velocity  
measurement

Moving reflector (back  
scatterer) = erythrocytes

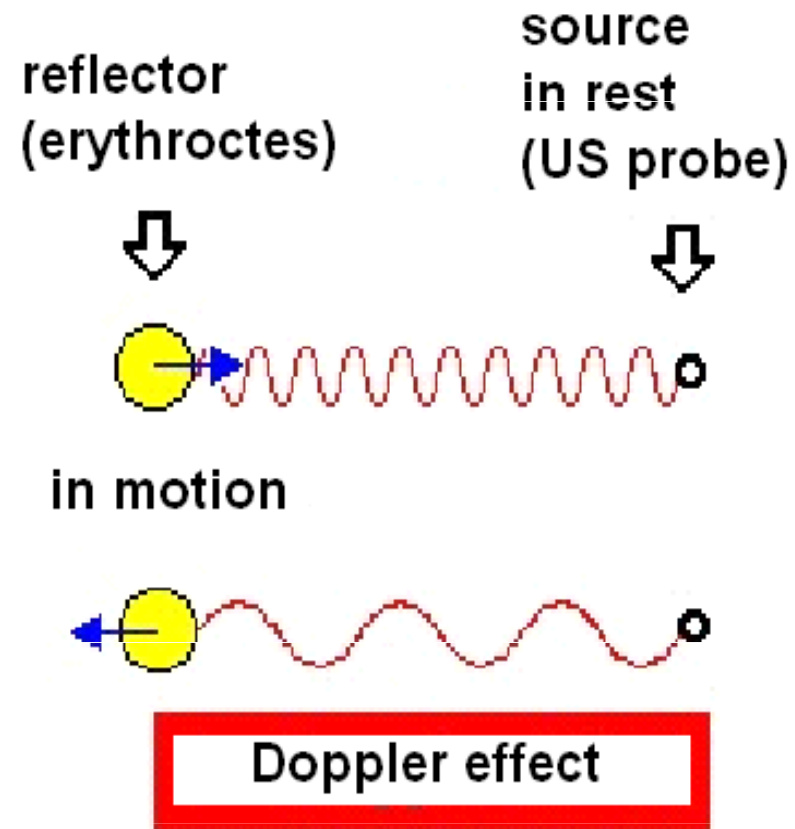



# Doppler flow measurement: Principle of blood flow measurement

US Doppler blood flow-meters

are based on the difference between the frequency of ultrasound (US) waves emitted by the probe and those reflected (back-scattered) by moving erythrocytes.

**The frequency of reflected waves is** (in comparison with the emitted waves)  
**higher in forward blood flow** (towards the probe)  
**lower in back blood flow** (away from the probe)

The difference between the frequencies of emitted and reflected US waves is proportional to blood flow velocity.

# Doppler flow measurement: principle of blood flow measurement

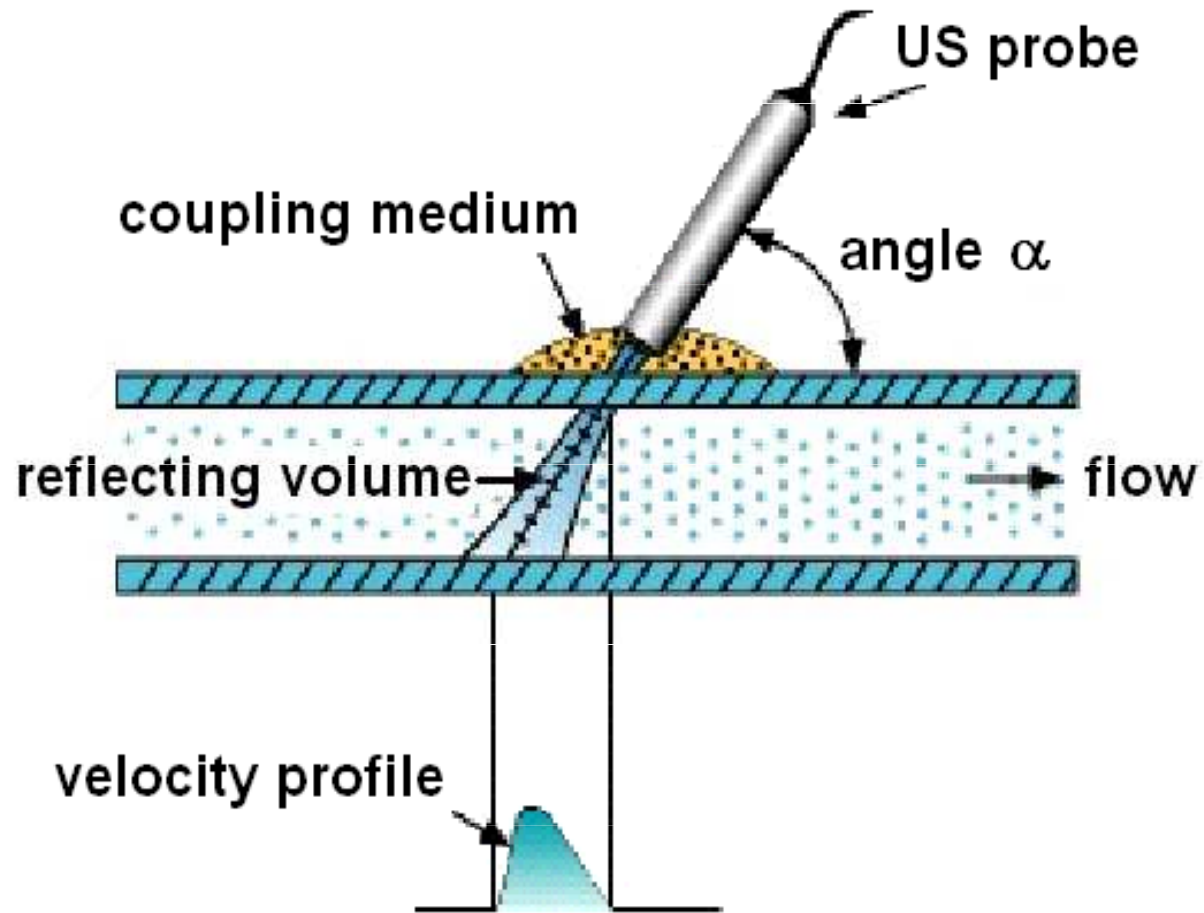

# Doppler flow measurement

- 1) Calculation of Doppler frequency change  $f_d$
- 2) Calculation of „reflector“ (erythrocytes) velocity  $v$

$$1) \quad f_d = \frac{2f_v v \cos \alpha}{c} \qquad 2) \quad v = \frac{f_d c}{2f_v \cos \alpha}$$

$f_v$  - frequency of emitted US waves

$\alpha$  - angle made by axis of emitted US beam and the velocity vector of the reflector

$c$  – US speed in the given medium (about 1540 m/s in blood)

Dependence of velocity overestimation on the incidence angle  $\alpha$  (if the device is adjusted for  $\alpha = 0$ , i.e.  $\cos \alpha = 1$ )

$\alpha$  - angle made by axis of emitted US beam and the velocity vector of the reflector

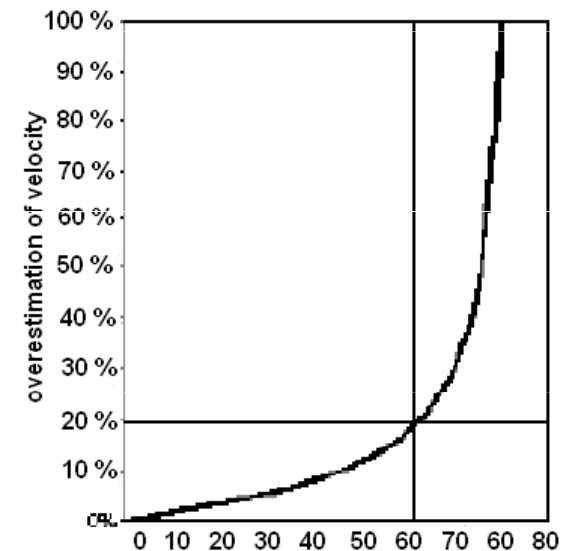

# Doppler flow measurement

- 1) Systems with continuous wave – CW. They are used for measurement on superficial blood vessels. High velocities of flow can be measured, but without depth resolution. Used only occasionally.
- 2) Systems with pulsed wave. It is possible to measure blood flow with accurate depth localisation. Measurement of high velocities in depths is limited.

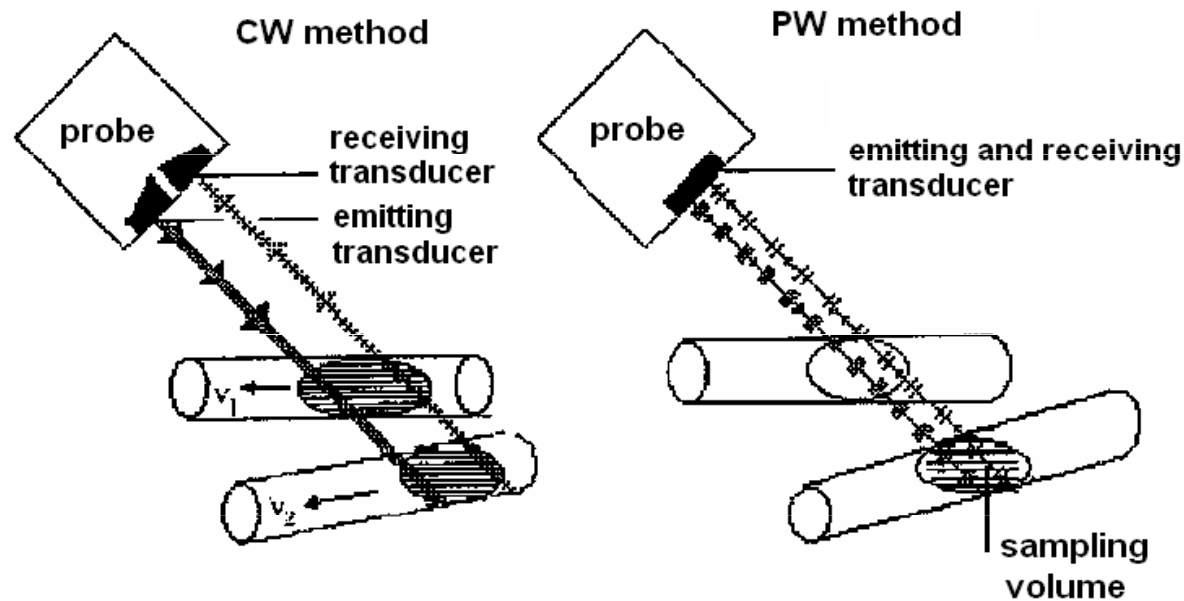

# Doppler flow measurement

## Systems with pulsed wave - PW

The probe has only **one transducer** which acts alternately as emitter and receiver.

The measurement of velocity and direction of blood flow in the vessel is evaluated in the so-called **sampling volume** with adjustable size and depth.

The pulse duration defines the size of the sampling volume (this volume should involve the whole diameter of the examined blood vessel).

# Doppler methods: Pulse wave (PW) systems – optional!

Aliasing – artefact of measurement. At high repetition frequency of pulses the upper part of the spectral curve can appear in negative velocity range.

- at velocity above 4m/s aliasing cannot be removed

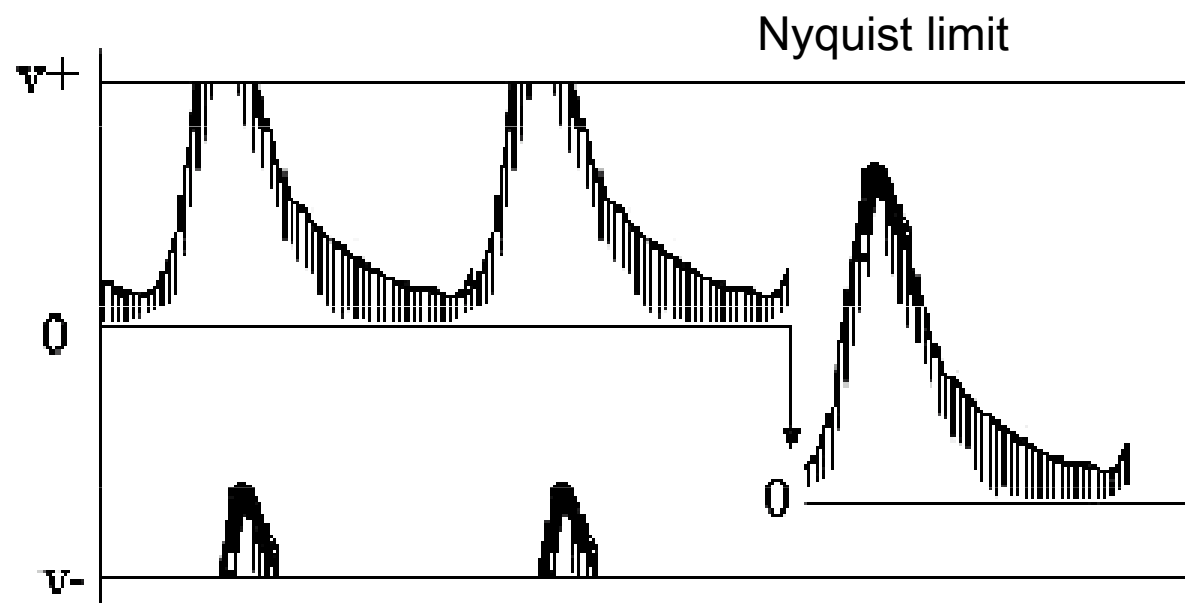

# Doppler methods

## DUPLEX method

is a **combination**

of **dynamic B-mode imaging** (the morphology of examined area with blood vessels is depicted)

and the **PW Doppler system** (measurement of velocity spectrum of blood flow).

It allows to examine blood flow inside heart or in deep blood vessels (flow velocity, direction and character)

# Doppler flow measurement

## Basic spectral curves

directional

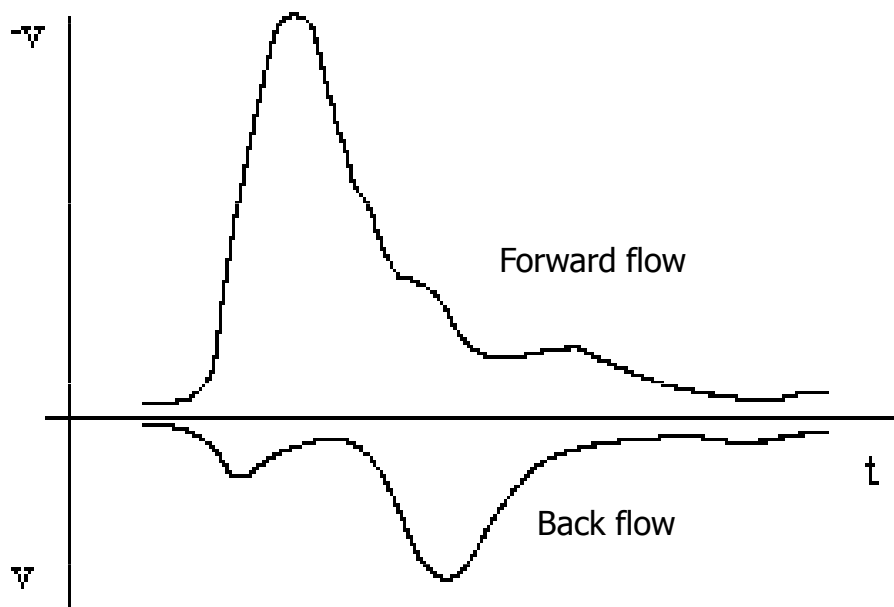

impedance

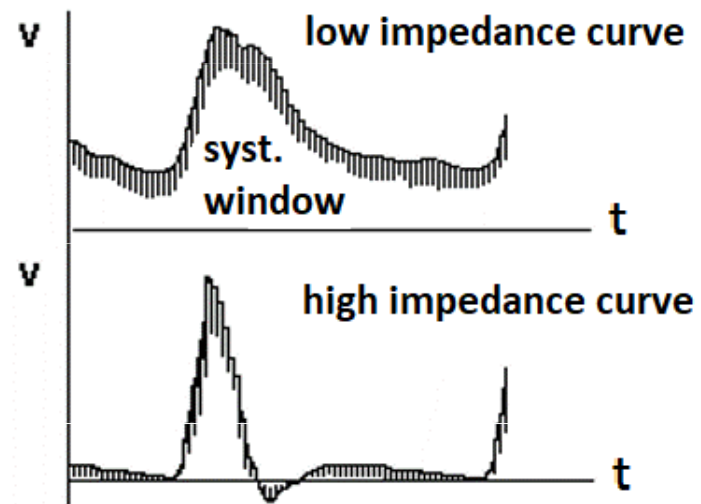

Low peripheral impedance: brain arteries, arteries in parenchymatous organs  
High peripheral impedance: arteries in skeletal muscles  
syst. = systolic



## Doppler methods

## DUPLEX method

Placement of sampling volume (left) and the record of blood flow velocity spectrum in stenotic *a. carotis communis* (right)

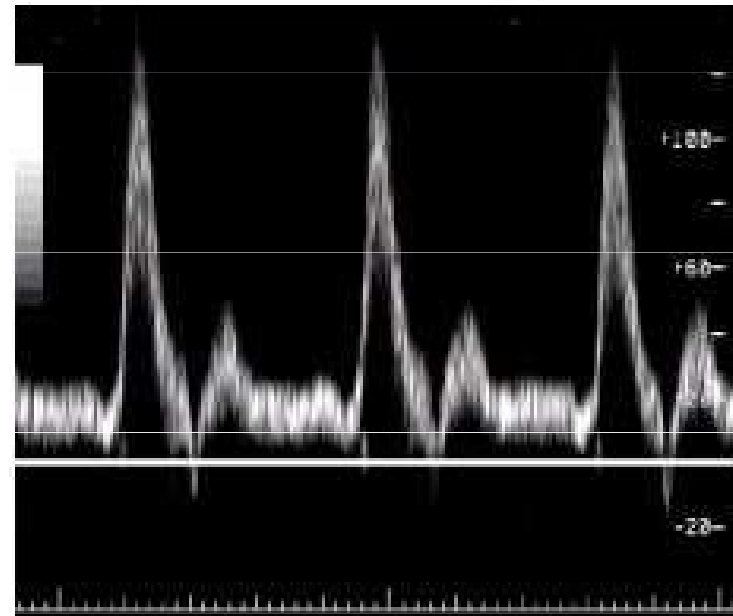

Figure 2

## Doppler methods

## Colour Doppler imaging

The image consists of black-white and colour part.

The black-white part contains information about reflectivity and structure of tissues.

The **colour** part informs about movements in the examined section. (The colour is derived from average velocity of flow.)

The apparatus depicts distribution and direction of flowing blood as a two-dimensional image.

**BART** rule – **blue away, red towards**. The flow away from the probe is coded by blue colour, the flow towards the probe is coded by red colour.

The brightness is proportional to the velocity, **turbulences are depicted by green patterns**.

# Doppler flow measurement TRIPLEX method

Combination of duplex method and colour Doppler imaging

Normal blood flow in *a. carotis communis* (left) and in *a. renalis dx* (right)

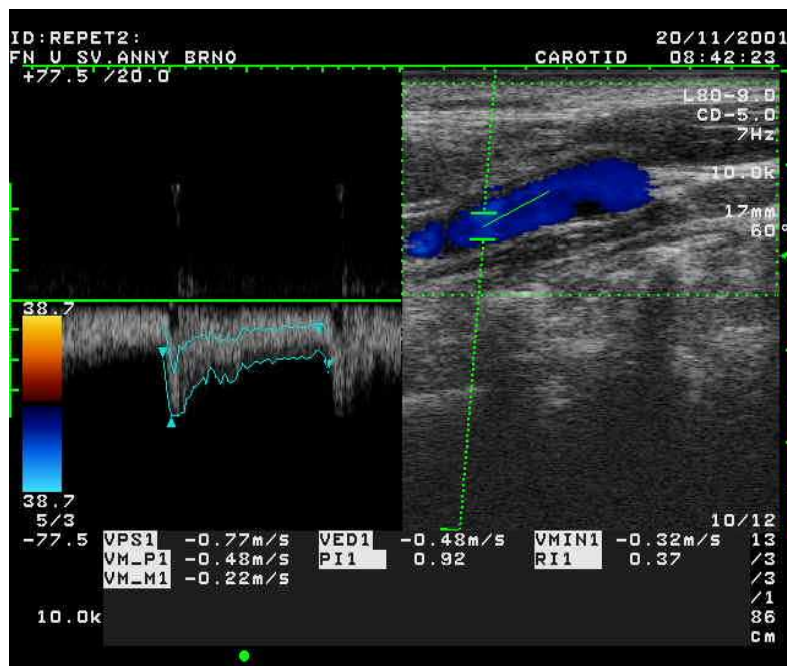

# Doppler methods

# TRIPLEX method

stenosis  
of  
a. carotis

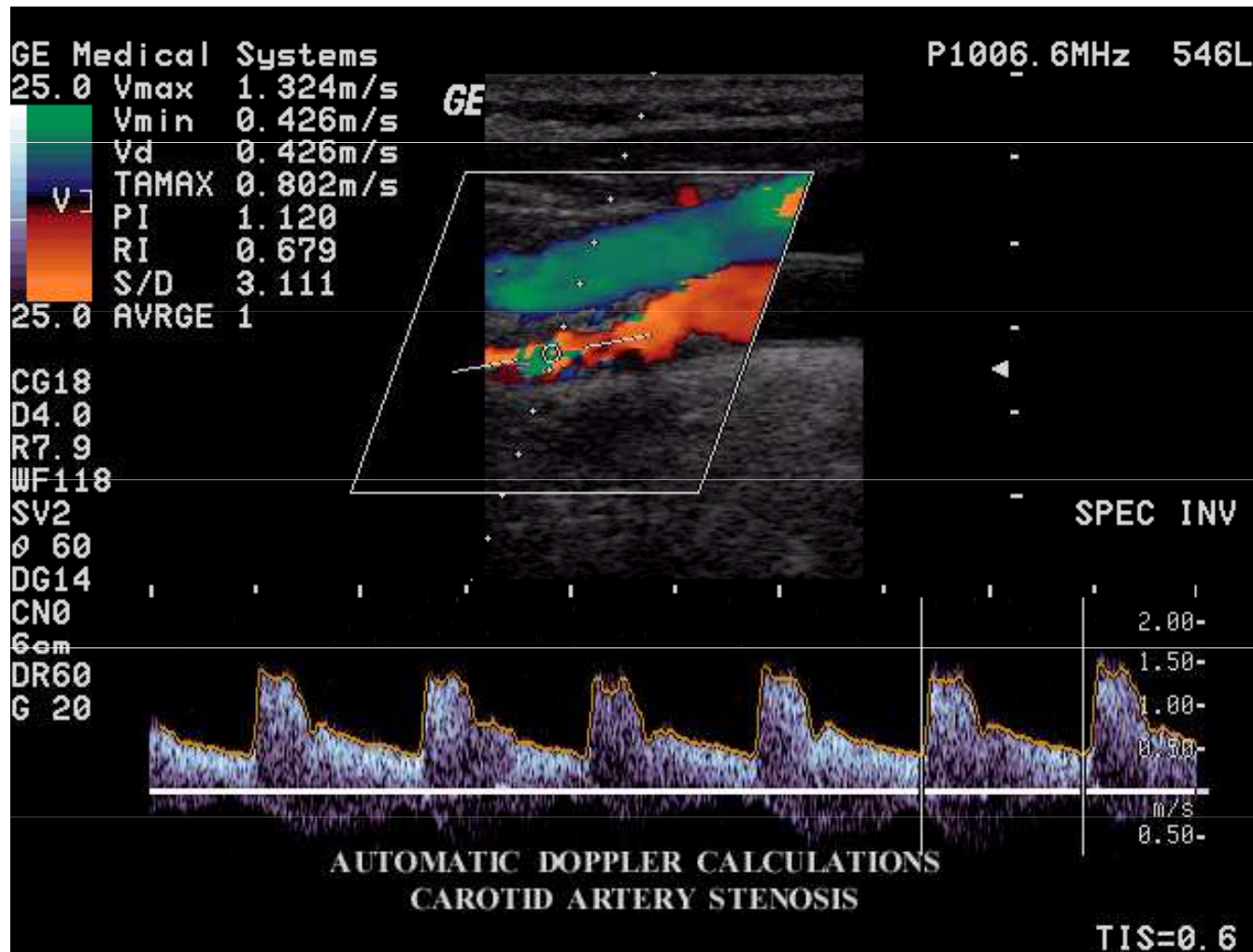

# Doppler methods

# Power Doppler method

- the whole energy of the Doppler signal is utilised
- mere detection of blood flow only little depends on the so-called Doppler incidence angle
- imaging of even very slow flows (blood perfusion of tissues and organs)
- flow direction is not shown

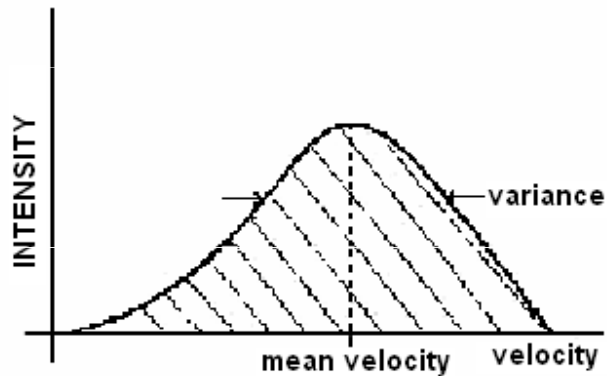

Carotid bifurcation

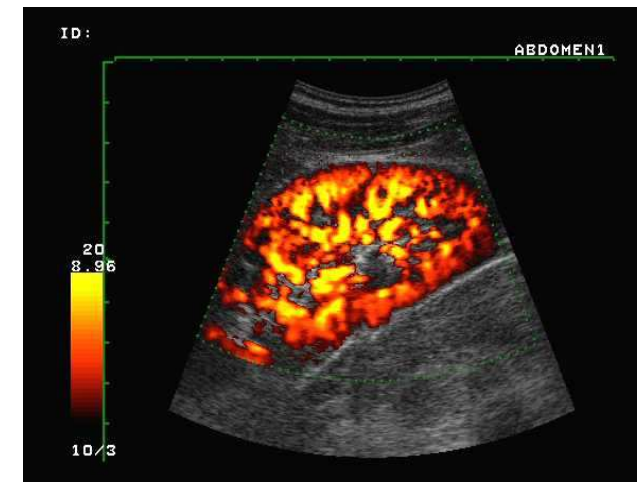

Renal perfusion

# Tissue Doppler Imaging (TDI)

Colour coding of information about velocity and direction of movements of tissues

Velocities 1-10 mm/s are depicted.

TDI of *a. carotis communis* during systole

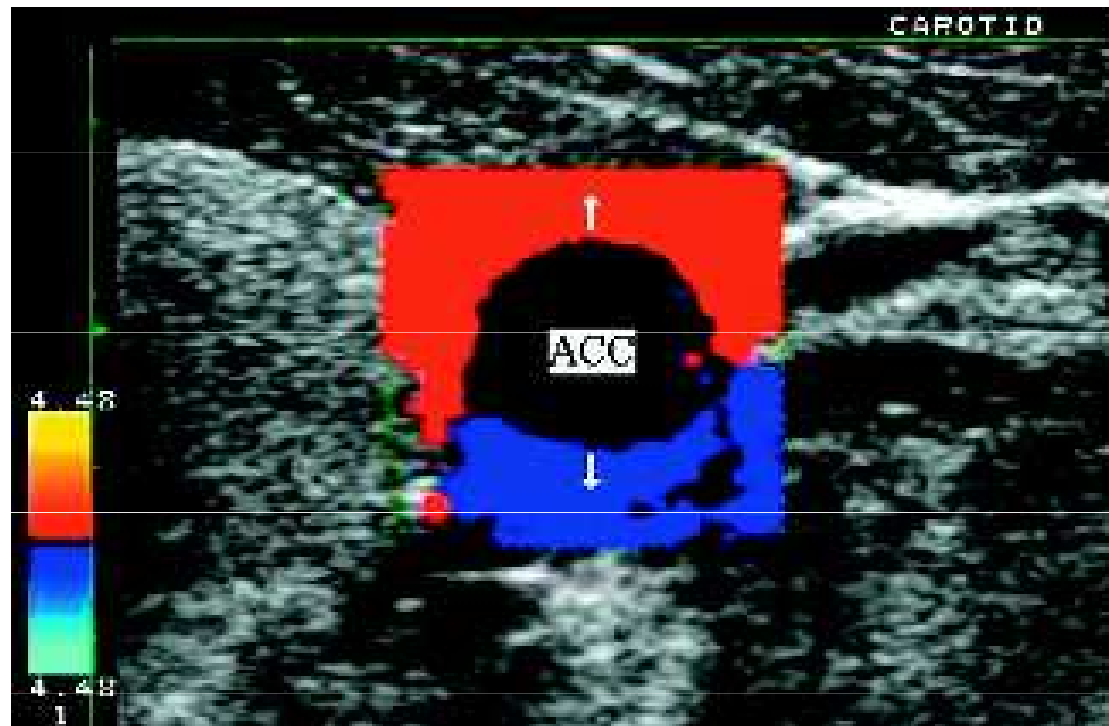

# Elastography

**Elastography is an imaging modality analogous to palpation.** Basis: pathological changes of tissues can manifest themselves like changed mechanical properties, e.g. rigidity. The tumours are more rigid than healthy tissues in most cases. This method allows to visualise inner structures of some tissues based on the measurement of the response to the tissue compression from the body surface. This response depends, among others, on the microscopic and macroscopic structure of the tissues. Moreover, the tissues have also the so called viscoelastic and poroelastic properties (poroelasticity is a specific elasticity of porous materials which pores are filled by a liquid).



# Elastography

Elastic properties of tissues cannot be evaluated based on a simple sonogram. Hence several ultrasonic elastographic methods were developed:

**Strain-Stress Elastography** where the tissue deformation is caused by the pressure exerted by the ultrasound probe.

**Acoustic Radiation Forced Impulse Elastography** where the pressure is exerted by a strong impulse of radiation force.

At present time, the **SWE – Shear Wave Elastography** is dominant. In this method, instead of the pressure action of the probe, the radiation force of the ultrasound waves is exploited – see the picture. The compression is done by means of relatively long repeated focussed impulses along the imaging axis, which produce the shear (transverse) waves. These waves propagate much slower than the longitudinal waves which speed is proportional to the tissue's elasticity (Young modulus). The particles of medium move (oscillate) with the amplitude of some micrometres, and to visualise this movement is needed a special imaging mode denoted as supersonic imaging – it encompasses ultrafast image processing (5000–20000 frames/s). In comparison with the previous method, the information on tissue elasticity is quantitative, the colour scale is calibrated in kPa.



# Elastography

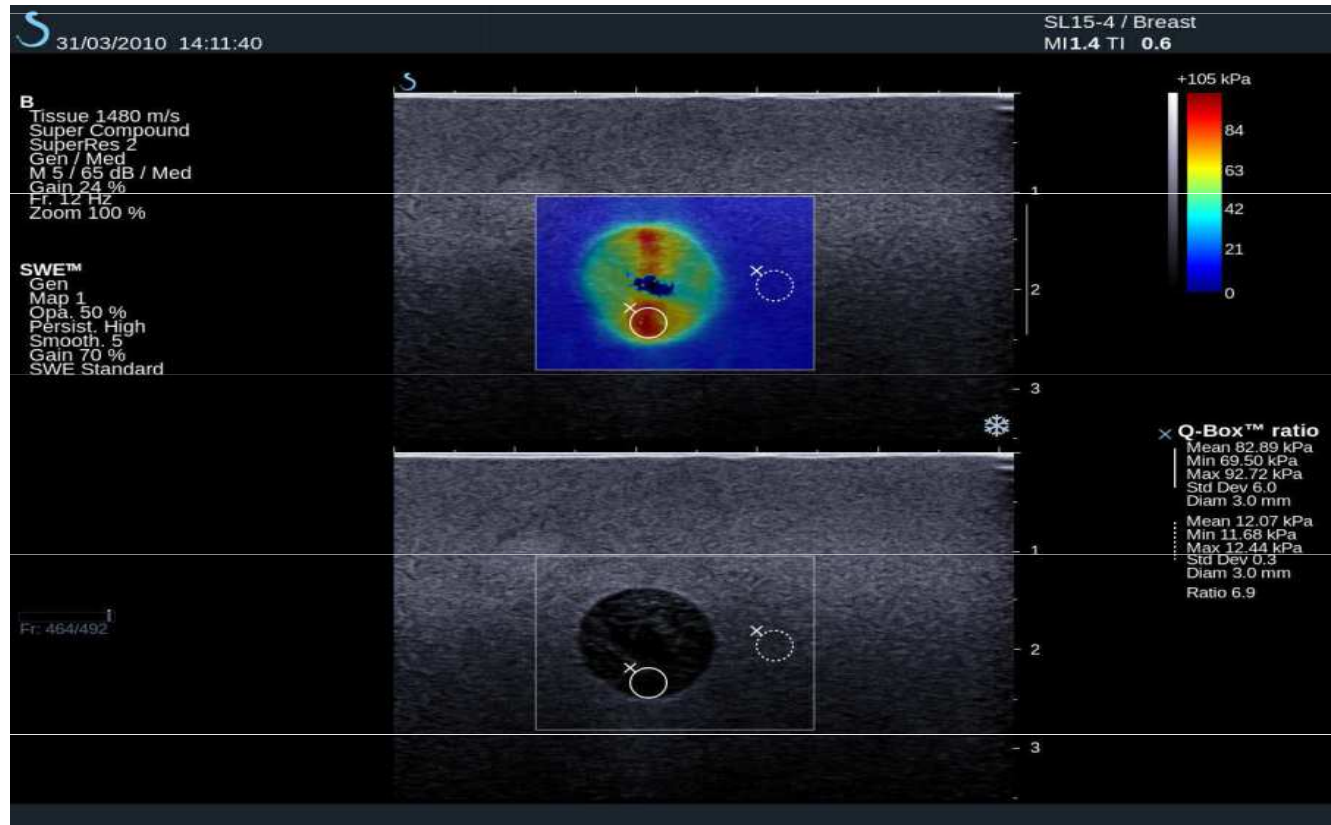

SWE elastography of a phantom with two areas of different elasticity. In the upper part we can see an elastogram, in the lower part a grayscale ultrasonogram.

# Ultrasonic densitometry

It is based on both the measurement of speed of ultrasound in bone and the estimation of ultrasound attenuation in bone. In contrast to X-ray methods, ultrasound densitometry also provides information on the structure of bone and its elastic properties.

- The speed of ultrasound depends on the density and elasticity of the measured medium. The anterior area of the tibia and the posterior area of the calcaneus are frequently used as places of measurement. The speed of ultrasound is given by the quotient of measured distance and the transmission time.
- Ultrasound attenuation depends on the physical properties of the given medium and the frequency of the ultrasound applied. For the frequency range 0.1 - 1 MHz the frequency dependence is nearly linear. Attenuation is currently expressed in dB/MHz/cm.
- Clinical importance: diagnostics of osteoporosis

# Ultrasonic densitometry



Ultrasound measurements used to assess bone density at the calcaneus

**M U N I**

## **Patient Safety: reducing Ultrasound 'Doses'**

**(see also the lecture on ultrasound cavitation)**

## Prudent use of Ultrasound

- US is non-ionising BUT since many bioeffects of ultrasound have not yet been studied fully, 'prudent' use is recommended
- ALARA – as low as reasonably achievable (exposure)
- In practice 'prudent' = justification + optimisation

# Biological Effects

- Possible bioeffects: inactivation of enzymes, altered cell morphology, internal haemorrhage, free radical formation ...
- Mechanisms of bioeffects:
  - Mechanical effects
    - Displacement and acceleration of biomolecules
    - Gas bubble **cavitation** (stable and transient) – see the lecture on biological effects of ultrasound
  - Elevated tissue temperatures (absorption of ultrasound and therefore increase in temperature high in lungs, less in bone, least in soft tissue)
- Bioeffects are deterministic with a threshold (cavitation) or without it (heating).

## Output Power from Transducer

- varies from one machine to another
- Increases as one moves from real-time imaging to colour flow Doppler
- M-mode output intensity is low but dose to tissue is high because beam is stationary

# Risk Indicators

- To avoid potentially dangerous exposures, two indices were introduced. Their values (different for different organs) are often displayed on device screens and should not be exceeded.
- **Thermal Index (TI):** TI = possible tissue temperature rise if transducer is kept stationary
  - TIS: soft tissue path
  - TIB: bone near focus of beam
  - TIC: Cranium (near surface bone)
- **Mechanical Index (MI):** measure of possible mechanical bioeffects



## More on the TI and MI

**Thermal index** – device power divided by the power that would increase the temperature by one degree under conditions of minimum heat loss (without perfusion).

**Mechanical index** (for assessment of cavitation-conditioned risk, increased danger when using echocontrast agents):

$$MI = I_{UZ} / \sqrt{f} \quad [W \cdot cm^{-2}, MHz]$$

### Justification

- No commercial demos on human subjects
- No training on students
- No 'see baby just for fun' or excessive screening in obstetrics

# Optimisation of 'Dose'

- **Minimise TI and MI and use appropriate index (TIS, TIB, TIC), care in cases when these underestimated**
- **Check acoustic power outputs on manual**
- **Use high receiver gain when possible as opposed to high transmit power**
- **Start scan with low transmit power and increase gradually**
- **Avoid repeat scans and reduce exposure time**
- **Do not hold transducer stationary**
- **Greater care when using contrast agents as these increase the possibility of cavitation**
- **Exceptional care must be taken in applying pulsed Doppler in obstetrics**
- **Regular quality control of the ultrasound device**

# MUNI

## Authors:

Vojtěch Mornstein, Ivo Hrazdira, Pavel Grec

## Content collaboration and language revision:

Carmel J. Caruana

## Graphical design:

Lucie Mornsteinová

Last revision: September 2024



— Bad Hair Day! —

<http://www.freehotgame.com>