

# Hereditary Cancer Syndromes

---



**Marek Svoboda**

**Masaryk Memorial Cancer Institute  
& Faculty of Medicine, Masaryk University**

# Human Genome Milestones

from the perspective of cancer genetics

1866 – Gregor Mendel, Brno, **Mendelian inheritance**

1953 – **DNA structure** (*Nature*, Watson, J.D., Crick, F.H )

1974 – Knudson AG, study of retinoblastomas: “**two-hit hypothesis**“

1982 – identification of **the first human oncogenes** „H-ras“ a  
„K-ras“

1987 – identification of **the Rb1 tumor supresor gene**

1999 – Fearon-Vogelstein’s **evolutionary model of carcinogenesis**

2000 – „**the next generation sequencing**“ (DNA sequencers on the market)

2001 – „**the draft**“ of the human genome (*Nature and Science*)

2003 – the Human Genome Project finished **the human genome sequence (ca 30 000 genes)**

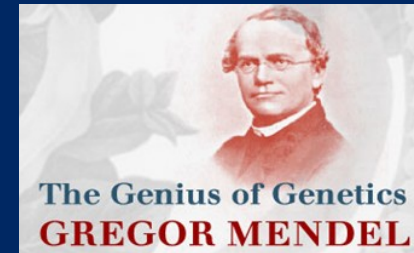

# Basic Dogmas of Oncology

## I) Cancer is a genetic disease

Aberrant gene expression is a key step in the initiation, promotion and progression of the tumor

## II) Carcinogenesis is a multistep process

Carcinogenesis is a multistep process involving alterations in at least two distinct classes of genes

## III) Biological correlates of gene expression are identifiable

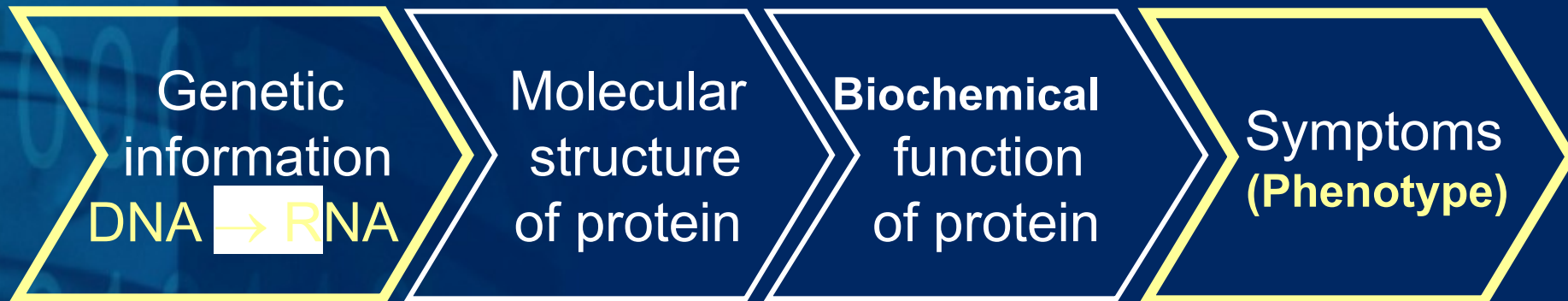

# Hereditary Cancer Syndromes

## MOLECULAR BIOLOGY

- Cancer- Accumulation of series of mutations at various cancer-susceptibility genes
- Most solid adult Tx requires 5-10 rate limiting mutations to acquire malignant phenotype
- Uncontrolled cell growth, invasion and metastasis

### GATE-KEEPER GENES

- Oncogenes-  
*c-ras, k-ras*
- Tumor suppressor genes  
(Anti-oncogenes)  
*p53, p21*

### CARE-TAKER GENES

- Stability genes/ DNA mismatch repair genes  
(DNA MMR)  
*MLH1, MSH2, MSH6*



# Hereditary Cancer Syndromes

## MOLECULAR BIOLOGY

- Everyone has two copies of each gene, one from each parent.
- Most people are born with two normal copies of each gene.
- In hereditary cancers a person is born with changes or mutations in one copy of a cancer-susceptibility gene
- In the majority of these cases, the changes were inherited from the mother or father.
- **Knudson's "two-hit" hypothesis**- two hits/ mutations within a genome are necessary for a malignant phenotype to develop'
- **Hereditary cancer**- One hit is already present in every cell (from birth)- only one additional hit is necessary
  - Additional hit-
  - 1. **Gain in function**- Proto-oncogene → Oncogene
  - 2. **Loss of function**- Inactivates Tumor Suppressor gene
- **Sporadic cancer**- Both hit occurs within a single somatic cell (after birth)

\*Carl O. Nordling in 1953, Alfred G. Knudson in 1971

# Hereditary Cancer Syndromes

## Hereditary cancer ~5-10%

- Early diagnosis
- Bilateral cancers
- Multiple primaries in an individual
- Multiple affected family members
- Spanning a number of generations
- Rare cancers (ovarian cancer, male breast cancer)

## Familial cancer ~ 15-20%

- More cases of a specific type(s) of cancer within a family than expected, but no specific pattern of inheritance
- Age of onset variable
- May result from chance clustering of sporadic cases
- May result from common genetic background (low penetrance gene), similar environment and/or lifestyle factors

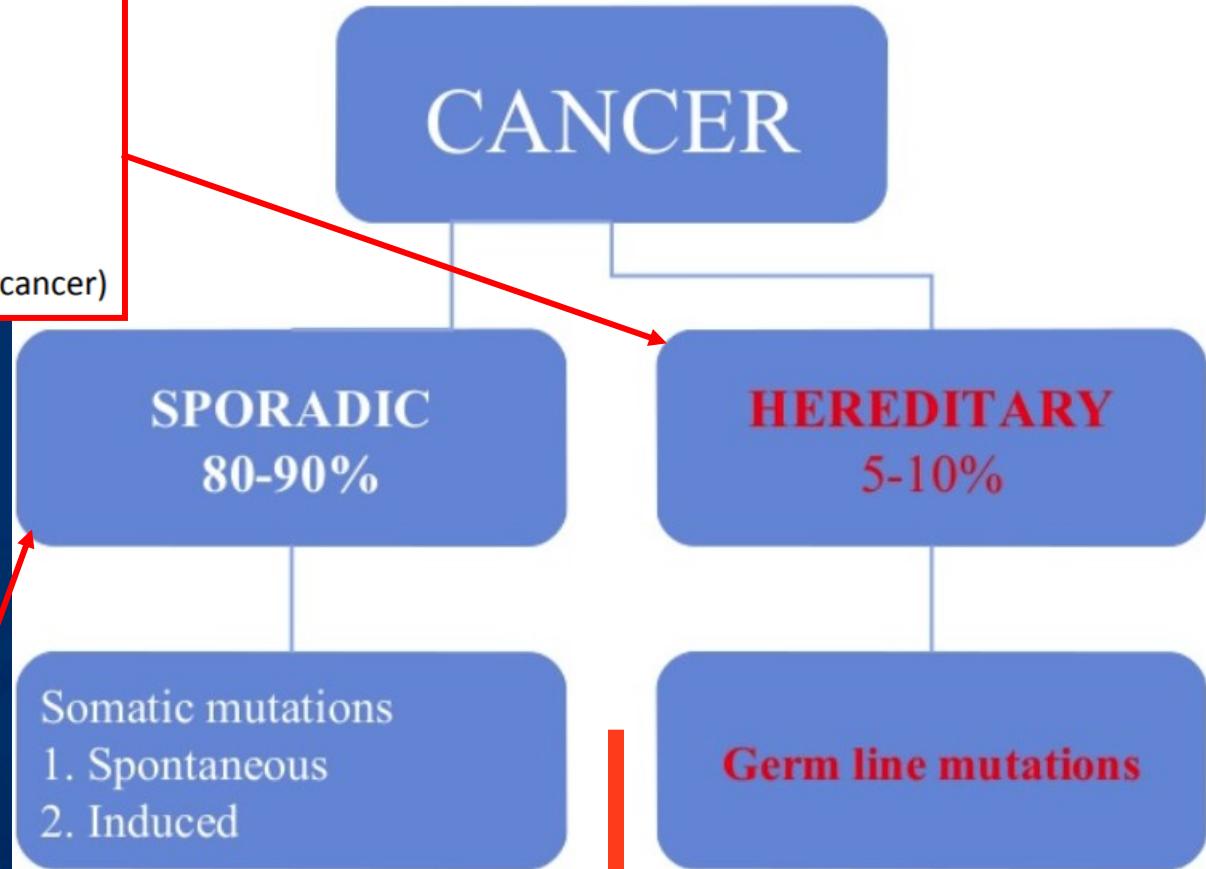

*Cancer is a common disease, so some families will have some members who having the same cancer but that does not mean the cancer in that family is hereditary.*

# Hereditary Cancer Syndromes

## HEREDITARY CANCER SYNDROMES (HCS)

- Changes (or mutations) in specific genes are passed from one blood relative to another.
- Individuals who inherit one of these gene changes will have a higher likelihood of developing cancer within their lifetime

## Characteristics

- Hereditary cancers often occur **earlier than the sporadic form of the same cancer**, so SCREENING from younger age is recommended
- Individuals having the inherited gene may be at a higher risk for **more than one type of cancer**. For cancer survivors, this may affect cancer treatment options or follow-up care
- Usually produce site-specific cancers
- Two or more relatives affected



# Hereditary Cancer Syndromes

## GENETIC SUSCEPTIBILITY

- To describe the high risk for cancer in people with an inherited mutation
- People with an inherited gene change have a 50% chance of passing the mutation to each of their children
- Do **not** increase the risk for every type of cancer
- **Not everyone** who is born with a gene change will develop cancer

## WHY?

- **Second hit** may not take place
- **Incomplete penetrance**- the AD gene is expressed at all or not
- **Expressibility**- Degree to which the phenotypes are expressed
- **Co-dominance**- alleles of a gene pair are different from each other but both are expressed



# Hereditary Cancer Syndromes

## Hereditary Cancer Syndromes (most common)

- Hereditary Breast and Ovarian Cancer Syndrome (BRCA1 and BRCA2)
- HNPCC/Lynch Syndrome (MMR genes – MLH1, MSH2, MSH6, PMS2 ) and EPCAM gene
- FAP, AFAP and MAP (APC and MYH)
- Malignant melanoma (p16 , CDK4)
- Hereditary Diffuse Gastric Cancer (CDH1)
- Paraganglioma Syndromes (SDHB,C,D)
- Von Hippel Lindau (VHL)
- Cowden Syndrome (PTEN)
- Neurofibromatosis type 1 and type 2 (NF1 and NF2)
- Juvenile Polyposis (BMP1A, SMAD4, LKB1)
- Li-Fraumeni Syndrome (p53)

# Hereditary Cancer Syndromes

## Hereditary Cancer Syndromes and Public Health

- ~5-10% of all cancers (with some exceptions)
- High risk of multiple primaries
- Occur at younger age
- Multiple family members affected
- Early identification would benefit from preventive care options

## MANAGEMENT OF FAMILY MEMBERS OF HCS

- Genetic Counseling
- Screening
- Intervention
  - Life-style modification
  - Pharmacological (Chemoprevention)
  - Surgical
  - Reproductive options

# Hereditary Cancer Syndromes

## IDENTIFYING AT-RISK PATIENTS



### Genetic counseling

- Consulting with an expert in cancer genetics
- Reviewing the family medical history including family members who never developed cancer
- Assessing and explaining risk for hereditary cancers
- Discussing the benefits and limitations of genetic testing
- Determining which family member is most appropriate to begin the genetic testing process in a family
- Interpreting genetic test results and explaining what they mean for
- Providing referrals to experts for follow-up screening and risk management
- Addressing common concerns about the privacy and confidentiality of personal genetic information



# Hereditary Cancer Syndromes

## Obtaining a Family History

- 4 generations – list all maternal and paternal relatives, whether or not they have had cancer
- Age at cancer diagnosis
- Pathology
- Age at death/cause of death
- History of oophorectomy or hysterectomy, CRC polyps-including number and pathology
- Ancestry

## Pedigree Analysis

Determine (suggest) the mode of inheritance: autosomal dominant, (AD), autosomal recessive (AR), sex-linked, mitochondrial.

Determine the probability of inheriting an *affected* gene for the offspring.

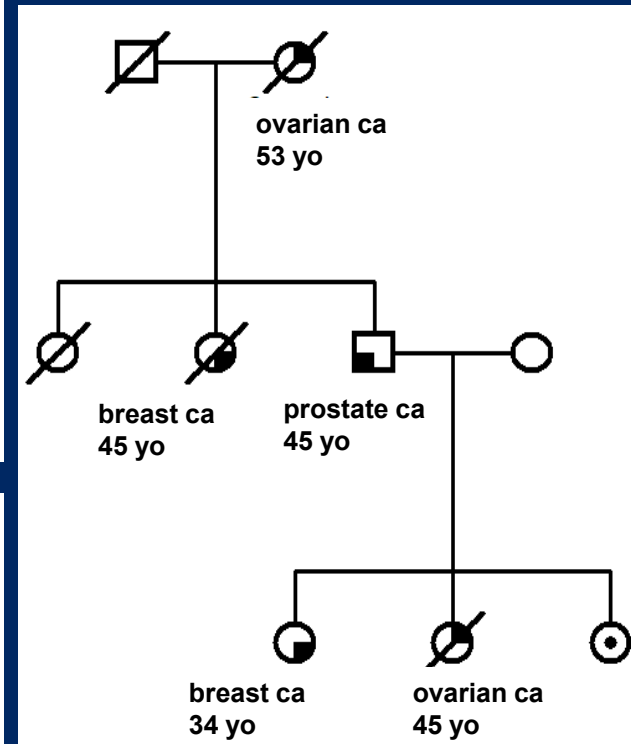

# Hereditary Cancer Syndromes

## SELECT AND OFFER TEST

### Interpretation of Genetic testing results



#### ■ Positive

- Mutation is found
- “have the gene”
- Seen in other individuals with disorder
- Surveillance decisions can be made

#### ■ Maybe

- Genetic change is found
- Not seen in other individuals with disorder
- Significance uncertain
- “Variant of uncertain significance”
- Seen 30% during panel testing
- Management decisions NOT made
- Revisit the clinic

#### ■ Negative

- No genetic change is found
- Limitation of the technology
- May have another gene involved
- Revisit the clinic, other gene testing

# Hereditary Cancer Syndromes

## Reproductive Decisions

**Some individuals want to know about prenatal diagnosis.**

- As hereditary cancer syndromes are not uniformly lethal, and the manifestation is in adulthood, prenatal diagnosis with a view to terminate pregnancy is not generally recommended.
- For Autosomal Dominant syndromes patients should be counseled that there is a 50% chance that the fetus does not carry the genetic mutation, and that inheriting the defective gene does not mean that cancer will definitely develop.
- As medical knowledge advances, we expect new preventive surveillance and treatment options may become available to the next generation and may significantly reduce cancer risk or improve cancer cure rates.
- Other considerations include PGD-IVF, gamete donation, and adoption.



# Hereditary Cancer Syndromes

## Hereditary Breast and Ovarian Syndrome (HBOC)

# Hereditary Cancer Syndromes

## GENETICS

- BRCA1 (*17q12-q21*) and BRCA 2 (*13q12-q13*)
- Autosomal Dominance Inheritance
- Tumor suppressor genes- encode proteins (1863 amino acid with zinc finger domain) necessary for repair of damaged DNA and also in DNA transcription
- Mutation→ profoundly sensitizes cells to the inhibition of PARP enzymatic activity→ uncontrolled cell proliferation in breast, ovary, tube, peritoneum
- Incomplete penetrance- depending on type of the mutation, phenotype of the individual and exogenous factors
- Prevalence- 0.24% in general population (Whittemore AS, Balise RR, Pharoah PD et al. *Br J Cancer* 2004;91:1911-1915)
- Highest prevalence- **Ashkenazi Jewish population** (2%) (Struwing JP, Hartge P, Wacholder S et al. *N Eng J Med* 1997;336:1401-1408)
- Founder mutations- Similar mutations found in different ethnic groups
- Most prevalent mutations-
  - BRCA1- *85delAG, 5382insC*
  - BRCA2- *6174delT*

# Hereditary Cancer Syndromes

## BRCA genes mutation penetrance

Cancer Type	Inherited Risk	General Population Risk
• Breast - female	45 - 84%*	11-12%
- male	up to 8%	<1%
• Ovarian and ovarian related	11 - 62%	1.5-2%
• Prostate	20%	16.2%
• There is also an increased incidence of melanoma, pancreatic and/or colon cancer in some families.		

\*Women who have already had breast cancer have up to a 20% risk to develop a new primary breast cancer within 5 years of their initial diagnosis, and up to a 60% risk in their lifetime.



# Hereditary Cancer Syndromes

## HBOC Testing Criteria (NCCN)

- **Individuals from a family with known BRCA1/2 mutation**
- **Personal H/O Breast Ca (invasive/ ductal Ca in situ) with any one**
  1. Diagnosed  $\leq 45$  yrs
  2. Diagnosed  $\leq 50$  yrs with
    - Additional Primary (C/L breast or I/L with clear separation)
    - $\geq 1$  close blood relatives with Ca Breast at any age
    - Unknown/ limited family H/O
  3. Diagnosed  $\leq 60$  yrs with triple negative Breast Ca (ER, PR, Her 2neu)
  4. Diagnosed at any age with
    - $\geq 1$  close blood relative with Breast Ca  $\leq 50$  yrs
    - $\geq 2$  close blood relatives with Breast Ca at any age
    - $\geq 1$  close blood relatives with Epithelial Ca Ovary
    - $\geq 1$  close blood relative with Male Breast Ca
    - $\geq 2$  close blood relatives with Ca Pancreas &/or Ca Prostate (Gleason's Score  $\geq 7$ )
    - High risk ethnicity (Ashkenazi Jewish)
- **Personal H/O Epithelial Ovarian Tx (or tube/ peritoneal Ca)**
- **Personal H/O Male Breast Ca**
- **Personal H/O Pancreatic Ca/ Ca Prostate (Gleason's Score  $\geq 7$ ) at any age with  $\geq 2$  relatives on the same side affected with breast/ ovarian/ pancreatic/ prostate Ca**
  1. **Family H/O only** (Discuss limitations of genetic testing) with
  2. First/ Second Degree Relative with Above-mentioned Criteria
- Third Degree Relative with Ca Breast/ Ca Ovary with  $\geq 2$  close blood relatives with Ca Breast (at least one diagnosed  $\leq 60$  yrs)

# Hereditary Cancer Syndromes

## If HBOC Testing Criteria Met

- Risk Assessment, Counseling, Psychological Support, Discuss genetic testing, Informed Consent

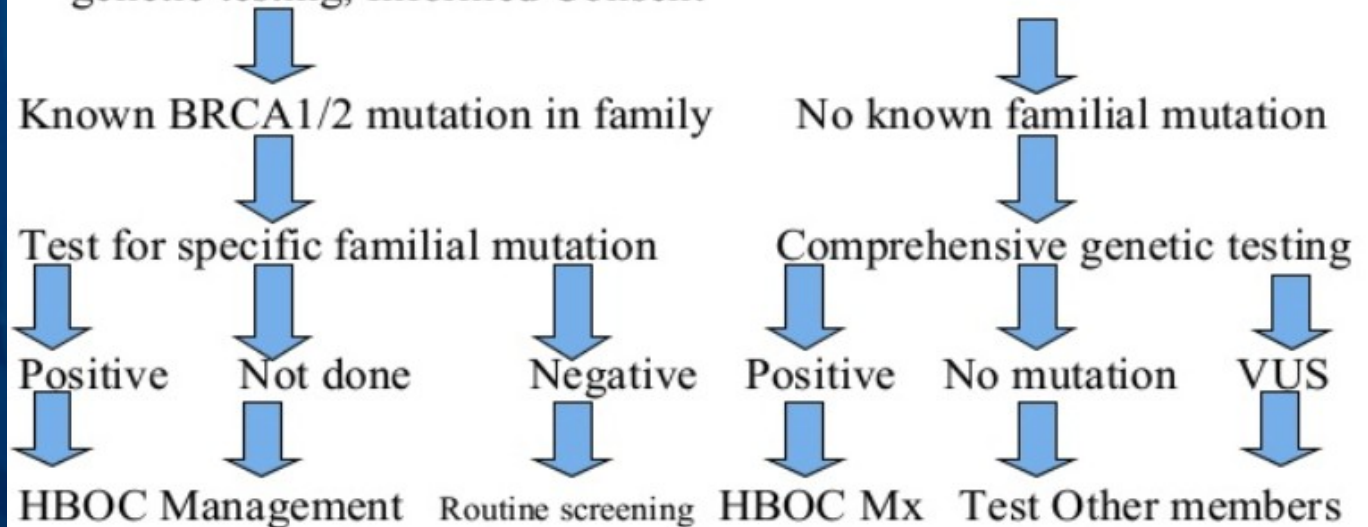

# Hereditary Cancer Syndromes

## Power of a negative test result in a HBOC family

A. Our patient was tested  
and no mutation found

- Increased risk for breast cancer based on family history
  1. Annual CBE and mammogram
  2. Annual breast MRI
- Increased risk for ovarian cancer based on family history
  1. Screening for ovarian cancer

B. Mutation identified in  
pt's relative and our pt  
tests negative for the  
familial mutation

- Pt. now at the general population risk to develop breast and ovarian cancer
  1. Annual CBE and annual mammogram
  2. No screening for ovarian cancer



# Hereditary Cancer Syndromes

## HBOC Syndrome Management (Positive BRCA mutation Carriers)

### For Women

- Breast Awareness- Starting at 18 years- Monthly SBE
- Clinical breast examination- from 25 yrs- every 6-12 mth
- Breast Screening
  1. Age 25-29 yrs - Annual breast MRI (preferably D7-D14) or mammography (if MRI not available)<sup>1</sup>
  2. Age 30-75 yrs - Annual Mammography/ MRI
  3. Age >75 yrs- Individualised management
- Discuss chemopreventive options
- Offer risk-reducing prophylactic mastectomy  
Based on earliest age of onset of Breast Ca in the family  
Discuss protection, risks, reconstructive options
- Offer risk reducing prophylactic BSO- 35-40 yrs, after family is completed
- Psychological, social and medical support after mastectomy/ BSO
- If does not opt for BSO- 6 monthly screening from 30 yrs or 5-10 yrs before earliest onset of familial Ca Ovary



# Hereditary Cancer Syndromes

## HBOC Syndrome Management (Contd.)

### For men

- From 35 yrs- Monthly SBE
- From 35 yrs- 6-12 monthly clinical breast exam
- 40 yrs- Baseline Mammogram/ MRI
- Annual breast imaging from 40 yrs- if gynecomastia or abnormal initial imaging
- From 40 yrs- Annual DRE and TRUS (Prostate Screening)

### For men and women

- No definite guidelines for pancreatic cancers
- Education regarding s/s of Cancers associated with BRCA
- Discuss reproductive options- PGD, AN diagnosis, childhood Tx and Fanconi's anaemia in BRCA2

### For relatives

- Risk Assessment and Genetic Counseling

# Hereditary Cancer Syndromes

## Life-Style Modification

### PREGNANCY

- BRCA- Full Term Pregnancy <40 yrs increases risk of early onset Ca Breast (OR 1.6 for BRCA1, 2.1 for BRCA2) but protects from late onset Ca Breast<sup>1</sup>

<sup>1</sup>Nadine A, David EG, Douglas FE. Pregnancies, Breast-Feeding, and Breast Cancer Risk in the International BRCA1/2 Carrier Cohort Study (IBCCS). *J Natl Cancer Inst* (19 April 2006) 98 (8): 535-544

- Another study- Each FT pregnancy reduces risk by 12%<sup>4</sup>

<sup>4</sup>Modan B, Hartge P, Hirsh YG, et al. Parity, oral contraceptives, and the risk of ovarian cancer among carriers and noncarriers of a BRCA1 or BRCA2 mutation *N Engl J Med*. 2001 Jul 26;345(4):235-40

### BREAST-FEEDING

- Breast feeding **reduces risk of Ca Breast** in BRCA significantly by suppressing ovulation, reducing estrogen and directly acting on mammary tissue<sup>1</sup>

<sup>1</sup>Jernström, Lerman C, P Ghadirian, et al. Pregnancy and risk of early breast cancer in carriers of BRCA1 and BRCA2. *The Lancet*, Volume 354, Issue 9193; 1846 - 1850

### TUBAL LIGATION

- General population- TL **protects against Ca Ovary**
- BRCA carriers- protective in BRCA1, **not** in BRCA2 <sup>2</sup>

<sup>2</sup>Narod SA, Sun P, et al. Tubal ligation and risk of ovarian cancer in carriers of BRCA1 or BRCA2 mutations: a case-control study. *Lancet* 2001;357:1467-1470

# Hereditary Cancer Syndromes

## CHEMO-PREVENTION

### ORAL CONTRACEPTIVE PILLS (COC)

- **Ca Ovary**

- General Population- Protective (50% reduced risk after 5 yrs, 80% after 10 yrs)
- BRCA- Protective in both BRCA1 and BRCA2
- Modan et al, 2001- No added protection as typically seen in general population<sup>1</sup>

<sup>1</sup>Modan B, Hartge P, Hirsh YG, et al. Parity, oral contraceptives, and the risk of ovarian cancer among carriers and noncarriers of a BRCA1 or BRCA2 mutation N Engl J Med. 2001 Jul 26;345(4):235-40

- **Ca Breast**

- General population- Early start of OCP increases (slightly) risk of early Ca Breast but protects from late onset Ca Breast
- Earlier studies- Small increase in Ca breast, mainly in BRCA1
- Recent studies- Low dose COC does not increase the risk<sup>2</sup>

<sup>2</sup>Milne RL, Knight JA, John EM, Dite GS, et al. Oral contraceptive use and risk of early-onset breast cancer in carriers and noncarriers of BRCA1 and BRCA2 mutations. Cancer Epidemiol Biomarkers Prev. 2005 Feb;14(2):350-6.

- **Conclusion-**

- Newer forms of COC possibly protects against ca Ovary in BRCA but role in Ca Breast is UNCERTAIN (probably no increased risk)



# Hereditary Cancer Syndromes

## CHEMO-PREVENTION (Contd.)

### TAMOXIFEN

- SERM use can protect against Ca Breast in BRCA2, but not in BRCA1<sup>1</sup>
- BRCA1 is mostly ER/PR -ve, while BRCA2 is mostly ER/PR +ve

<sup>1</sup>King MC, Wicand S, Hale K, Lee M, Walsh T, Owens K, et al. Tamoxifen and breast cancer incidence among women with inherited mutations in BRCA1 and BRCA2: National Surgical Adjuvant Breast and Bowel Project (NSABP-P1) Breast Cancer Prevention Trial. JAMA 2001;286:2251-6

- A Decision Analysis- a BRCA carrier at 30 yrs- Tamoxifen increases survival by 1.8 years and quality-adjusted survival by 2.7 years<sup>2</sup>

<sup>2</sup>Grann VR1, Jacobson JS, Thomason D, Hershman D, Heitjan DF, Neugut AI. Effect of prevention strategies on survival and quality-adjusted survival of women with BRCA1/2 mutations: an updated decision analysis. J Clin Oncol. 2002 May 15;20(10):2520-9

### INNOVATIVE METHODS

- PARP Sensitizers<sup>3</sup>

<sup>3</sup>Hannah F, Nuala M, Christopher JL. Targeting the DNA repair defect in BRCA mutant cells as a therapeutic strategy. Nature 434, 917-921 (14 April 2005)



# Hereditary Cancer Syndromes

## PROPHYLACTIC OOPHORECTOMY

- NCCN 2014, NIH 1995, SGO 2005- all recommend prophylactic BSO
- Reduces risk of Ca Ovary and Ca Tube
- Reduces risk of Ca Breast from 42% to 21%- by removing the source of estrogen
- Benefit extends for even those with already diagnosed Ca Breast
- Role in Primary Ca Peritoneum- Uncertain

# Hereditary Cancer Syndromes

## PROPHYLACTIC OOPHORECTOMY

(Contd.)

### Evidences

- If done at 30 yrs- prophylactic oophorectomy improved survival by 0.4 to 2.6 years; mastectomy, by 2.8 to 3.4 years; and mastectomy and oophorectomy, by 3.3 to 6.0 years over surveillance<sup>1</sup>

<sup>1</sup>Grann VR1, Panageas KS, Whang W, Antman KH, Neugut AI. Decision analysis of prophylactic mastectomy and oophorectomy in BRCA1-positive or BRCA2-positive patients. *J Clin Oncol.* 1998 Mar;16(3):979-85.

- Kauff et al, 2002 (*NEJM*, 2002;346:1609-1615)- BSO reduces risk of Ca Ovary, compared to screening.
- 5 yr cancer-free survival was 94% (BSO) vs 69% (Screening)
- Moller et al, 2002 (*Int J Cancer* 2002;101:555-559)- 5 yr disease free survival was 100% for Ca Breast

# Hereditary Cancer Syndromes

## PROPHYLACTIC OOPHORECTOMY

(Contd.)

### Timing of Surgery

- Recommendation- 35-40 yrs, after family is completed (NCCN, 2014)
- BRCA1- Ca Ovary starts from late 30 and early 40- 54% before 50 yrs of age
- Modern trend of delay in child bearing- poses problem
- BRCA2- Ca Ovary occurs 10 yrs later than BRCA1  
BSO can be performed near natural menopause  
Decreases protection against Ca Breast (at 50 yr- 26- 34% risk)



# Hereditary Cancer Syndromes

## PROPHYLACTIC OOPHORECTOMY

(Contd.)

### Hysterectomy

- **Points in favour**

- Reduces the risk of leaving behind a residual tube at the time of BSO
- Theoretically malignant transformation in interstitial part of the tube possible
- Eliminates risk of Ca Endometrium in women receiving HRT/ Tamoxifen
- Higher incidence of UPSC in Ashkenazy Jewish women carrying BRCA mutation (Goldman NA et al. ASCO Proc 2002;21. Lavie O et al. Gynecol Oncol 2004;92:521-524)

- **Points against**

- Ca tube occurs most commonly in the distal portion
- No report of Ca tube in interstitial part in BRCA
- Goshen et al (Gynecol Oncol 2000;79:477-481) did not find any correlation between UPSC and BRCA



# Hereditary Cancer Syndromes

DNA repair biomarkers for PARP inhibitor therapies

## New investigational therapy: PARP inhibitors

- Two genes are said to be in a **synthetic lethal relationship** if a mutation in either gene alone is not lethal but mutations in both cause the death of a cell.
- Inhibition of PARP[poly(adenosine-diphosphate-ribose) polymerase] appears to selectively kill cells which lack functional BRCA.



Cell Survival



Cell Survival



Apoptosis  
/Cell Death

# Hereditary Cancer Syndromes

## Colorectal Cancer Genetics

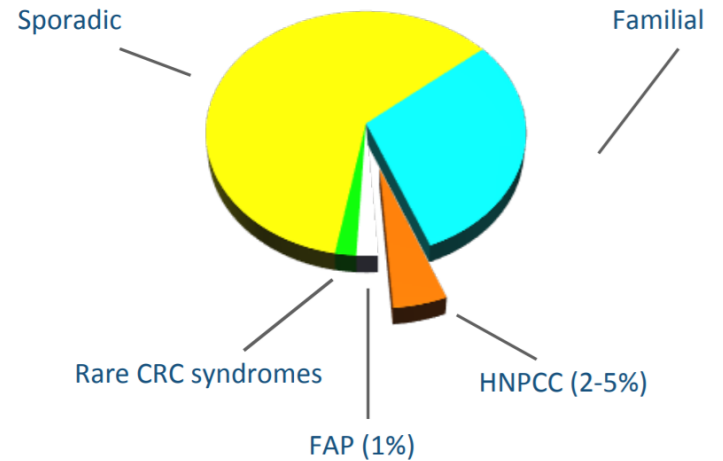

## Risk of Colorectal Cancer

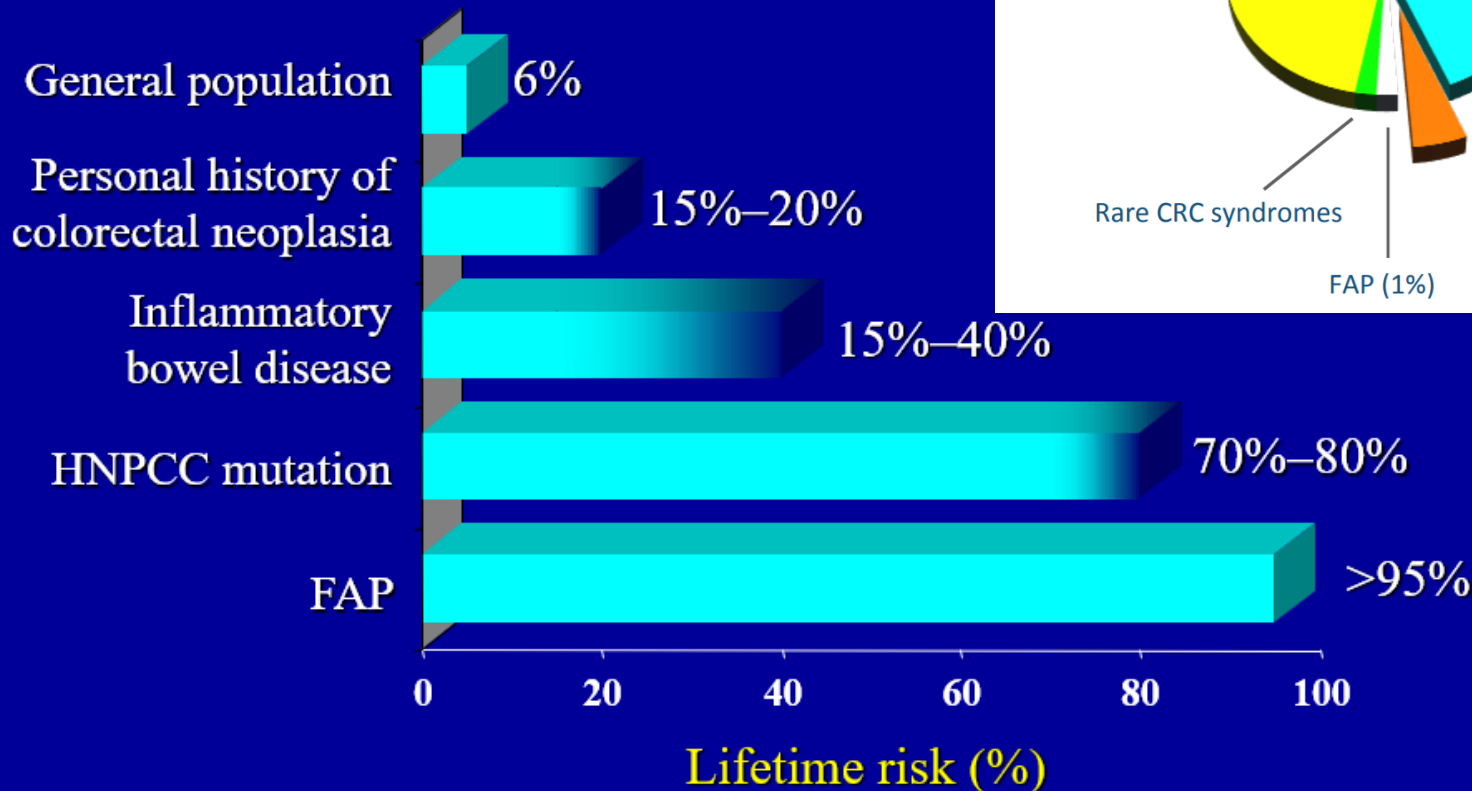

# Hereditary Cancer Syndromes

## Lynch syndrome (LS)/Hereditary non-polyposis colorectal cancer

- Germline mutations in one of four mismatch repair (MMR) genes (*MLH1*, *MSH2*, *MSH6*, and *PMS2*) and *EPCAM* gene
- *MLH1* and *MSH2* germline mutations account for approximately 90%;
- *MSH6* mutations ~7%-10%; and
- *PMS2* mutations in fewer than 5%.
- Germline deletions in *EPCAM* (not a mismatch repair gene) inactivate *MSH2* in about 1% of individuals with Lynch syndrome.

# Hereditary Cancer Syndromes

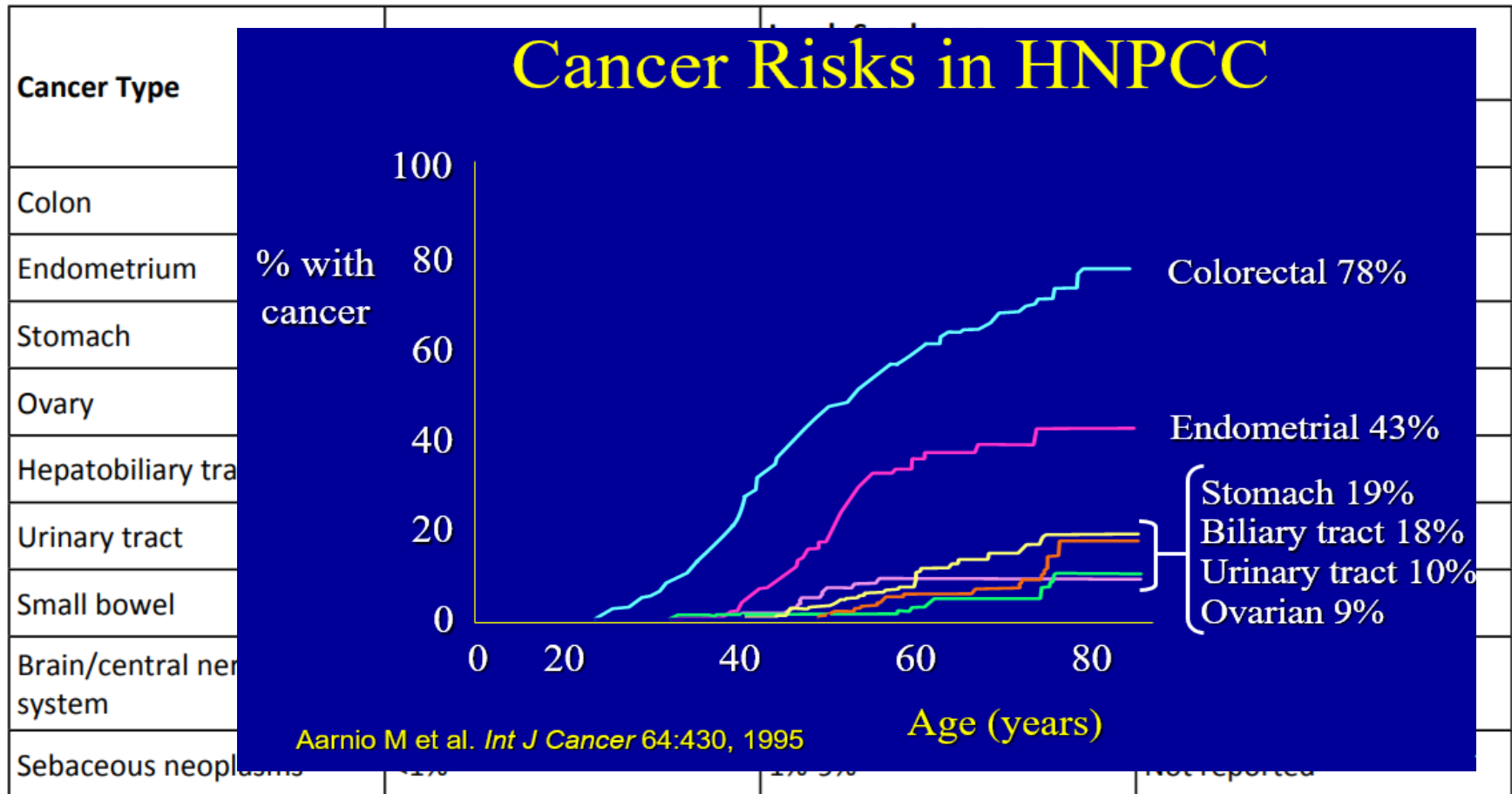

Aarnio et al [1999], Vasen et al [2002], American Cancer Society [2002], Hampel et al [2005], Ponti et al [2006], South et al [2008], Watson et al [2008], Barrow et al [2009], Barrow et al [2009], Stoffel et al [2009]



# Hereditary Cancer Syndromes

## Amsterdam Criteria used to diagnose Lynch syndrome (3-2-1)

### Amsterdam Criteria

- **Three** or more family members, one of whom is a first-degree relative of the other two, with a confirmed diagnosis of colorectal cancer
- **Two** successive affected generations
- **One** or more colon cancers diagnosed before age 50 years
- FAP(Familial Adenomatous Polyposis) excluded

### Amsterdam II Criteria

- **Three** or more family members, one of whom is a first-degree relative of the other two, with HNPCC-related cancers \*\*

# Hereditary Cancer Syndromes

## Bethesda Guidelines - used to screen (criteria for microsatellite instability testing)

### Colorectal cancer

- Under age 50
- With a synchronous or metachronous HNPCC tumor
- Under age 60 with histology consistent with HNPCC
  - tumor infiltrating lymphocytes, Crohn-like reaction, mucinous/signet ring differentiation, medullary growth pattern
- With a first-degree relative who has an HNPCC tumor <50
- With 2 first or second-degree relatives with HNPCC tumor

## Pedigree of a Lynch syndrome family

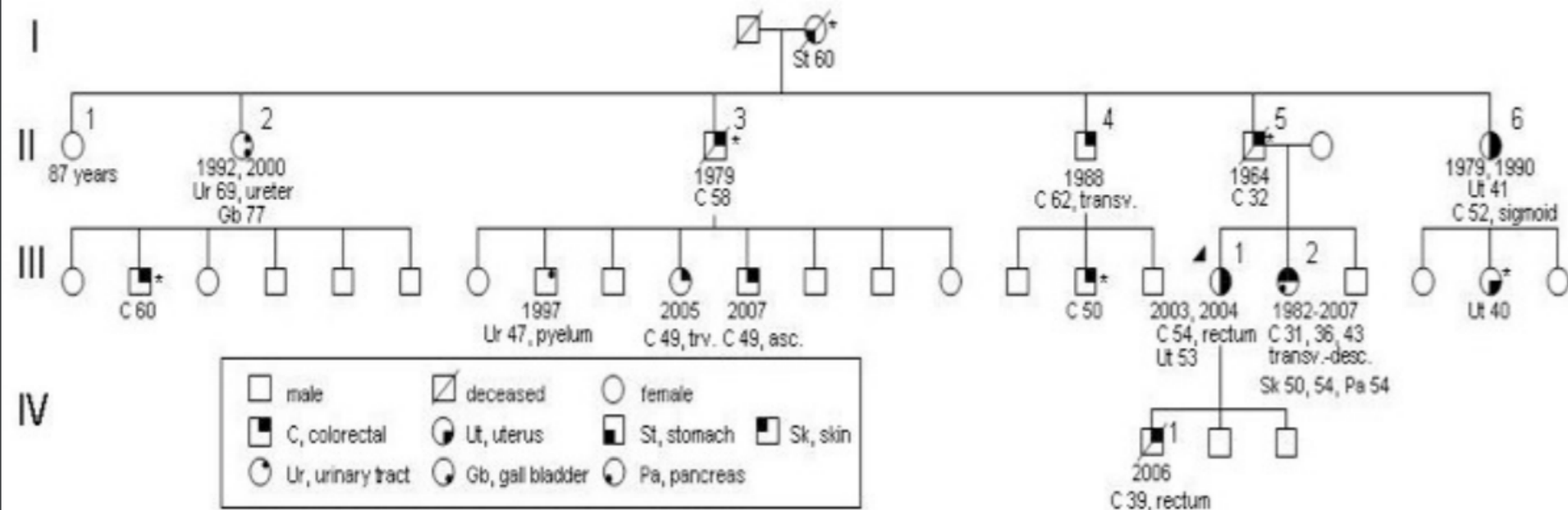



# Hereditary Cancer Syndromes

## Lynch syndrome- MMR genes

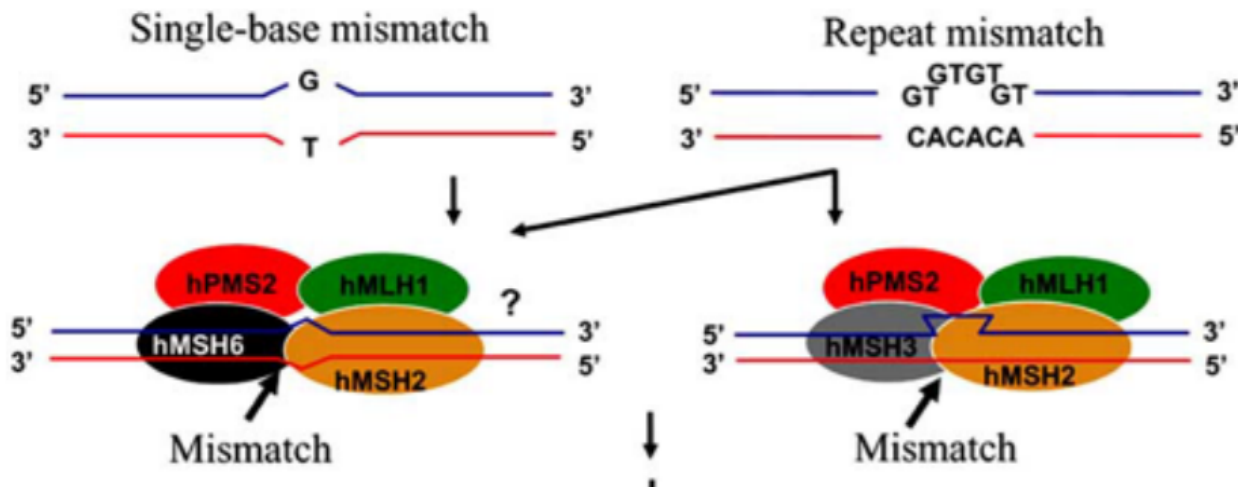

## Immunohistochemistry (IHC)

- Stain archived tumor tissue for MMR proteins
- Missing protein indicates which gene to sequence
  - MLH1 and PMS2
  - MSH2 and MSH6
- MLH1 can be lost by methylation or by somatic mutations

# Hereditary Cancer Syndromes

## Mismatch Repair Failure Leads to Microsatellite Instability (MSI)

## Microsatellite Instability (MSI)

Normal

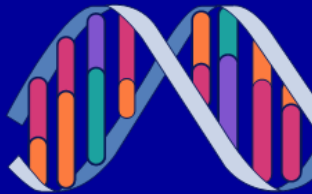

- 10%–15% of sporadic tumors have MSI
- 95% of HNPCC tumors have MSI at multiple loci

Microsatellite  
instability

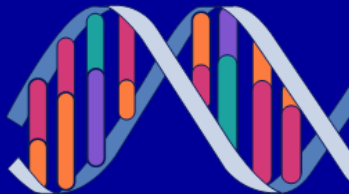

*NEJM* 342:71, 2000

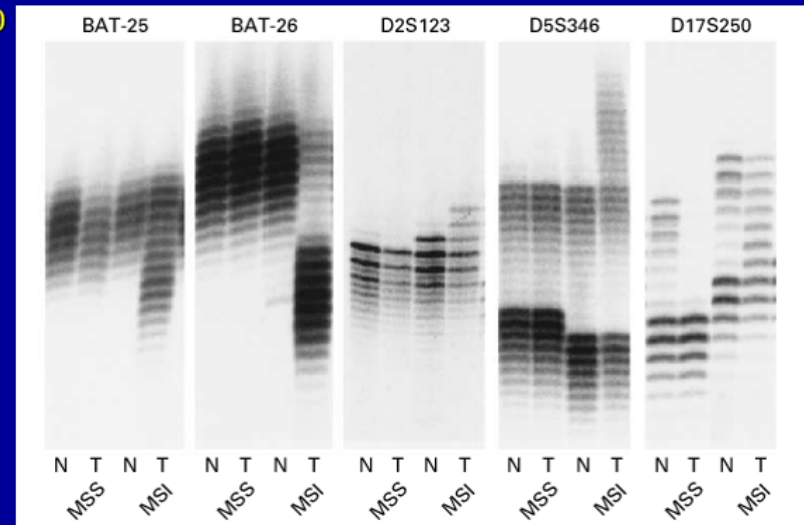

## Management of Lynch syndrome

- Increased surveillance
  - Colorectal, endometrial
- Prophylactic surgery
  - Colorectal, endometrial

Malignancy	Intervention	Recommendation
Colorectal cancer	Colonoscopy	Begin at age 20–25, repeat every 1–2 years
Endometrial cancer	<ul style="list-style-type: none"> <li>• Transvaginal ultrasound</li> <li>• Endometrial aspirate</li> </ul>	Annually, starting at age 25–35

- Does surveillance help??
  - Detection of CRC at an earlier stage, to a 63% reduction of the risk of CRC and to a significant reduction of the mortality associated with CRC



# Hereditary Cancer Syndromes

## Surveillance Reduces Risk of Colorectal Cancer in HNPCC Families

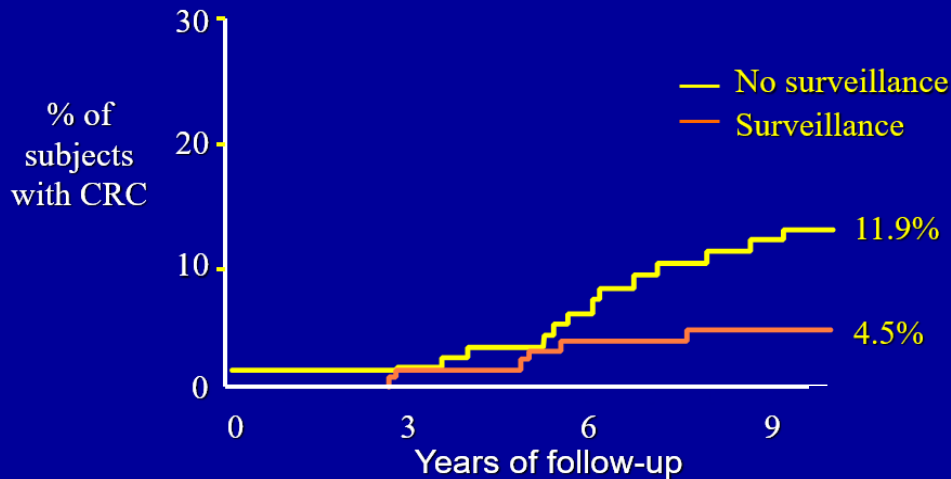

Jarvinen HJ et al. *Gastro* 108:1405, 1995

## Surveillance Improves HNPCC Survival

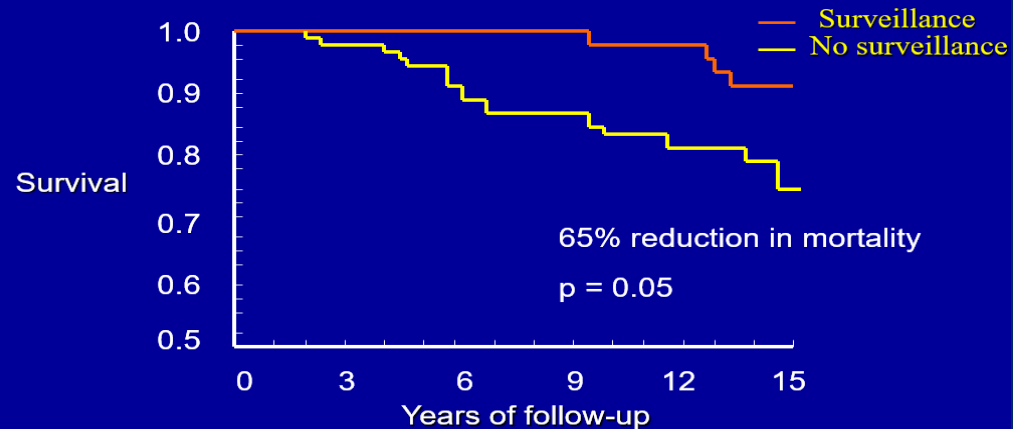

Jarvinen H et al *Gastroenterology* 118:829, 2000

## Colon Polyposis Syndromes

- **Familial Adenomatous Polyposis (FAP)**
  - Hundreds of polyps, earlier age of onset
  - ~20% de novo rate
  - Gardner and Turcot variants
  - *APC* gene
  - AD inheritance
- **Attenuated FAP (AFAP)**
  - 10 or more polyps, later age of onset
  - *APC* gene
  - AD inheritance
- **MYH-associated Polyposis (MAP)**
  - 10 or more polyps
  - *MYH* gene
  - Autosomal recessive!

# Hereditary Cancer Syndromes

## FAP

- Mutation in APC gene (a tumor suppressor)
- autosomal dominant (AD), nearly 100% penetrant
- 20-25 % new mutation rate
- patients develop 100s – 1000s of colon polyps, some of which become malignant

*Also at risk for:*

- CHRPE (Congenital Hypertrophy of the Retinal Pigment Epithelium )
- Epidermoid cysts
- Abnormal dentition
- Desmoid tumors
- Malignant tumors (hepatoblastoma, CNS tumors, thyroid cancer)
- attenuated form (AFAP)  
with typically <100 polyps





# Hereditary Cancer Syndromes

## Some FAP Manifestations Correlate With Specific *APC* Gene Regions

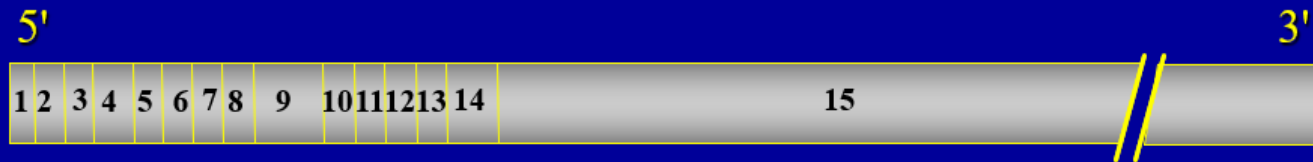

- Attenuated FAP
- Classic FAP
- CHRPE

# Hereditary Cancer Syndromes

## Attenuated FAP

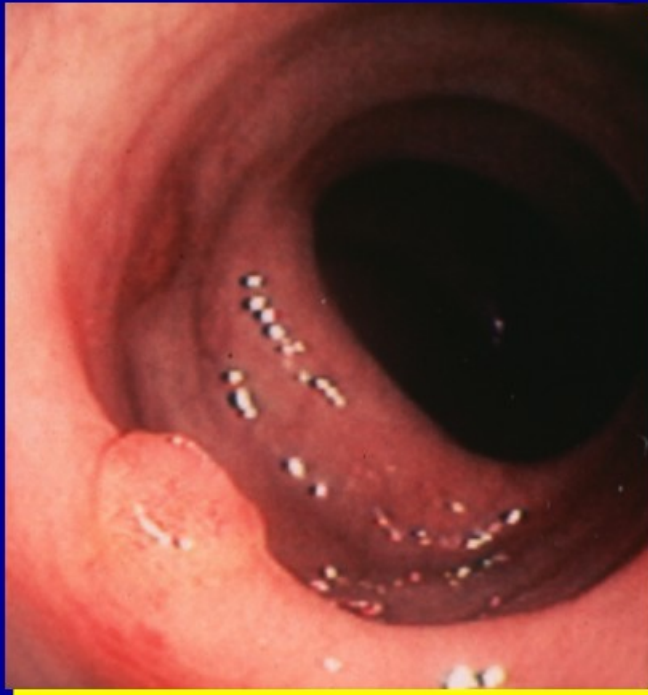

- Later onset (CRC ~age 50)
- Fewer colonic adenomas
- Not associated with CHRPE (congenital hypertrophy of retinal pigment epithelium)
- Upper GIT lesions
- Associated with mutations at 5' and 3' ends of *APC* gene

# Hereditary Cancer Syndromes

## FAP pedigree

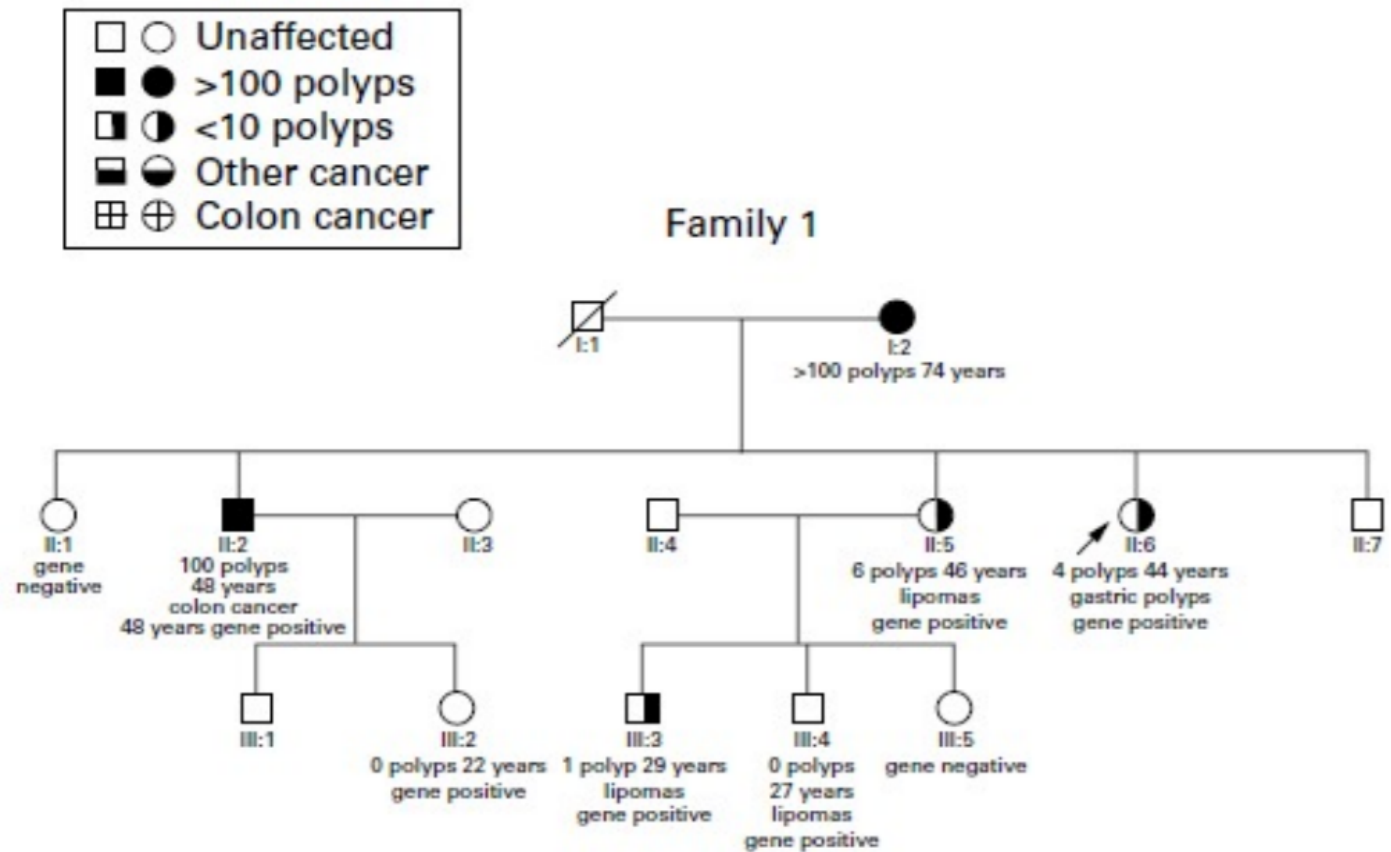



# Hereditary Cancer Syndromes

## Management of Colon Polyposis (FAP/AFAP/

- Increased screening
  - Colorectal, duodenum, stomach, thyroid
  - Hepatoblastoma (<5 years of age)
- Prophylactic surgery
  - Colorectal

# Hereditary Cancer Syndromes

## Multiple Endocrine Neoplasia Type 1

- MEN1
  - Pituitary tumors
  - Parathyroid tumors
  - Endocrine tumors of the gastro-entero-pancreatic tract
    - gastrinoma, insulinoma, glucagonoma
  - 90% symptomatic by mid-20s
  - 10% new mutation rate

### MULTIPLE ENDOCRINE NEOPLASIA TYPE I

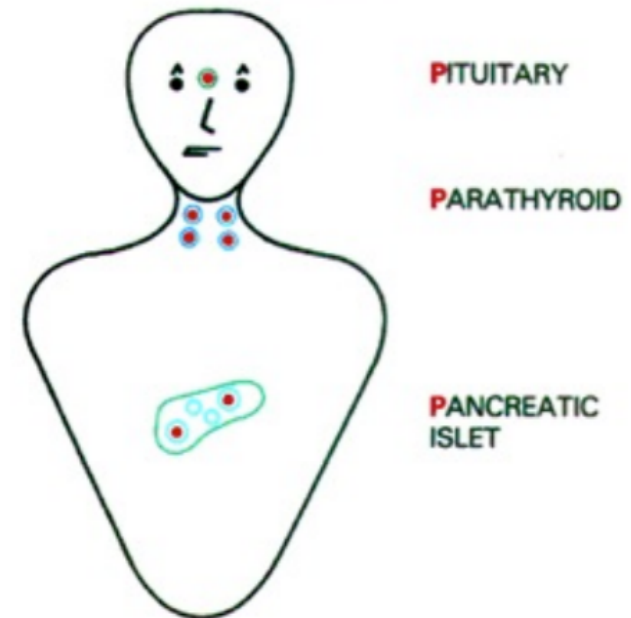

# Hereditary Cancer Syndromes

## Multiple Endocrine Neoplasia Type 2

- **MEN2A**
  - Medullary thyroid cancer -- occur in ~95% of cases
    - Average onset by age 15-20
  - Pheochromocytoma -- occur in ~50% of cases
  - Parathyroid disease -- occur in ~20-30% of cases
- **MEN2B**
  - Medullary thyroid cancer -- occur in 100% of cases
    - Average onset in early-childhood
  - Pheochromocytoma – occur in ~50% of cases
  - Mucosal neuromas
  - Marfanoid body habitus
- **FMTC**
  - Medullary thyroid cancer -- occur in 100% of cases
    - Average onset in middle-adulthood

# Hereditary Cancer Syndromes

## Li-Fraumeni Syndrome

- Initially described by Frederick Li and Joseph Fraumeni as syndrome associated with sarcomas and other diverse tumors.
- Associated cancer include:
  - soft-tissue sarcoma,
  - osteosarcoma,
  - early-onset breast cancer,
  - brain tumors,
  - adrenocortical carcinoma,
  - and leukemias, primarily acute leukemia.
- Inherited in an autosomal dominant manner.
- Gene mutations: *TP53* (tumor suppressor gene)



# Hereditary Cancer Syndromes

## Cowden syndrome

- An autosomal dominantly inherited hamartoma syndrome with an incidence of at least 1/200,000 (probably an underestimate)
- Pathognomonic cutaneous feature is the trichilemmoma, a benign tumor derived from outer-root sheath epithelium of a hair follicle
- Variable expression
- Associated with inherited alterations in the gene, PTEN gene (Tumor suppressor)

### Cancer Risks Associated with Cowden Syndrome:

- Female Breast Cancer 25%-50% lifetime risk (vs ~11% in general pop.)  
Average age of diagnosis may be around age 38-46
- Thyroid Carcinoma: 3%-10% lifetime risk (vs 1% in general population)  
Non-medullary
- Endometrial Cancer 5-10%

# Hereditary Cancer Syndromes

## Cowden syndrome- Mucocutaneous features

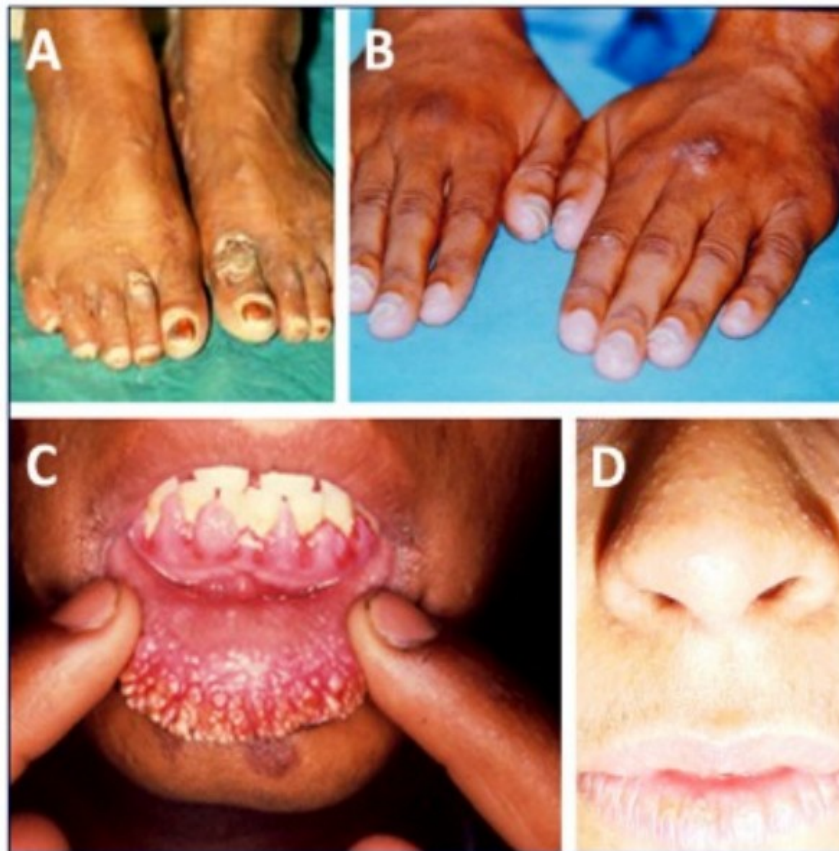

(A) Acral keratotic lesions of the feet (case 1),  
(B) Acral keratotic lesions of the dorsal aspect of hands (case 1),  
(C) Papillomas on hypertrophic gingival mucosa (case 3),  
(D) Pinkish papules of the nose (case 4).

# Hereditary Cancer Syndromes

## Hereditary Diffuse Gastric Cancer(HDGC)

*CDH1 gene* –only gene known to be associated w/ HDGC; however accounts for only 1/3 of hereditary diffuse gastric cancers a poorly differentiated adenocarcinoma that infiltrates into the stomach wall causing thickening of the wall (*linitis plastica*) without forming a distinct mass.

Diffuse gastric cancer is also referred to as signet ring carcinoma or isolated cell-type carcinoma.

*CDH1* mutations confer:

- Increased risk for diffuse gastric cancer
  - 67% lifetime risk for men
  - 83% lifetime risk for women
- Increased risk for lobular breast cancer (39% lifetime risk)
- Majority of cancers diagnosed before age 40



## Peutz-Jeghers Syndrome

### Clinical Features

- Benign growths (polyps) in small intestine (stomach/ bowel)
- Abdominal pain and internal bleeding
- Breast, testicular, pancreatic cancers
- Dark-brown or dark-blue spots on lips, gums, inside mouth, around mouth, eyes, nostrils (mucocutaneous macules)





# Hereditary Cancer Syndromes

## Peutz-Jeghers Syndrome -Diagnosis

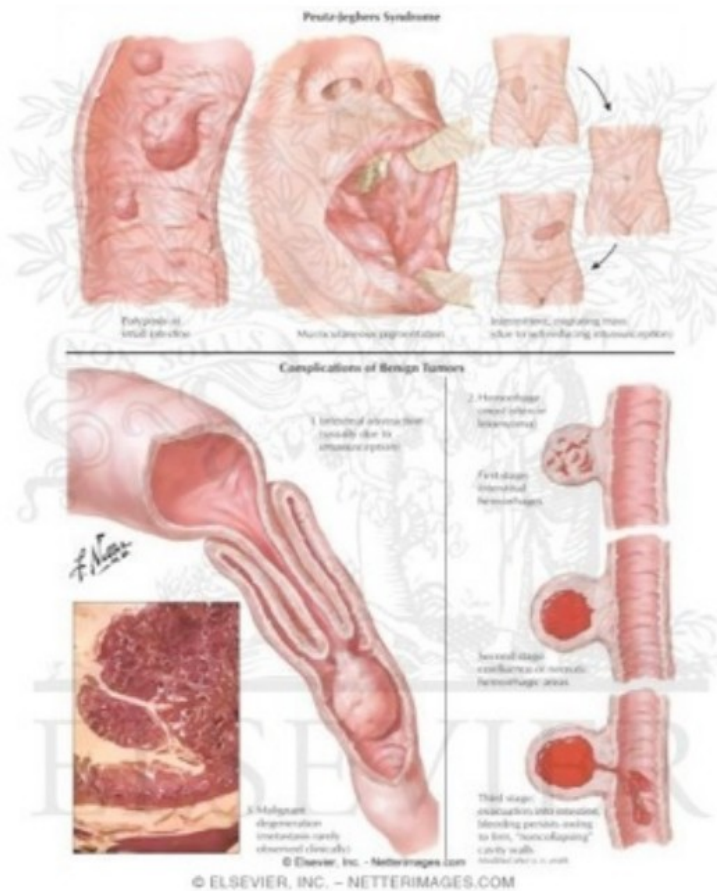

- Gastrointestinal polyps and pigmented spots
- Endoscopy detects polyps
- Polyps have distinct shape and histological composition
- DNA test available for asymptomatic individuals
- In individuals with a clinical diagnosis of PJS, molecular genetic testing of *STK11* (*LKB1*) reveals disease-causing mutations in nearly all individuals who have a positive family history and approximately 90% of individuals who have no family history of PJS.

# Hereditary Cancer Syndromes

**THANK YOU**