

MÁME ZDE KRYCHLE SLOŽENÉ Z MENŠÍCH KRYCHLIČEK. KRYCHLIČKY OZNAČENÉ X ODEBEREME. VYTÁHNI SILNĚ (A DOPLŇ!), CO Z KRYCHLI ZBUDE!

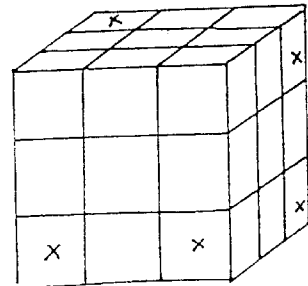

KRYCHLE SLOŽENÉ Z MALÝCH KRYCHLIČEK JSOU "PROVRTANÉ" VŽDY SKRZ NASRZD (X) VYTÁHŇTE SILNĚ, CO ZBUDE. VÍTE, KOLIK KRYCHLIČEK BYLO ODSTRANĚNO?

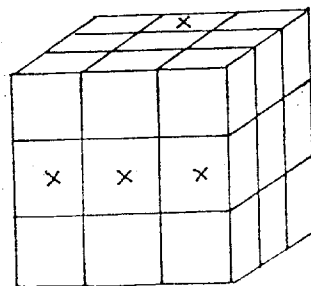
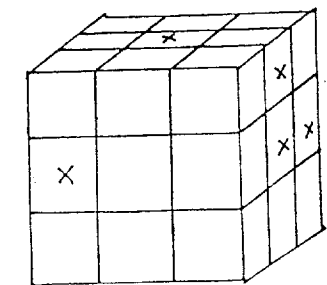
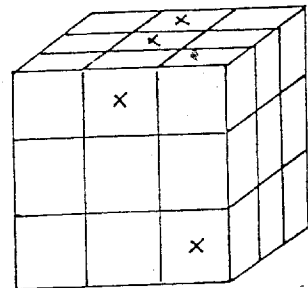
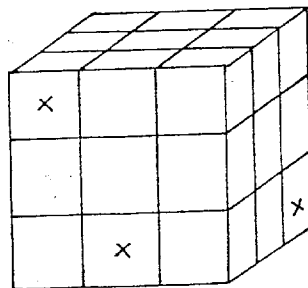
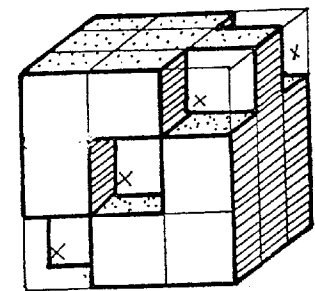
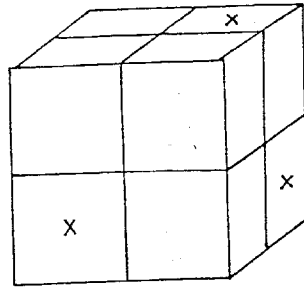
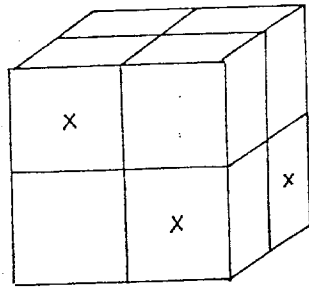
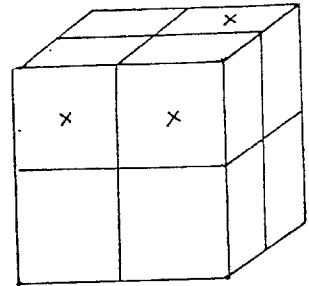
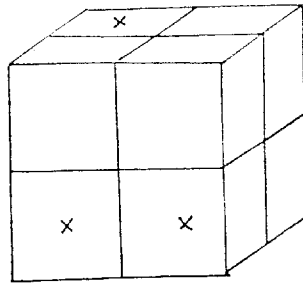
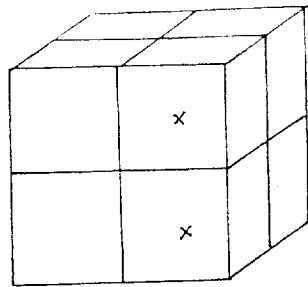
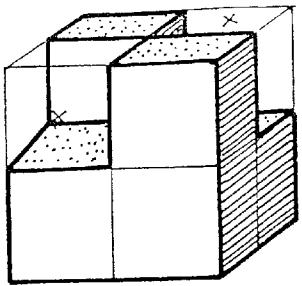
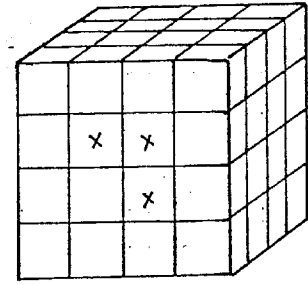
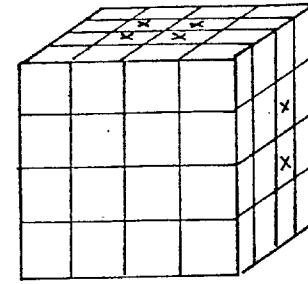
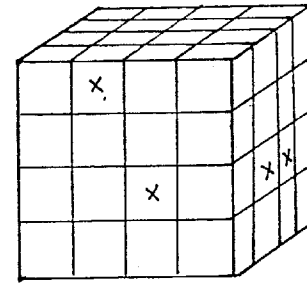
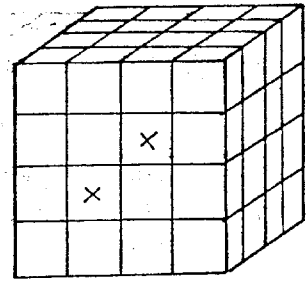
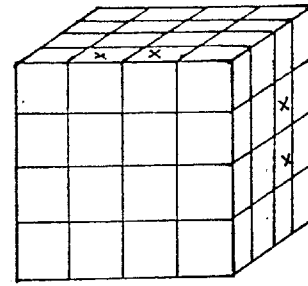
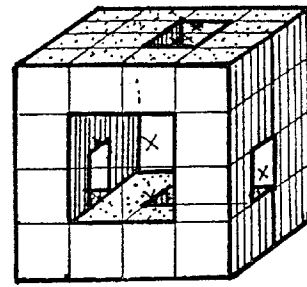

Z DALŠÍCH KRYCHLI JSOU ODSTRANĚNY POUZE MALÉ KRYCHLIČKY OZNAČENÉ X. VYTÁHŇTE SILNĚ TĚLESA, KTERÁ PO ODSTRANĚNÍ KRYCHLIČEK ZBUDE. VYBARVĚTE!

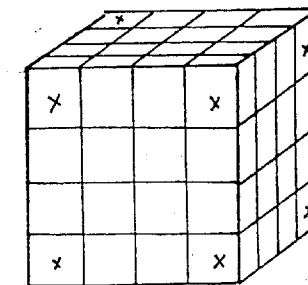
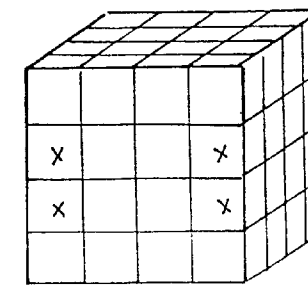
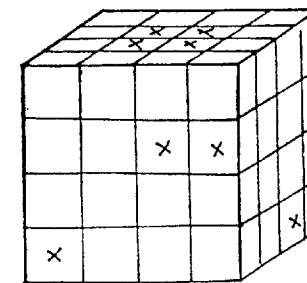
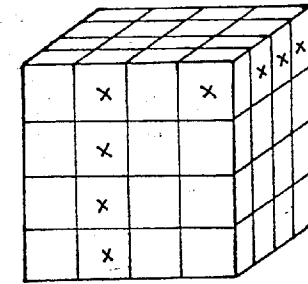
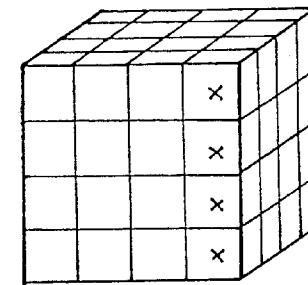
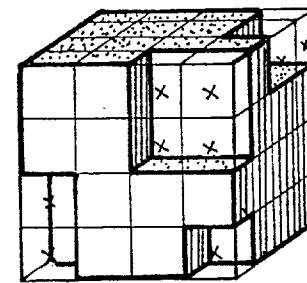

URČI PLOŠU A OBJEM TĚCHTO TĚLES!

OMĚLI BYSTE URČIT PLOŠU TĚCHTO TĚLES?

C-J

DO DRÁTĚNÉ KRYCHLE ABCD EFGH JE UHÍSTĚN NEPRŮHLEDNÝ TROJÚHELNÍK ZAKRESLI KRYCHLI S TROJÚHELNÍKEM I V PŮDŮČENÍ (NEJDRÍV DOPLNĚ VRCHOLY!)

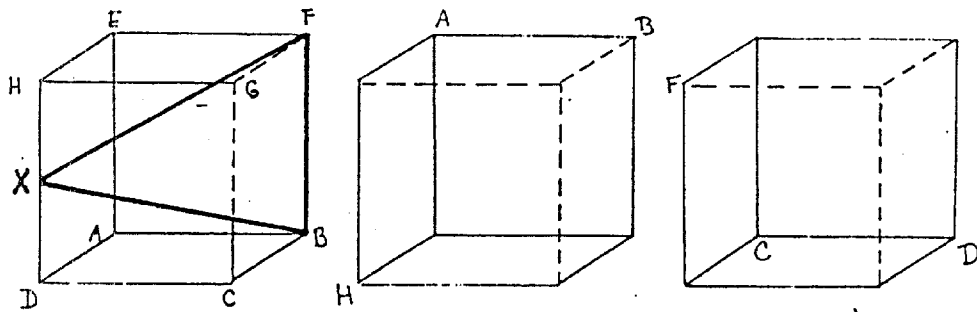
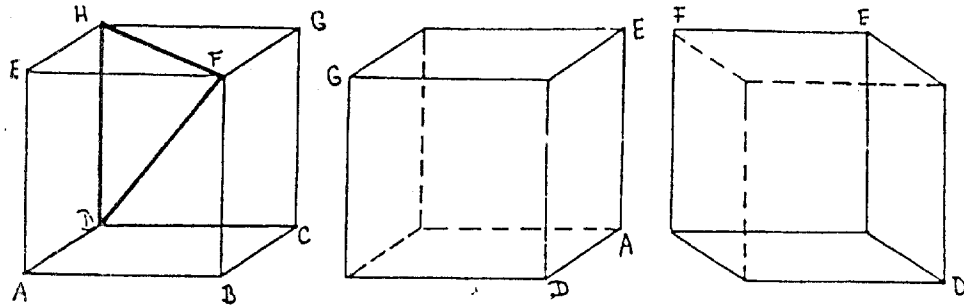

✓ KRYCHLI JSOU DVA NEPRŮHLEDNÉ TROJÚHELNÍKY. ZAKRESLI V PŮDŮČENÍ!

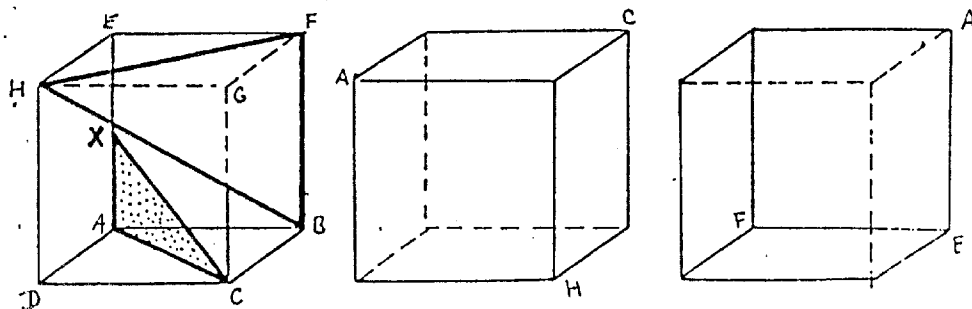
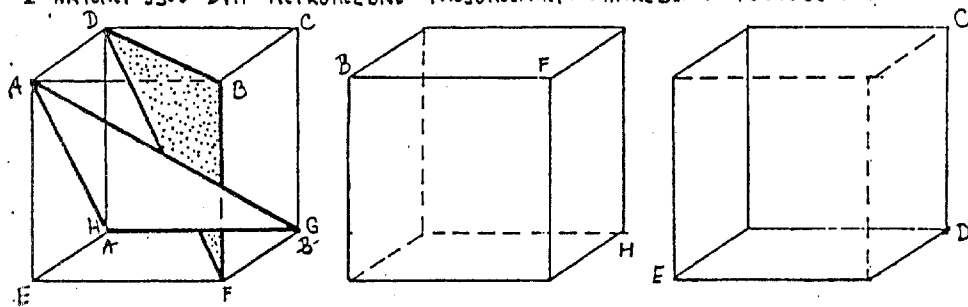

URČI, KTERÉ STRANY TROJÚHELNÍKŮ  $\triangle ACX$ ,  $\triangle BFH$  NEBO  $\triangle AHG$  A  $\triangle BDF$  JSOU RŮVNŮBĚŽNÉ, ROVNOBĚŽNÉ NEBO MIMOPARALÉLNÉ!

V DRÁTĚNÉ KRYCHLI JE UHÍSTĚN NEPRŮHLEDNÝ ČTYRÚHELNÍK. ZAKRESLI HO V PŮDŮČENÍ - NYCH POLOHÁCH NA SOUSEDNÍCH KRYCHLÍCH.

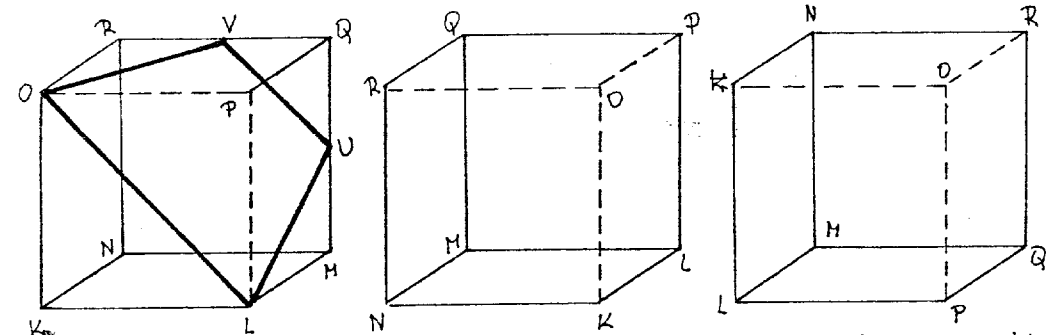
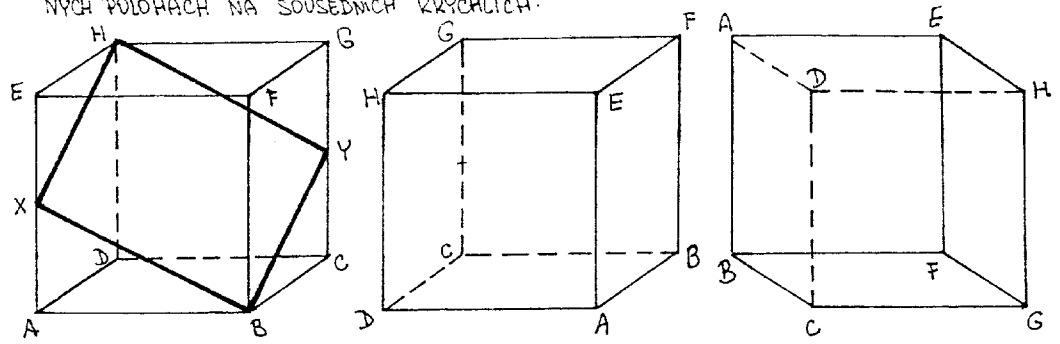

KRYCHLE JE SEŘÍZNUTA ROVINOU. ZAKRESLI ZBYTEK KRYCHLE SILNĚ - V PŮDŮČENÍ!

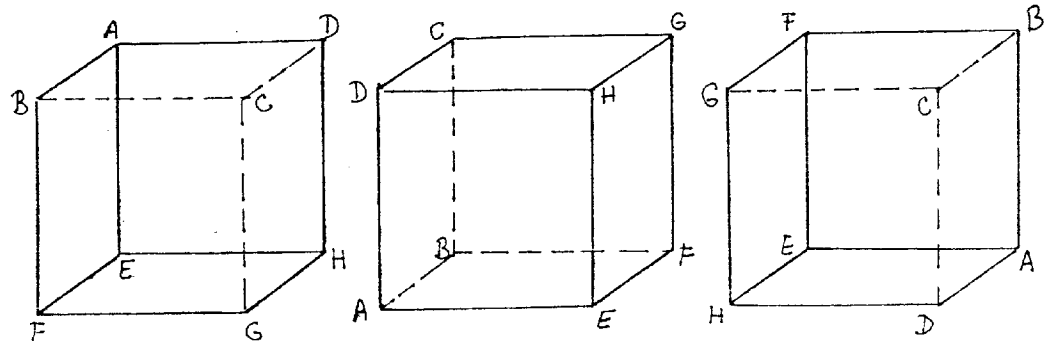
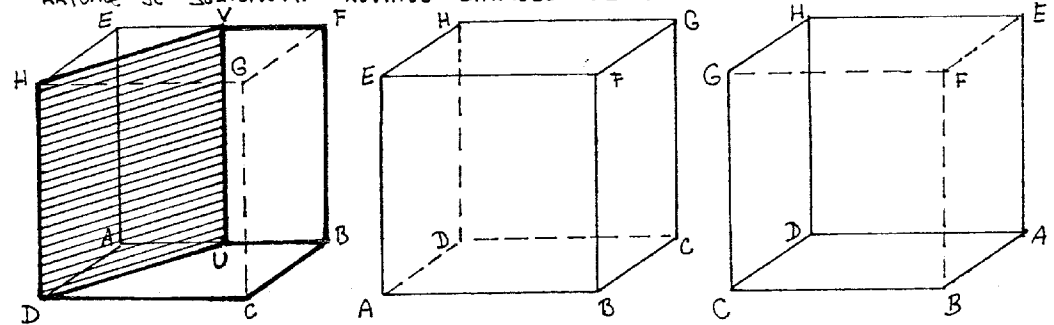

Příklad

K danému tělesu sestrojte jednotlivé pohledy.

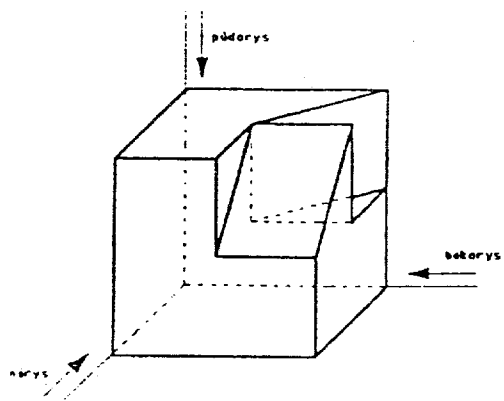

Řešení:

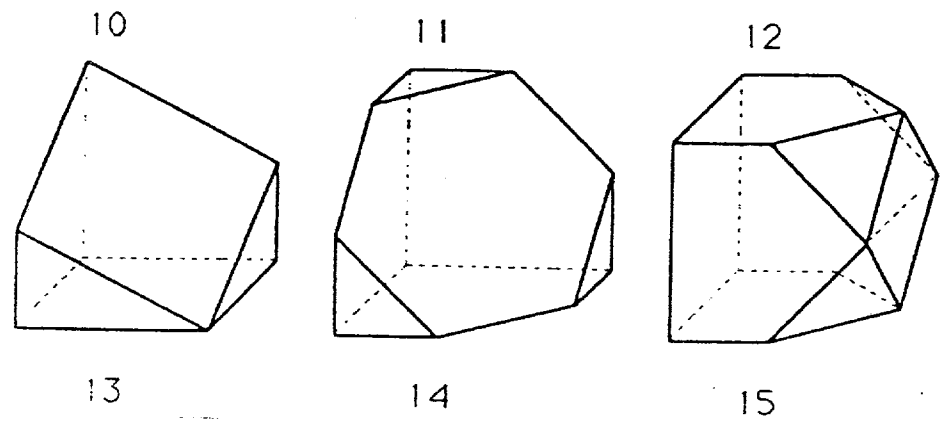
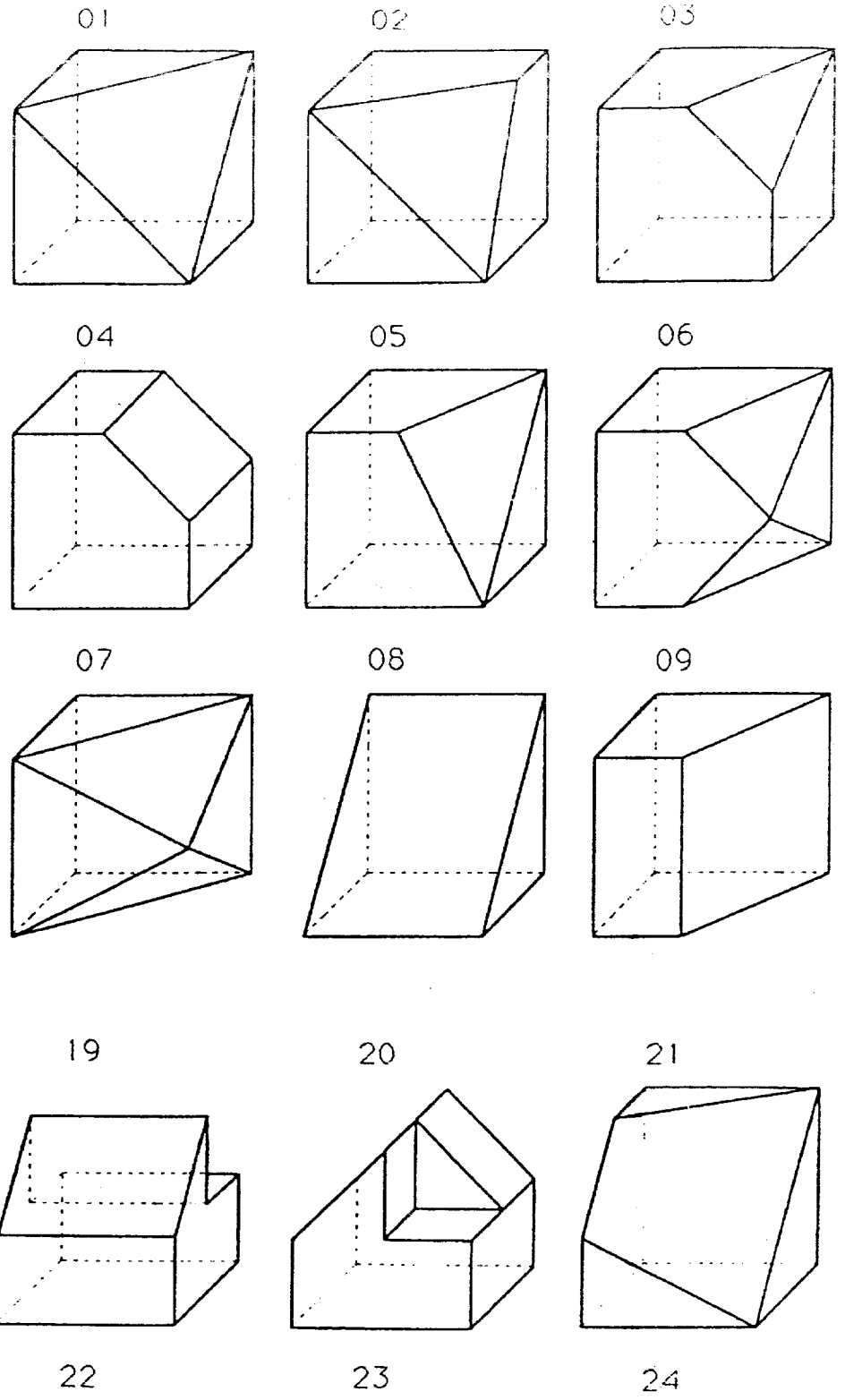
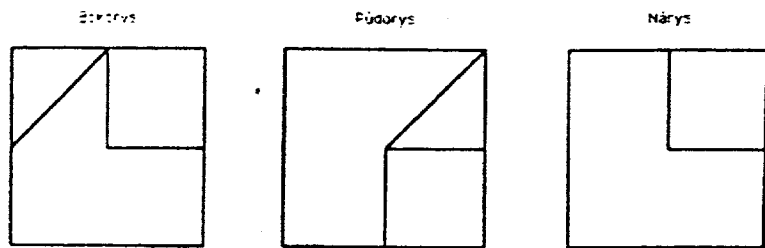

26 Bokarys

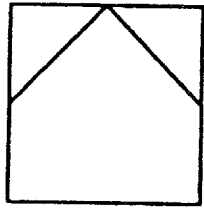

Püöröys

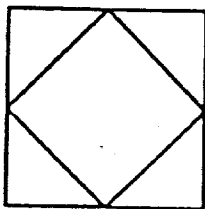

Närys

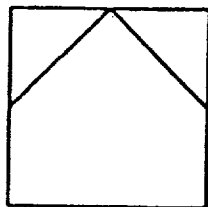

27 Bokarys

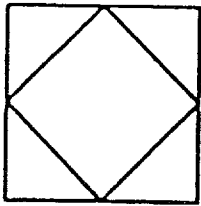

Püöröys

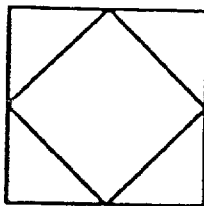

Närys

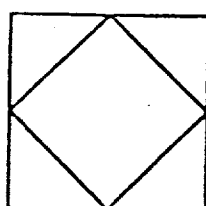

28 Bokarys

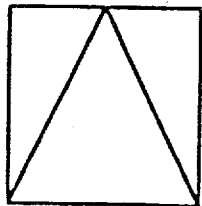

Püöröys

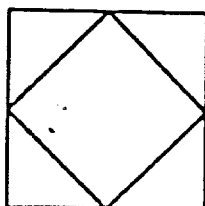

Närys

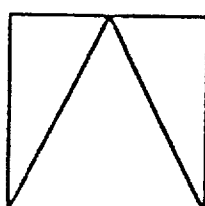

29 Bokarys

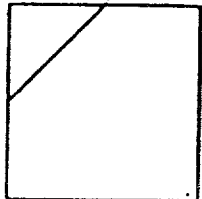

Püöröys

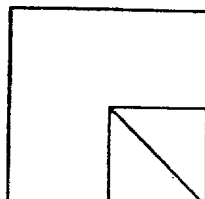

Närys

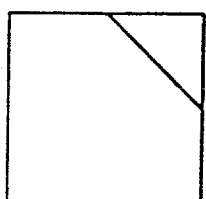

30 Bokarys

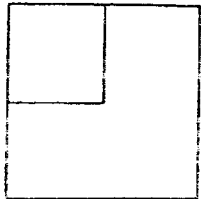

Püöröys

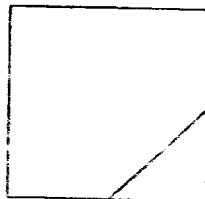

Närys

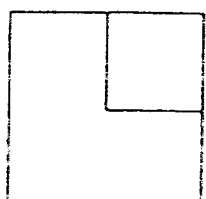

36 Bokarys

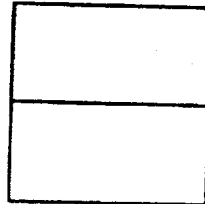

Püöröys

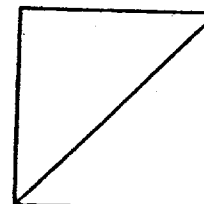

Närys

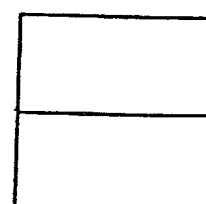

37 Bokarys

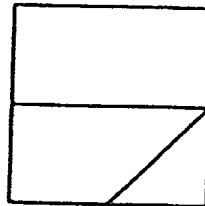

Püöröys

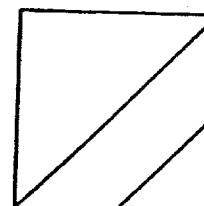

Närys

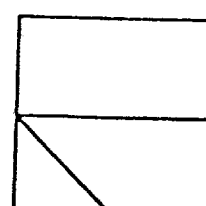

38 Bokarys

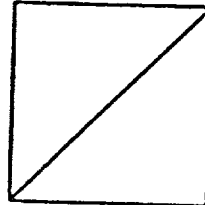

Püöröys

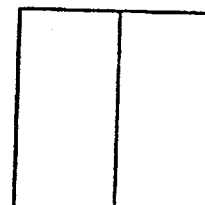

Närys

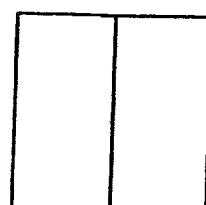

39 Bokarys

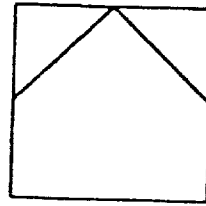

Püöröys

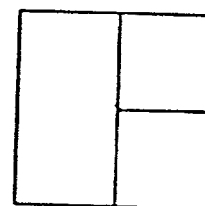

Närys

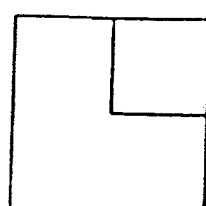

40 Bokarys

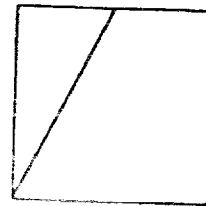

Püöröys

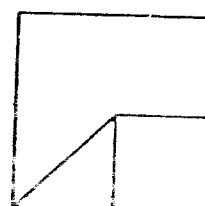

Närys

