

KRYSTALICKÁ STAVBA LÁTEK (KOVŮ)

Základy krystalografie

Vazba mezi atomy

Molekuly a krystaly pevných látek tvořeny atomy. Typ vazby mezi atomy určen způsobem jakým jsou k sobě atomy poutány (valenční síly):

- Iontová vazba (atomy s výraznou elektronegativitou).
- Kovalentní vazba (překryv valenčních orbitálů – vznik elektronového páru).

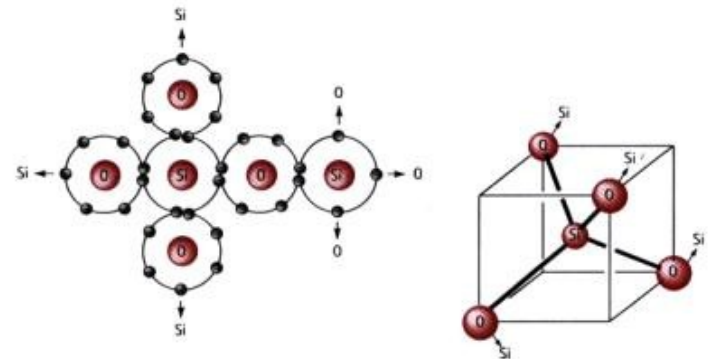
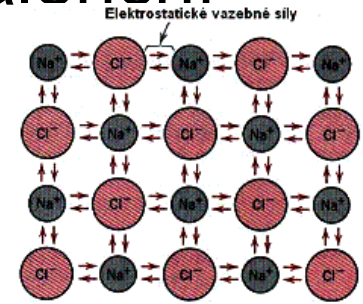

Vazba mezi atomy

- Vazba Van der Waalsova.
- Kovová vazba (klad. ionty+elektronový plyn).

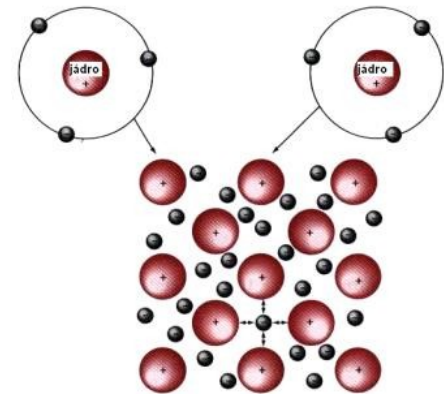
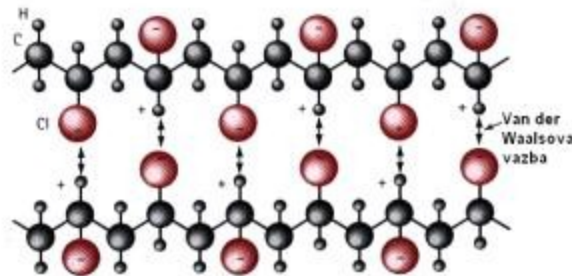
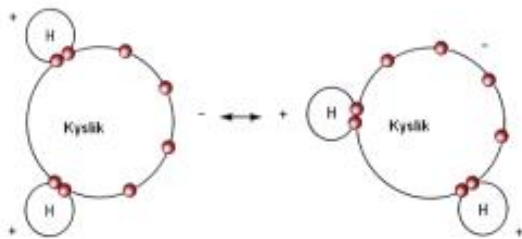

Uspořádání hmoty v prostoru

Skupenství: pevné, plynné, kapalné.

Z hlediska uspořádanosti:

- neuspořádané,
- uspořádané na krátkou vzdálenost,
- uspořádané na velkou vzdálenost
(krystalová mřížka).

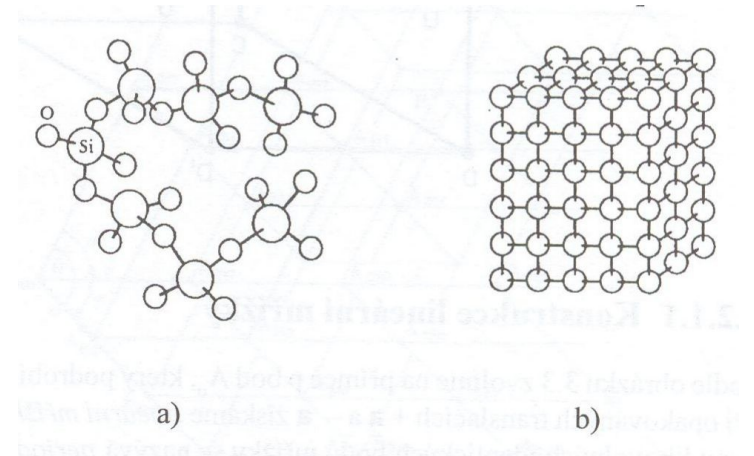

IA										IIA										IIIB										IVB										VB										VIB										VIIB										VIII										IB										IIB										IIIA										IVA										VA										VIA										VIIA										VIII A									
1 1.008 H Hydrogen																				2 4.003 He Helium																																																																																																																																											
3 6.941 Li Lithium	4 9.012 Be Beryllium																				10 20.180 Ne Neon																																																																																																																																										
11 22.990 Na Sodium	12 24.305 Mg Magnesium																				17 35.453 Cl Chlorine																																																																																																																																										
19 39.098 K Potassium	20 40.06 Ca Calcium	21 44.956 Sc Scandium	22 47.88 Ti Titanium	23 50.942 V Vanadium	24 51.996 Cr Chromium	25 54.938 Mn Manganese	26 55.847 Fe Iron	27 58.933 Co Cobalt	28 58.70 Ni Nickel	29 63.546 Cu Copper	30 65.39 Zn Zinc	31 69.72 Ga Gallium	32 72.61 Ge Germanium	33 74.922 As Arsenic	34 78.96 Se Selenium	35 79.904 Br Bromine	36 83.80 Kr Krypton																																																																																																																																														
37 85.468 Rb Rubidium	38 87.62 Sr Strontium	39 88.906 Y Yttrium	40 91.22 Zr Zirconium	41 92.906 Nb Niobium	42 95.94 Mo Molybdenum	43 98.906 Tc Technetium	44 101.07 Ru Ruthenium	45 102.906 Rh Rhodium	46 106.42 Pd Palladium	47 107.868 Ag Silver	48 112.41 Cd Cadmium	49 114.82 In Indium	50 118.71 Sn Tin	51 121.76 Sb Antimony	52 127.60 Te Tellurium	53 126.905 I Iodine	54 131.29 Xe Xenon																																																																																																																																														
55 132.905 Cs Cesium	56 137.33 Ba Barium	57 138.906 La Lanthanum	72 178.48 Hf Hafnium	73 180.948 Ta Tantalum	74 183.85 W Tungsten	75 186.207 Re Rhenium	76 190.2 Os Osmium	77 192.22 Ir Iridium	78 195.08 Pt Platinum	79 196.967 Au Gold	80 200.59 Hg Mercury	81 204.38 Tl Thallium	82 207.2 Pb Lead	83 208.980 Bi Bismuth	84 (209) Po Polonium	85 (210) At Astatine	86 (222) Rn Radon																																																																																																																																														
87 (223) Fr Francium	88 226.025 Ra Radium	89 227.028 Ac Actinium																																																																																																																																																													

	meters	dm	cm	mm	µm	nm	Å
1Å =	10 ⁻¹⁰	10 ⁻⁹	10 ⁻⁸	10 ⁻⁷	10 ⁻⁶	10 ⁻⁵	1
1mm =	10 ⁻³	10 ⁻²	10 ⁻¹	1	10 ³	10 ⁶	10 ⁹
1µm =	10 ⁻⁶	10 ⁻⁵	10 ⁻⁴	10 ⁻³	1	10 ³	10 ⁶
1cm =	10 ⁻²	10 ⁻¹	1	10	10 ⁴	10 ⁷	10 ¹⁰
1dm =	10 ⁻¹	1	10	10 ²	10 ⁵	10 ⁸	10 ¹¹
1m =	1	10	10 ²	10 ³	10 ⁶	10 ⁹	10 ¹⁰

Crystal Structures

- Cubic, face centered
- Cubic, body centered
- Cubic
- Hexagonal
- Monoclinic
- Orthorhombic
- Tetragonal
- Rhombohedral



Atomic Number
Atomic Weight
Symbol
K Energy (-)
L Energy (-)
M Energy (-)

Alkal Earth
Alkaline Earth
Rare Earth
Other Metals
Non-Metals
Halogens
Transition Metals
Metalloids
Noble Gases

58 140.12 Ce Cerium	59 140.908 Pr Praseodymium	60 144.24 Nd Neodymium	61 (145) Pm Promethium	62 150.36 Sm Samarium	63 151.97 Eu Europium	64 157.25 Gd Gadolinium	65 158.925 Tb Terbium	66 162.50 Dy Dysprosium	67 164.930 Ho Holmium	68 167.26 Er Erbium	69 168.934 Tm Thulium	70 173.04 Yb Ytterbium	71 174.967 Lu Lutetium
90 232.038 Th Thorium	91 231.036 Pa Protactinium	92 238.029 U Uranium	93 237.048 Np Neptunium	94 244 Pu Plutonium	95 (243) Am Americium	96 (247) Cm Curium	97 (247) Bk Berkelium	98 (251) Cf Californium	99 (252) Es Einsteinium	100 (257) Fm Fermium	101 (258) Md Mendelevium	102 (259) No Nobelium	103 (260) Lr Lawrencium

Základy krystalografie

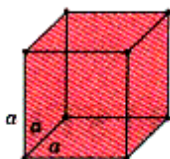
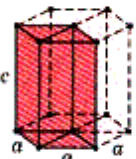
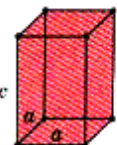
7 krystalografických soustav

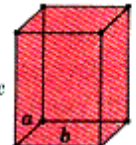
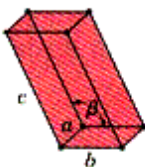
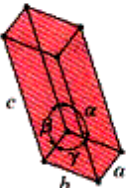
Soustava	Úseky na osách	Úhly	Elementární buňka
Kubická (krychlová) prostá, prostorově a plošně centrovaná.	$a = b = c$	$\alpha = \beta = \gamma = 90^\circ$	
Šesterečná (hexagonální), prostá	$a = b \neq c$	$\alpha = \beta = 90^\circ, \gamma = 120^\circ$	
Čtverečná (tetragonální), prostá a prostorově centrovaná	$a = b \neq c$	$\alpha = \beta = \gamma = 90^\circ$	
Trigonální - klencová (romboedrická), prostá	$a = b = c$	$\alpha = \beta = \gamma \neq 90^\circ$	
Kosočtverečná (ortorombická), prostá, bazálně, plošně i prostorově centrovaná.	$a \neq b \neq c$	$\alpha = \beta = \gamma = 90^\circ$	
Jednoklonná (monoklinická), prostá a bazálně centrovaná	$a \neq b \neq c$	$\alpha = \gamma = 90^\circ \neq \beta$	
Trojklonná (triklinická), prostá	$a \neq b \neq c$	$\alpha \neq \beta \neq \gamma \neq 90^\circ$	

Základy krystalografie

14 Bravaisových mřížek.

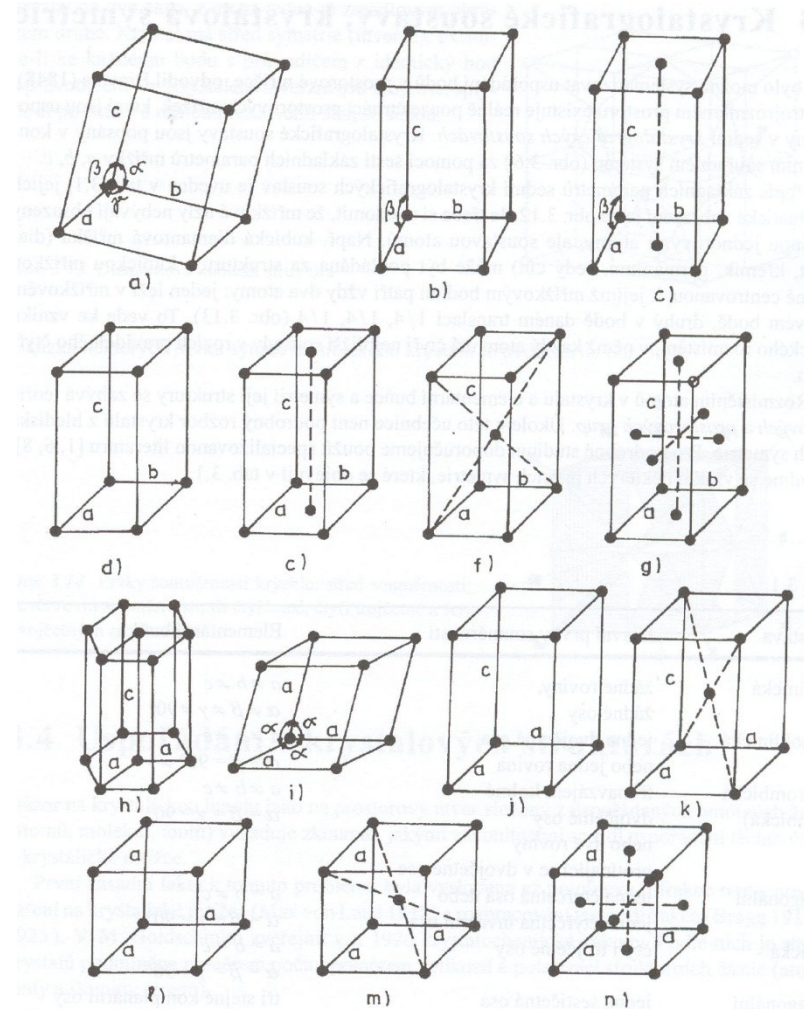
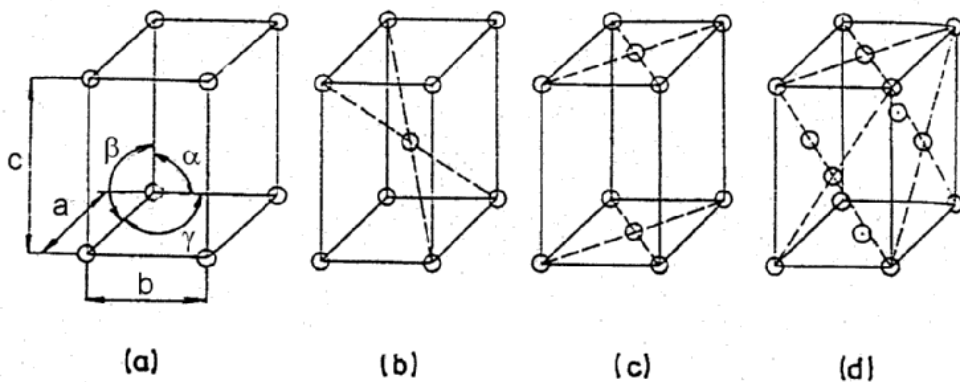

Základní typy kovových struktur

Většina kovů a jejich slitin krystalizuje:

- Krychlová plošně centrovaná mřížka FCC (face centred cubic).
- Krychlová prostorově centrovaná mřížka BCC (body centred cubic).
- Hexagonální těsně uspořádaná mřížka HCP (hexagonal close packed).

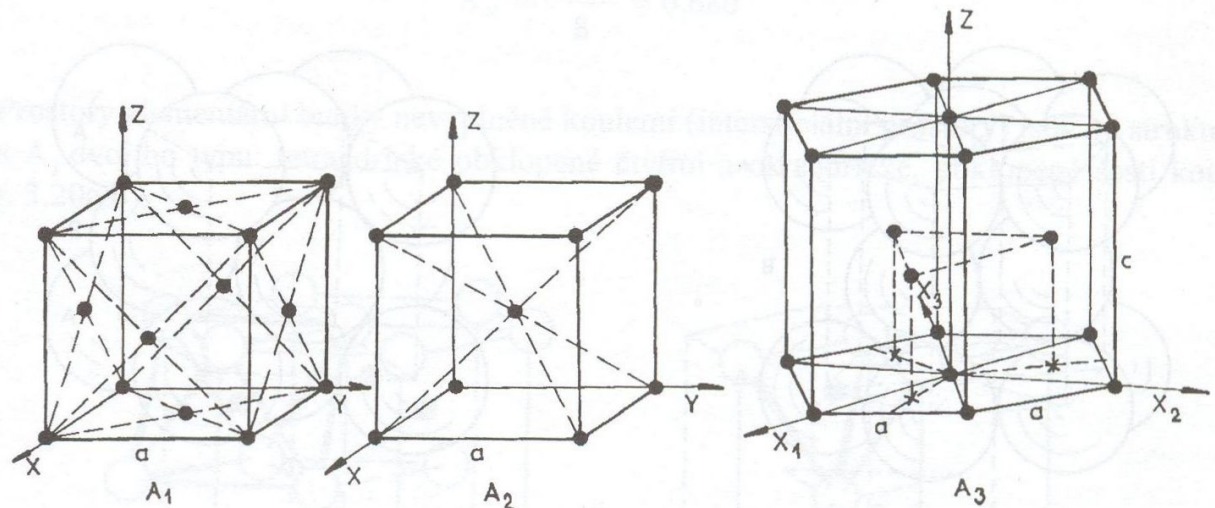

Základní typy kovových struktur

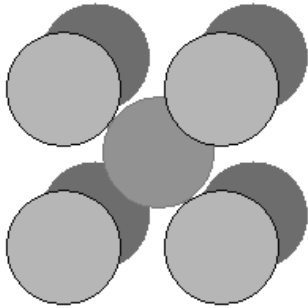

BCC

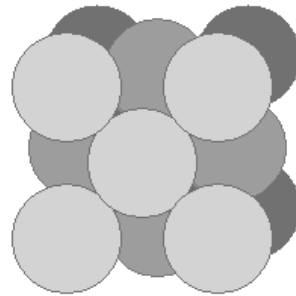

FCC

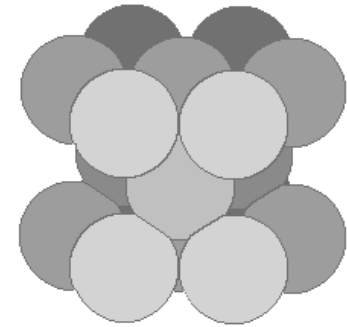

HCP

I přes výrazné zaplnění prostoru atomy zůstávají v mřížce volná místa – tzv. intersticiální dutiny.

Poruchy krystalické mřížky

V ideálním krystalu jsou všechny uzlové body obsazeny atomy.

Vady v krystalech:

- bodové vady,
- čárové vady,
- plošné vady,
- prostorové vady.

Bodové poruchy

Poruchy v čistých kovech:

- vakance,
- intersticiály.

V tuhých roztocích navíc:

- substituční a
- intersticiální příměsi.

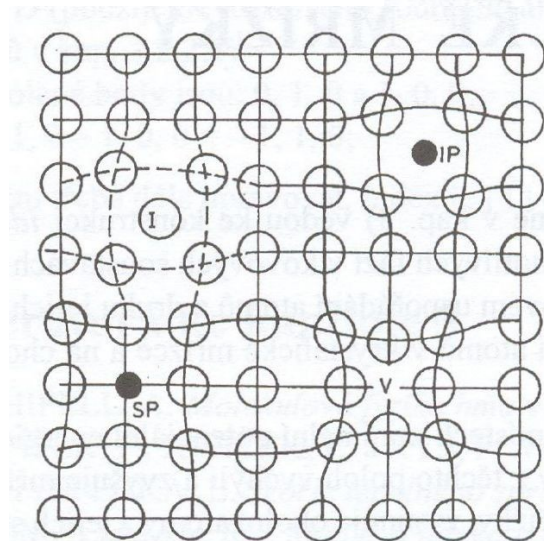
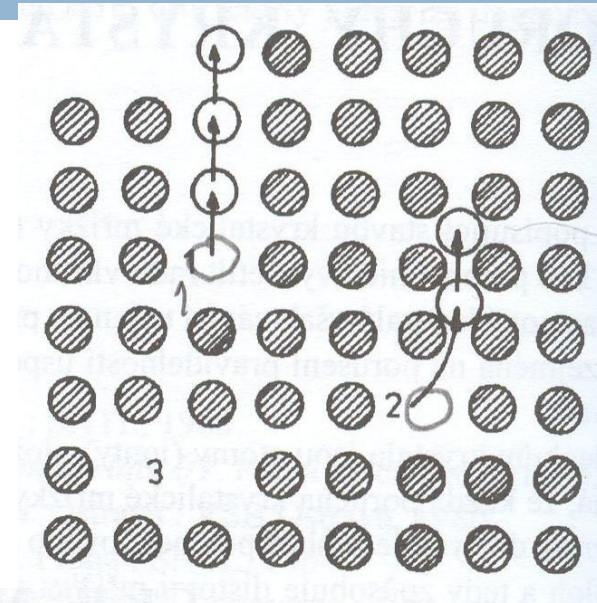

Čárové a hranové poruchy

Vznikají přesunutím (dislokováním) určitého množství atomů při skluzovém pohybu.

Dislokace:

- hranové,
- šroubové.

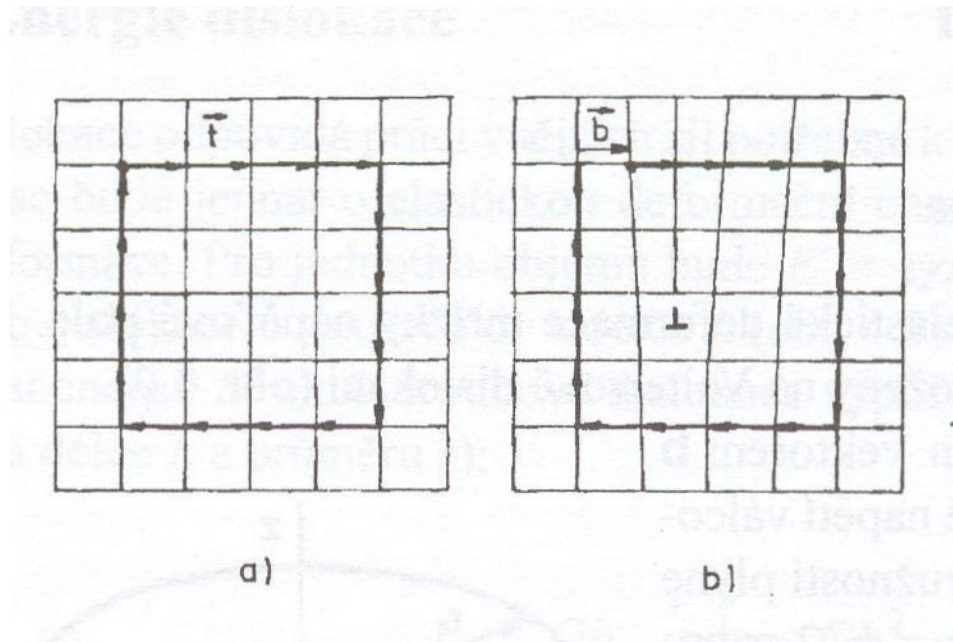

b - Burgersův vektor udává charakter dislokace.

Závěr

Literatura:

- [1] Askeland, D.R. *The Science and Engineering of Materials*. Chapman & Hall, 1996.
- [2] Ptáček a kol. *Nauka o materiálu I a II*. CERM, 2003, 520+396 s.
- [3] Hluchý, M., Kolouch, J. *Strojírenská technologie 1*. Scientia, 2007, 266 s.

