

Proteiny

Mléčné proteiny

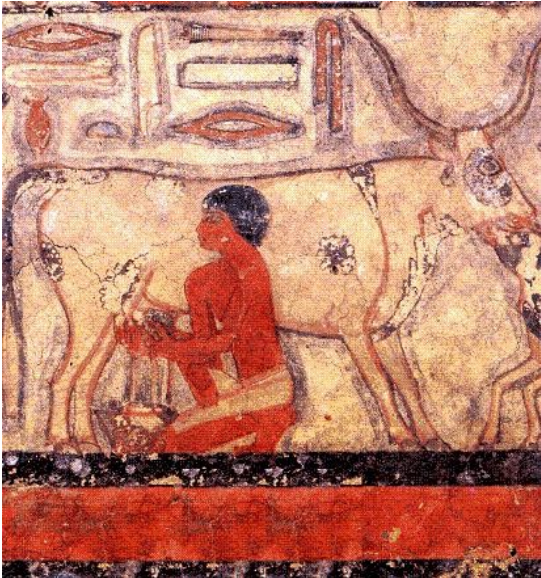

Table 7.4 Amino acid composition of milk proteins

<i>Amino acid</i>	<i>Lactalbumin</i>	<i>β-Lactoglobulin</i>	<i>α</i>	<i>Caseins β</i>	<i>γ</i>
Glycine	2.9	3.1	2.5	2.2	1.4
Alanine	1.9	1.8	3.3	1.5	2.1
Valine	4.2	4.1	5.7	9.0	9.5
Leucine	10.4	9.2	7.1	10.2	10.8
Isoleucine	6.1	6.4	5.8	4.9	4.0
Proline	1.4	1.6	7.4	14.1	15.3
Phenylalanine	4.0	4.8	4.2	5.1	5.2
Tyrosine	4.8	4.5	7.3	2.8	3.3
Tryptophan	6.3	6.6	1.4	0.6	1.1
Serine	4.3	4.1	5.7	6.0	5.0
Threonine	5.0	4.9	4.4	4.5	4.0
Cystine	5.8	5.7	0.4	0.0	0.0
Methionine	0.9	0.8	2.3	3.0	3.7
Arginine	1.0	1.4	3.9	3.0	1.7
Histidine	2.6	3.0	2.6	2.7	3.3
Lysine	10.4	9.6	8.0	5.7	5.6
Aspartic	16.8	17.1	7.6	4.3	3.6
Glutamic acid	11.6	11.4	20.3	20.4	20.6

Results are taken from Gordon and Ziegler³⁵, Block and Weiss³⁸, Gordon *et al.*³⁷ and Gordon *et al.*³⁸ and are converted to weight per cent of total.



Kasein a kaseináty

Vysoký obsah fosforu (cca 1 %; fosforečná kyselina esterifikuje hydroxylové skupiny serinu a částečně též glutamové kyseliny)



Casein Micelle

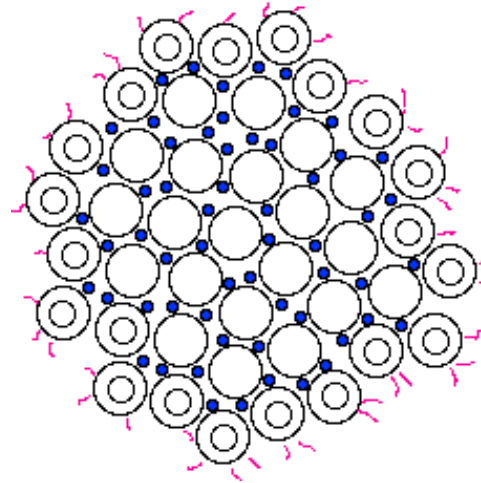

Casein Submicelle

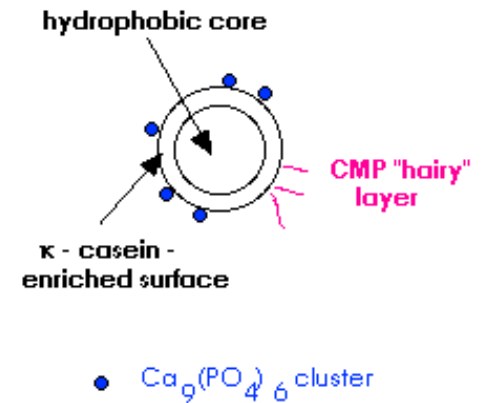

Důkaz kaseinu v keramice

konzumace
mléka

druhová
příslušnost

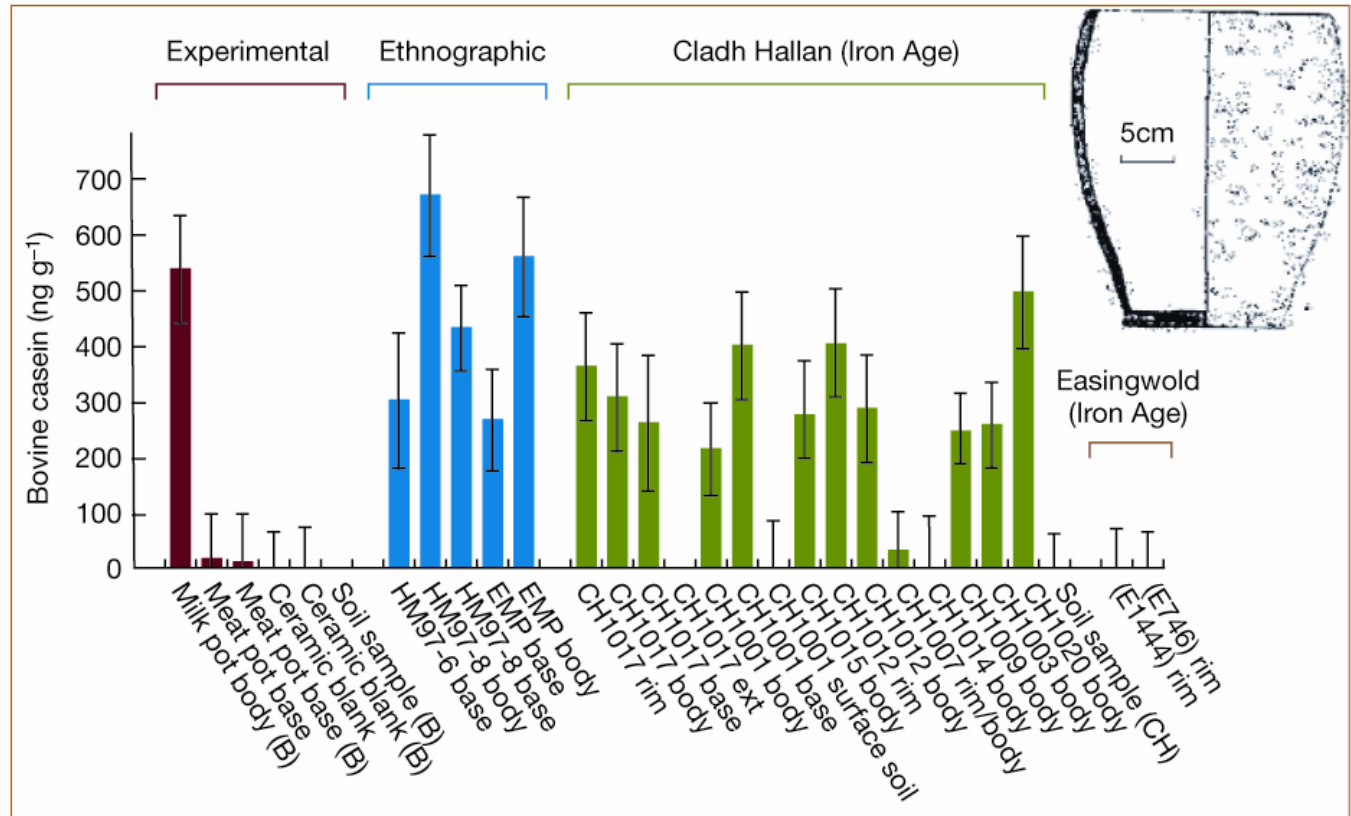

Figure 1 Amounts of bovine α -casein present in samples of pottery and soil, as determined by duplicate assay using digestion-and-capture immunoassay with a monoclonal antibody raised against this protein. Error bars, one standard deviation. The assay is specific only for cows' milk and is able to detect as little as 100 ng protein per g of ceramic (0.1 p.p.m.). Experimental coarseware pots (ceramic 'blank') were used to boil either milk (milk pot) or beef (meat pot) repeatedly and were buried for 1 year in upland soil. Ethnographic pots were obtained from Pakistan (HM) and India (EMP); each had been recently used to prepare dairy products. Cladh Hallan (CH) vessels (inset) were collected from a single site (fill of house 112, South Uist, Outer Hebrides). Domestic cooking pots from Easingwold, North Yorkshire (E), contained large amounts of well-preserved animal fats.

Krev

Albumin (druhově specifický)

Glykoproteiny krevních skupin

Štípaná industrie
Kosterní pozůstatky
Sedimenty

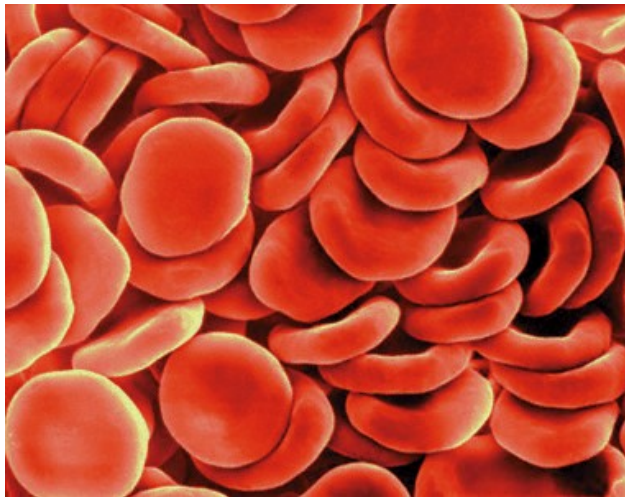

Hemoglobin

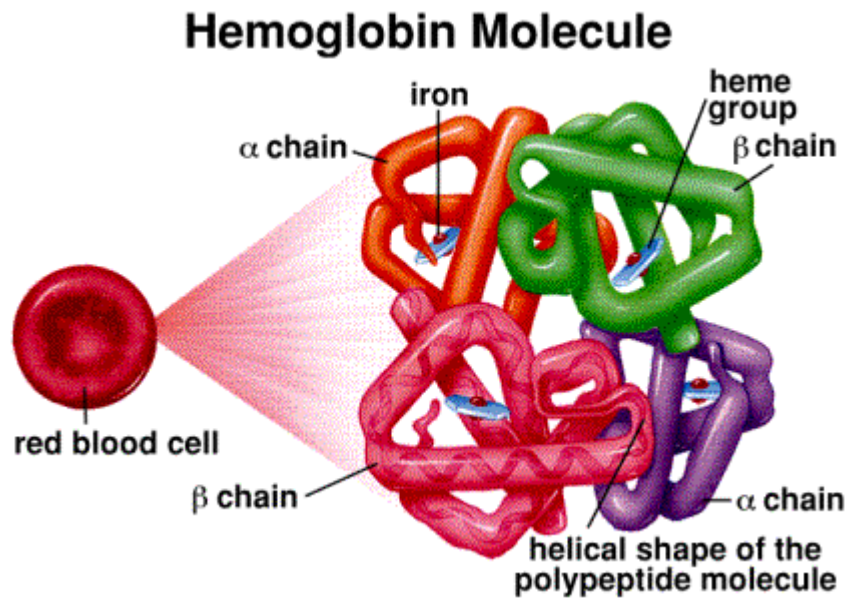

Recentní kultovní sošky z Mali

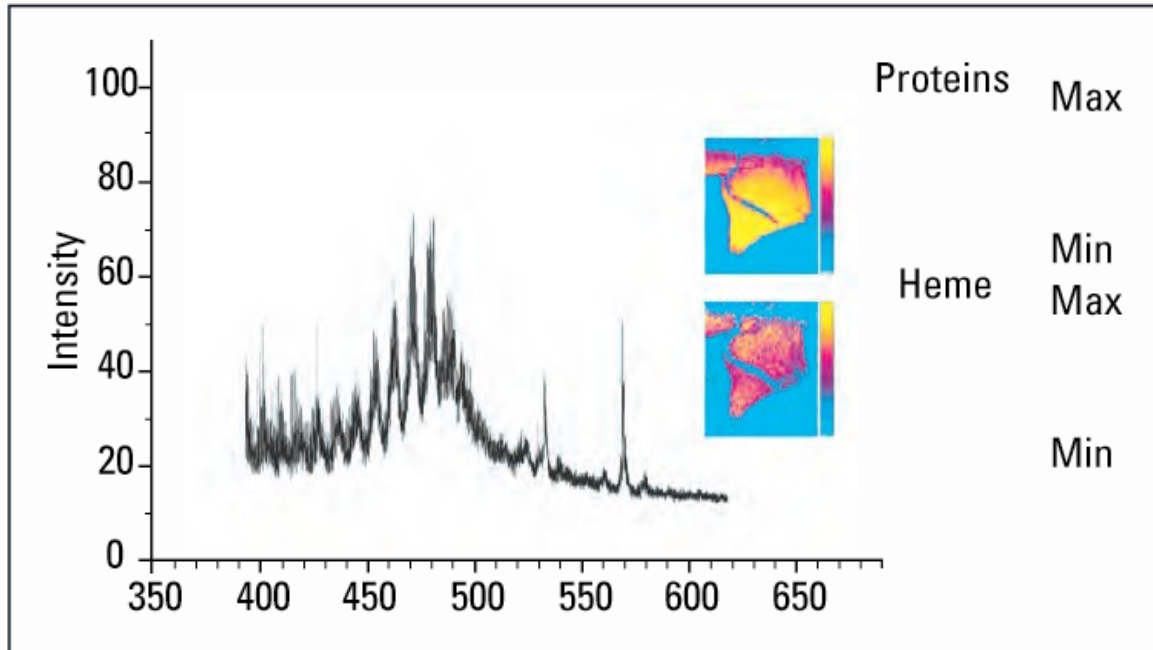









TOF SIMS analysis of an African artifact, highlighting the characteristic m/z 616.2 peak of heme as well as the overlapping spatial distribution of proteins (sum of amino acid fragments) and heme (tripyrrole fragments) on the sample's surface.

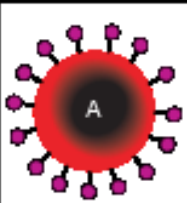
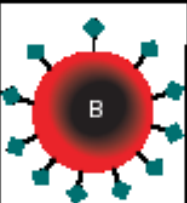
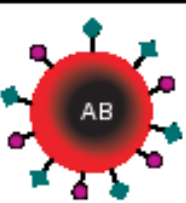

Proteiny krevních skupin

Antropologie: určování příbuzenství mezi jedinci na pohřebištích

Kriminalistika: identifikace osob

	Group A	Group B	Group AB	Group O
Red blood cell type				
Antibodies present	 Anti-B	 Anti-A	None	 Anti-A and Anti-B
Antigens present	 A antigen	 B antigen	 A and B antigens	No antigens



Chemie krevních skupin

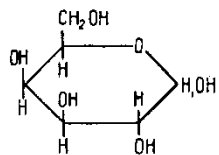
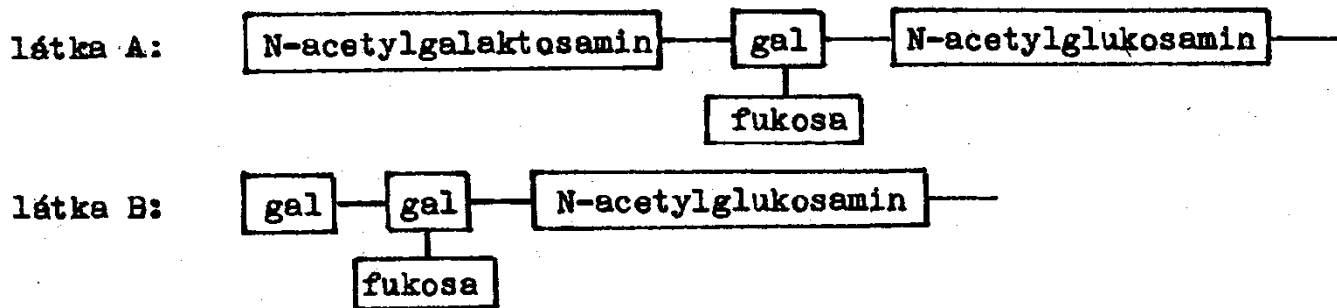

D-Galaktose

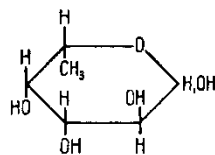

L-Fucose

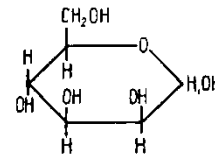

D-Mannose

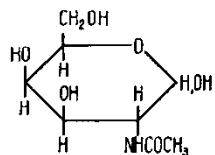

N-Acetyl-D-Galaktosamin

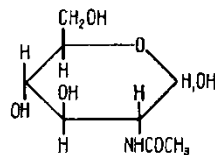

N-Acetyl-D-Glukosamin

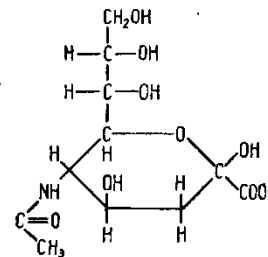

N-Acetyl-Neuraminsäure

Abb. 69. Die wesentlichen Zuckerbausteine von Blutgruppensubstanzen

Albumin

Identifikace druhové příslušnosti kostí a krevních skvrn.

„Molekulární paleontologie“

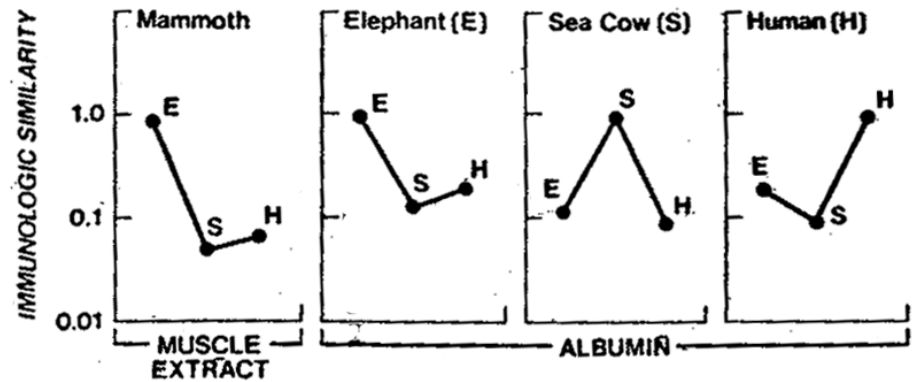
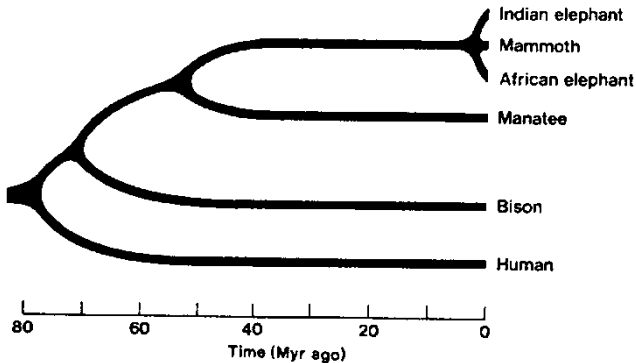
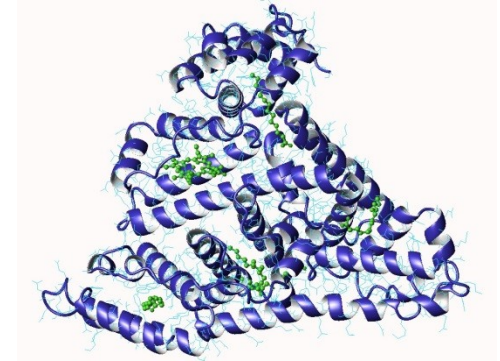
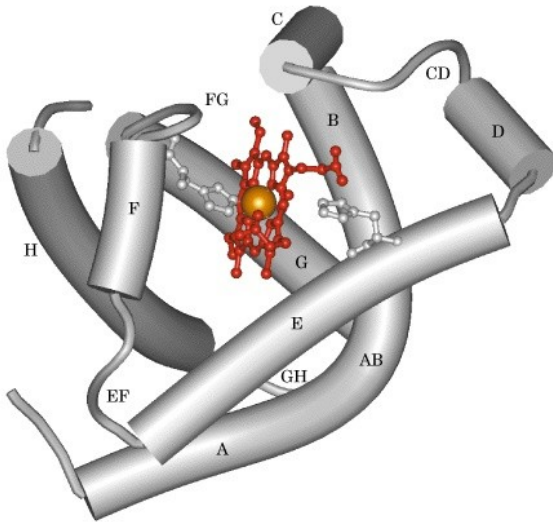

Fig. 4. Extract of mammoth muscle reacts with antisera to albumin like elephant albumin, not like sea cow (manatee) or human albumin. The sea cow is believed to be a very distant relative of the elephant

Nelze ho detekovat ve spálených kostech (teplota nad 300 C)

Myoglobin

Vyskytuje se pouze v příčně pruhované a srdeční svalové tkáni.



Sval

Obsah myoglobinu (mg/g
čerstvé tkáně)

M. temporalis

18,5

M. pectoralis maior

33,1

M. rectus abdominis

54,1

Bránice

29,4

M biceps brachii

31,5

Svaly jazyka

15,3

Myoglobin

Přítomnost lidského myoglobinu v koproliitech (subfosilních exkrementech) a keramice je dokladem kanibalismu.

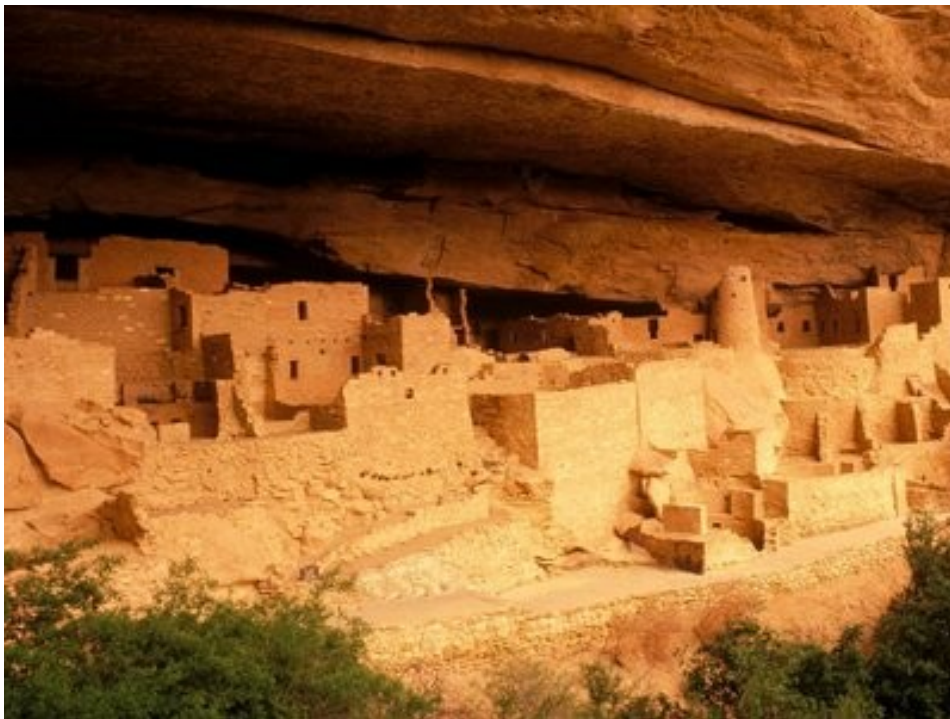

Anasazi (Pueblané, JZ USA)

Lipidy

= estery vyšších mastných kyselin

Glyceridy (glycerol)

Tuky

Oleje

Vosky (alkoholy s dlouhým řetězcem)

Ostatní (cholesterol, aj.)

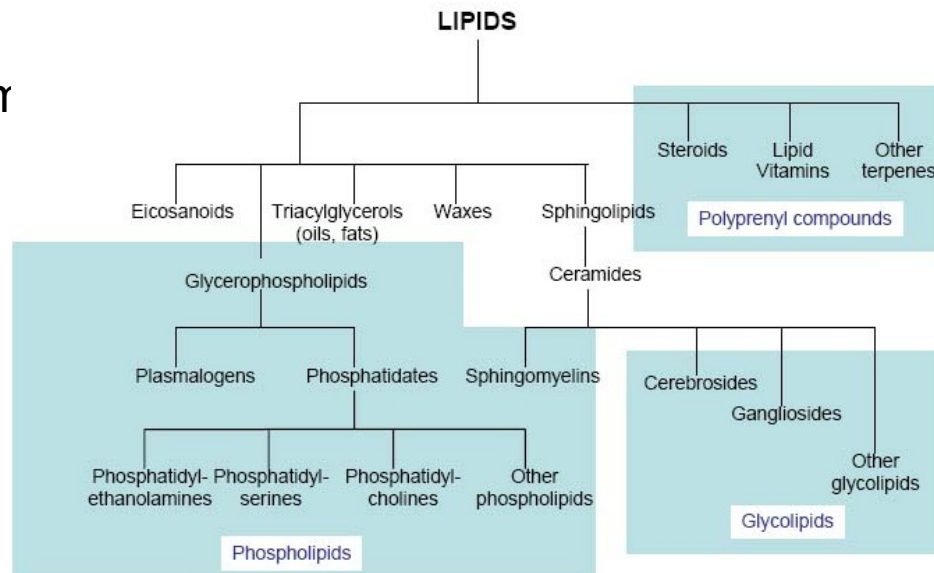
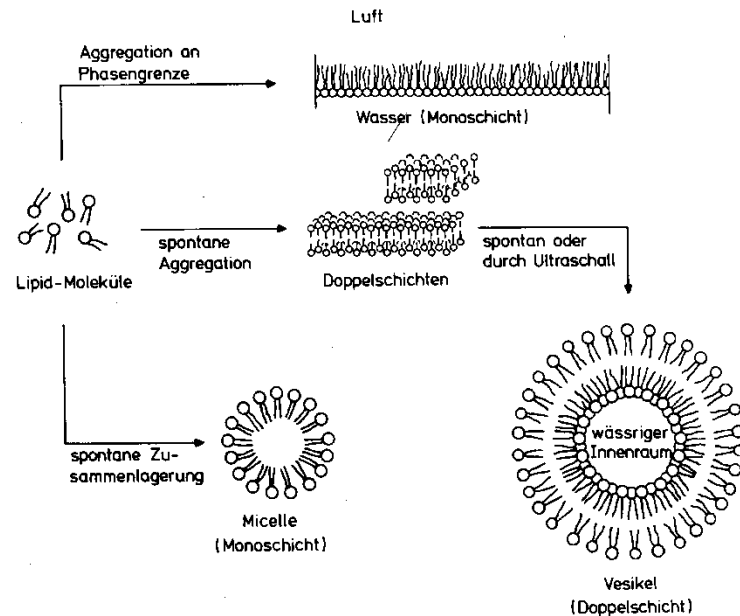

Živočišné tuky

Tabulka 13

Složení mastných kyselin některých důležitých tuhých tuků

Mastná kyselina	Obsah (% veškerých mastných kyselin)							
	kokosový tuk	vepřové sádlo	hovězí lůj	mléčný tuk kravský	margarín ⁺)	pokrmový ⁺) tuk 100%ní	lidský tuk podkožní	tuk mateřského mléka
Máselná	0	0	0	2-4	0,1	0	0	0
Kapronová*)	0-0,8	0	0	1,4-2	0,1	0	0	0-0,1
Kaprylová**)	5,5-9,5	0-0,2	0	0,5-1,5	0-0,1	0	0	0-0,1
Kaprinová***)	4,5-9,5	0-0,2	0	1,6-2,7	0-0,1	0	0	0,5-1
Laurová	44-52	0,1-0,6	0,1-0,4	1,7-3,7	1-10	0-1	0,3-0,7	3-4
Myristová	13-19	1,4-2,4	2-3	7,9-12,1	1-8	0,2-3	3,1-4,3	6-8
Palmitová	7,5-10,5	24-30	24-31	25-32	10-20	6-20	22-25	26-32
Stearová	1-3	12-19	21-27	8-12	4-14	5-16	5,2-7	11-15
Palmitolejová	0-1,3	2,3-3,7	1,7-3,0	1,6-5,0	2-6	0-1	4,3-7	2,2-3
Olejová ⁺⁺)	5-8	38-46	38-48	26-33	21-55	33-68	41-47	23-28
Linolová	1,5-2,5	4,2-9,4	1,7-2,0	1,0-2,4	6-35	8-22	9-13	4-6
Linolenová	0	0,1-1,3	0-0,2	0-0,5	0-5	0-3	0-1,0	0,5-1,5
Arachidonová	0	0-1,0	0-1,1	0-0,8	0	0	0-0,5	0,4-1
Trans-izomery	0	0-1,0	4-12	5-9 ⁺⁺⁺)	6-16	3-20	2-7	2-9
Rozvětvené	0	0-0,2	1-2	1-3 ⁺⁺⁺)	0-0,1	0-0,1	0-1	1-2

⁺) pokud neobsahují řepkový olej

⁺⁺) včetně *trans*-izomerů

⁺⁺⁺) odkaz 30

*) hexanová

***) oktanová

****) dekanová

Anaerobní oxidace - mikrobiální

OH: *Bacillus subtilis*, *Clostridium perfringens*, *Micrococcus luteus*

Oxo: *Micrococcus luteus*

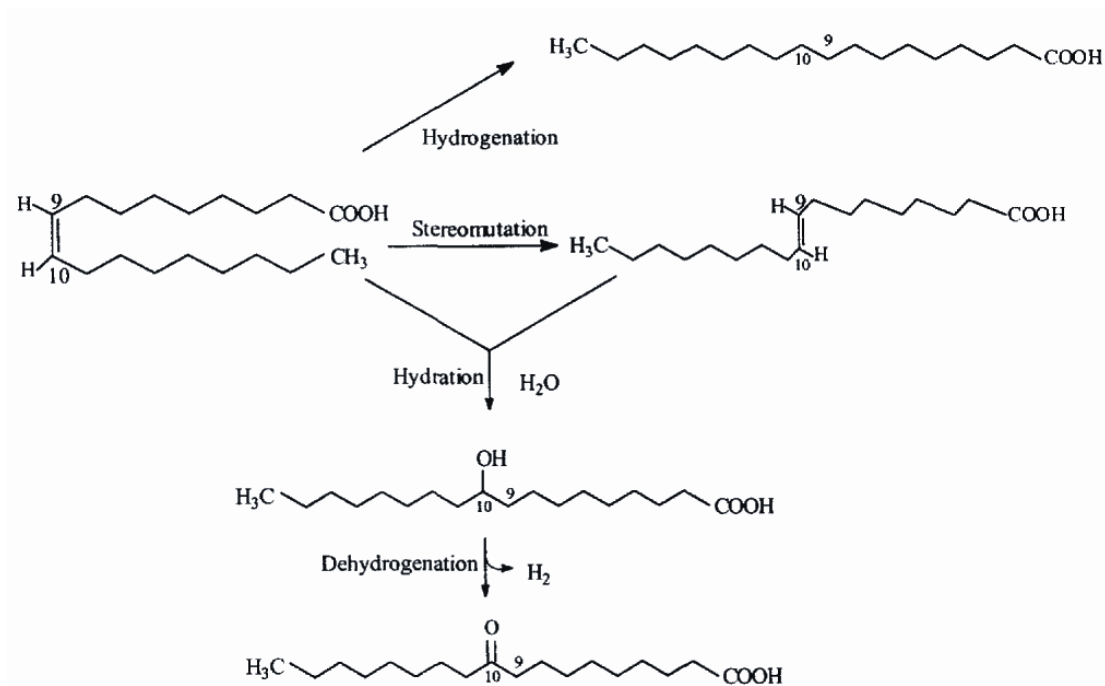
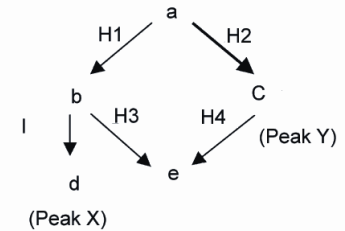
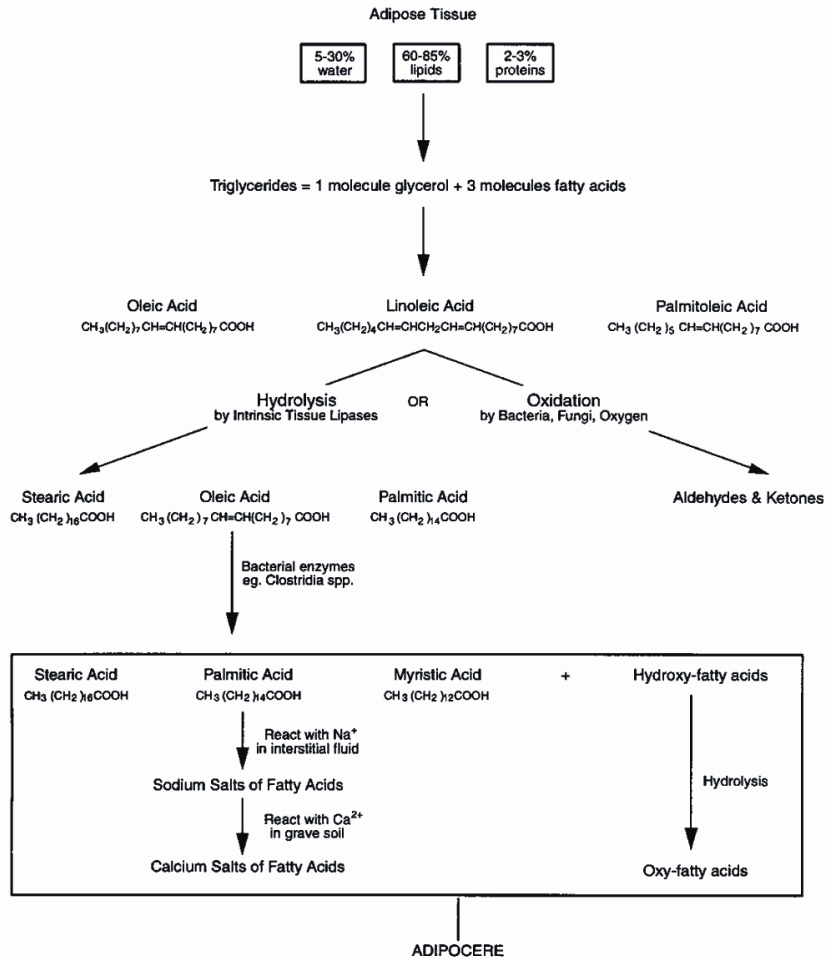

FIG. 6—Chemistry of microbial degradation of oleic acid during adipocere formation.

Anaerobní oxidace - mikrobiální



H1,2,3,4 : Hydrogenation
I : Isomerization

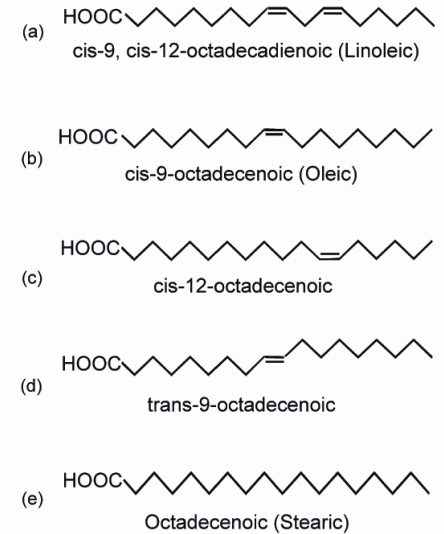

Fig. 4
Changes to fat during decomposition

Fig. 5. Putative pathway from octadecadienoic acid to octadecenoic acid or octadecanoic acid.

Produkty anaerobní oxidace

„bog butter“

máslo v dřevěné nádobě bylo
zakopáno do rašeliniště
(= způsob konzervace)



Cca 1000 let starý tuk ze zmrzlého odpadu v oblasti Yukonu

Lokalita Thule (Herschelův ostrov)

Materiál obsahoval poměrně významný podíl nenasycených MK. Nízká teplota nedovolila významnější mikrobiální aktivitu, většina MK byla volných (jednoduchá hydrolýza ve vlhkém prostředí).

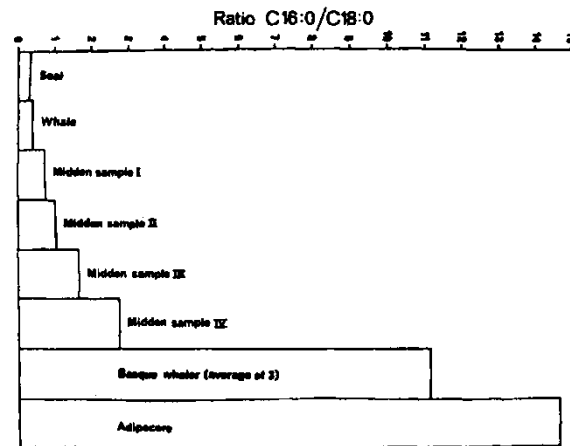
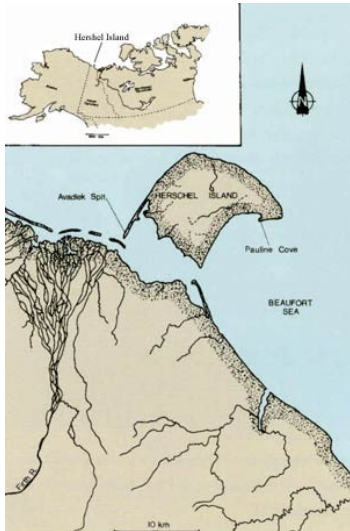

FIG. 4. Histogram showing ratio of palmitic acid (C16:0) to oleic acid (C18:1) for various substances, including unpublished results of fatty material from a Basque whaling station excavated at Red Bay, Labrador.

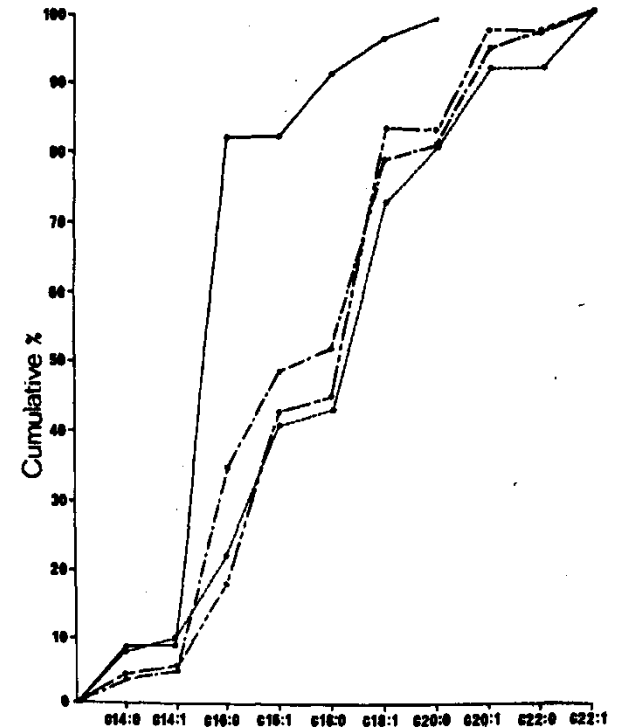

FIG. 5. Cumulative percentage fatty acid composition plots of various materials, showing apparent similarity of midden samples (means of samples I, II, and III of this study) to average for three seal species and average for whales (data taken from Table 4). Adipocere —, midden samples I, II, III ----, average seals ····, average whales -·-·.

Palivo v římských kahanech

Rostlinné oleje (olivový) – fytoosteroly, vyšší obsah kyseliny olejové

Živočišný tuk (lůj) – cholesterol, vyšší obsah kyseliny stearové

Greek Olive Oil (Methyl Ester)

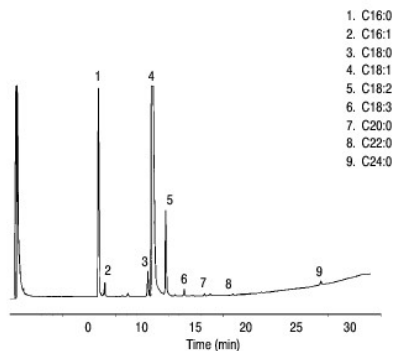

GC: 6890
Carrier: Helium, constant flow 46.6 psi
Column: HP-INNOWax, 30 m x 0.25 mm x 0.25 μ m (Part No. 19091N-133)
Inlet: 1.5 μ l, 260°C, deactivated liner with glass wool
Oven: 150°C (1 min), 2.9°C/min 230°C (1 min)
Detector: FID 260°C

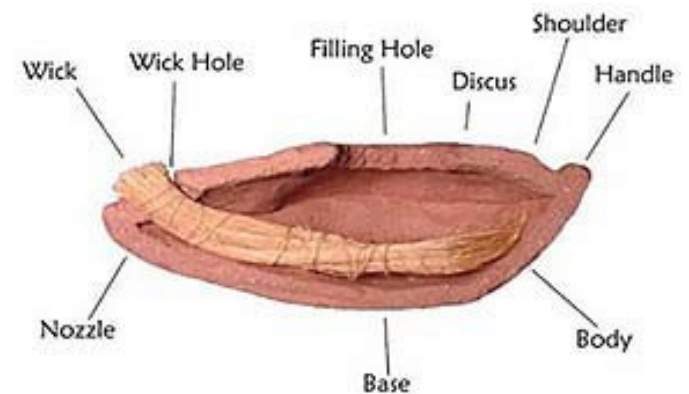

Epikutikulární vosk - Brassicaea

Biomarker v archeologii: důkaz vaření kapusty (*Brassica oleracea*)

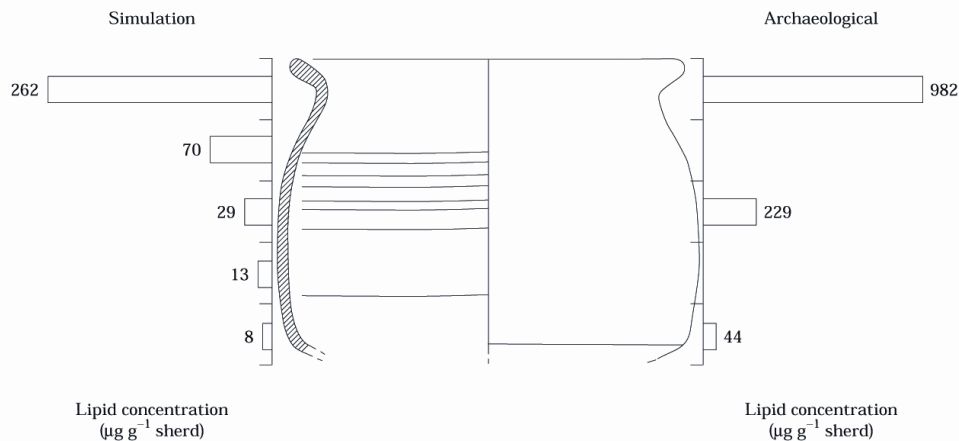

Figure 3. Diagram of a Late Saxon/early mediaeval jar (RP54). On the left is a histogram showing the lipid concentrations ($\mu\text{g lipid g}^{-1}$ sherd) as an average of three samples taken from cleaned ceramic at five points on the experimental vessel. On the right is a histogram showing the lipid concentrations ($\mu\text{g lipid g}^{-1}$ sherd) at three points on the ancient vessel (RP54).

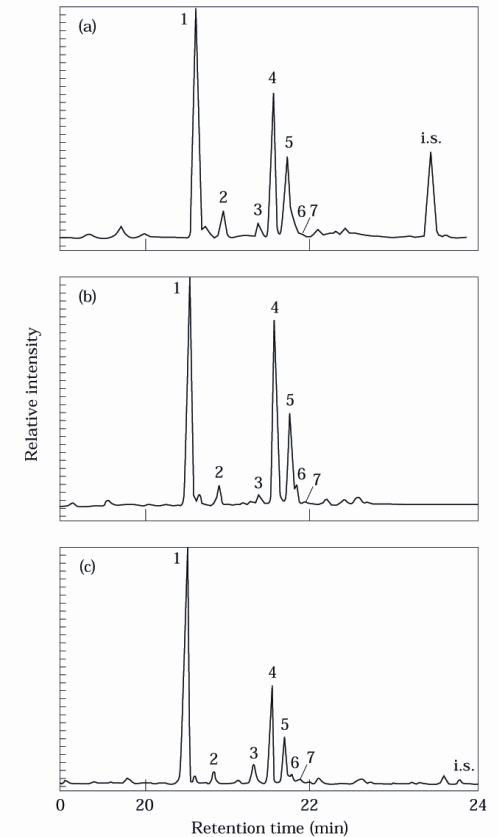
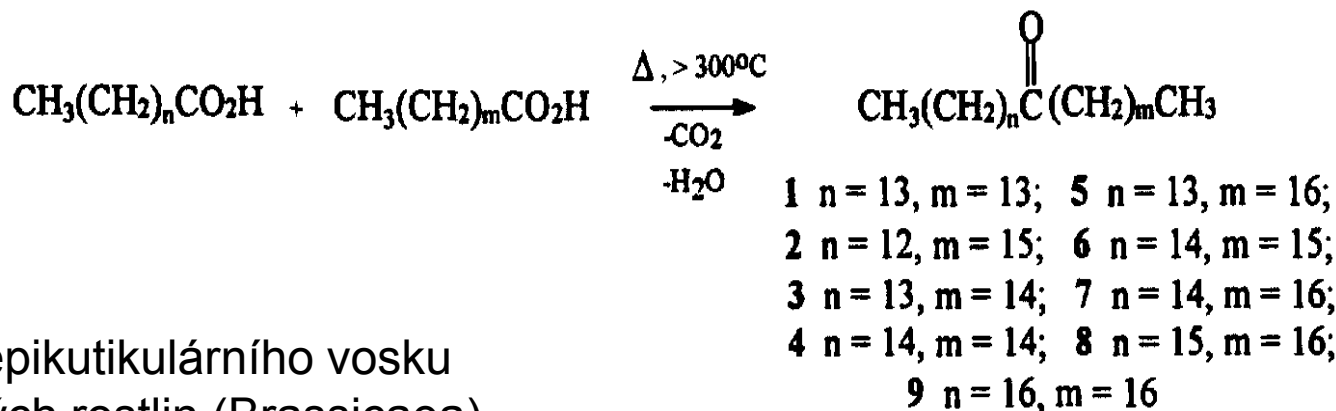

Figure 2. Partial gas chromatograms of the lipid extracts from (a) the experimental jar (ED1); (b) modern *Brassica* leaves; and (c) the ancient jar (RP54). In each case the peaks represent *Brassica* leaf wax components: 1 = *n*-nonacosane; 2 = *n*-hexacosanol; 3 = *n*-heptacosanol; 4 = nonacosan-15-one; 5 = nonacosan-15-ol; 6 = *n*-hentriacontane; and 7 = *n*-octacosanol. i.s. = the internal standard *n*-tetraatriacontane. Internal standard was not added to the leaf wax extract (b).

Ketony s dlouhými alkylovými řetězci

kondenzační produkty MK v archeologickém materiálu



Součást epikutikulárního vosku
brukvovitých rostlin (Brassicaea)

řepka
kapusta

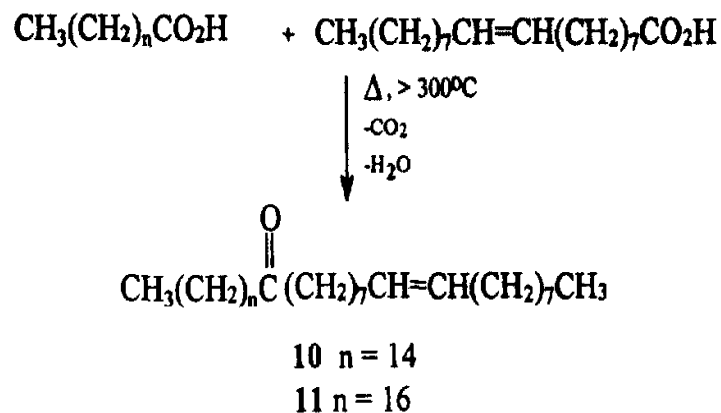

Reesterifikace

Ethylestery MK v tuku

(vlasy, tuková tkáň) – forenzní materiál:

významné zastoupení v tkáních
chronických alkoholiků

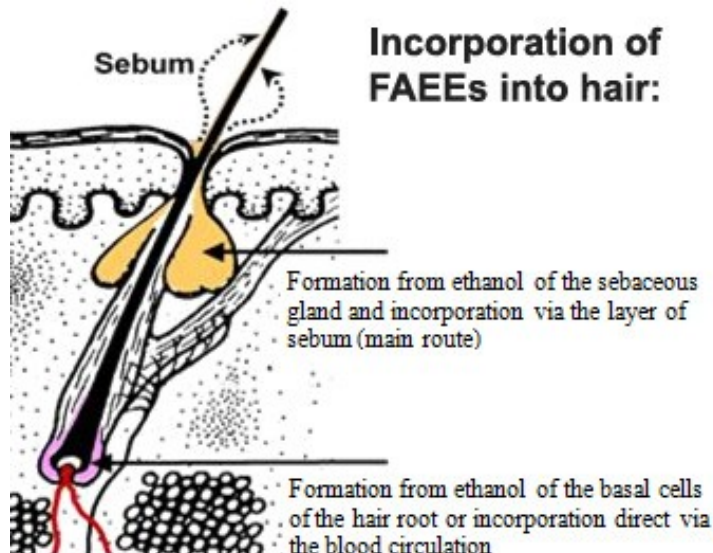

Ethylestery mastných kyselin byly nalezeny ve vlasech mumií (mužů i žen) kultury Chiribaya (JZ Peru, poušť Atacama, 1000-1250 n.l.). Zdrojem ethanolu byl fermentovaný kukuřičný nápoj „chicha“.

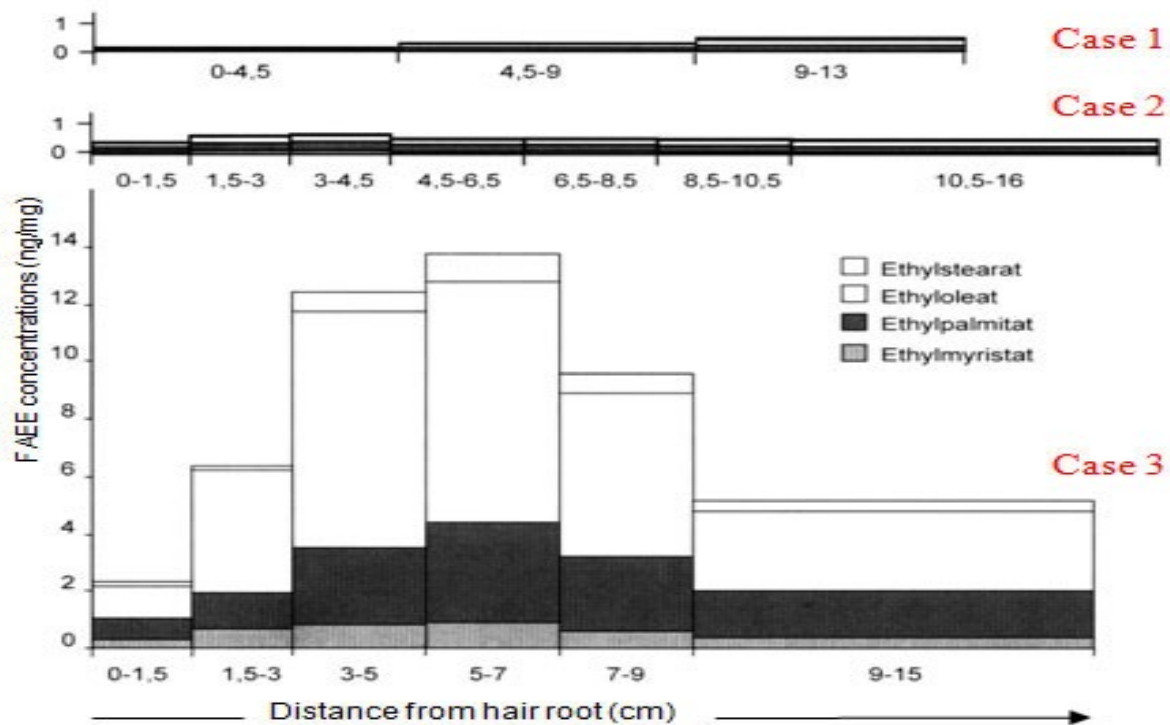

Case 1 abstinent

Case 2 příležitostný (společenský) piják

Case 3 alkoholik v léčbě (60 gramů ethanolu/ den po dobu 6 měsíců).

Nízkomolekulární látky

Tabák

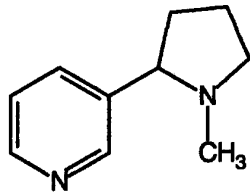

Nicotine, NIC

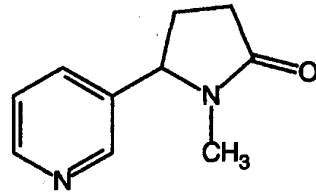

Cotinine, COT



Fig. 443. A—C Bauerntabak (*Nicotiana rustica*).
A Blühende Pflanze. B Blüte. C Dieselbe im Längsschnitt.

D—J Gewöhnlicher Tabak (*N. Tabacum*).
D Blühende Pflanze. E Blüte. F Frucht. G Same. H Derselbe im Längsschnitt. J Narbe.
(Nach Engler-Prantl.)



Adriaen van Ostade,
*An Apothecary
Smoking in an Interior*
1646, oil on panel.

Tabák



Detail chrupu muže středního věku z East Kirk of St Nicholas (Aberdeen; 17. stol.)

Table 1: Nicotine concentrations (ng/g) in the human remains from Kirchheim.

Group	n	Age	ng/g
1.	2	0- 9	32.7- 58.8
2.	2	10-19	31.8- 36.9
3.	2	20-29	33.6- 35.4
4.	4	30-39	33.0- 46.8
5.	2	40-49	37.5-149.7
6.	3	50-59	33.3- 55.2
7.	3	70-80	31.8- 39.8
8.	5	adults (20-80)	31.2- 44.4

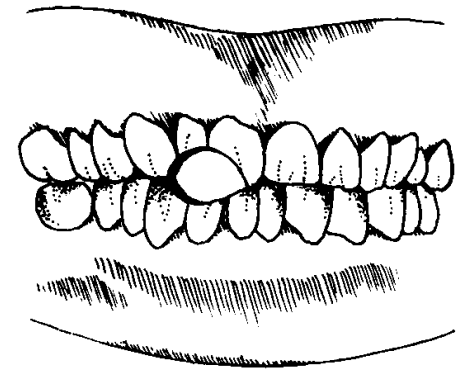

Hašiš

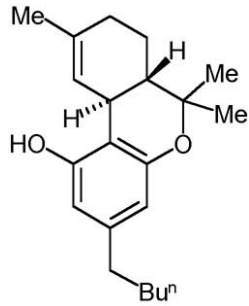

Tetrahydrocannabinol (THC)



Pazyryk (skytská mohyla)



Koka

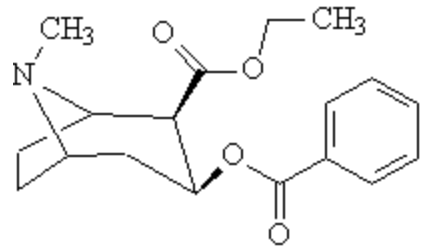

kokain



PLATE XX.—*Erythroxylon coca* (Coca). (From Jackson: *Experimental Pharmacology and Materia Medica*.)

Koka



Figure 1. A coca-leaf "quid" distends the left cheek of the naturally mummified remains of a 36-year-old male from the Maitas Chiribaya culture.

TABLE 1
Radiocarbon Dating and Cocaine Tests from the Pisagua-7 Site

Mummy Number	Age(Yr)	Sex*	Cocaine Test			14C Lab No.	Radiocarbon Dates	
			Matrix**	ng/10mg***	Pos/Neg****		13C-corrected Conventional Radiocarbon Age (+/- 1 sigma B.P.)	Calibrated Date***** 2 sigma
726-A	5-7	I	H	0.3	Neg	GX16097 (Muscle)	2955 +/- 115	1443-858 I = 1154 BC(RAD)
723	25-30	M	H	0.7	Neg	GX16098 (Skin)	2695 +/- 85	1012-764 I = 833 BC(RAD)
725-A, C2	40-45	F	H	13.3	Pos	Beta 169826 (Hair)	2850 +/- 50	1140-900 I = 1000 BC(AMS)
741	3-4	F	N	5.6	Pos	Beta 170070 (Hair)	2730 +/- 40	940-810 I = 850 BC(AMS)

*Sex: I = Indeterminate, M = male, F = female.

**Matrix: H = hair, N = nail.

***ng/10mg = nanograms/10 milligrams of sample. Values of 3.0 or greater = positive.

****Neg = negative, pos = positive.

*****I = value at line of intercept. (RAD) = radiometric method; (AMS) = accelerator mass spectrometry method. GX = Geochron Laboratories, Cambridge, Massachusetts. Beta = Beta Analytic Laboratory, Miami, Florida.

Stanovení v lidských pozůstatcích

CONCENTRATIONS (ng/g) OF ALKALOIDS AND METABOLITES			
—	Cocaine	Nicotine	Hashish
<i>Peru (natural mummies)</i>			
Hair	220–13 900 (12)	28–1400 (12)	50–1700 (17)
Soft tissue	43–1371 (10)	57–1997 (6)	49–2795 (8)
Brain	42–185 (4)	84–587 (3)	15–138 (4)
Teeth	10–113 (5)	17–104 (7)	15–39 (4)
Bone	26–326 (16)	39–577 (26)	14–276 (20)
<i>Egypt (artificial mummies)</i>			
Hair	24–200 (4)	140–900 (4)	800–4100 (4)
Soft tissue	70–442 (8)	125–1045 (10)	59–2875 (10)
Bone	25–110 (6)	45–1050 (11)	36–2800 (10)
<i>Bell culture</i>			
Bone	0 (10)	56–142 (8)	0 (10)
<i>Sudan</i>			
Bone	0 (2)	87–93 (2)	0 (2)

No of samples in parentheses.

Kakao

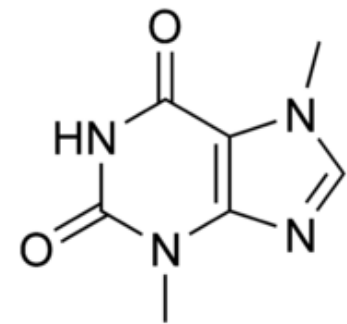

theobromin

Kakao

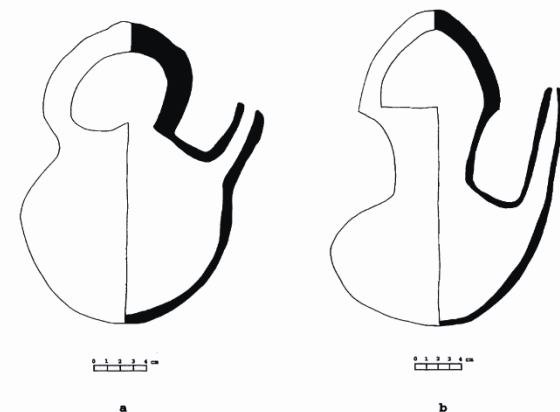
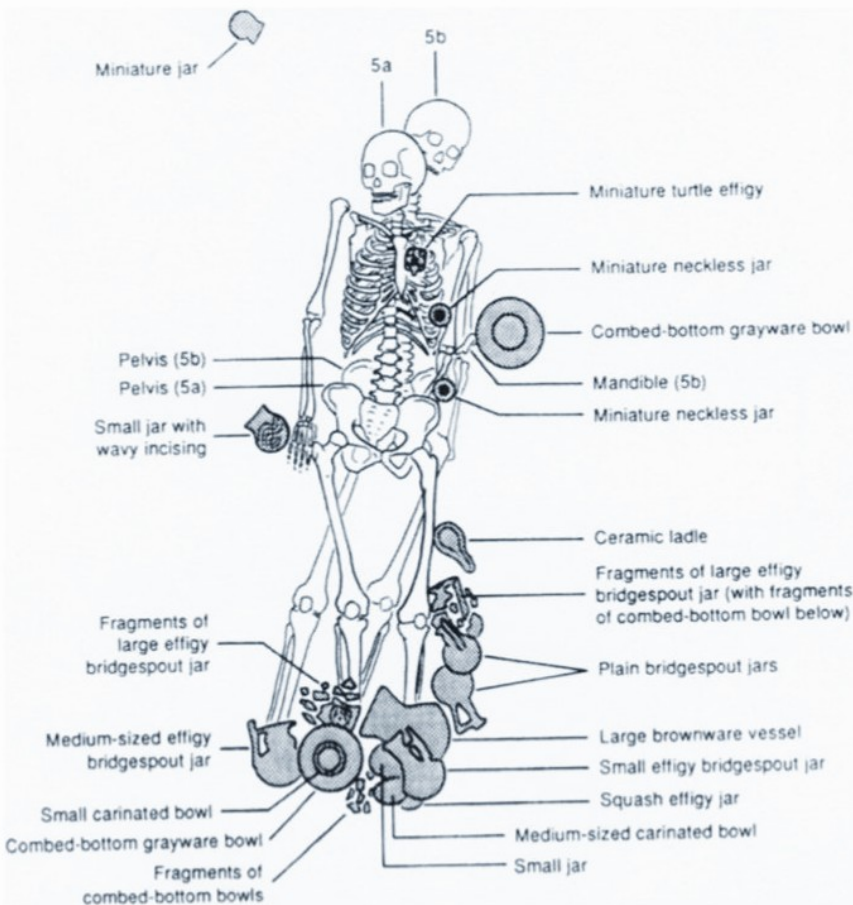
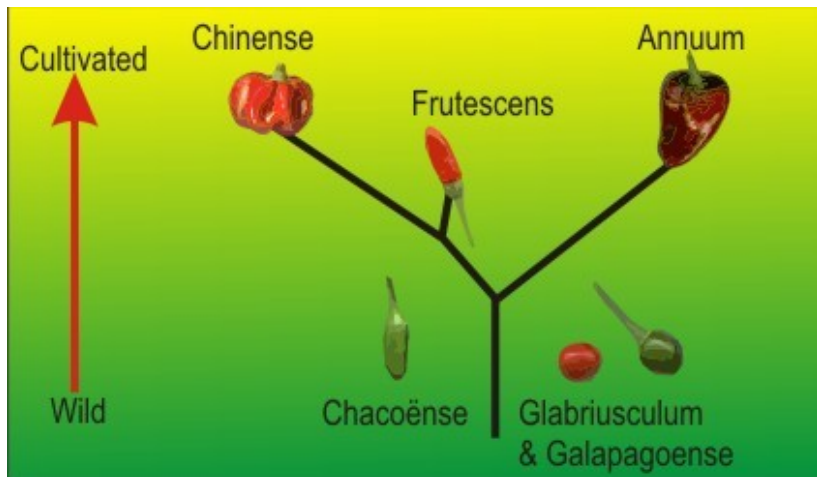

Figure 10. Spouted vessels from Colha, Belize containing substantial cacao residues; a: Unnamed Black and Fluted (Chunhinta Ceramic Group) type jar found in burial Strat 67 of Op. 2012 (after Valdez 1987:107-108; b: Unnamed Black, Fluted, and Red Stuccoed (Chunhinta Ceramic Group) type jar found in burial Strat 61 in Op. 2012. (Illustrations by Jenifer Bryan and courtesy of Thomas R. Hester and Fred Valdez, Jr.)



Figure 5. Late Preclassic spouted vessels from Oaxaca; a: spouted jars from Burials 5a and 5b, possibly a husband and wife from an elite family, at Abasolo, Oaxaca (after Marcus and Flannery 1996:171). Illustration courtesy of Joyce Marcus.

Paprika



Paprika

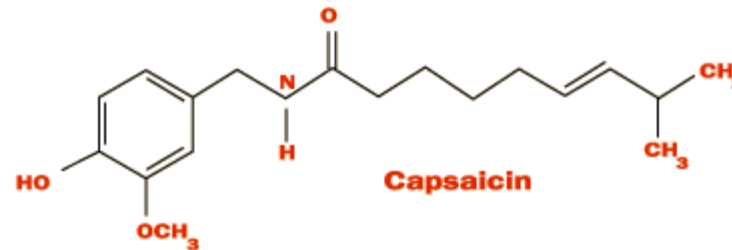

Table 1. Quantitative analyses of capsaicinoids in fresh fruits and archaeological samples

Sample	Sample weight (mg)	Capsaicin (mg) ^a (percentage content)	Dihydrocapsaicin (mg) ^a (percentage content)
<i>Capsicum annum</i> , fresh fruits	499	0.429 ± 0.004 (0.086%)	0.154 ± 0.003 (0.031%)
<i>Capsicum frutescens</i> , fossil fruits	966	0.036 ± 0.005 (0.0037%)	0.049 ± 0.005 (0.0051%)
10482 (R.233) ^b	1072	nd ^c	nd
10493 (R.236) ^b	984	nd	nd
10523 (R.239) ^b	1146	nd	nd

^a Mean ± standard deviation ($n = 3$).

^b Archaeological sample from cemetery number 2 at Yaral (Peru).

^c nd = none detected.

Betel

Listy pepřovníku betelového

Ořech arekové palmy (nezralé)



Areca catechu L.



PIPER BETLE.—LINN.—De Blanco.

1. betle

L. C. Dardagnac. Betelna.

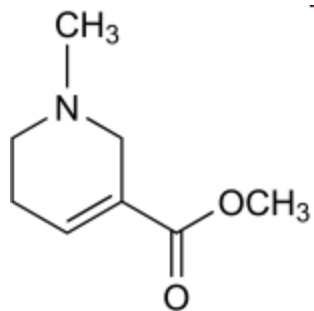

arekolin

arekaidin
guvacin
guvakolin

Vlastní betelové sousto se připravuje tak, že se na listy pepřovníku betelového obvykle dá vápno a dále se položí část semene arekové palmy, případně kousek kořene gambirovníku. Takto připravené komponenty se těsně zavinou do pepřovníkového listu, vloží do úst a sousto se intenzivně žvýká.



Peyotl

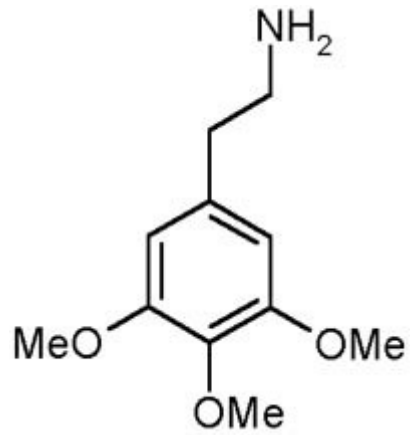

meskalin



Víno

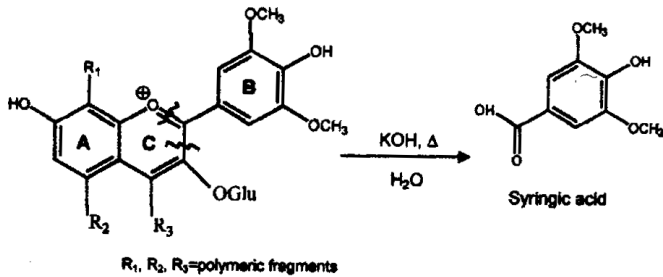

Malvidin-3-glucoside in the polymerized pigment

Figure 3. Production of syringic acid. Syringic acid is released from the flavylum structure of malvidin-3-glucoside in the polymerized pigment by alkaline fusion through the formation of a hydrated hemichemical form in which the pyran (C ring) is broken in two steps.

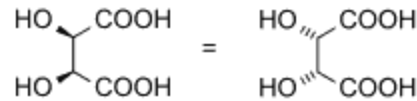
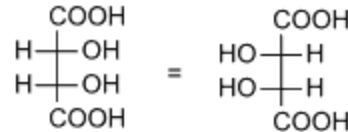

Víno lze ve výjimečných případech (např. v amforách z Tutanchamonovy hrobky v Egyptě) identifikovat na základě přítomnosti charakteristických biomarkerů. Pro víno je typická kyselina tartarová). Malvidin-3-glucosid je flavonoidní pigment zodpovědný za červenou barvu vína, nelze ho ale stanovit přímo – zalkalizováním vzorku se z něj uvolňuje kyselina syringová, ta se detekuje a její přítomnost pak charakterizuje červené víno. Přítomnost pouze kyseliny tartarové ukazuje spíše na bílé víno.

Keramika
Paleobotanika

polyfenoly
tartarová kyselina

syringová kyselina
(specifická pro červené víno)

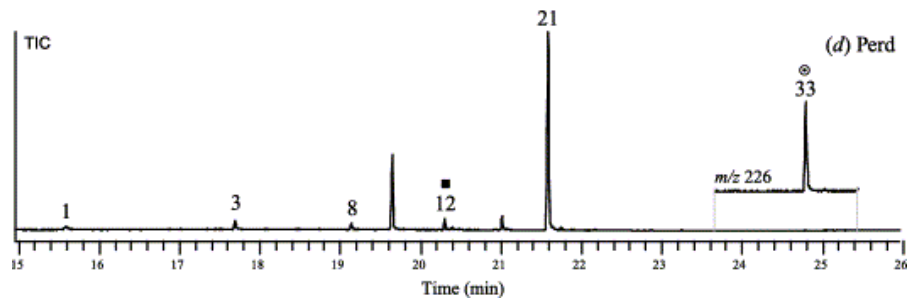
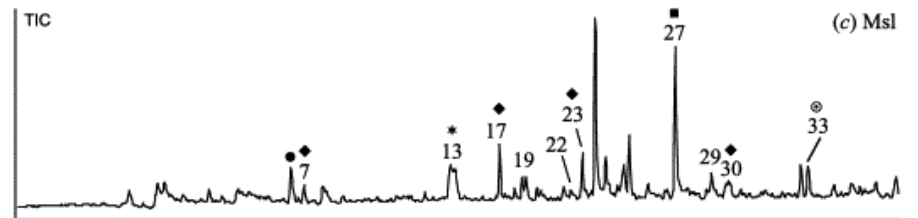
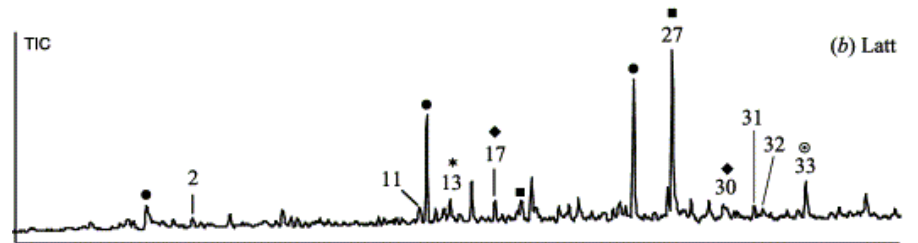
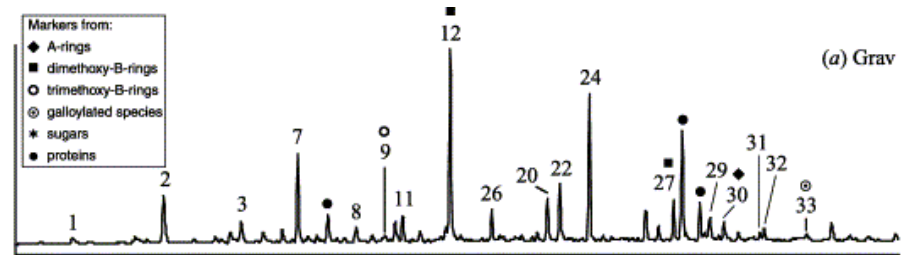

Pivo

Nelze specificky prokázat.

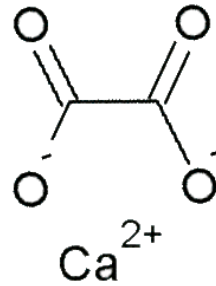

šřavelan vápenatý
(„pivní kámen“)

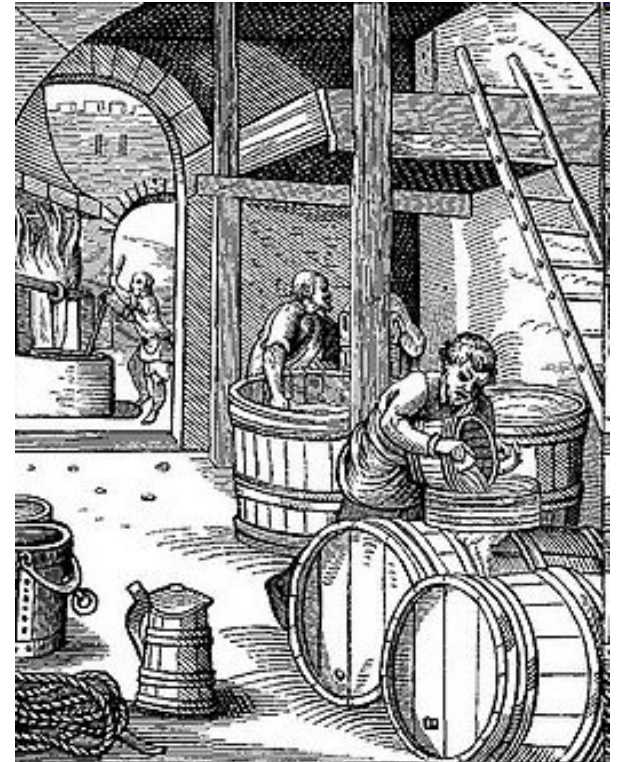

Izotopy

Izotopy v přírodě



The Nuclei of the Three Isotopes of Hydrogen

Protium



1 proton

Deuterium



1 proton
1 neutron

Tritium



1 proton
2 neutrons

STABLE ATOMS		UNSTABLE ATOM
Carbon 12	Carbon 13	Carbon 14
6 Protons 6 Neutrons	6 Protons 7 Neutrons	6 Protons 8 Neutrons

$$\delta^{13}\text{C} = \left[\frac{(^{13}\text{C}/^{12}\text{C})_{\text{Sample}}}{(^{13}\text{C}/^{12}\text{C})_{\text{Standard}}} - 1 \right] \times 1000$$

$$\delta^{15}\text{N} = \left[\frac{(^{15}\text{N}/^{14}\text{N})_{\text{Sample}}}{(^{15}\text{N}/^{14}\text{N})_{\text{Standard}}} - 1 \right] \times 1000$$

Presné hmotnosti niektorých atómov

Atóm	Relatívna hmotnosť	Atóm	Relatívna hmotnosť
^1H	1,007825	^{29}Si	28,976491
^2H	2,014102	^{30}Si	29,973761
^{12}C	12,000000	^{31}P	30,973763
^{13}C	13,003354	^{32}S	31,972074
^{14}N	14,003074	^{33}S	32,971460
^{15}N	15,000108	^{34}S	33,967864
^{16}O	15,994915	^{35}Cl	34,968854
^{17}O	16,999133	^{37}Cl	36,965896
^{18}O	17,999160	^{79}Br	78,91835
^{19}F	18,998405	^{81}Br	80,91635
^{28}Si	27,976927	^{127}I	126,90435

Fotosyntéza

C3 rostliny

ječmen, pšenice,
brambory, cukrová řepa,

C4 rostliny

kukuřice, cukrová třtina

CAM rostliny

ananas, sukulenty

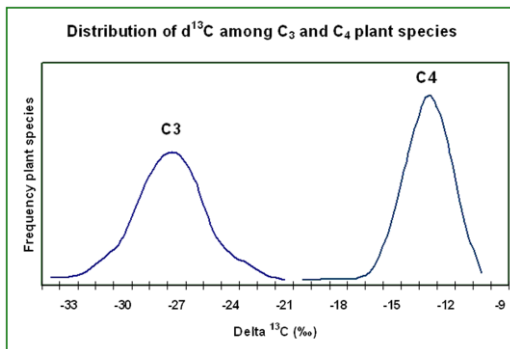
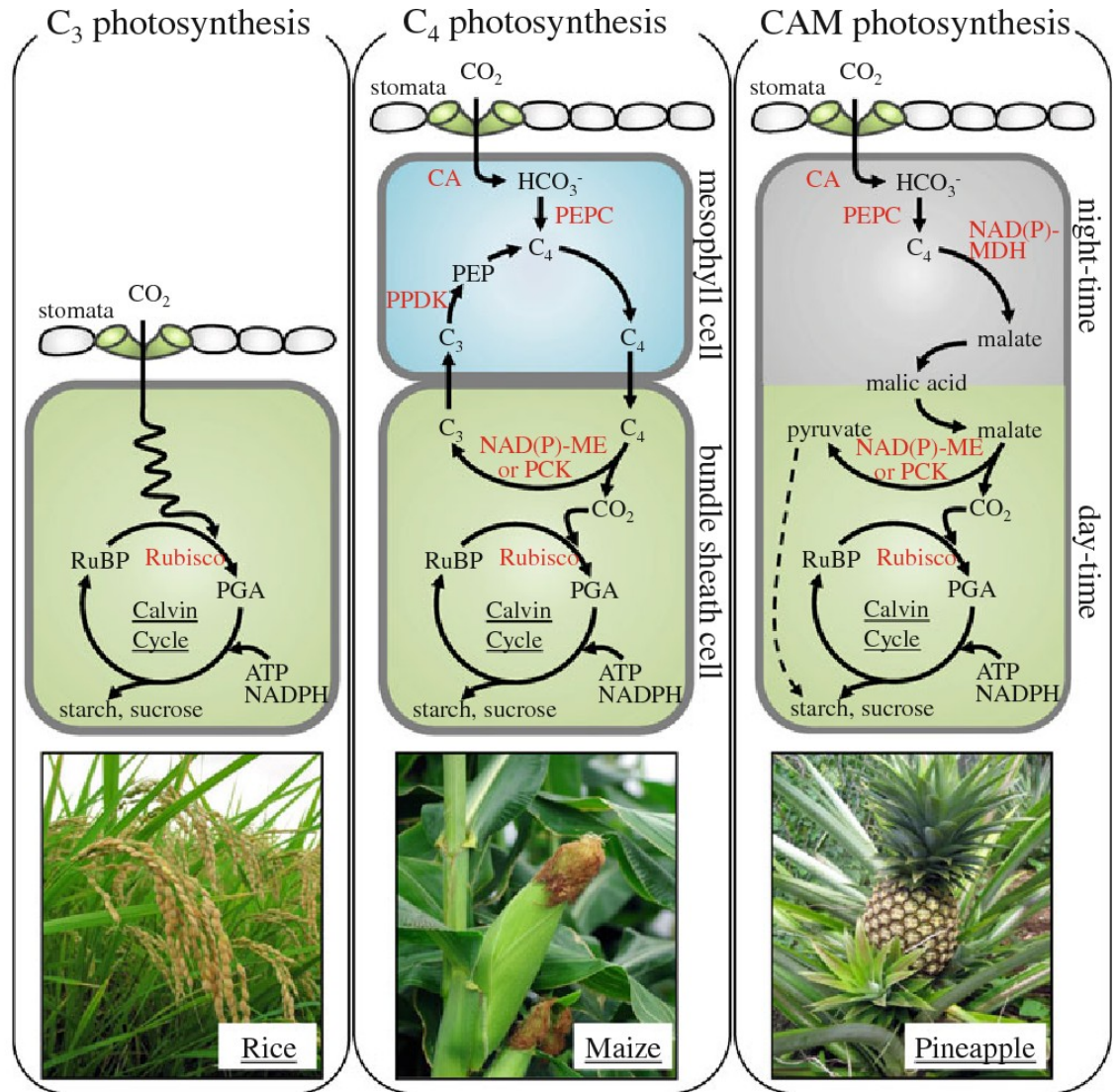

$$\delta^{13}\text{C} = \left[\frac{(^{13}\text{C}/^{12}\text{C})_{\text{Sample}}}{(^{13}\text{C}/^{12}\text{C})_{\text{Standard}}} - 1 \right] \times 1000$$

$$\delta^{15}\text{N} = \left[\frac{(^{15}\text{N}/^{14}\text{N})_{\text{Sample}}}{(^{15}\text{N}/^{14}\text{N})_{\text{Standard}}} - 1 \right] \times 1000$$

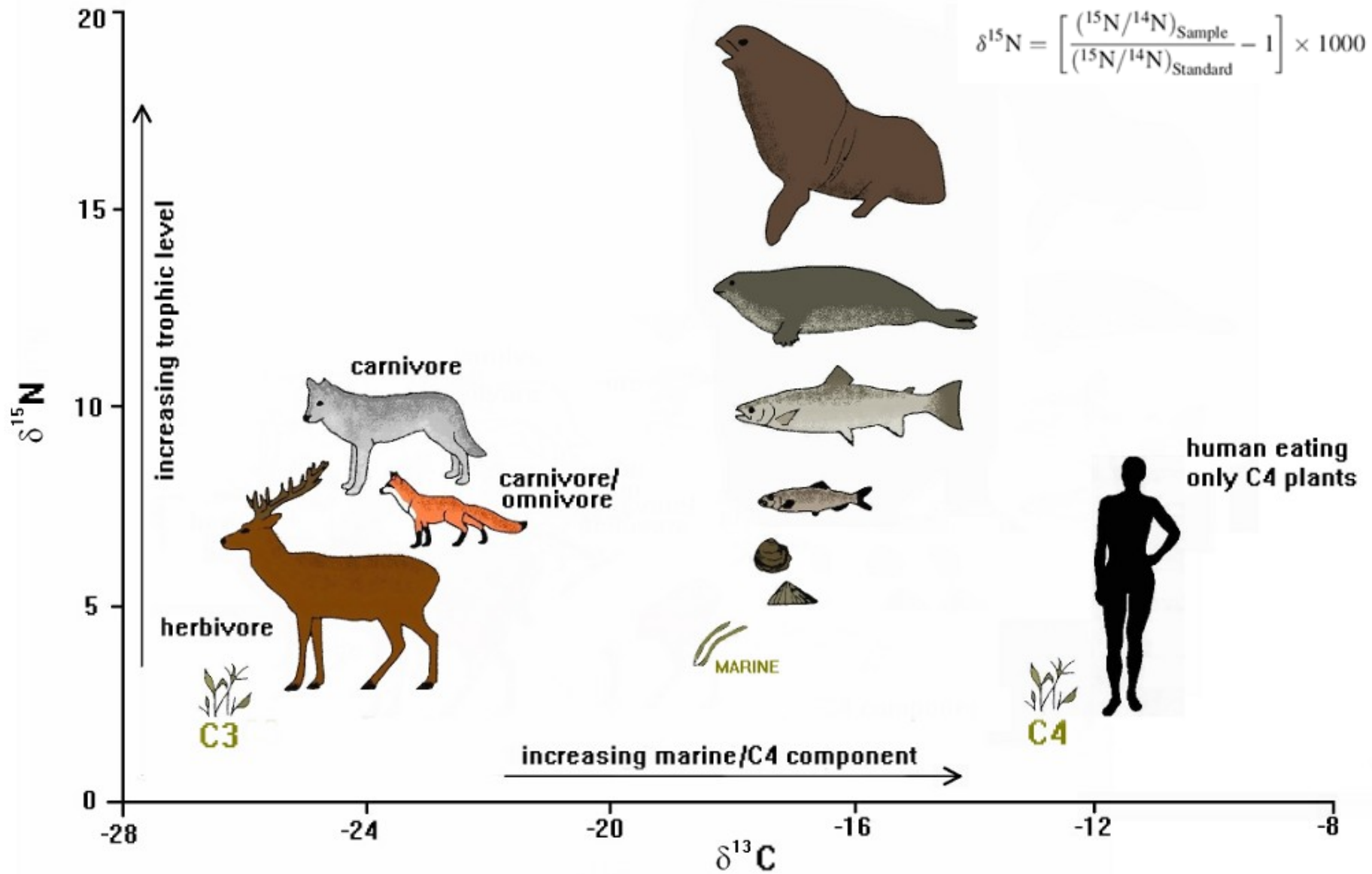

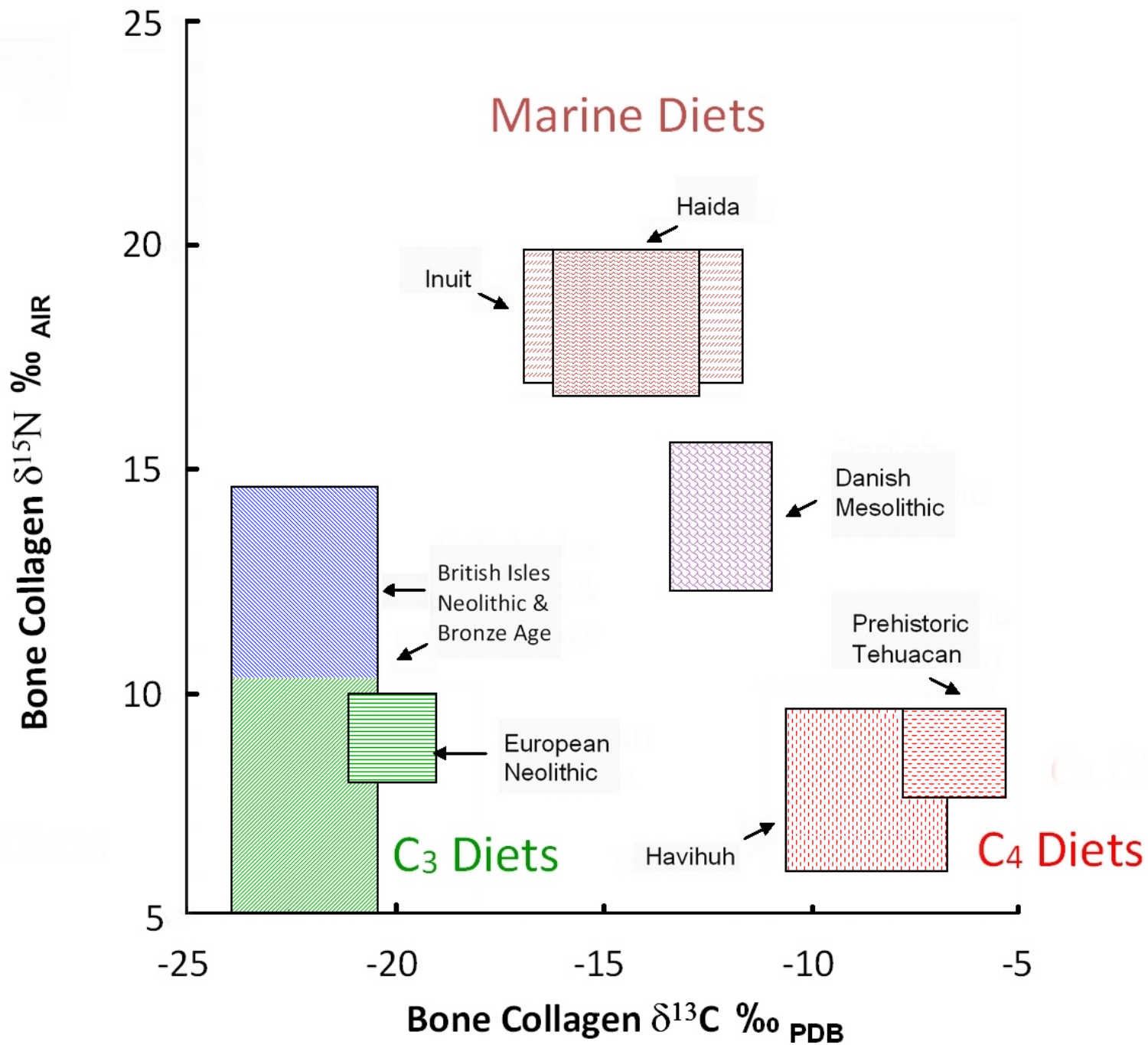

Izotopy v lipidech

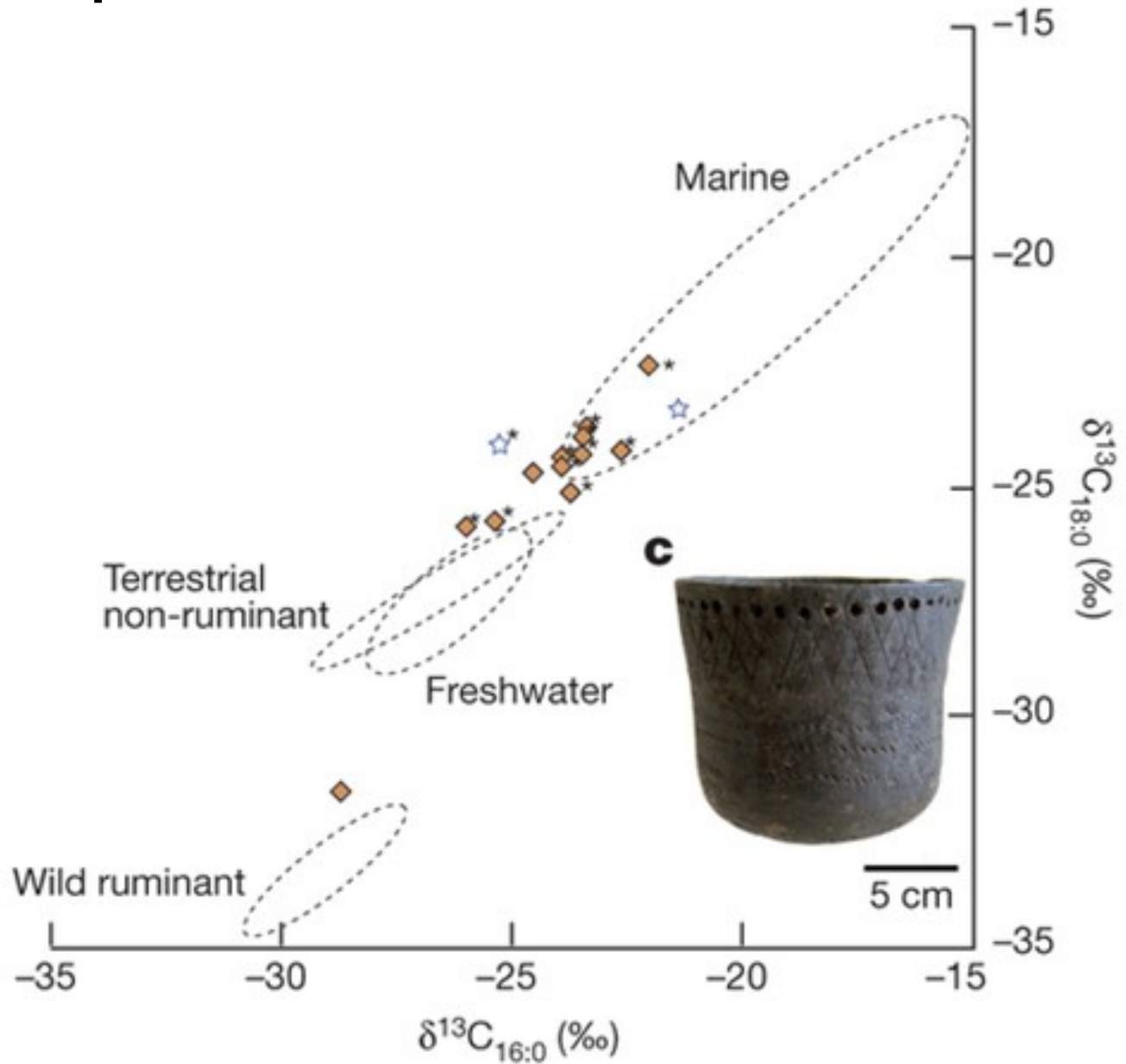

Mléko and mléčné produkty

Lipidy

trans-mastné kyseliny (vyšší obsah v extrahovaném tuku)

Proteiny

kasein (termicky degradovaný) – druhově specifický



Keramika

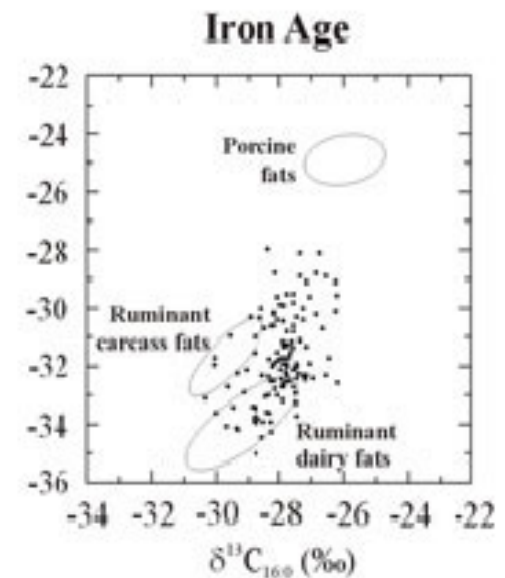
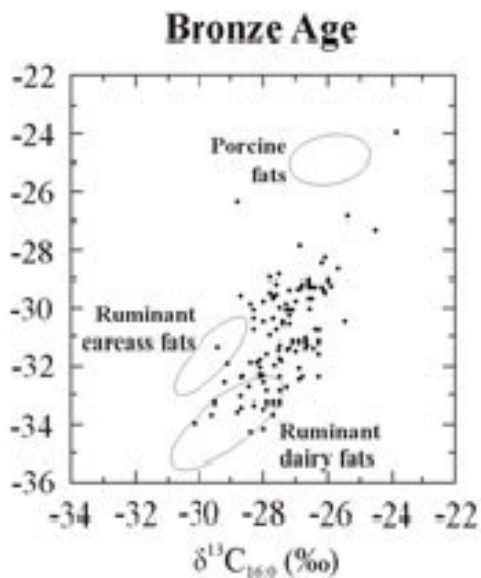
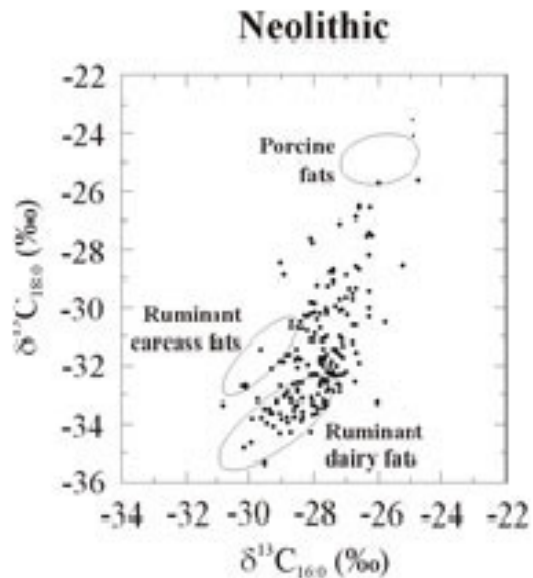

Maso

Keramika
Koprolity

Tuk (nespecifický)

Myoglobin (druhově specifický)

