



MINISTERSTVO ŠKOLSTVÍ,
MLÁDEŽE A TĚLOVÝCHOVY



OP Vzdělávání
pro konkurenceschopnost

INVESTICE DO ROZVOJE VZDĚLÁVÁNÍ

Antisense oligonucleotides

Antisense RNA

- Expression vector that produces a transcript, which is complementary to a known transcript
- Expression vector is introduced into a host cell by transfection and blocks translation of target mRNA

Antisense RNA

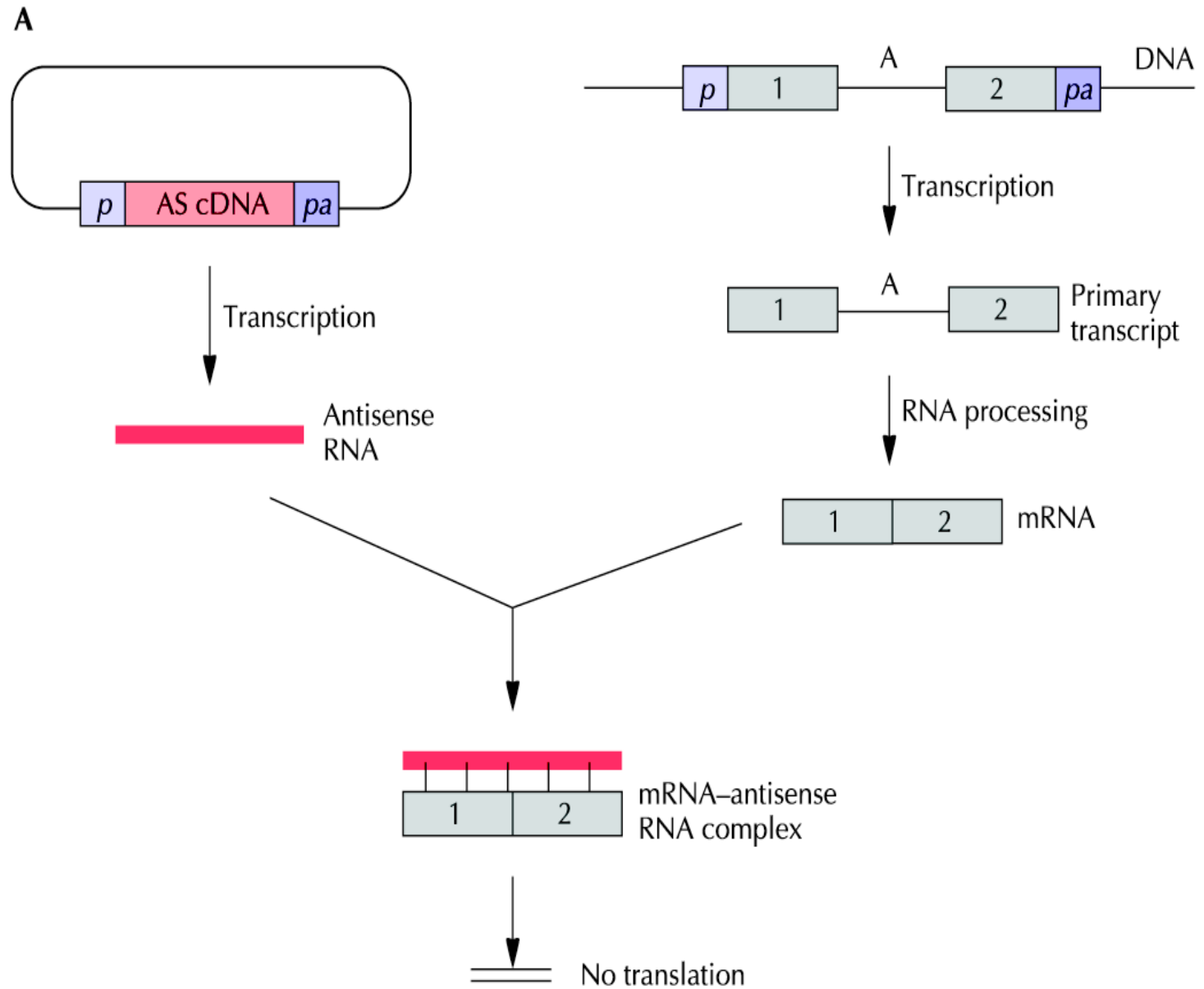

Therapeutic Antisense RNA

- Insulin-like growth factor 1
 - prevalent in malignant glioma (common brain tumour) as well as prostate carcinomas
- Rat prostate carcinoma cells transfected with antisense receptor cDNA
- Mouse injected with transfected cells
 - small or no tumours compared to control rats treated with non-transfected carcinoma cells

Why Antisense Oligonucleotides?

- Large antisense RNA is readily subjected to degradation
 - Human cells specifically target dsRNA for turnover by nucleases
- DNA oligonucleotides more stable, more readily delivered to target cells
- Directed to 5' or 3' ends of mRNAs, intron-exon boundaries, naturally ds regions

Antisense Oligonucleotides

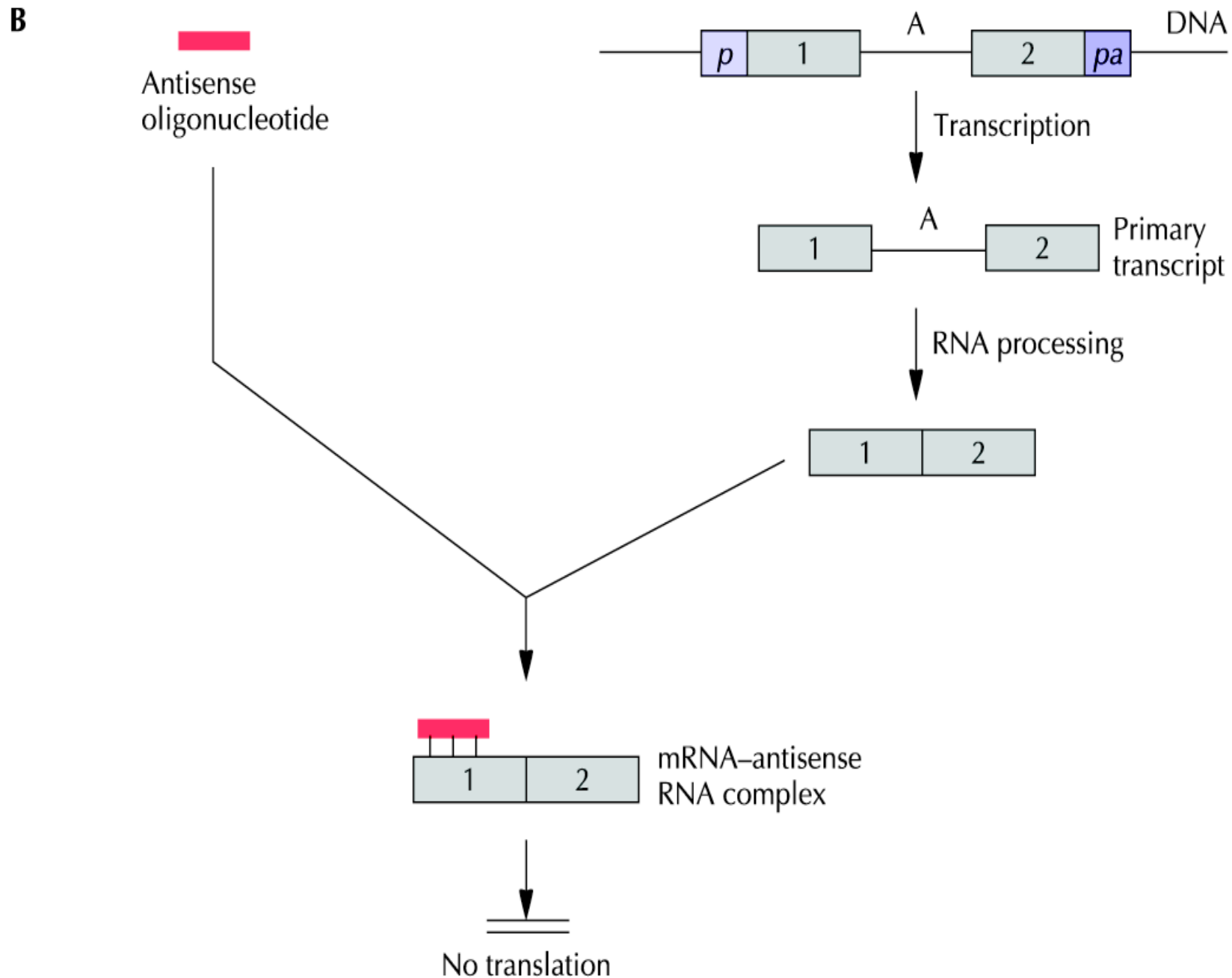

Antisense Oligonucleotides - „mode of action“

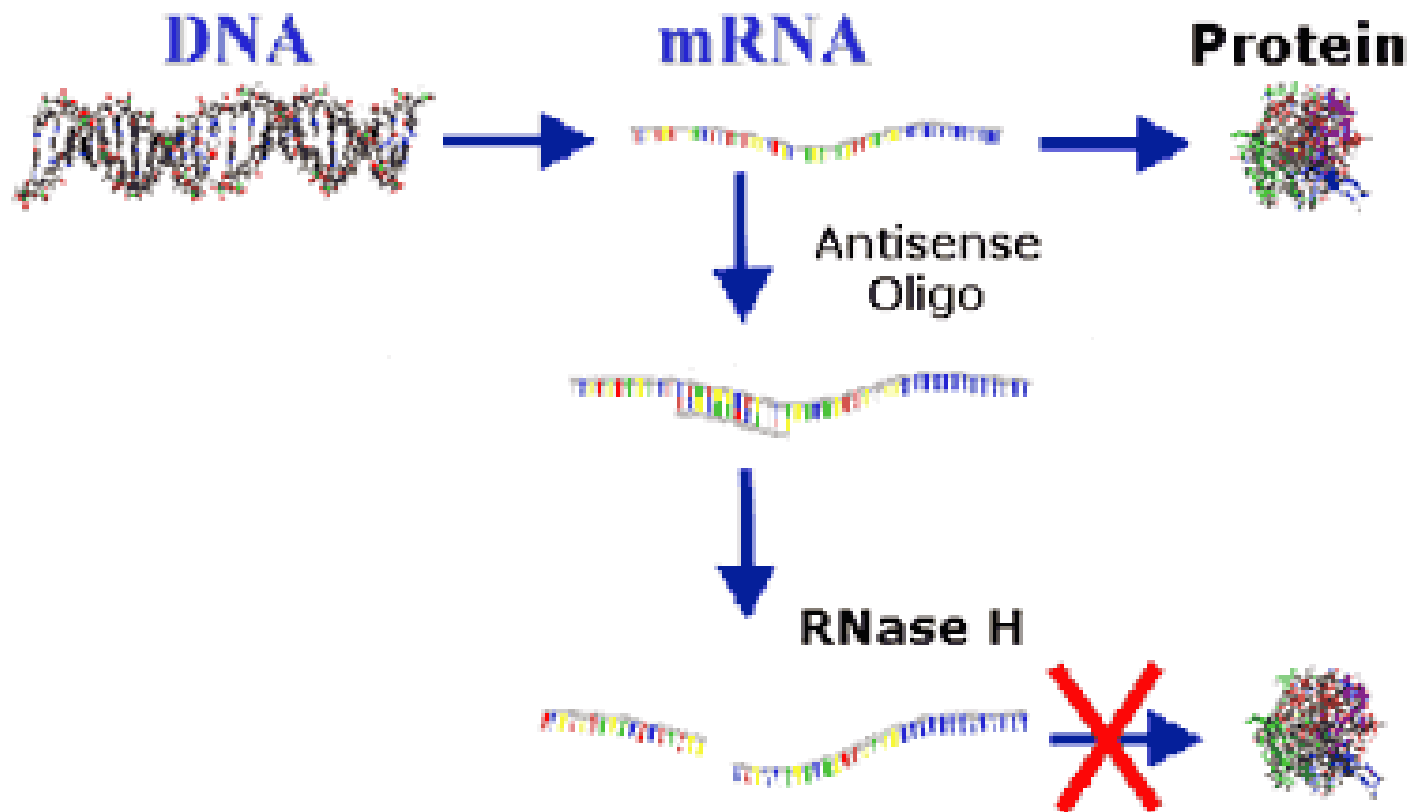

Possibilities of RNA-triplex forming by action of antisense-oligos

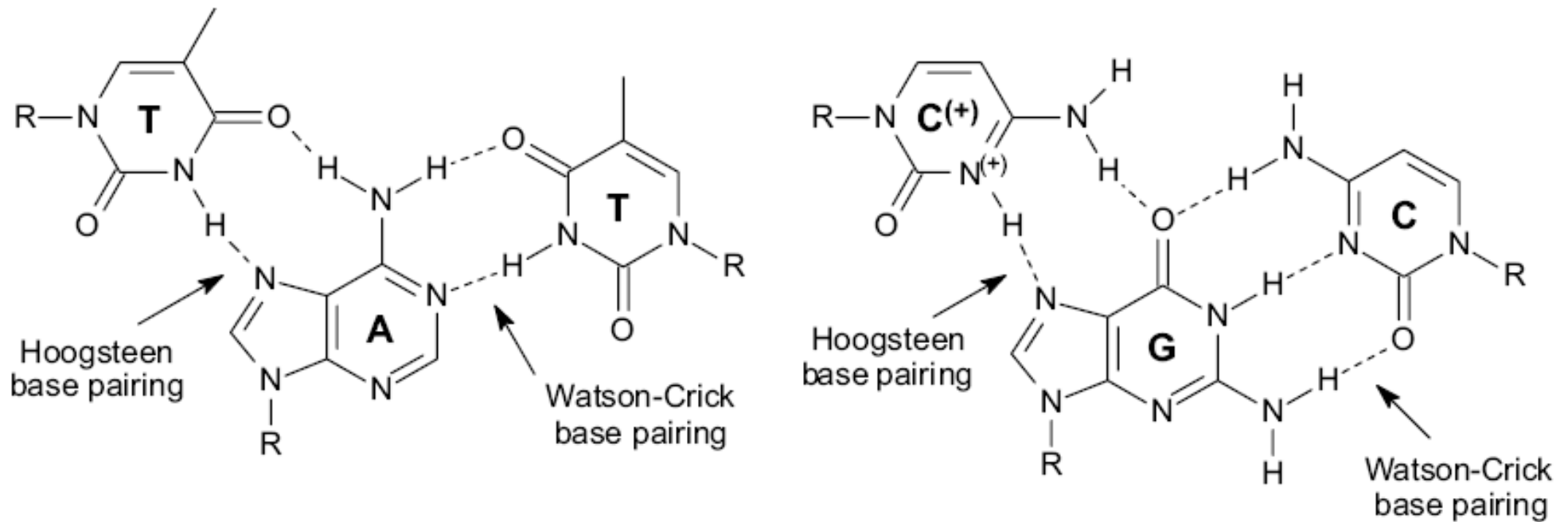

Fig. 6.11 Watson-Crick and Hoogsteen base pairing.

Possibilities of RNA-triplex forming by action of antisense-oligos (continued)

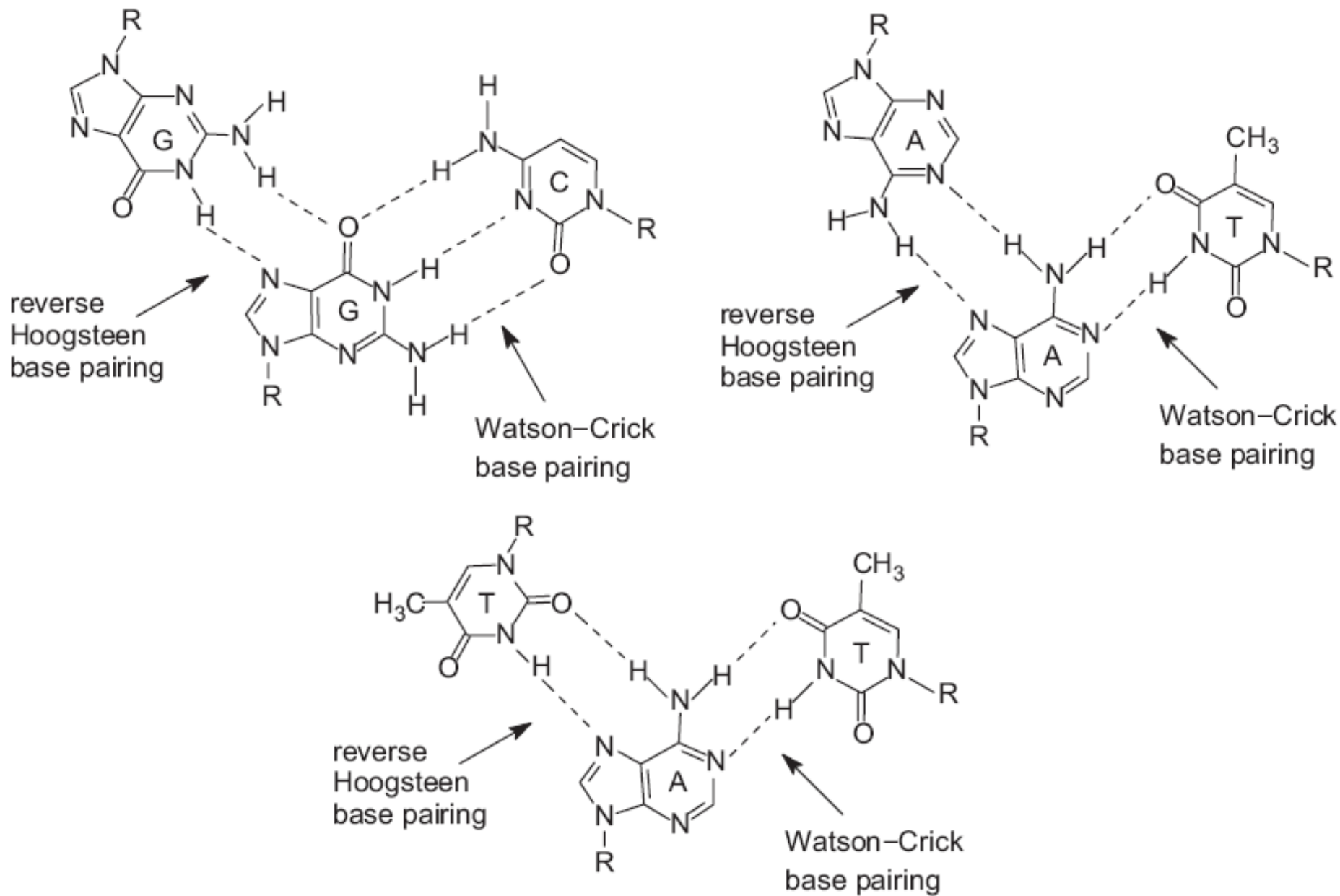
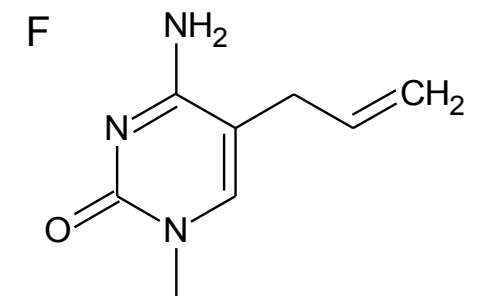
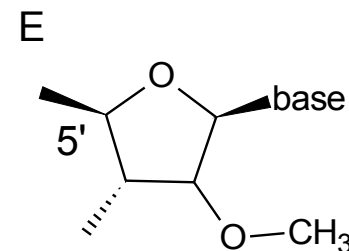
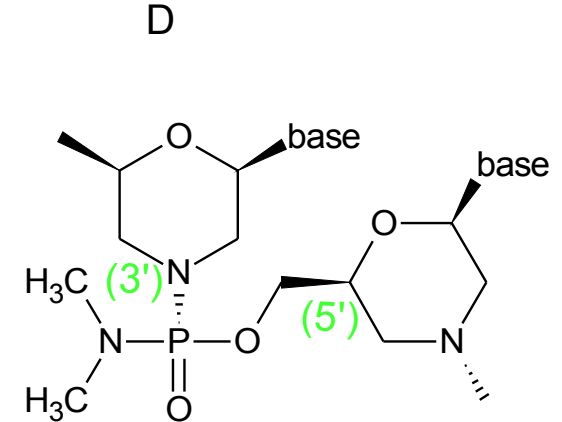
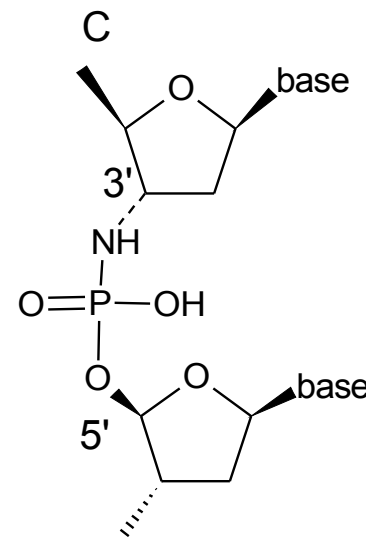
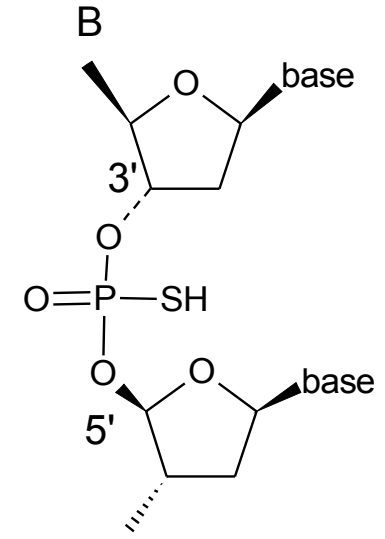
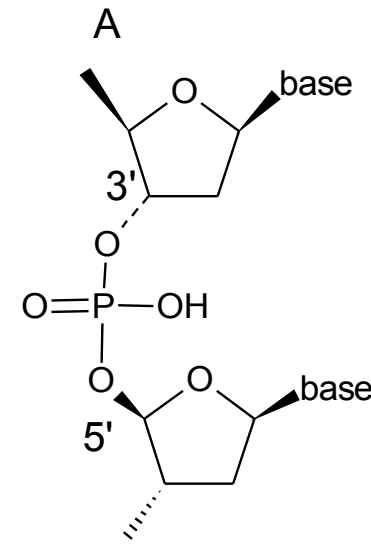

Fig. 6.12 Possible triple helix motifs.

Optimizing Antisense Oligos

- Natural oligos (A) susceptible to cellular nucleases
- Alterations improve nuclease resistance
- Replacement of free oxygen with sulfur in phosphodiester bond (B) particularly effective
- Replacement of deoxyribose with morpholine ring together with substitution of hydroxyl group in phosphate moiety (D) with dimethylamine led also to active compounds



Phosphorothioate Antisense Oligos (B)

- Water-soluble in form of polysodium salts
- Complex with target mRNA activates RNase H
- Some therapeutics in clinical trials
 - eg. against cytomegalovirus infection of retinas in patients with AIDS
- Decreased mRNA binding, increased nonspecific protein binding wrt native oligos

Native oligos: Splice Site Correction

- β -thalassemia: Mutations in hemoglobin chains lead to reduced oxygen binding (anemia)
- Binding of oligos prevent inappropriate splice activity

A

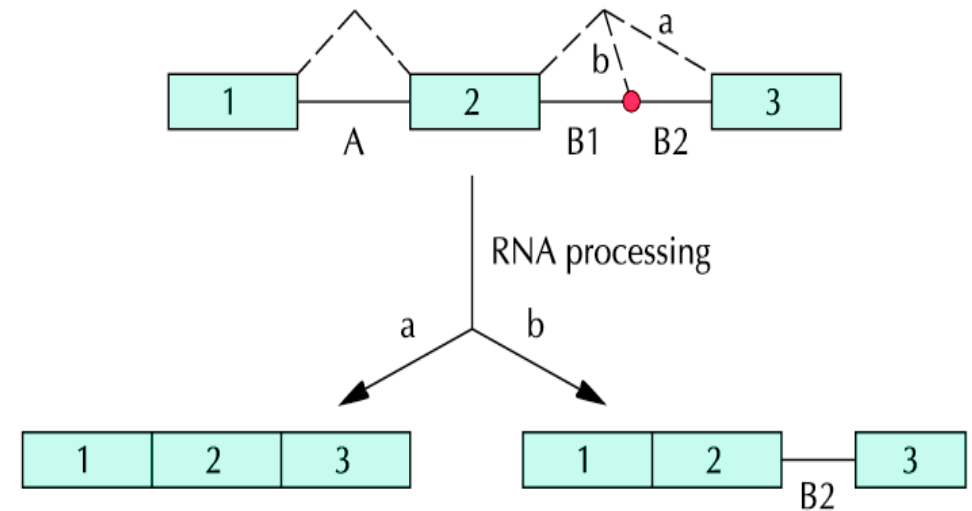

B

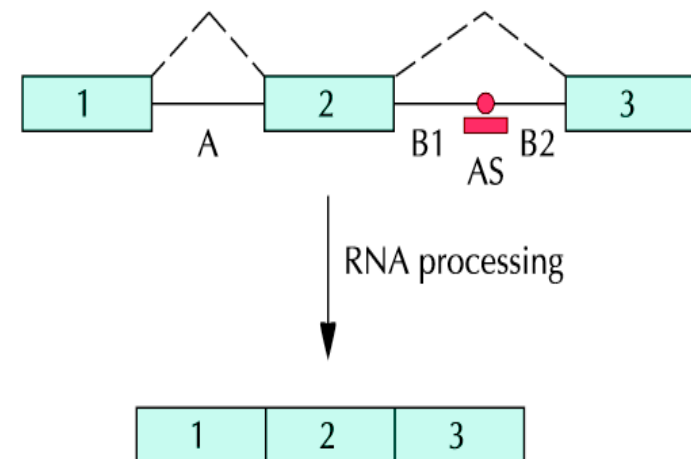

Oligos' Delivery

- Extremely hydrophilic
- Exactly tissue-targeted delivery needed
- Liposome plus cell-specific binding proteins could allow targeted, efficient delivery of appropriate doses of therapeutic antisense oligonucleotides

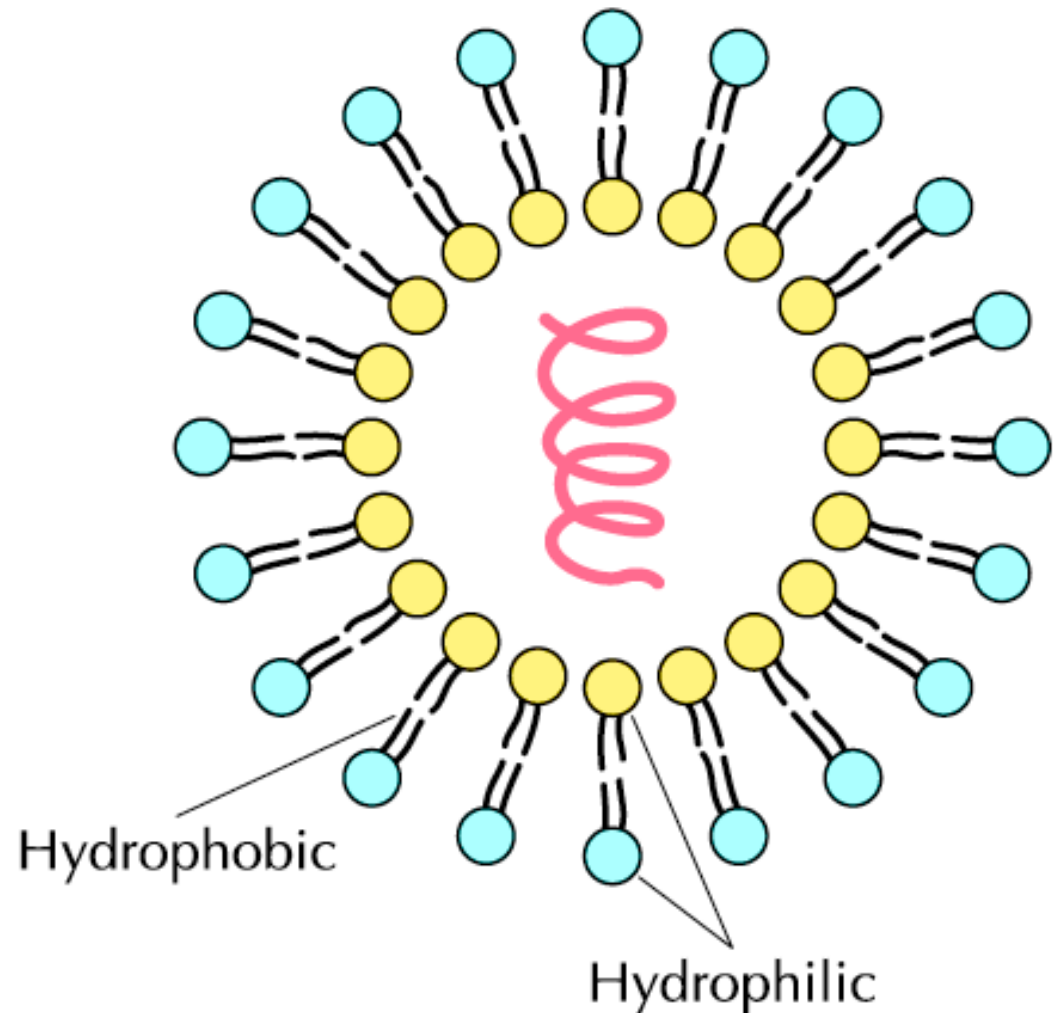

Compounds Used

fomivirsen

- 21 deoxyribonukleotides, phosphorothioate
- docosasodium salt
- sequence 5'-G-C-G-T-T-T-G-C-T-C-T-T-C-T-T-C-T-T-G-C-G-3'
- cytomegalovirus replication inhibitor: complementary to RNA of IE2 („immediate early region 2“) of HCMV, inhibits IE2 protein production and thus virus replication
- treatment of CMV retinitis in patients with AIDS
- Vitravene™ intravitreal inj. (approved in USA cca 1998 - 2001)

Compounds in Clinical Trials

Phosphorothioate oligos

alicaforfen – therapeutic of ulcerative colitis, inh. of synt. ICAM (intercellular adhesion molecule)

afovirsen – antiviral & antineoplastic – inhibitor of human papillomavirus replication

miravirsen, SPC-3649 – antiviral – anti liver-specific miRNA - hepatitis C

aprinocarsen, Affinitak™ – antineoplastic – inhibitor of protein kinase C_α - non small cells lung & breast cancer

oblimersen, Genasense® – antineoplastic - targeted to gene of Bcl2 anti-apoptotic protein – various tumours

trabedersen, AP-12009 – antineoplastic - inhibitor of overexpression of

Transforming Growth Factor β_2 (TGF β_2) – brain cancers (glioma, astrocytoma)

Compounds in Clinical Trials

Intercellular Adhesion Molecule (ICAM) Synthesis Inhibitors

Ulcerative Colitis = Inflammatory Bowel Disease (IBD) = chronic relapsing inflammatory disease of the mucose layer of the intestine

- idiopathic = ethiology is unknown
- pathogenesis is believed to be multifactorial and to include genetic, environmental and immunologic factors
- chronic inflammation is manifested namely due to dysregulation of the adaptive immunity system, which leads to a change of tolerance to intestinal bacteria and to an anomalous response to the normal luminal microflora \Rightarrow immunologic imbalance \Rightarrow \uparrow production of inflammatory cytokines and **adhesion molecules** (ICAM, MadCAM), \uparrow activation of polymorphonuclear monocytes (PMN); their migration into the intestine and interaction with the epithelium influences epithelium functions from the barrier one to electrolytes management

INTESTINAL LUMEN

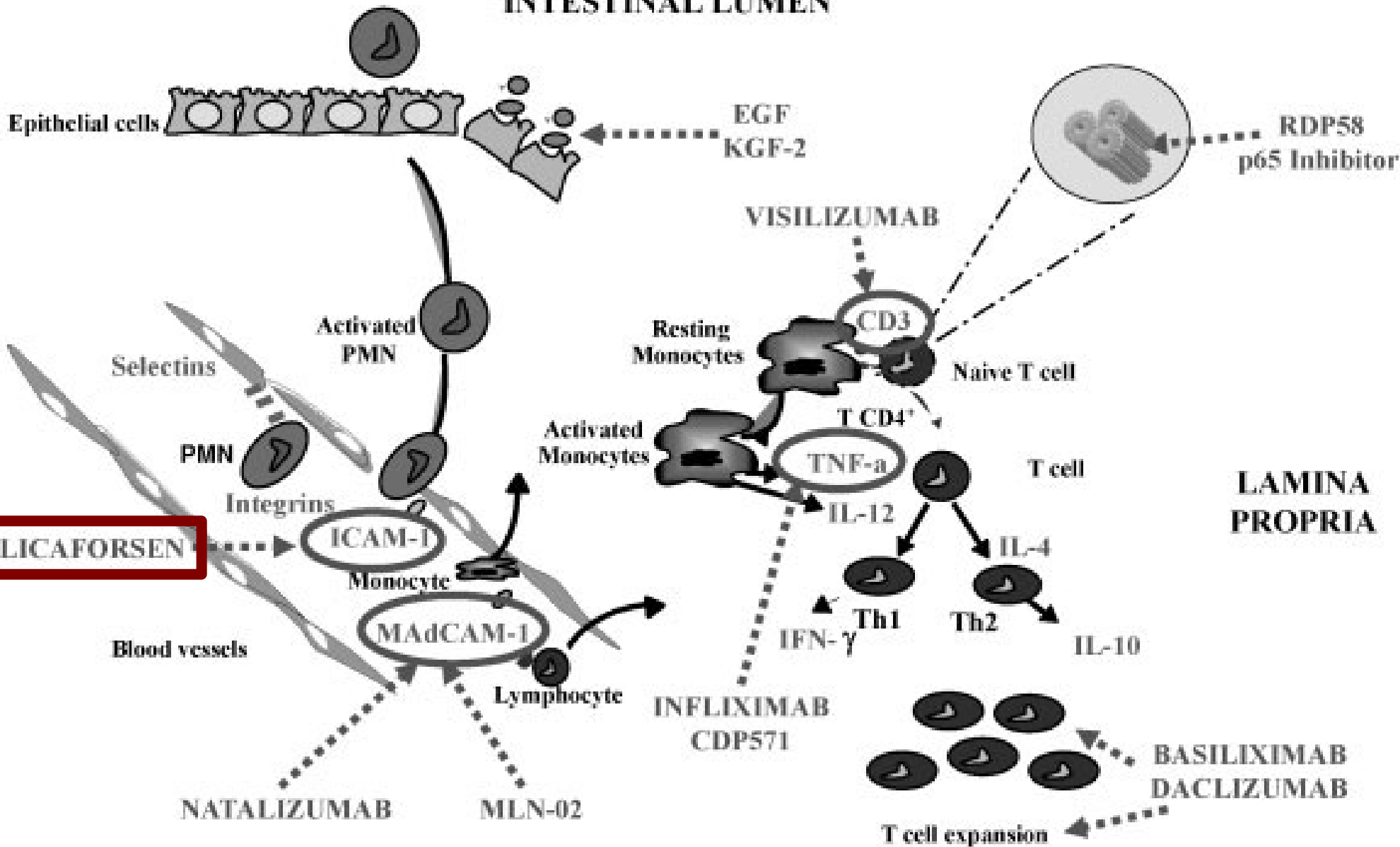

Mechanism of origin of IBD, biomolecules engage in it and therapeutic targets of selected biodrugs

ICAM-1 intercellular adhesion molecule 1

MadCAM mucous address adhesion molecule

IFN interferon

IL interleukin

EGF epidermal growth factor

PMN – polymorphonuclear monocyte

Alicaforsen

syn. ISIS 2302

- oligodeoxyribonucleotide modified by thiophosphoric acid (phosphorothioate)
- 20 bases
- binds (hybridizes) to the non-translated 3'-region of human ICAM-1 mRNA \Rightarrow activation of nuclease RNase-H \Rightarrow cleavage of the heterodimer \Rightarrow attenuation of ICAM synthesis

• phase 3 clinical tests

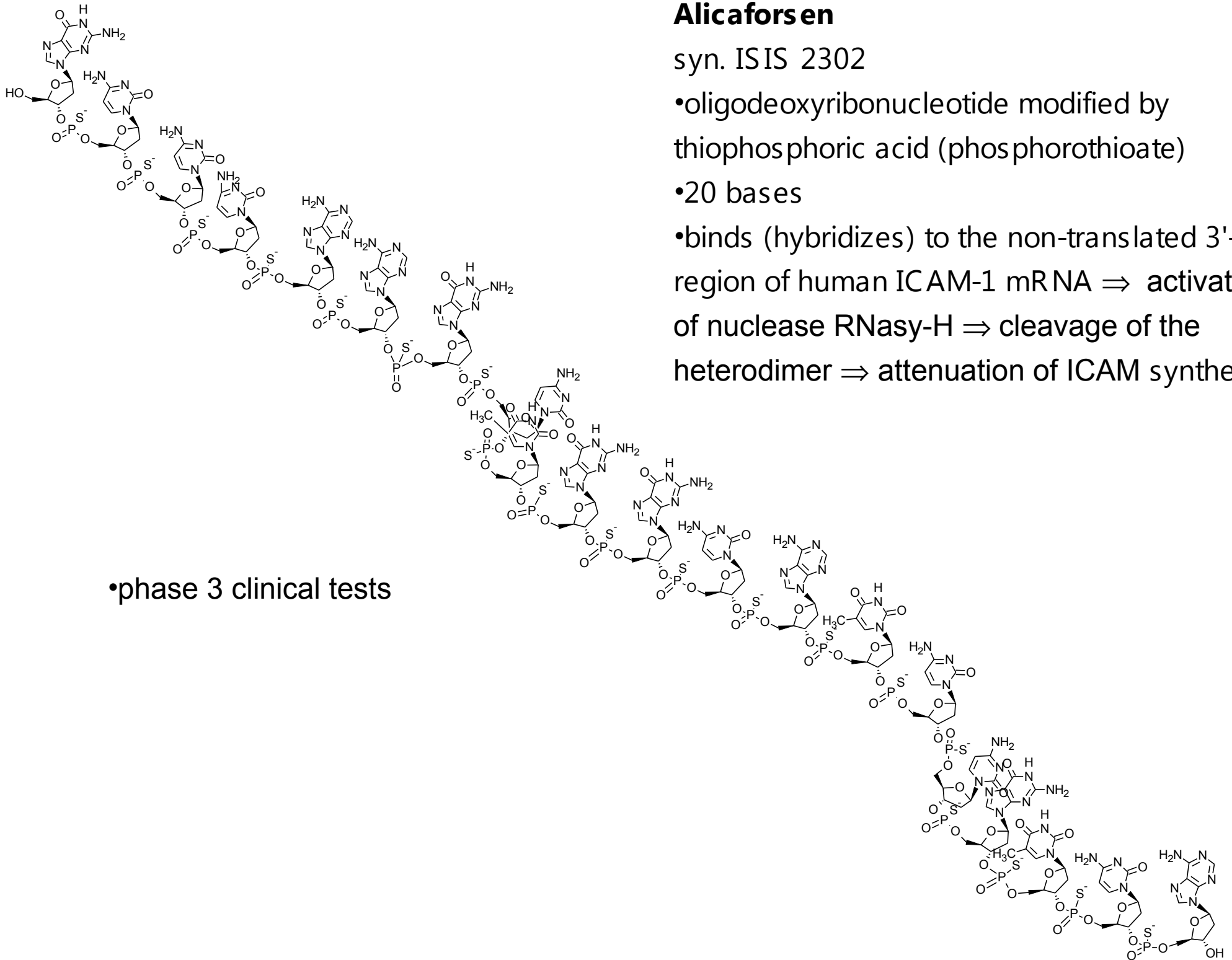

Compounds in clinical trials: antiviral agents

afovirsen, syn. ISIS 8741 – free „acid“; ISIS 2105 – nonadecasodium salt

- Sequence: ttgcttccat cttcctcgtc
- Modification: residues of phosphoric acid substituted with those of thiophosphoric acid
- Usage: treatment of human papillomavirus infections (HPV; manifestations of the infection: warts of female genitals – cervical cancer)
- mode of action: binding to viral mRNA

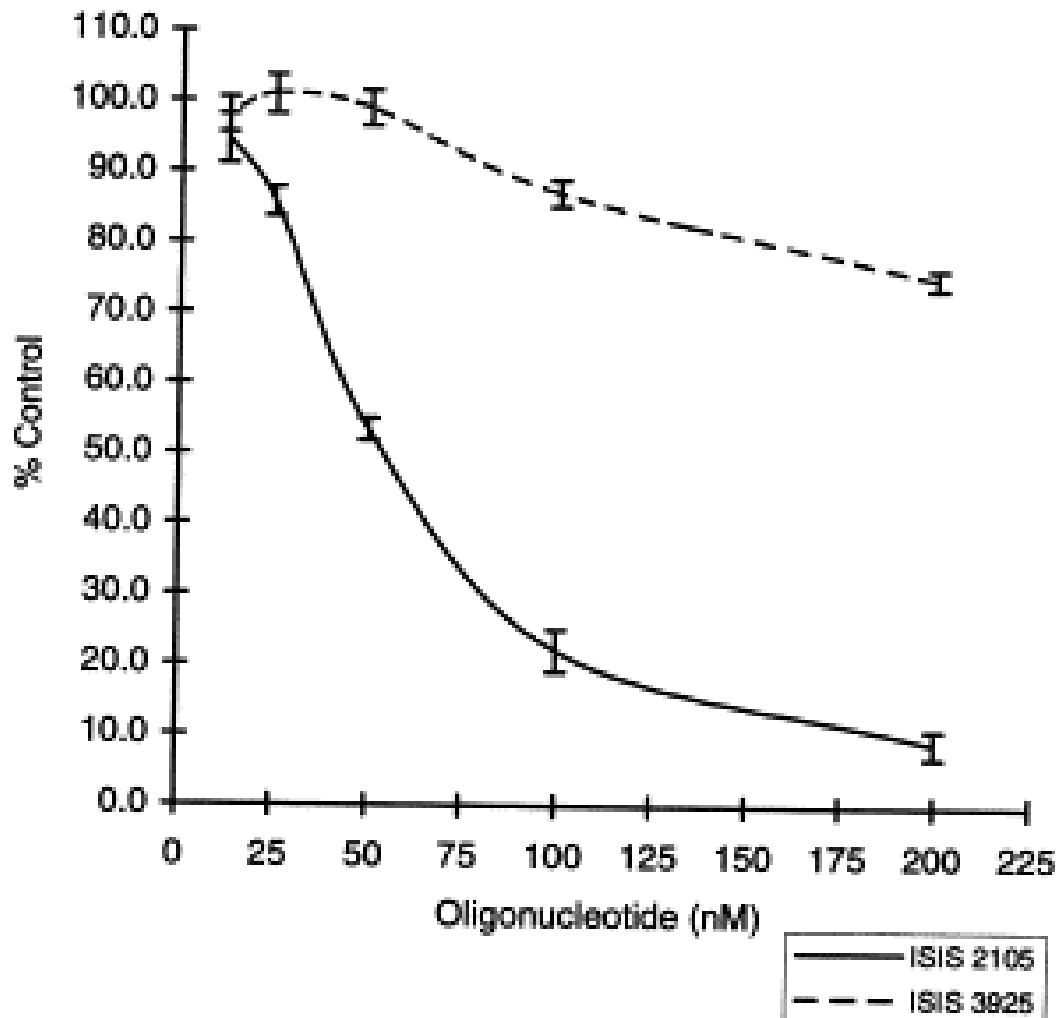

Effect of **ISIS 2105** and ISIS 3925 (20 residue phosphorothioate oligonucleotide designed to be complementary to influenza A virus) to HPV DNA replication. 24 h after infection by electroporation, cells of the line SCC-4 were treated with increasing doses of either ISIS 2105 or ISIS 3925. Cells were „harvested“ 24 h after electroporation and their HPV DNA content was determined. Data are plotted in % of untreated control experiment; mean of 3 assays.

Compounds in clinical trials: antiviral agents

miravirsen, SPC3649

•RNA, (P-thio)((2'-O,4'-C-methylene)m5C-dC-(2'-O,4'-C-methylene)A-dT-dT-(2'-O,4'-C-methylene)G-(2'-O,4'-C-methylene)m5U-dC-dA-(2'-O,4'-C-methylene)m5C-dA-(2'-O,4'-C-methylene)m5C-dT-(2'-O,4'-C-methylene)m5C-(2'-O,4'-C-methylene)m5C), sodium salt (1:14)

•16 bases, phosphorothioate groups, 8 methylene bridges between 2'-O and 4'-C atoms of ribose

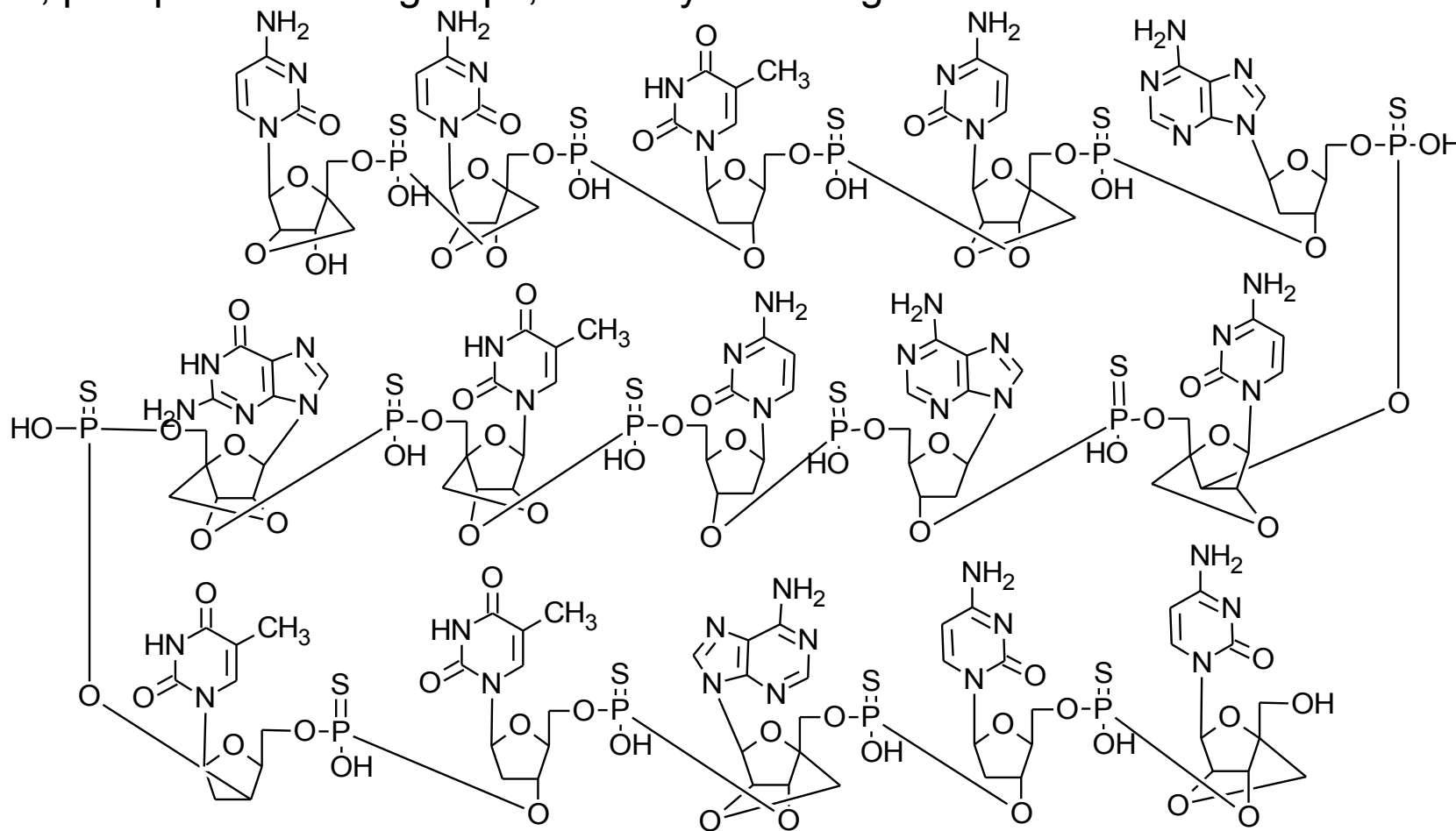

- microRNAs are short (21-23 nucleotide) non-coding regulatory RNAs that influence gene expression at a post-transcriptional level
- microRNA-122 (miR-122) is a major regulatory RNA in liver that fine-tunes the expression of over 100 cellular genes and enhances hepatitis C virus (HCV) replication through interaction with two adjacent sites downstream of stem loop I (SLI) within the HCV 5' untranslated region (5' UTR) of the viral RNA
- „locked nucleic acid“ SPC3649-induced miR-122 antagonism suppressed HCV genotype 1a and 1b infection *in vivo*
- phase 1 – 2 clinical tests against HCV infection have been finished

Compounds in clinical trials: antitumour agents

Proteinkinase C_α inhibitors

- proteinkinases C: serine-threonine kinases taking part in cell signal transduction (phosphorylation of signal molecules); their altered expression is linked with cancerogenesis

aprinocarsen, syn. ISIS 3521, LY900003, CGP 64128A

Affinitak™

- deoxyribonucleotide, 20 bases, phosphorothioate
- A-C-T-T-T-G-A-G-T-G-G-T-C-G-C-T-C-T-T-G
- phase 2 clinical tests against non-small cells lung cancer (inoperable or metastasizing) alone or combined with carboplatin, gemcitabin or paclitaxel; also against breast cancer treated previously by an other drug have been finished
- phase 3 against lung cancer: addition of aprinocarsen to gemcitabin or carboplatin has neither prolonged patients survival nor increased treatment effectiveness evaluated by other measures

Compounds in Clinical Trials

Morpholine oligos

eteplirsen, AVI-4658

- treatment of Duchenne muscular dystrophy (DMD)
- DMD: a fatal muscle degenerative disorder, caused by misreading and bad translation of DMD (dystrophin) gene to dystrophin peptide due to mutations of this gene
- 1 per 3500 newborn boys is affected
- sequence CTCCAACATCAAGGAAGATGGCATTCTAG; 30 bases; $M_r = 10369.83$
- targeted to 51. exon in dystrophine mRNA
- enables partial restoration of reading and translation of DMD gene by „patching“ of its bad splicing \Rightarrow production of truncated, but functional chain of dystrophine
- applied locally by i.m. injection
- 2 phase 2 clinical studies proceed

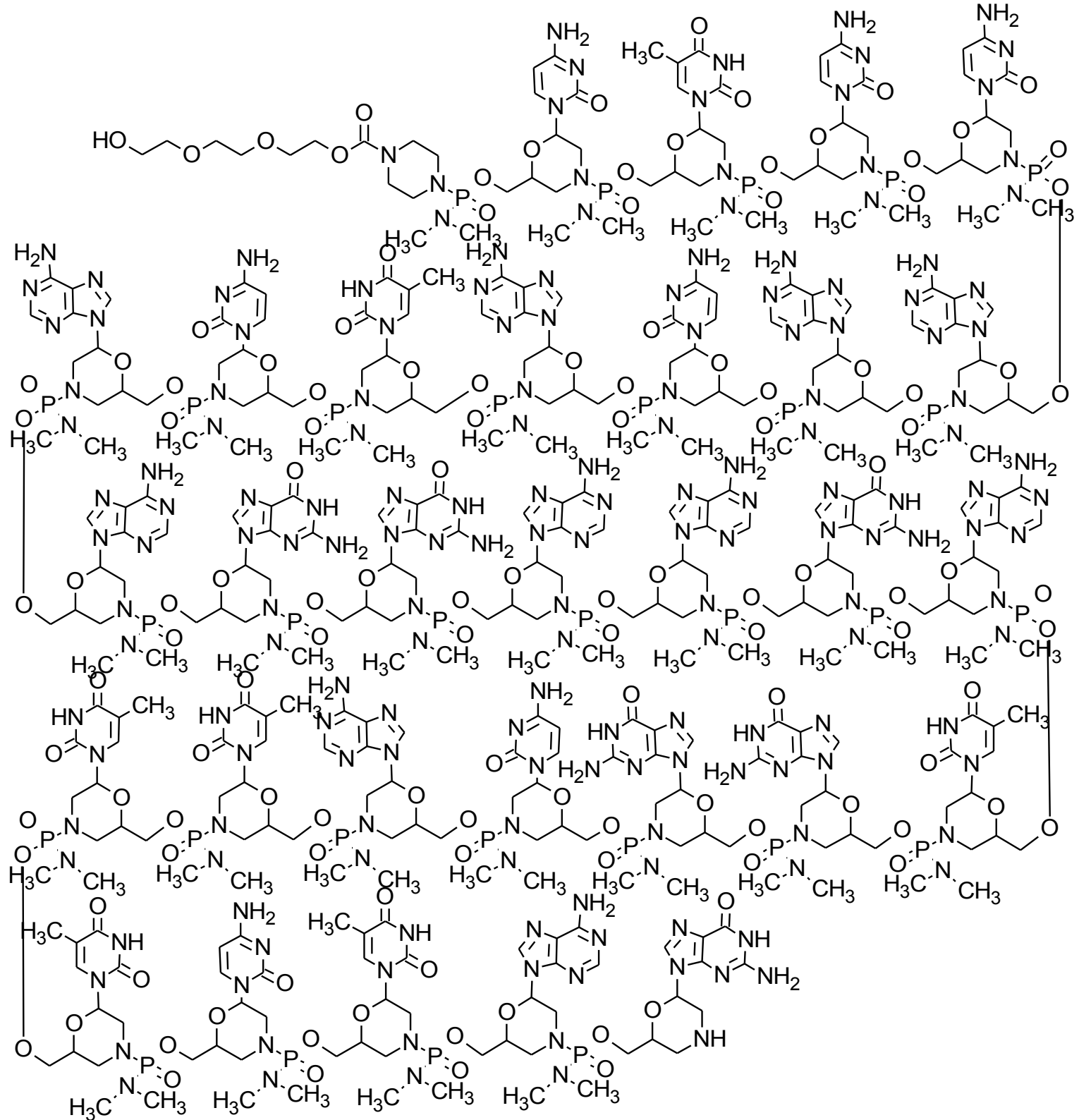

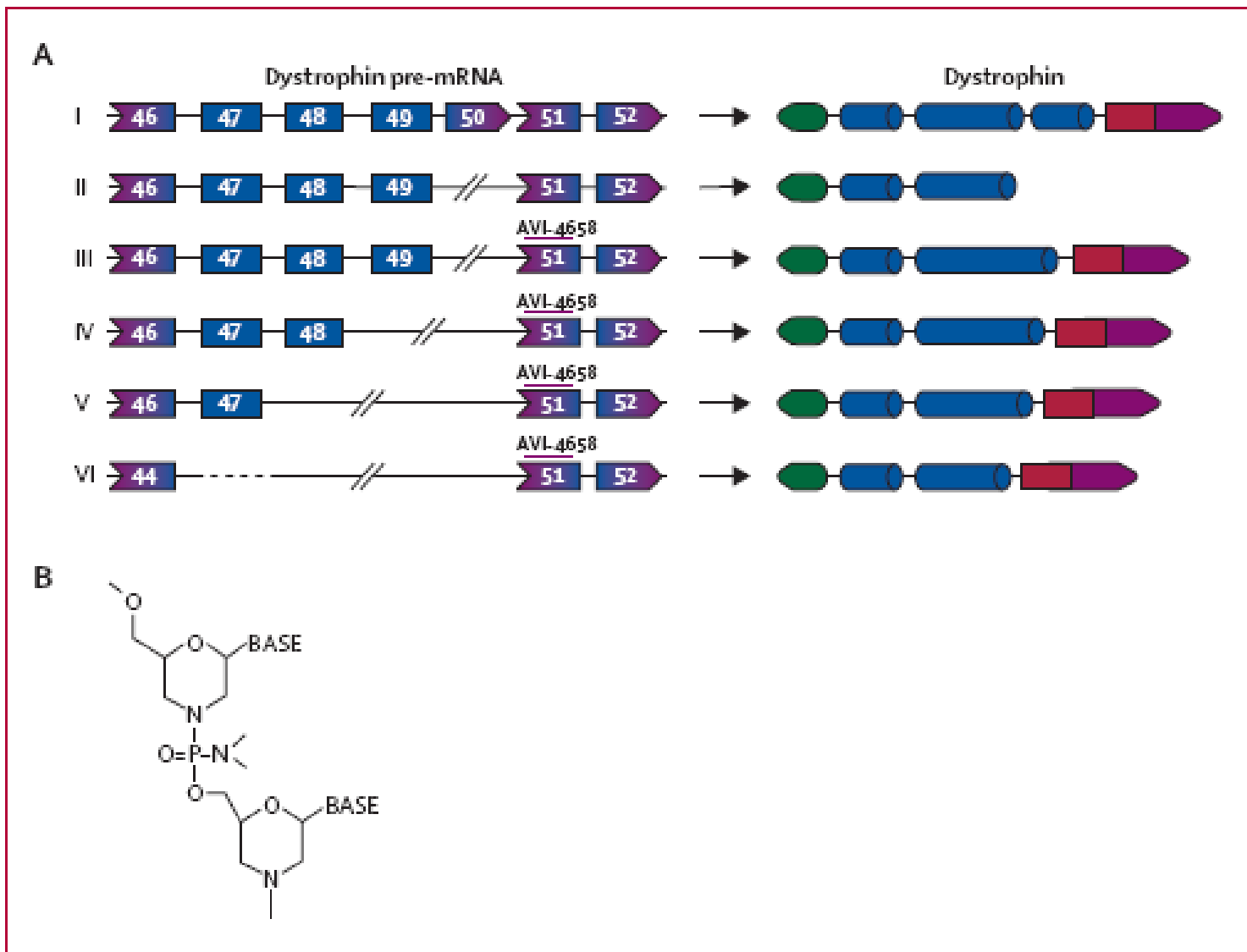

Figure 1: Deletions and predicted results of exon skipping in the patients who were studied

(A) Pre-mRNA transcripts and dystrophin protein products from full length DMD, in patients with Duchenne muscular dystrophy, and predicted protein sequences after exon skipping. (I) The normal dystrophin gene produces the full length dystrophin product. (II) Patients 1 and 2 had a deletion in exon 50 that disrupts the open reading frame, leading to a truncated and unstable dystrophin. (III) Skipping of exon 51 restores the reading frame, producing a truncated but functional dystrophin that lacks exons 50 and 51. (IV) Patient 7 is missing exons 49 and 50. (V) Patients 3 and 4 are missing exons 48-50. (VI) Patients 5 and 6 are missing exons 45-50. All the truncated dystrophins produced after skipping of exon 51 are missing the hinge 3 region and some of the rod domain but have been associated with the milder BMD phenotype.³³⁰ (B) Structure of the phosphorodiamidate morpholino modification of the antisense oligomer.

Compounds in Clinical Trials

Morpholine oligos

radavirsen, AVI-7100

- phosphorodiamidate morpholino antisense oligomer with positive charges on selected subunits; 20 nucleotide bases

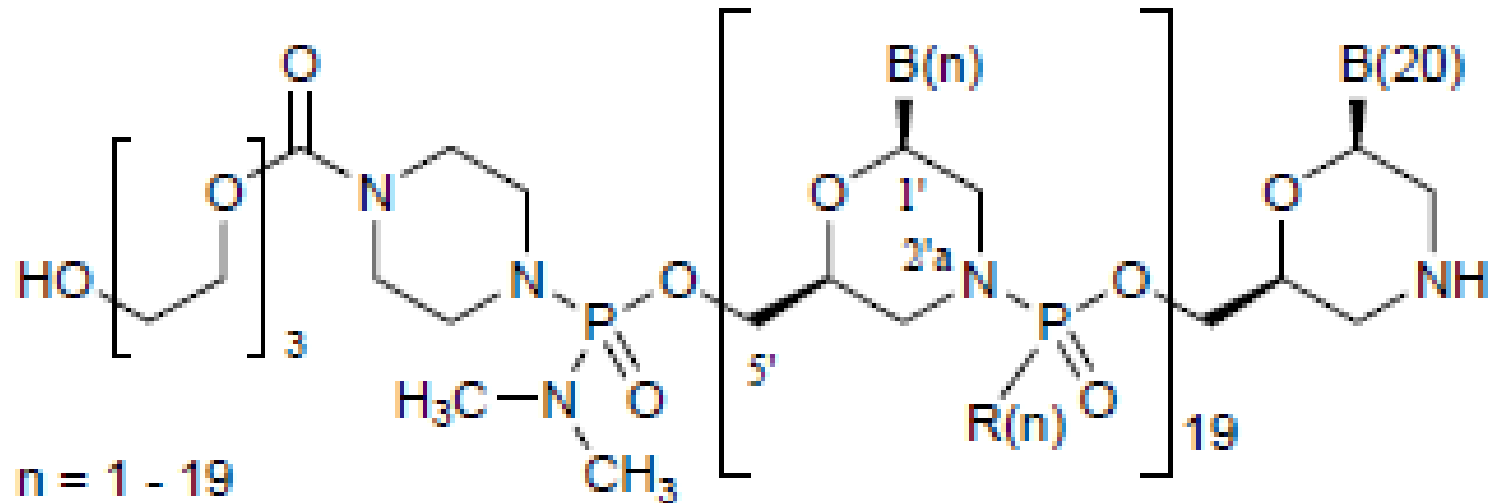

B(1-20) : C-G-G-T-T-A-G-A-A-G-A-C-T-C-A-T-C-T-T-T

R(1-3) = R(5-11) = R(13-16) = R(18) = R(19) = -N(CH₃)₂

R(4) = R(12) = R(17) = HN  N-

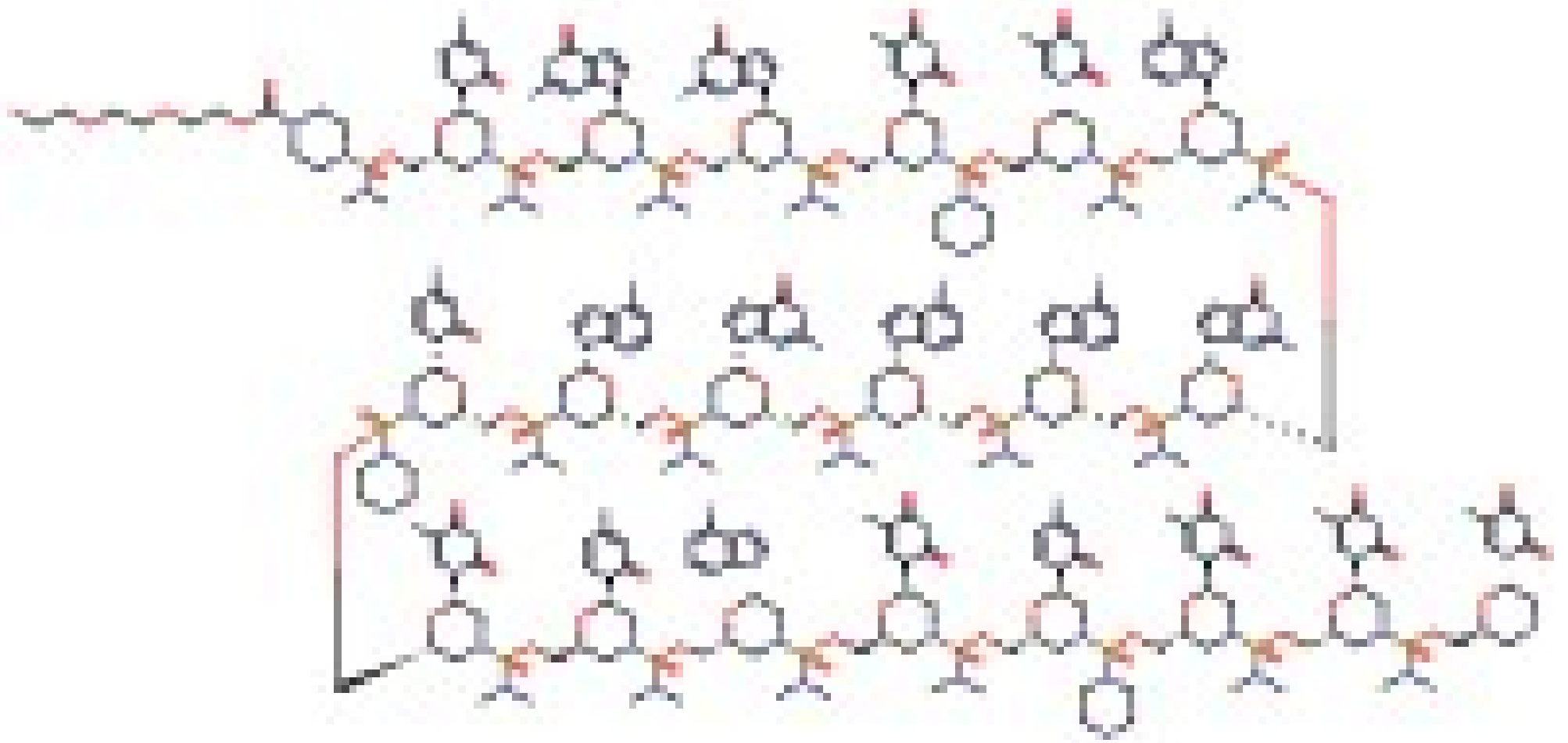

- intended for influenza A
- specifically targets viral messenger RNA sequences
- phase 1 clinical tests to characterize the safety, tolerability and pharmacokinetics of escalating single-administration doses of AVI-7100 in healthy human subjects.