



INVESTICE DO ROZVOJE VZDĚLÁVÁNÍ

Insulin(s) and other, mostly oral antidiabetics

One- and three-letter symbols of L- α -amino acid rests

One-letter	Three-letter	
A	Ala	alanine
B	Asx	asparaginic acid or asparagine
C	Cys	cysteine
D	Asp	asparaginic acid
E	Glu	glutamic acid
F	Phe	phenylalanine
G	Gly	glycine
H	His	histidine
I	Ile	isoleucine
K	Lys	lysine
L	Leu	leucine
M	Met	methionine
N	Asn	asparagine
P	Pro	proline
Q	Gln	glutamine
R	Arg	arginine
S	Ser	serine
T	Thr	threonine
U	Sec	selenocysteine
V	Val	valine
W	Trp	tryptofane
X	Xaa	unknown or „other“ amino acid
Y	Tyr	thyrosine
Z	Glx	glutamic acid or glutamine (or compounds such as 4-karboxyglutamic acid 5-oxoproline)

1. Insulines

Insuline

- Secreted mostly by β -cells of Langerhans islets of pancreas
- Enables utilisation of glucose by cells of body
- First isolated by Banting and Best from dog's pancreas in 1921

Human insuline

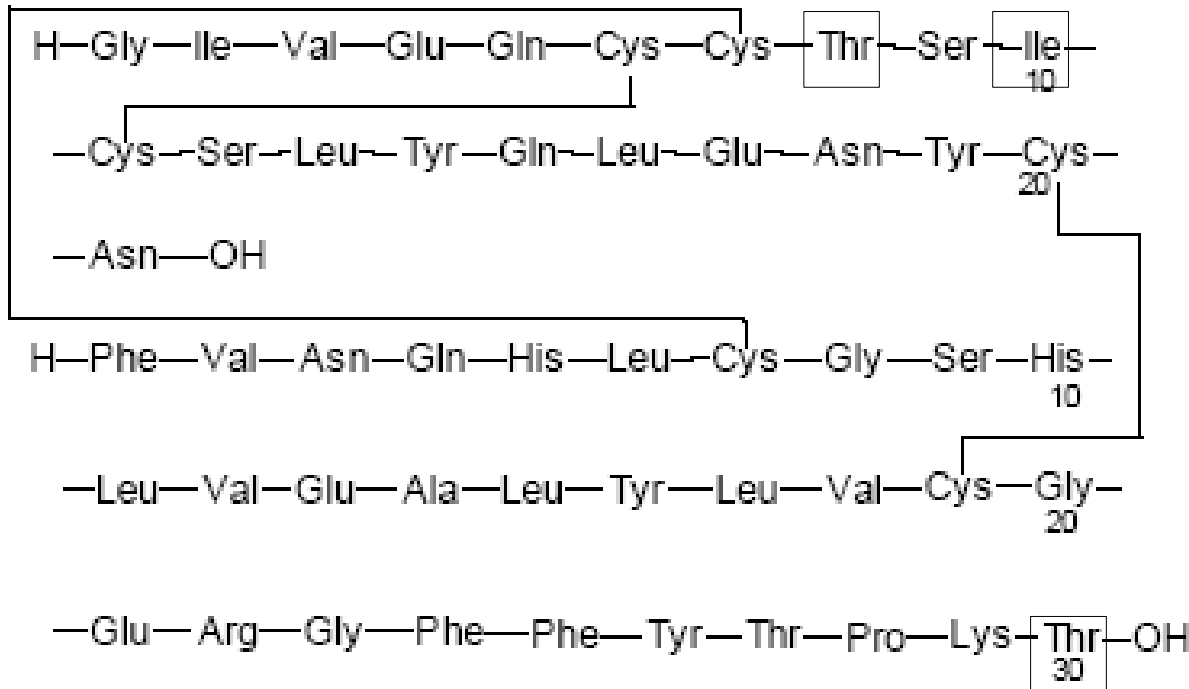
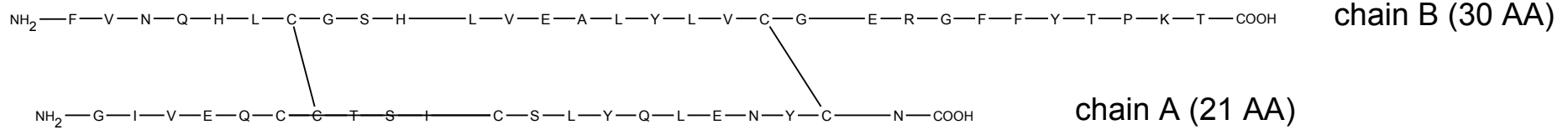

C₂₅₇H₃₈₃N₆₅O₇₇S₆

M_r 5807,60

CAS 11061-68-0

- formed from its precursor proinsuline consisted of 110 AA

10 20 30 40 50 60
MALWMRLLPL LALLALWGPD PAAAFVNQHL CGSHLVEALY LVCGERGFFY TPKTRREAED

70 80 90 100 110
LQVGQVELGG GPGAGSLQPL ALEGLQKRG IVEQCCTSIC SLYQLENYCN

1-24 signal sequence; 25-54 chain B; 57-87 peptide C; 90-110 chain A

- today produced by recombinant technology, or by partial synthesis from the porcine one

Insulinum humanum PhEur

- syn. humuline

Bovine (cow's) insuline

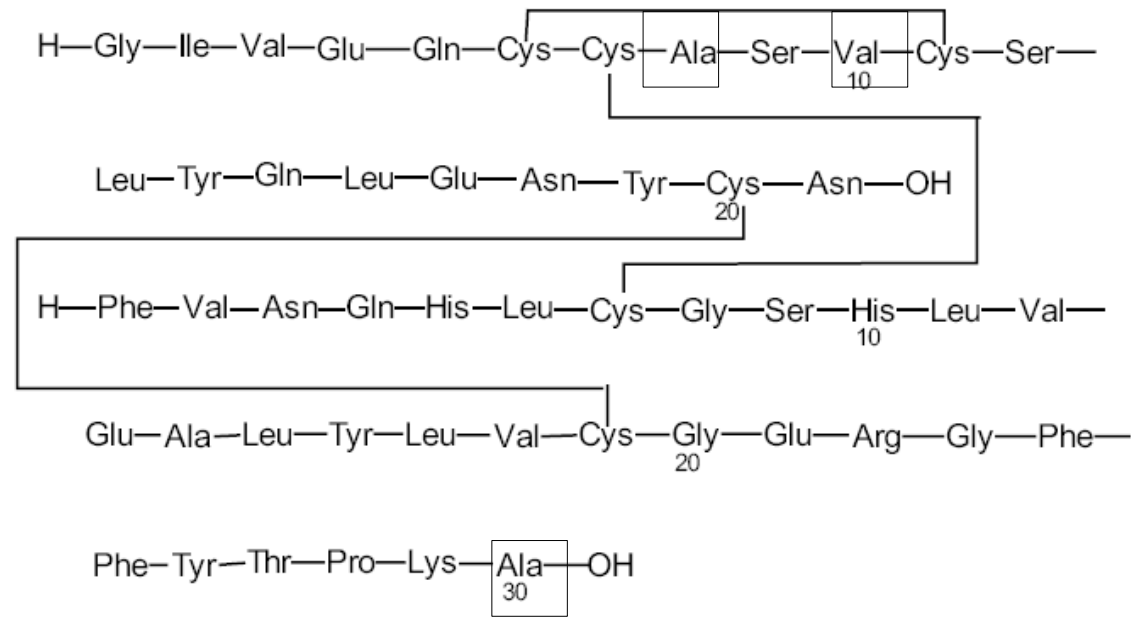

Insulinum bovinum PhEur

- isolation from beef pancreases

Porcine (swine) insuline

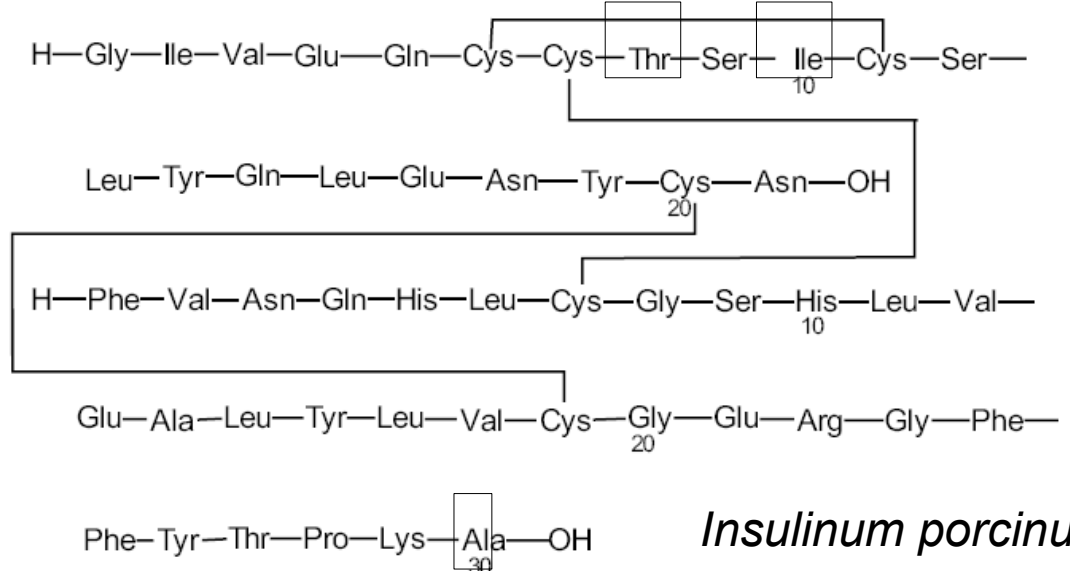

Insulinum porcinum PhEur

Insuline analogues

human

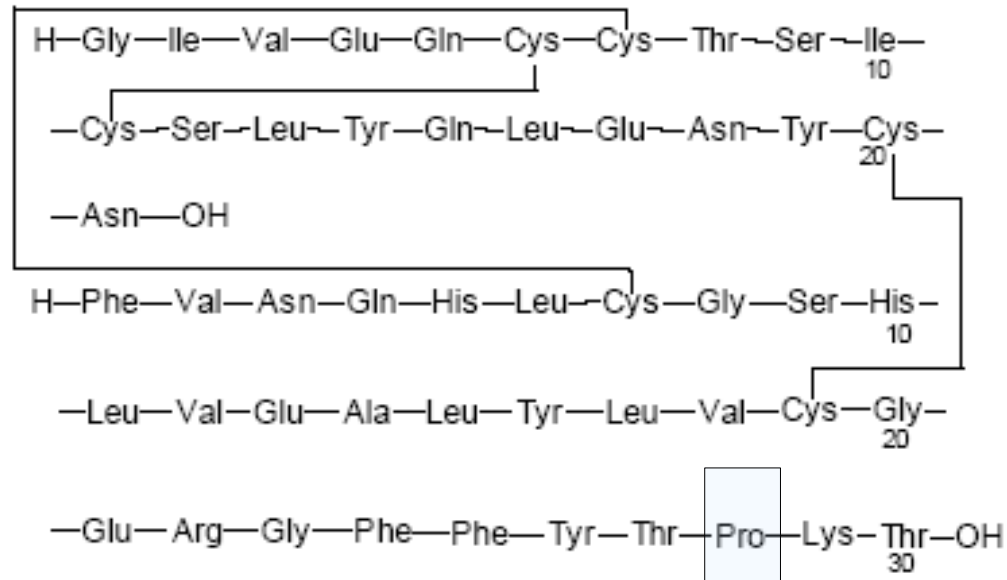

$C_{257}H_{383}N_{65}O_{77}S_6$

M_r 5807,60

CAS 11061-68-0

•recombinant technology

aspart
Insulinum aspartum
PhEur
 Novorapid®

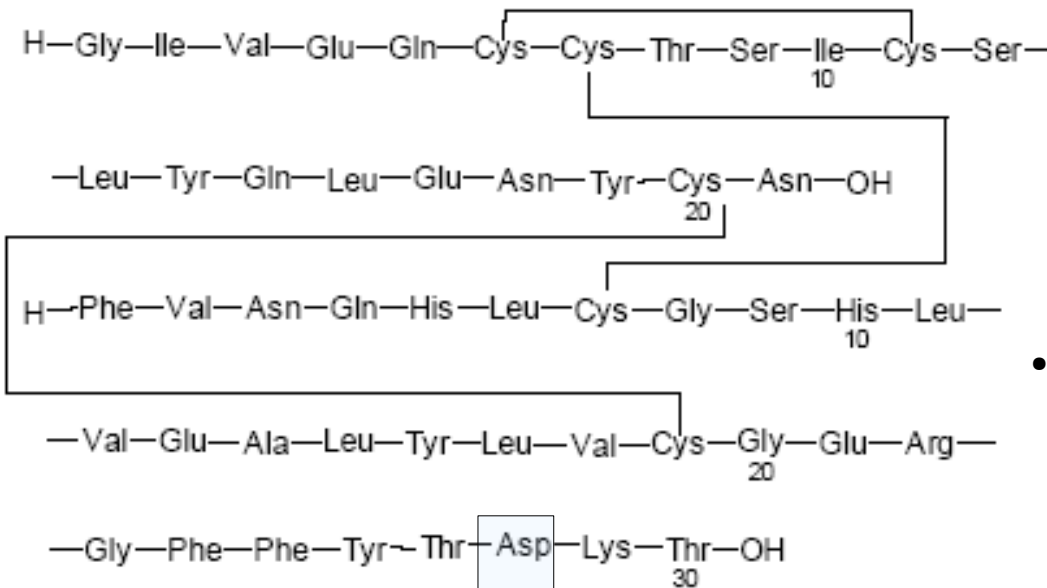

$C_{256}H_{381}N_{65}O_{79}S_6$

M_r 5825,58

CAS 116094-23-6

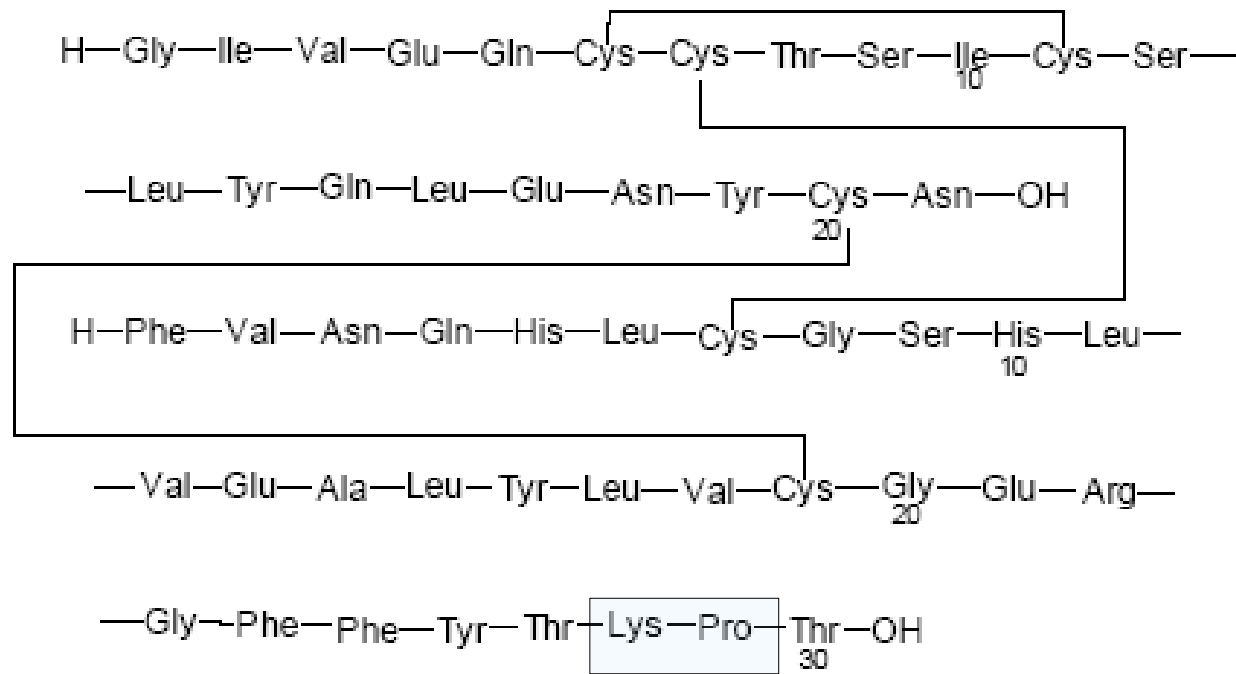

$C_{257}H_{383}N_{65}O_{77}S_6$

M_r 5807,61

CAS 133107-64-9

insulin-lispro

Insulinum lisprum PhEur

•recombinant

Humalog ®, Liprolog ®

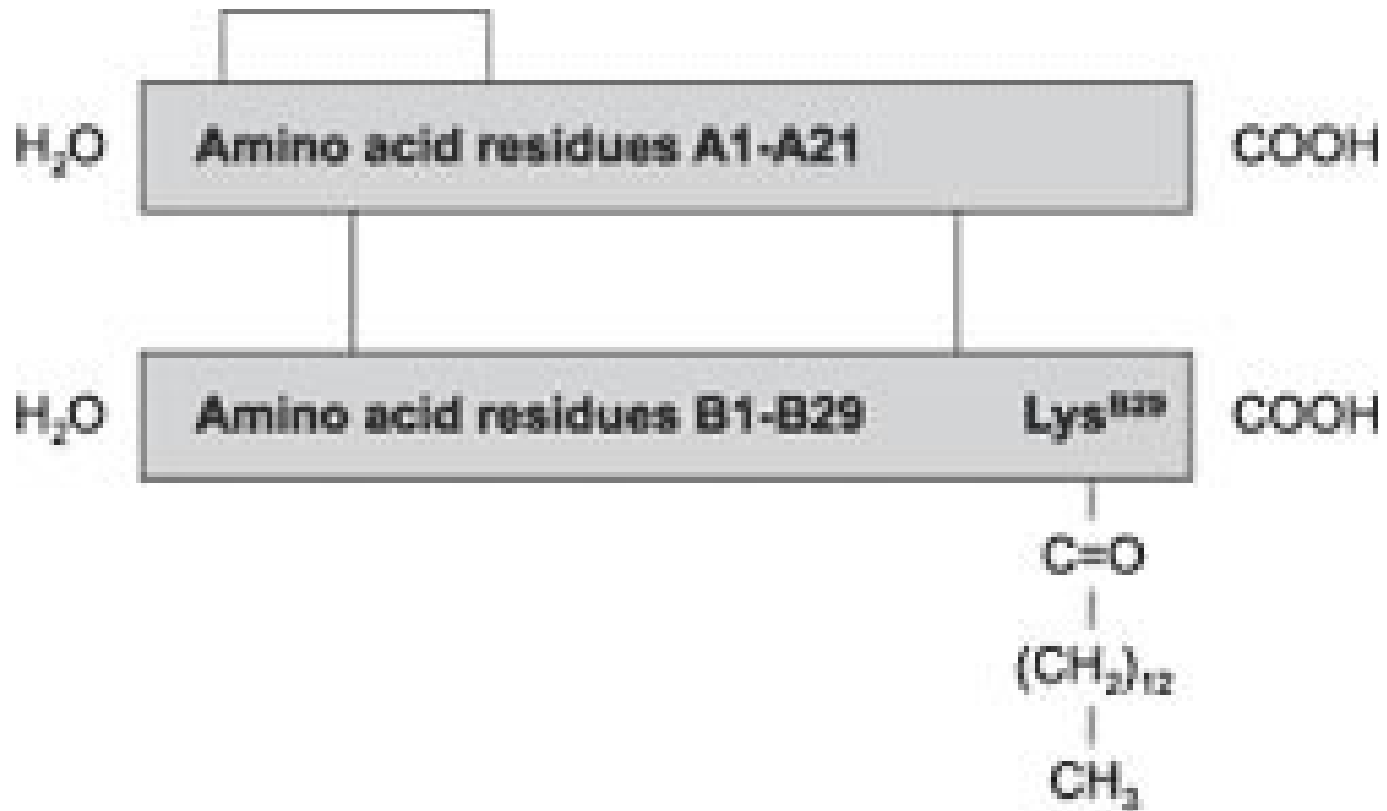

insulin-detemir

- chain B has only 29 AA, tetradecanoyl (myristoyl) attached to Lys^{B29}
- recombinant-semi synthetic

Levemir ®

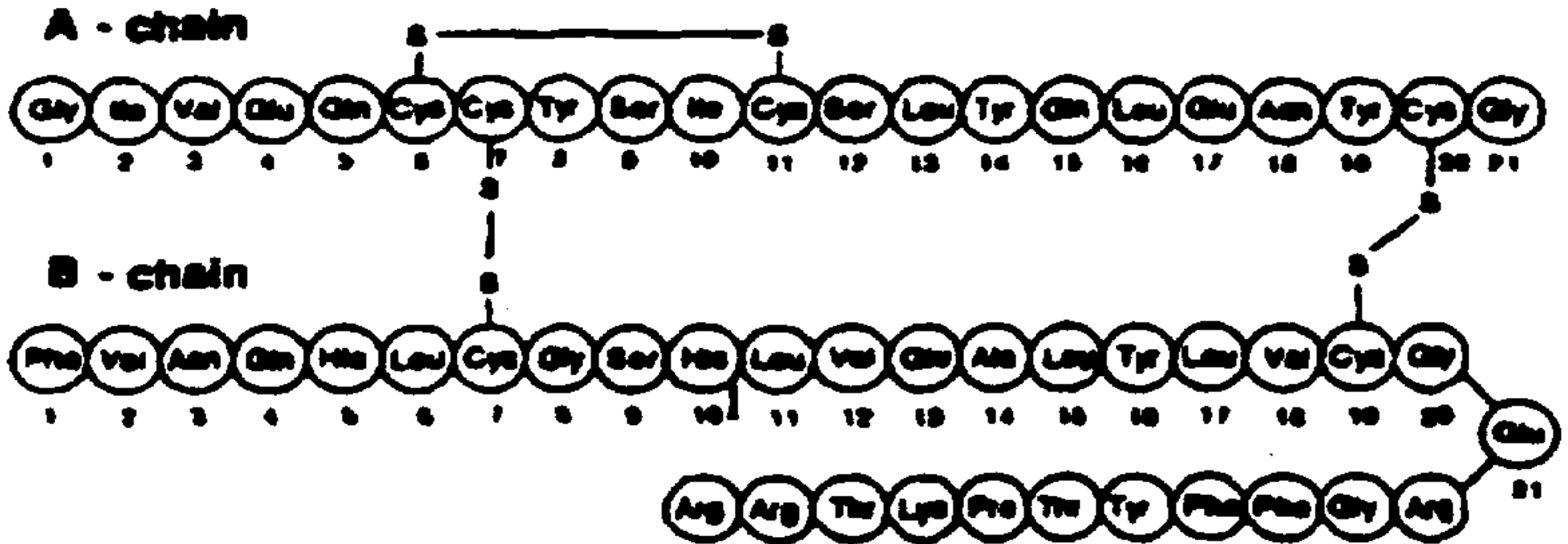

insulin-glargin

Gly^{21A}-L-Arg^{30B}-L-Arg^{31B}-insulin

Lantus[®], Optisulin[®]

- insulin of 1st choice in diabetes of 2nd type when oral antidiabetics are not satisfactory
- long $T_{1/2}$, typically administered 1x daily s.c. before sleeping

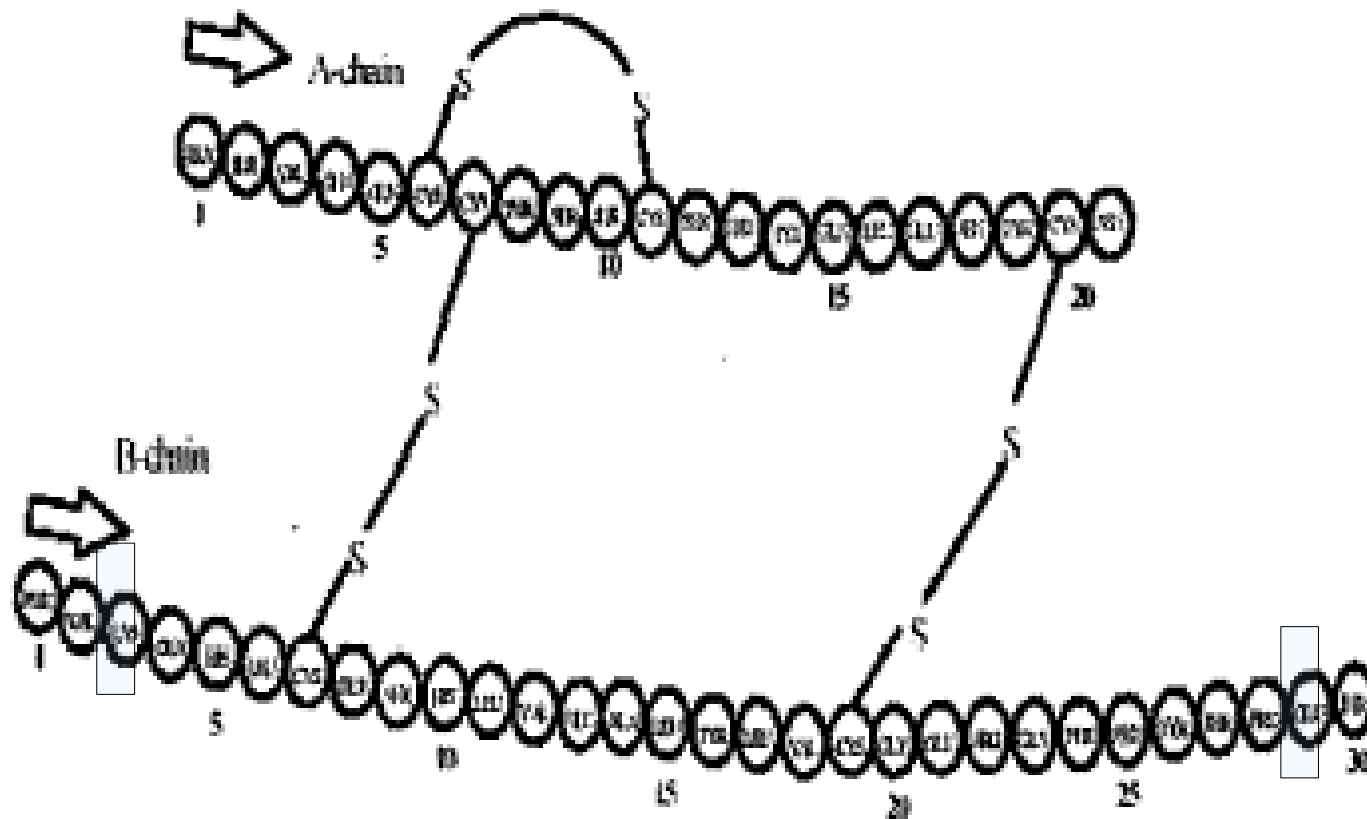

Chemical name: 3βLys-29βGlu-human insulin

CAS registry number: 207748-29-6

Molecular formula/molecular weight: $C_{258}H_{384}O_{78}N_{64}S_6/5823$

insulin-glulisin

Apidra ®

Summary of the used insulin analogues

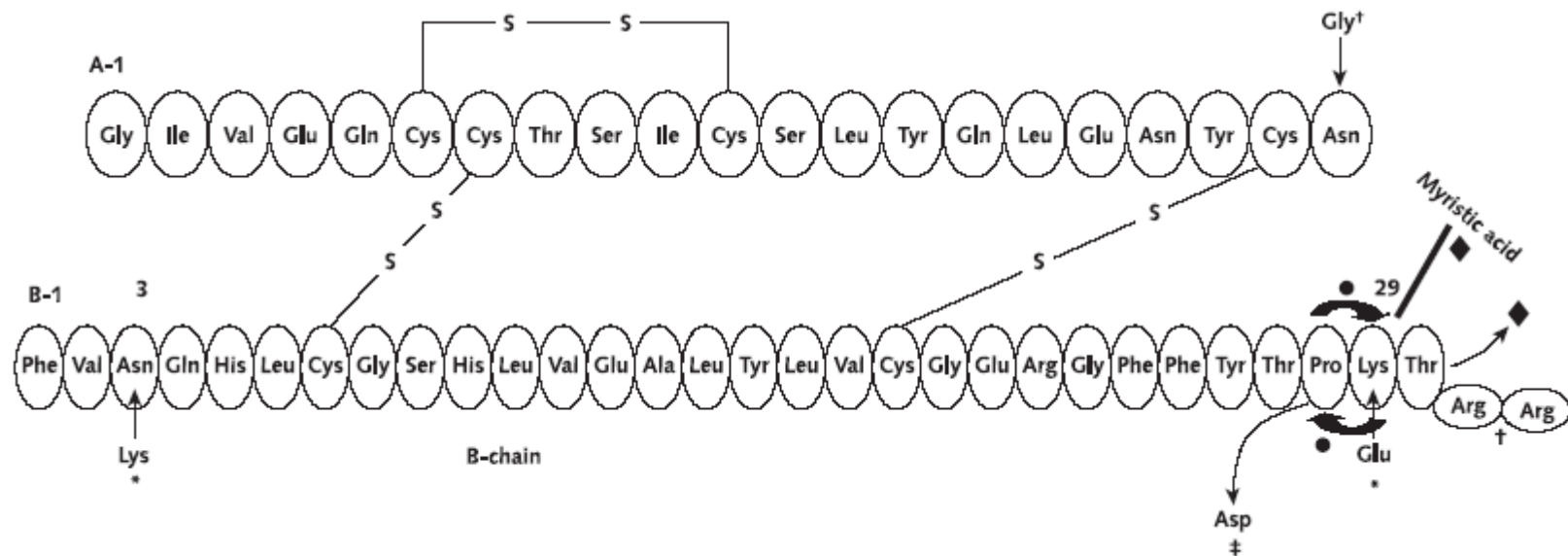

● = Insulin lispro differs from human insulin by the substitution of proline with lysine at position 28 and the substitution of lysine with proline at position 29 of the insulin β chain.

‡ = Insulin aspart is designed with the single replacement of the amino acid proline by aspartic acid at position 28 of the human insulin β chain.

* = Insulin glulisine is designed with the substitution of the amino acid lysine with asparagine at position 3 of the human insulin β chain and by substitution of the amino acid lysine at position 29 with glutamine.

† = Insulin glargine differs from human insulin in that the amino acid asparagine at position A21 is replaced by glycine and 2 arginines are added to the C-terminus of the β chain.

◆ = Insulin detemir is designed to bind albumin in plasma after absorption. Threonine is omitted from position 30 of the insulin β chain and replaced by myristic acid, a C14 fatty acid chain.

Figure reprinted with permission from reference 2: Oiknine R, Bernbaum M, Mooradian AD. A critical appraisal of the role of insulin analogues in the management of diabetes mellitus. *Drugs*. 2005;65:325-40. [PMID: 15669878]

Glucagone

- adversary of insulin
- peptid consisted of 29 AA from pancreas α -calls supporting cleavage of liver glycogene and increasing glycaemia
- causes relaxation of smooth gastric muscules similarly to cholinergics

H—His—Ser—Gln—Gly—Thr—Phe—Thr—Ser—Asp—Tyr—
10

Ser—Lys—Tyr—Leu—Asp—Ser—Arg—Arg—Ala—Gln—
20

Asp—Phe—Val—Gln—Trp—Leu—Met—Asn—Thr—OH

$C_{153}H_{225}N_{43}O_{49}S$

M_r 3482,78

CAS 16941-32-5

Glucagonum PhEur

- isolated from porcine or bovine pancreases

Glucagonum humanum PhEur

- produced by recombinant technology; AA sequence is identical
- usage: treatment of serious hypoglycaemia, X-ray GIT diagnostic etc.

Sulfonylurea derivatives

- 1942 hypoglycaemic side effect of antibacterial sulfonamides discovered
- 1955 carbutamide as 1st p.o. antidiabetic introduced

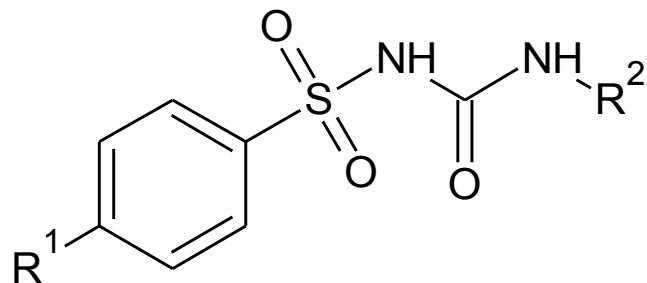

common is struct. fragment of 1-benzenesulfonylurea subst. in the position 4 of the benzene ring and on the N³ of urea

R¹ = -H or anything

R² = alkyl, cycloalkyl, heterocycle with max. 10 non-hydrogen atoms

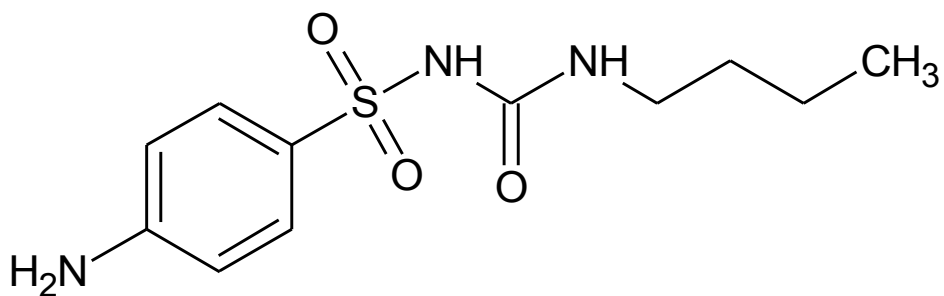

carbutamide

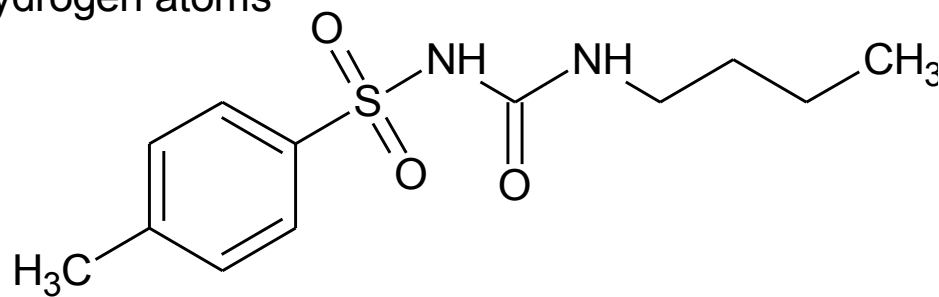

tolbutamide

Sulfonylurea derivatives

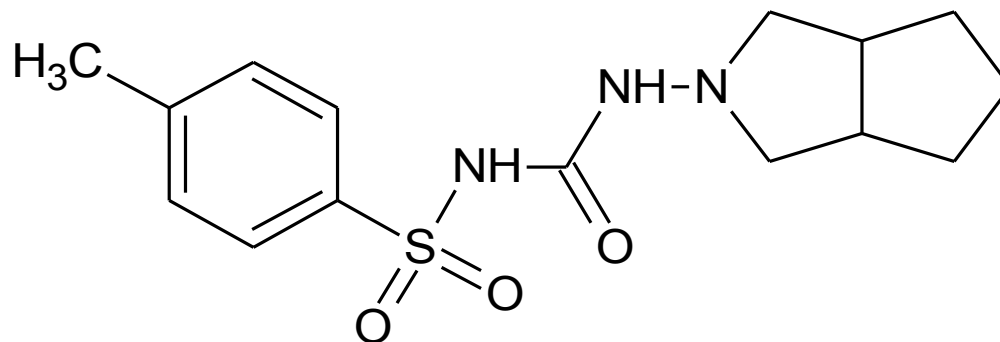

1-(3-Azabicyclo[3.3.0]oct-3-yl)-3-(*p*-tolylsulfonyl)urea

gliclazide

Diaprel MR ®

- antiradical effects
- ↓ reactivity of platelets, ↑ synthesis of prostacyclin in endothel and fibrinolysis
- improves plasmatic antioxidant parameters (SOD, total antioxidant capacity, thiols)
- probably a result of the presence of 3-azabicyclo[3.3.0]octane moiety

Sulfonylurea derivatives of 2nd generation

- first prepared in 1970th, enabled ↓ dosing g → mg
- result of introducing of carbonylaminoethyl fragment into position 4 of the benzene ring

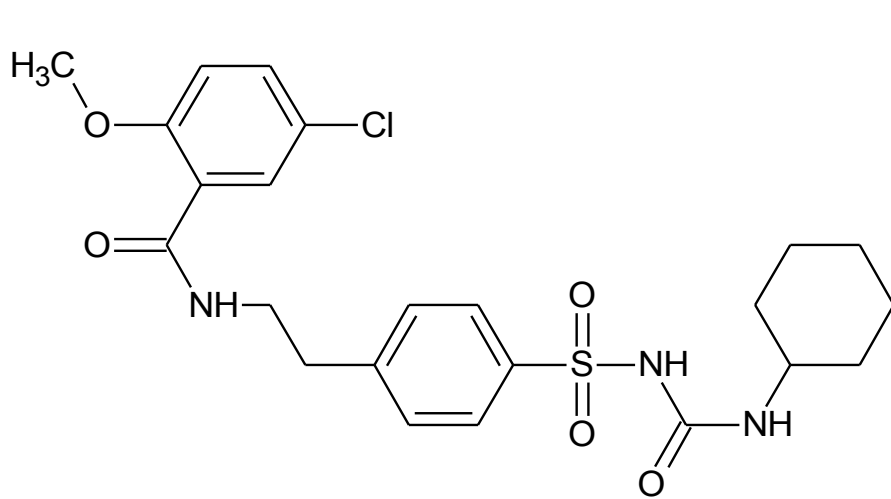
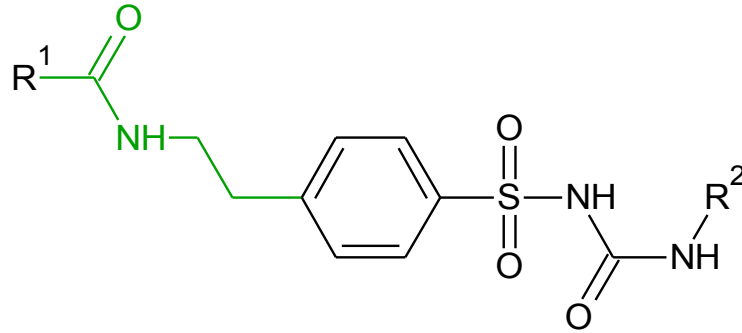

glibenclamide

Glucobene ®

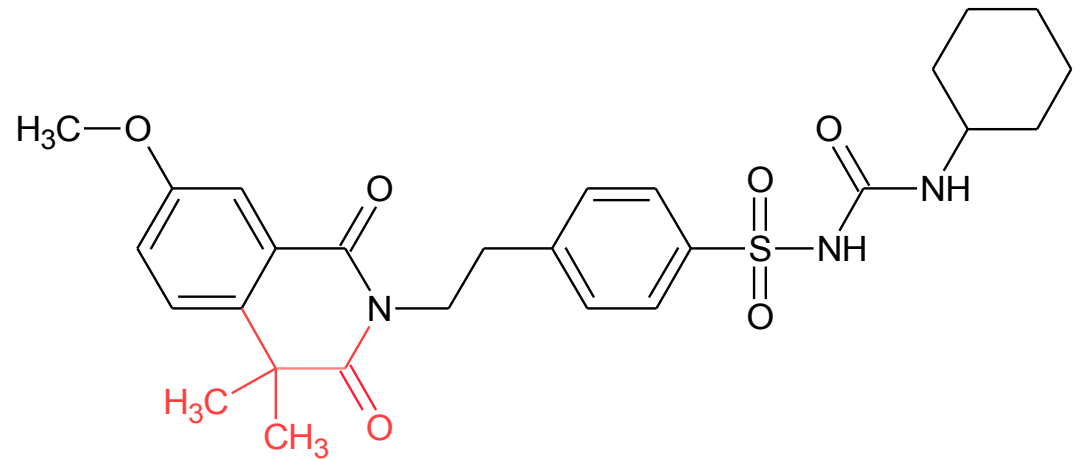

gliquidone

Glurenorm ®

- an *in vitro* evidence of PPAR_γ receptor stimulation given; as active as pioglitazone in induction of the PPAR_γ target gene expression

Sulfonylurea derivatives of 2nd generation

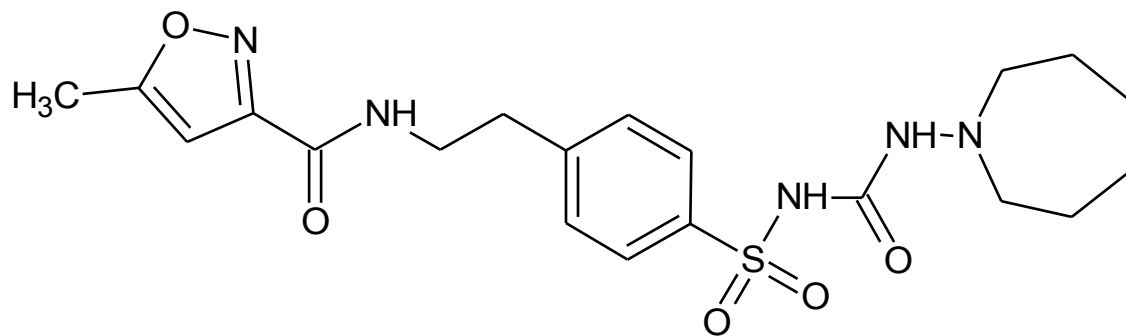

glisoxepide

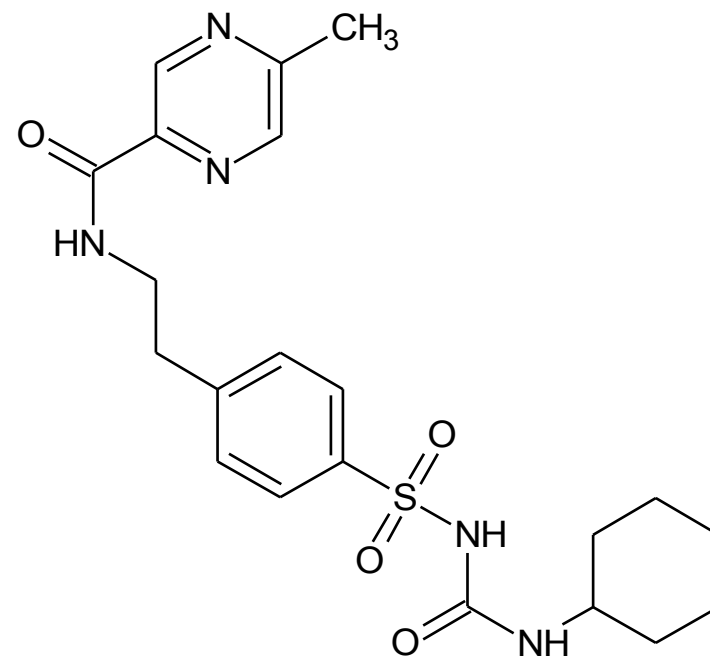

glipizide

Minidiab®

Sulfonylurea derivatives of 3rd generation

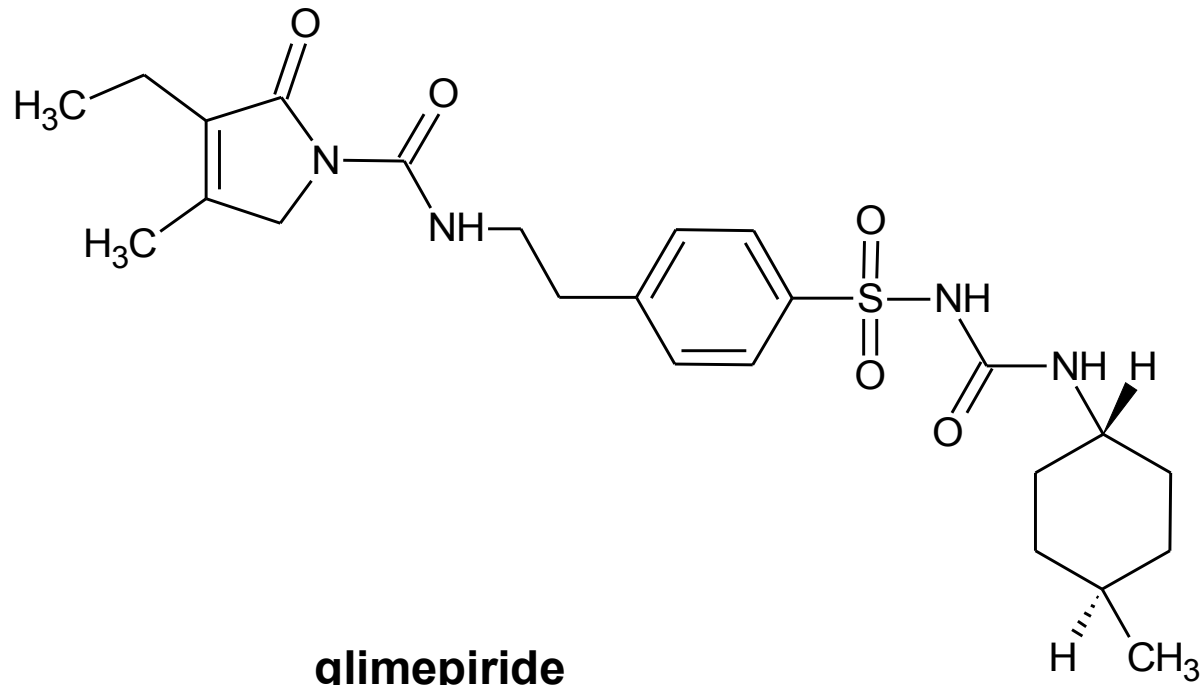

Amaryl ®

Mode of action of sulfonylureas: binding to sulfonylurea receptor, which is a part of K⁺-ATP complex ⇒ channel closure ⇒ changes of voltage of β-cells membranes ⇒ influx of Ca²⁺ ⇒ exocytosis of insulin granules

Adverse effects:

- interference with K⁺-ATP channels of the myocard ⇒ impairing of its function
- further development of hypoglycaemia
- enhancement of apoptosis and exhaustion of β-cells.

Glinides

- structurally relatively heterogenous group
- mode of action** similar to that of sulfonylureas (binding to the same receptor): ↓ conductivity of membranes of β -cells mediated by K^+ \Rightarrow depolarisation of membranes and opening of voltage-gated Ca^{2+} channels \Rightarrow ↑ intracellular concentration of Ca^{2+} \Rightarrow ↑ release of insulin granules
- stimulation of $PPAR\gamma$ receptor demonstrated *in vitro* also

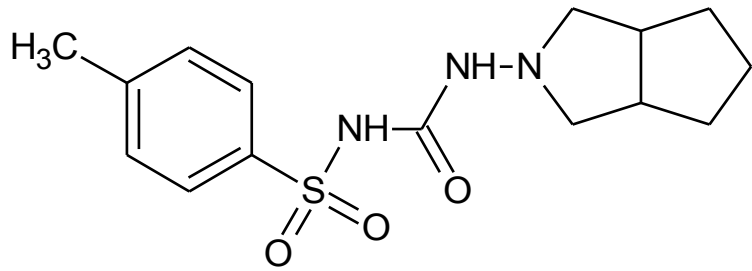

gliclazide

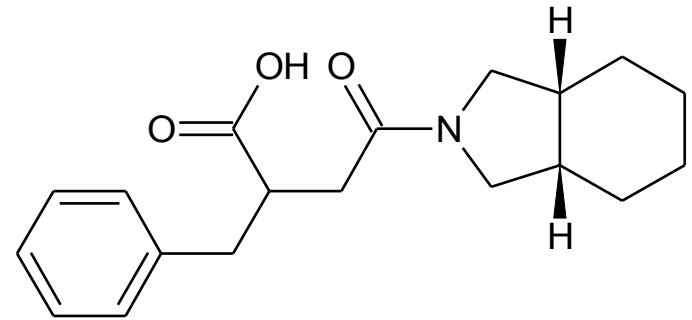
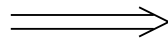

2-benzyl-4-[(3aR,7aS)-octahydro-2H-isoindol-2-yl]-4-oxobutanoic acid

mitiglinide

- 1st glinide

Glinides

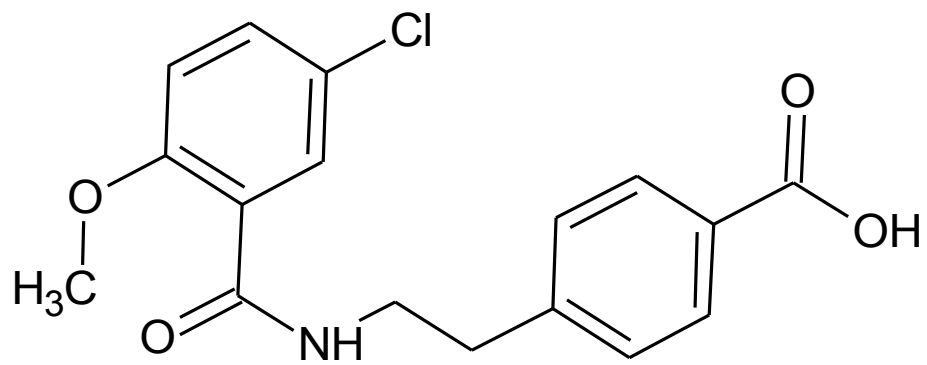

meglitinide

Glinides

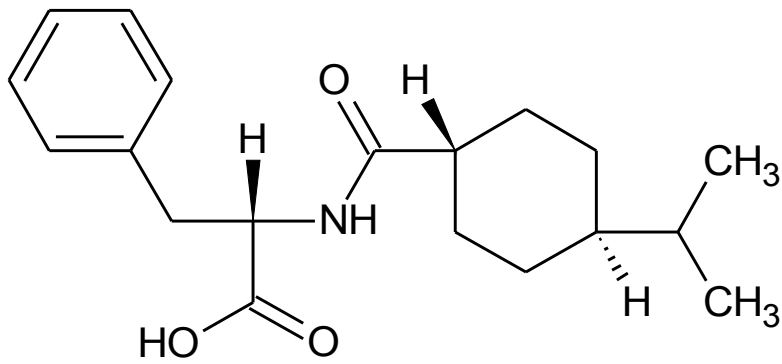

nateglinide

Starlix ®

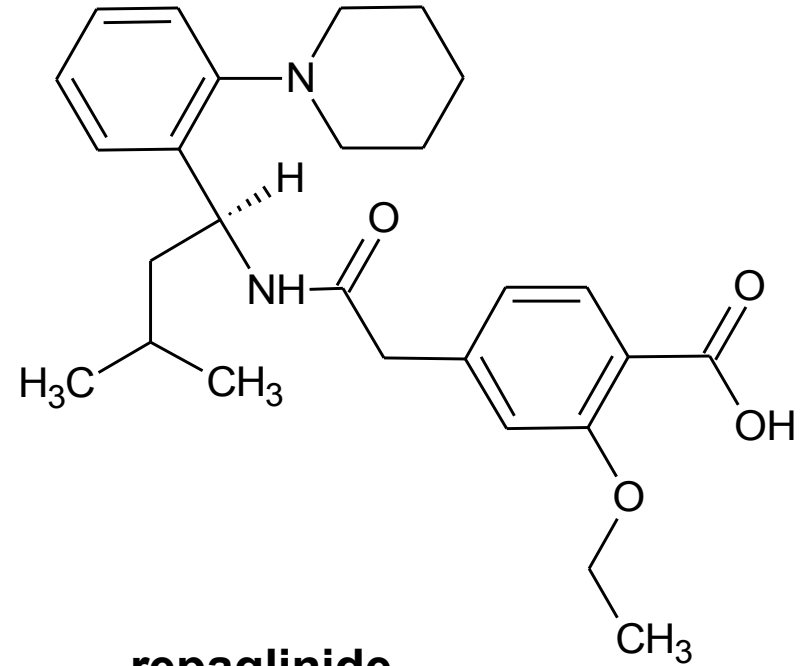

repaglinide

Novonorm ®

- probably prolong the life of β -cells
- reduce postprandial \uparrow glycaemia in patients with worsened glucose tolerance \Rightarrow slow down thinning of *intima media* of carotids
- positive effect on triglycerides and free fatty acids levels in plasma of diabetics of 2nd type 120 min after meals

Biguanide derivatives

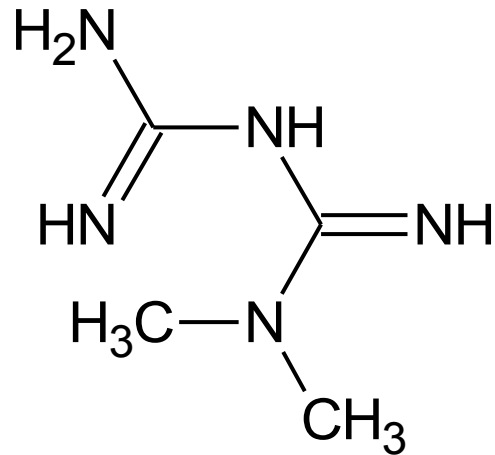

1,1-dimethylbiguanide

Adimet®

metformin

- also cardioprotective effect; improves also conditions in chronic heart failure probably by means of activation of AMP-activated protein kinase (AMPK) and subsequently endothelial nitric oxide synthase (eNOS) and co-activator of PPAR γ receptor (PGC-1 α)

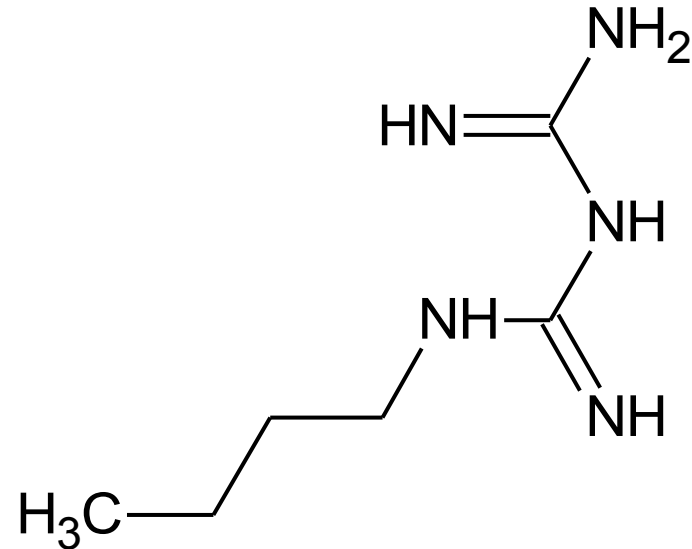

1-butylbiguanide

buformin

Biguanide derivatives

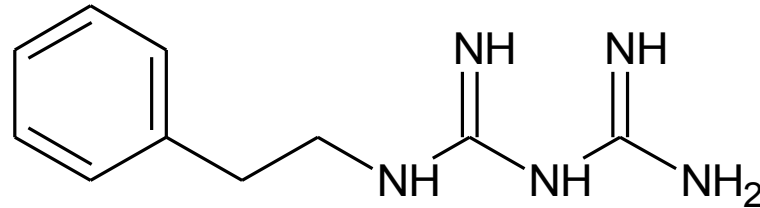

1-(2-phenylethyl)guanidine
fenformin

Effects of biguanides:

- obsolete in humans; causes strong lactate acidosis
- ↓ glucose synthesis in liver by gluconeogenesis
- ↑ utilisation of glucose in peripheral organs
- ↓ fatty acids oxidation about 10 – 20 %

Mode of action: activation of AMPK (AMP-activated protein kinase; in absence of insulin, biguanides renew uptake of glucose in insulin-resistant cardiomyocytes by complementary activation of AMPK and protein kinase B; this was demonstrated also in hepatocytes and cells of skeletal musculature

•target site of gluconeogenesis inhibition: glyceraldehyde-3-phosphate reductase; biguanides inhibit expression of the gene for this enzyme

Unwanted effects: lactate acidose: ↓ gluconeogenesis ⇒ accumulation of pyruvate and NADH, ↓ NAD⁺ ⇒ (lactate dehydrogenase) ⇒ ↑ lactate productin

Compounds interacting with PPAR receptors

PPAR = peroxisome proliferator- activated receptors – a family of receptors of the cell nucleus directly linked to DNA

- sensitive to fatty acids; cause changes of transcription, which alter utilisation (catabolism) of fatty acids and glucose

- activities of the particular subtypes of PPARs take part in regulation of sensitivity to insulin and obesity symptoms and also in food intake control

- activation of PPAR_α ↑ lipolysis and fatty acids oxidation; these receptors take part in the mode of action of fibates

- PPAR_γ receptors = key regulators of insulin resistance; take also part in activation of adipocytes differentiation, ↑ adipogenesis and thus body weight

PPAR_δ (=PPAR_β) receptors are engaged in the process of development of obesity, which is caused by improper alimentation

- PPAR agonists are useful as p.o. antidiabetics**, partial selective agonists of PPAR_γ are the most suitable ones

Thiazolidindiones (glitazones)

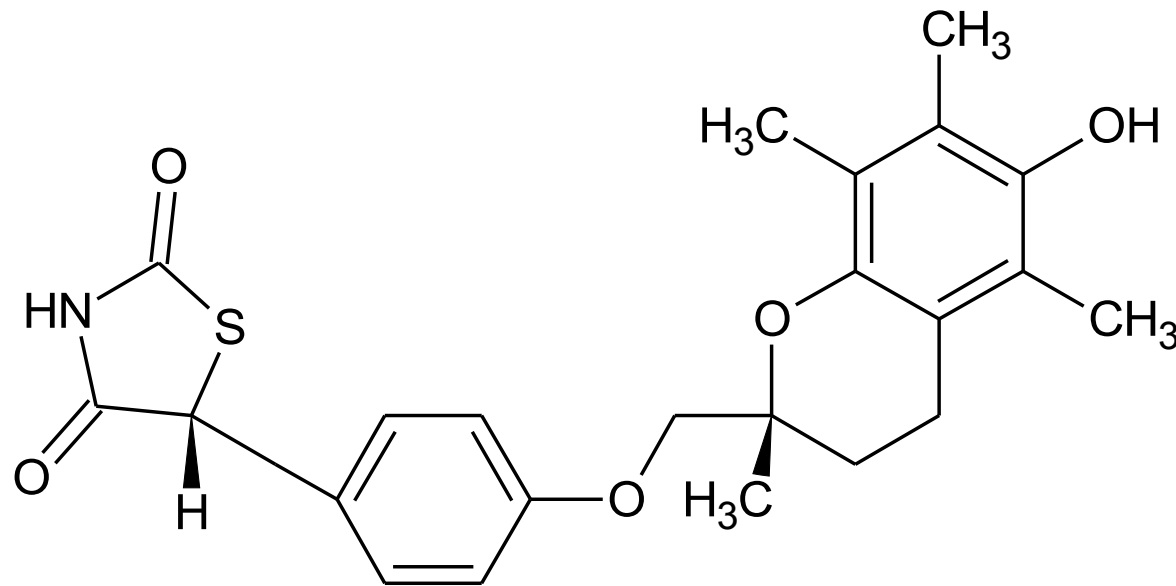

troglitazone

•withdrawn; ↑ risk of hepatotoxicity; approx. 1.9 % of patients in clinical tests exhibited ↑ of alanine aminotransferase (ALT) over the triple of the upper limit

Thiazolidindiones (glitazones)

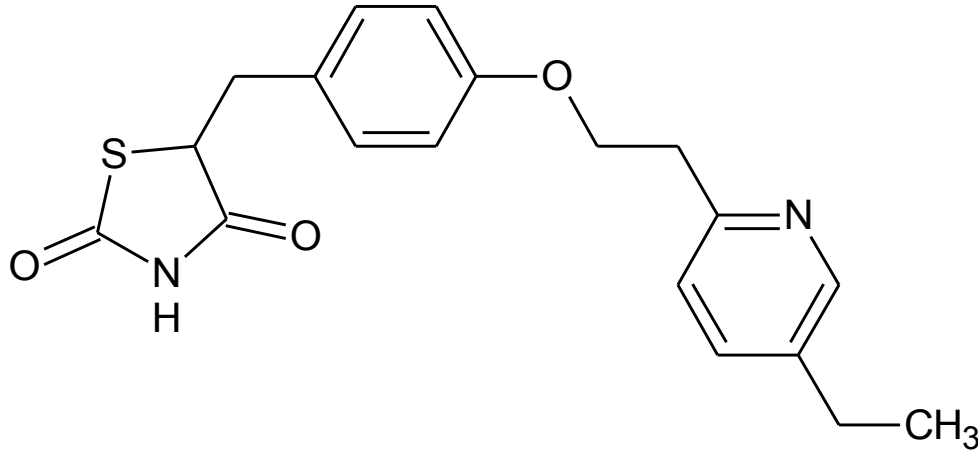

pioglitazone

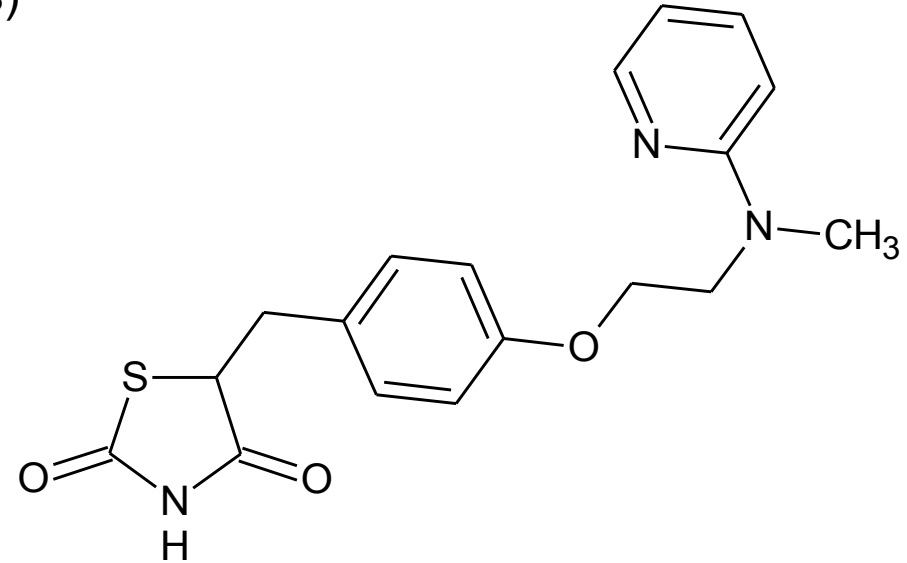

rosiglitazone

Mode of action: stimulation of PPAR γ rp. increases sensitivity of cells of peripheral tissues (fat, muscles) and of liver to insulin \Rightarrow \uparrow insulin-dependent supply of glucose to cells & \downarrow release of glucose from liver

- probably protect β -cells by \downarrow of direct glucotoxicity and insulin requirement

Adverse effects: oedema, cardiomegaly, anaemia, haemodilution

Actos[®]

- quite positive effect to blood lipids: \downarrow increased triacylglyceroles, \uparrow HDL; \uparrow LDL less than rosiglitazone

Avandia[®]

- \downarrow concentration of glycated haemoglobin (HbA_{1c})

Selective PPAR γ modulators

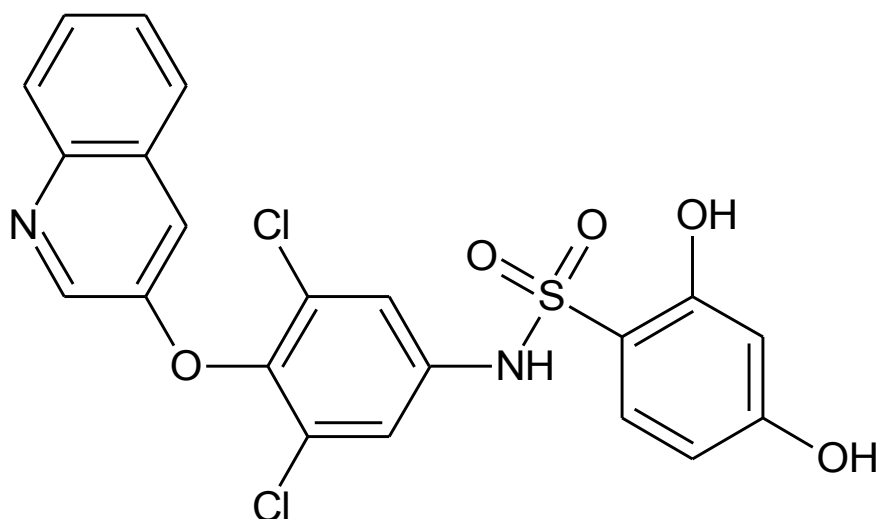

INT-131

- pharmacological profile different from glitazones: minimal stimulation of adipocytes differentiation, partial activation of target genes PPAR γ engaged in do adipogenesis, it simultaneously exhibits activity to another set of target genes, which is capable to affect directly insulin sensitivity; gain of glucose tolerance; preclinical evaluation demonstrated lower impact to lungs and heart weights and total increase of body weight, haemodilution and plasma volume
- clinical studies of the phase II: INT-131 is 8times more active than rosiglitazone, no evidence of liquids retention and weight gain was acquired
- X-ray crystallography: other way of binding to the receptor than that of glitazones, primarily forms hydrophobic contacts with the “ligand binding pocket” without direct H-bonds to key amino acids rests of the helix 12, which are typical for full agonists

Selective PPAR γ modulators

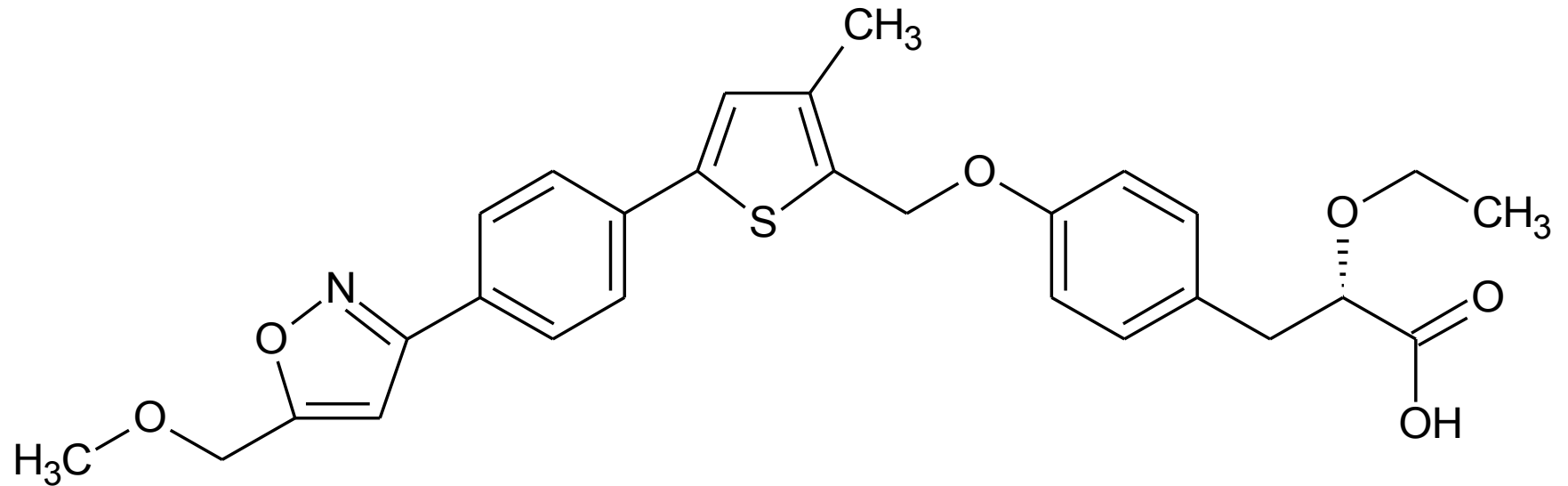

PAR-1622

- partial agonist of PPAR γ : 37 % of the activity of the full agonist rosiglitazone, does not interact with PPAR δ , 56x more selective to PPAR γ than to PPAR α
- improves hyperglycaemia
- does not increase blood plasma volume

GLP-1 analogues

- GLP-1: Glucagon-like peptide 1 = an intestinal hormone, which together with glucose-dependent insulinotropic polypeptide (GIP)* potentiates insulin secretion induced by food
- potentiates all steps of insulin biosynthesis; has positive impact to function and surviving of β -cells
 - decreases redundant glucose production in liver, slows down stomach emptying leading to postprandial hypoglycaemia, its central effect leads to appetite decrease (\Rightarrow body weight loss), probably also positive effects to cardiovascular system
 - disadvantages of GLP-1 as a drug: necessity of administration in a continual infusion, extremely short biological half-time $T_{1/2} = 2 - 3$ min (fast decomposition by peptidases) \Rightarrow need of more stable analogues

*Both are known also as **incretins**.

GLP-1 analogues

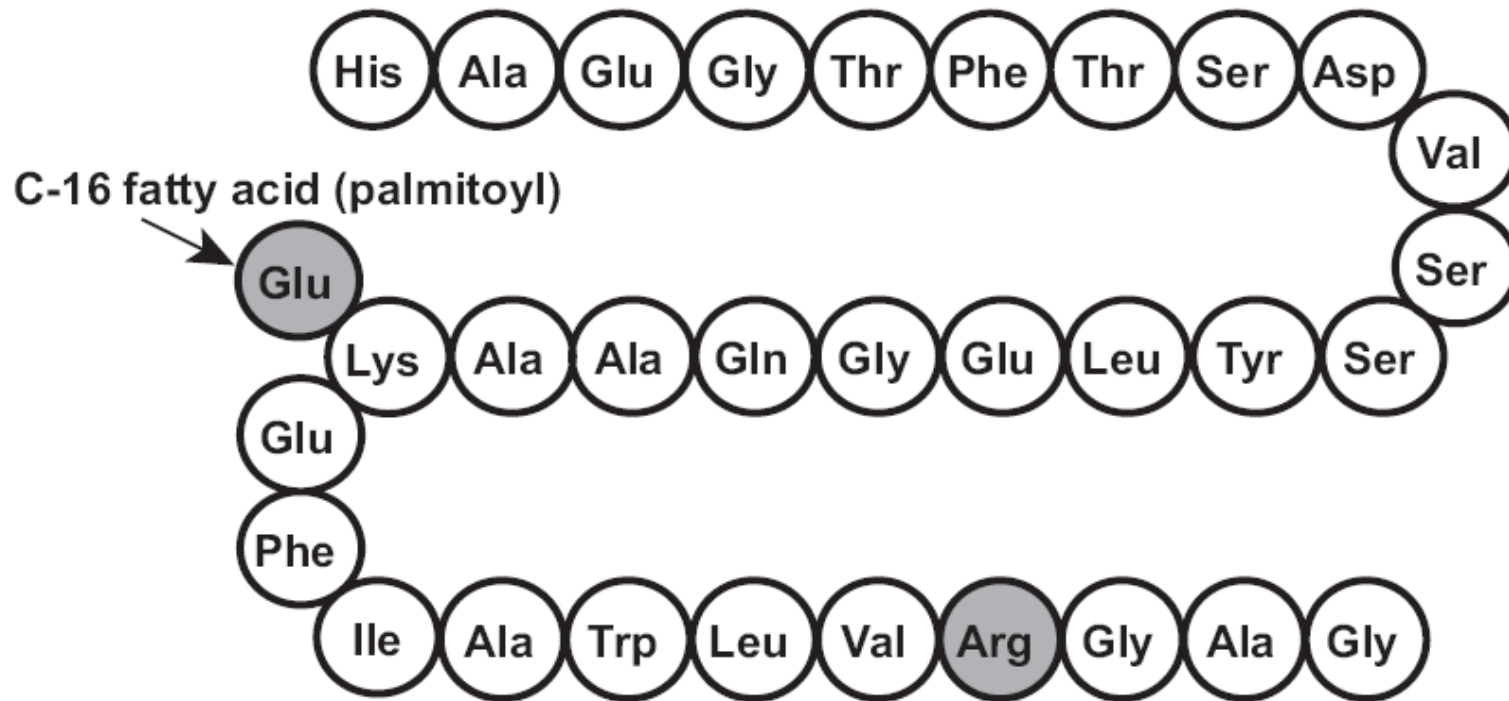

liraglutide

Victoza® inj. sol.

γ -L-glutamoyl(N- α -hexadecanoyl)-Lys²⁶, Arg³⁴-GLP-1(7-37)

- sequence of amino acid rests shares 97 % identity with the fragment 7-37 of the native GLP-1
- strong binding to serum albumin, mutual association of molecules, does not come under glomerular filtration $\Rightarrow T_{1/2} = 12.5$ hours after s.c. injection
- improves functions of both α and β cells

α -Glucosidase inhibitors

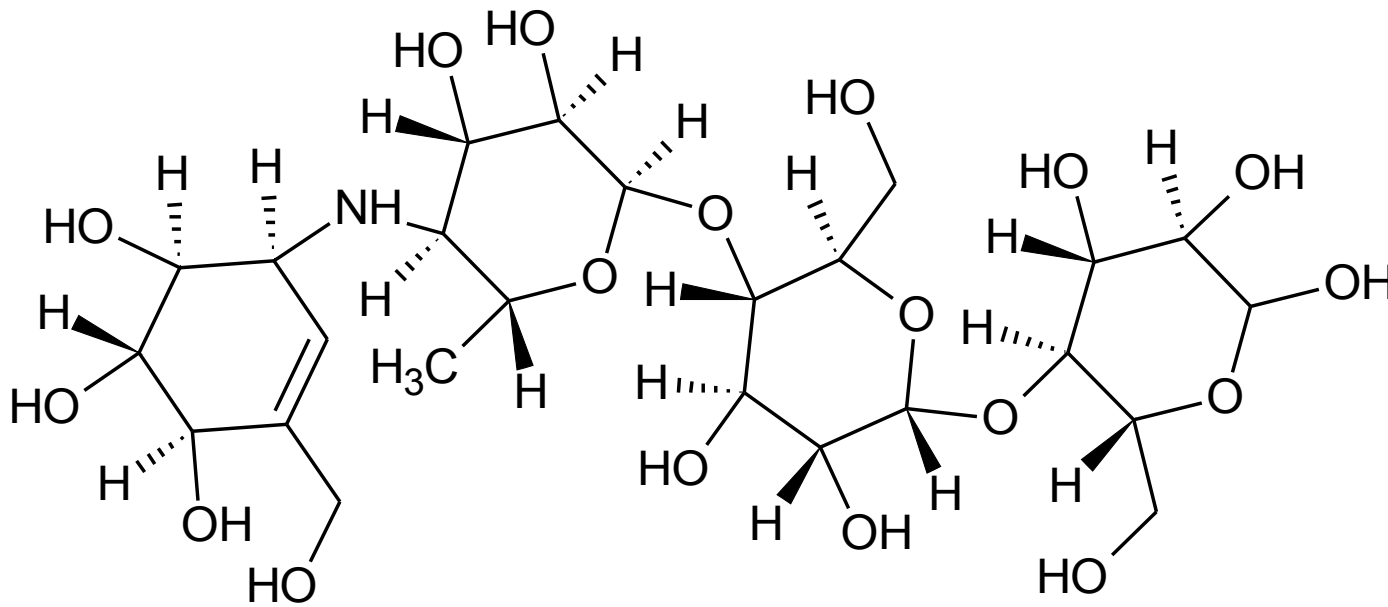

O-4,6-Dideoxy-4-{\[(1S,4R,5S,6S)-4,5,6-trihydroxy-3-(hydroxymethyl)-2-cyclohexen-1-yl]amino}- α -D-glucopyranosyl-(1-4)-O- α -D-glucopyranosyl-(1-4)-D-glucose

acarbose

Glucobay[®]

Mode of action of α -glucosidase inhibitors: inhibition of cleavage of α -glycosidic bond \Rightarrow hydrolysis of poly- and oligosaccharides to monosaccharides inhibited \Rightarrow \downarrow absorption of saccharides in small intestine \Rightarrow \downarrow glycaemia

•slow down also emptying of stomach and \uparrow postprandial hypotension and heart rate; probably also by stimulation of GLP-1

•reduce postprandial \uparrow glycaemia in patients with worsened glucose tolerance \Rightarrow slow down thinning of *intima media* of carotids

α -Glucosidase inhibitors

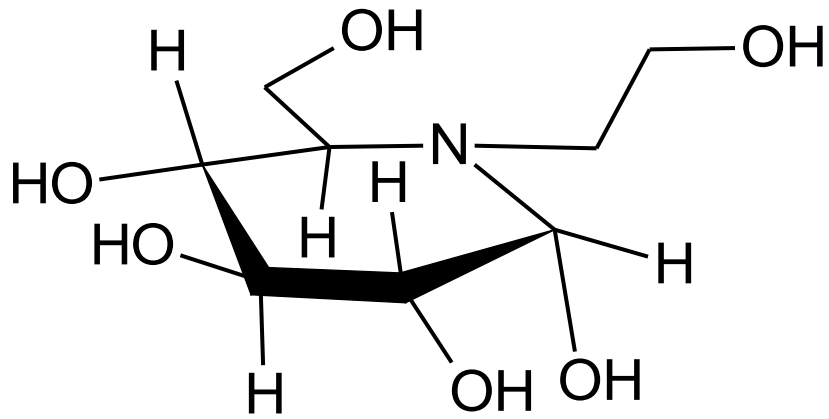

N-(2-Hydroxyethyl)-1-deoxynojirimycin

miglitol

(Glyset®)

- a piperidine analogue of glucose
- derived from natural nojirimycin from *Streptomyces ficellus*

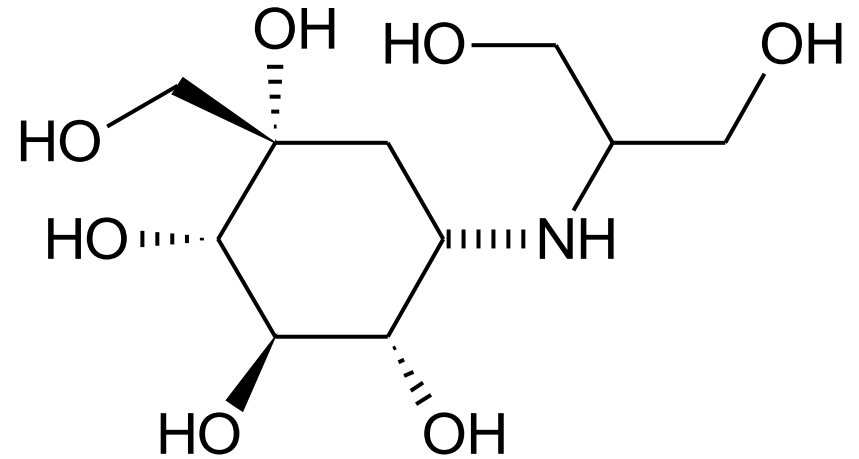

voglibose

(Basen®)