

# PATHOBIOCHEMISTRY



Trendlink. [online]. [cit. 2014-08-18]. Dostupné z: <http://www.trendlink.com/aktien/Biochemie>

Institute of Molecular Biology and  
Pharmaceutical Biotechnology

Mgr. Marie Brázdová, Ph.D.

[brazdovam@vfu.cz](mailto:brazdovam@vfu.cz)



Biofyzikální ústav AV ČR. [online]. [cit. 2014-08-18]. Dostupné z: <http://www.ibp.cz/cs/o-instituci/zakladni-informace/>

Institute of Biophysics, Academy of  
Sciences of the Czech Republic,  
v.v.i.  
Královopolská 135  
612 65 Brno

# Pathobiochemistry

Pathobiochemistry deals with disorders of biochemical processes in the organism, biochemical changes in the course of disease states and tries to explain them at the molecular level.

**Guarantor:** Mgr. Marie Brázdová, Ph.D., 45-308,  
[brazdovam@vfucz](mailto:brazdovam@vfucz)

## **Tutorial lecturers:**

Mgr. Marie BRÁZDOVÁ, Ph.D.

Mgr. J. Jelinek,

Mgr. R. Helm, Mgr. M. Petr, Mgr. Z. Soldánová, Mgr. V. Pařilová

## **Lecturers:**

Mgr. Marie BRÁZDOVÁ, Ph.D.,

Mgr. J. Jelinek, Mgr. Z. Soldánová, Mgr. V. Pařilová

# Syllabus Pathobiochemistry 2019/2020

1. Introduction, the importance of studying pathobiochemistry. The scope and requirements for successful completion of the course exam, recommended literature. Metabolism disorders, types and causes. Hereditary metabolic diseases.
2. Amino acid metabolism and its disorders. Types of diseases and therapy. (MB)
3. Enzymes, regulation of metabolism. Causes increased activity of cellular enzymes in the plasma. Clinically significant enzymes.
4. The nucleic acid metabolism disorders of purine and pyrimidine. Hyperuricemia, orotacidurie, therapy.
5. Pathobiochemistry of carbohydrates, glucose metabolism and its disorders. Glycemic control disorders. Pathobiochemistry of diabetes mellitus, types of DM. Disorders of glycogen metabolism, glykogenosis.
6. Disorders of lipid metabolism. Cholesterol, lipoproteins. Lipidosy, dyslipoproteinaemia.
7. Understanding the regulation of metabolism. Biochemical communication. Receptors.
8. Blood, blood plasma proteins. Blood clotting, coagulopathy. Dysproteinaemias. Porphyrins. Biosynthesis, metabolism disorders. Porphyria, hemoglobinopathies.
9. Xenobiotics and their effects on the body. Detoxification mechanism. Biological oxidation. The effects of free radicals on the organism. Lipoperoxidation antioxidants.
10. Tumor, tumor markers. Basic characteristics of tumor cells. Strategy laboratory tests. Requirements ideal tumor marker. Used tumor markers.
11. Analysis of urea and the urinary sediment. Immunochemical methods.
12. Mechanization and automation in clinical biochemistry. Analyzers, their distribution from different perspectives. Diagnostic kits. The organization of work in clinical-biochemical laboratory, laboratory and hospital information systems.
13. Pathobiochemistry of arteriosclerosis. Ischemic heart failure - cardiac markers.
14. Relation between Pathobiochemistry and Clinical Biochemistry. Clinical and biochemical analysis and its specific features. Terminology of Clinical Biochemistry. The analyzed material. Material removal.

# Syllabus of practical exercises:

Fridays 9:30-11:00

28.2., 13.3., 27.3., 24.4, 22.5.

1. Practice: Analysis of proteins in serum **Biochemical analyzer BS 200**
2. Practice: Analysis of tumor suppressor by immunodetection on membrane. (23.2. MB)
3. Practice: Basic biochemistry. *Biochemical analyzer Dimension.*
4. Practice: Immunochemical methods. *Immulite Immunoassay Analyser.*
5. Practice: Hematologic methods and Final test. (MB)

# Literature:

moodle- pathobiochemistry2018

- Murray et al. *Harper's Illustrated Biochemistry. 29th Edition.* Lange, 2012.
- KARLSON, P.; GEROK, W.; GROSS, W. *Pathobiochemie.* Academia, Praha, 1987.
- *Laboratorní diagnostika.* Edited by Tomáš Zima. 1. vyd. Praha: Galén, 2003. ISBN 80-7262-201-3.
- *Clinical biochemistry :metabolic and clinical aspects.* Edited by S. K. Bangert - William J. Marshall. New York: Churchill Livingstone, 1995. ISBN 0-443-04341-8. MASOPUST, Jaroslav. *Klinická biochemie. Požadování a hodnocení biochemických vyšetření.* 1. vyd. Praha: Karolinum, 1998. část I. a část II. ISBN 80-7184-649-3.
- *Clinical guide to laboratory tests.* Edited by Norbert W. Tietz. 3rd ed. Philadelphia: W.B. Saunders Company, 1995. ISBN 0-7216-5035-X.

# The exam from Pathobiochemistry:

## conditions for exam

credit from practical course

(100% presence, 80% small test before practical part, powerpoint presentation-Hereditary metabolic diseases, credit test 80%)

## Exam: 2 parts

- test (60% limit)

.....

- oral examination

from A (90-95% of test)

B (90-80%), C(90-80%), D (80-70%), E (70-60%)

[helmar@vfucz](mailto:helmar@vfucz) powerpoint presentation-Hereditary metabolic diseases

# 1. Hereditary metabolic disorders (HMD)

Causes and types of failures. Hereditary metabolic disorders (DMP). Diagnostics. Therapy

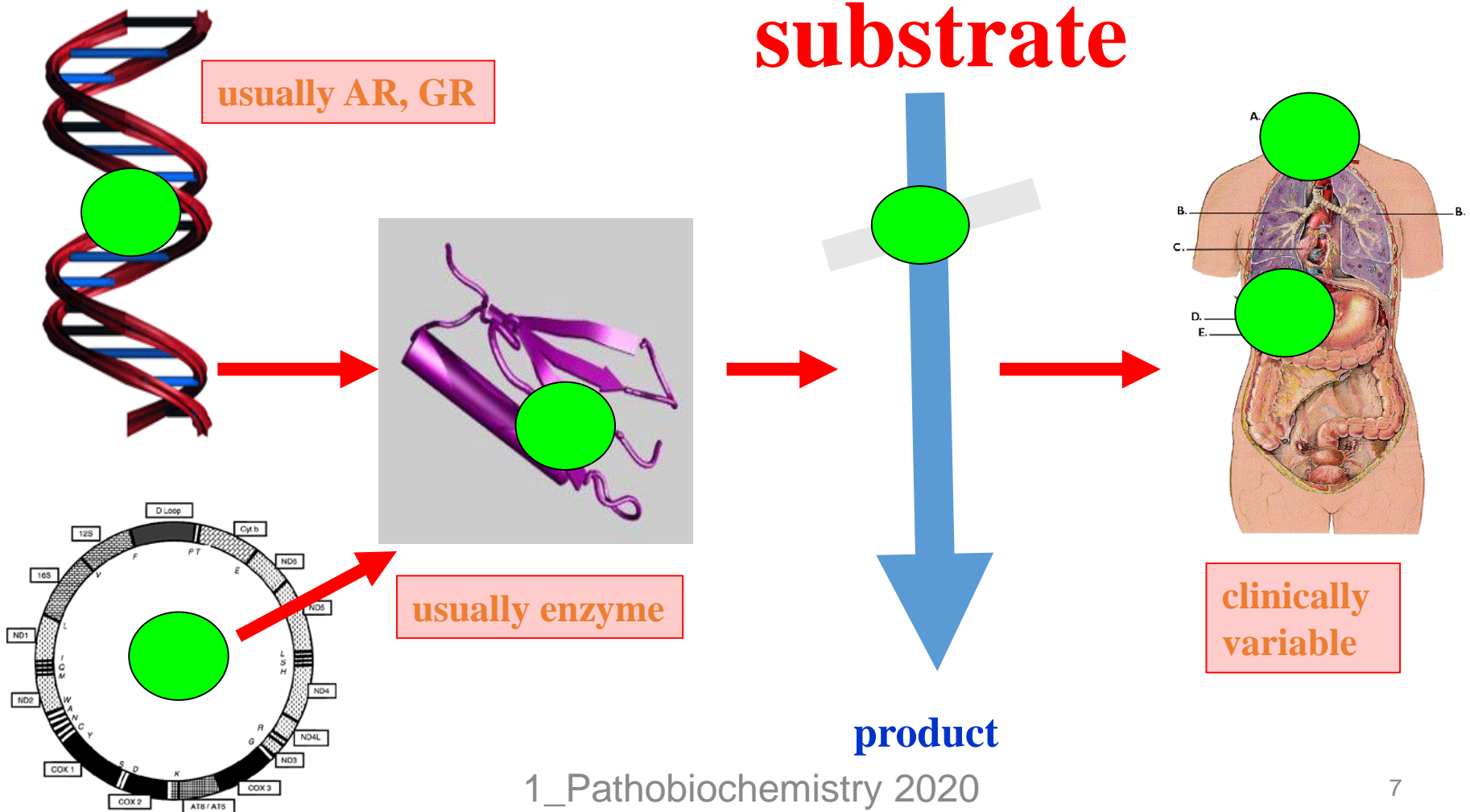

# 1.1. Causes and kinds of disorders.

## Hereditary metabolic disorders (HMD).

- **Before:** Inborn errors of metabolism
- **Definition:** diverse group of diseases whose common characteristic is a presence of genetically conditional protein change
- Beginning of 20. century - conception of HMD was formulated - sir Archibald Garrod - 4 HMD
- Today-HMD-more than 700 -1000 TYPES

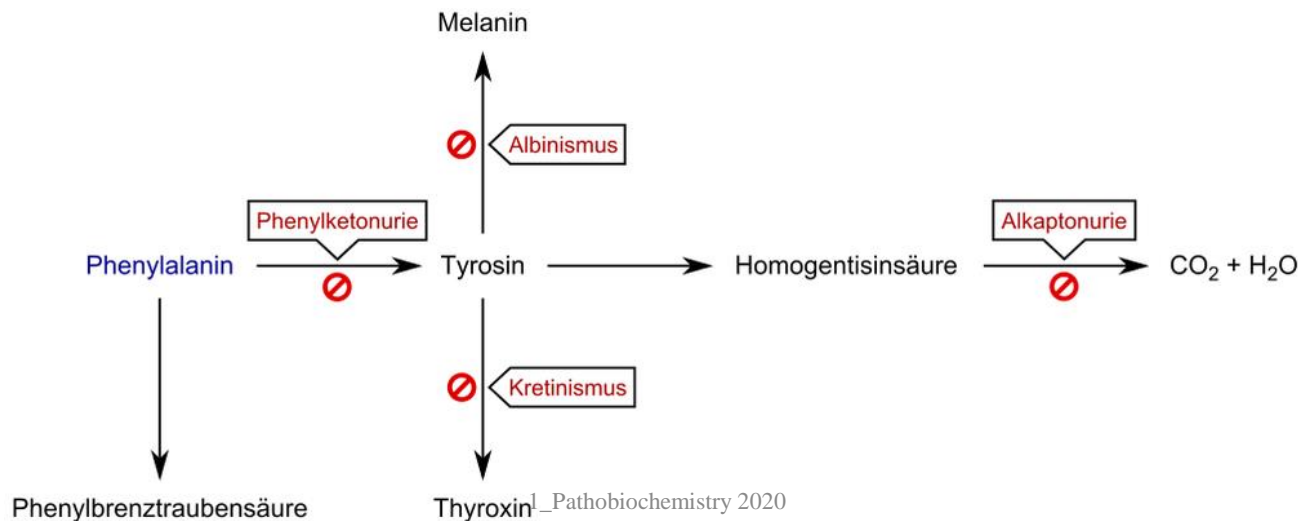



# Sir Archibald Edward Garrod,

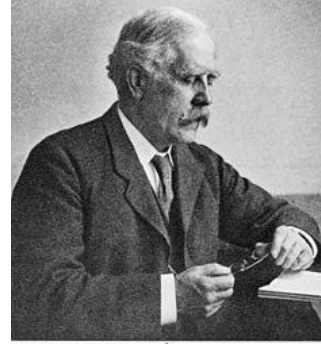

*A. E. Garrod*

- Sir Archibald Edward Garrod, (25 November 1857 - 28 March 1936) was an English physician who pioneered the field of **inborn errors of metabolism**. He also discovered **alkaptonuria**, understanding its inheritance. He served as Regius Professor of Medicine at the University of Oxford from 1920 to 1927.[2]
- **History**
- Beginnings of a discovery of HMD are connected with name [Archibald Garrod](#), who pointed to a connection between human diseases and [Mendel's principles of a heredity](#) and formulated a concept of HMD (inborn errors of metabolism). Garrod engaged by a study of [alkaptonuria](#) and in 1902 published a book *The Incidence of Alkaptonuria: a Study in Chemical Individuality*, which is first record of human recessive [hereditary](#). In 1923 next his book *Inborn Errors of Metabolism* was published, where we can find studies about [alkaptonuriia](#), [cystinuria](#), [pentosuria](#) and [albinism](#).

# Causes and types of failures. Hereditary metabolic disorders (DMP).

Hereditary metabolic disorders (DMP) are a diverse group of 700-1000 diseases that are caused by **enzyme deficiency, hyperactivity, transport protein dysfunction or other protein related pathways.**

They are characterized by **autosomal recessive, gonosomal recessive and dominant, but also mitochondrial inheritance.**

Insufficient production of an enzyme or protein is due to mutations in **nuclear or mitochondrial DNA.**

Conservative estimates of the cumulative incidence of all hereditary metabolic disorders are reported at about 1: 500 (heterozygous frequency 1:15); it is very likely that DMPs are currently underdiagnosed. Each GP has at least two or more DMP patients in his district and that each specialist encounters these patients in their practice.

The group of hereditary metabolic disorders is quite heterogeneous in common features.

1) By their very nature, biochemical and enzymatic abnormalities will be detectable in patients.

2) Furthermore, as most metabolic pathways are common to many cells in the body, **multiorgan involvement** (eg, CNS, muscle, kidney and liver involvement in mitochondrial diseases) is common.

3) Clinical manifestations of DMP are **very non-specific** (failure to thrive, anorexia, growth disorder, psychomotor development disorder, consciousness disorder),

4) there are very **rare specific signs** that are highly likely to occur for some DMPs (eg sweaty feet in patients with isovaler aciduria or typical facial dysmorphism in patients with mucopolysaccharidoses or generalized peroxisomal diseases).

5) Affect patients of **any age from prenatal to old age**.

# Causes of hereditary metabolic disorders

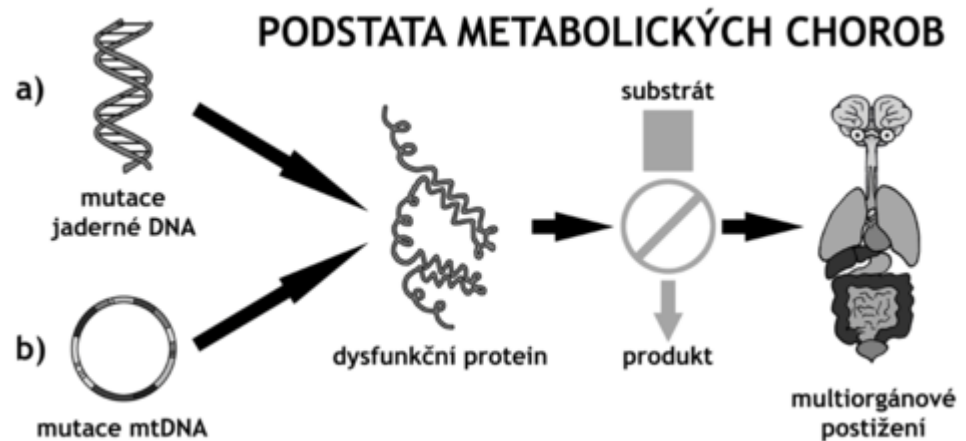

- The most common cause of hereditary metabolic disorders is **nuclear DNA mutations in germ cells** (and consequently in somatic cells) with typical **monogenic Mendelian inheritance** - commonly autosomal recessive, gonosomal recessive and dominant.
- Less common causes of DMP are **mitochondrial DNA mutations** that are transmitted by the **maternal type** of inheritance.
- **Phenotypic manifestations** in two individuals with the same genotype may differ due to **other factors** such as environmental effects (diet, lifestyle in small molecule diseases) or epigenetic changes, epistasis (interaction with allelic variants in other genes), inactivation X -chromosome (lyonization).
- Mutations can be of the point mutation type (missense, nonsense, synonymous mutation), deletion and insertion (with or without reading frame shift), and it is often not possible to directly determine the degree of impairment of the function of the protein from the type of mutation and its location.
- Consequence: defective transcription (mRNA level) and translation, splicing,....

# Hereditary metabolic disorders (HMD)

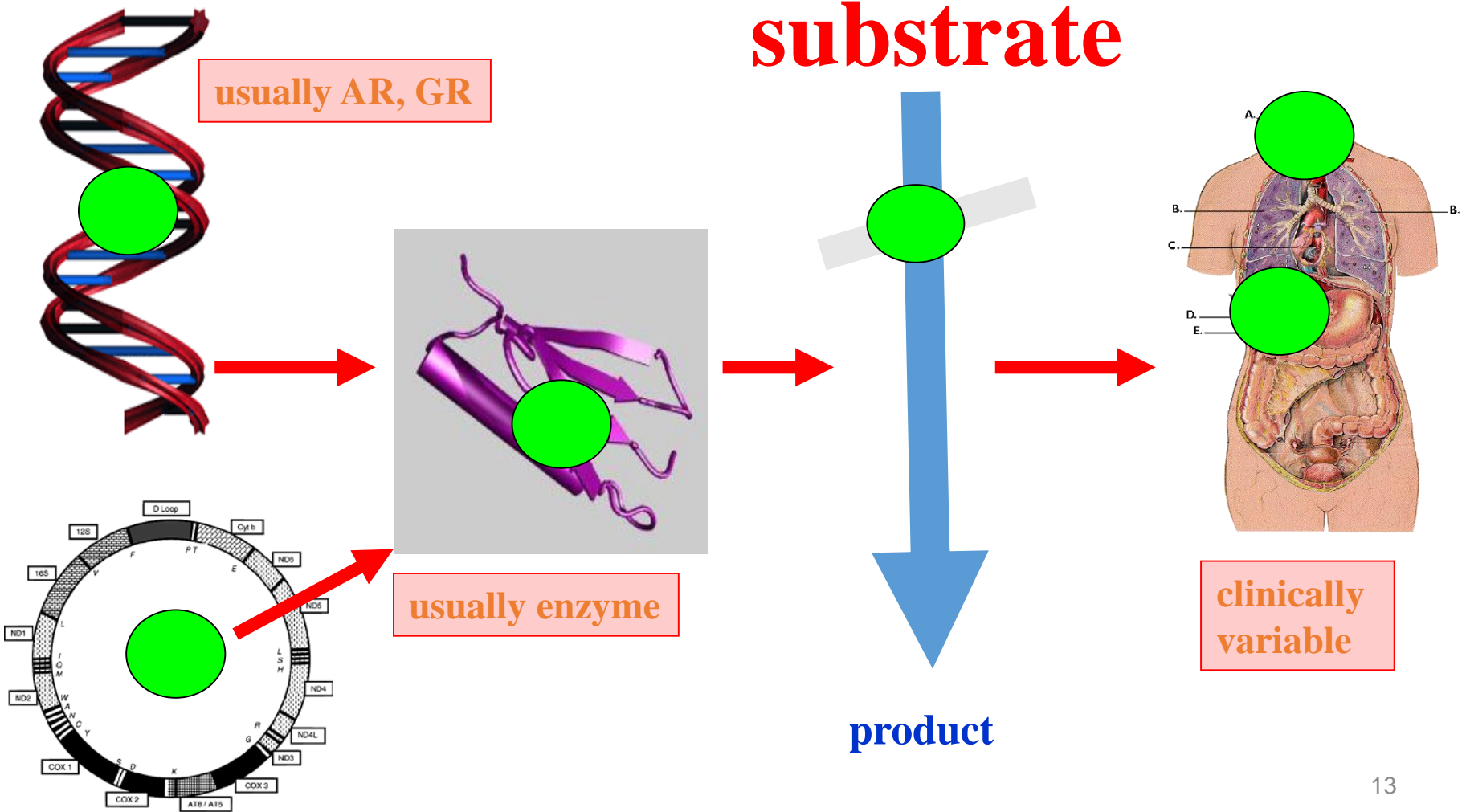

# Consequences of mutation

- altered amount of **translated protein** (usually decreased or rarely increased)
- altered **protein properties** (by changing the isolated function of a single domain, or by globally changing all functions, eg in misfolding).
- mutations can also lead to **changes in the function of non-protein gene products** such as miRNAs or siRNAs that regulate expression of a number of target genes.
  
- **Affected protein:**
- (a) mostly an enzyme (ENZYMOPATHY) of some metabolic pathway which then binds and does not produce its product, which may be absent, the substrate which may accumulate or eventually metabolize to the by-product is not drained. This leads to the involvement of different organs to different degrees (eg Alkaptonuria).
- b) non-enzymatic blood proteins: plasma protein or hemoglobin (sickle cell anemia)
- c) plasma membrane structural proteins: change in cell shape (eg spherocytosis)
- d) receptors, components of ion channels, regulatory proteins (eg tumor suppressor)

# Impacts of mutations

- **Accumulation of a substrate** (small molecules-for example phenylalanine are diffusely scattered in body fluids, transferred across a filtering barrier of kidneys, excreted by urine. Big molecules-for example mucopolysaccharides accumulate in a place where they arise).

**Example = PKU (phenylketonuria)** - a mutation of a gene for PAH (phenylalaninehydroxylase), enzymatic activity < 1% (2 alleles are affected). Low percentage of PKU is caused by a mutation of 1 allele or in a gene for a cofactor of PAH - tetrahydrobiopterin (milder form of PKU).

- **Lack of a product**
- **Accumulation of a defective enzyme**
- **Synthesis of an incorrect product - block of a metabolic pathway**
- **Lost of various enzymatic activities**

# Pathogenesis of HMD

- HMD are diseases which arise on a **molecular level**
- Causes of HMD is a change of genetic information (gene, DNA) → bad transcription into mRNA → bad synthesis of protein → protein with a changed structure
- Mutation → defective transcription → defective translation
- 1 gene encodes synthesis of 1 protein molecule

**Kinds of mutations:** deletion, insertion, lost of a part or whole chromosome



# Function of protein in intermediate metabolism

- Enzyme
- Transport protein
- Structural protein
- Regulatory protein

Most often-protein works like enzyme

enzyme

Substrate → product

# Example p53

- Impact of mutation of a protein function
- Lost of a function
- Amplification of a function - some of protein functions or intensity of a protein production amplificates by a mutation/accumulation
- Profit of a new function
- incorrect protein expression of ( in a place and in time)

# Mutation of *TP53*

A point mutation in TP53 causes a loss of p53-like tumor suppressor function

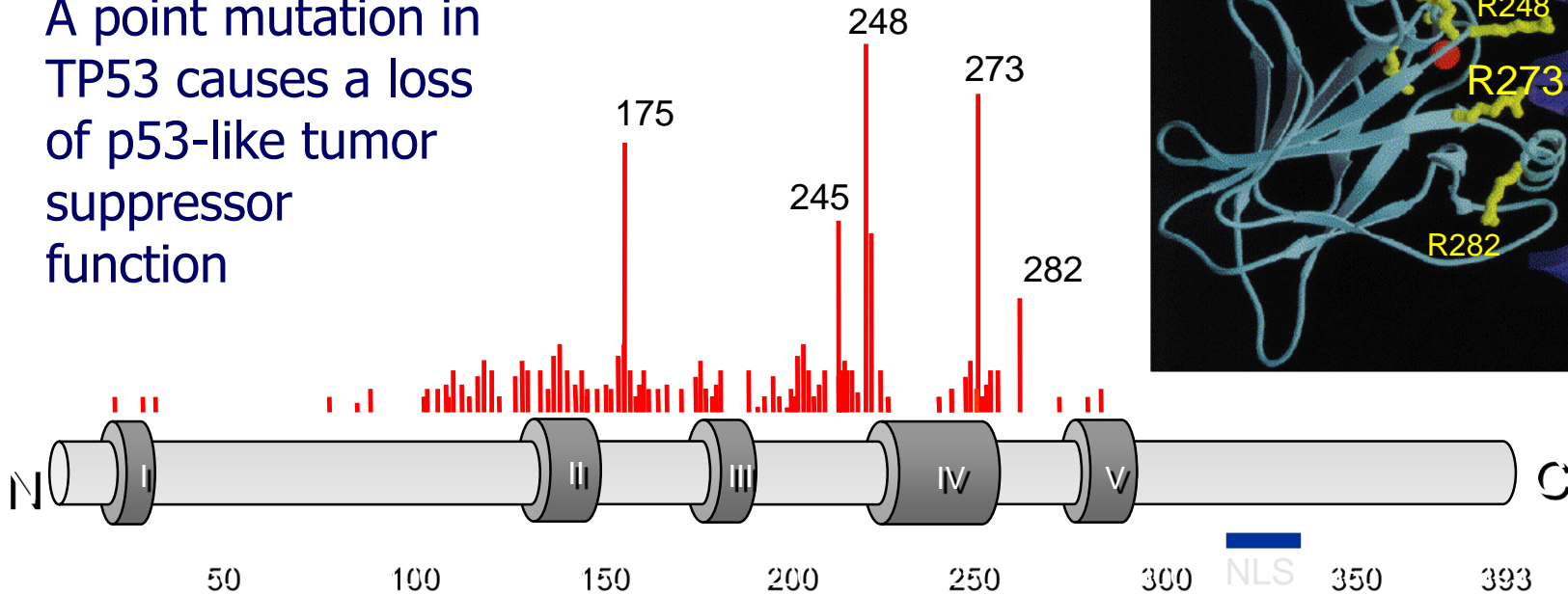

## Consequences of mutation on protein functions

• loss of function

• enhancement of function - mutation enhances some of the functions of the protein or intensity of protein production / accumulation)

• gain new features

• improper protein expression (in place and time)

PuPuPuC(A/T)(T/A)GPyPyPy

# Functional impact of TP53 mutations and GOF mechanisms

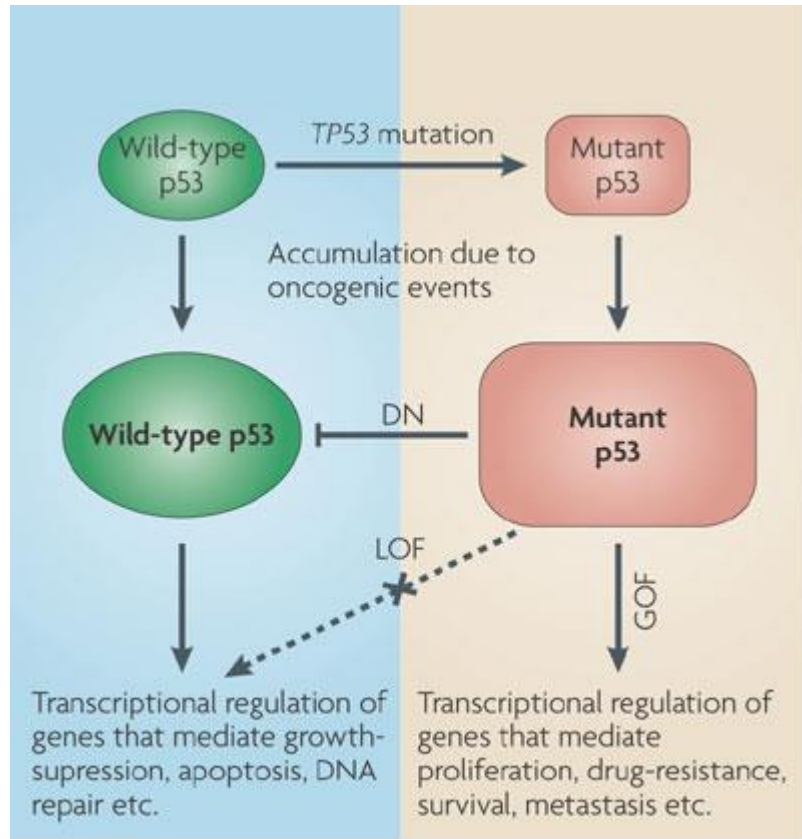

Nature Reviews | Cancer

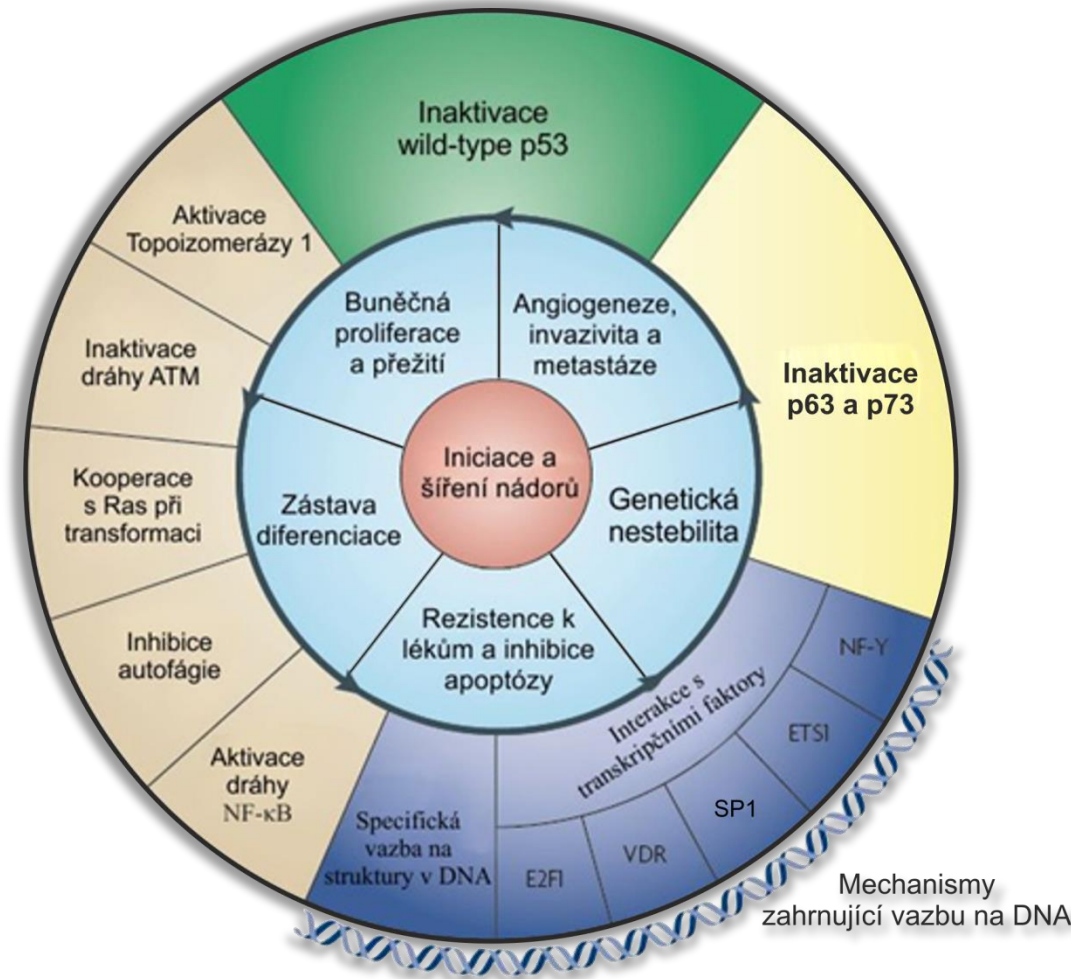

p53- tumor suppressor, antionkgen, transcription factor,  
DNA binding protein  
mutant p53-oncogene

# Incidence of Hereditary metabolic disorders

- belongs to the group of so-called rare diseases. The incidence of individual HMDs diagnosed is low, 1: 103 to 1: 106 or lower, but the overall incidence of all DMPs is relatively high (reported 1: 1000 to 1: 600). The actual incidence is probably even higher, and many patients escape the diagnosis of DMP. The incidence of DMP is different in different populations.
- Individual occurrence relatively rare (1:15 000 - 200 000)
- Collective incidence high (1: 1000), incidence probably higher (around 1: 500)
- neonatal screening 1: 1000-1: 4000
- selective screening of at least 1: 500-1: 1000
- heterozygous frequency for DMP of at least 1:15
- representation varies by population
- higher incidence in imbred populations (PKU Turkey, organic aciduria Middle East)
- tyrosinemia type I Quebec, aspartylglycosaminuria Finland, lysosomal diseases Israel
- Conservative estimates of the cumulative incidence of all hereditary metabolic disorders are reported at about 1: 500 (heterozygous frequency 1:15); it is very likely that DMPs are currently underdiagnosed.

**Incidence**, a statistical indicator in epidemiology, is the ratio of the number of newly reported sick individuals over a given period of time (new cases) to the number of all individuals in the study population.

# Incidence of HMD in CR

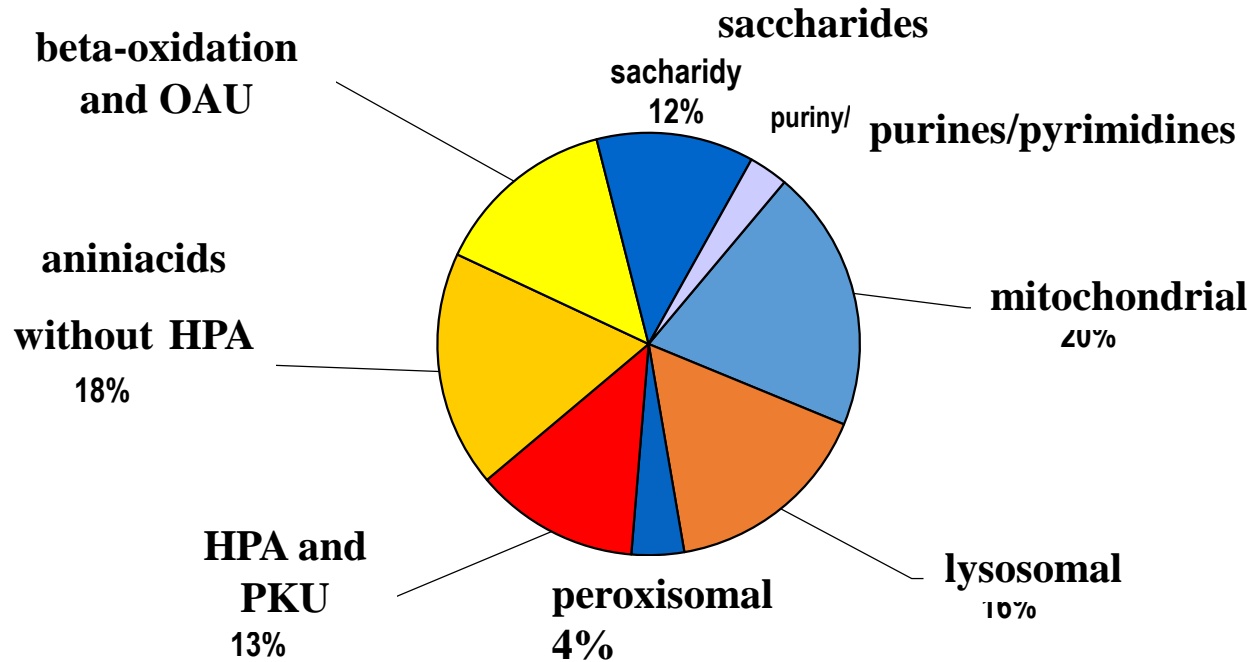

CR , 2005, n=127

**incidence for ČR ~ 1:1000  
still ~150 various nosologically units**

# Methods of HMD transmission (inheritance)

## NUCLEAR DNA

Autosomal recessive  
Autosomal dominant  
Gonosomal dominant  
Gonosomal recessive

## EXTRANUCLEAR DNA

Maternal type of a heredity (mitochondrial DNA)

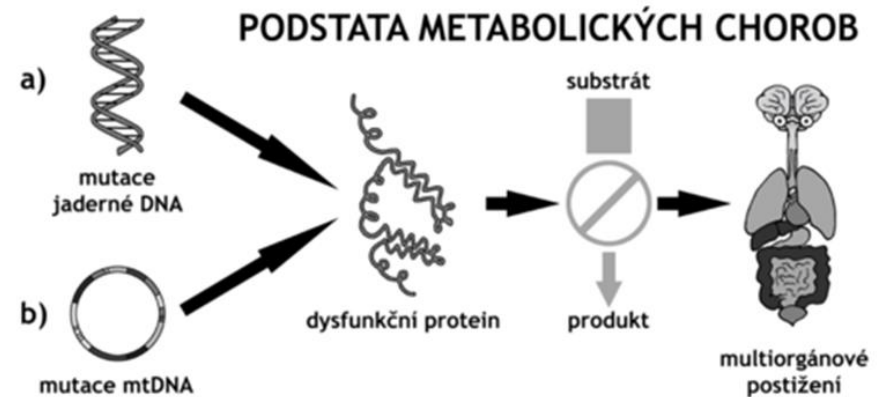

# Inheritance AR (Autosomal Recessive)

- The vast majority of DPMs such as **PKU** are inherited
- The disease manifests itself only in homozygote (carrier of both defective alleles for given trait)
- **Heterozygous** is a clinically healthy individual, a carrier of a defective gene

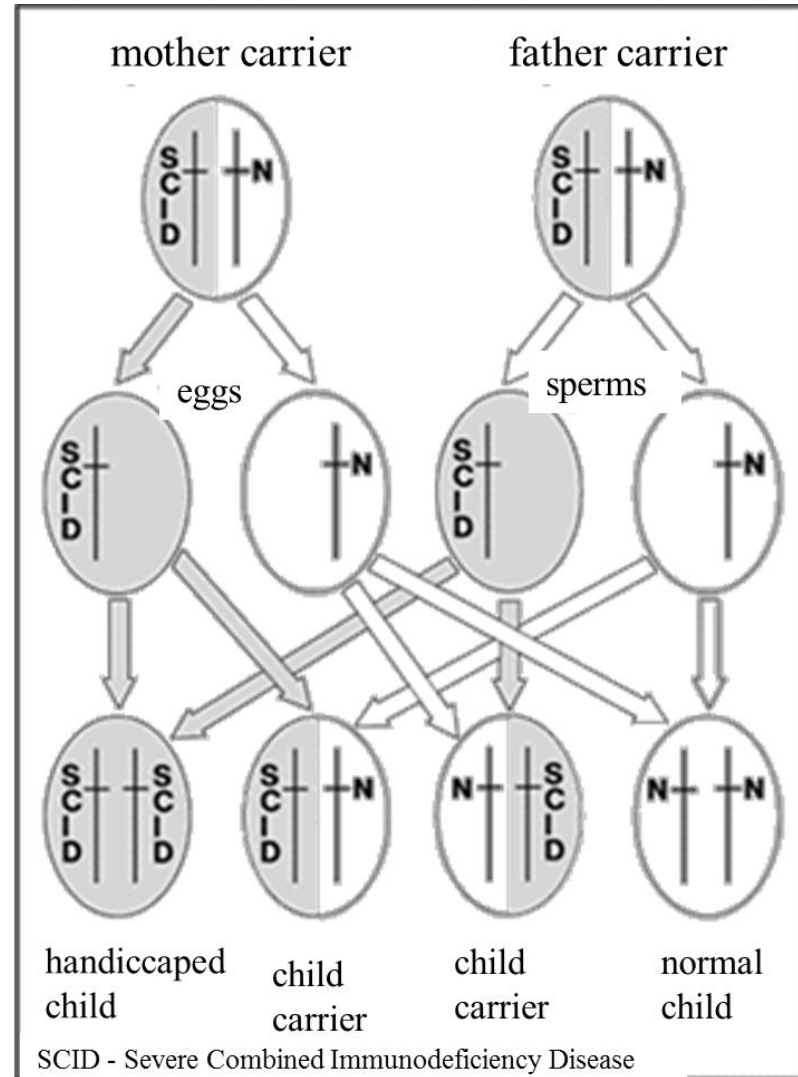



# Inheritance GR (Gonosomally recessive)

- The abnormal gene of the recessive type is linked to the sex chromosome X
- Clinically, it only affects men
- (have one X chromosome, women have XX)
- If one of the parents is affected, then they are
  - - men are either healthy or suffering from a disease
  - - **women may be 50% carriers**
- Examples: Hunter mucopolysaccharidosis, type VIII glycogenosis

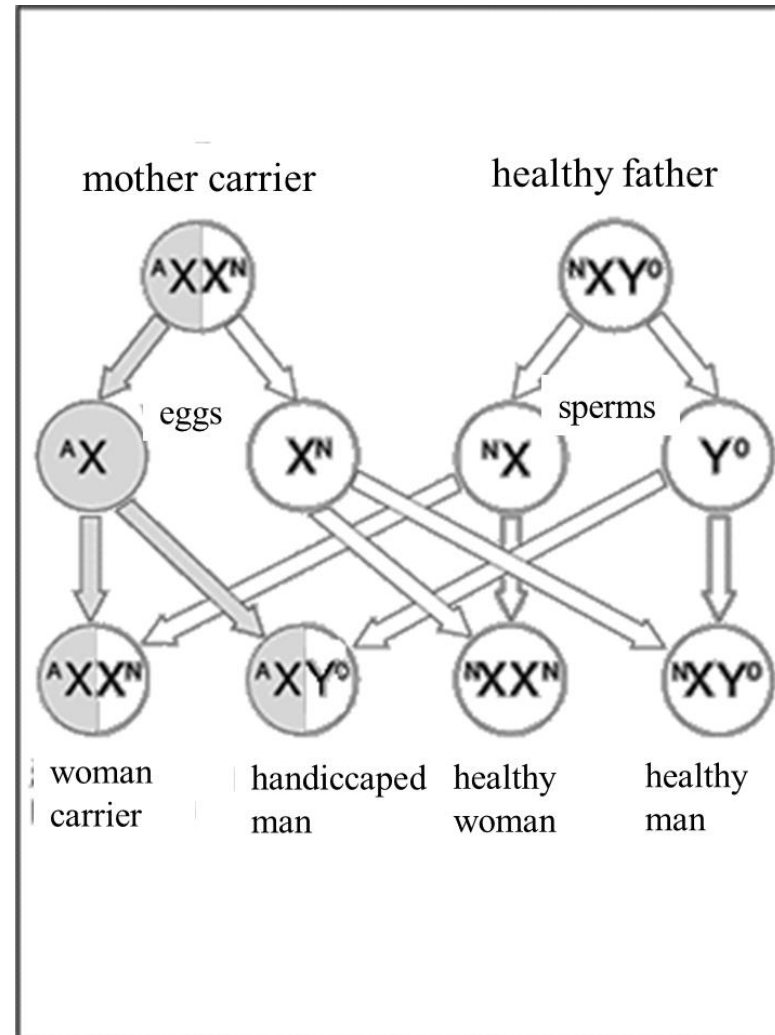

Gonosomal recessive heredity

# Maternal type of inheritance

- 1) All mitochondria are inherited by each individual **exclusively from the mother** (mitochondria of the zygote are all of the origin of the egg, all mitochondria of the sperm disappear).
- 2) There are about 1000 mitochondria per cell - one mitochondria with mutated mtDNA therefore **has no effect** on the cell. Whether a mutation in mtDNA is somehow expressed at the cell or whole organism level depends on **how many percent of mitochondria** have mutated genetic information.

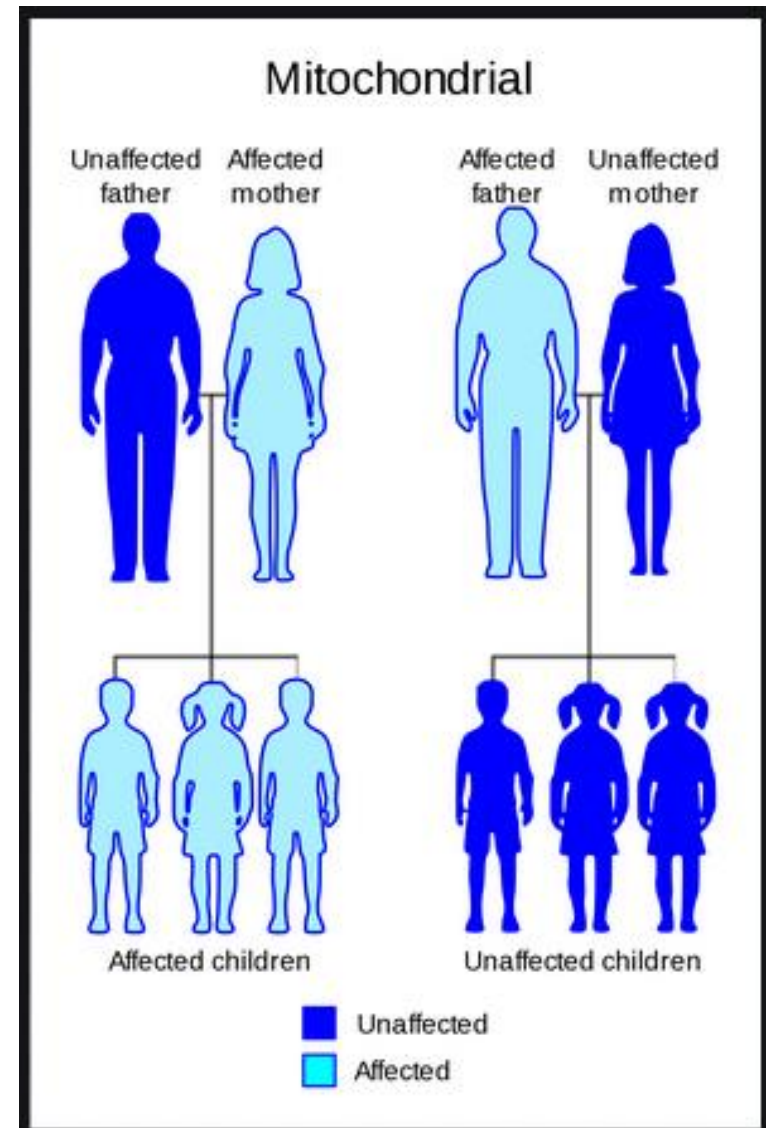

# Classification of HMD

1. According a speed of appearing of clinical signs
2. According of individual metabolic systems
3. According a subcellular localization of changed protein
4. According an analytical methodic which are used for an evidence of HMD

# 1. According to the rate of onset of clinical symptoms - disease:

- acute metabolic
- with intermittent course
- chronic

# 2. According to individual metabolic systems - metabolic disorders

- amino acids
- carbohydrate
- lipids
- purines and pyrimidines
- high molecular weight substances
- dyes etc.

# Classification of DMP according to the affected metabolic pathway

Hereditary metabolic disorders typically include metabolic disorders:

- disorders of organelle metabolism
- mitochondrial disease
- peroxisomal disease
- lysosomal diseases
- glycosylation disorders (bound to endoplasmic reticulum)

metabolic disorders primarily not bound to organelles

- disorders of amino acid metabolism
- organic aciduria
- disorders of carbohydrate metabolism including glycogenoses
- disorders of purine and pyrimidine metabolism
- lipid metabolism disorders
- porphyria
- other DMPs

### 3. According to the subcellular localization of the altered protein:

- cytosolic
- mitochondrial
- lysosomal
- peroxisomal
- Golgi apparatus
- ion channels, et

### 4. Type of molecules: small molecule diseases diseases of complex molecules

## 1) HMD Clinic

- **Manifestations** - at any age from birth to adulthood
- **Manifestation** - varied, from mild chronically occurring forms to acute life-threatening conditions
- **Severity** depends on the degree of affection of the altered protein (eg 0-20% enzyme activity)

## Clinical symptoms of HMD

- **Non-specific** - most of them (muscle tension disorders, behavioral disorders, consciousness disorders, convulsions, failure to thrive, vomiting, impaired heart, muscle, liver, kidney function...)
- **Specific** - eg typical abnormal odor of urine, sweat..., lens ectopia and thrombembolic events

# Laboratory non-specific findings

- Acidosis (eg lactate in PDH deficiency)
- Alkalosis (eg OTC deficiency- ornithine carbamoyltransferase)
- Hypoglycemia
- Hyperammonemia
- Hypoketosis (with hypoglycaemia in  $\beta$ oxidation disorders)
- Hyperketosis (in some org. Acidurias)
- Hypouricemia / hyperuricemia (meturic disorder)
- Hypocholesterolemia / hypercholesterolemia (deficiency of 7-dehydrocholesterol called Smith-Lemli-Opitz sy)



# 1\_1. Acute metabolic diseases

- **Beginning:** usually in the early neonatal or early infant period
- **Symptoms:** respiratory failure, sepsis, convulsions, consciousness disorders, protracted jaundice, developing RDS or DIC, etc.
- **Examples:** metabolic disorders of AMK, galactose, ureagenesis, organic acids,
  - $\beta$  fatty acid oxidation

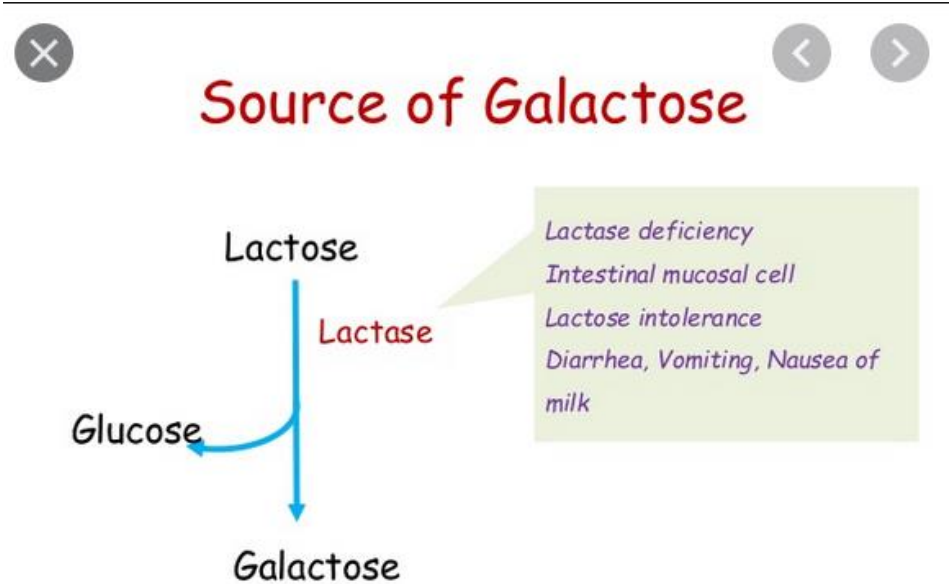

# 1\_2. Metabolic diseases with chronic course

- **Characteristics:** alternation of asymptomatic periods with attacks that typically occur after exercise eg change of nutrition (protein load), feverish period (increased energy requirement of the organism during catabolism)...
- **Examples:** late forms of OTC deficiency (ornithine carbamoyltransferase - urea cycle disorder)

Rare Urea Cycle Disorder May be Reversible with a Liver Cell Transplant Procedure Performed during Infancy



A rare urea cycle disorder that approximately 50 Canadian babies are born with each year has responded well to an experimental liver cell transplant procedure. Decreasing the chance of brain damage, the procedure may offer sufferers of the disorder the chance to live normal lives. Just last month, Calgary physicians performed the procedure on a Winnipeg infant girl, Nazadana Jan. Believed to be the first of its kind, the transplant procedure was performed at the Alberta Children's Hospital.

Urea cycle disorder is a genetic disease caused from the build-up of ammonia in the body. Left untreated, the disease leads to brain damage and death, with the best treatment for the condition being a liver transplant. However, newborns are not mature enough to undergo liver transplants, but thanks to a new procedure, urea cycle disorder may soon be treatable from birth. A tricky procedure to perform on a child, according to Jan's surgeon, Dr. Aneal Khan, Jan's liver cell transplant, if successful, may open the door to new hope for patients suffering from the urea cycle disorder. In Jan's case, several medical geneticists performed a series of liver cell transplants in an effort to stop the progression of the condition.

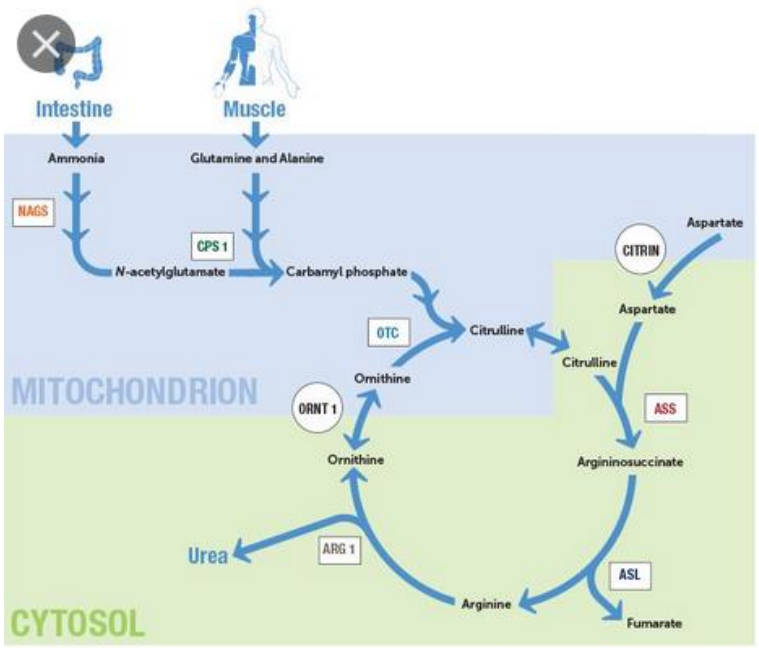

Urea cycle enzymes	
NAGS	N-acetylglutamate synthase
CPS 1	Carbamyl phosphate synthetase
ASS	Argininosuccinate synthetase
ASL	Argininosuccinate lyase
ARG 1	Arginase I
OTC	Ornithine transcarbamylase
Mitochondrial transporters	
ORNT 1	Ornithine translocase
CITRIN	Citrin

# 1\_3. Chronically progressive metabolic diseases

- **Characteristics:**

Initially normal psychomotor development stops after a certain period or regresses

- **Examples:**

storage diseases (mucopolysaccharidoses, neurodegenerative diseases...)



## **Mucopolysaccharidosis**

- Facial Features like Flat Nasal Bridge and Thick Lips
- Short Torso / Hearing Loss
- Dysplasia or Abnormal Bone Size
- Developmental Delays and Mental Retardation
- Enlarged Organs like Heart, Liver & Spleen
- Heart Diseases / Respiratory Issues

## 4) HMD classification according to HMD manifestations

The fundamental difference in the nature of the metabolites that cause clinical manifestations of the disease makes it possible to divide hereditary metabolic disorders into two groups:

**small molecule diseases**  
**diseases of complex molecules**

**Phenotypic manifestations** in two individuals with the **same genotype** may differ due to other factors such as environmental effects (diet, lifestyle in small molecule diseases) or epigenetic changes, epistasis (interaction with allelic variants in other genes), inactivation X - chromosome (lyonization).

# 4\_1\_small molecule diseases

are caused by

**accumulation of small toxic molecules** (ammonia, organic acids)

Lack of desirable metabolites (ketone bodies, glucose), which arise from catabolism of food intake substances (protein amino acids, carbohydrates, fatty acids).

1) Typically, the **disease manifests in neonatal age within a few hours or days**, the unbalanced concentration of toxic molecules occurs after increased intake of food or fever infections, as an acute condition with behavioral change to coma (e.g. hypoketotic coma in MCAD deficiency (Medium chain fatty acid (MCAD) deficiency acyl-CoA dehydrogenase deficiency).

Attacks may occur repeatedly, in conjunction with the specific situation the patient is associated with (prolonged starvation or sudden overeating).

2) However, some diseases may differ from this pattern and may also be subacute or chronic, affecting organs other than the CNS.

## 4\_2\_Diseases of complex molecules

- **Diseases of large molecules result** from defects in metabolism (defects in the formation, transport of substances, but also in their degradation) of endogenously produced macromolecules (glycosaminoglycans, glycolipids, glycoproteins and others).
- Some of these substances **form structural parts of cell membranes**, which in turn manifest themselves as a defect of this type, others are degraded in peroxisomes and lysosomes, where they can accumulate. This lasts from months to years, the disease is free from attacks and obvious short-term nutritional or infectious contexts, and is chronic in nature, manifesting only after the latent phase has elapsed, during which enough macromolecules have accumulated to produce a defect at function level.
- Diseases in which **macromolecules accumulate** in peroxisomes or lysosomes may mimic neurodegenerative or cancerous diseases.
- Diseases in which membrane defects occur, in turn chromosome aberrations, such as organomegaly, head and face dysmorphism, CNS and other organ disorders.

# Examples of the best known HMD

- Metabolic disorders of AA
- Organic aciduria
- Disorders of carbohydrate metabolism
- Disorders of lipoprotein metabolism
- Disorders of purine and pyrimidine metabolism
- Disorders of high metabolism. substances

# Diagnosis HMD

1. In a level of metabolites
2. In a level of enzymes
3. In a molecular level

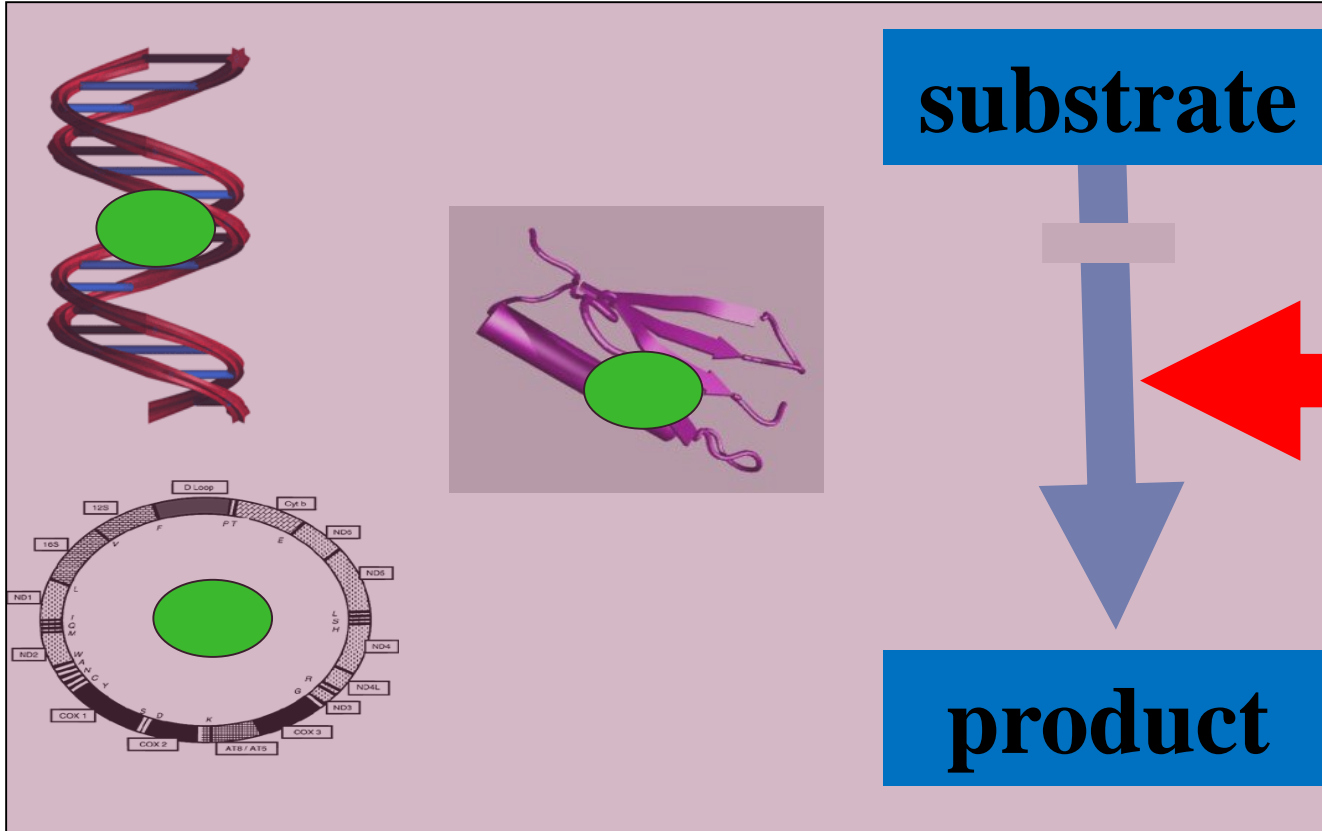

**DNA/RNA**

**Enzymology**

**Metabolites**

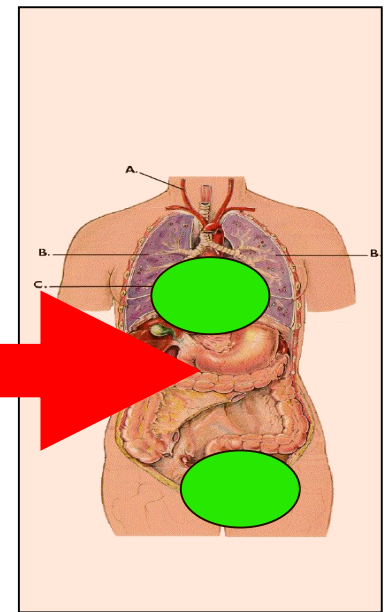

**Symptoms**  
Specific – for example:.  
odor  
urine color  
Nonspecific – for example:  
coma  
PMR  
dysmorphia  
hepato/myopathies  
and so on

## Laboratory diagnostics of HMD



**precursor**



**substrate**



**By-product**

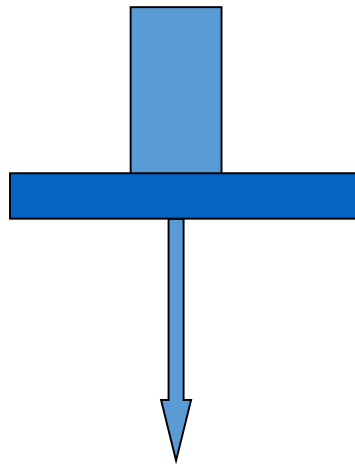

**product**



**precursor**



**substrate**



**secondary product**

Examples:

- Phe a Phe-derivates
- ammonia
- cystine in cystinosis
- cystine in cystinuria
- mucopolysaccharides

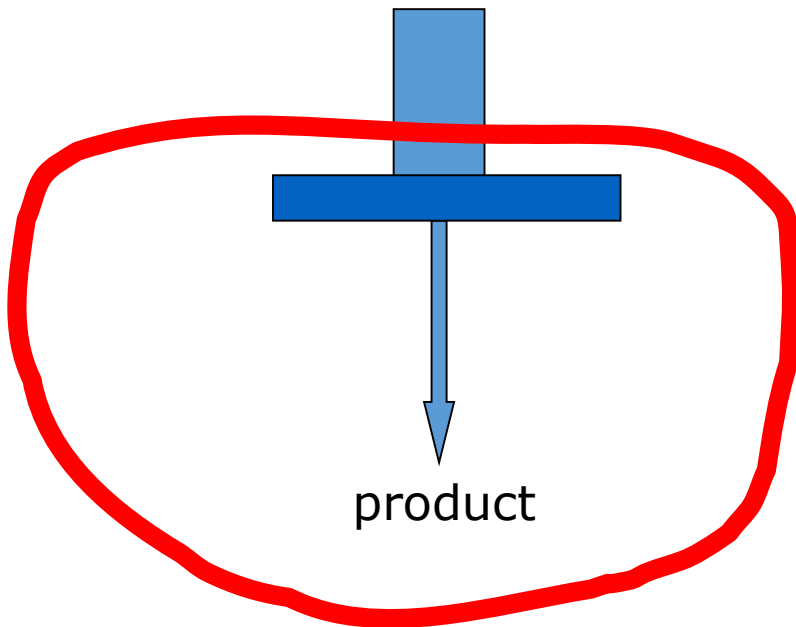

### Examples:

- glucose in GSD
- ketone bodies in beta-oxidation disorders of fatty acids
- plasmalogenes in peroxisomal disorders
- cysteine in deficiency of CBS
- AdoMet in RM
- ATP in mitochondrial diseases

# 1. Diagnostics in a level of metabolites

- **Characteristic:** we prove a changed concentration of a metabolite( substrate, product, abnormal metabolit). The oldest simplest and most spread.
- **Utilization:** where an enzyme or a transport protein is a defective protein → in a place of metabolic block a substrate accumulates and a product misses, alternatively other metabolites are synthesized consequently an activation of alternative metabolic pathways
- **Material:** serum or plasma, urine, liquor, whole blood in the form of dried blood spots on a filtering paper

# Diagnosis HMD

**Laboratory diagnosis HMD** - on several levels:

- Prenatal diagnosis - examination to determine whether the fetus is affected by the HMD, which was demonstrated in the family - only justified cases (AFP, defect in the family)
- Postnatal diagnosis - *neonatal screening (PKU hypothyreosis etc.)*

Most of the HMD can be diagnosed prenatally - analyzing the enzyme activity or mutation in chorionic villi or amniocytes or by investigation of metabolites in amniotic fluid.

- Early diagnosis - **treatment, compensation**

# 1. Diagnosis at the level of metabolites - continuing

- **Investigated metabolites:** amino acids, carbohydrates, oligosaccharides, glycosaminoglycans, purines, pyrimidines, lipids, steroids etc.
- **Used laboratory techniques:**
  - chromatography - paper
    - thin layer
    - liquid (ion-exchange, high-performance HPLC)
    - gas (mass spectrometry GC/MS )
  - electromigration techniques
    - electrophoresis
    - capillary electrophoresis
  - tandem mass spectrometry MS/MS

# Presymptomatic diagnosis

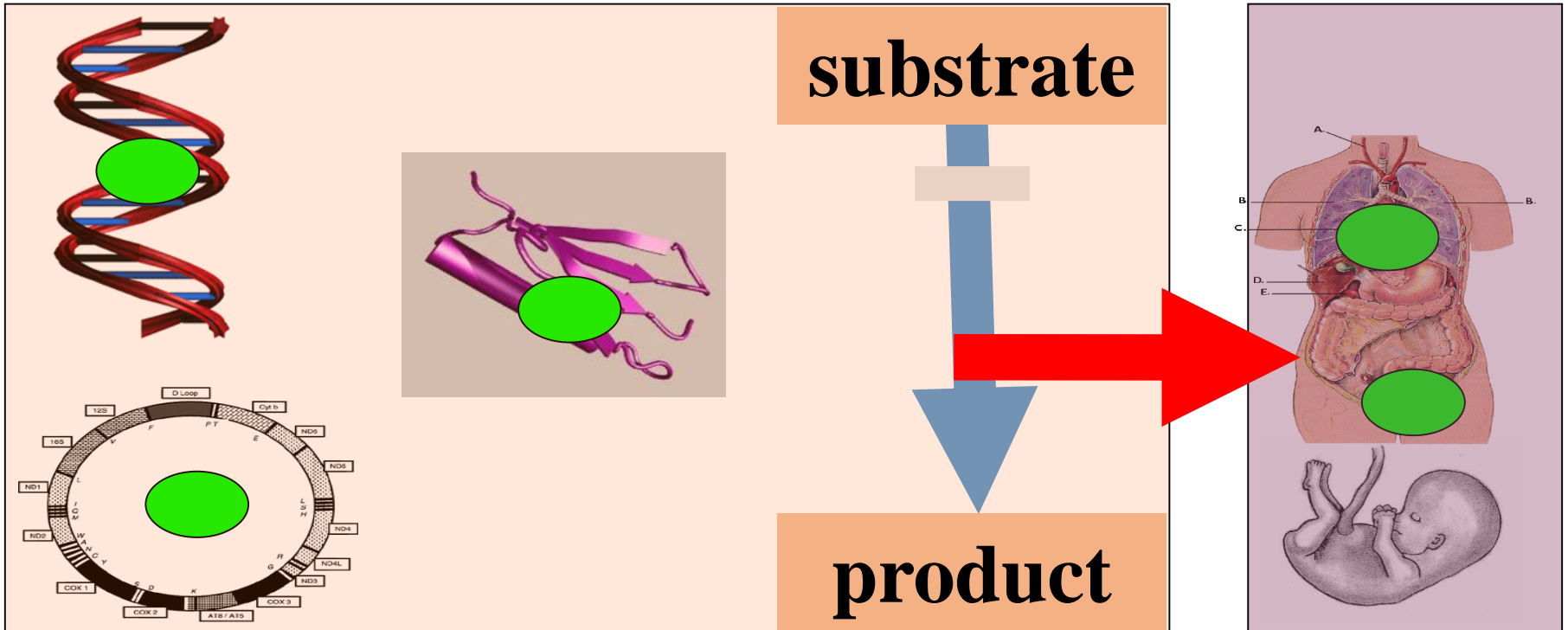

**examination related risk HMD prenatal diagnosis**

**screening population segment**

**neonatal screening**

**one disease or group of diseases known in advance**

## Definition:

Neonatal screening (NS) = active nationwide search the disease in its preclinical stage.

The analysis of dried blood in filter paper collected by standard procedures from the footer of all neonates.

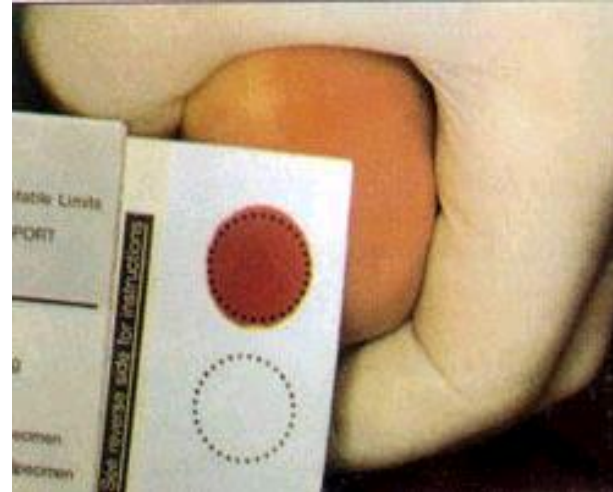



# Hyperphenylalaninemia/ phenylketonuria

- **Characteristics:** insufficient conversion of Phe to Tyr
- **Cause:**
  - 1) Deficiency phenylalaninhydroxylase
  - 2) Disorder of the coenzyme tetrahydrobiopterin metabolism
- **Occurrence:** about 1:10 000, the most common DPM
- Neonatal screening- in Czech republic from 1975 nationwide - Guthrieho test

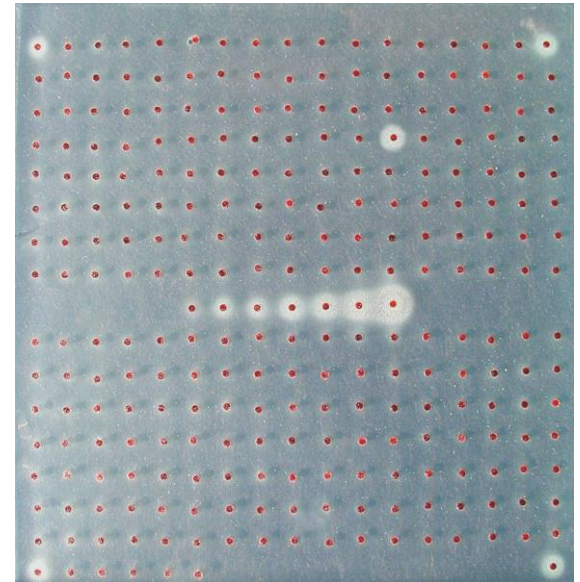

# Screening

- *Screening* = method for detecting early forms of disease or deviations from the norm in a given population through test
  - is performed on all neonates born in the Czech republic
    - rapid diagnosis and early treatment mainly inherited metabolic disorders
    - **confirm / refute the disease** before its symptoms and damage to child
- Method of sampling drops of blood from the footer to the neonatal screening card

# The development of the neonatal screening

- 1962 - founder - prof. Robert Guthrie - introduced a bacterial test for the early detection and *PKU and hyperphenylalaninemia* in USA (using the strain of the *Bacillus subtilis*, they proliferate in the environment of high concentration of phenylalanine)
- from 1969 Guthrieho method in Czech republic, **allover screening up from 1975**
- from 1985 - the extension of the screening test for *congenital hypothyroidism (CH)* - *iodines deficit fetus, severe damage to the developing brain of a child*
- from 2006 - increasing testing of *congenital adrenal hyperplasia (CAH)* - previously called adrenogenital syndrome
- 2009 - changes and extensions of screening (according to the Bulletin of the Ministry of Health)
  - screening is expanded to include of the *screening cystic fibrosis*

# Blood collection from neonatal screening



# Classical criterion for screening

- generally recognized screening test
  - credibility of the scr. test: cut-off, fal.neg. Load the healthy population: recall, fal.poz.
  - the company is able to secure NS and aftercare of patients retained the organization and economic
- 
- Diagnostic costs and treatment should be economically balanced in the health care system
  - NS is a positive contribution towards the cost of „benefit/cost“
  - NS is a continuous process - efficiency must be constantly evaluated

- Neonatal laboratory screening



- Hyperphenylalaninemia, phenylketonuria

- Neonatal laboratory screening (NLS) is an active search for diseases in their early, preclinical stage to diagnose and treat these diseases before they can manifest themselves and cause irreversible damage.
- NLS is based on the diagnosis of the disease by determining the concentration of a specific substance in a dry drop of blood on a so-called neonatal screening card.

- decreased thyroid function (congenital hypothyroidism - CH)
- insufficiency of adrenal hormone production (congenital adrenal hyperplasia - CAH)

- Mucosal disorders (cystic fibrosis - CF)

- amino acid metabolism disorders

congenital disorder of phenylalanine amino acid metabolism

(phenylketonuria - PKU, hyperphenylalaninemia - HPA)

argininaemia (ARG); type I citrullinemia (CIT); branched-chain amino acid metabolism disorder (leucinoses, maple syrup disease - MSUD);

cystathionine beta-synthase (CBS) deficiency homocystinuria, pyridoxine

non-responsive form; methylenetetrahydrofolate reductase (MTHFR)

deficiency homocystinuria; glutaric aciduria type I (GA I); isovaleric aciduria (IVA)

- hereditary disorders of fatty acid metabolism

medium chain fatty acid acyl-CoA dehydrogenase deficiency (MCAD

deficiency); long-chain fatty acid 3-hydroxyacyl-CoA dehydrogenase

## Results of neonatal laboratory screening in the Czech Republic in 2015:

In 2015, 110,800 live newborns were born.

NLS was detected in 87 newborns with one of the 13 examined diseases

Onemocnění	Počet zachycených	Prevalence	Počet pacientů od r. 2010	Prevalence (kumulativní)
<b>CH</b>	<b>36</b>	1 : 3 078	<b>248</b>	<b>1 : 2 669</b>
<b>CAH</b>	<b>10</b>	1 : 11 080	<b>50</b>	<b>1 : 13 236</b>
<b>HPA/PKU</b>	<b>21</b>	1 : 5 276	<b>125</b>	<b>1 : 5 295</b>
MSUD	0	-	<b>1</b>	<b>1 : 661 823</b>
MCADD	4	1 : 27 700	<b>32</b>	<b>1 : 20 682</b>
LCHADD	0	-	<b>10</b>	<b>1 : 66 182</b>
VLCADD	0	-	<b>4</b>	<b>1 : 165 456</b>
CPT I	0	-	<b>0</b>	-
CPT II / CACT	0	-	<b>0</b>	-
GA I	1	1 : 110 800	<b>4</b>	<b>1 : 165 456</b>
IVA	0	-	<b>3</b>	<b>1 : 220 608</b>
<b>CF</b>	<b>15</b>	1 : 7 387	<b>95</b>	<b>1 : 6 967</b>
<b>CELKEM</b>	<b>87</b>	<b>1 : 1 274</b>	<b>572</b>	<b>1 : 1 157</b>



## 2. Diagnostics at the level of enzymes

- **Characteristics:** show reduced activity of the affected enzymes. Testing is difficult (economically costly, often greater burden for the patient - material removal).
- **Use:** in prenatal diagnosis, to confirm the appropriate DPM, normally precedes testing at the level of metabolites
- **Material:** leukocytes, erythrocytes and trombocytes isolated from peripheral blood, serum or plasma, culture of skin fibroblast, tissue from muscle or liver biopsy

### 3. Diagnostics on the molecular level

- **Characteristics:** diagnosis at the DNA level shows you the defective gene. Economically costly, indicate wisely
- **Use:** to definitively confirm the diagnosis, where it can be clearly do so on the basis testing of metabolites or enzymes, followed by genetic consulting
- **Materiál:** leukocytes from peripheral blood, cells from amniotic fluid obtained by amniocentesis, chorionic villus cells obtained by biopsy of the placenta

# Symptomatic diagnosis

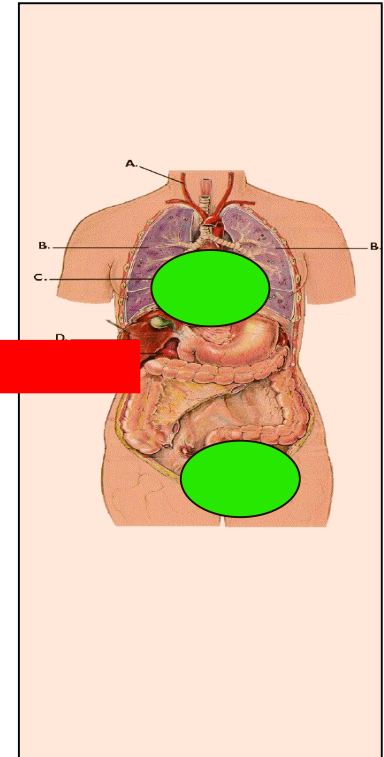
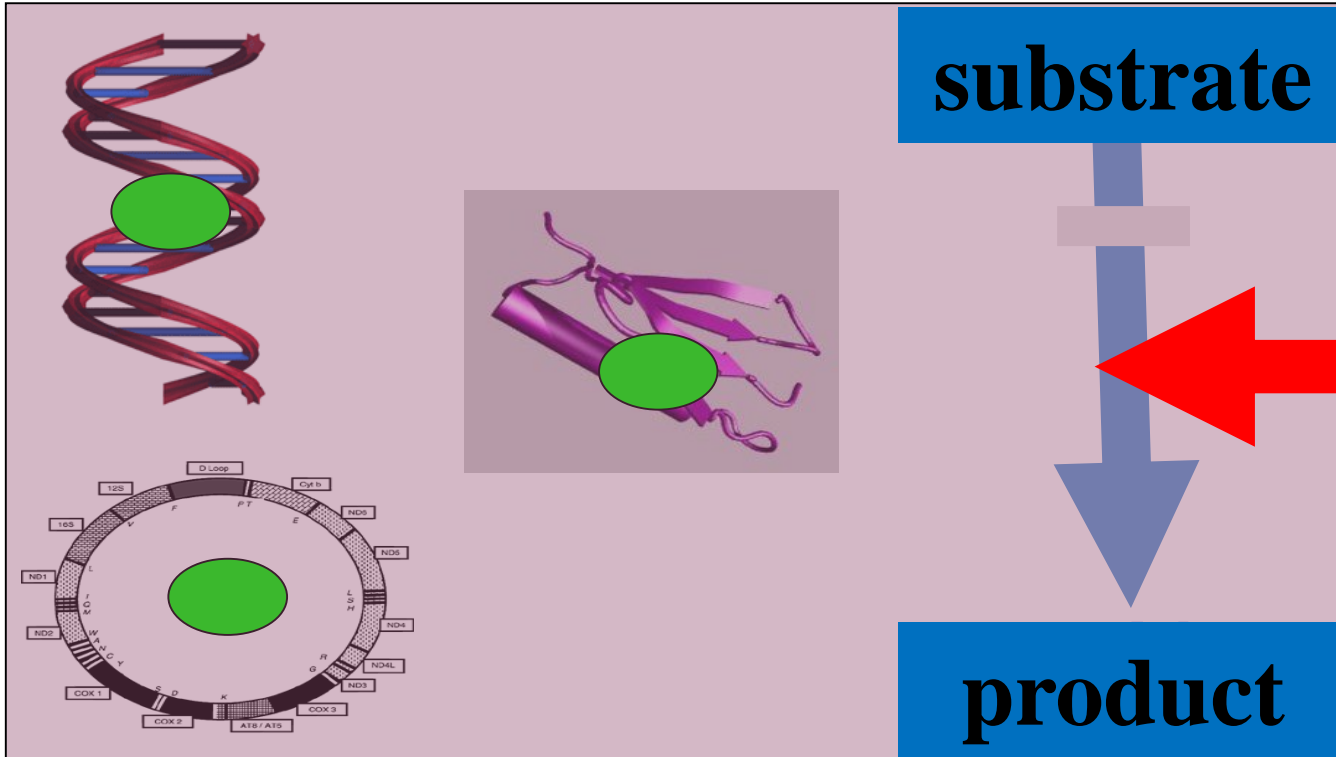

**DNA/RNA**  
screening  
scanning  
sequencing

**Enzymology**  
leuko/lymfo  
fibro  
muscle

**Metabolites**  
analyte  
profile of analytes  
urine/blood/liquor

**Symptoms**  
specific  
nonspecific  
coma  
PMR  
dysmorphia  
hepato/myopathies

# The clinical picture of HMD - bodies

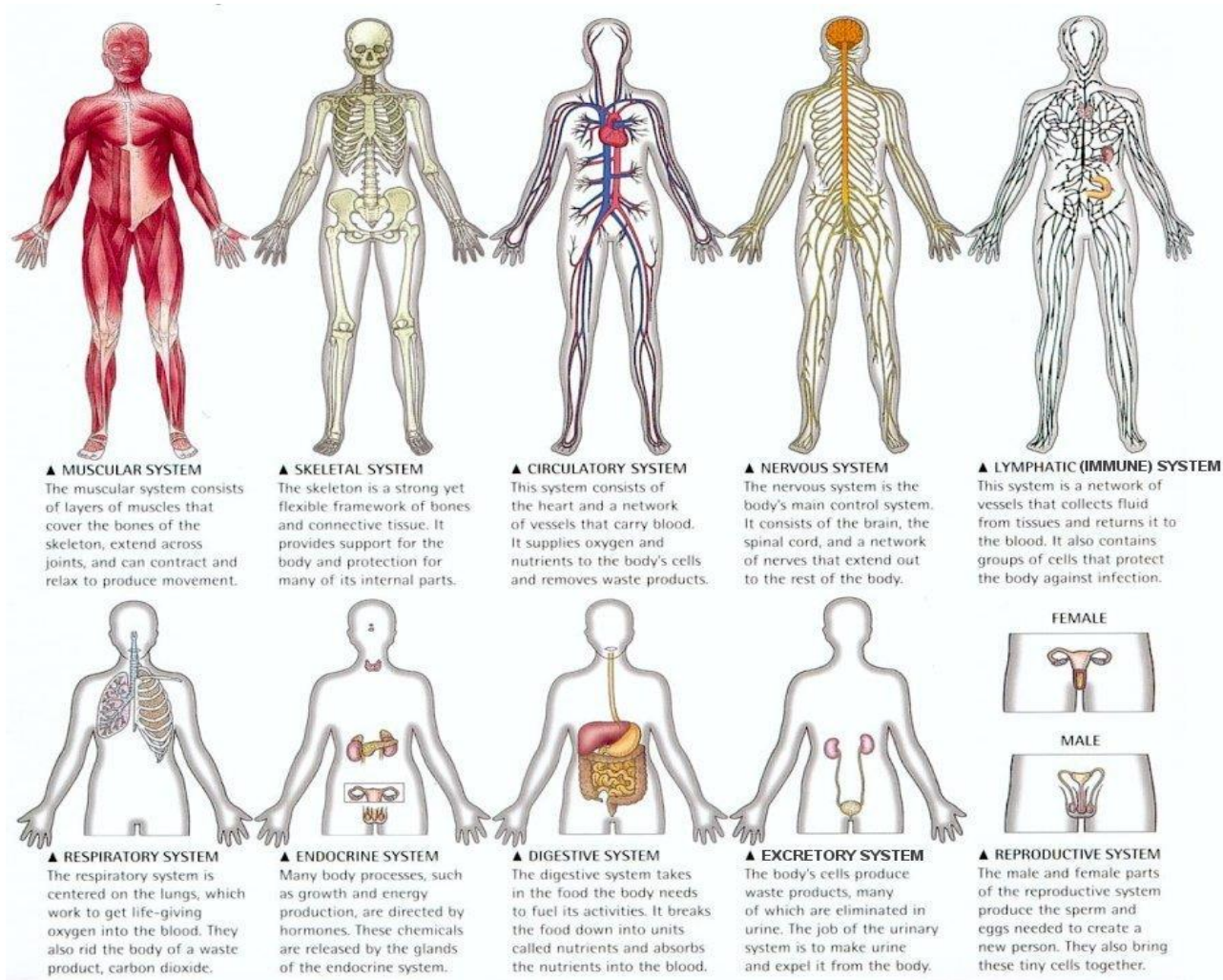

# The basic situation of the differential diagnosis of HMDT

- **Small molecules**

- acutely ill newborn baby
- (repeated) prolonged unconsciousness attack
- failure to thrive infants
- hypoglycaemia

- **Large molecules**

- progressive disabilities of CNS and muscle
- facial dysmorphism
- organomegaly (liver, spleen, heart)

# Abnormal smell and color of urine

- smell (small volatile molecules):

- sweaty feet - isovalerate
- caramel/maple syrup - oxoacids
- cooked cabbage - methionine oxide
- fish smell - trimethylamine
- black currant - some organic acids
- mouse smell - phenylacetate

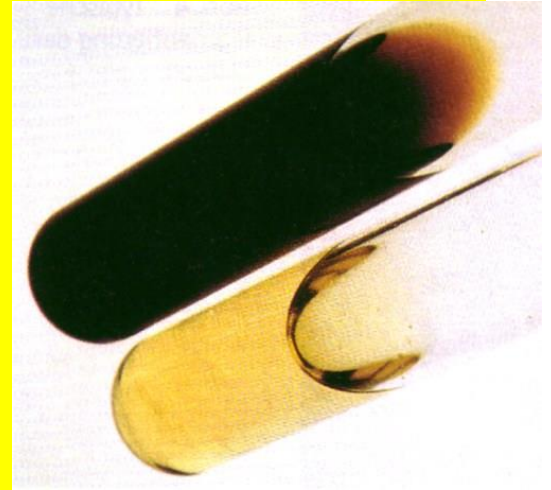

- coloring

- red-orange - urate
- black-brown in the oxidation - homogentisate
- blue - indoxalid derivates
- green - 4-OH-butyrate

# Common laboratory findings in HMD

## Blood

- glycemia
- cholesterol
- TG
- urine acid
- MAc
- hyperamonemia, RAlk
- ALT, AST
- CK
- anemia/pancytopenia

## Urine

- ketones
- urine acid
- crystalluria
- myoglobinuria

# HMD-diagnostic of metabolites

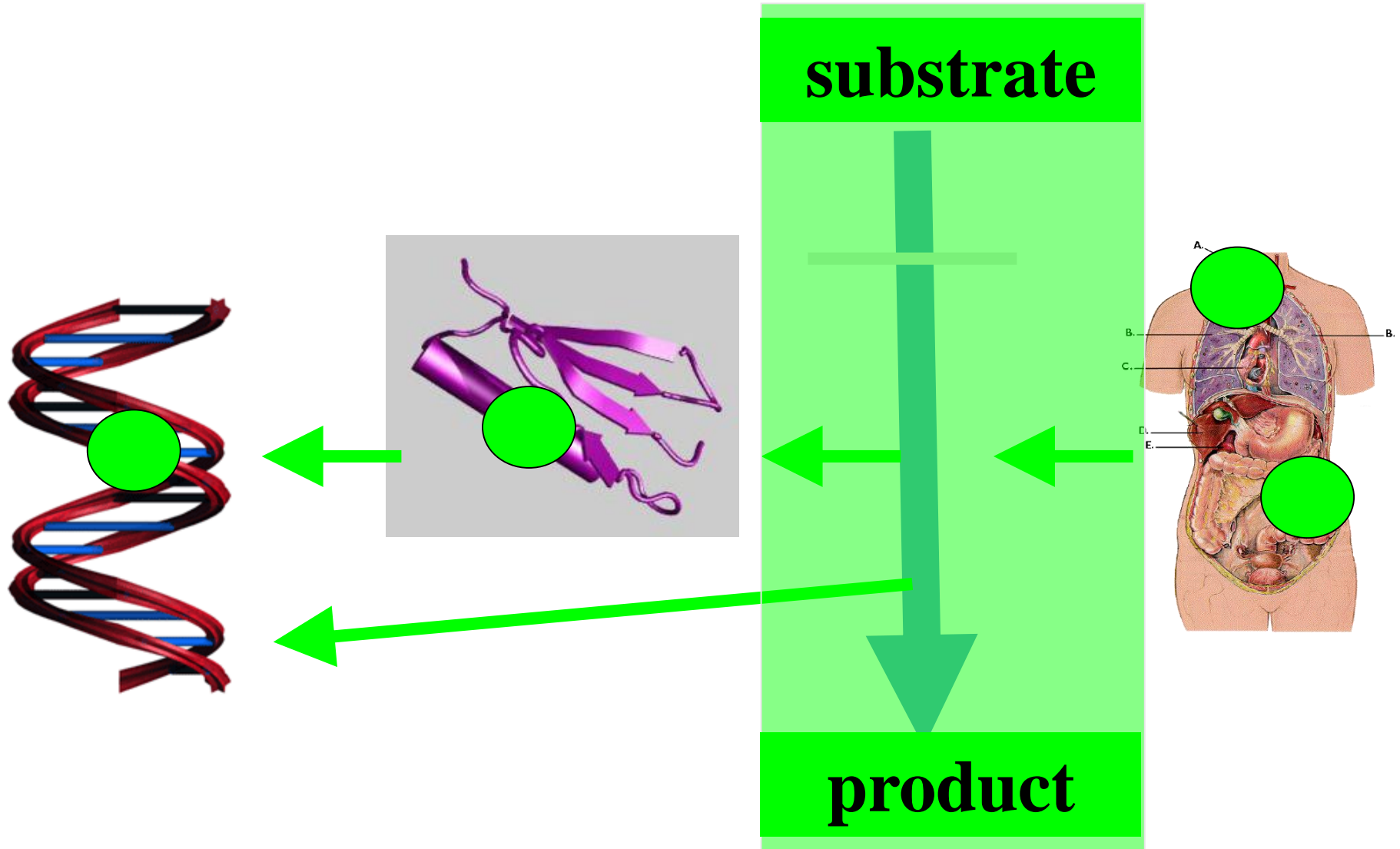



# Sensitivity of methods

- Alkaptonuria: 1-5 g homogentisate /day
- Cystinuria: 1-5 g cystine/day

Urine - liters for analysis

- Phenylketonuria: 0.1 g phenylalanine /l of blood
- MCAD: C8 acylcarnitine 0.0001 g / l of blood

0.2 - 1 ml serum

Blood paper about 0.05 ml of blood

# Amino acids - citrulinemia

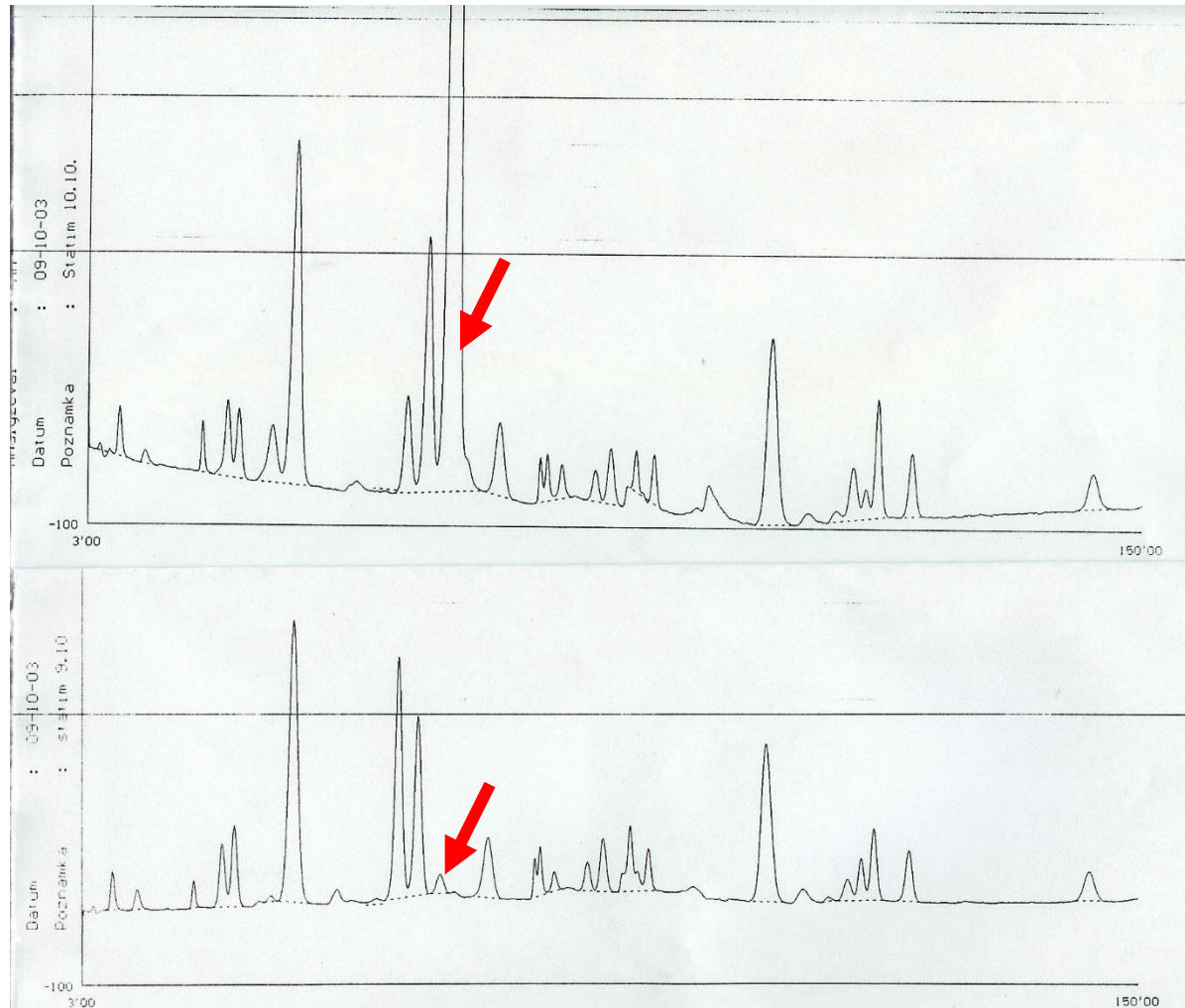

# GC-MS: methylmalonic aciduria

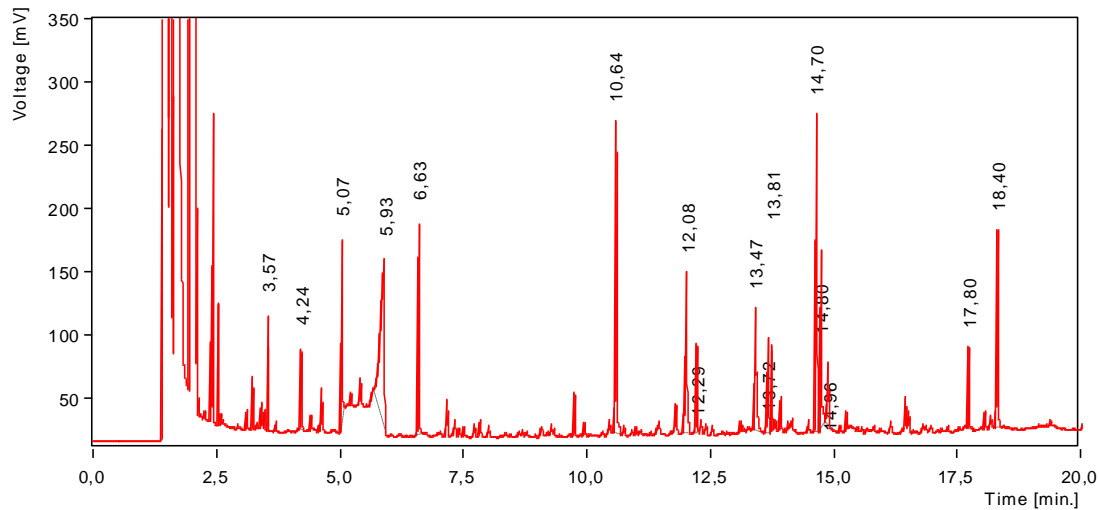
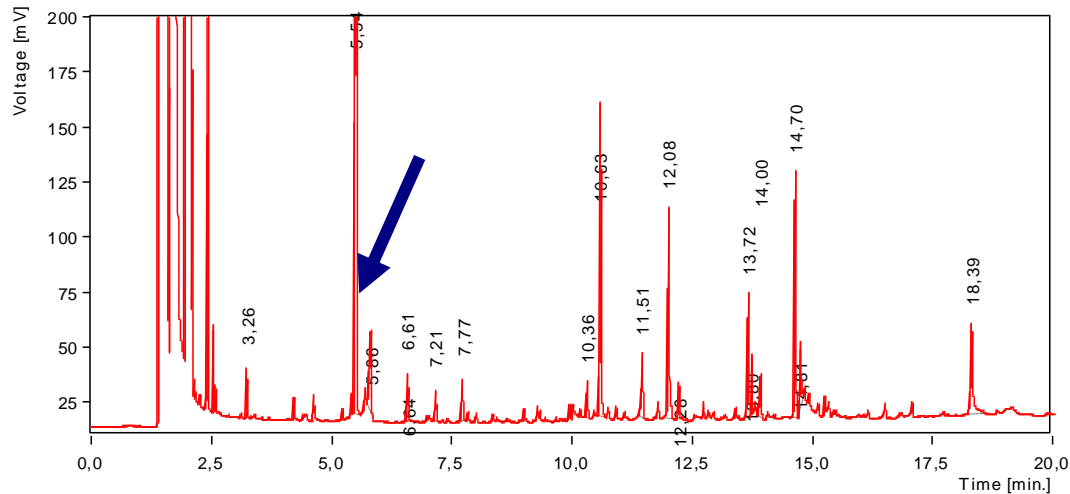

# GC-MS: MCAD

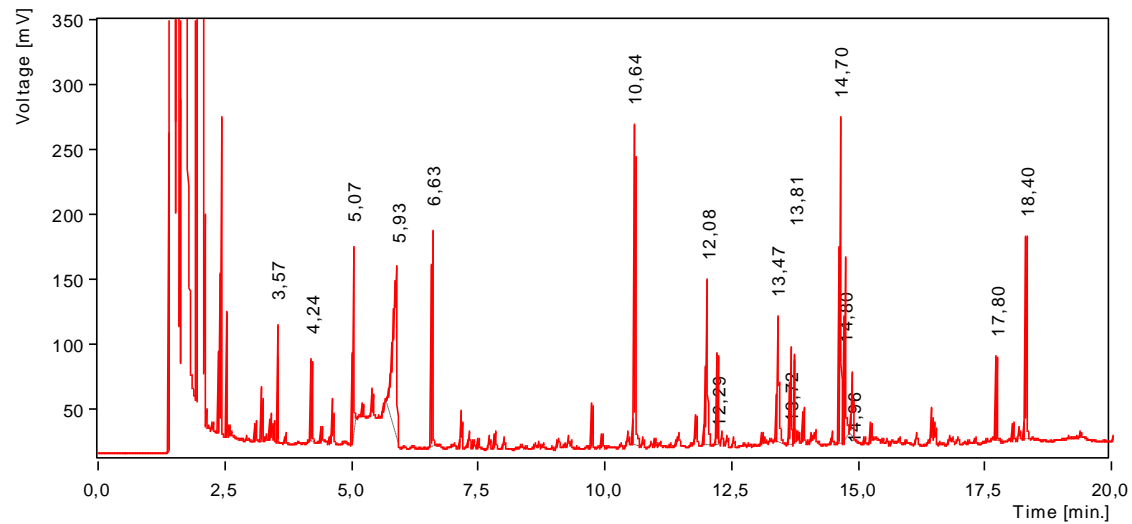
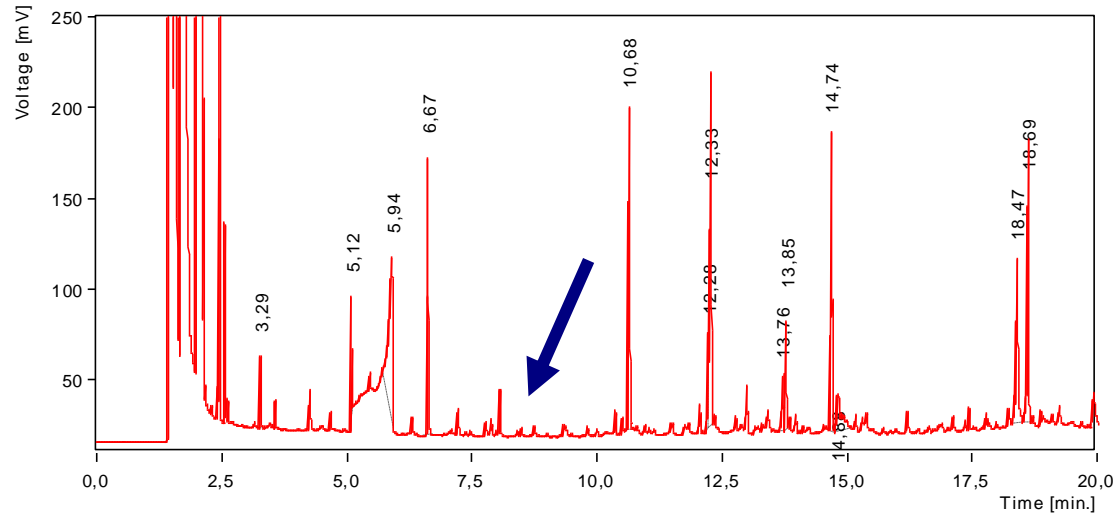

# MPS I – Hurler disease (deficiency of $\alpha$ –iduronidase)



MPS I in a 6-year-old girl

lent by Dr.Ledvinová

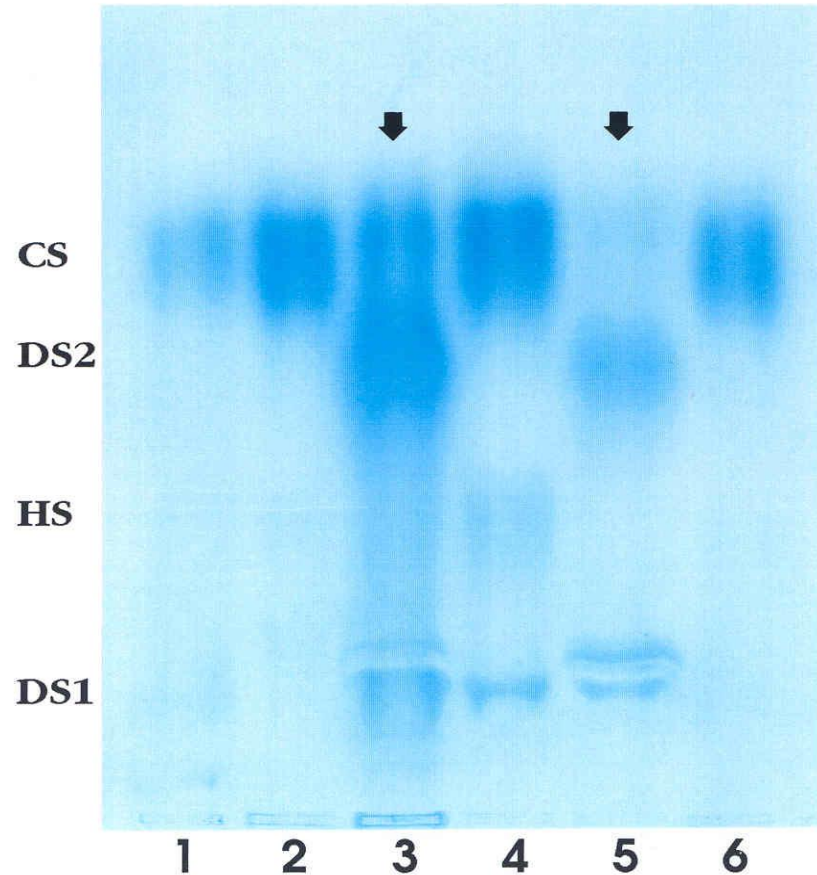

Electrophoresis of urinary GAGs  
(*excretion of dermatan sulphate/DS and heparan sulphate/HS* )

# Glycoproteinosas – HPTLC oligosaccharides in urine

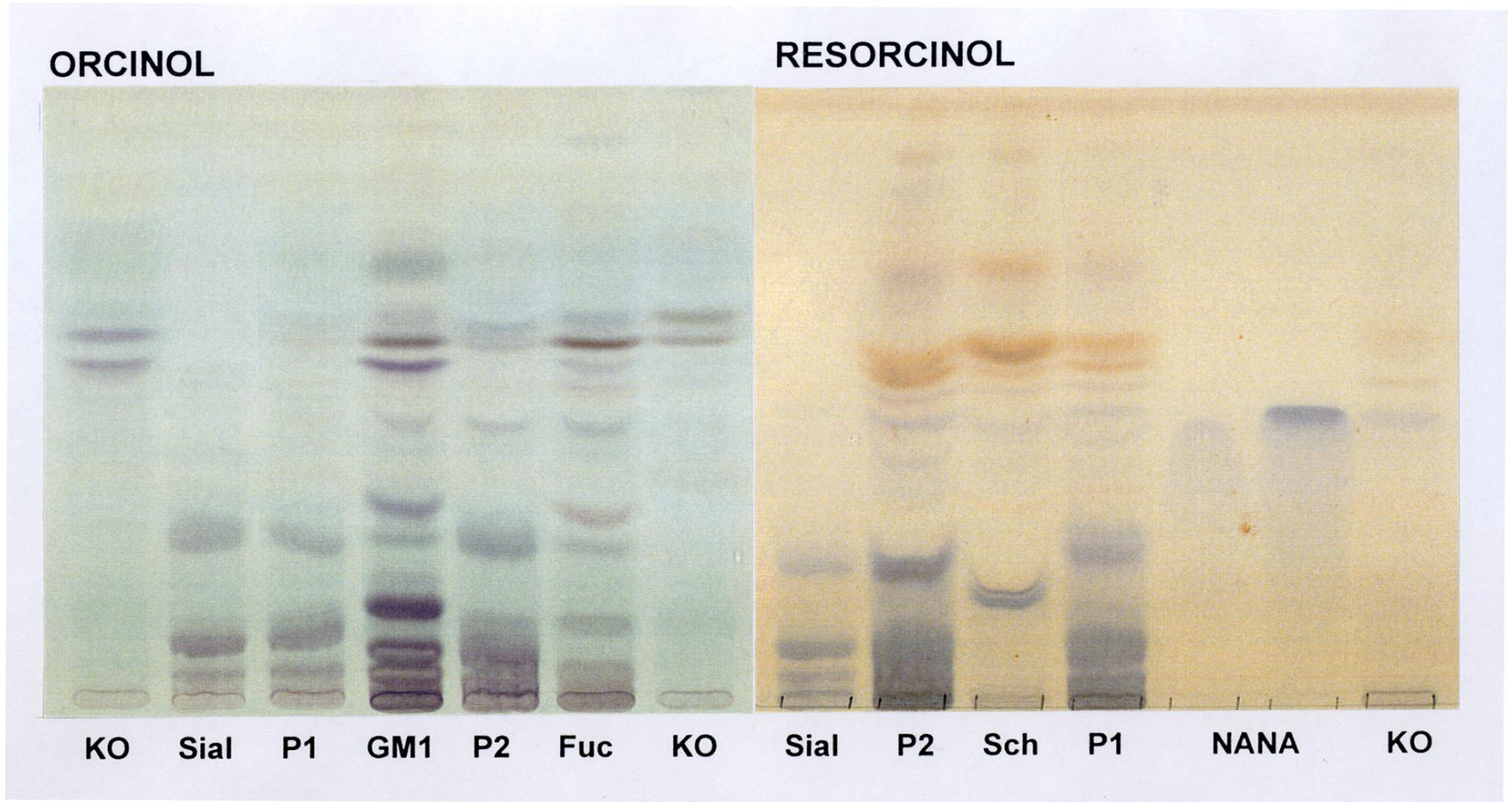

lent by Dr.Ledvinová

# Diagnostics of HMD

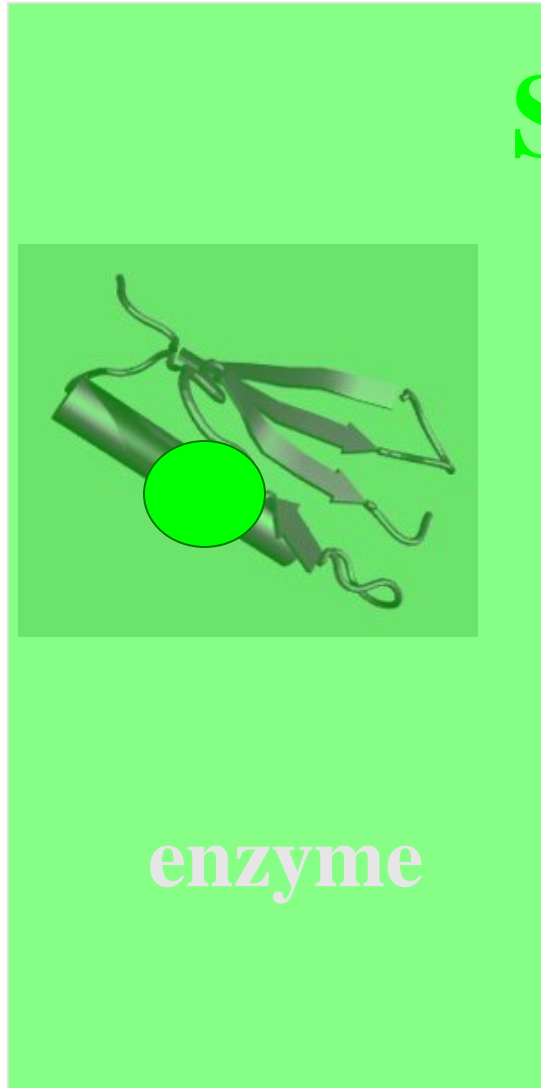
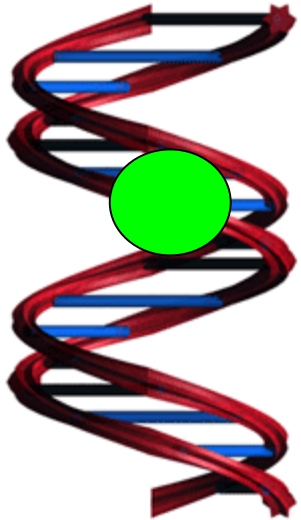

**Substrate**

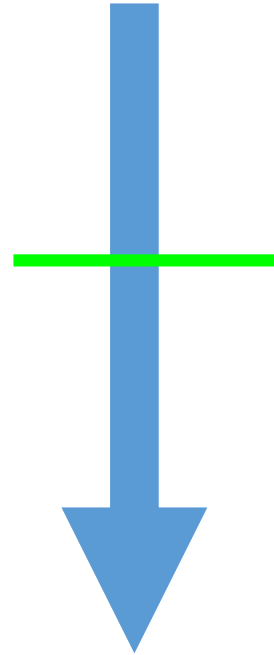

**product**

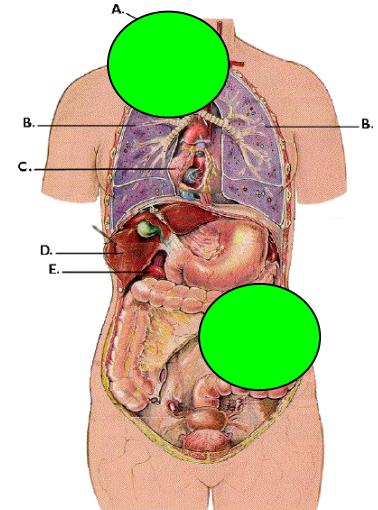

# Principles of enzymatology examination

- Separation of **substrate** and **product**
- Quantification of gain or loss

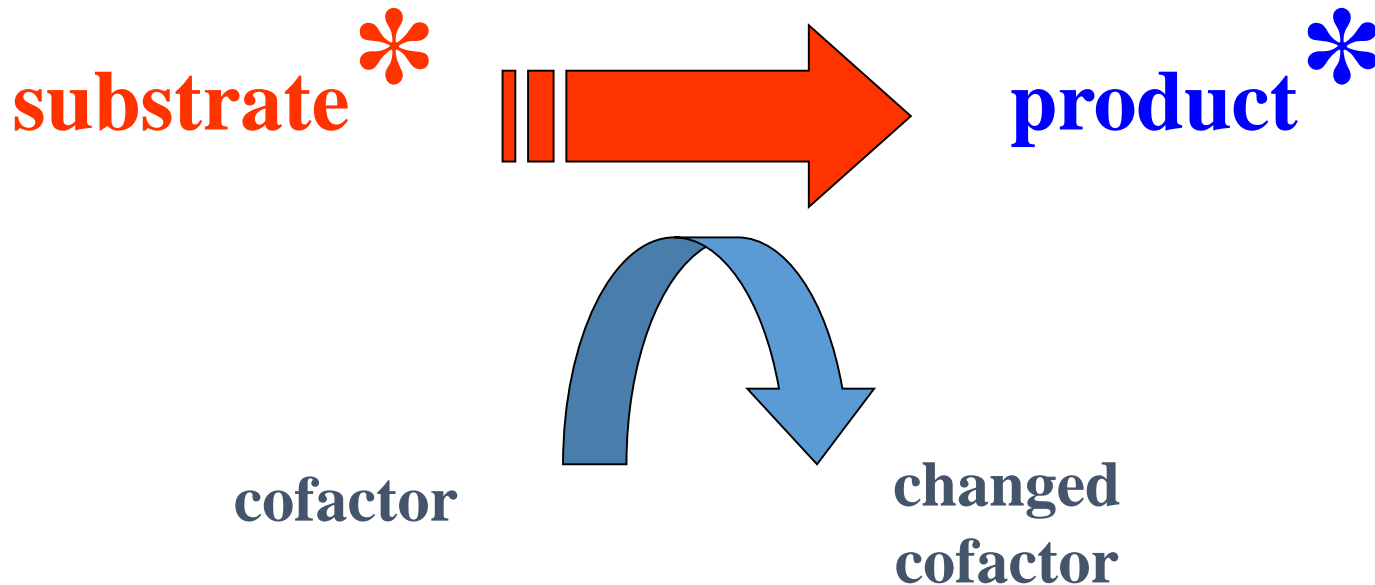

- Quantification of gain or loss



# Assessment of enzymes in HMD

- Cells are usually necessary
- Leukocytes, fibroblasts
- Fetal tissues and fetal (germ) layers
- Fluorimetric and radiometric techniques (eventually photometric)
- Measured parameter: the loss of substrate or the product formation
- **46 enzymes**

# Typical results of enzymology

- Afflicted homozygotes clearly deficient
- Heterozygotes: overlay
- Healthy homozygotes: usually normal distribution of activity in population

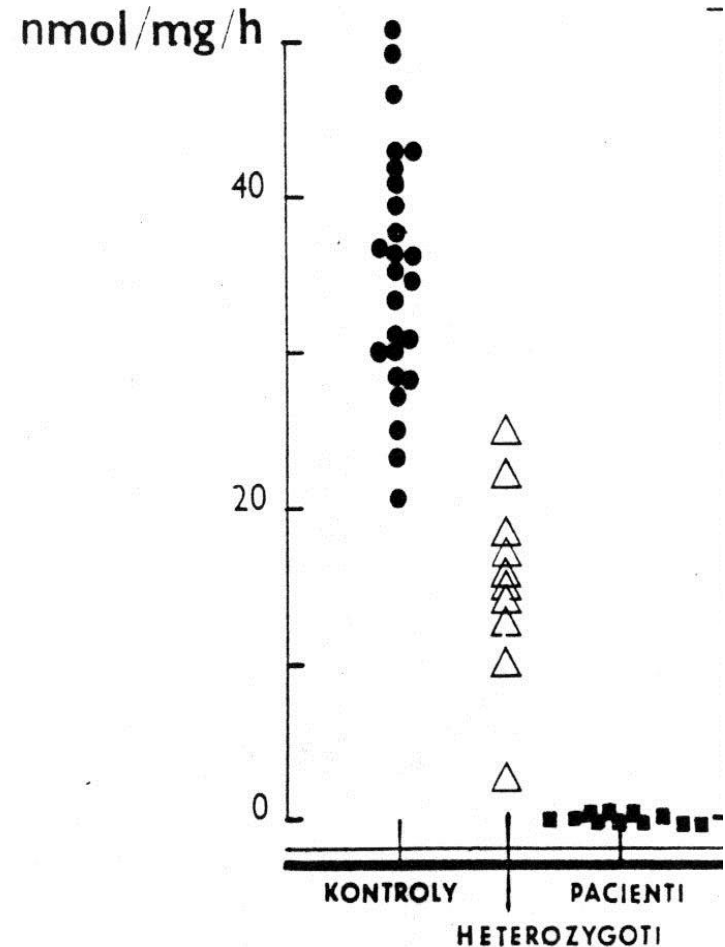

# Diagnostics of HMD

DNA

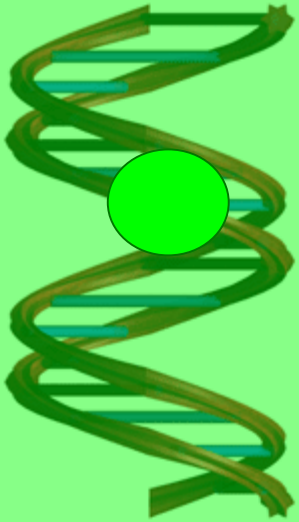

Substrate

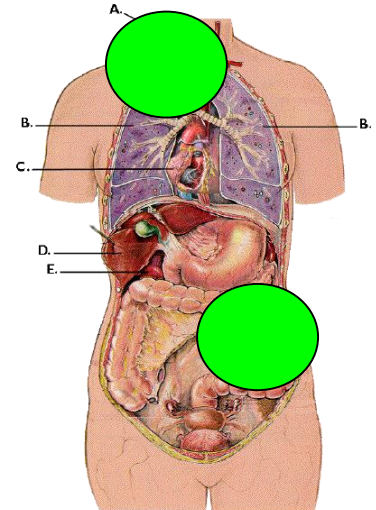
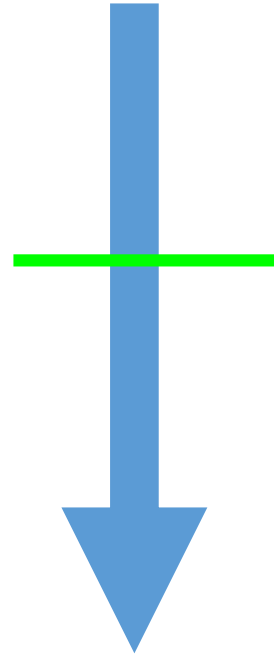
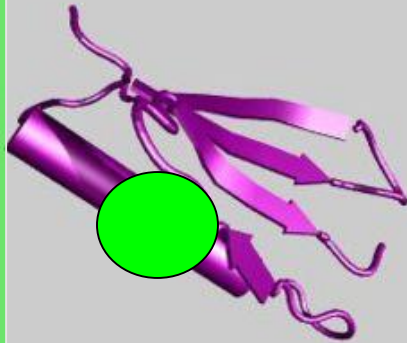

product

# OTC: Mutation c. 829 C>T (R277W)

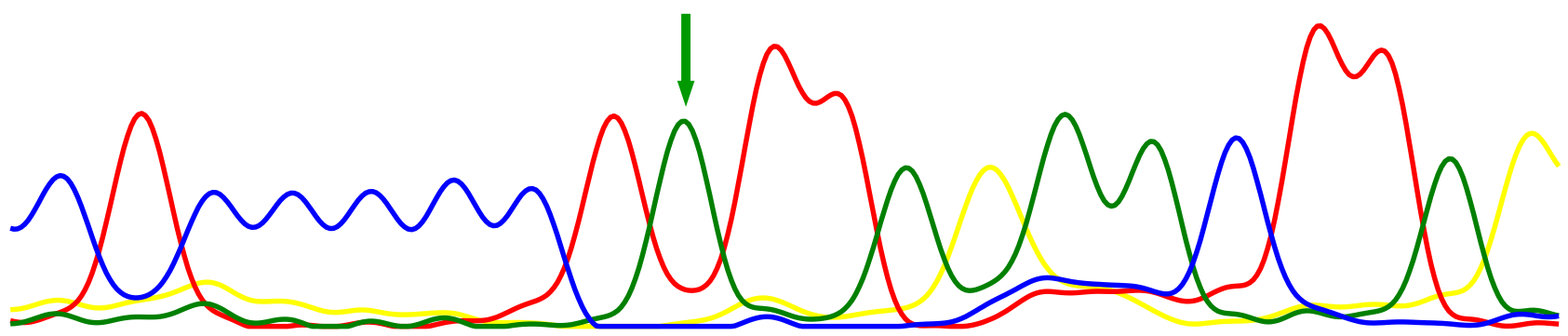
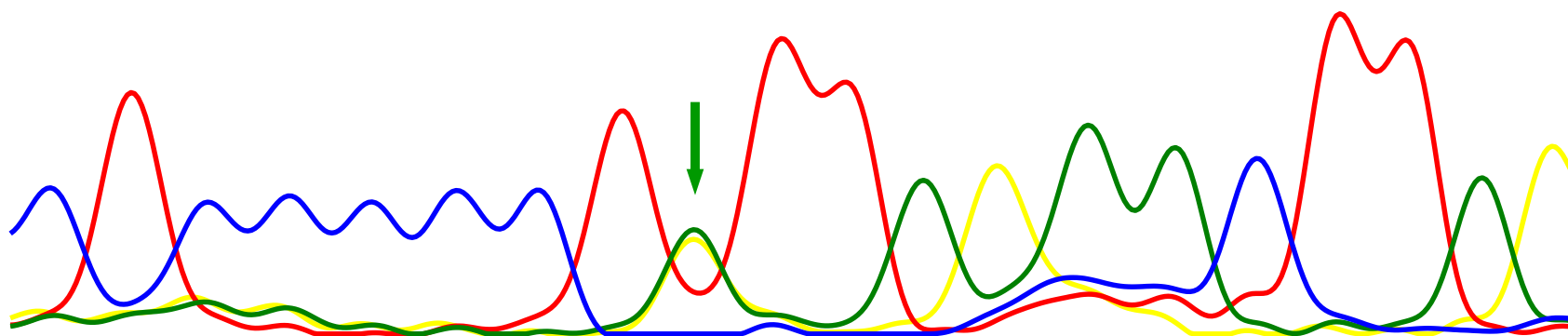
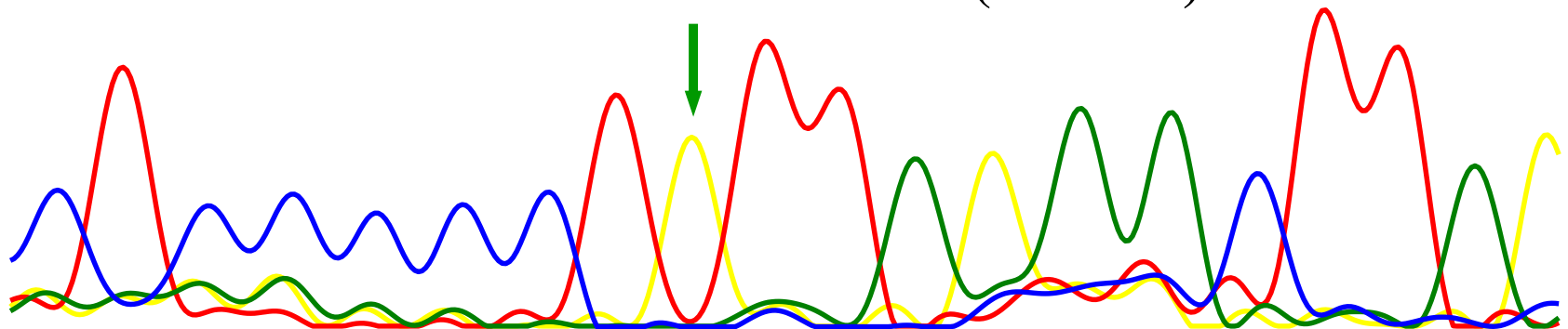

**A G A A A A A G T / C G G C T C C A G G C T**

## The normal sequence

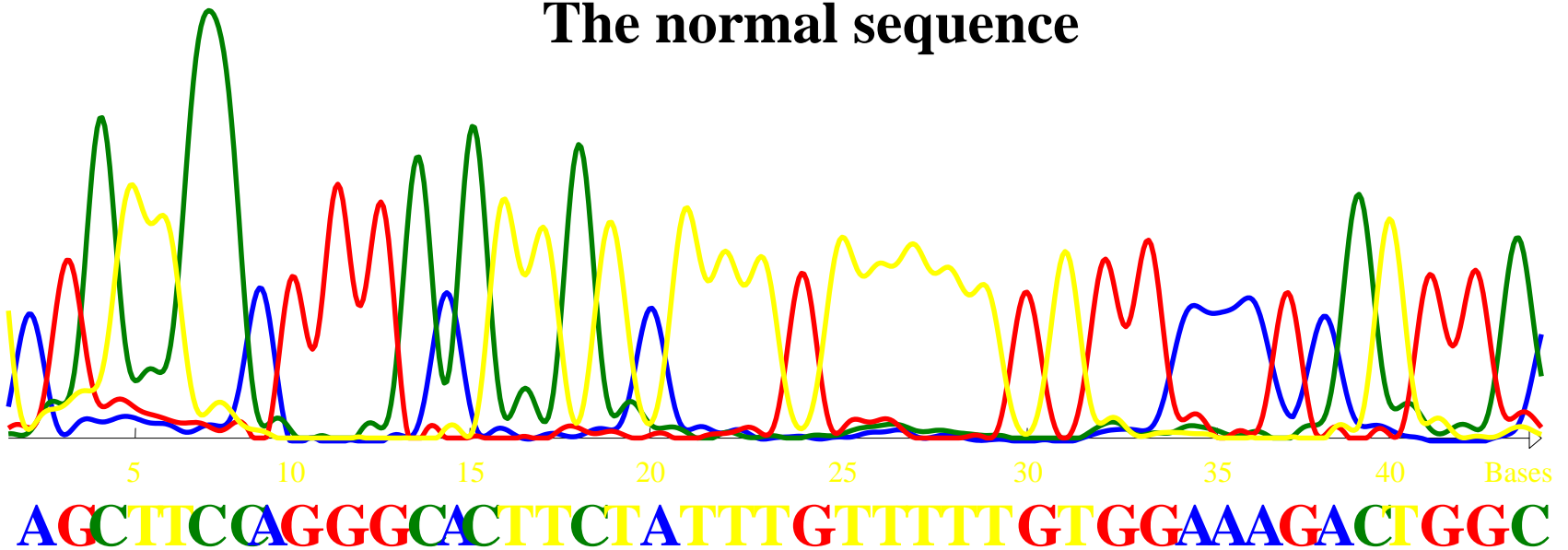

## Heterozygous deletion

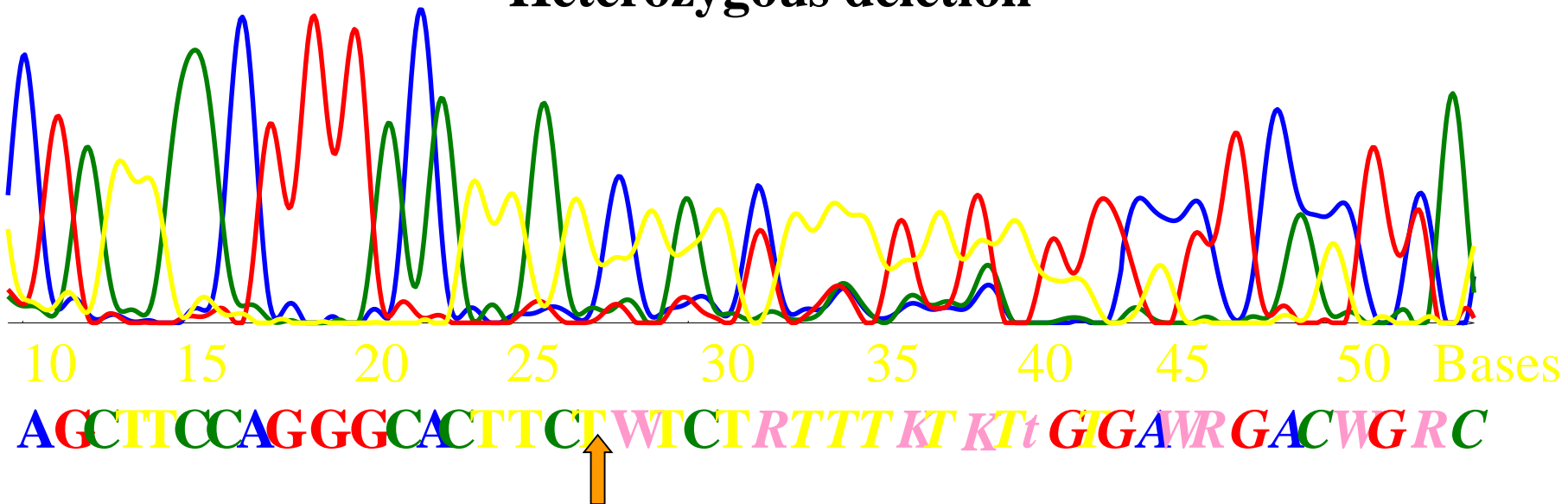

# Treatment of HMD

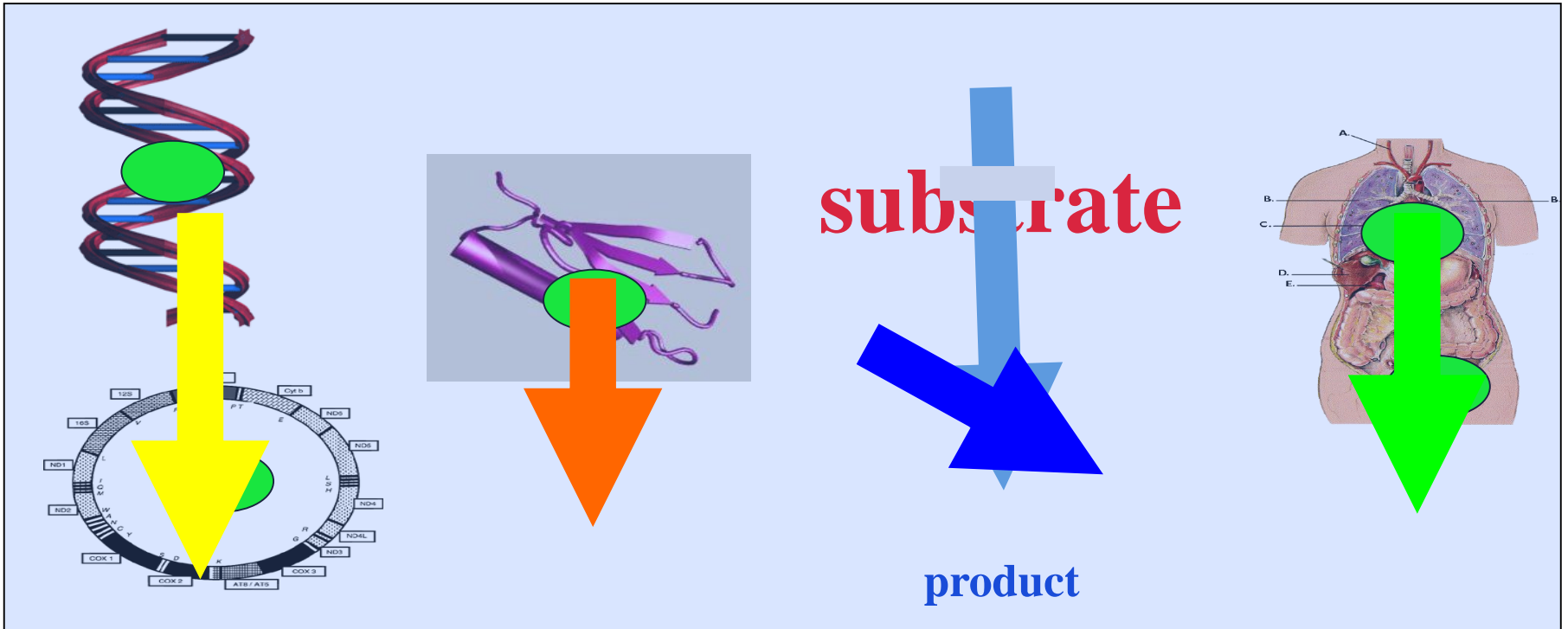

# Treatment of HMD

1. At the metabolite level
  2. At the enzymatic level
  3. At the cell level
- The only causal treatment- at the cell level.
  - Symptomatic and supportive treatment- mitigates symptoms, not removing the cause.

# 1. Treatment at the metabolite level

- a) Restriction of the gain or the formation of toxic metabolites (eg. diet in PKU, galaktosemia, prevention of catabolism in aminoacidopathies, organic acidurias)
- b) Removal of toxic metabolites (peritoneal dialysis, hemodialysis, exchange transfusion) and the use of alternative metabolic pathways (eg. benzoate administration in hyperammonemia)
- c) Administration of metabolic inhibitors (eg. allopurinol in hyperuricemia)
- d) Replacement of deficient products (eg. arginine in disorders of the urea cycle, tyrosine in PKU)



## 2. Treatment at the enzymatic level

- a) **Activation of enzyme** by coenzymes delivery at pharmacological doses( eg. pyridoxine in deficiency of cystathionine  $\beta$ -synaze)
- b) **Delivery of the deficient enzyme** directly - enzyme (eg. in Gaucher and Fabry disease, some types mukopolysachyridoses or glycogenoses)

### 3. Treatment at the cell level

- **Gene therapy** with viral or non-viral vectors (yet with no DPM is not used routinely, has its pitfalls)
- A special place in the treatment takes **transplantation of organs and tissues** (eg. liver in tyrosinemia , kidney in cystinosis, bone marrow in adrenaleukodystrofia)

# Treatment 1- causal

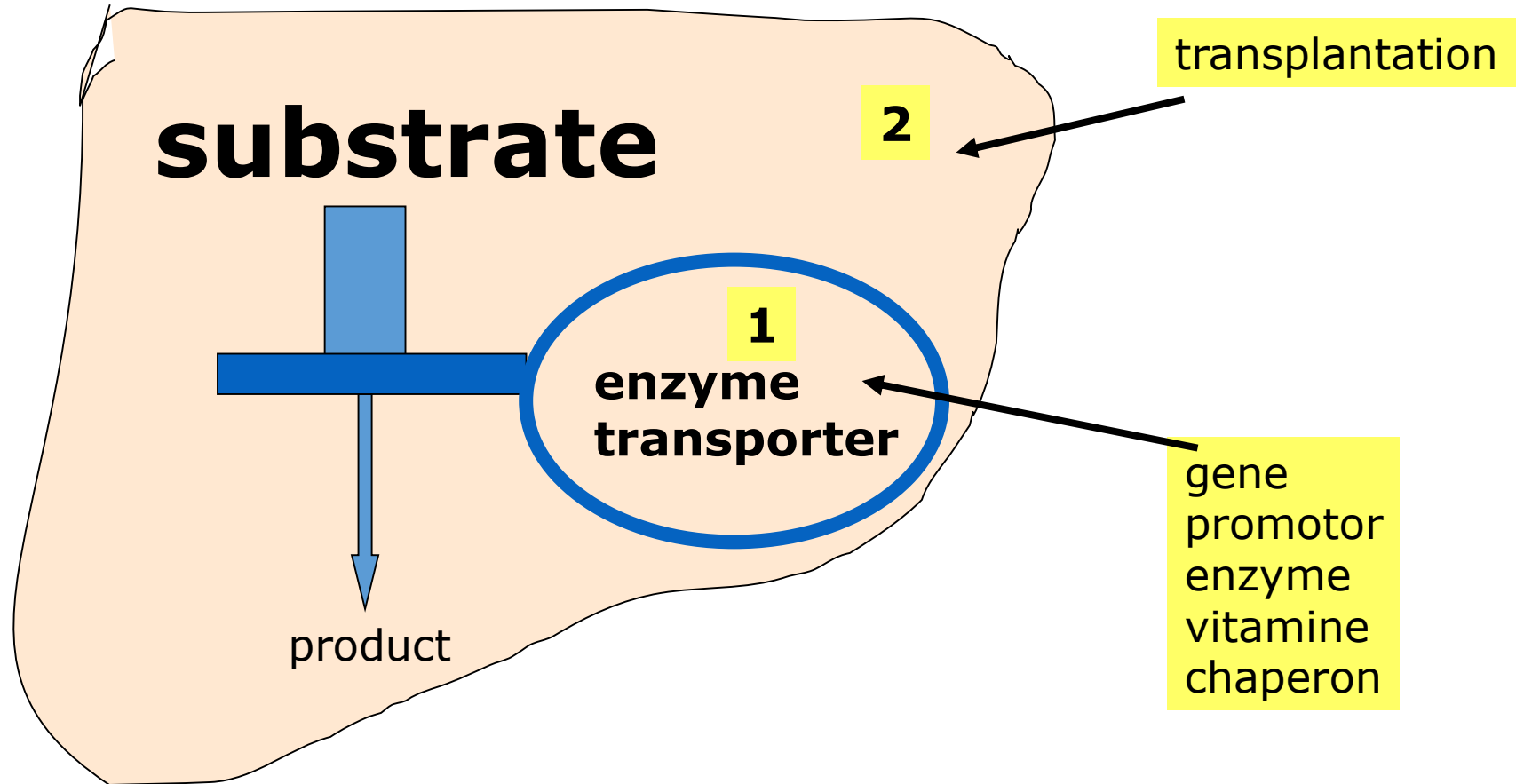

## Treatment 2- influence the path

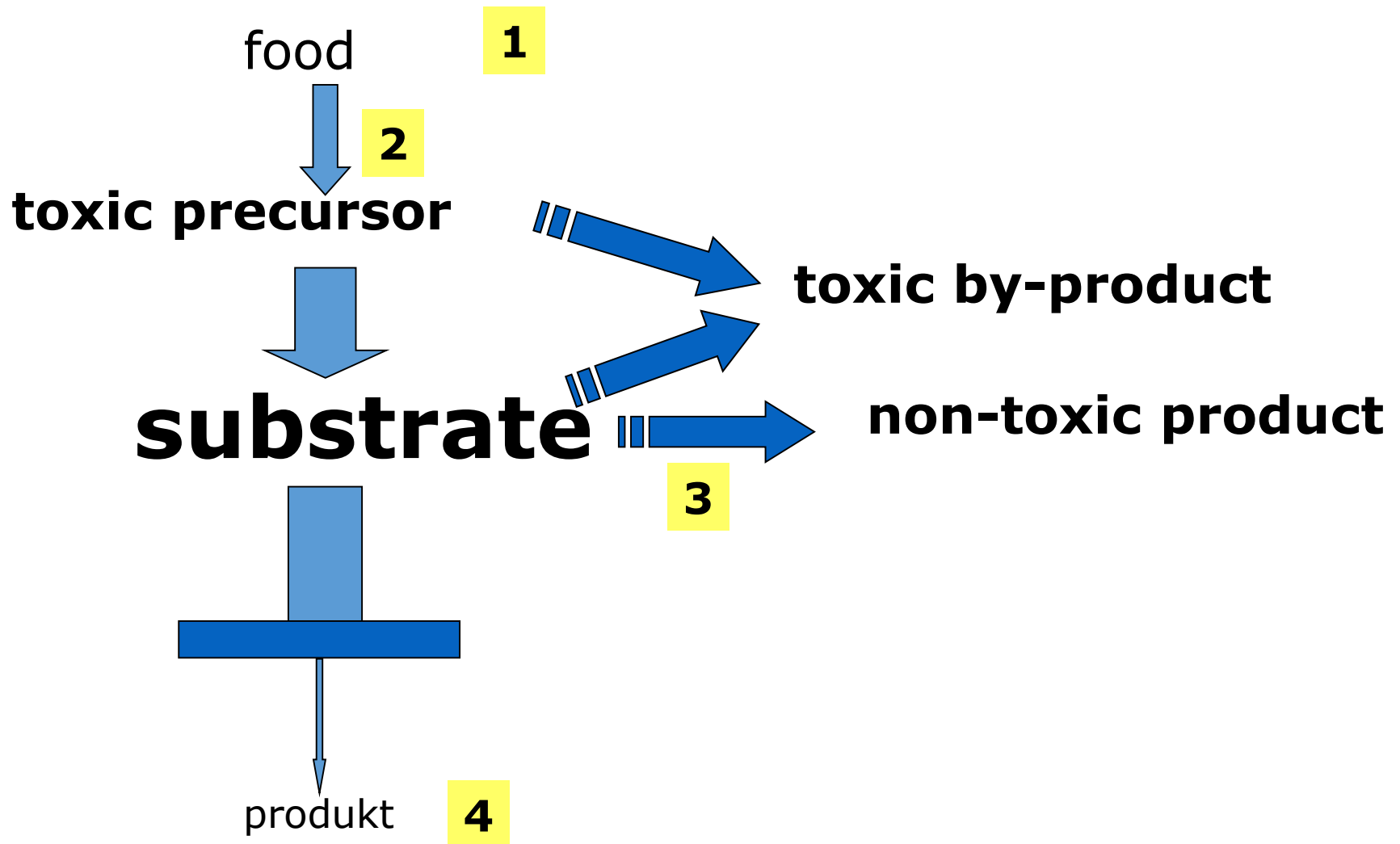

# Treatment 3- systematic

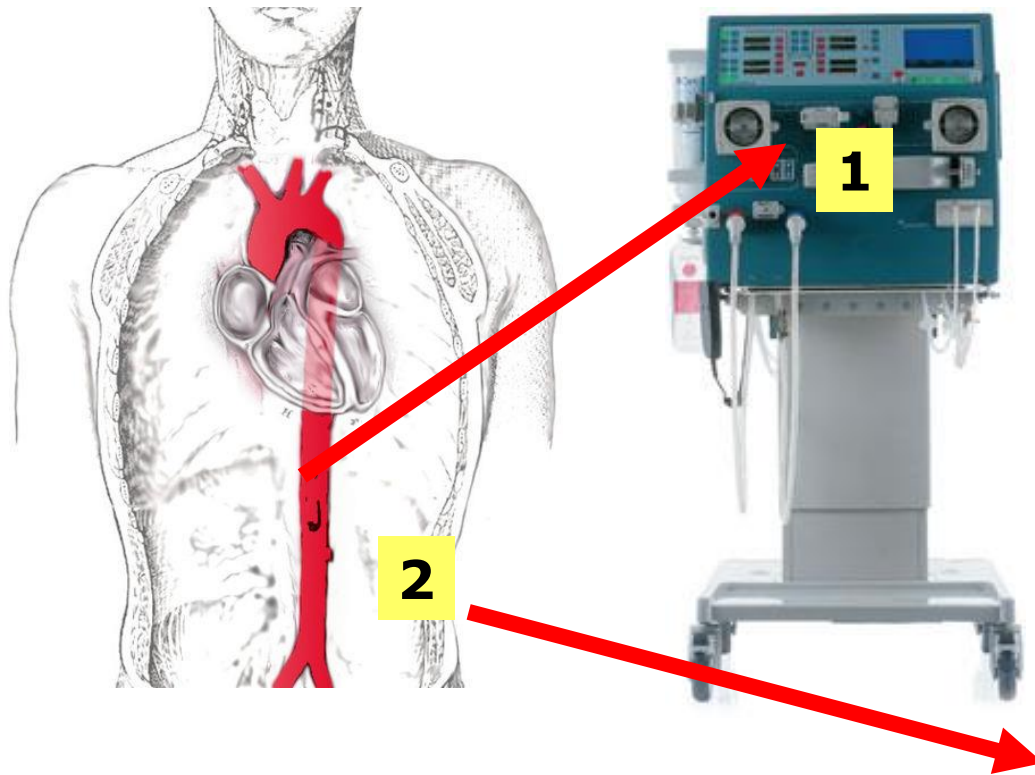

**Elimination of toxins**  
hemodialysis  
Hemadsorption  
Exchange transfusion

**General treatment**  
Energy  
E  
Hydration  
Treatment of infections  
Etc.

- Gene Therapy has made important medical advances in less than two decades. Within this short time span, it has moved from the conceptual stage to technology development and laboratory research to clinical translational trials for a variety of deadly diseases. Among the most notable advancements are the following:
- **Gene Therapy for Genetic Disorders**
- **Severe Combined Immune Deficiency (ADA-SCID)** ADA-SCID is also known as the bubble boy disease. Affected children are born without an effective immune system and will succumb to infections outside of the bubble without bone marrow transplantation from matched donors. A landmark study representing a first case of gene therapy "cure," or at least a long-term correction, for patients with deadly genetic disorder was conducted by investigators in Italy. The therapeutic gene called ADA was introduced into the bone marrow cells of such patients in the laboratory, followed by transplantation of the genetically corrected cells back to the same patients. **The immune system was reconstituted in all six treated patients without noticeable side effects, who now live normal lives with their families without the need for further treatment.**

### **Chronic Granulomatus Disorder (CGD)**

CGD is a genetic disease in the immune system that leads to the patients' inability to fight off bacterial and fungal infections that can be fatal. Using similar technologies as in the ADA-SCID trial, investigators in Germany treated two patients with this disease, whose reconstituted immune systems have since been able to provide them with full protection against microbial infections for at least two years.

- **Hemophilia**  
Patients born with Hemophilia are not able to induce blood clots and suffer from external and internal bleeding that can be life threatening. In a clinical trial conducted in the United States , the therapeutic gene was introduced into the liver of patients, who then acquired the ability to have normal blood clotting time. The therapeutic effect however, was transient because the genetically corrected liver cells were recognized as foreign and rejected by the healthy immune system in the patients. This is the same problem faced by patients after organ transplantation, and curative outcome by gene therapy might be achievable with immune-suppression or alternative gene delivery strategies currently being tested in preclinical animal models of this disease.
- **Other genetic disorders** After many years of laboratory and preclinical research in appropriate animal models of disease, a number of clinical trials will soon be launched for various genetic disorders that include congenital blindness, lysosomal storage disease and muscular dystrophy, among others.

# Gene Therapy for Acquired Diseases

- **Cancer** Multiple gene therapy strategies have been developed to treat a wide variety of cancers, including suicide gene therapy, oncolytic virotherapy, anti-angiogenesis and therapeutic gene vaccines. Two-thirds of all gene therapy trials are for cancer and many of these are entering the advanced stage, including a **Phase III trial of Ad.p53 for head and neck cancer and two different Phase III gene vaccine trials for prostate cancer and pancreas cancer**. Additionally, numerous Phase I and Phase II clinical trials for cancers in the brain, skin, liver, colon, breast and kidney among others, are being conducted in academic medical centers and biotechnology companies, using novel technologies and therapeutics developed on-site.
- **Neurodegenerative Diseases** Recent progress in gene therapy has allowed for novel treatments of neurodegenerative diseases such as Parkinson's Disease and Huntington's Disease, for which exciting treatment results have been obtained in appropriate animal models of the corresponding human diseases. Phase I clinical trials for these neurodegenerative disorders have been, or will soon be, launched.
- **Other acquired diseases**  
The same gene therapeutic techniques have been applied to treat other acquired disorders such as viral infections (e.g. influenza, HIV, hepatitis), heart disease and diabetes, among others. Some of these have entered, or will soon be entering, into early phase clinical trials.
- [www.asgct.org/about\\_gene\\_therapy/diseases.php](http://www.asgct.org/about_gene_therapy/diseases.php)
- [http://www.asgct.org/about\\_gene\\_therapy/diseases.php](http://www.asgct.org/about_gene_therapy/diseases.php)