

Antiviral drugs

1. Adamantane derivatives
2. Neuraminidase inhibitors
3. Viral replication inhibitors
4. Viral proteases inhibitors
5. Immunotherapeutics

Replication cycle of the influenza virus type A

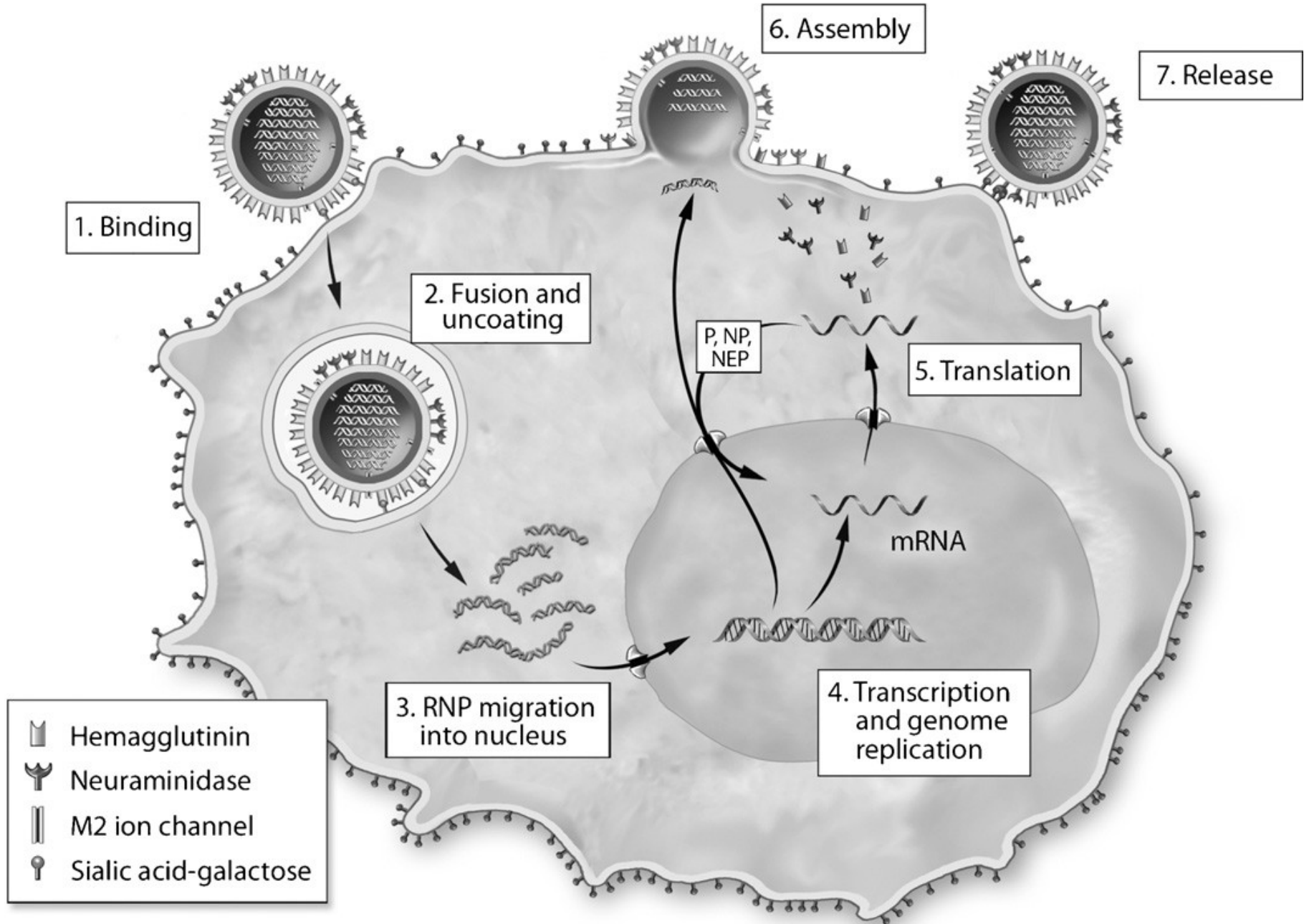

1. Adamantane derivatives

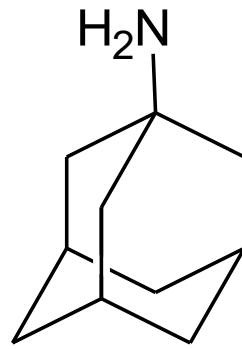

1-aminotricyklo[3.3.1.1]decane

1-aminoadamantane

amantadine

•also antiparkinsonic

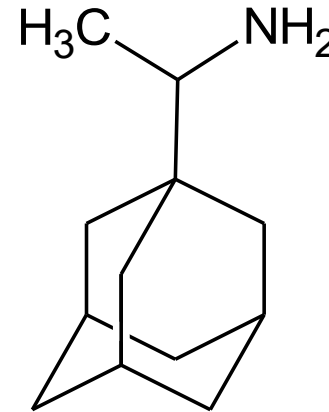

1-(1-aminoethyl)tricyklo[3.3.1.1]decane

1-(1-aminoethyl)adamantane

rimantadine

- against influenza of type A only; ineffective against swine influenza H1N1
- mechanism of action: inhibition of replication of influenza virus type A by blocking of transmembrane protein - proton channel M2
- mainly prophylactic
- frequent resistance (M gene mutation)
- adverse effects: frequent; sleeplessness, hallucinations, orthostatic hypotension, depressions, nausea, vomiting

Ion channel M2 of the influenza virus H1N1 2009 (swine influenza)

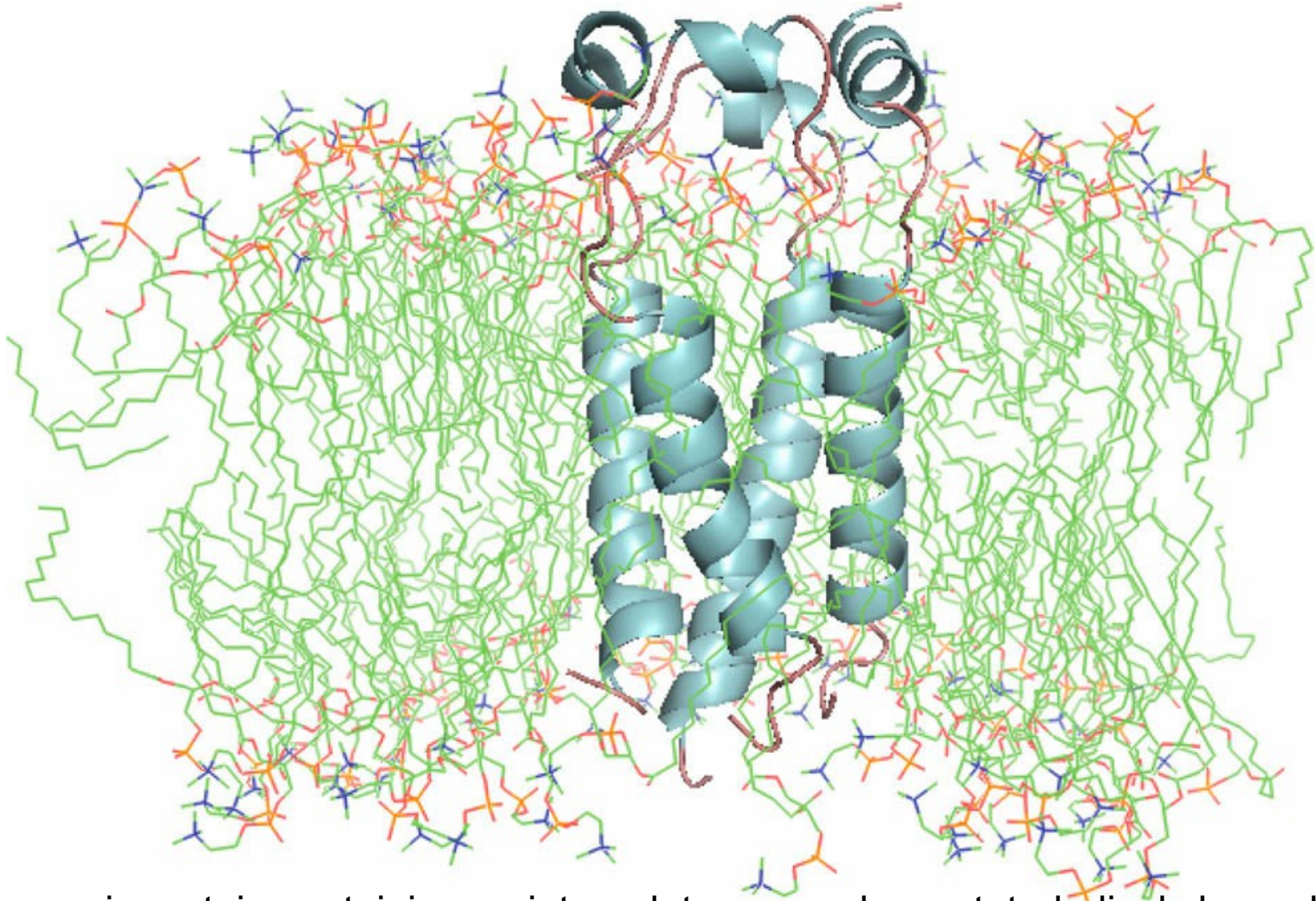

- homotetrameric protein containing an integral transmembrane tetrahelical channel consists of 97 amino acid rests in every unit; every unit contains the C-terminal domain from 54 AA, the transmembrane domain from 19 AA and the extracelullar N-terminal domain from 24 AA
- proton-selective channel is controlled by endosomal pH values; it leads endosomal protons into the virion
- this channel is probably fundamental for the life cycle of the virus

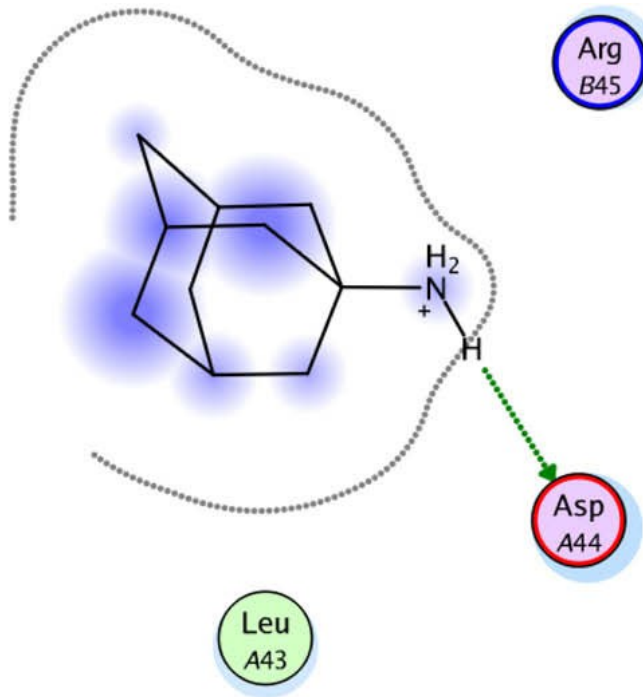
A

Interaction of adamantane with proton channel M2 of viruses H5N1 (A) and H1N1 (B)

- adamantane antiviralotics are bound to the outside „lipoid pocket“ near Trp41 (in addition H-bridge to Asp 44), the molecule acts as an „molecular wedge“, which stabilizes close conformation of the channel gate and increases energy barrier for its opening
- blue spots represent sizes or electron clouds of lipophilic fragments of M2 channel which interact with the drug by hydrophobic interactions

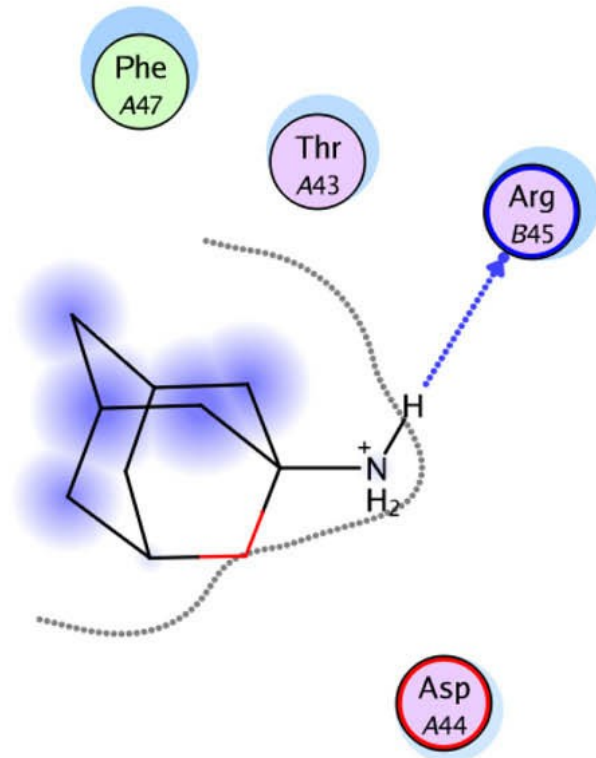
B

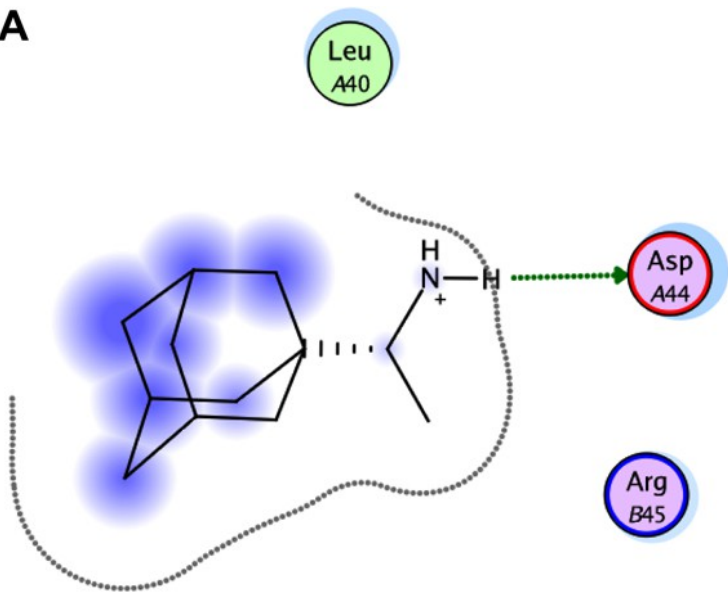
A

Interaction of rimantadine with proton channel M2 of H5N1 (A) and H1N1 (B) viruses

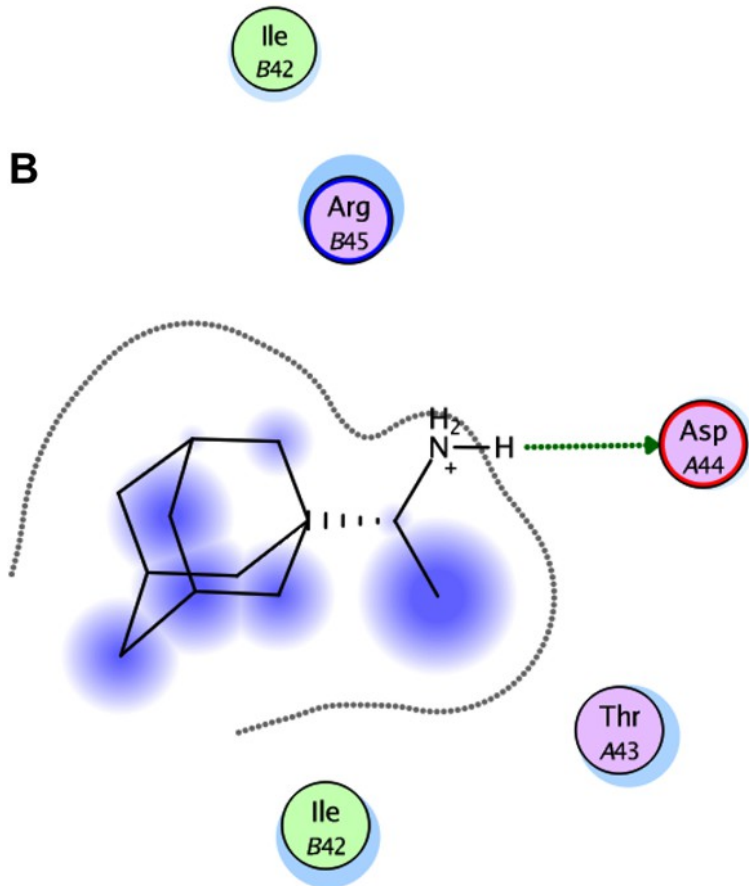
B

2. Viral neuraminidase inhibitors

Neuraminidase (sialidase, acyl-neuramidyl hydrolase):

- glycoprotein
- glucosidase which cleaves specifically glycoside bonds α -2 \rightarrow 3 and α -2 \rightarrow 6 to galactose
- enzyme cleaving N-acetylneuraminic acid away from more complex oligosaccharides on the cell surface and thus facilitating releasing of virions from the infected cell and their spreading to other cells of host organism
- also acts as a superficial antigen of the influenza virus with principal significance for the immunity response
- in mammals and birds, 9 neuraminidase serotypes and 16 hemagglutinin serotypes have been found up to now (hemagglutinin is also a superficial antigen)

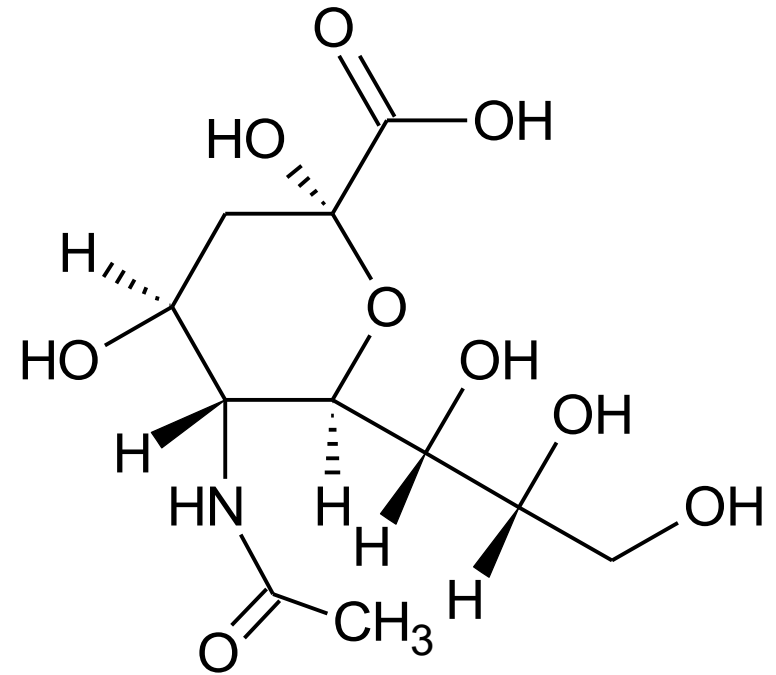

N-acetylneuraminic acid
Acneuramic acid [INN]

N-acetylneuraminic acid and 1st experimental neuraminidase inhibitors

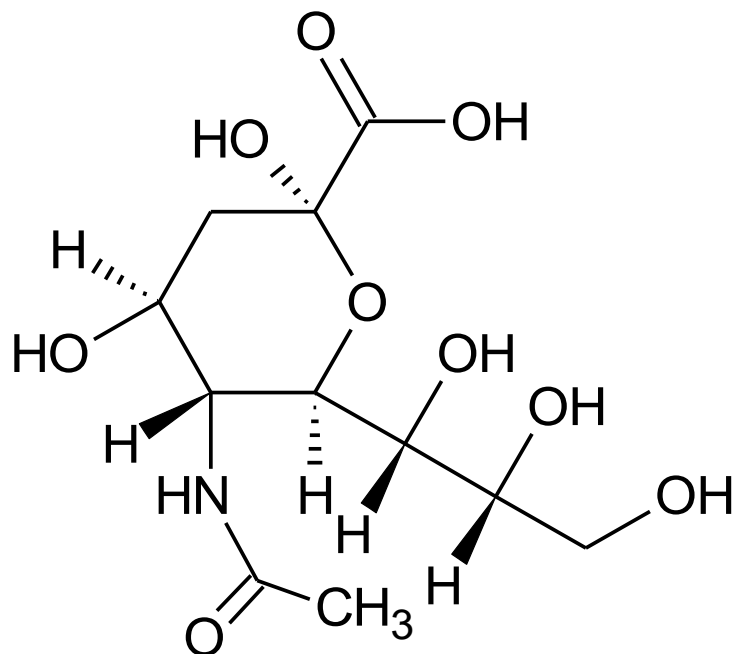

N-acetylneuraminic acid
Aceneuramic acid [INN]

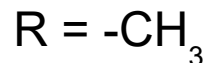
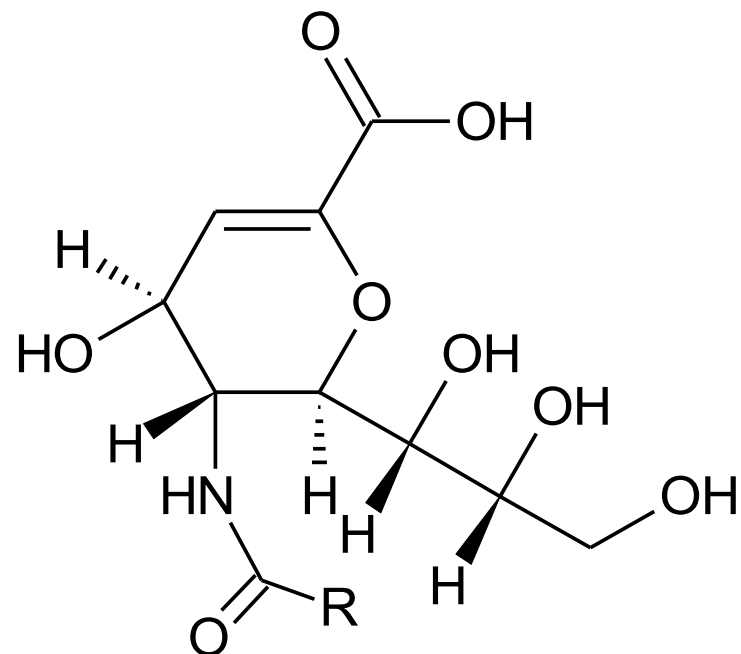

2-Deoxy-2,3-dehydro-N-
acetylneuraminic acid
DANA

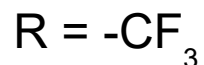

2-Deoxy-2,3-dehydro-N-
trifluoroacetylneuraminic acid
FANA

Viral neuraminidase inhibitors

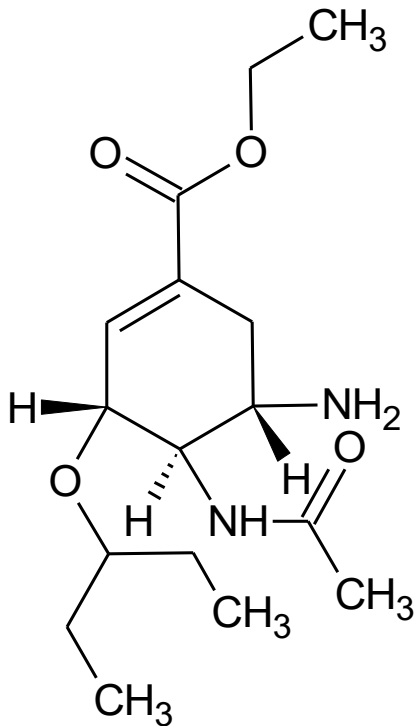

oseltamivir

Tamiflu[®] cps.

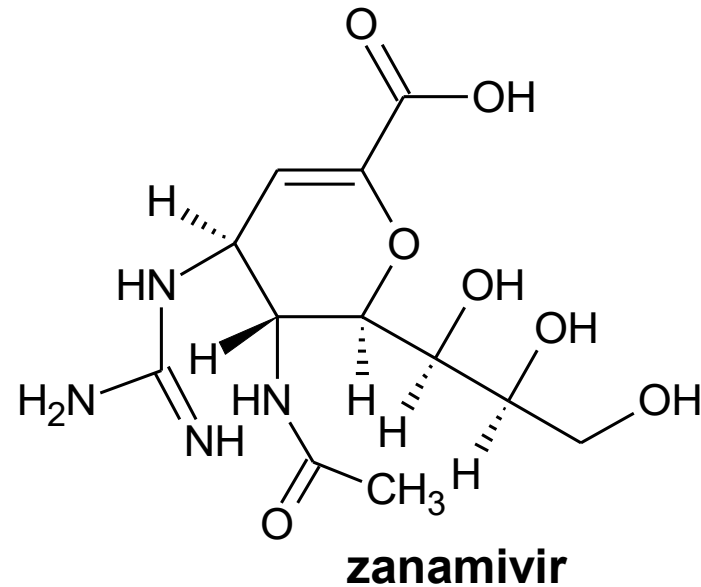

zanamivir

Relenza[®] inh. plv. dos.

- intranasal administration only
- dimeric and multimeric forms with expected greater activity, longer elimination half-time and greater bioavailability are being developed

• effective against H1N1 (swine), not against H5N1 (bird)

• development of forms for i.v. or i.m. administration

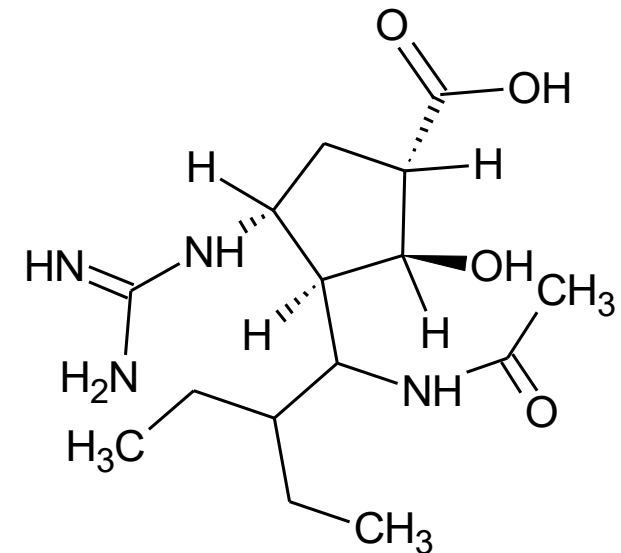

peramivir

BCX-1812

• i.v. administration

Rapivab[®]

approved in the
U.S.A December
14th, 2014

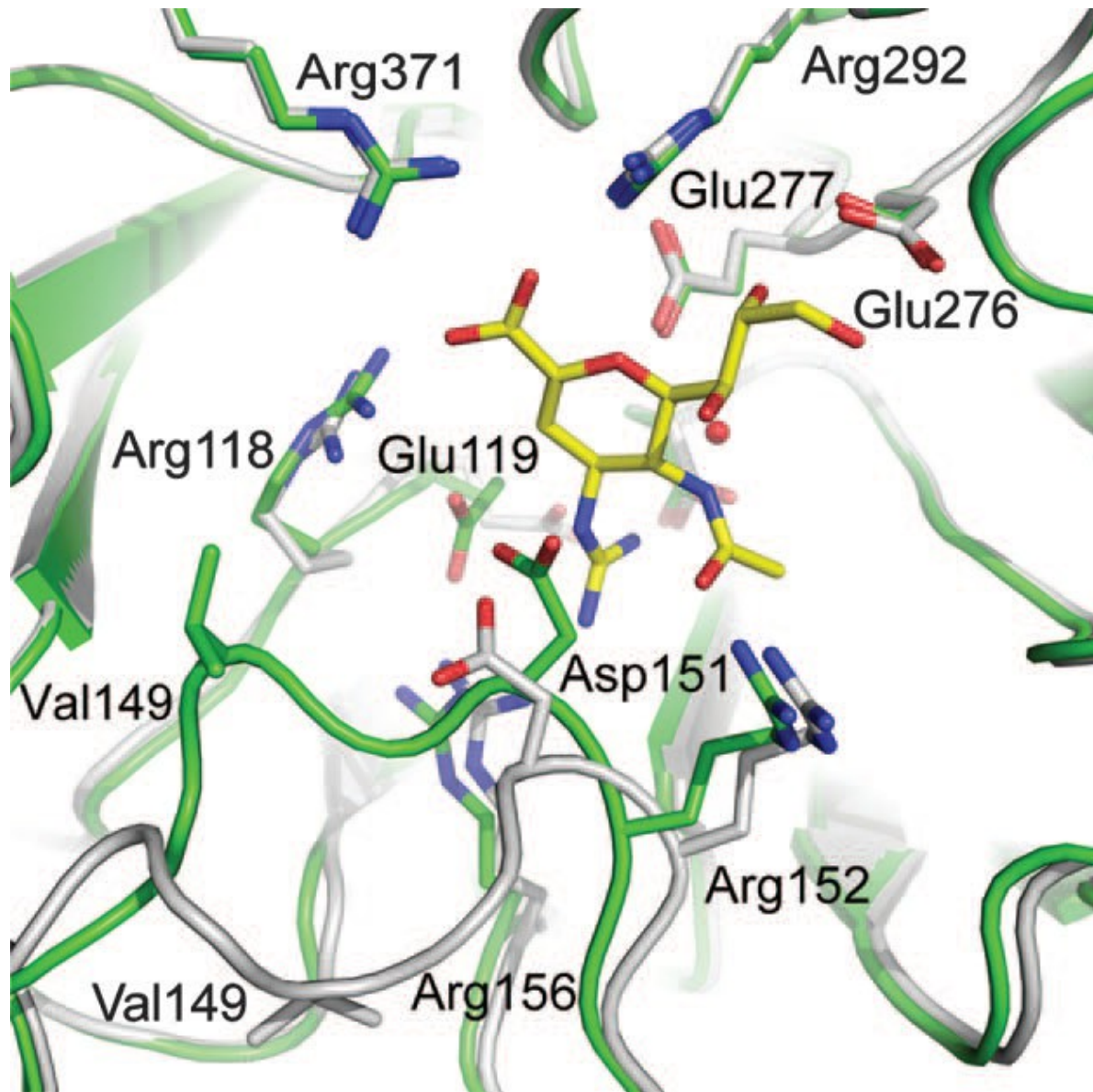

A model of binding of zanamivir to the active site of neuraminidase of reconstructed H1N1 virus from 1918 (similar to swine 2009)

3. Inhibitors of replication of RNA viruses

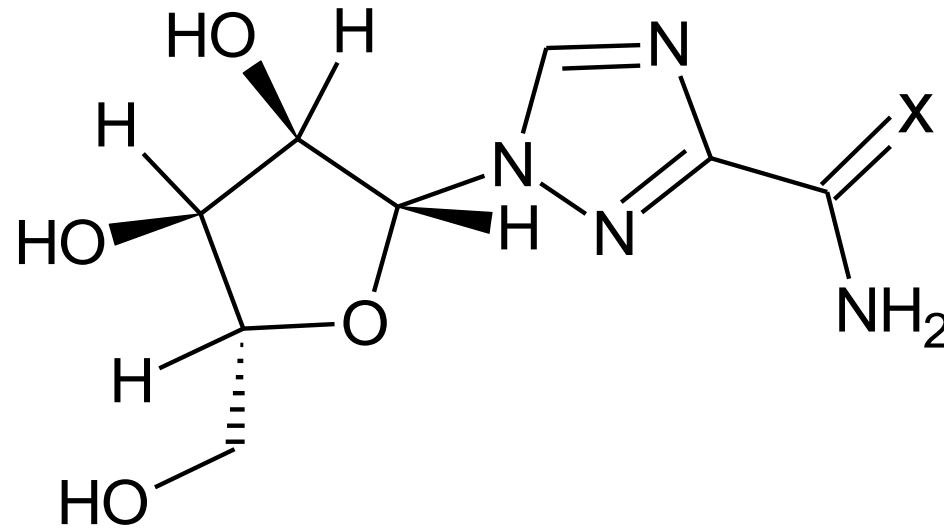

X = O

1-β-D-ribofuranosyl-1,2,4-triazole-3-carboxamide

ribavirin

- broad spectrum including SARS-coronavirus (Severe Acute Respiratory Syndrome)
- known since 1970th
- approved for treatment of HCV (hepatitis C; ± pegylated interferon) and RSV (respiration syncytial virus) in children
- mechanisms of action:
 1. inhibition of inosine-5'-monophosphate dehydrogenase (changes IMP to xanthosine-5'-monophosphate in *de novo* synthesis of GMP)
 2. direct interference with transcription and replication

Rebetol[®], Copegus[®]

X = NH

viramidin

syn. **taribavirin** [USAN]

- prodrug, expected lower toxicity (hemolysis), clinical trials of the 3rd phase for HCV completed

Mechanism of action of ribavirin

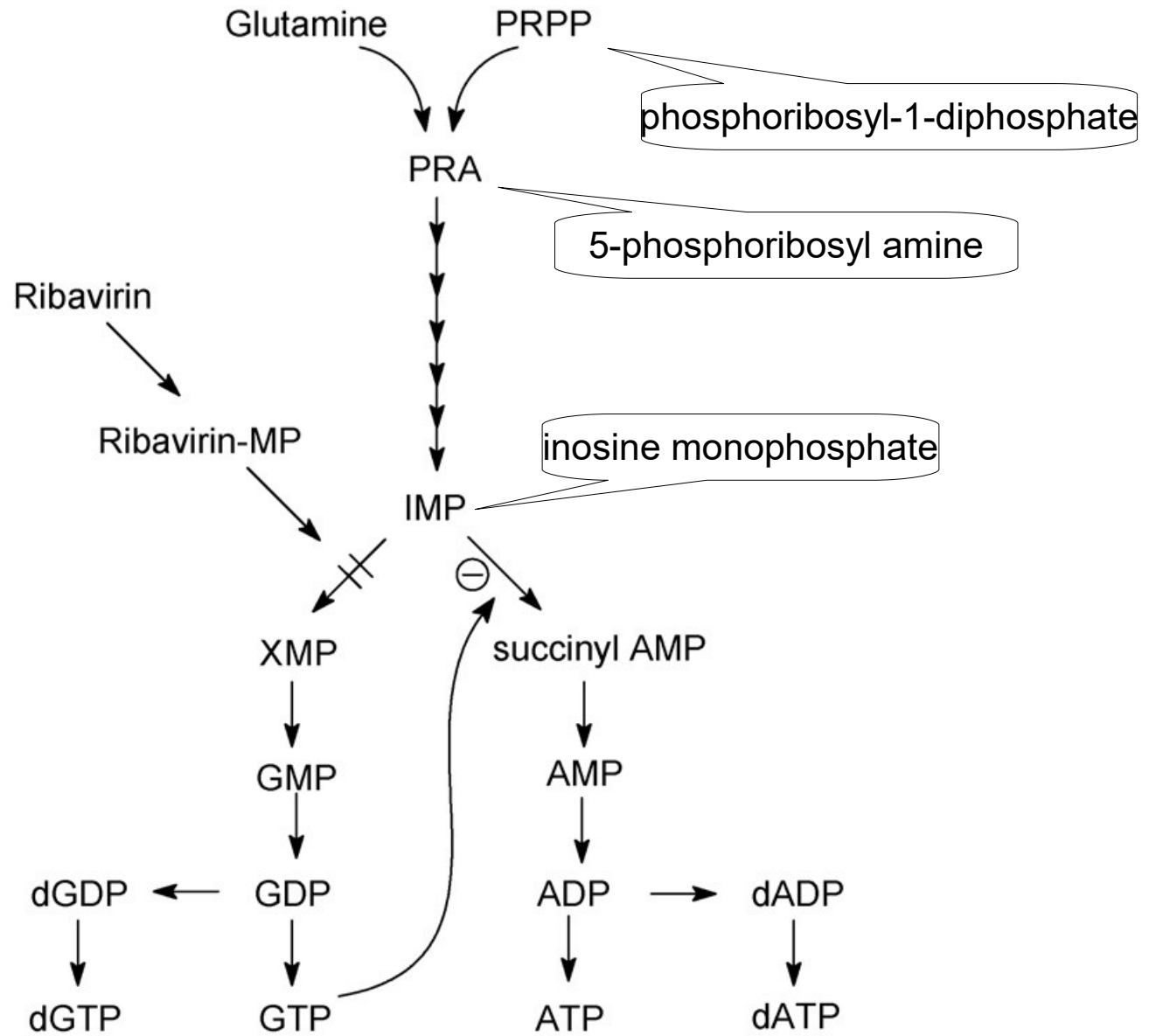

3. Inhibitors of replication of RNA viruses

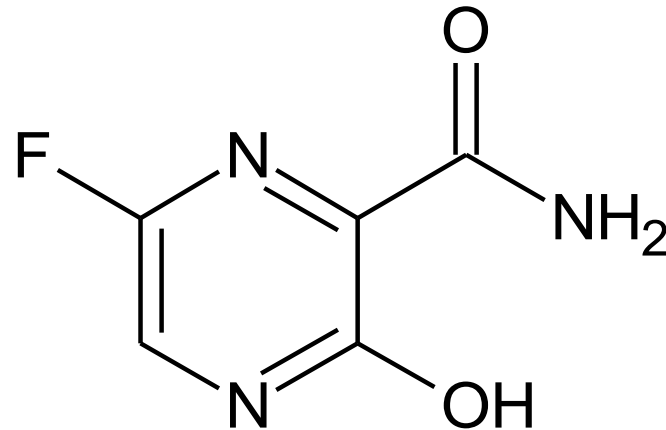

favipiravir

5-fluoro-3-hydroxypyrazine-2-carboxamide

T-705

- broad spectrum including influenza A, B, C
- clinical trials of the 1st and 2nd phases (pharmacokinetics, dose finding for influenza)
- mechanism of action: after entering the cell, phosphorylation to monophosphate by phosphoribosyl transferase and further to triphosphate by cell kinase; in this form the drug inhibits RNA-dependent RNA-polymerase
- *in vitro* very active against H5N1 (bird) and seasonal influenzas
- low toxicity, no cytotoxic effect

3. Inhibitors of replication of RNA viruses

Reverse transcriptase inhibitors

- reverse transcriptase = RNA-dependent DNA-polymerase discovered in 1970th by Temin, Mizutani and Baltimore in oncoviruses
- catalyses „reversal“ transcript of viral RNA into DNA in retroviruses

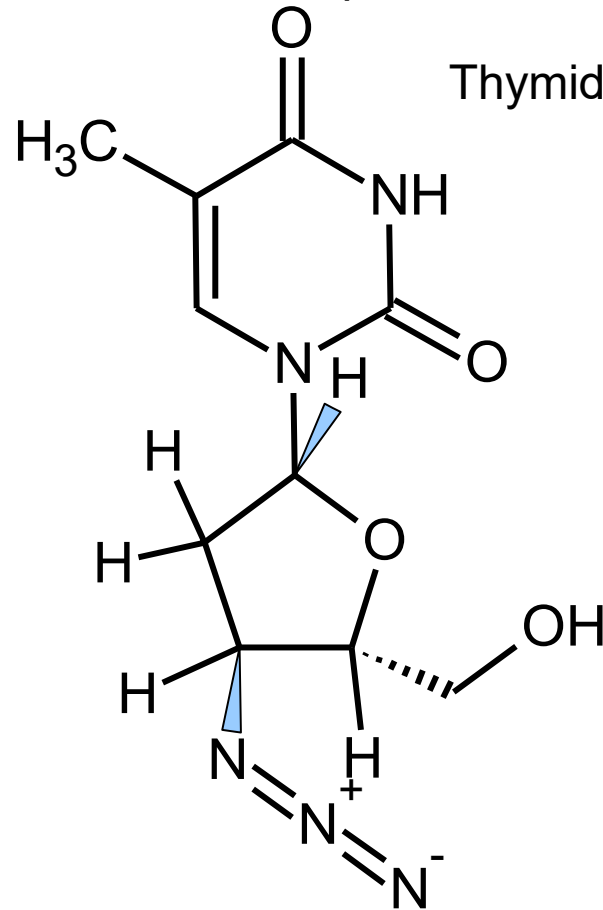

3'-azido-2', 3'-dideoxythymidine
zidovudine
azidothymidin, AZT
Retrovir[®]

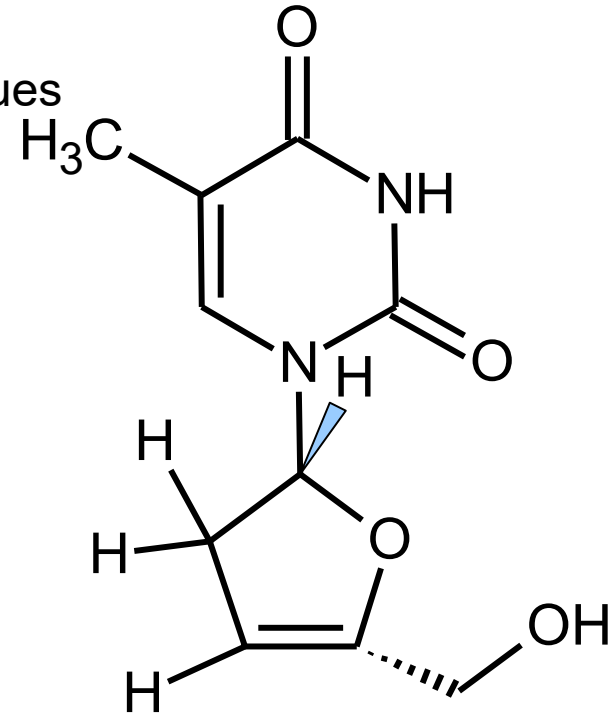

2', 3'-didehydro-2', 3'-dideoxythymidine
stavudine
Zerit[®]

- treatment of HIV infections

Reverse transcriptase inhibitors

Cytidine analogues

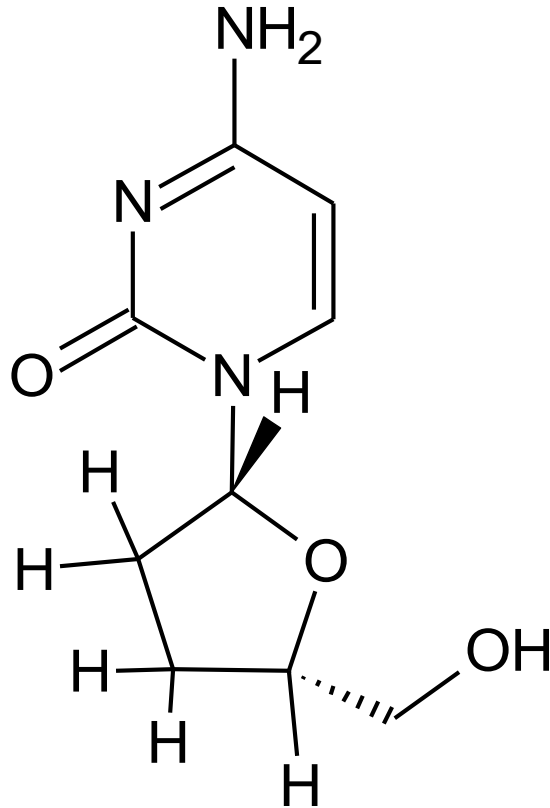

2',3'-dideoxycytidine

zalcitabine

ddC

Hivid[®]

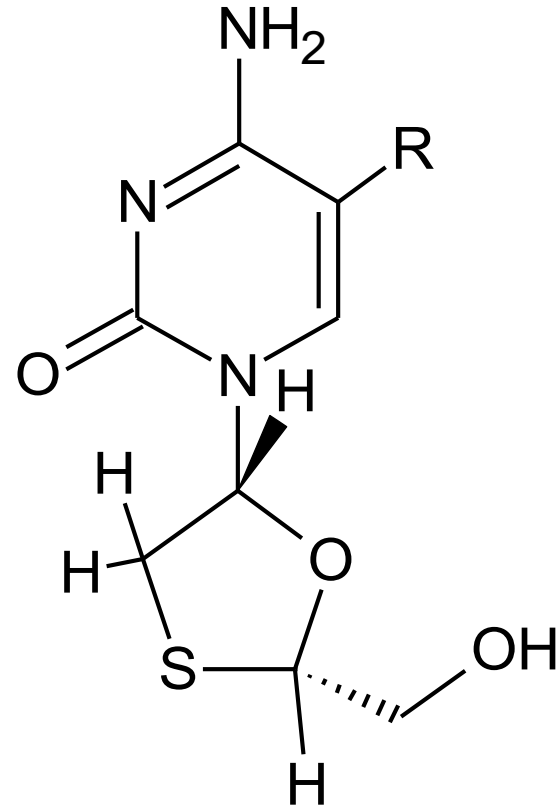

R = -H 2',3'-dideoxy-3'-thiacytidine

lamivudine

3TC

Epivir[®]

R = -F 2',3'-dideoxy-5-fluor-3'-thiacytidin

emtricitabine

Emtriva[®]

•treatment of HIV infections

Reverse transcriptase inhibitors
Purine derivatives

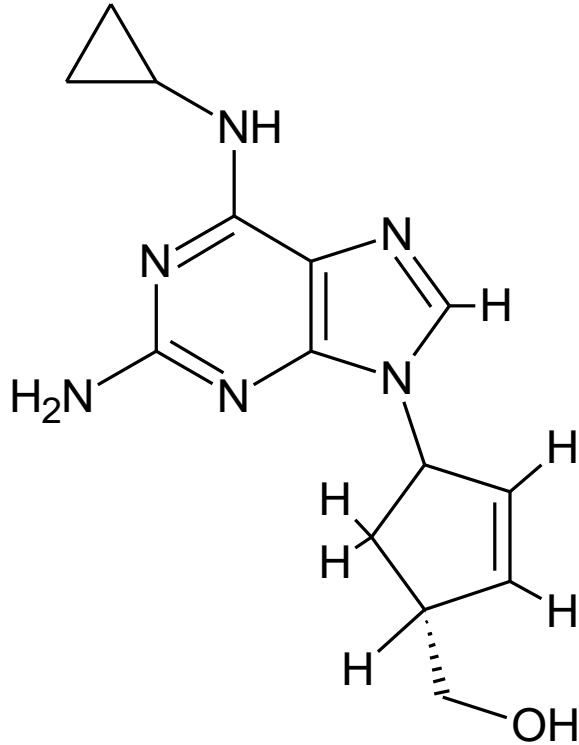

{(1*R*)-4-[2-amino-6-(cyclopropylamino)-9*H*-purin-9-yl]cyclopent-2-en-1-yl}methanol

abakavir
ABC
Ziagen[®]

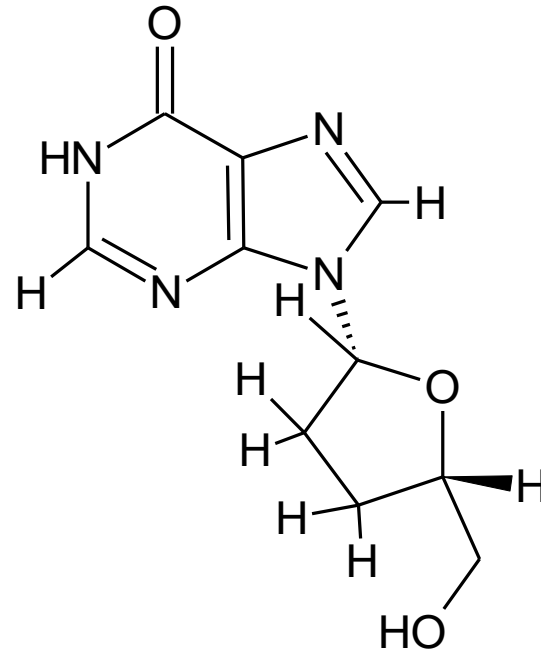

2',3'-dideoxyinosine

didanosine
ddl
Videx[®]

Nucleotide reverse transcriptase inhibitors

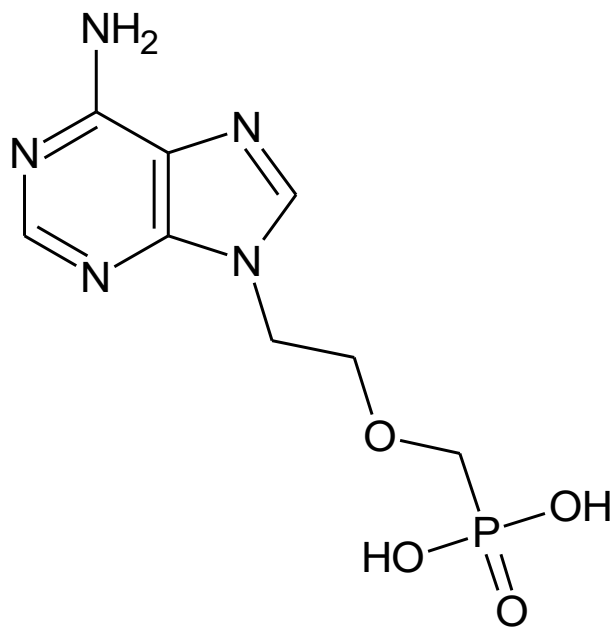

9-(fosfonylmethoxyethyl)adenine

adefovir

- originally developed against HIV, in doses which were needed it was nephrotoxic
- now treatment of HBV (hepatitis B)

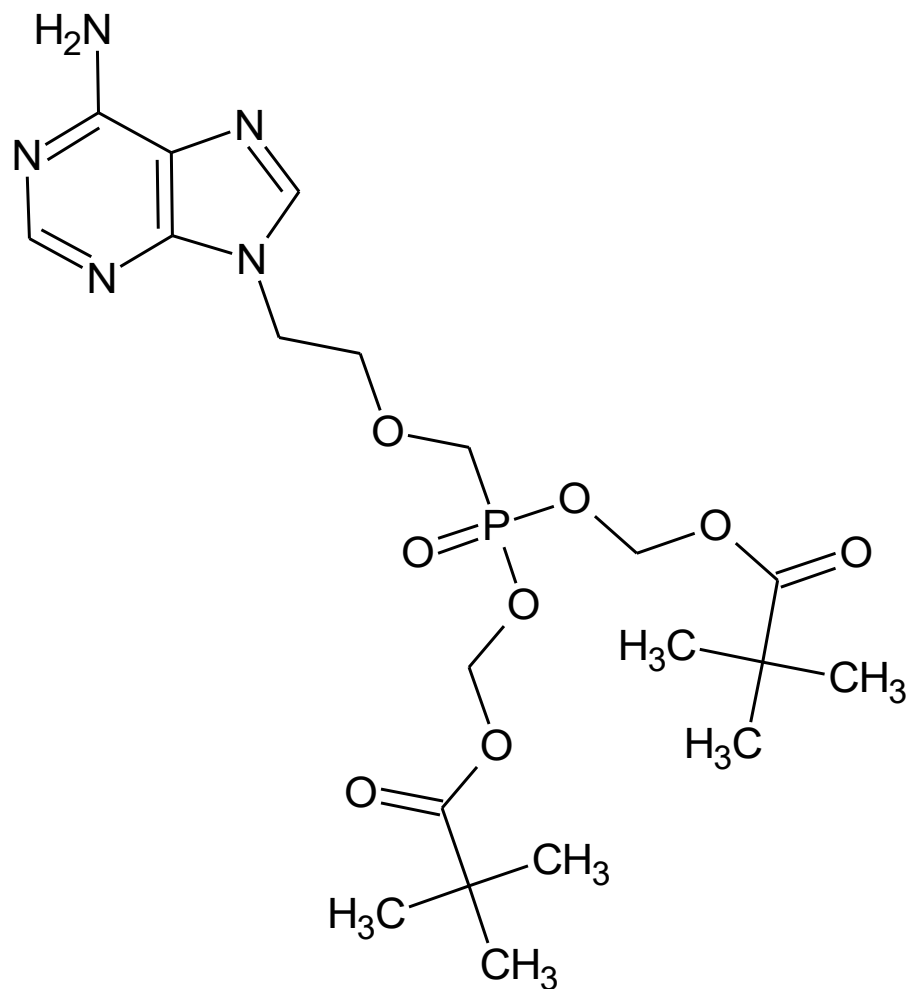

adefovir dipivoxil

- a prodrug with improved lipophilicity and bioavailability

- prof. Antonín Holý, Inst. of Org. Chem. and Biochem., Prague
- nominated for Nobel Prize

Nucleotide reverse transcriptase inhibitors

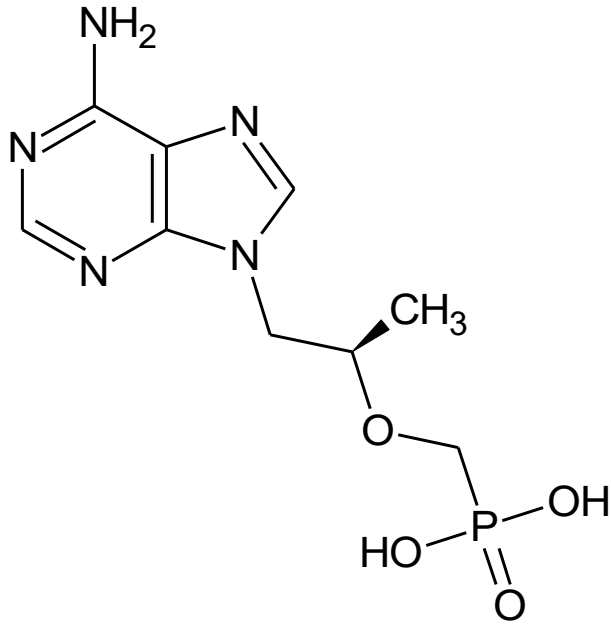

(R)-9-[(2-fosfonylethoxy)propyl]adenine

tenofovir

•against HIV

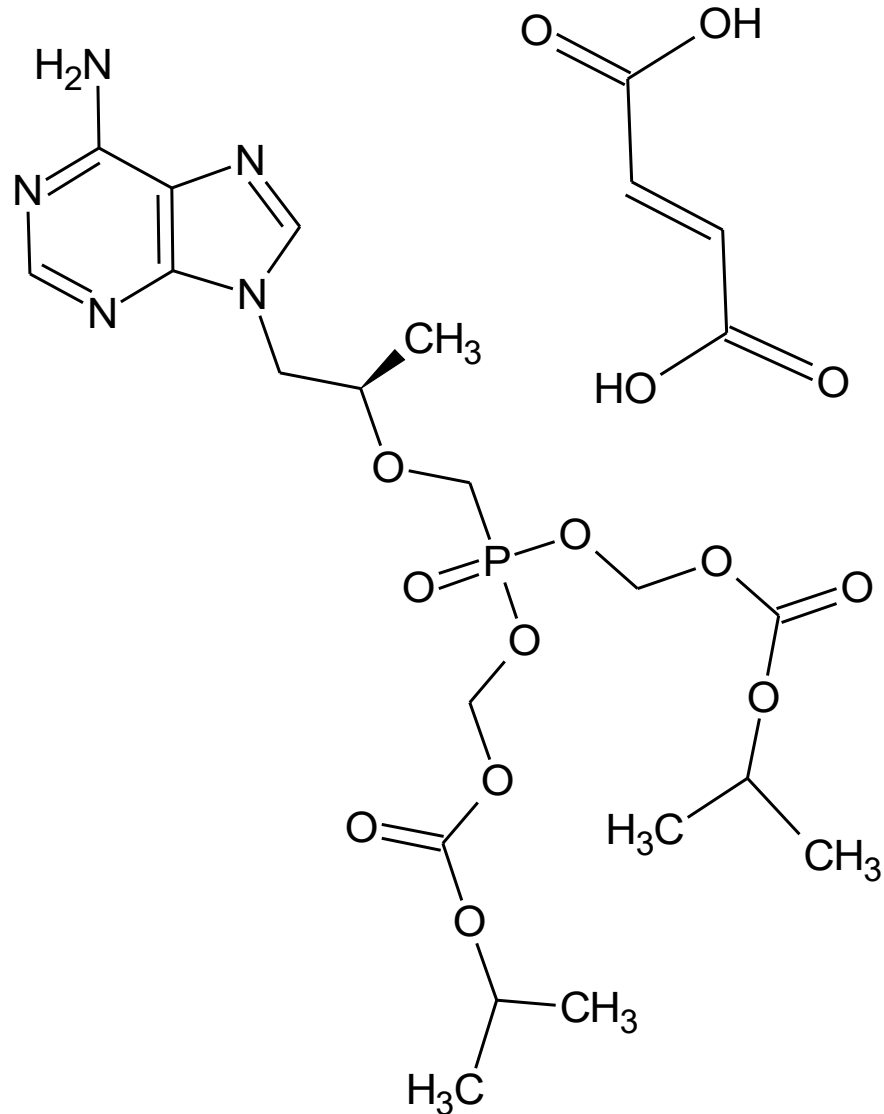

•**tenofovir disoproxil fumarate**

•clinical studies for HBV and HIV

Viread[®] tbl., Truvada[®] cps. (+ emtricitabin)

Inhibitors of DNA polymerase of herpetic viruses

- DNA polymerase of *Herpesviridae* family consists of 2 units: the catalytic subunit UL 54 + additive protein UL 44

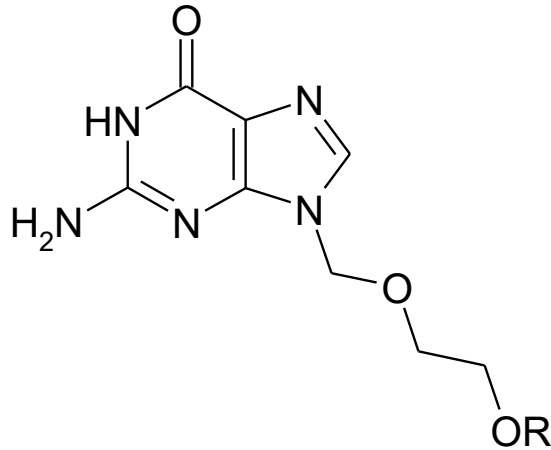

aciclovir
Aciclovirum PhEur

R = -H

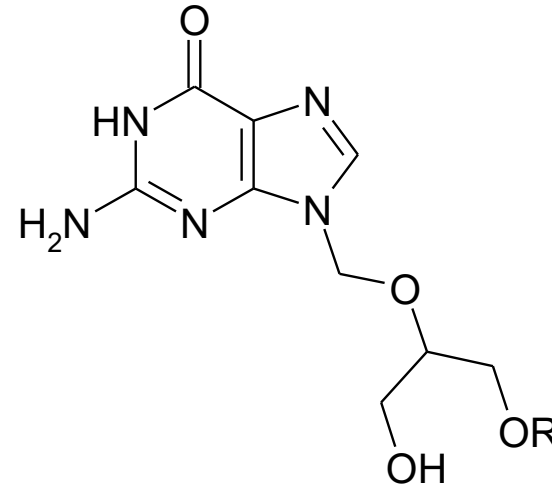

ganciclovir

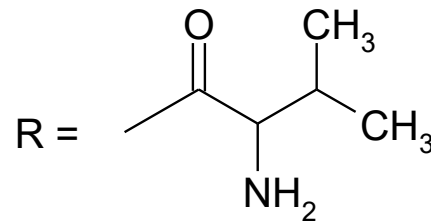

valaciclovir

valganciclovir

- nucleoside analogues, guanine derivatives
- herpetic infections including HCMV (human cytomegalovirus)
- prodrugs – valine esters have improved biological availability

Inhibitors of DNA polymerase of herpetic viruses

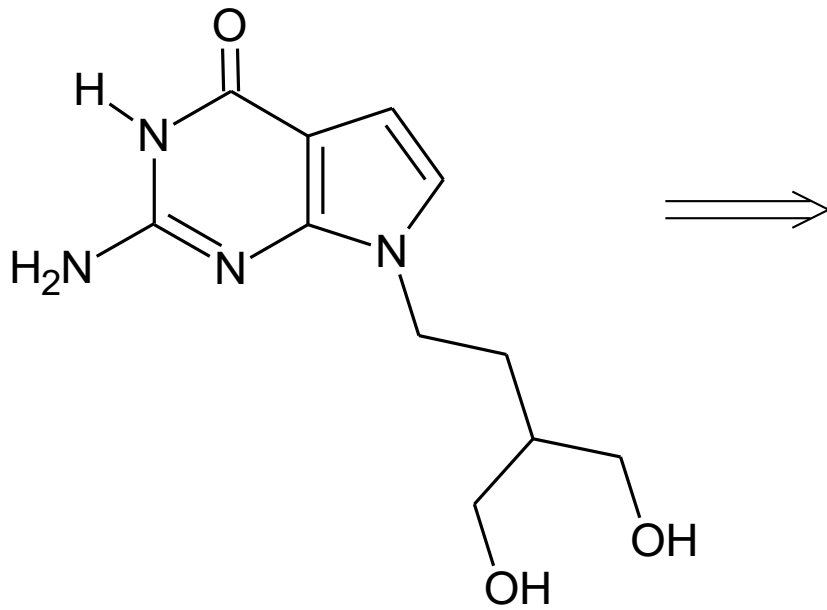

penciclovir

Vectavir® drm crm

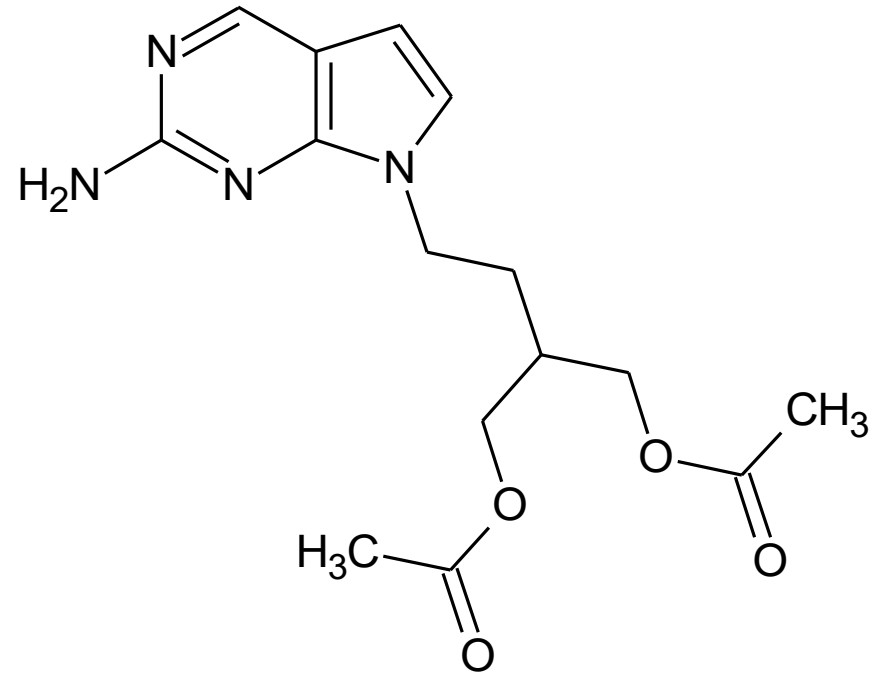

famciclovir

•competitive inhibitor

Famciclovir Arrow® por tbl flm

Inhibitors of DNA polymerase of herpetic viruses

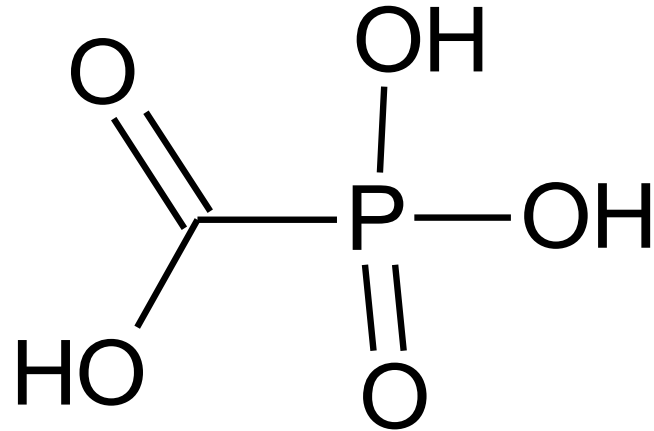

foscarnet

Foscarnetum natricum hexahydricum PhEur

- CMV retinitis, other herpesviruses, HIV
- mechanism of action: inhibits viral DNA polymerase by binding to the diphosphate binding site and by blocking of cleaving of diphosphate away from the triphosphate of terminal nucleoside which is added to the growing DNA chain
- blocks also reversal transcriptase

Viral proteases inhibitors

Inhibitors of HCV (hepatitis C virus) NS3 protease

- hepatitis C: 2 – 15 % of the world population are estimated to be infected, WHO: $1.7 \cdot 10^8$ people (2006)
- 10 – 20 % overcomes the virus, the rest becomes permanent virus hosts, in 10 – 20 %, cirrhosis or liver cancer is developed
- transfer is parenteral, sexual or vertical (mother→child)

NS3 protease

- situated on the N-terminal domain of NS3 protein
- probably an important site of intervention
- responsible for the intramolecular cleavage on NS3/4A site and following processes
- it simultaneously corrupts synthesis of interferon regulation factor 3 (IRF-3) of the host which leads to decrease of immunity response

Inhibitors of HCV (hepatitis C virus) NS3 protease

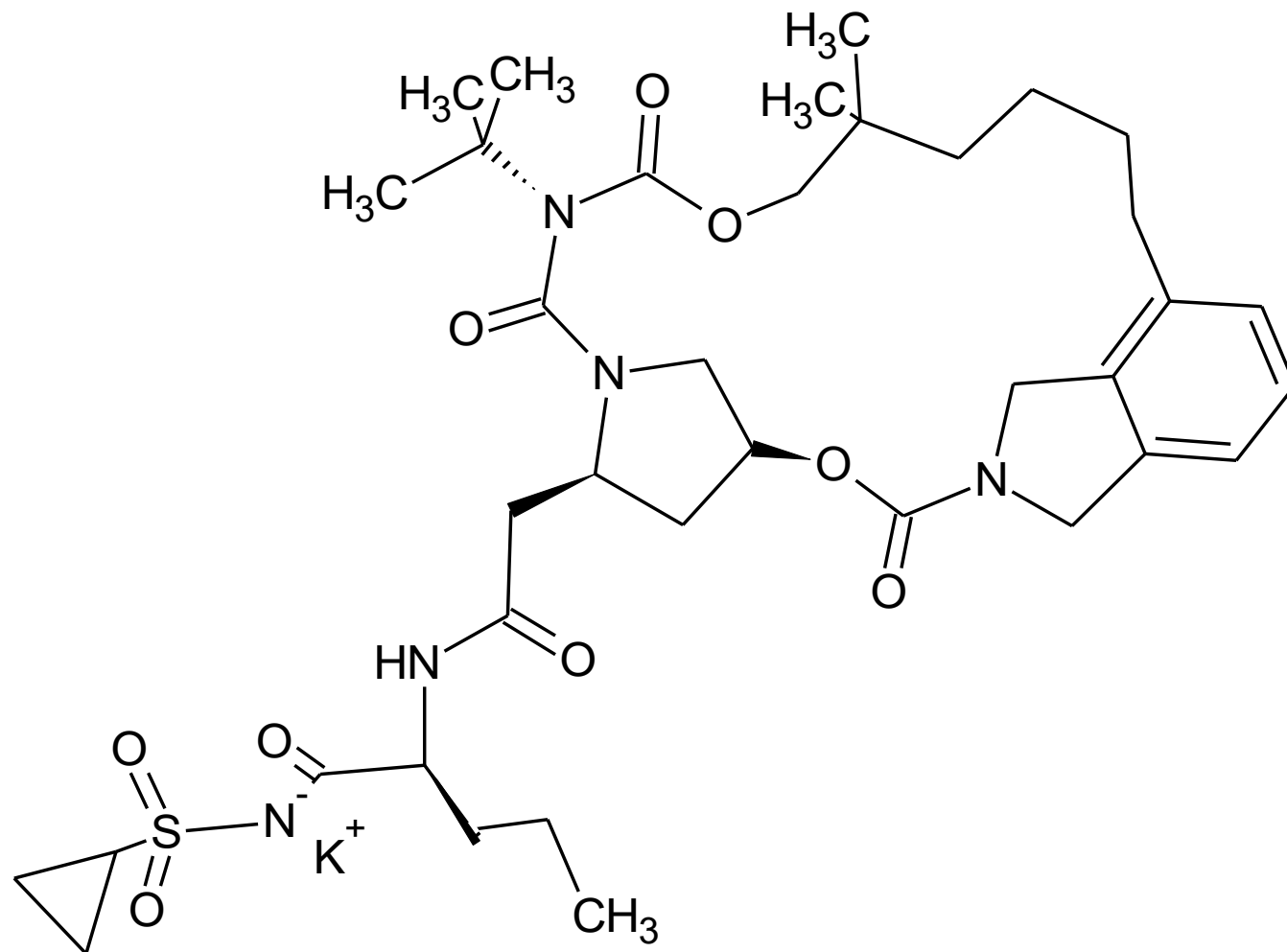

MK-7009

Immunotherapeutics: antibodies

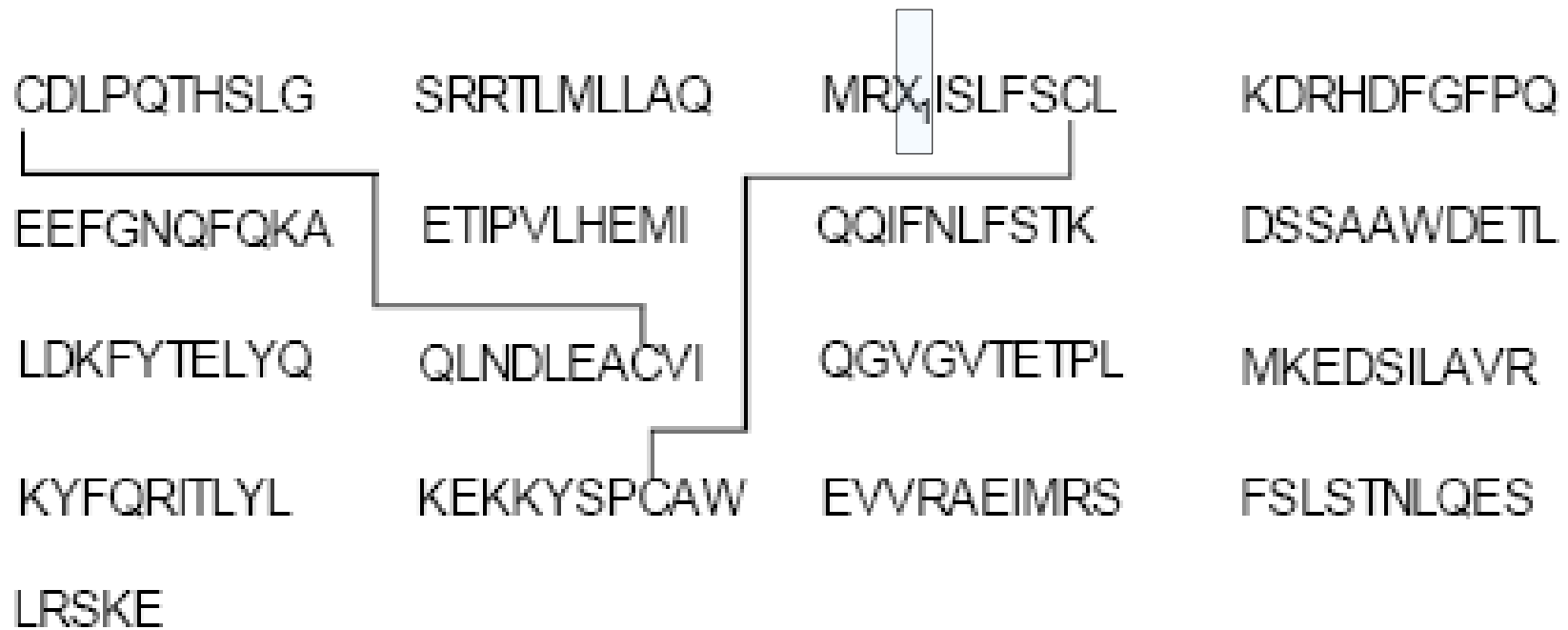

interferon α_2

Interferoni alfa-2 solutio concentrata PhEur

X1 = Lys α_{2a}

X1 = Arg α_{2b}

- antiviral activity during synthesis of viral RNA and proteins
- antiprolifetive activity
- production by a recombinant technology on bacteria
- also pegylated: peginterferon alfa-2a (Pegasys ®) - at N-terminal, N², N⁶-dikarboxy-Lys esterified with PEG-monomethylether is attached; possibility of oral administration