

# 6. Regulation of gene expression in eukaryotes nuclear receptors (cell signaling)

Regulation is mediated by

1) interactions of regulatory proteins

with regulatory sequences on DNA

2) ncRNA

Model of a transcription unit

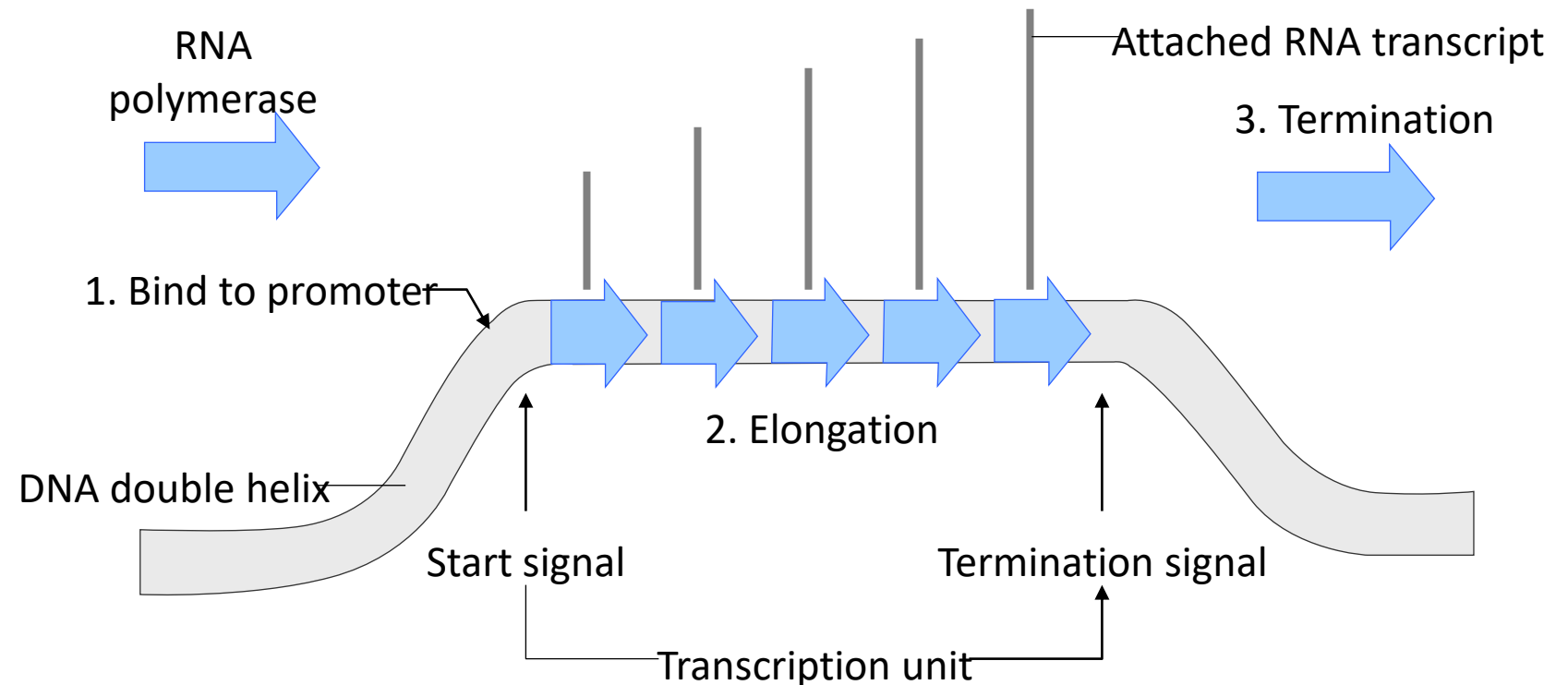

# Levels of gene expression control

## 0. Chromatin

1. Where and how often is a given gene transcribed (transcriptional control)

2. How the primary transcript is spliced (post-transcriptional-spliced control)

3. Selection of RNAs to be transported from the nucleus to the cytoplasm (control of RNA transport)

4. Selection of mRNAs to be translated on ribosomes (translational control)

5. Selective destabilization of certain mRNAs in the cytoplasm (mRNA degradation)

6. Selective activation, inactivation and compartmentalization of specific proteins after they have been synthesized (protein activity control - post-translational control, transport)

Six steps of information transfer in eukaryotes that constitute potential regulatory points of gene expression

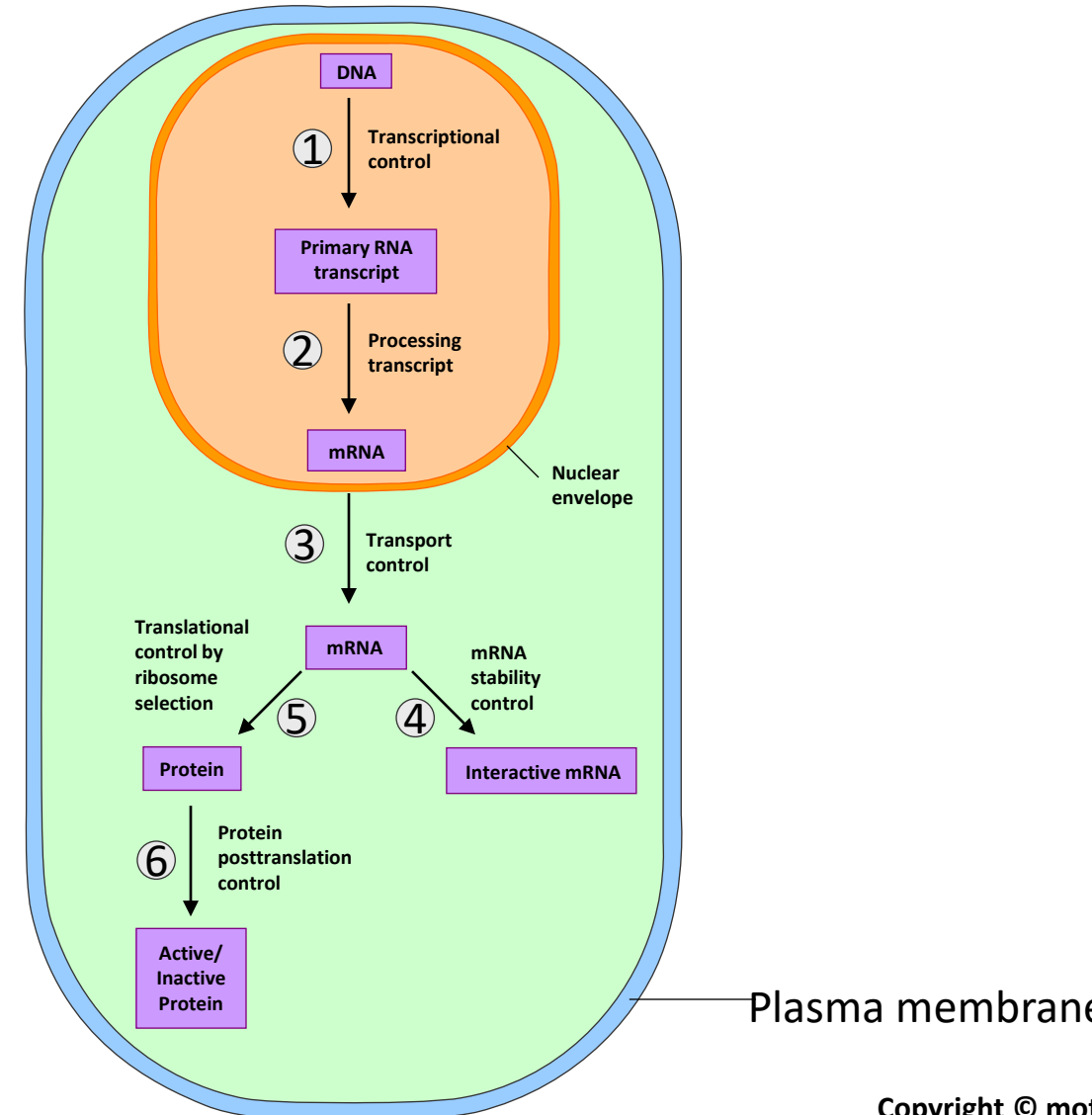

# DNA segments that can modulate transcription by binding gene regulatory proteins

Regulation is mediated by

1) interactions of regulatory proteins

with regulatory sequences on DNA  
2) ncRNA

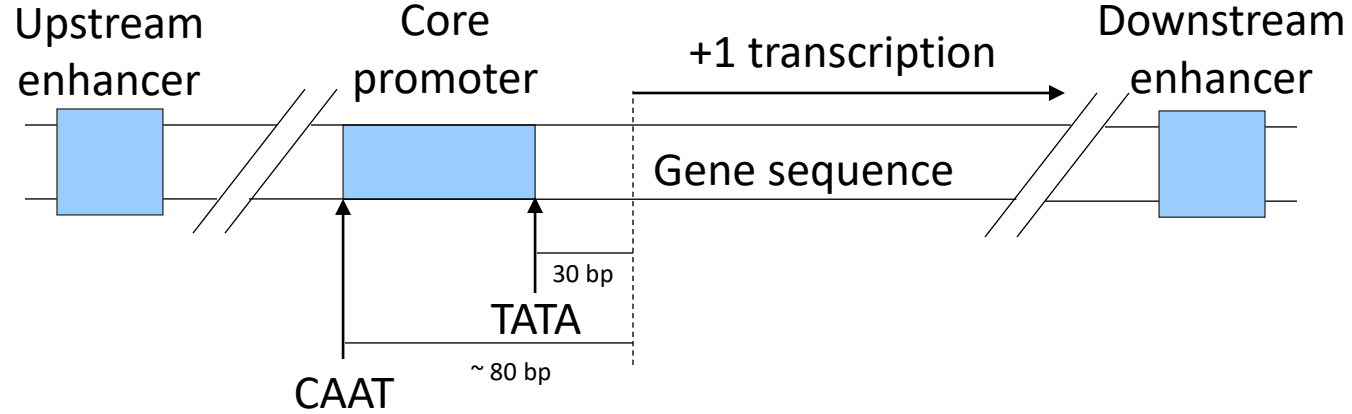

A

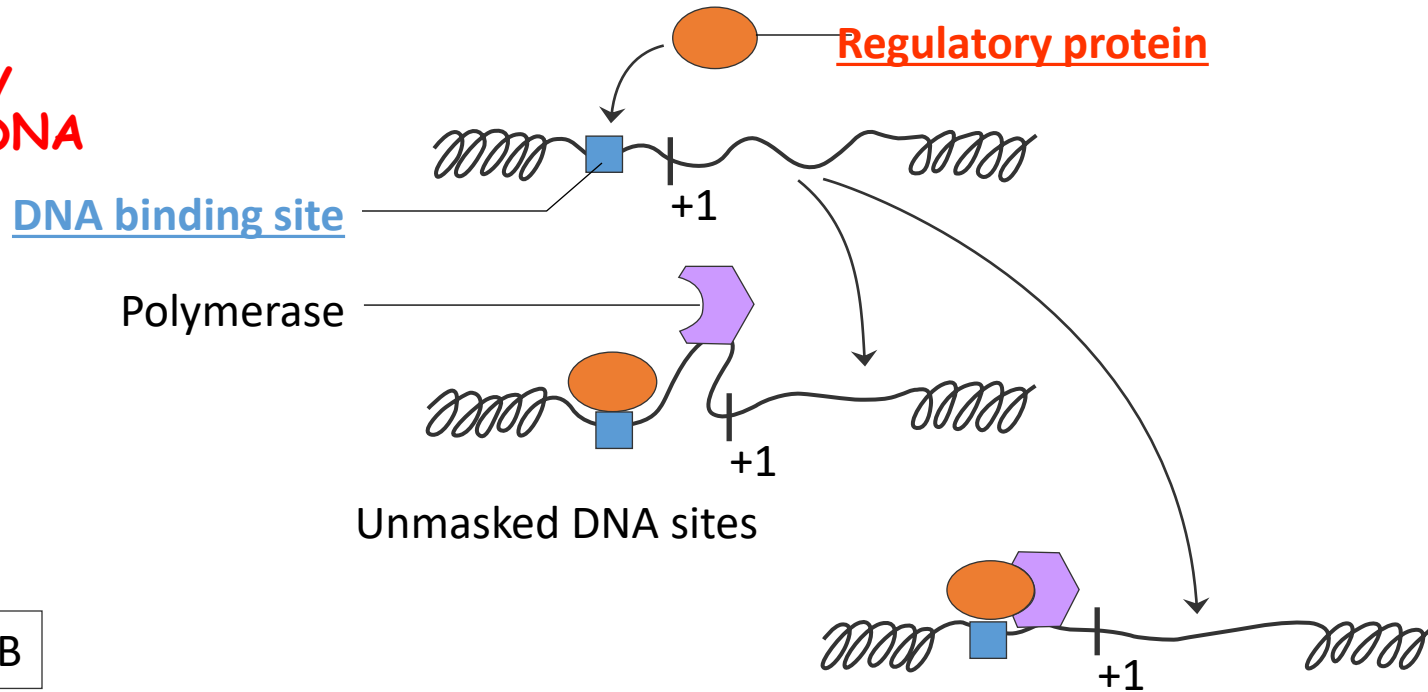

B

# Protein-DNA interactions

- proteins interact with sugar phosphate skeleton (phosphate) or through grooves with bases

- **Sequences not sequence specific** (skeleton - histones; structurally specific - HMG proteins) or sequentially specific (skeleton + grooves - combination: BglII (AGATCT) and BamHI (GGATCC) contact the same bases and They "read" the curvature of the surroundings

The shape and charge specificity of DNA determines the types of DNA binding domain DNA...)

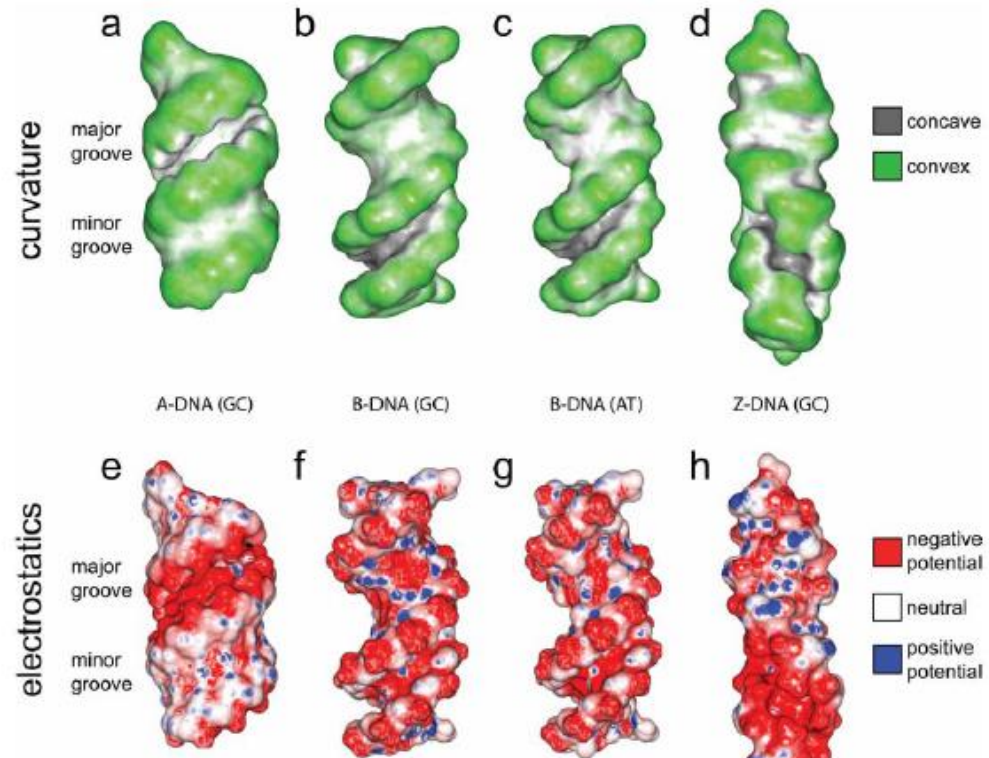
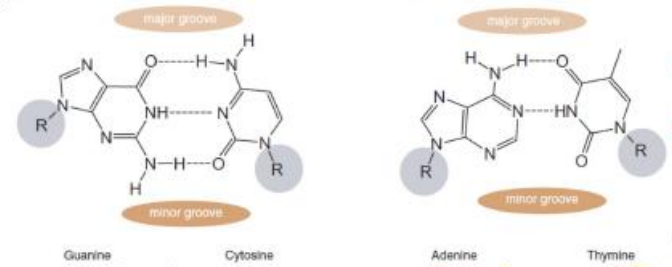

„shape readout“  
zakřivení kostry - souvisí se sekvencí a prostředím

Rohs et al, Annu Rev Bioch, 2010

# Types of interactions

- **salt bridges** - between phosphates and + charged AK side chains (Lys, Arg, His)
- **hydrogen bonds** - between phosphates, sugars, bases in NK and peptide bond or hydrophilic AK side chains
- **stacking** - between aromatic amino acids (Trp, Tyr, Phe, His) and bases
- **hydrophobic interactions** - between bases in NK and non-polar side chains of AK

TEST

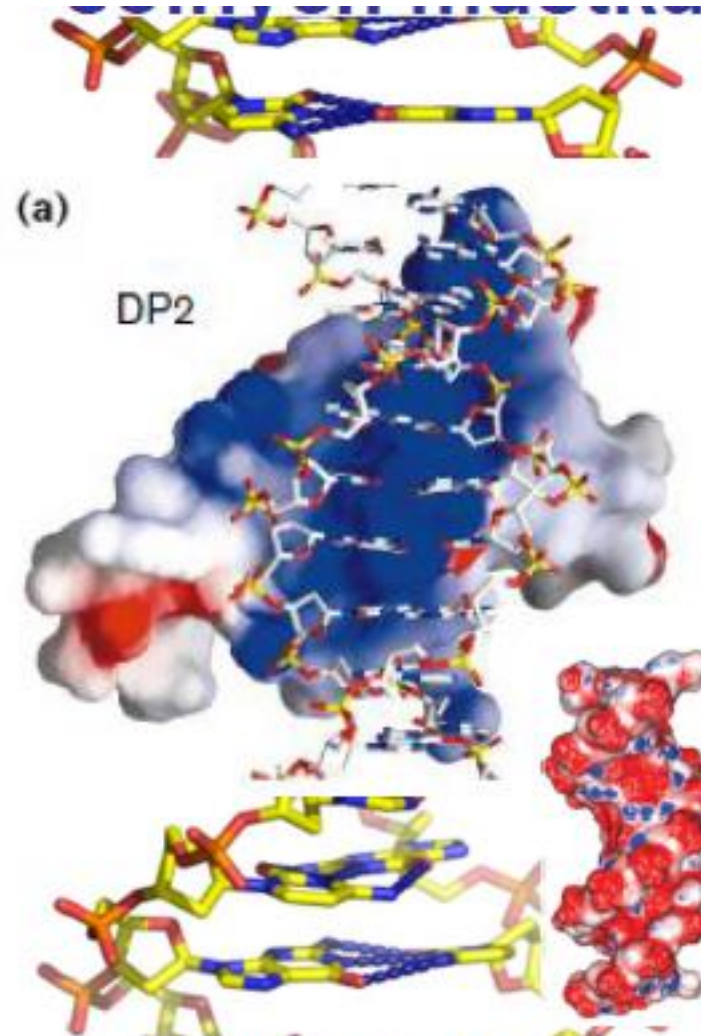

Gajiwala & Burley, COiSB, 2000  
8\_MB-2022-RNA-regulation

Phosphates can interact with salt bridges

- Arg and Lys - saline
- salt bridges
- (positive charges Arg and Lys
- creates a bond with the negative
- phosphate group charge)
- Electrostatic charge / surface indicates protein binding capabilities

# Hydrogen bonds

- sequence-specific protein contacts the base ("direct")
- readout) - through a large or small groove - a large groove is
- more accessible - **hydrogen bonds (donor vs electron acceptor)**

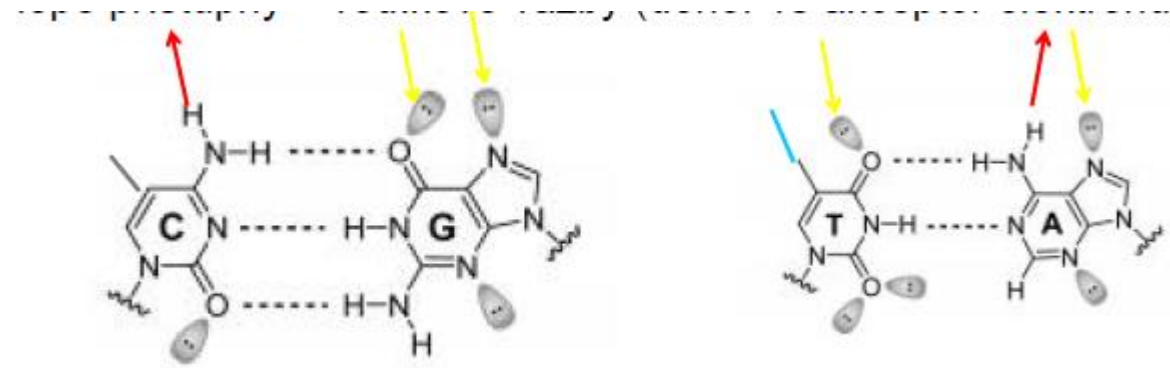
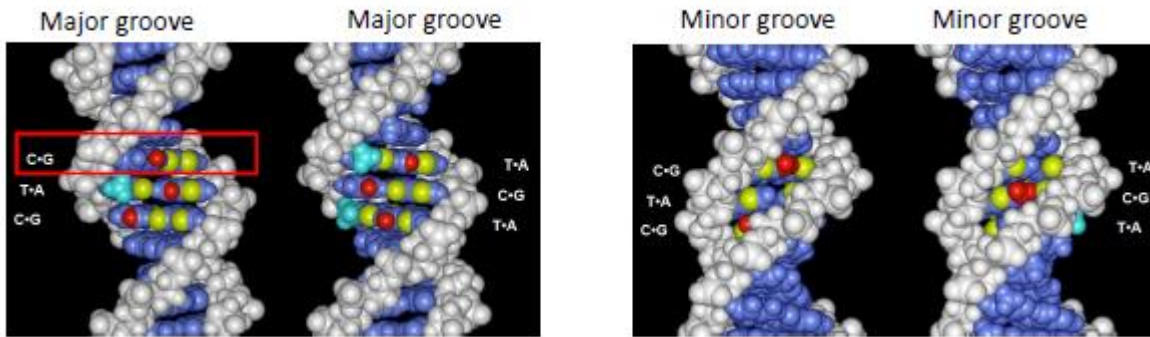

related to recognition and helix - pre interaction and helix with DNA ex. many direct interactions between AK side chains and NA bases.

Uncommon interactions:

O6 or N7 guan atoms...

Side chains Arg, Lys, Gln, Asn, Ser

Less often:

N6 or N7 adenine atoms

Exceptionally:

Pyrimidines

often occurs: more H-bonds to 1 base water-mediated H-bond between protein and NA

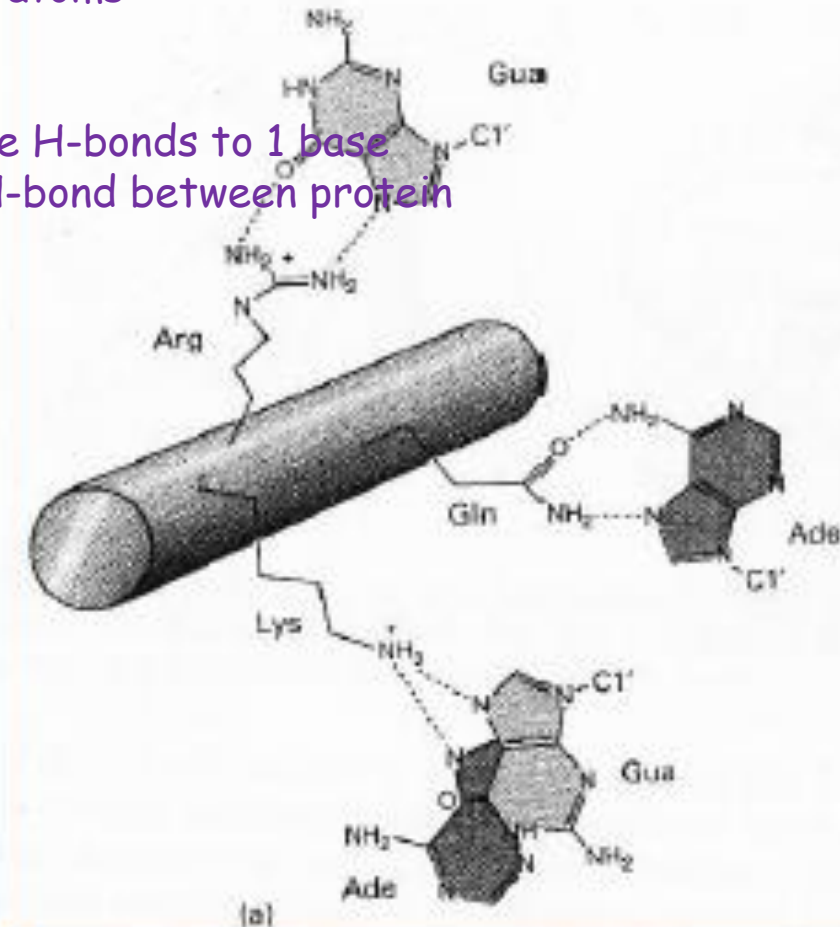

# Binding of proteins to DNA via hydrogen bonds

- The large groove has the size corresponding to the dimensions and the helix
- and has exposed H-linking groups
- Ade residues C-6 (NH<sub>2</sub>) and N-7 may form specific ones
- hydrogen bonds with Gln and Asn
- Gua can form specific hydrogen bonds with Arg
- Strong binding, sequence specific - affinity nM - uM
- Weak binding, structural specific - affinity uM - mM

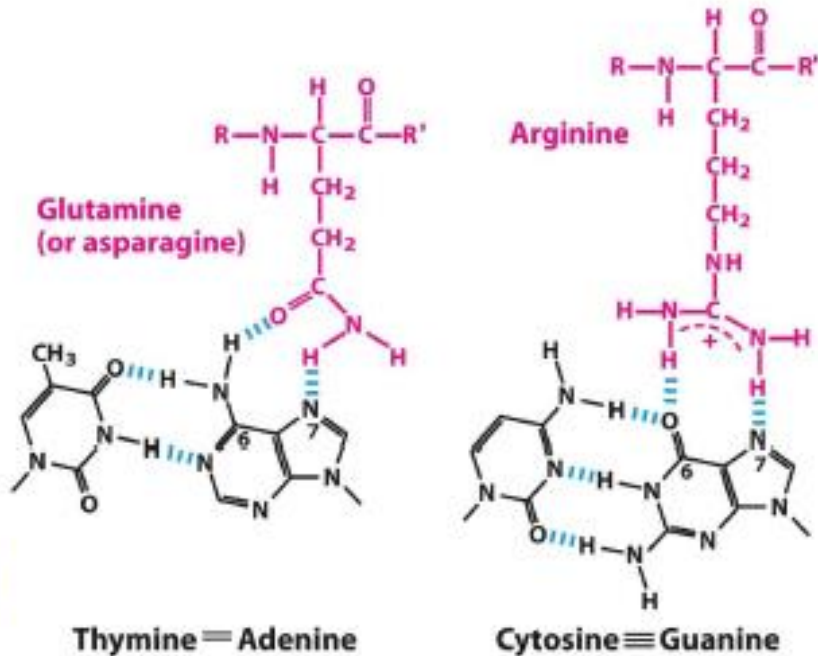
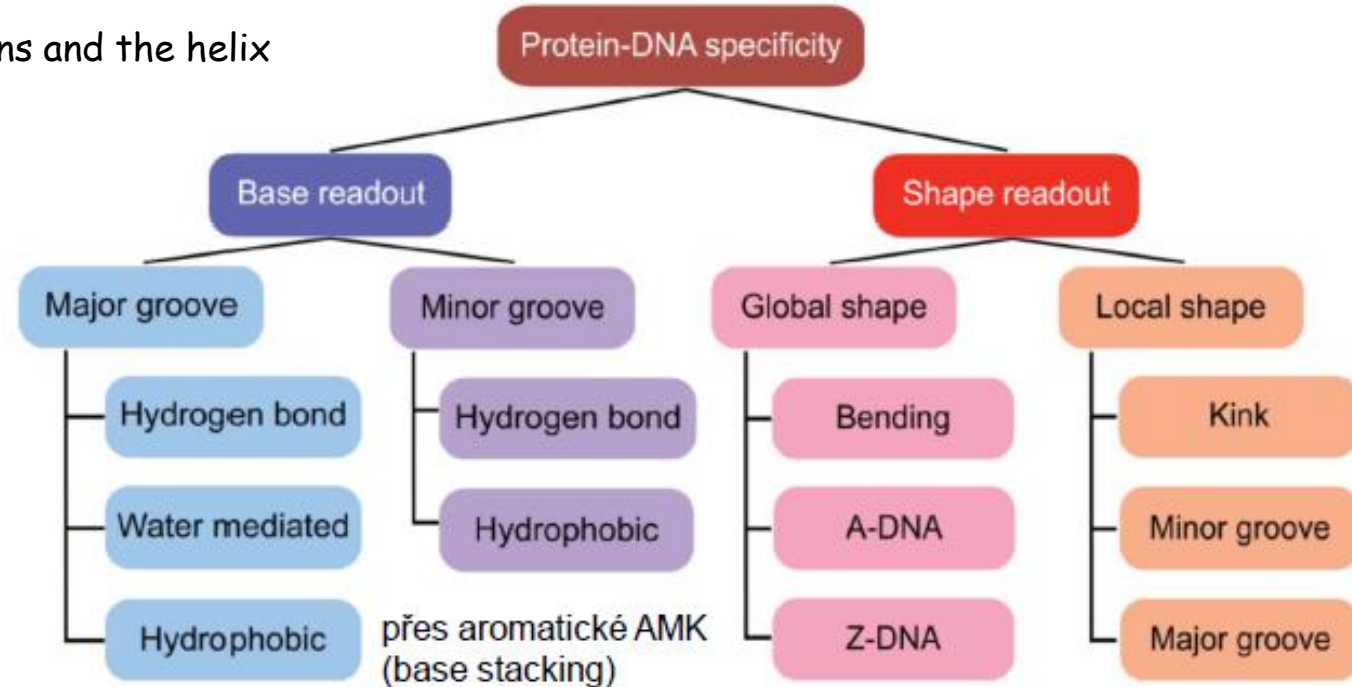

- více jak 70 SCOP superrodin (strukturních motivů)
- dle sekundárních struktur –  $\alpha$ -šroubovice (17),  $\beta$ -listy (7), smíšené  $\alpha/\beta$  motivy (48)

Rohs et al, Annu Rev Bioch, 2010

# Protein motifs interacting with DNA

## Helix-Turn-Helix (HTH) domains

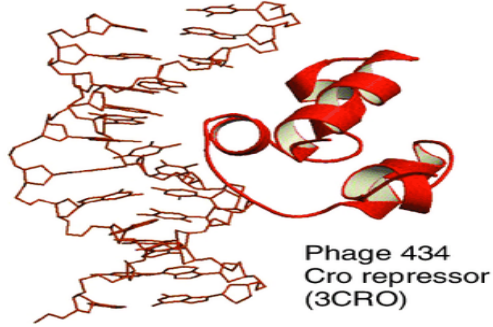

## Zinc fingers

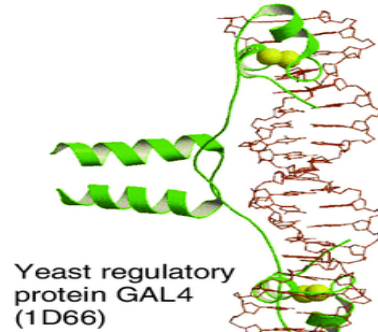
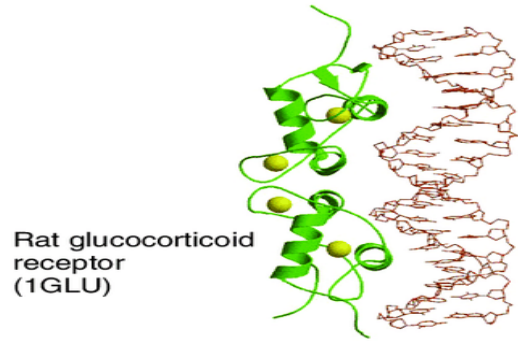

## Leucine zippers

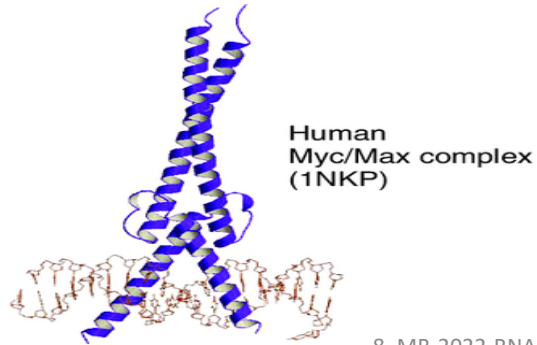
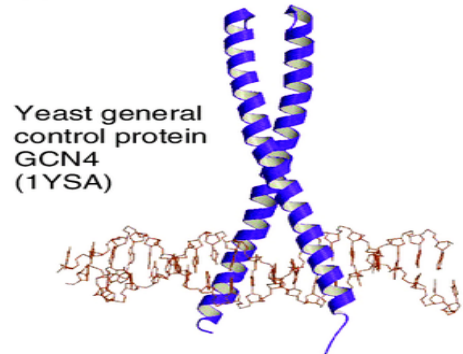

- **Zipper typ**
  - Leucinový zip
  - Helix-loop-helix
- **Helix-otáčka-helix**
  - HTH
  - Winged helix
  - TALE
- **Zinkový prst**
  - ββα zinc-finger
  - Hormon-receptor
  - Loop-sheet-helix
  - Gal4
- **Histon, HMG-box**
- **β-sheet motivy**

α-šroubovice

β-listy

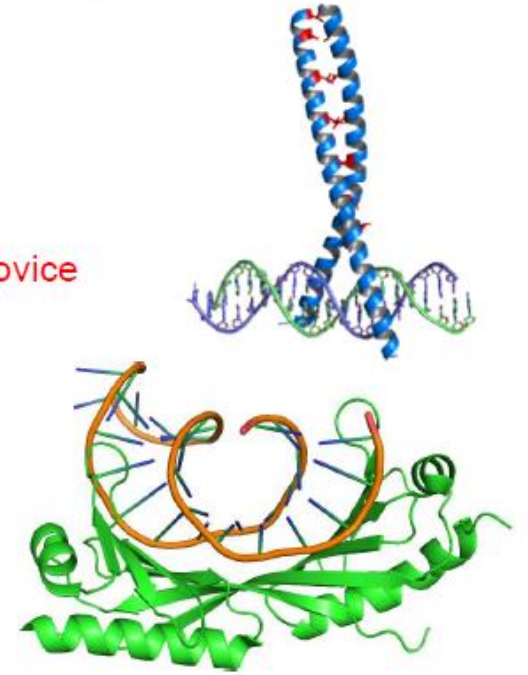

Luscombe et al, Genome Biology, 2000

Rooman, Marianne and Wintjens,  
René (March 2015)  
*Protein-DNA Interactions. In: eLS.*  
John Wiley & Sons, Ltd:  
Chichester.  
DOI:  
10.1002/9780470015902.a0001348.  
pub3



# Motivy- Transkripční faktory - GCN4 a AP1 a c-Myc

- **Zipper typ** (dle způsobu dimerizace)
  - **Leucinový zip** (tzv. bZIP = basic) (transcr. fact.  $\gamma$ GCN4, c-Jun/c-Fos=AP-1)
    - 2  $\alpha$ -helixy (2 x 60 AMK)
    - coiled-coil (>30AMK, Leu, C-term)
    - bazická část (N-terminus, navazuje na CC)
    - bazická šroubovice vázána do VŽ

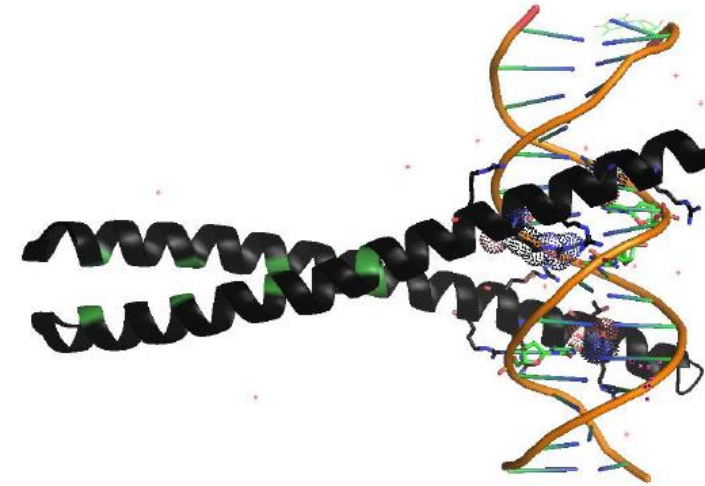
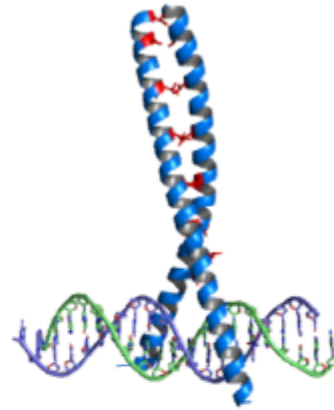

Interakce bazických AMK: Arg(232+240)=PO<sub>4</sub>, Arg(243)=Gua  
 Konsensus sekvence: TGACTCA  
 GCN4 – regulace genů pro syntézu AMK

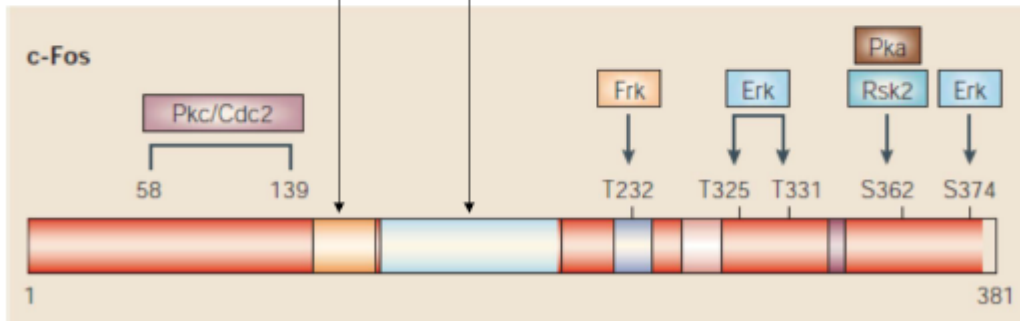

## – Helix-loop-helix (c-Myc/Max, MyoD)

- CC a bazické části jsou odděleny smyčkou
- bazická šroubovice vázána do VŽ
- smyčka poskytuje větší flexibilitu pro vazbu

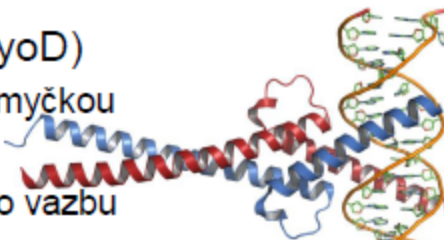

šroubovice-smyčka-šroubovice

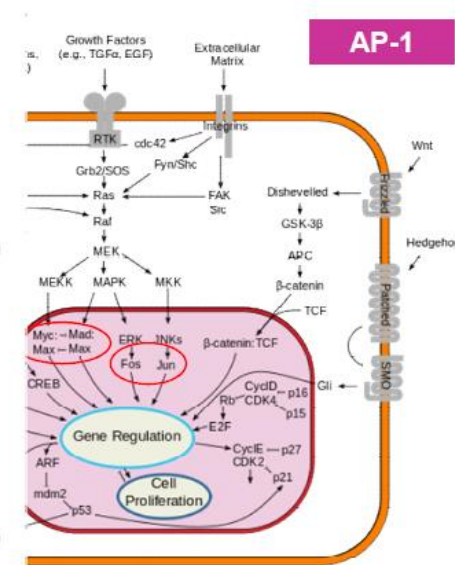
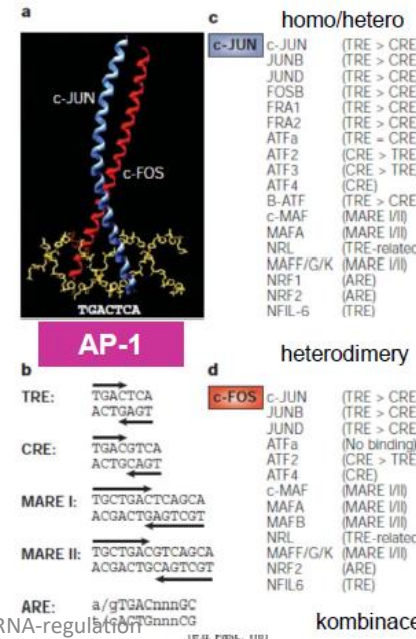

Efferl & Wagner, NRC, 2003  
 Wikipedie

# Helix-otáčka-helix

- HTH
- Winged helix
- TALE

## Helix-turn-helix motiv (HTH)

- Obsahuje ~ 20 AMK ve dvou šroubovicích vzájemně kolmých
  - $\alpha$ -helix pro vazbu na DNA („recognition“) -  $\beta$ -obrátk - druhá šroubovice
  - Sekvenčně-specifická vazba prostřednictvím „recognition“ šroubovice a velkého žlábků
  - nejčastější motiv u prokaryot - homodimery vážou palindrom. sekvence
  - HTH motiv se obvykle vyskytuje ve svazku 3-6 šroubovic (stabilizovaných hydrofobním jádrem)
  - motiv může být buď součástí hlavního proteinu (Cro) nebo z něj může pouze vybíhat (LacI)

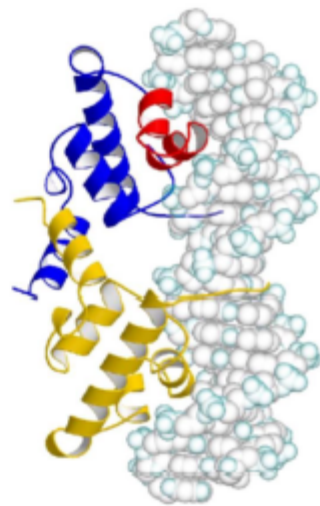

1. Cro and Repressor (1lmb)

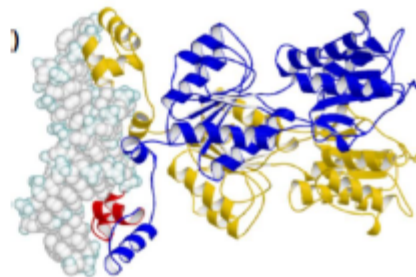

Luscombe et al, Genome Biology, 2000  
3. LacI repressor (1wet)

- „winged“ HTH obsahuje „recognition“ šroubovici (H3) a  $\beta$ -listy, které poskytují další kontakty s DNA

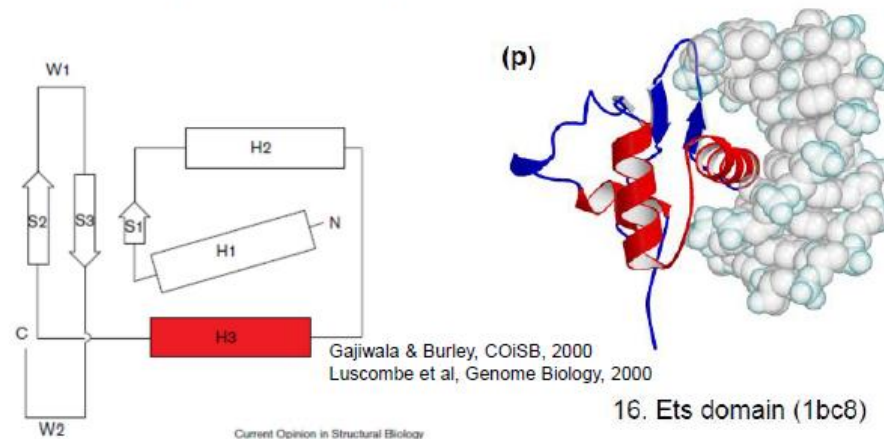

Gajiwala & Burley, COISB, 2000  
Luscombe et al, Genome Biology, 2000

16. Ets domain (1bc8)

Méně často křídlo ve VŽ a cukr-fosfátová kostra se šroubovicí (hRFX1)

### Transcription activator-like effectors (TALE)

Patogenní bakterie injikují do rostlinných buněk ovlivňují transkripci rostlinných promotorů



PthXo1  
23 repetice obtáčí DNA ve VŽ

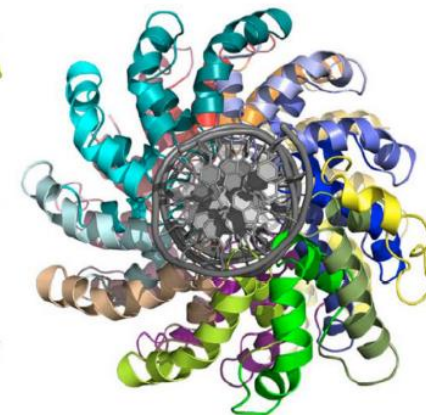

TALEN technologie  
Mak et al, Science, 2012

# General transcription factors-motive HTH

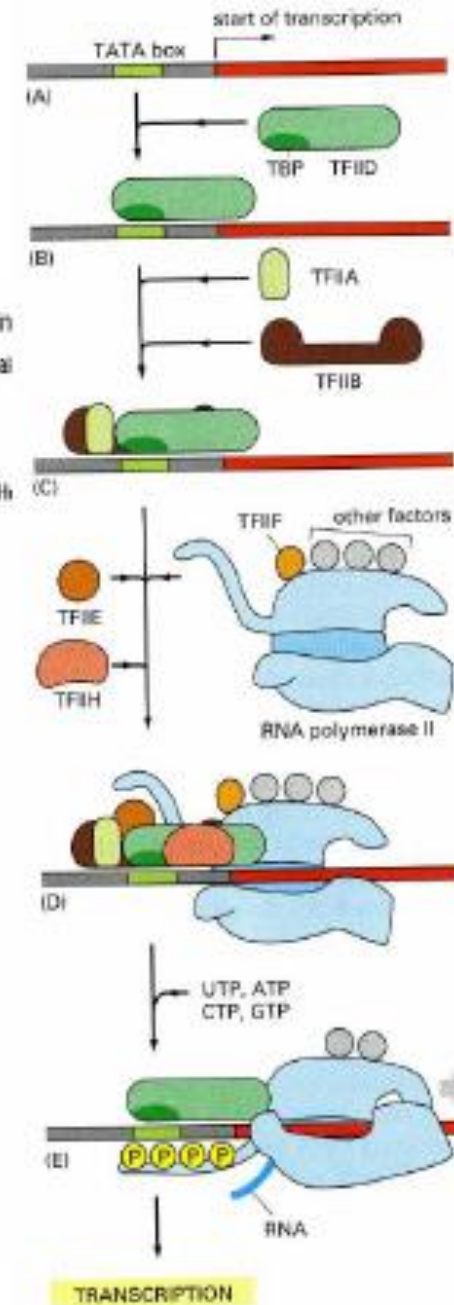
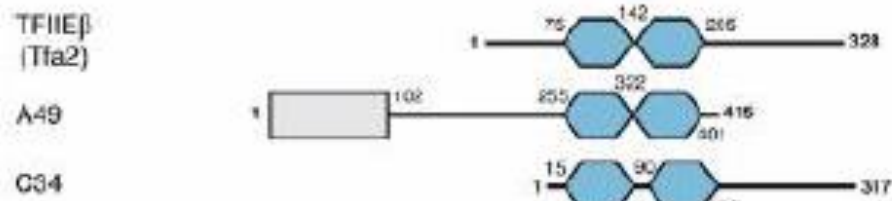
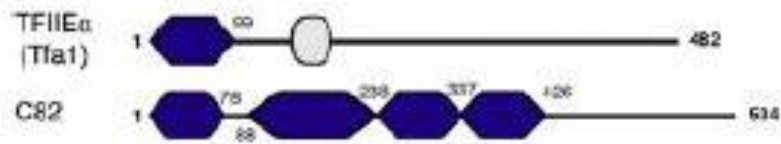
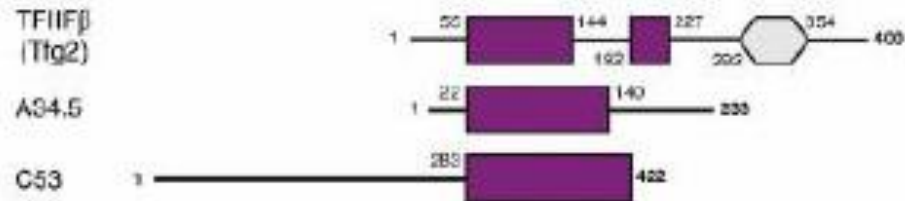
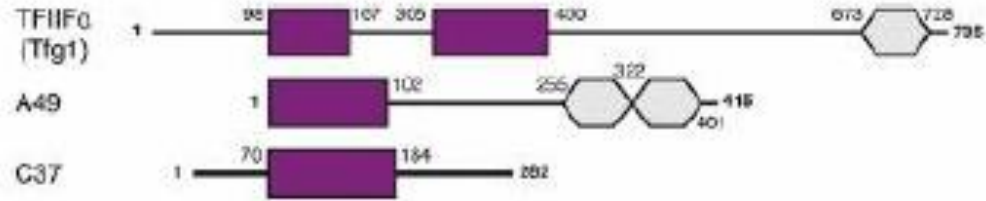

# Zinc finger

- $\beta\beta\alpha$  zinc-finger
- Hormon-receptor
- Loop-sheet-helix
- Gal4

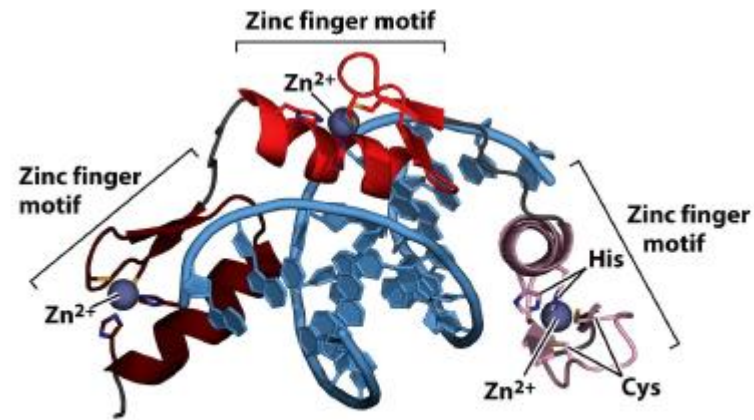

## Zinc-finger/Zinkový prst

- cca 30 AMK ve dvou krátkých antiparalelních  $\beta$ -lístech a  $\alpha$ -šroubovici
- smyčka („hairpin“) stabilizovaná („crosslinked“)  $Zn^{2+}$  - koordinovaný 4xCys nebo 2xCys + 2xHis (tetraedrická struktura)

C2H2 motiv:

Cys-X<sub>2-4</sub>-Cys-X<sub>3</sub>-Phe-X<sub>5</sub>-Leu-X<sub>2</sub>-His-X<sub>3</sub>-His

PDB grafika

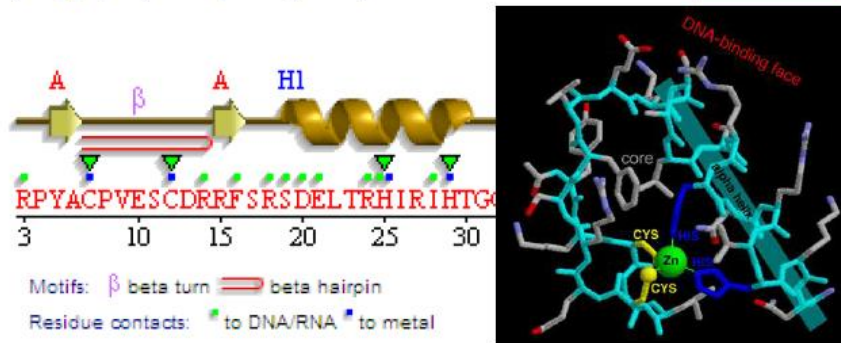
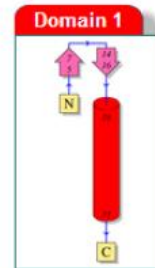

- Dobře charakterizované DNA-proteinové kontakty – je známá specifita ZFs pro všech 64 možných kombinací 3 sousedních bp
- Lze pro specifickou sekvenci DNA poskládat ZFs – nová technologie „zinc nuclease“ pro genové manipulace

## „genome editing“

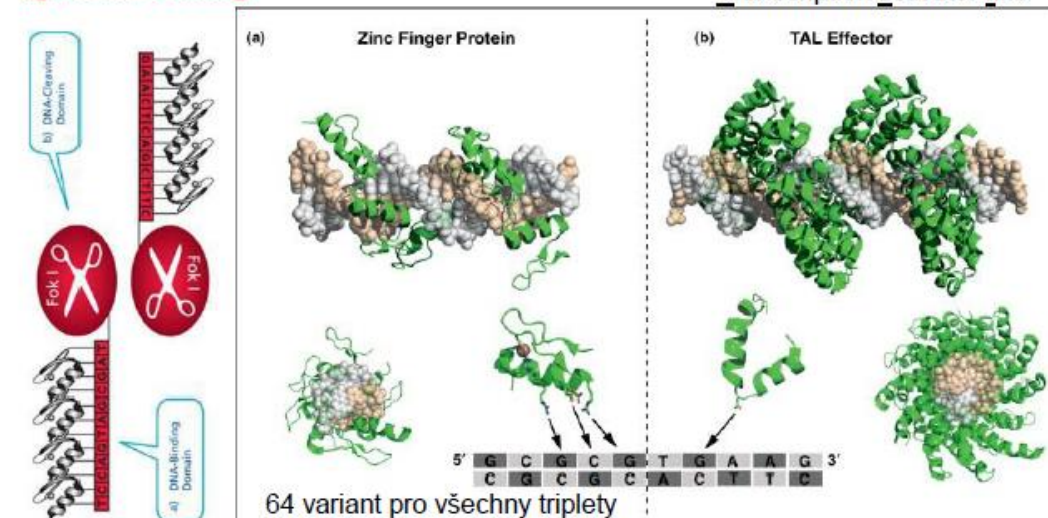

Perez-Pinera a spol., COiCB, 2012

# DNA-interacting p53 protein

## Loop-sheet-helix

- loops coming out of main core domain - protrudes  $\beta$ -sheet and  $\alpha$ -helix
- 3 Cys and 1His coordinate Zn helix in a large groove and loop in a small groove
- Activation of transcription through acidic TA domain
- core / DNA-binding domain p53 - transcription factor important for cell cycle regulation, apoptosis and repair of the damaged DNA (tumor suppressor)

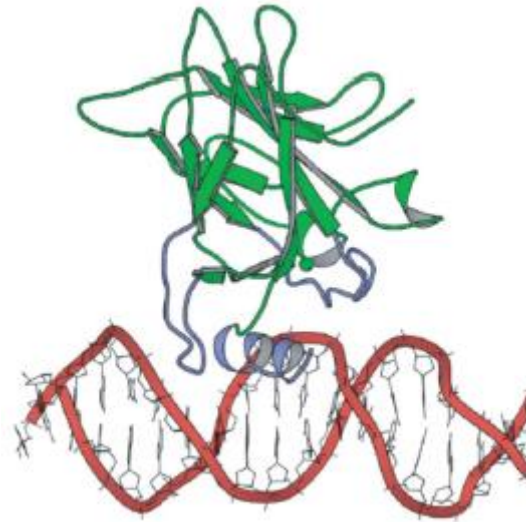

## Loop-sheet-helix

- core/DNA-vazebná doména p53 – transkripční faktor důležitý pro regulaci buněčného cyklu, apoptozy a opravy poškozené DNA (nádorový supresor)

- Konsensus sekvence PuPuPuC(A/T)(T/A)GPyPyPy (v promotorech p21, PUMA)
  - 95% “nádorových” mutací je v „core“ doméně (R273H)
  - Regulace/aktivace modifikací C-koncové domény
- Protein se váže jako tetramer (C-koncová doména)

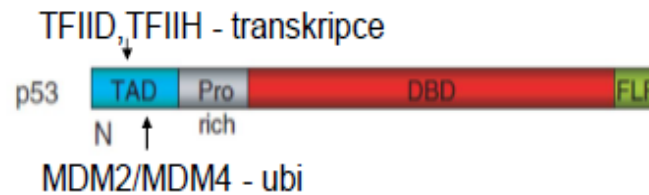
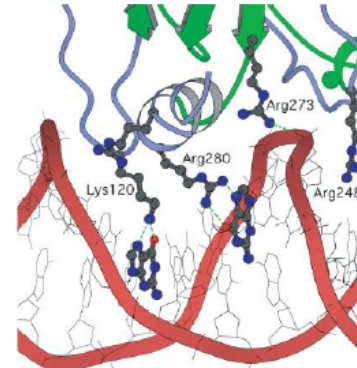

TEST

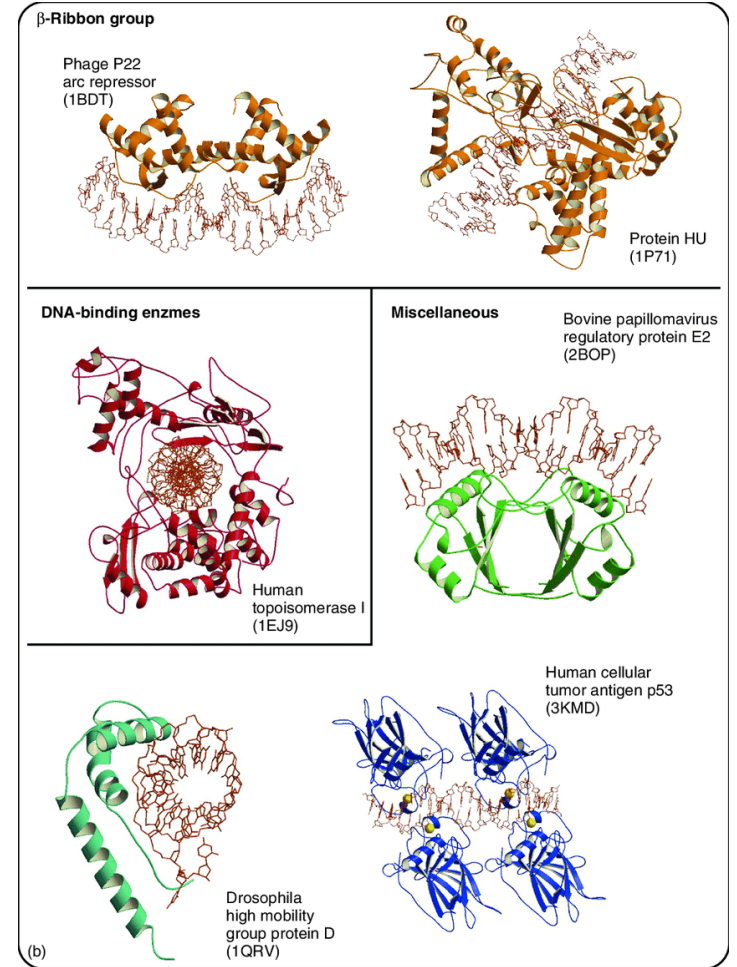

Rooman, Marianne and Wintjens, René (March 2015)

Protein–DNA Interactions. In: eLS. John Wiley & Sons, Ltd: Chichester.

DOI:

10.1002/9780470015902.a0001348.pub3

# Motives receptors for hormones, loop-sheet-helix, GAL4

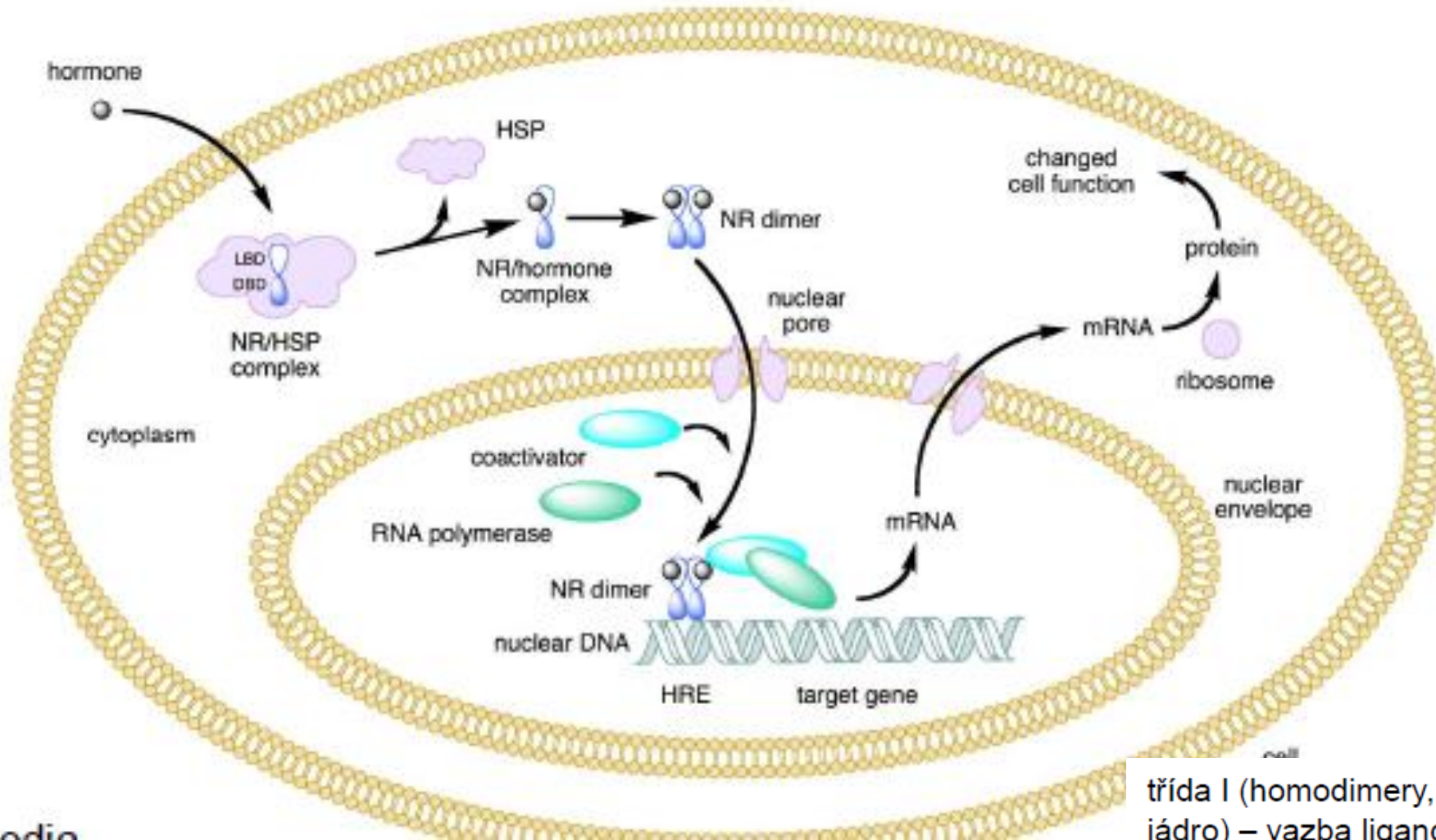

## Gal4

proteinní faktor reguluje v kvasinkách metabolismus (kvasinkový dvou-hybridní systém)

šroubovice

zinek koordinuje 2 Zn (2 Cys, 2 Zn)

šroubovice ve velkém žlábků a 2. taktu s cukr-fosfátovou trau

interakce přes krátký CC ment

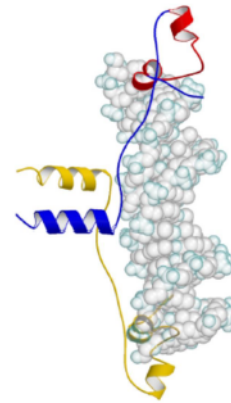

20. Gal4-type (1d66)

il.: Nature, 1992

třída I (homodimery, cytoplasmu) a třída II (heterodimery, jádro) – vazba ligandu také moduluje vazbu ko-aktivátorů (dalších transkripčních faktorů nebo chromatinových remodelátorů)

# Regulation at the transcriptional level

Basic regulation of transcription  
(common to all genes)

Regulation by components of the "basal transcription complex" (RNA polymerase binding to the TATA box, TATA binding proteins and other "basal" transcription factors binding to the RNA polymerase or in the promoter region)

Genes regulated only in this way:

**Constitutively expressed genes**

**Specific effects on gene expression:**

Through regulatory sequences in DNA and specific transcription factors.

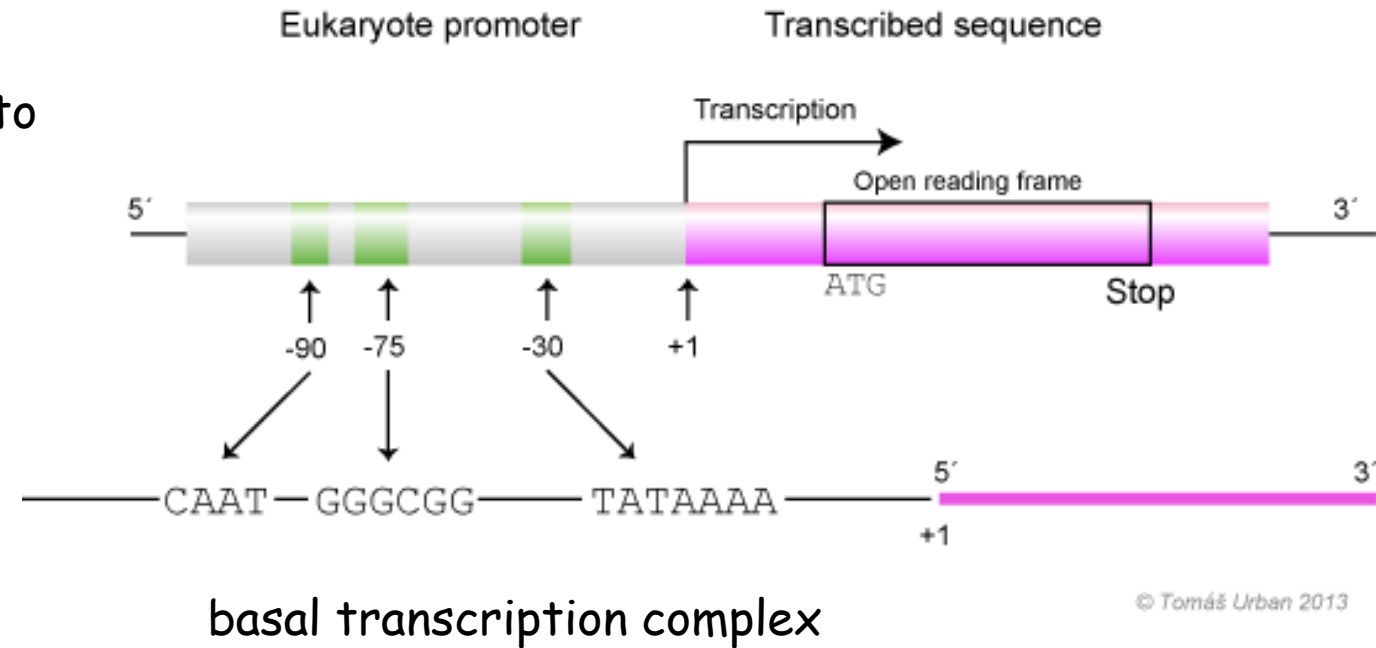

# Scheme of the activity of a master gene

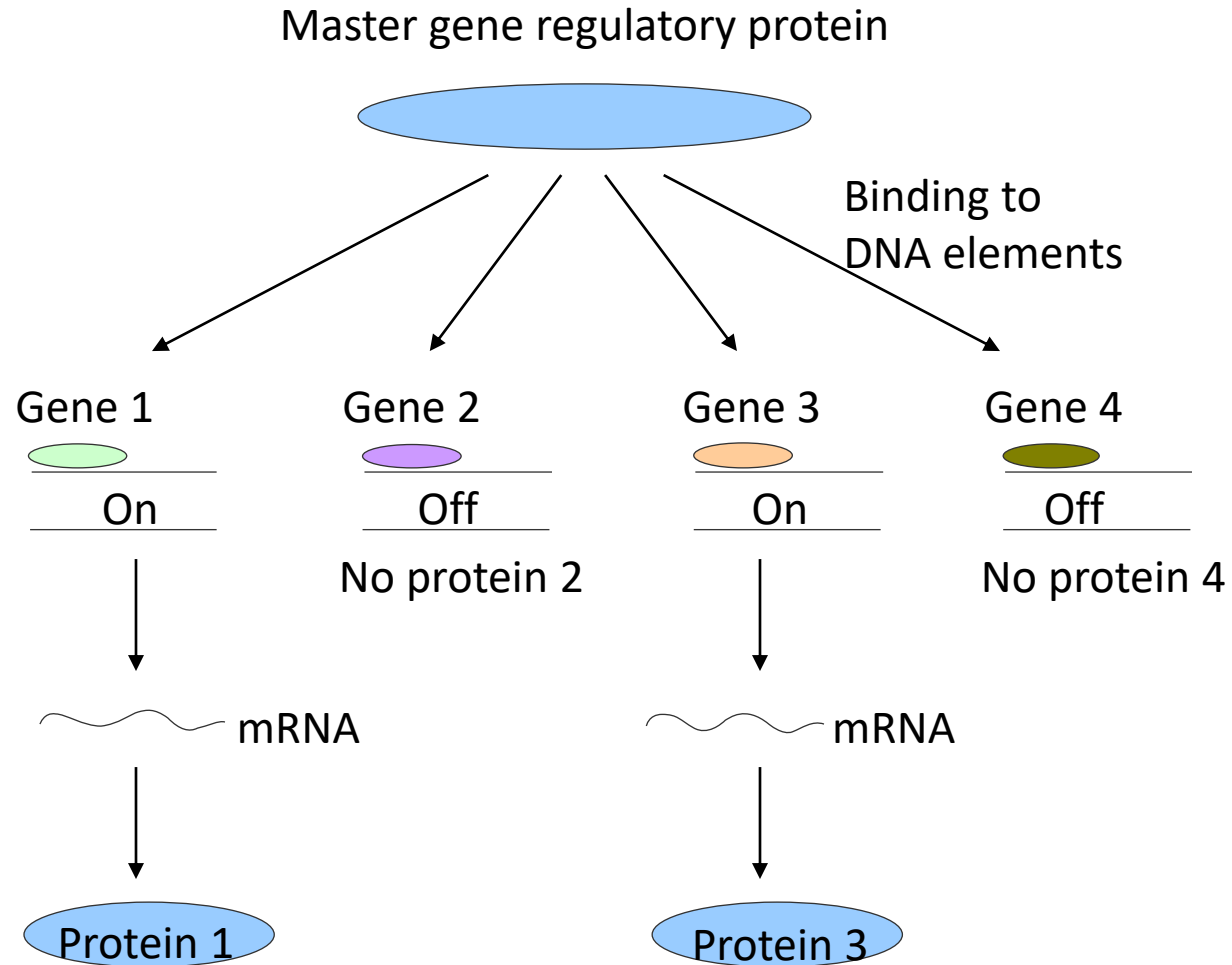



# transcription factors

## Necessary to initiate transcription

They usually induce transcription, exceptionally they can inhibit it

Their various combinations bind to the promoter before the RNA polymerase is attached

## General transcription factors

in all or most cell types

necessary to induce transcription

□ **basal TF-low** activity, minimal cell requirements

most common: TFIIA, TFIIB, TFIID (includes a subunit called TATA binding protein (TBP) - binds specifically to the TATA box sequence), TFIIE, TFIIF and TFIIH)

□ **constitutive TF** - increase the basal activity of the cell according to the cell type, the basic requirements of the cell (present (and active) in the cell at all times

- **general transcription factors**, Sp1, NF1, CCAAT)

- **special transcription factors**

They apply to inducible transcription

- only in cells of certain tissues and certain situations (example p53)

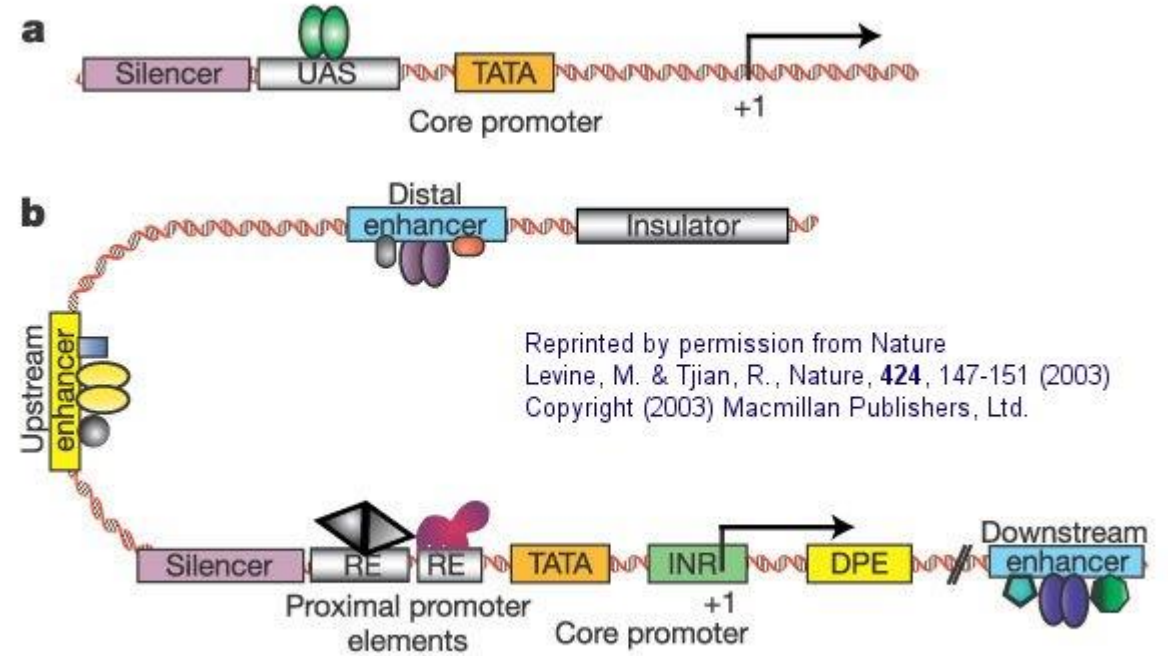

**Figure 1** Comparison of a simple eukaryotic promoter and extensively diversified metazoan regulatory modules. **a, Simple eukaryotic transcriptional unit.** A simple core promoter (TATA), upstream activator sequence (UAS) and silencer element spaced within 100–200 bp of the TATA box that is typically found in unicellular eukaryotes. **b,** Complex metazoan transcriptional control modules. A complex arrangement of multiple clustered enhancer modules interspersed with silencer and insulator elements which can be located 10–50 kb either upstream or downstream of a composite core promoter containing TATA

box (TATA), Initiator sequences (INR), and downstream promoter elements (DPE).

## Terminology

**Enhancers** - regulatory sequences in DNA that bind transactivators

Transactivators bind coactivators

**Silencers** - regulatory sequences that bind the corepressor

Hormones bind to the intracellular receptor, which binds to the hormone response element

These terms are still used. The terms are gradually being replaced:

regulatory sequences in DNA (enhancer, silencer, hormone response element)

specific transcription factors (different from basal transcription factors)

mediator proteins -coactivators

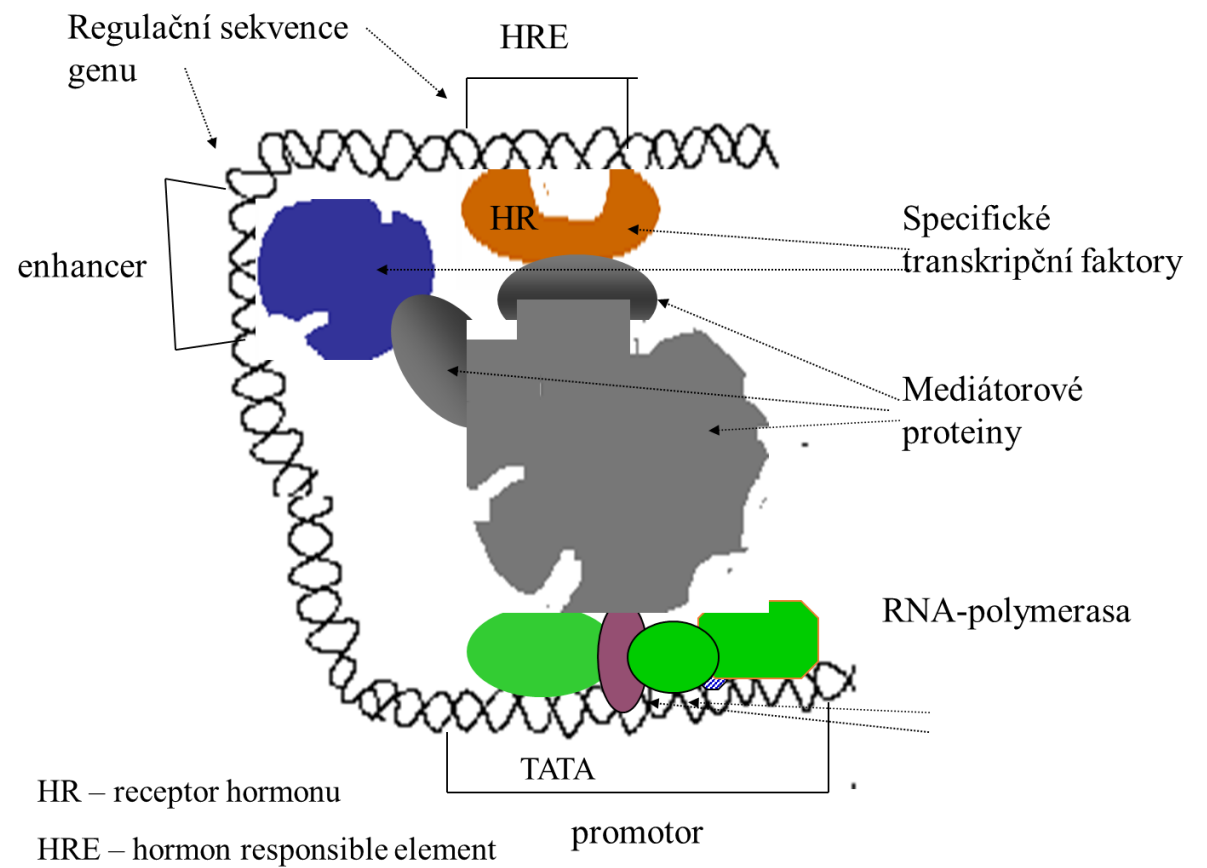

- **Transcription factors** are proteins that help turn specific genes "on" or "off" by binding to nearby DNA.
- Transcription factors that are **activators** boost a gene's transcription. **Repressors** decrease transcription.
- Groups of transcription factor binding sites called **enhancers** and **silencers** can turn a gene on/off in specific parts of the body.
- Transcription factors allow cells to perform logic operations and combine different sources of information to "decide" whether to express a gene.

# ➤ Components of the eukaryotic promoter:

- Basal transcription factors (basal, constitutive) Special transcription factors

1. Constitutive - present (and active) in the cell at all times - general transcription factors, Sp1, NF1, CCAAT
2. Conditionally active - their activation required

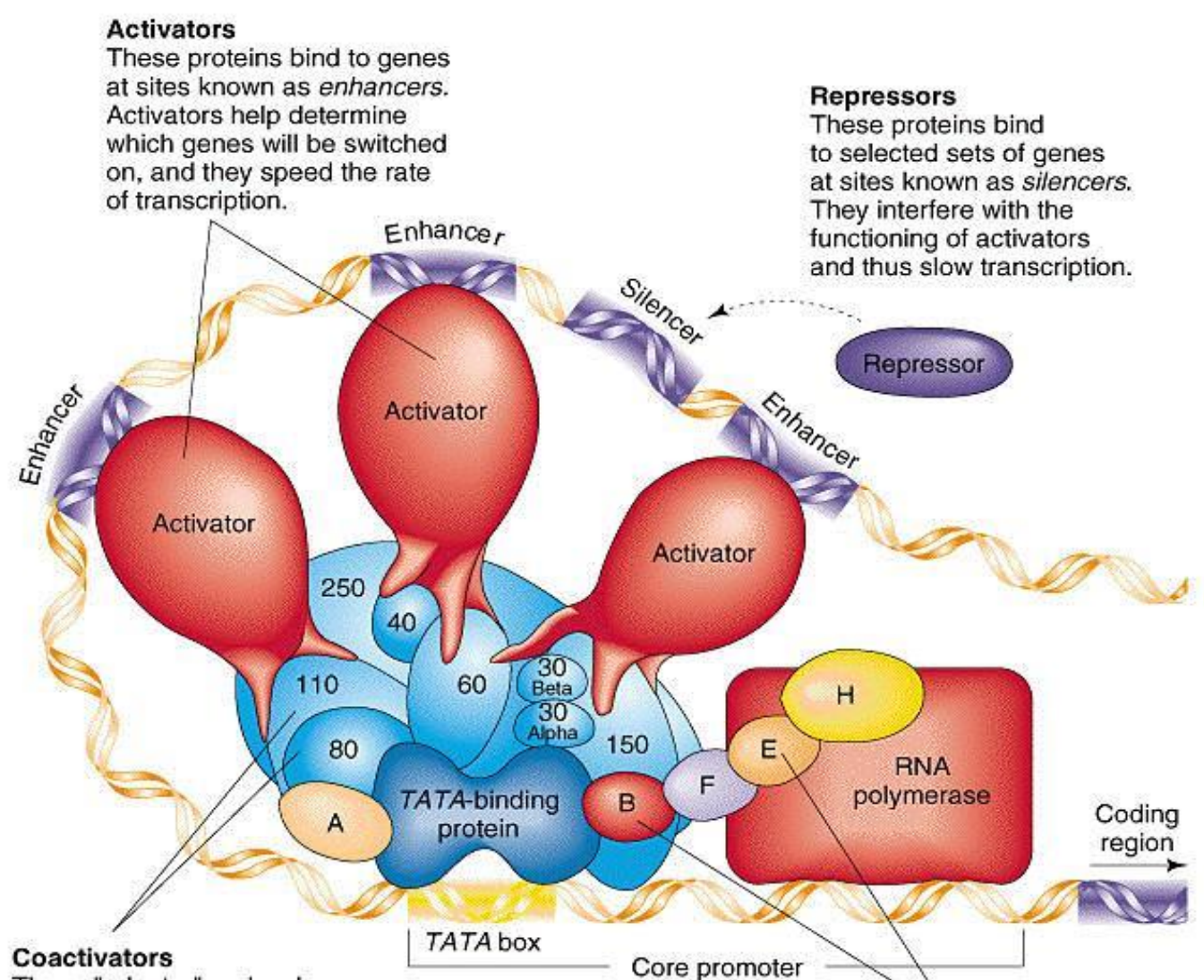

**Activators**  
These proteins bind to genes at sites known as *enhancers*. Activators help determine which genes will be switched on, and they speed the rate of transcription.

**Repressors**  
These proteins bind to selected sets of genes at sites known as *silencers*. They interfere with the functioning of activators and thus slow transcription.

**Coactivators**  
These "adapter" molecules integrate signals from activators and perhaps repressors and relay the results to basal factors.

**Basal transcription factors**  
In response to injunctions from activators, these factors position RNA polymerase at the start of the protein-coding region of a gene and send the enzyme on its way.

<http://www.cbs.dtu.dk/course/cockbooks/dave/Lekt03bkg.html>

## BASAL TRANSCRIPTION FACTORS (EUKARYOTES)

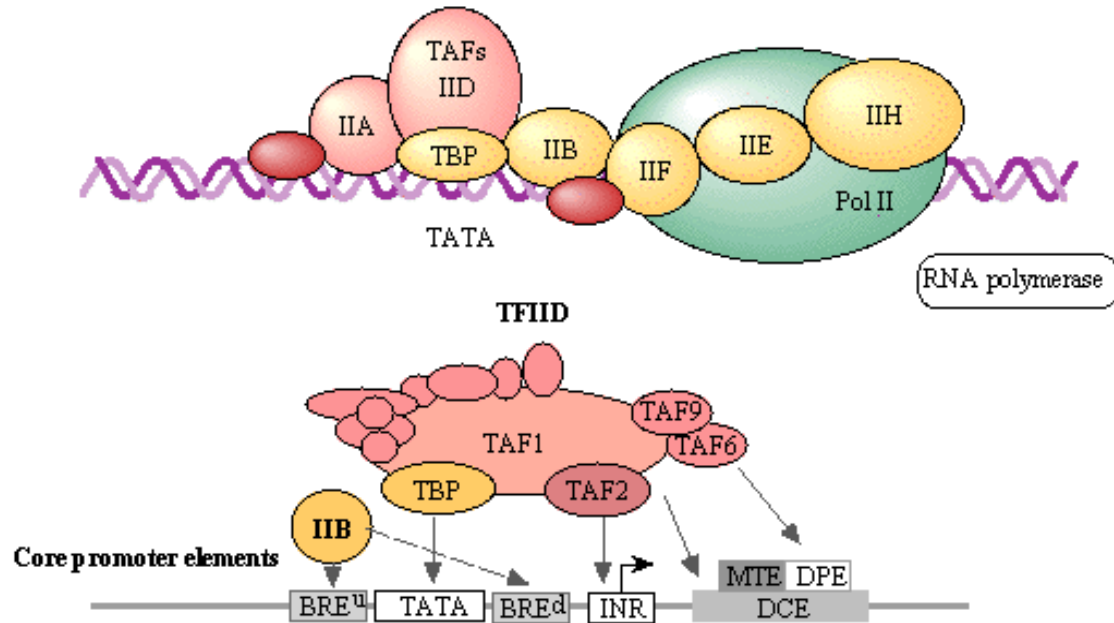

### General transcription factors for RNA polymerase II

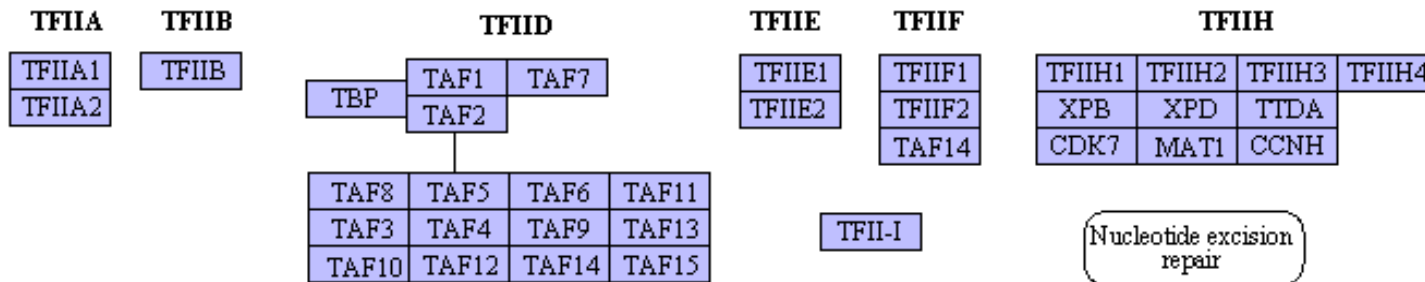

### Mechanical division

Transcription factors of the general transcription complex (TFIIA, TFIIB, TFIID, TFIIE, TFIIF, TFIIH - are ubiquitous and react with the promoter (often TATA box) of structural genes, important in the development of vertebrates and invertebrates

Upstream transcription factors (UTF) - upstream - towards the 5' part, proteins that bind to the regulatory part of the RNA polymerase I promoter at position -110 to -180, the presence is not necessary to initiate transcription, but multiplies its efficiency (it can also repressive)

Inducible transcription factors - same as UTF, but need to be activated or inhibited

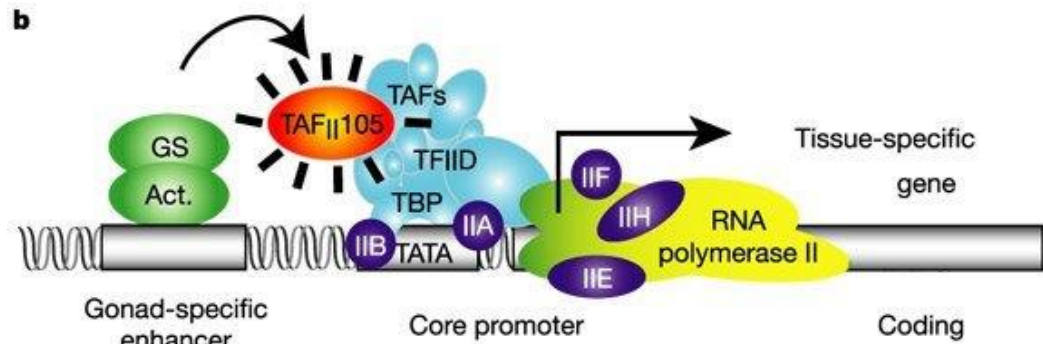
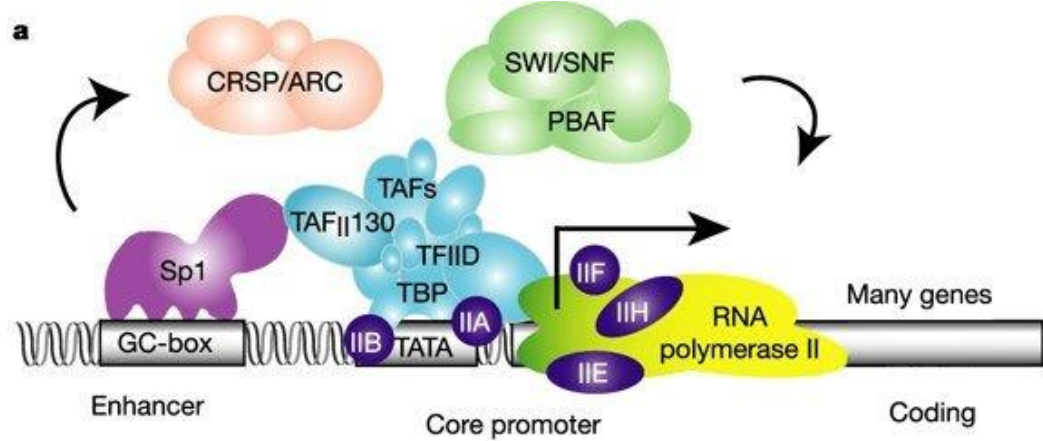

Reprinted by permission from Nature  
Levine, M. & Tjian, R., *Nature*, **424**, 147-151 (2003)  
Copyright (2003) Macmillan Publishers, Ltd.

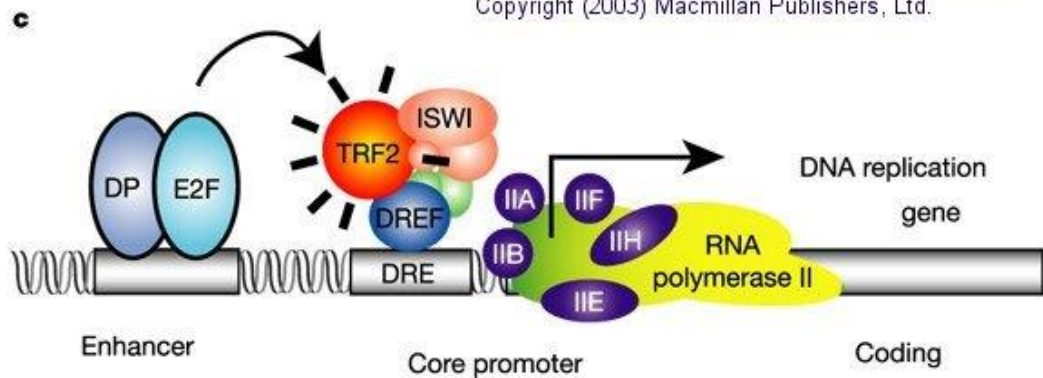

- A. "The eukaryotic transcription apparatus can be divided into three sets, which include the RNA polymerase II core complex and related general transcription factors (TFIIA, -B, -D, -E, -F and -H), multi-subunit cofactors (mediator, CRSP, TRAP, ARC / DRIP, etc.) and various chromatin modifying or remodeling complexes (SWI / SNF, PBAF, ACF, NURF and RSF).
- B. Metazoa organisms have developed multiple gene-selective and tissue-specific TFIID-like assemblies using alternative TAFs (TBP [TATA Binding Protein] -related factors such as ovarian-specific TAF105), as well as TRF (TBP-[TATA Binding Protein-associated factors] -related factors, such as is TRF2 in *Drosophila* and mice), which mediate the formation of specialized RNA polymerase initiation complexes that direct the transcription of tissue-specific and gene-selective expression programs. "(Natural link in the picture above.)"

## ➤ Methods of activation of transcription factors:

- ligand-induced conformation change (signal, eg hormone)
- conformational change after removal of the inhibitory protein
- conformational transition induced by phosphorylation
- phosphorylation by protein kinase
- phosphatase dephosphorylation
- stabilization of the transcription factor

- transkripční faktor indukující expresi genů potřebných pro svalové buňky
- obsahuje doménu šroubovice-smyčka-šroubovice (HLH) pro vazbu na DNA a dimerizaci
- funguje jako heterodimer složený z tkánově specifického proteinu HLH (**MyoD**) a obecného proteinu HLH (**proteinu E**)
- při heterodimerizaci s proteinem, který postrádá DNA vazebnou doménu (**Id**) k vazbě komplexu na DNA nemůže dojít (inhibice svalové diferenciace)

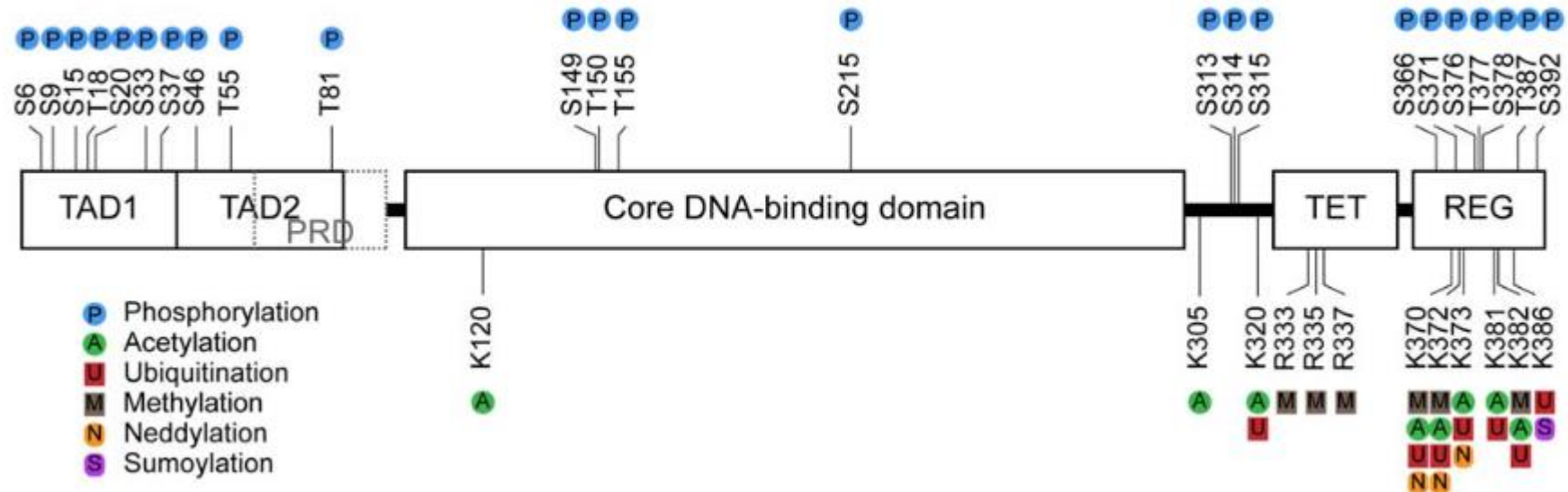
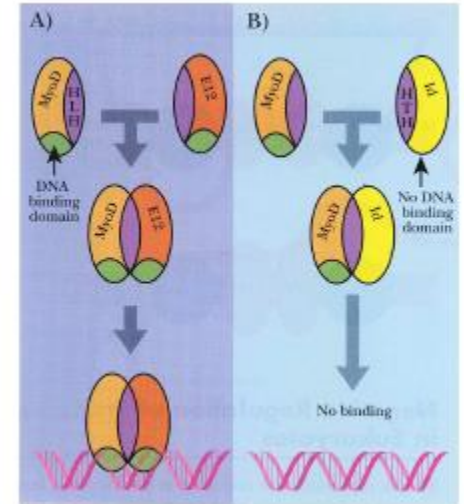

# Gene regulation by members of the nuclear receptor superfamily

## A. Glucocorticoid receptor

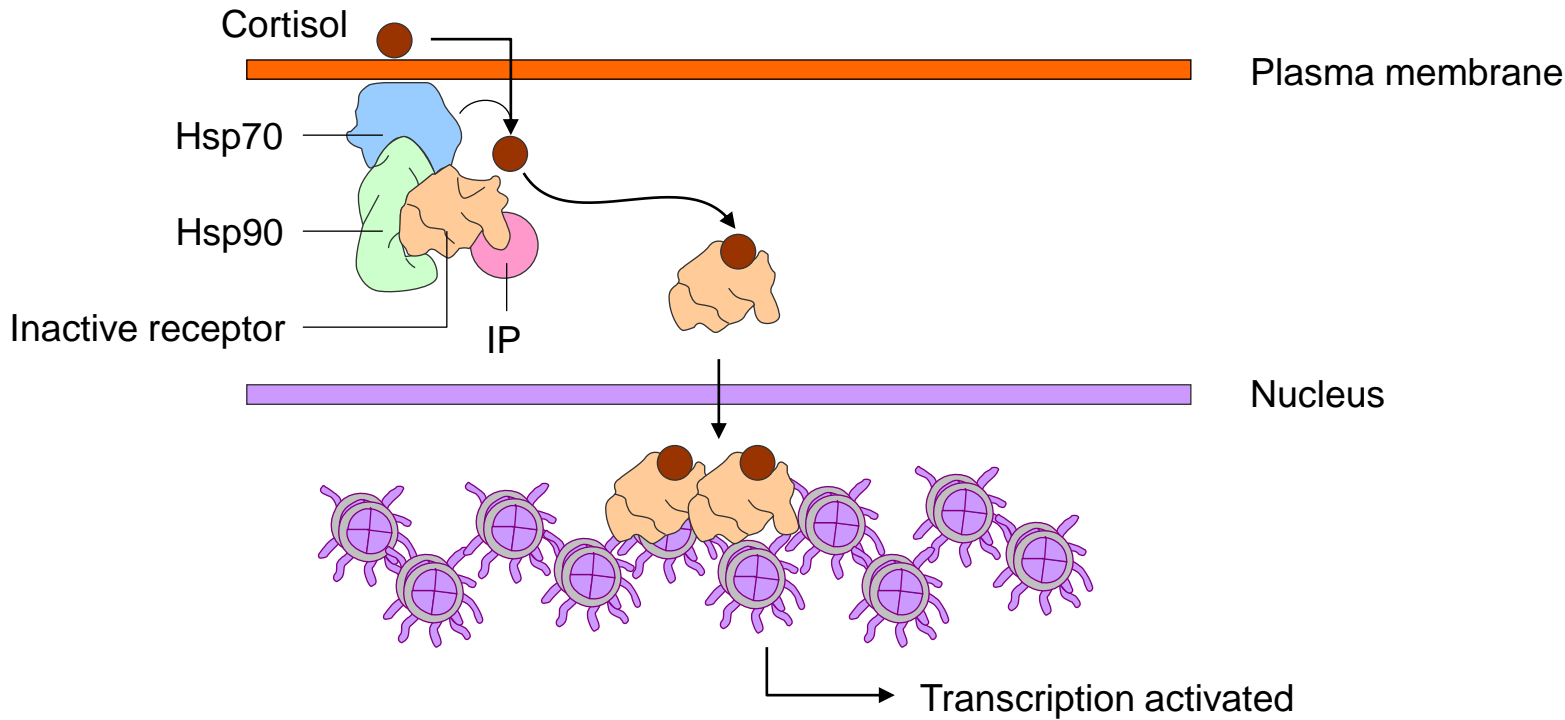

The glucocorticoid receptor (GR, or GCR), also known as NR3C1 (nuclear receptors of subfamily 3, group C, member 1), is a receptor to which cortisol and other glucocorticoids bind. GR is expressed in almost every cell in the body and regulates genes that control development, metabolism and the immune response. Because the receptor gene is expressed in several forms, it has many different (pleiotropic) effects in different parts of the body. When glucocorticoids bind to GR, its primary mechanism of action is the regulation of gene transcription. The unbound receptor resides in the cytosol of the cell. After the receptor is bound to the glucocorticoid, the receptor-glucocorticoid complex can proceed in either of two ways. The activated GR complex regulates the expression of anti-inflammatory proteins in the nucleus or suppresses the expression of pro-inflammatory proteins in the cytosol (by preventing the translocation of other transcription factors from the cytosol to the nucleus). In humans, the GR protein is encoded by the NR3C1 gene, which is located on chromosome 5 (5q31). Glucocorticoid receptor - [https://en.gaz.wiki/wiki/Glucocorticoid\\_receptor](https://en.gaz.wiki/wiki/Glucocorticoid_receptor)

# Gene regulation by members of the nuclear receptor superfamily

## B. Estrogen receptor

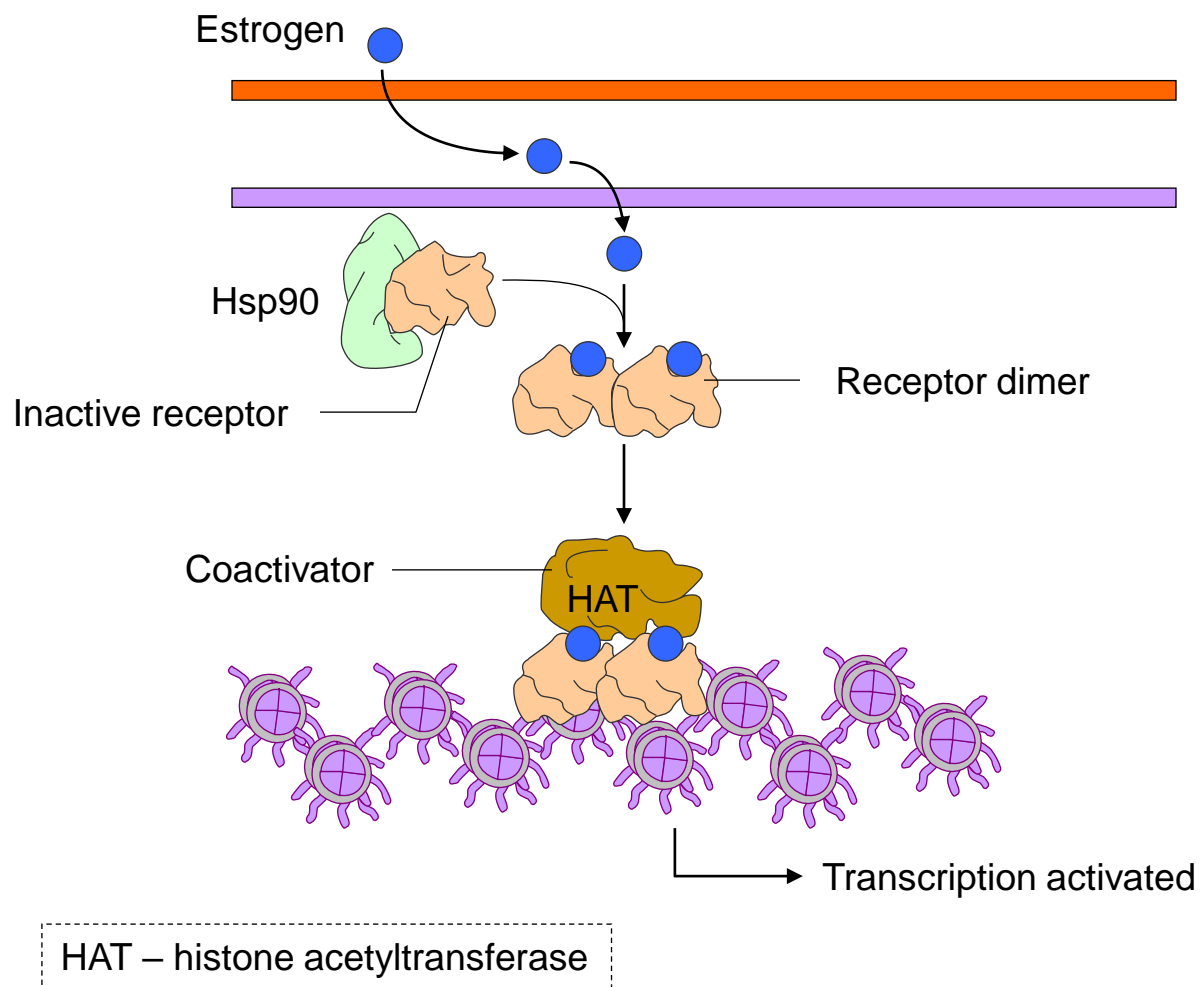

[2] Estrogen receptors (ERs) are steroid receptors present in the cell nucleus [1] of vertebrates to which estrogen binds. Humans and other mammals have two types of estrogen receptors, the estrogen receptor  $\alpha$  (ER $\alpha$ , also ESR1) and the estrogen receptor  $\beta$  (ER $\beta$ , also ESR2). Both receptors can form homodimers as well as common heterodimers. However, the GPER receptor, which is a special G protein-coupled receptor, also responds to estrogen. [2] All of these types of receptors also occur in other vertebrates, including fish. [2]

Estrogen receptors allow the detection of estrogen at specific sites in the vertebrate body. At rest, they are usually found in the cytosol, while upon binding to the ligand (estrogen), they are activated, dimerized, and enter the cell nucleus. There it binds to DNA sequences known as estrogen responsive units (EREs). The binding is also affected by other co-regulators (coactivators and corepressors). [3] Due to its receptors, estrogen controls reproduction, both the development of the reproductive system and reproductive behavior. The best known, however, is the influence on the development of female (female) genitals. Furthermore has several functions not related to reproduction, e.g. affects bone density and strength, blood lipid levels, fat storage, and management of water with salts, as well as some higher brain functions (memory effect). However, it probably also affects the development of parts of the male reproductive system, such as



# Gene regulation by members of the nuclear receptor superfamily

## C. Thyroid receptor

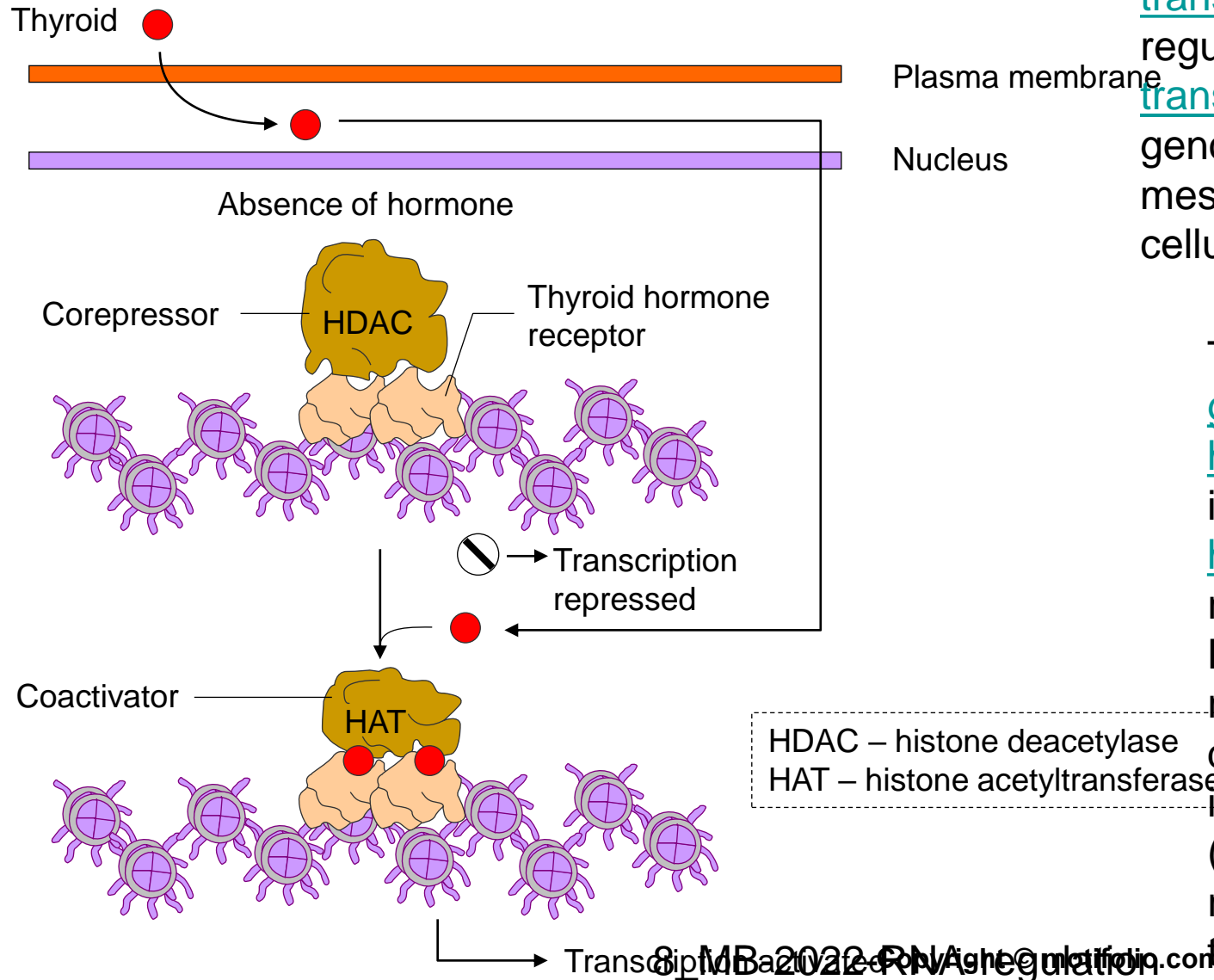

The **thyroid hormone receptor (TR)**<sup>[1]</sup> is a type of **nuclear receptor** that is activated by binding **thyroid hormone**.<sup>[2]</sup> TRs act as **transcription factors**, ultimately affecting the regulation of gene **transcription** and **translation**. These receptors also have non-genomic effects that lead to second messenger activation, and corresponding cellular response.<sup>[3]</sup>

Thyroid hormone receptors **regulate gene expression** by binding to **hormone response elements (HREs)** in DNA either as **monomers**, **heterodimers** with other nuclear receptors, or **homodimers**.<sup>[4]</sup> Dimerizing with different nuclear receptors leads to the regulation of different genes. THR commonly interacts with the **retinoid X receptor (RXR)**, a nuclear retinoic acid receptor.<sup>[9]</sup> TR/RXR heterodimers are the most transcriptionally active form of TR.<sup>[10]</sup>

# Regulation after transcription

Alternative splicing, miRNAs and siRNAs, translation initiation factors, & protein modifications.

- Even after a gene has been transcribed, gene expression can still be regulated at various stages.
- Some transcripts can undergo **alternative splicing**, making different mRNAs and proteins from the same RNA transcript.
- Some mRNAs are targeted by **microRNAs**, small regulator RNAs that can cause an mRNA to be chopped up or block translation.
- A protein's activity may be regulated after translation, for example, through removal of amino acids or addition of chemical groups.

## Regulation of RNA level

rare in bacteria, common in higher organisms

**RNA processing- alternative splicing**

**mRNA stability** - for many genes, RNA interference affects life span or translation rate

translation - regulatory proteins bind to mRNA and / or the ribosome and affect the translation rate

**control options:**

mRNA degradation rate control (mRNA stability)

converting the non-translatable mRNA into a form that can be translated

translational control by regulatory proteins

binding of antisense RNA to mRNA

# Regulation of gene expression by transcriptional modification

Alternative splicing and variation of the polyadenylation site at the 3' end causes a single gene to produce different proteins

## RNA editing

In some cases, the RNA may be edited after transcription.

The primary transcript (hnRNA) is identical, after transcription there is a base exchange or nucleotide addition (deletion)

Syntéza apoB v hepatocytech a enterocytech

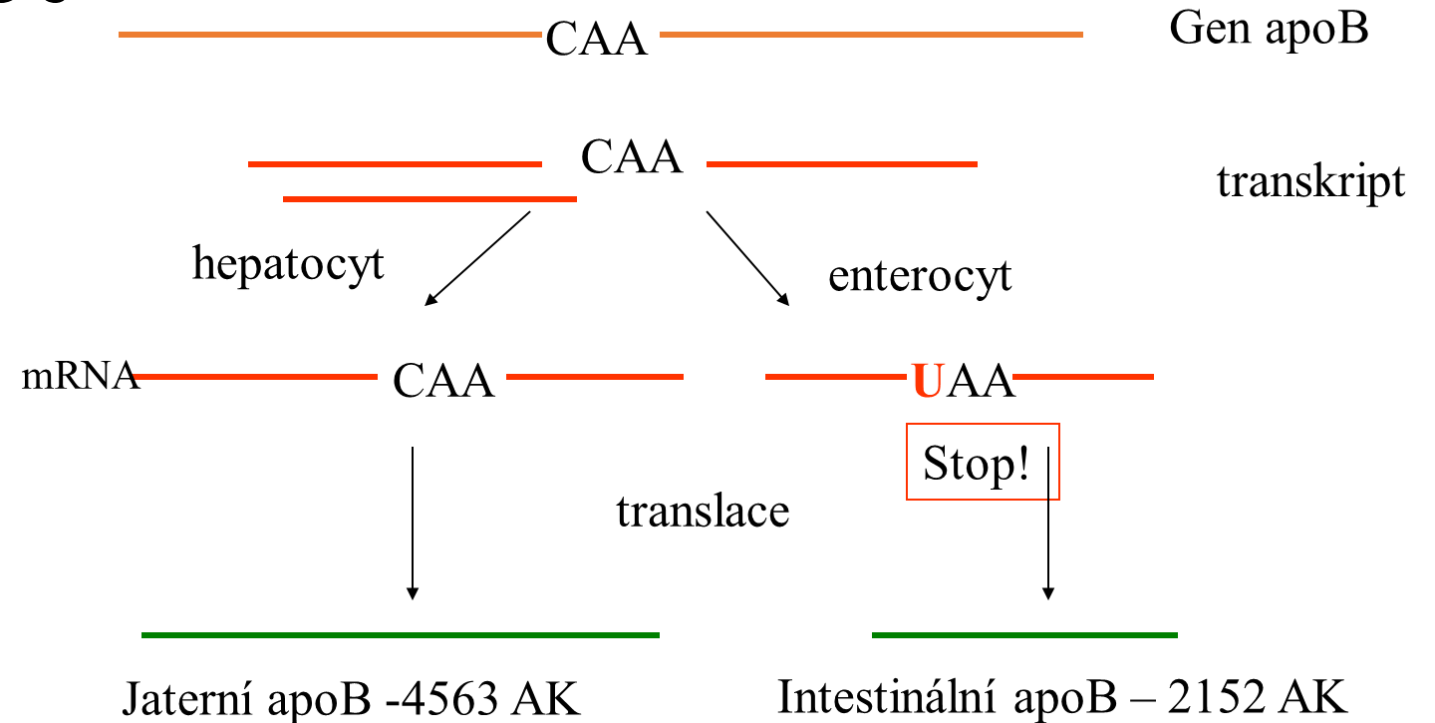

Gen apoB produkuje v játrech protein obsahující 4563 AK

Tentýž gen v enterocytech produkuje apoB obsahující jen 2152 AK

Konverze C(cytosin) na U (uracil) deaminací v RNA transkriptu generuje stop-kodón v intestinální mRNA. Tak protein produkovaný v enterocytu má pouze 48 % délky proteinu hepatálního

**Syntéza apoB v hepatocytech a enterocytech (je součástí chylomikronů a VLDL)**

# RNA level regulation

- RNA stability
- mRNA has a short half-life, upon degradation it undergoes ribonuclease degradation
- sensitivity to RNases depends on the secondary structure
- this may be affected by regulatory signals that induce the binding of regulatory proteins to RNA

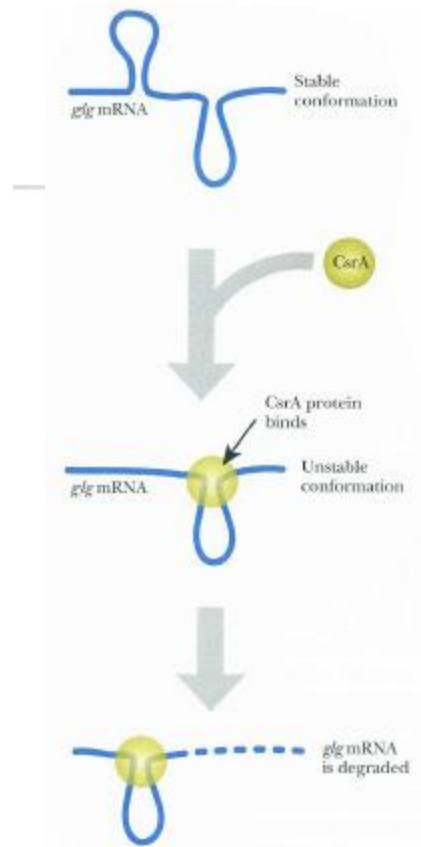

- Translation regulation
- the ribosome binding site (RBS) on the mRNA may be hidden by the secondary structure
- cleavage of a portion of the mRNA by RNase III restores RBS accessibility

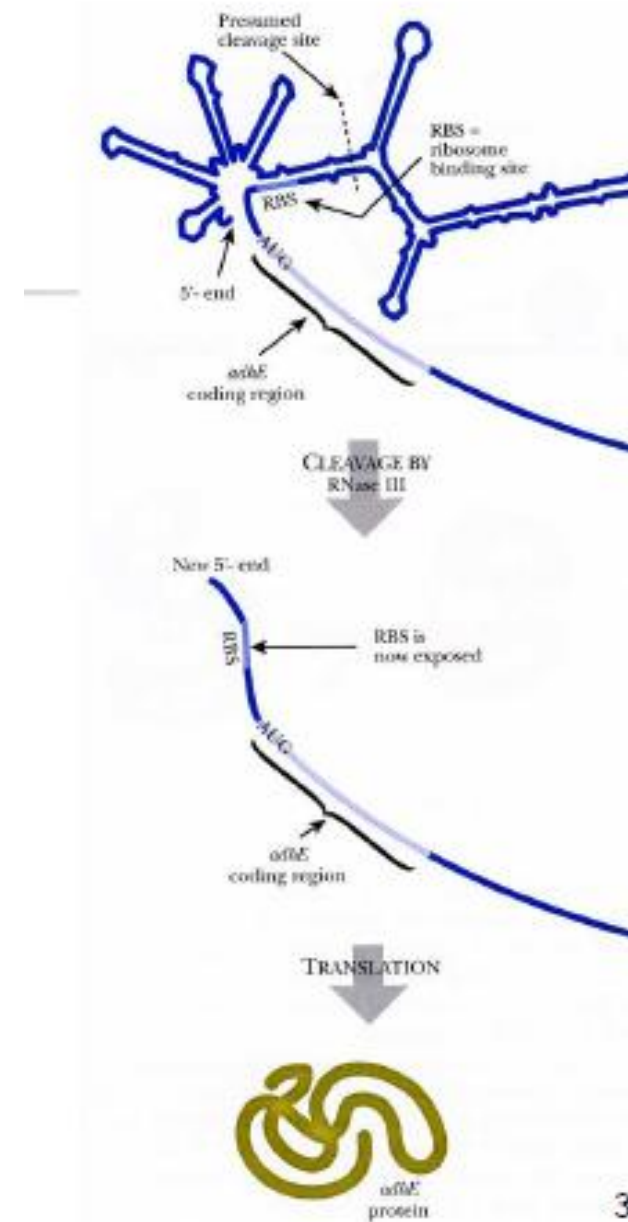

# RNA stability

- mRNA has a short half-life, it is readily degraded by ribonucleases
- mRNA secondary structure is a key component in RNase sensitivity
- mRNA secondary structure can be altered by protein binding - regulation signals

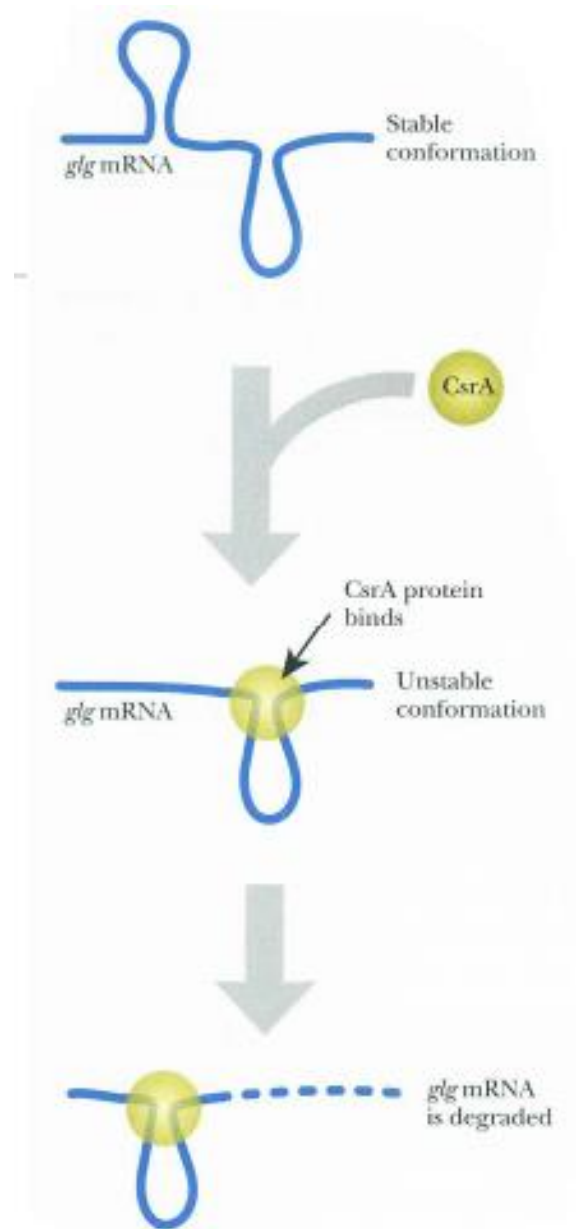

# General scheme of messenger RNA decay pathways.

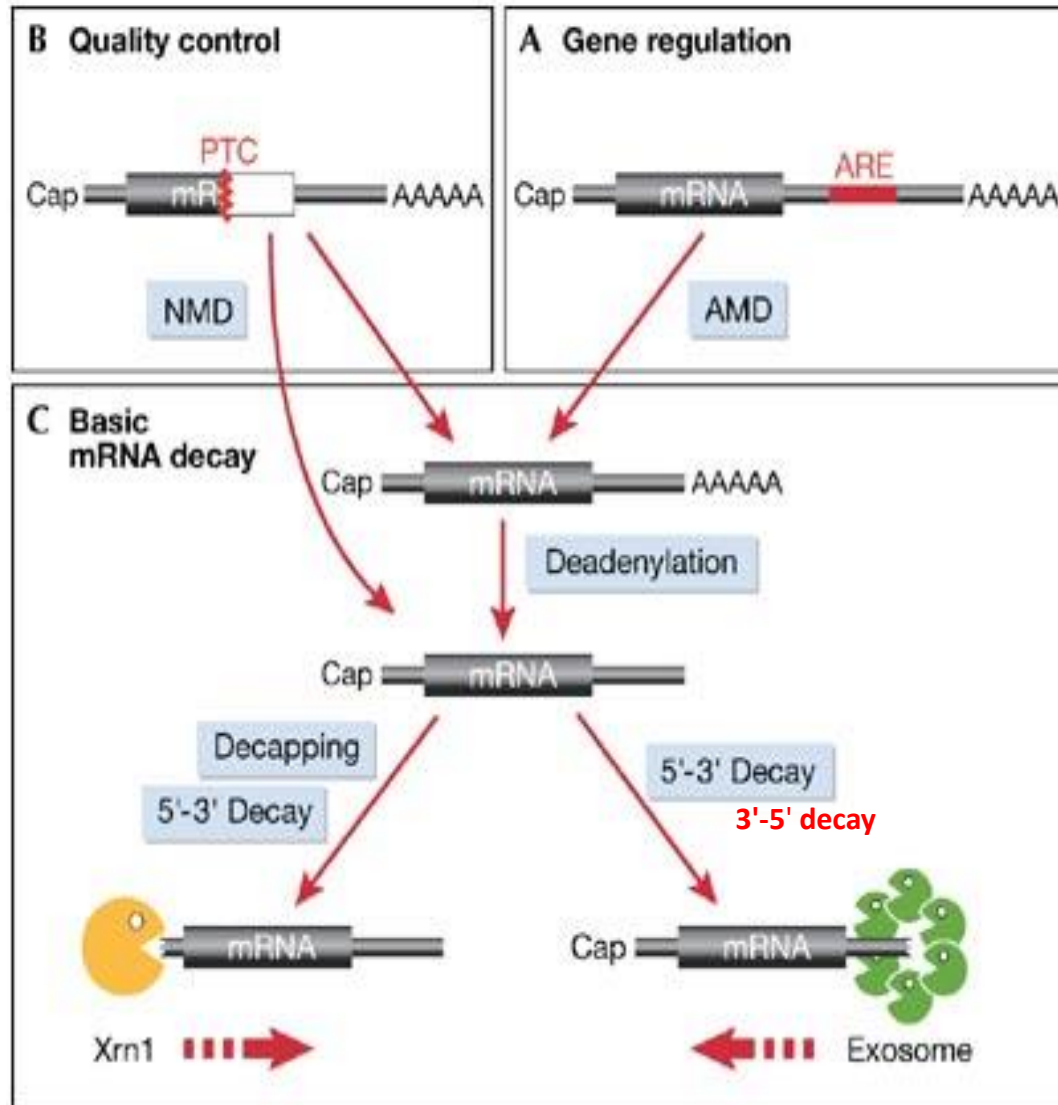

(A) mRNAs containing an AU-rich element (ARE) in their 3' UTR undergo rapid ARE-mediated mRNA decay (AMD) in resting cells. **Concealing ARE sequence from AMD induces gene expression.** (B) Quality control mechanisms. mRNAs that contain a premature termination codon (PTC) are recognized and specifically degraded by the nonsense-mediated mRNA decay (NMD) pathway. (C) The basic mRNA decay machinery in the cytoplasm initially removes the poly(A) tail through the activity of deadenylating enzymes. Subsequently, the mRNA can be further degraded from the 3' end by a complex of 3'–5' exonucleases known as the exosome. Alternatively, the mRNA is decapped at the 5' end, and the 5'–3' exonuclease Xrn1 proceeds to degrade the body of the mRNA.

Level of Regulation	Bacteria	Eukaryotes
<b>Chromatin remodeling</b>	<ul style="list-style-type: none"> <li>• Limited packaging of DNA</li> <li>• Remodeling not a major issue in regulating gene expression.</li> </ul>	<ul style="list-style-type: none"> <li>• Extensive packaging of DNA</li> <li>• Chromatin must be opened for transcription to begin.</li> </ul>
<b>Transcription</b>	<ul style="list-style-type: none"> <li>• Positive and negative control by regulatory proteins that act at sites close to the promoter</li> <li>• Sigma interacts with promoter.</li> </ul>	<ul style="list-style-type: none"> <li>• Positive and negative control by regulatory proteins that act at sites close to and far from promoter</li> <li>• Large basal transcription complex interacts with promoter.</li> <li>• Mediator complex required.</li> </ul>
<b>RNA processing</b>	<ul style="list-style-type: none"> <li>• None documented</li> </ul>	<ul style="list-style-type: none"> <li>• Extensive processing: alternative splicing of introns addition of 5' cap and 3' tail</li> </ul>
<b>mRNA stability</b>	<ul style="list-style-type: none"> <li>• Some RNA interference documented</li> </ul>	<ul style="list-style-type: none"> <li>• For many genes, RNA interference limits life span or translation rate.</li> </ul>
<b>Translation</b>	<ul style="list-style-type: none"> <li>• Regulatory proteins bind to mRNAs and/or ribosome and affect translation rate.</li> </ul>	<ul style="list-style-type: none"> <li>• Regulatory proteins bind to mRNAs and/or ribosome and affect translation rate.</li> </ul>
<b>Post-translational modification</b>	<ul style="list-style-type: none"> <li>• Folding by chaperone proteins</li> <li>• Chemical modification (e.g., phosphorylation) may change activity.</li> </ul>	<ul style="list-style-type: none"> <li>• Folding by chaperone proteins</li> <li>• Chemical modification (glycosylation, phosphorylation)</li> <li>• Ubiquitination targets proteins for destruction by proteasome.</li> </ul>

# Eukaryotic Gene Expression: An Overview

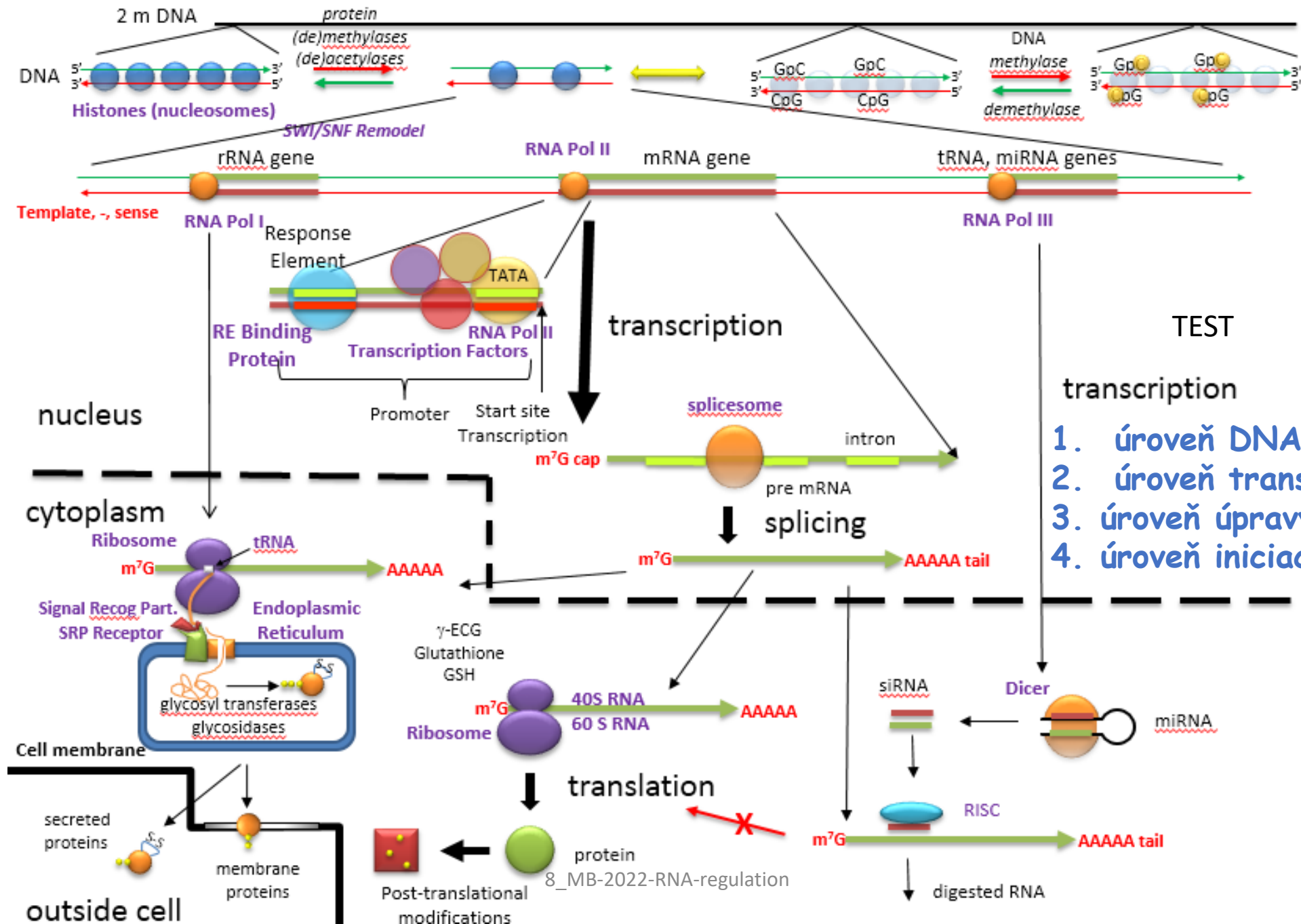

- TEST
1. úroveň DNA a chromozomů
  2. úroveň transkripce
  3. úroveň úpravy transkriptů
  4. úroveň iniciace translace

<https://employees.csbsju.edu/h.jakubowski/classes/ch331/bind/olbindtranscription.html>



# Regulatory mechanisms mediated by transcription factors by RNA

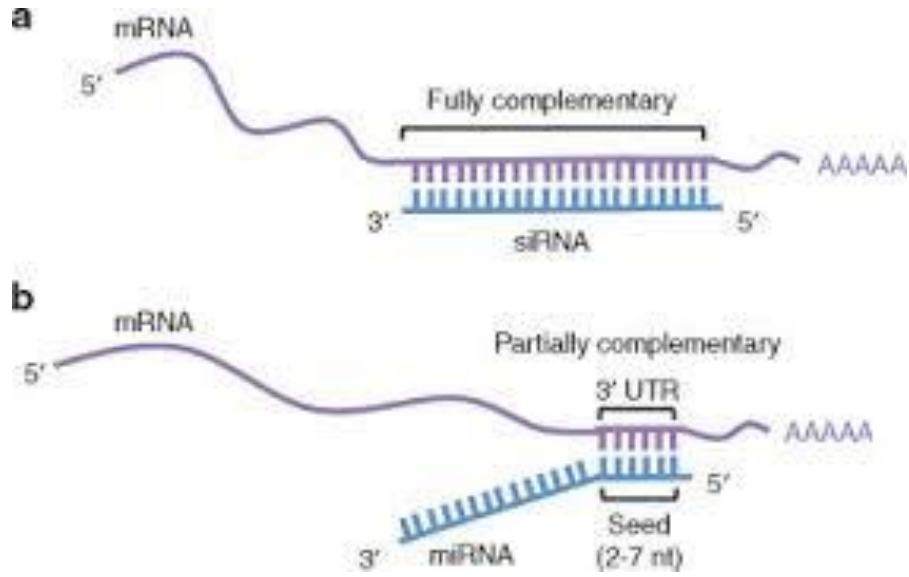
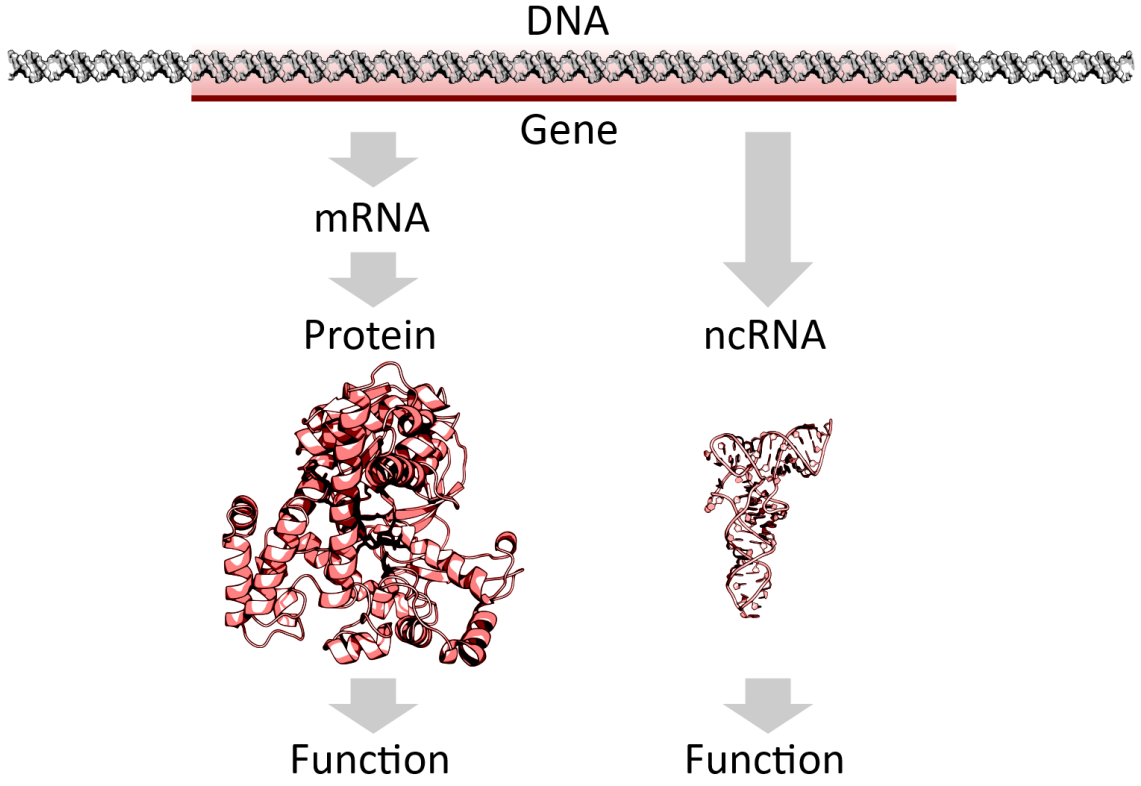

# Functional types of RNA

---

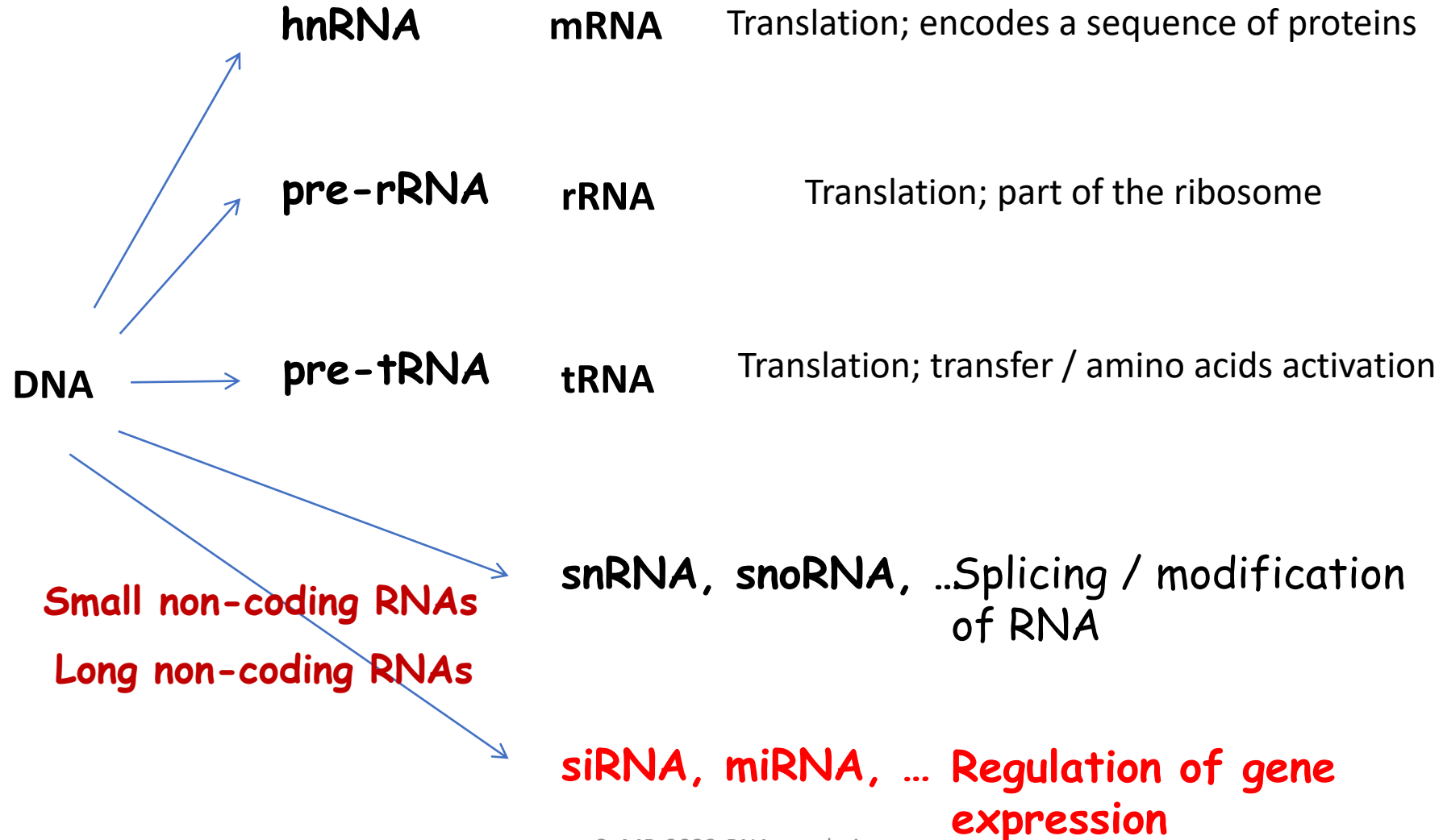

## World of noncoding RNAs

encoding genes represent less than 2% of the total genome sequence

VS.

at least 90% of the human genome is actively transcribed  
the more complex organism, the more it comprises non-coding RNAs

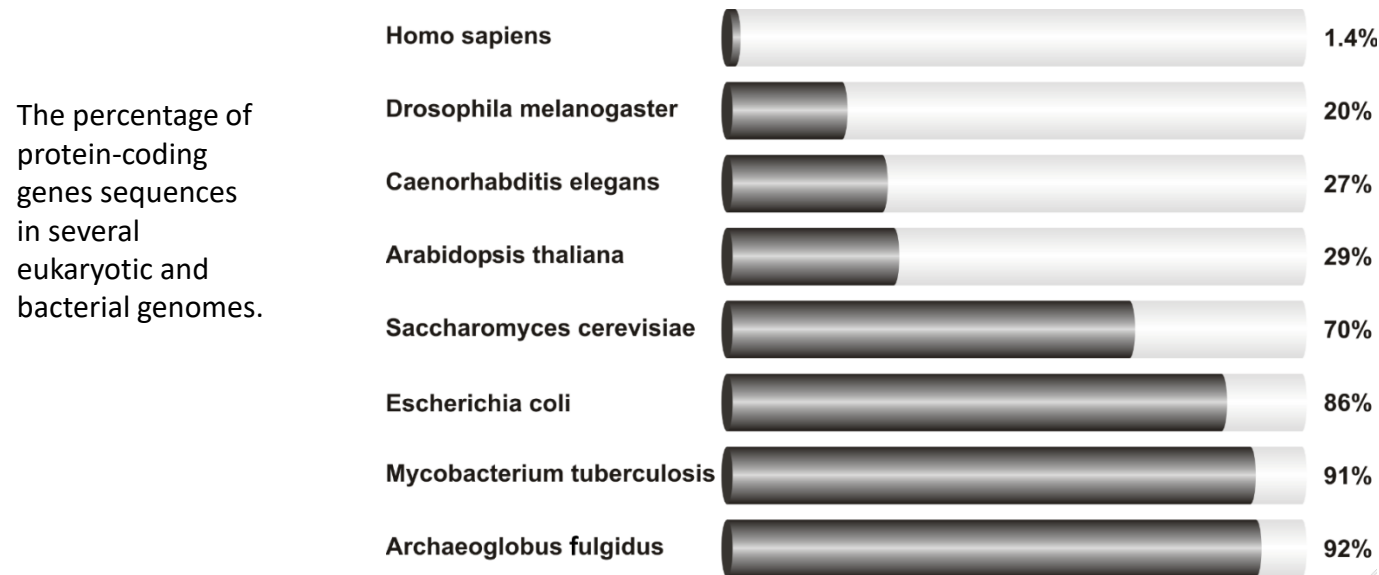

Recent evidence suggests that the non-coding RNAs (ncRNAs) may play major biological roles in cellular development, physiology and pathologies. NcRNAs could be grouped into two major classes based on the transcript size: small ncRNAs and long ncRNAs.

# Small non-coding RNAs

miRNA

siRNA

piRNA

snoRNA

PARS

tiRNA

microRNA (miRNA)  
 Piwi-interacting RNA (piRNA)  
 small interfering RNA (siRNA)  
 small nucleolar RNA (snoRNAs)  
 tRNA-derived small RNA (tsRNA)  
 small rDNA-derived RNA (srRNA)  
 small nuclear RNA,  
 also commonly referred to as U-RNA

Class	Symbol	Characteristic	Disease / biological function associations
<b>Small non-coding RNAs</b>	<b>MicroRNAs</b>	miRNAs 18–25 nt; account 1–2% of the human genome; control the 50% of protein-coding genes; guide suppression of translation; Drosha and Dicer dependent small ncRNAs	initiation of various disorders including many, if not all, cancers / regulation of proliferation, differentiation, and apoptosis involved in human development
	<b>Small interfering RNAs</b>	siRNAs 19–23 nt; made by Dicer processing; guide sequence specific degradation of target mRNA	great potential in diseases treatment / posttranscriptional gene silencing mainly through RISC degradation mechanism; defence against pathogenic nucleic acids
	<b>Piwi-interacting RNAs</b>	piRNAs 26–30 nt; bind Piwi proteins; Dicer independent; exist in genome clusters; principally restricted to the germline and somatic cells bordering the germline	relationship between piRNAs and diseases has not yet been discovered / involved in germ cell development, stem self-renewal, and retrotransposon silencing
	<b>Small nucleolar RNAs</b>	snoRNAs 60–300 nt; enriched in the nucleolus; in vertebrate are excised from pre-mRNA introns; bind snoRNP proteins	association with development of some cancers / important function in the maturation of other non-coding RNAs, above all, rRNAs and snRNAs; miRNA-like snoRNAs regulate mRNAs
	<b>Promoter-associated small RNAs</b>	PASRs 20–200 nt; modified 5' (capped) ends; coincide with the transcriptional start sites of protein- and non-coding genes; made from transcription of short capped transcripts	relationship with diseases has not yet been discovered / involved in the regulation of the transcription of protein-coding genes by targeting epigenetic silencing complexes
	<b>Transcription initiation RNAs</b>	tiRNAs ~ 18 nt; have the highest density just downstream of transcriptional start sites; show patterns of positional conservation, preferentially located in GC-rich promoters	
	<b>Centromere repeat associated small interacting RNAs</b>	crasiRNAs 34–42 nt; processed from long dsRNAs	relationship between crasiRNAs and diseases has not yet been discovered / involved in the recruitment of heterochromatin and/or centromeric proteins
	<b>Telomere-specific small RNAs</b>	tel-siRNAs ~ 24 nt; Dicer independent; 2'-O-methylated at the 3' terminus; evolutionarily conserved from protozoa to mammals; have not been described in human up to now	relationship between tel-siRNAs and diseases has not yet been discovered / epigenetic regulation
	<b>Pyknons</b>	subset of patterns of variable length; form mosaics in untranslated and protein-coding regions; more frequently in 3' UTR	expected association with cancer biology / possible link with posttranscriptional silencing of genes, mainly involved in cell communication, regulation of transcription, signaling, transport,

# Long non-coding RNAs

lincRNA

TERRAs

T-UCR

Long non-coding RNAs	Long intergenic non-coding RNAs	lincRNAs	ranging from several hundreds to tens of thousands nt; lie within the genomic intervals between two genes; transcriptional cis-regulation of neighbouring genes	involved in tumorigenesis and cancer metastasis / involved in diverse biological processes, such as dosage compensation and/or imprinting
	<b>Long intronic non-coding RNAs</b>		lie within the introns; evolutionary conserved; tissue and subcellular expression specified	aberrantly expressed in human cancers / possible link with posttranscriptional gene silencing
	<b>Telomere-associated ncRNAs</b>	TERRAs	100 bp - >9 kb; conserved among eukaryotes; synthesized from C-rich strand; polyadenylated; form inter-molecular G-quadruplex structure with single-stranded telomeric DNA	possible impact on telomere-associated diseases including many cancers / negative regulation of telomere length and activity through inhibition of telomerase
	<b>Long non-coding RNAs with dual functions</b>		both protein-coding and functionally regulatory RNA capacity	deregulation has been described in breast and ovarian tumors / modulate gene expression through diverse mechanisms
	<b>Pseudogene RNAs</b>		gene copies that have lost the ability to code for a protein; potential to regulate their protein-coding cousin; made through retrotrans-position; tissue specific	often deregulated during tumorigenesis and cancer progression / regulation of tumor suppressors and oncogenes by acting as microRNA decoys
	<b>Transcribed-ultraconserved regions</b>	T-UCRs	longer than 200 bp; absolutely conserved between orthologous regions of human, rat, and mouse; located in both intra- and intergenic regions	expression is often altered in some cancers; possible involvement in tumorigenesis / antisense inhibitors for protein-coding genes or other ncRNAs

# RNA interference - RNAi

TEST

- **sequence-specific gene silencing mechanism** triggered by **double stranded RNA**, on the **post-transcriptional level** or **transcriptional level**
- inhibitory elements are small RNA molecules (**miRNAs**, **siRNAs....**)
- **miRNAs** generated by cleavage of larger **pre-miRNA molecules**
- nucleases **Drosha and DICER**, which are compiled into multiprotein complex **RISC** (RNA-induced silencing complex) with **proteins Argonaut**
- RNA interference is a process by which **noncoding RNA molecules** interfere (pair) with target regions of **mRNA**, resulting in **prevention of gene expression** of these mRNAs.
- For short, this proces is also called RNAi. We rank him among **posttranscriptional mechanisms** of **gene expression**.
- **Most eucaryotic organisms is capable of RNA interference**, the process was first studied in the **C. elegans**.

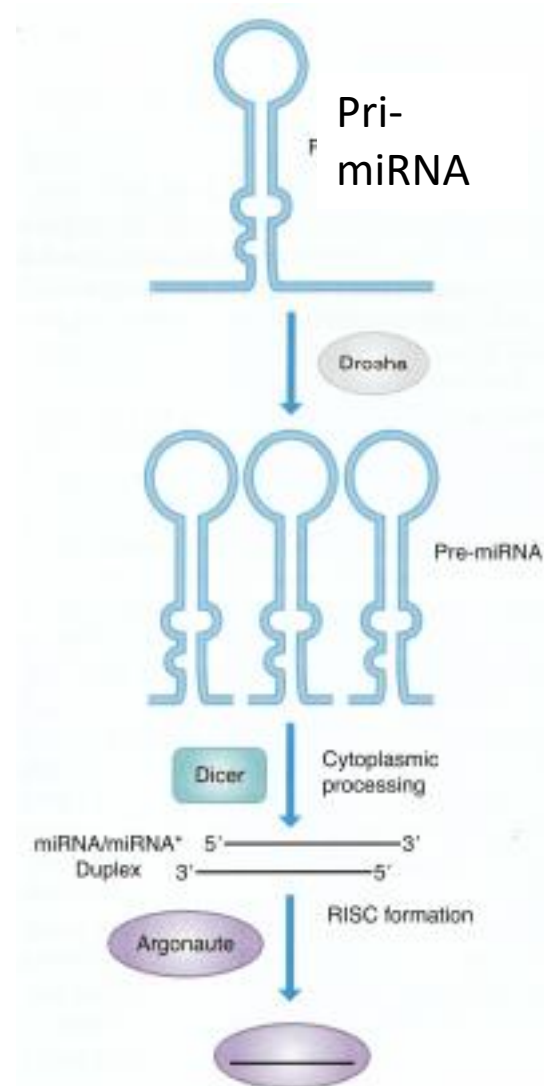

# RNA interference

**RISC** has helicase activity, thanks to which miRNA is loosened; only one chain remains associated with the complex

that allows **sequence-specific binding of the whole complex to the target complementary mRNA**

nuclease activity of RISC complex **cleaves the mRNA** - its degradation occurs

Originally protecting **cells against viruses**

**common in eukaryotic cells**

**useful for targeted inactivation of genes: research of gene functions**

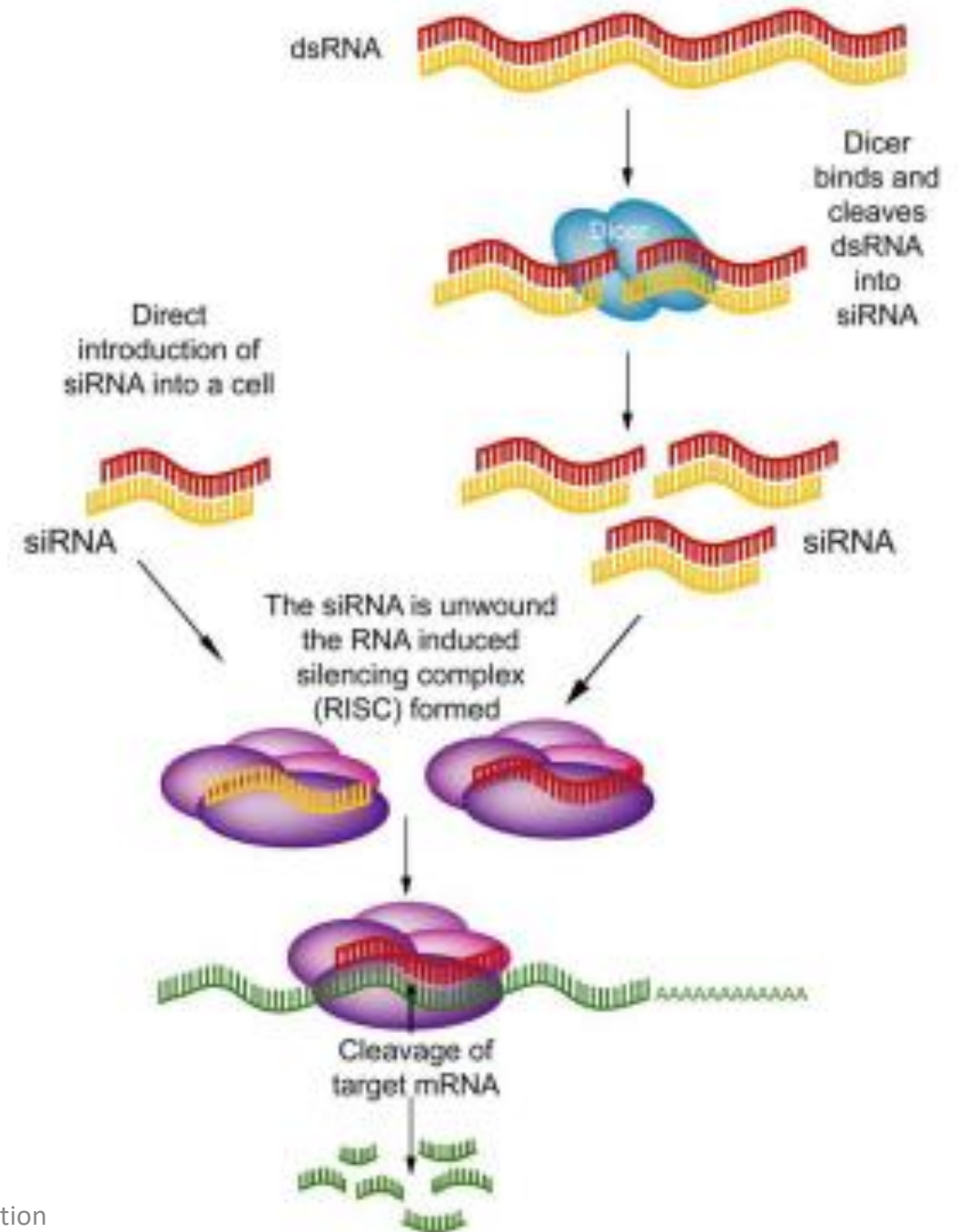

# Discovery of RNA interference (1998)

- silencing of gene expression with dsRNA



The Nobel Prize in Physiology or  
Medicine 2006

"for their discovery of RNA interference - gene silencing by  
double-stranded RNA"



Photo: L. Cicero

**Andrew Z. Fire**



Photo: J. Mottern

**Craig C. Mello**



*Cenorhabditis  
elegans*



# Mechanism of action of small RNA- depends on the length of sRNA, biogenesis (precursor), ...

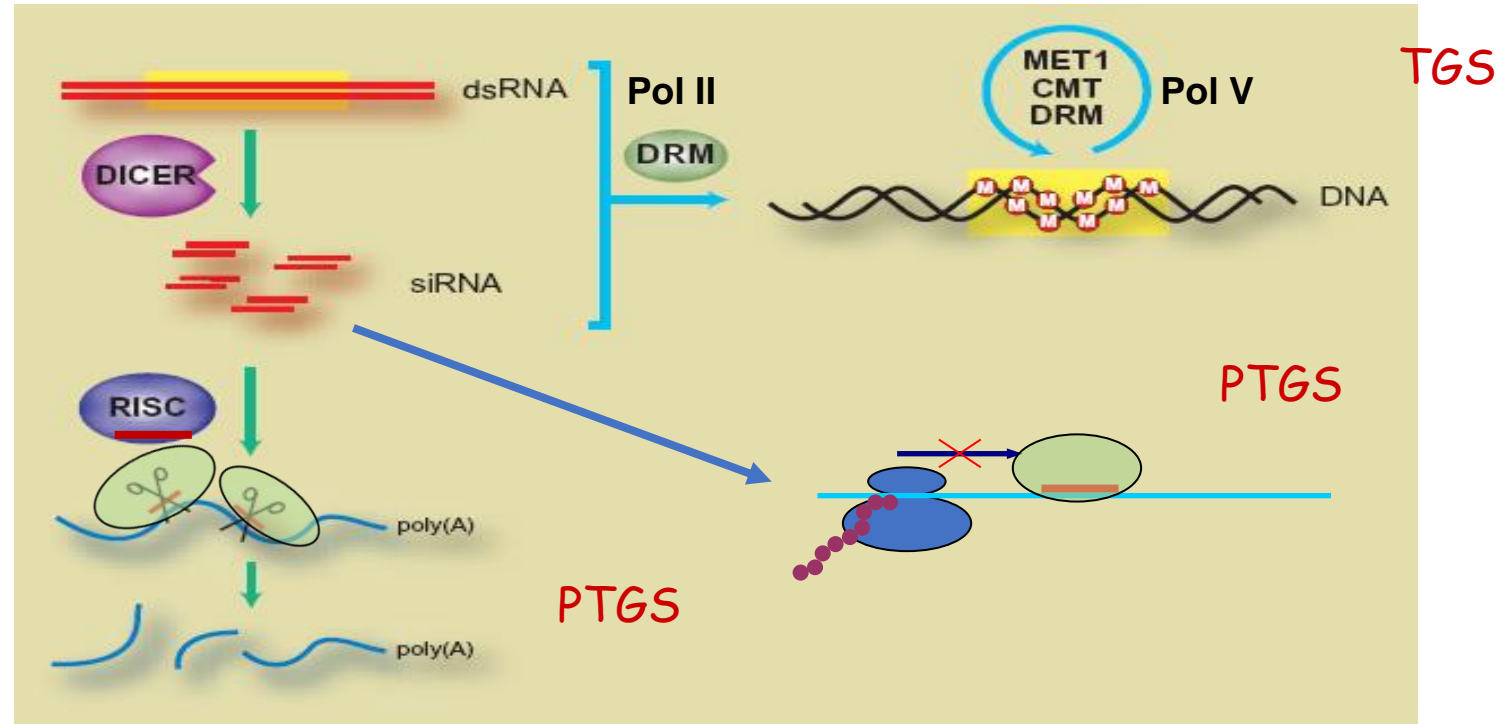

**PTGS (posttranscriptional gene silencing):**

- specific transcription degradation or translation blocking

**TGS (transcriptional gene silencing):**

- methylation of cytosines in the promoter (RdDM), heterochromatinization, inhibition of transcription factor binding



# Basic mechanism of RNAi

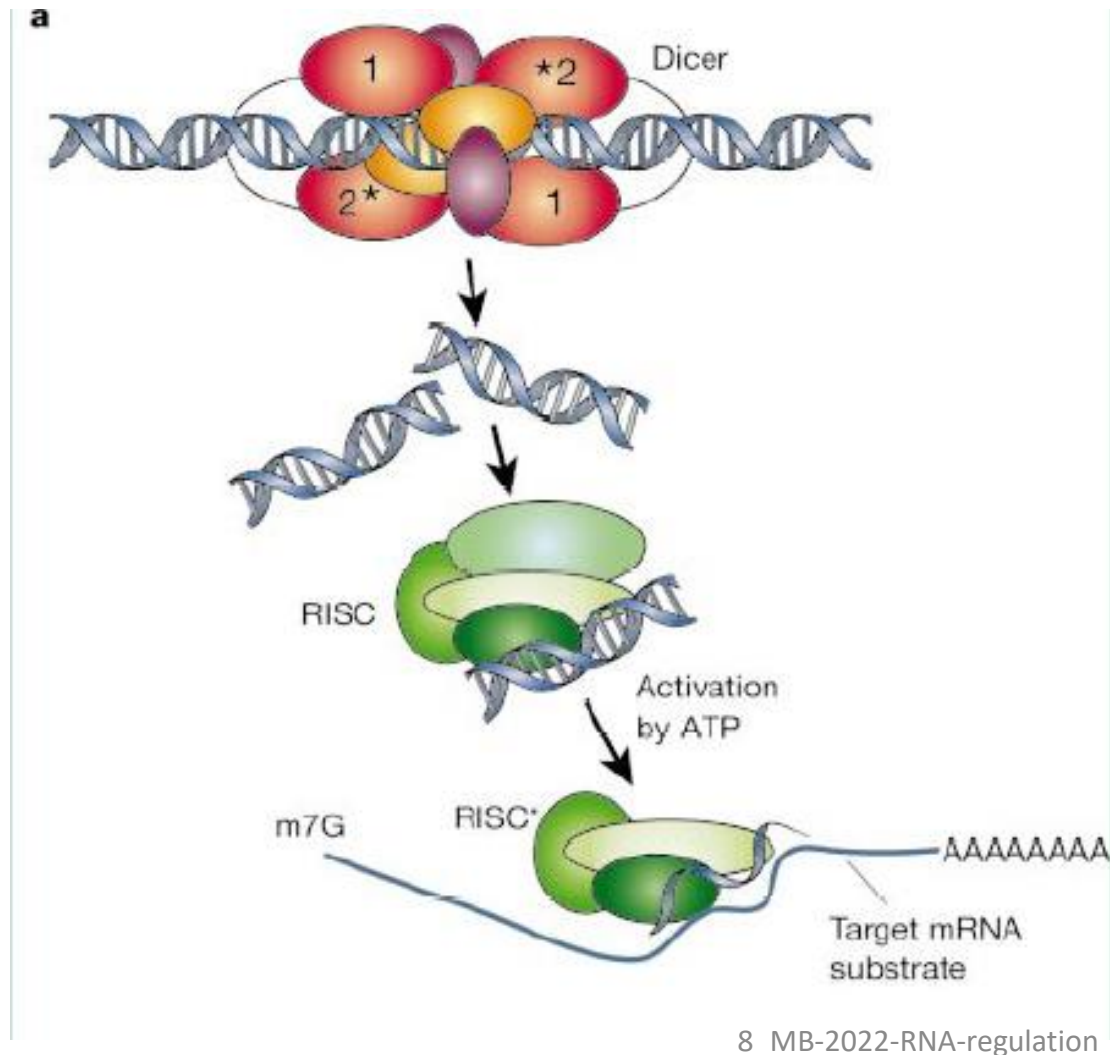

dsRNA in cell is cleaved by RNase DICER into short dsRNA fragments – sRNA

Argonaute with a single strand (from sRNA) mediates recognition of complementary sequences, which should be silenced (TGS, PTGS)

# Small RNA in plants/animals

- 3' end of sRNA methylated (HEN1) - protection
- **miRNA (micro)** – from transcripts of RNA Pol II (pre-miRNA)
  - hundreds MIR genes (*in trans*)

Pol II

DROSHA (Rnase III),  
PASHA (RNA binding protein),  
DICER

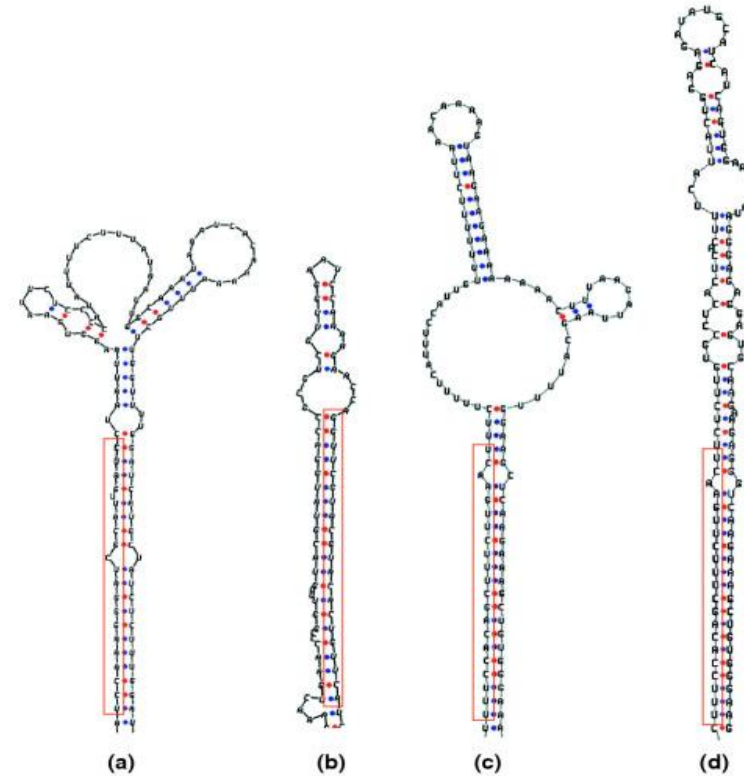

- **siRNA (small interfering)** – from dsRNA of various origin (both internal and external – thousands types (both *in cis* and *in trans*)

# miRNA biogenesis

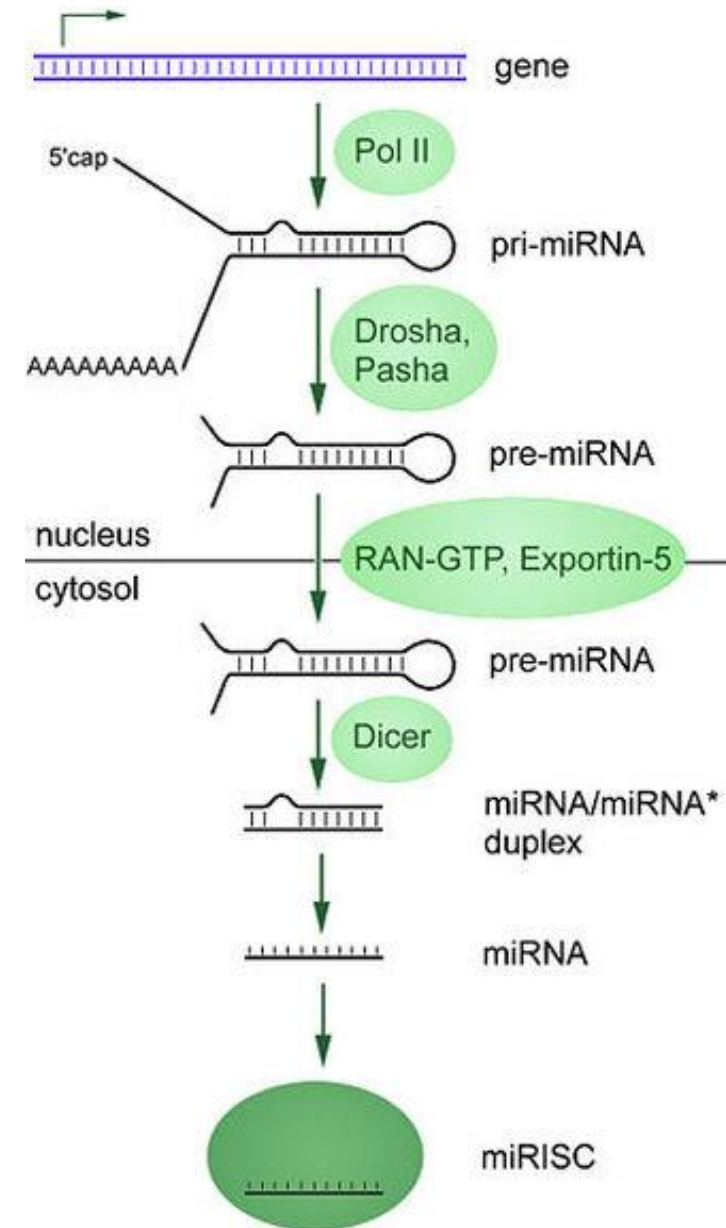

# siRNA

- **siRNA (small interfering)** from dsRNA of various origin (both internal and external – thousands types (both *in cis* and *in trans*)

animals)

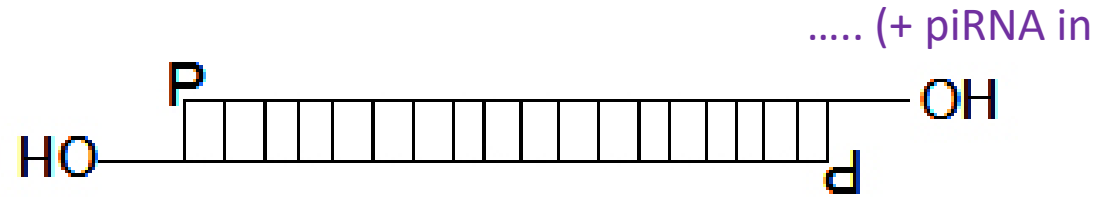
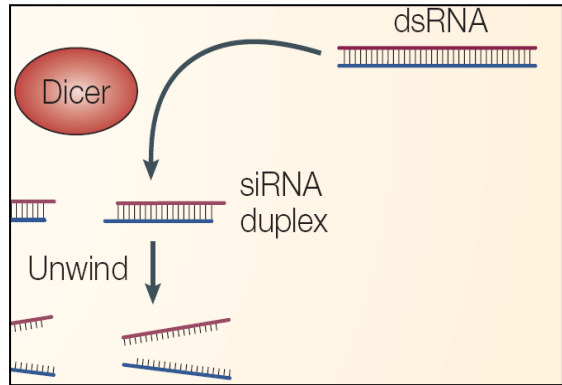

Schematic representation of a siRNA molecule: a ~19-21basepair RNA core duplex that is followed by a 2 nucleotide 3' overhang on each strand. OH: 3' hydroxyl; P: 5' phosphate.

DICER

**Dicer**, also known as **endoribonuclease Dicer** or **helicase with RNase motif**, is an [enzyme](#) that in humans is encoded by the *DICER1* [gene](#). Being part of the [RNase III](#) family, Dicer cleaves [double-stranded RNA](#) (dsRNA) and pre-microRNA (pre-miRNA) into short double-stranded RNA fragments called [small interfering RNA](#) and [microRNA](#), respectively. These fragments are approximately 20-25 [base pairs](#) long with a two-base overhang on the 3' end. Dicer facilitates the activation of the [RNA-induced silencing complex](#) (RISC), which is essential for [RNA interference](#). RISC has a catalytic component [argonaute](#), which is an [endonuclease](#) capable of degrading [messenger RNA](#) (mRNA).

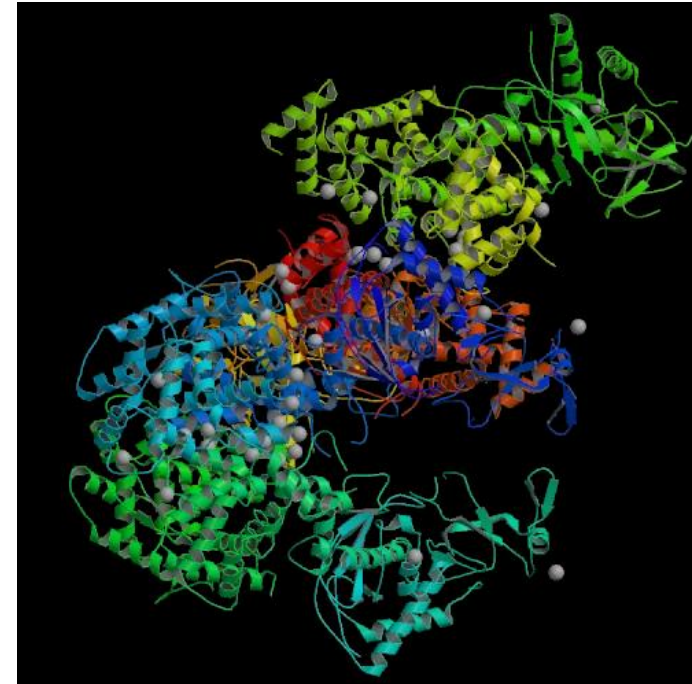

# Argonaute

RNA binding protein (20-26 nt RNA)

- strand selection (5' nt, participation of HSP90)
- 10 genes in *Arabidopsis*
- main component of RISC (RNA induced silencing complex)
- block of translation or slicer (RNase H-like endonuclease - PIWI domain)
- role in TGS (RdDM) (RNA directed DNA methylation)

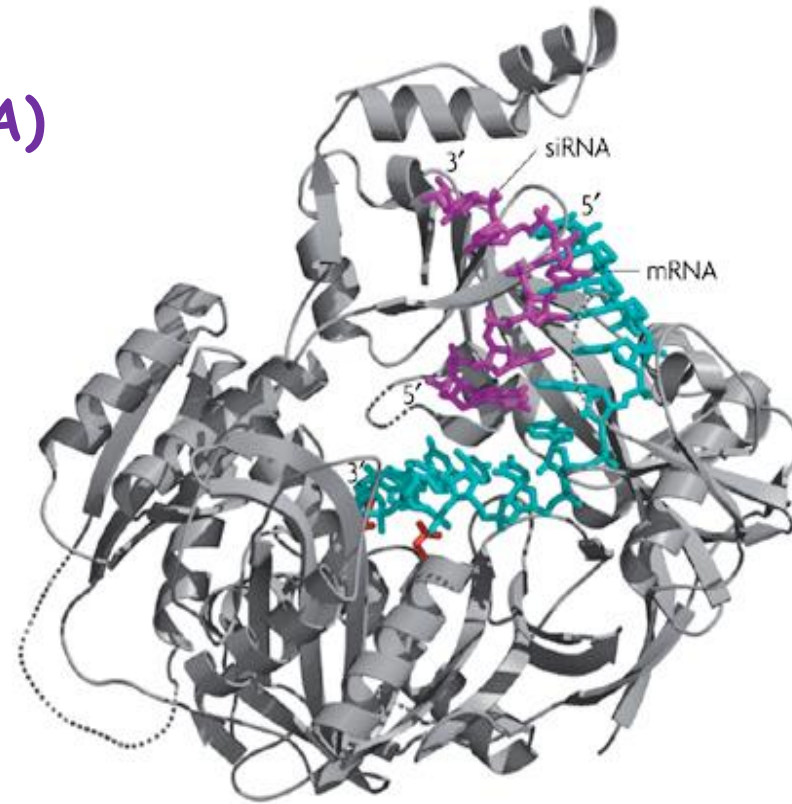

# Mechanism of small RNA action - overview

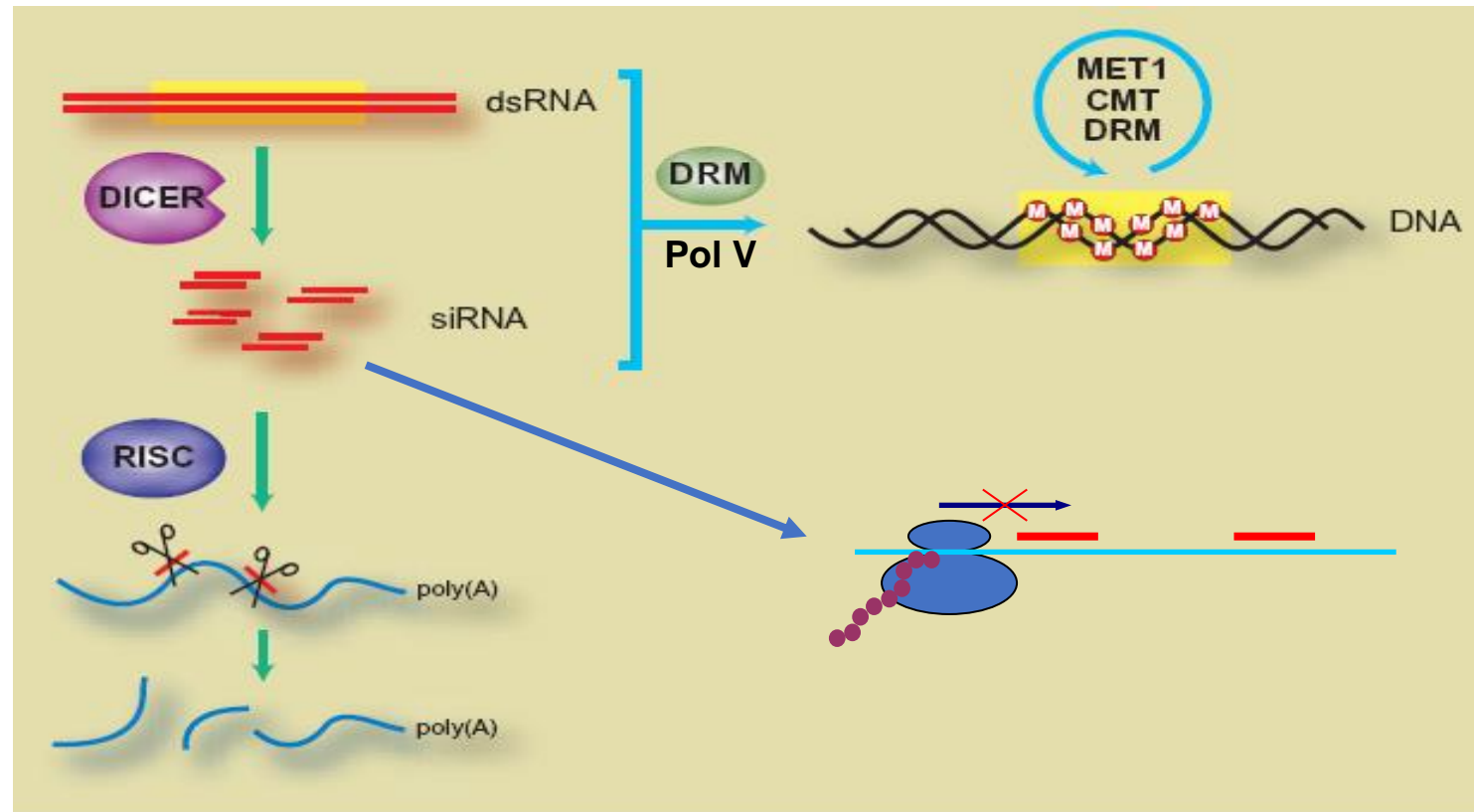

**PTGS (21-22 nt):** - specific cleavage of transcript  
- - block of translation

**TGS (24 nt):** - methylation of promoter, heterochromatin formation  
- preventing interaction of transcription factors

# sRNA mode of action also depends on complementarity

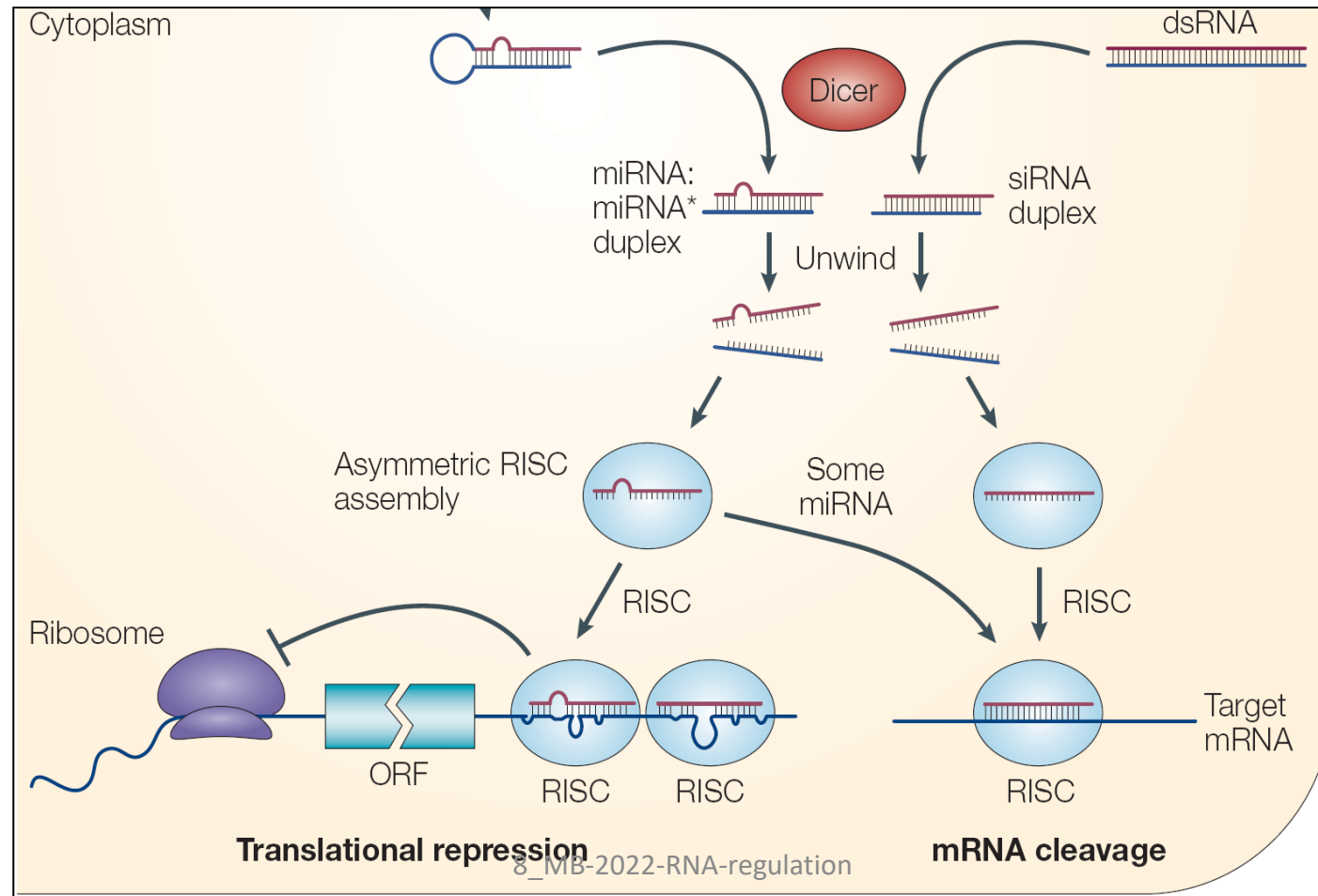

# dsRNA formation

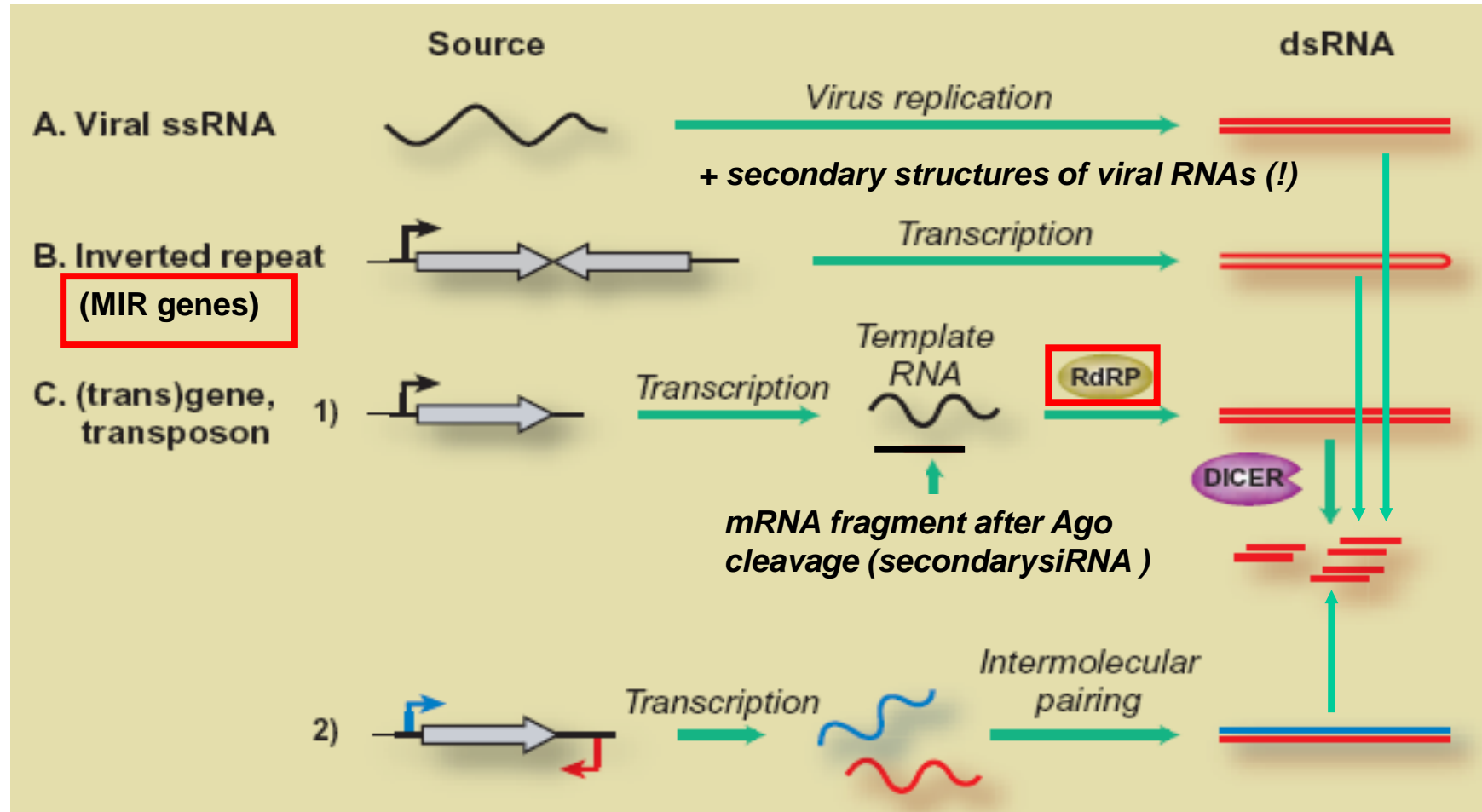

- RdRP = RNA-dependent RNA Polymerase – synthesis of compl. RNA strand templates:
  - transcripts cleaved by RISC
  - impaired mRNAs (without polyA or cap)
  - transcripts of RNA polymerase IV



# Overview of RNA interference

Overview of [RNA interference](#). The [dicer](#) enzymes produce [siRNA](#) from double-stranded RNA and mature [miRNA](#) from precursor miRNA. miRNA or siRNA is bound to an [argonaute enzyme](#) and an effector complex is formed, either a [RISC \(RNA-induced silencing complex\)](#) or [RITS \(RNA-induced transcriptional silencing\)](#) complex. RITS affects the rate of [transcription](#) by [histone](#) and [DNA methylation](#), whereas RISC degrades [mRNA](#) to prevent it from being [translated](#).

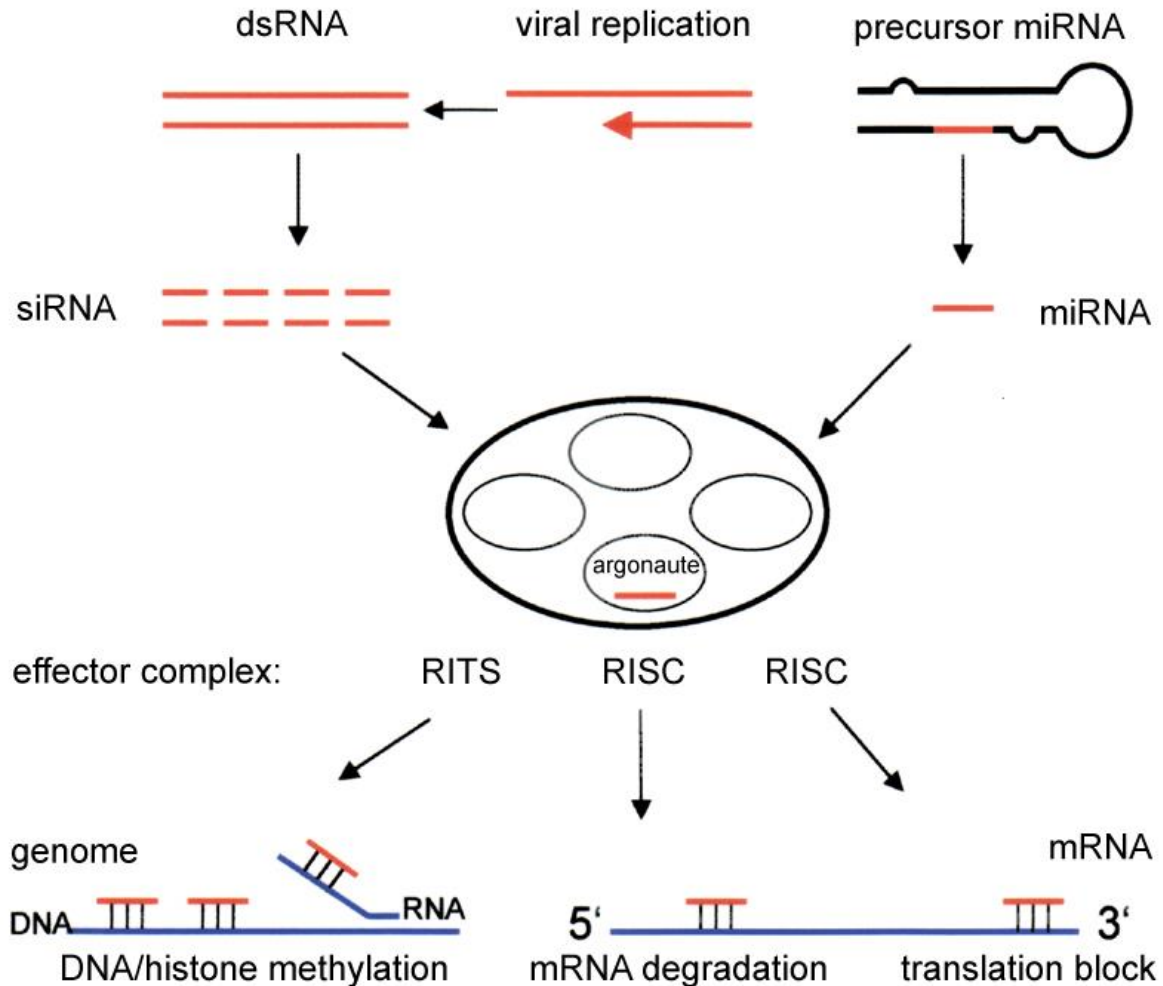

Matzke MA, Matzke AJM – This figure is adapted from one by Matzke MA, Matzke AJM (2004) Planting the Seeds of a New Paradigm. PLoS Biol 2(5): e133 [doi:10.1371/journal.pbio.0020133](https://doi.org/10.1371/journal.pbio.0020133).

# microRNA

small non-coding RNA of 18-25 nucleotides in size  
negative regulatory expression genes that  
degrade target mRNA or block its translation  
microRNAs arise from primary pri-miRNA  
transcripts that are relatively large (even several  
kb)

pri-miRNAs are treated in the nucleus with  
Drosha RNAase and protein

Pasha binding dsRNA to pre-miRNA about 70  
nucleotides long with imperfect hair structure  
pre-miRNAs are exported to the cytoplasm by  
Exportin 5 and digested with Dicer nuclease to  
final 22 kb miRNA duplexes

The miRNA binds to the RISC, one fiber degrades  
and the other mediates the degradation or  
translation inhibition of the respective mRNA

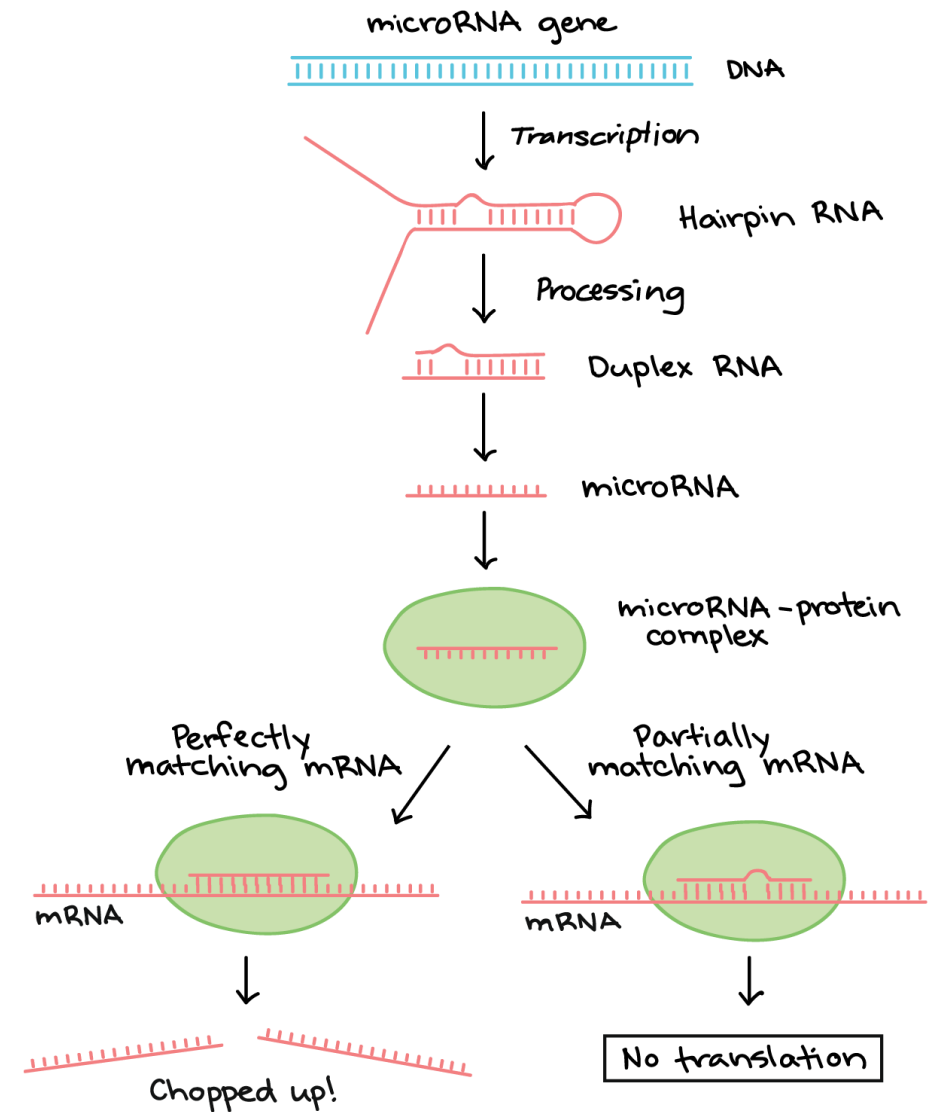

# RNA interference

based on enzyme degradation or translation inhibition of specific mRNA

Drosha (RNaseIII)  
Pasha (protein)  
Exportin 5 (transporter)  
Dicer (RNaseIII)  
RISC (multiprotein complex)

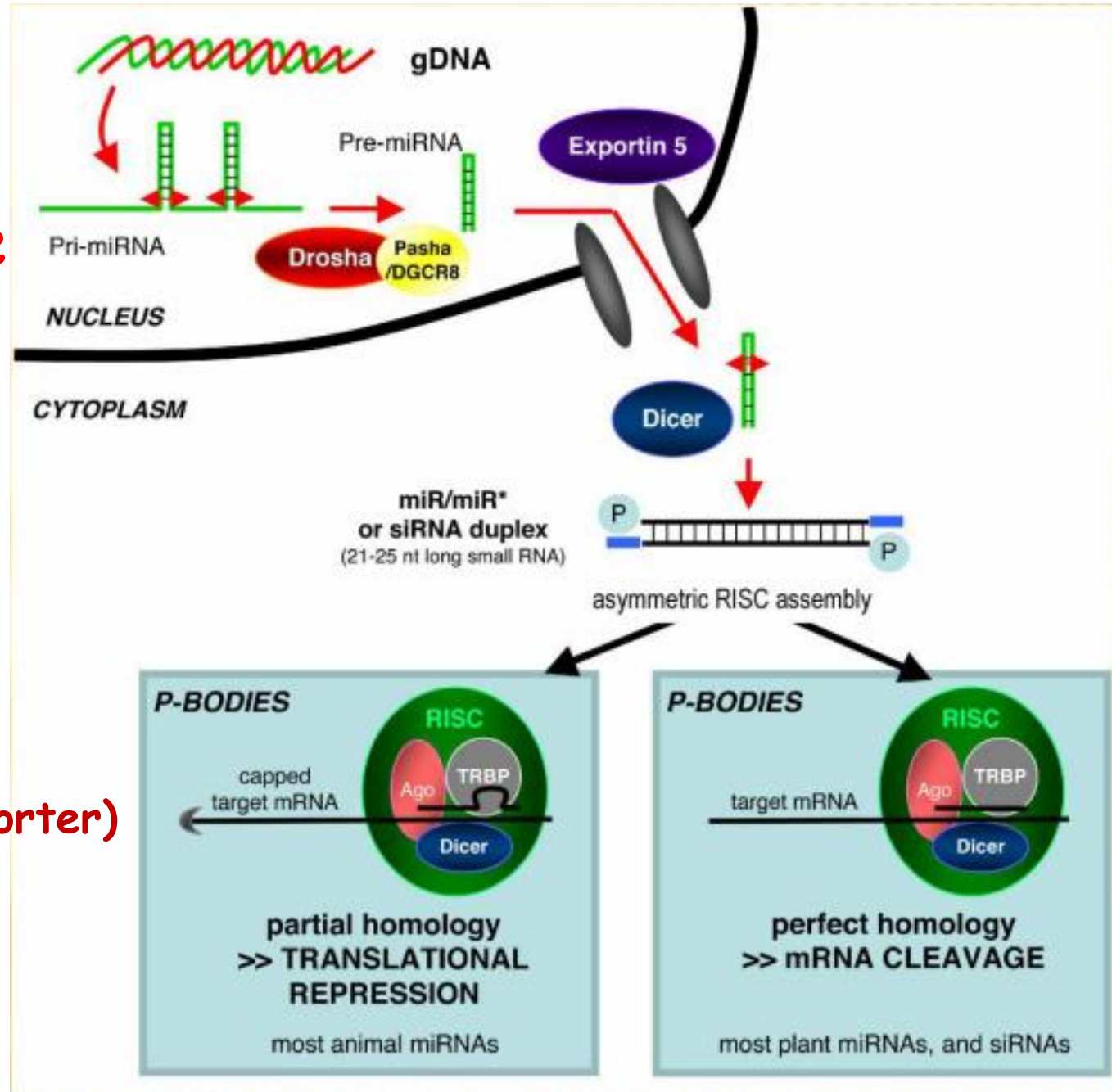

TEST



# siRNA and miRNA utilisation:

- 1) gene analysis
- 2) gene therapies
- 3) anti-viral vaccines
- 4) transgenic organisms that have transiently inhibited selected genes

- iRNA usage does not fall under *GMO*
- Yet usage of cassettes producing iRNA does!

# MicroRNAs as tumor suppressors or oncogenes

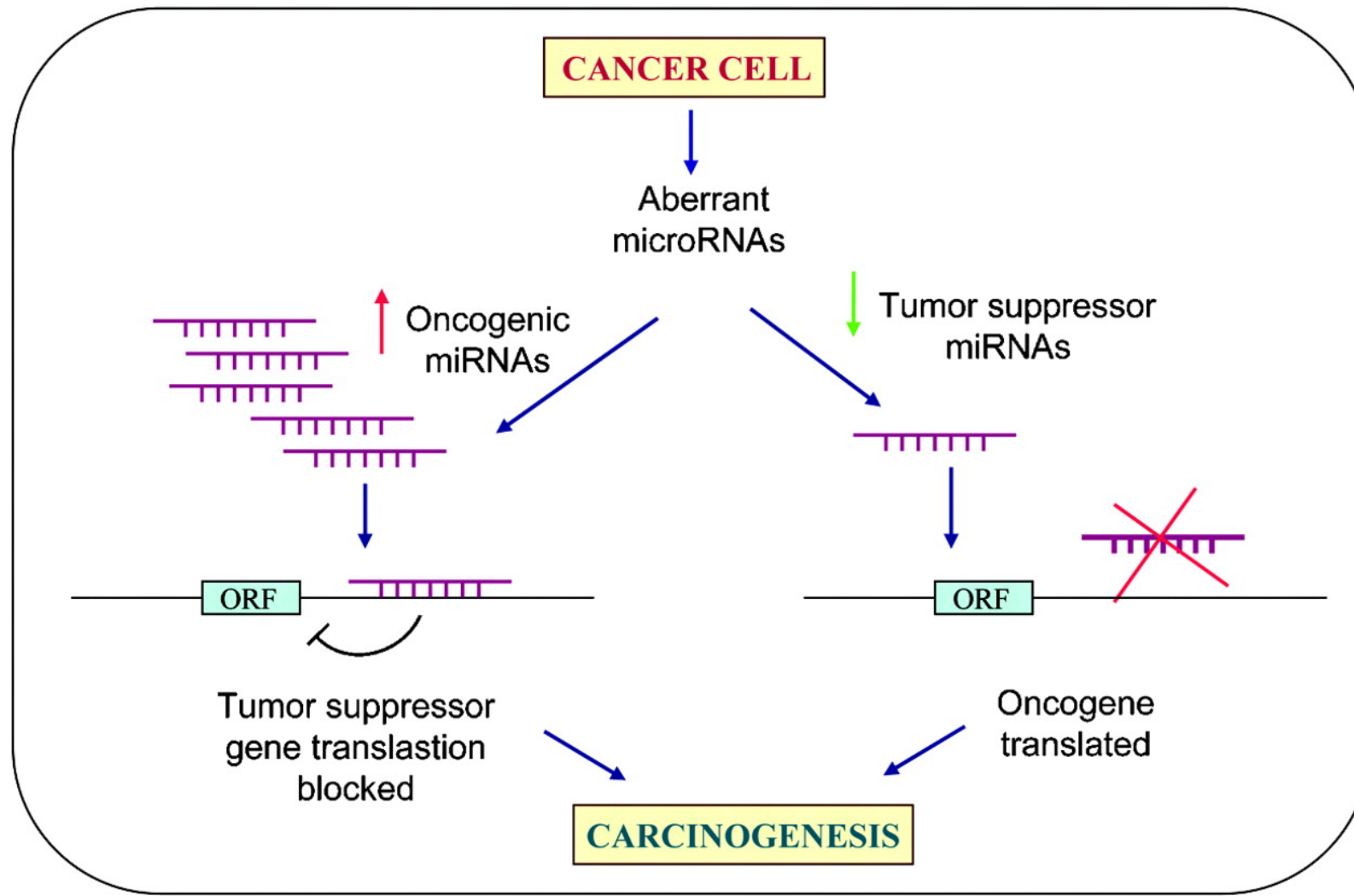

# CRISPR system

In 2008, it was described RNAi analogous system designed to the degradation of viral NA

- It uses internal "virus" sequences inserted in the inverted repeats (CRISPR)
- **CRISPR = clusters of regularly interspaced short palindromic repeats**
- After transcription of this sequence leads to their progressive cleavage by **Cas proteins**
- **The resulting products interfere with the nucleic acid of the entering virus**
- Each of repeats followed by short segments called **Spacer DNA**, obtained during previous meetings with relevant bacterial viruses or plasmids.

**Brouns et al. (2008): Small CRISPR RNAs Guide Antiviral Defense in Prokaryotes, Science 321, 960-964**

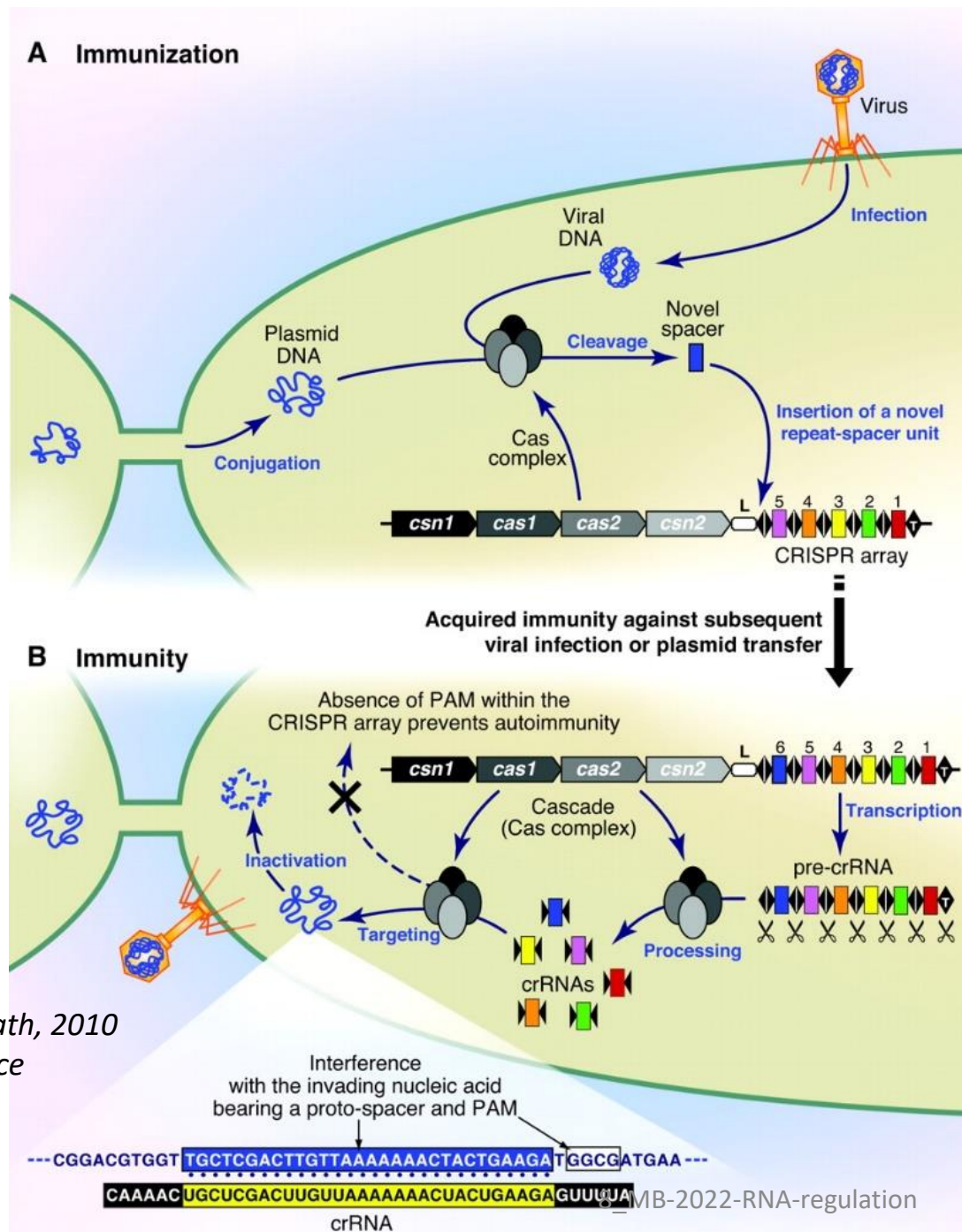

**Overview of the CRISPR/Cas mechanism of action. (A)** Immunization process: After insertion of exogenous DNA from viruses or plasmids, a Cas complex recognizes foreign DNA and integrates a novel repeat-spacer unit at the leader end of the CRISPR locus. **(B)** Immunity process: The CRISPR repeat-spacer array is transcribed into a pre-crRNA that is processed into mature crRNAs, which are subsequently used as a guide by a Cas complex to interfere with the corresponding invading nucleic acid. Repeats are represented as diamonds, spacers as rectangles, and the CRISPR leader is labeled L.

Horvath, 2010  
Science



# CRISPR/Cas9

- the whole system is modified for targeted mutagenesis
- - vector - gRNA = crRNA tracr + RNA
- 
- part gRNA and 20nt complementary section to the target site in the genomic DNA
- - + Coexpression of Cas9 nuclease (even the same vector)

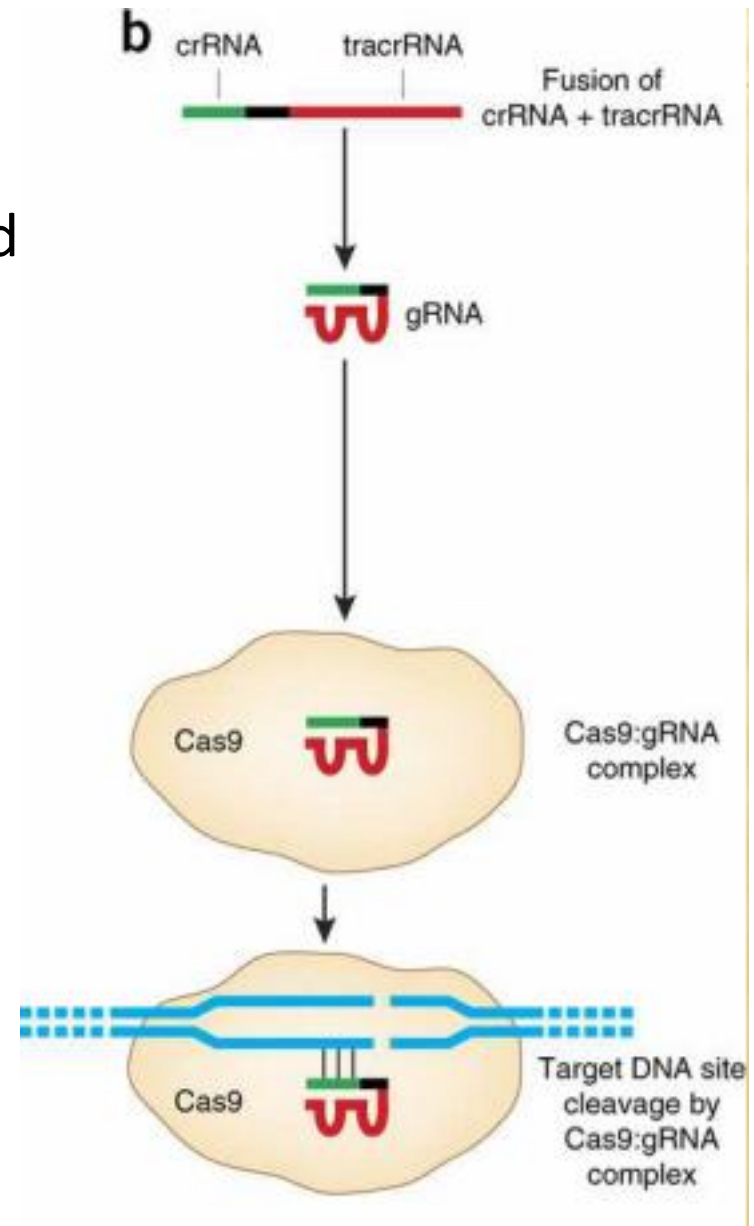
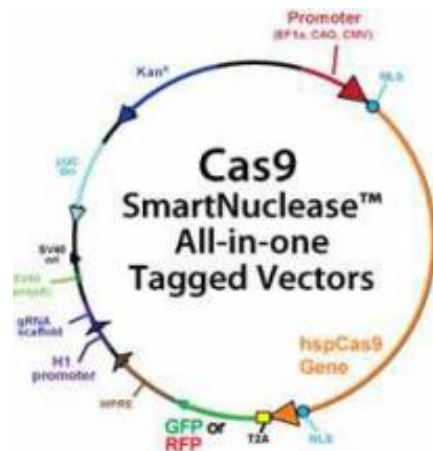

- PAM - protospacer adjacent motif
- sequence in the vicinity of gDNA
- required for efficient cleavage by Cas9 nuclease
- the original system "NGG" (but the development of systems with other sequences)
- according to the system target sequence must be in the N 20 -GG

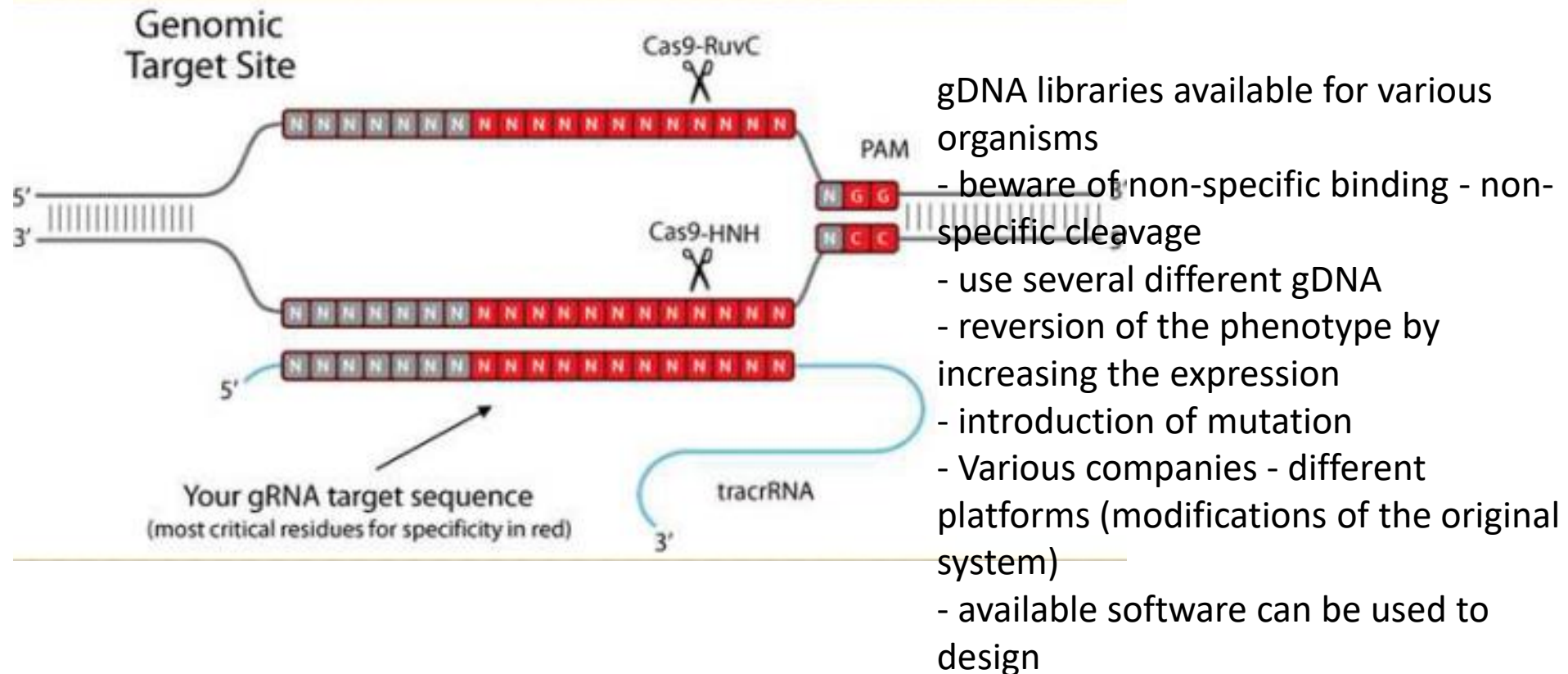

A. Genome Engineering With Cas9 Nuclease

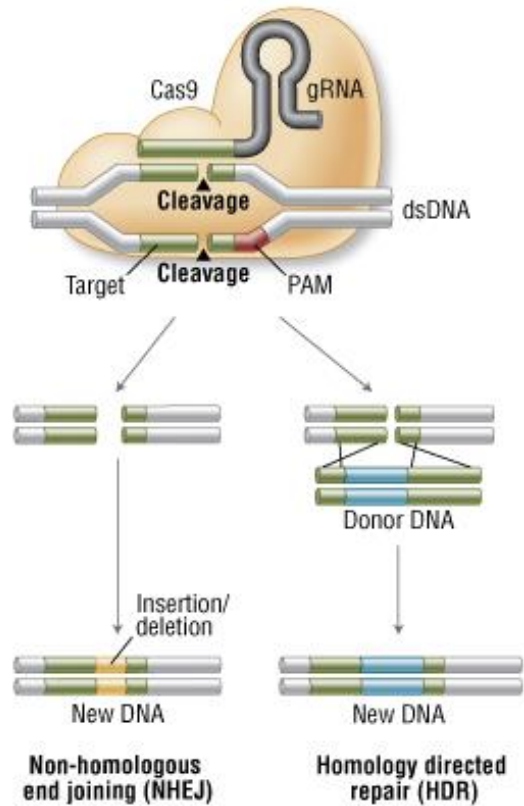

B. Genome Engineering By Double Nicking With Paired Cas9 Nickases

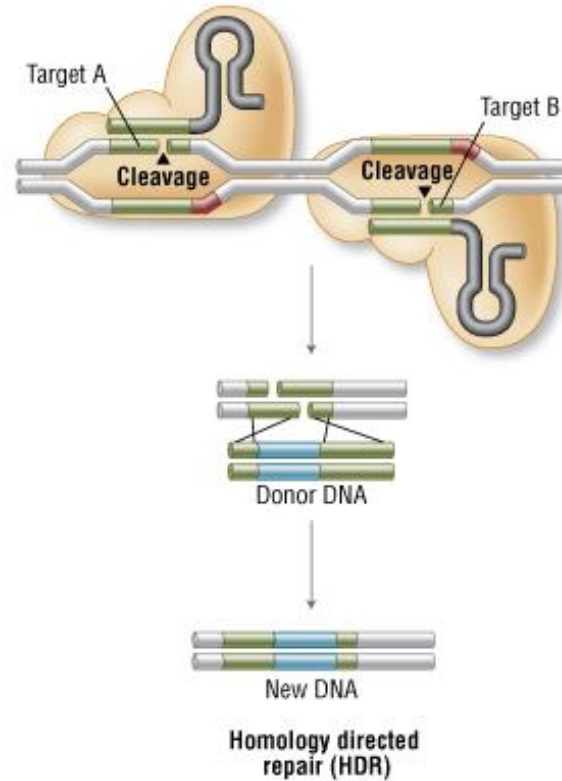

C. Localization With Defective Cas9 Nuclease

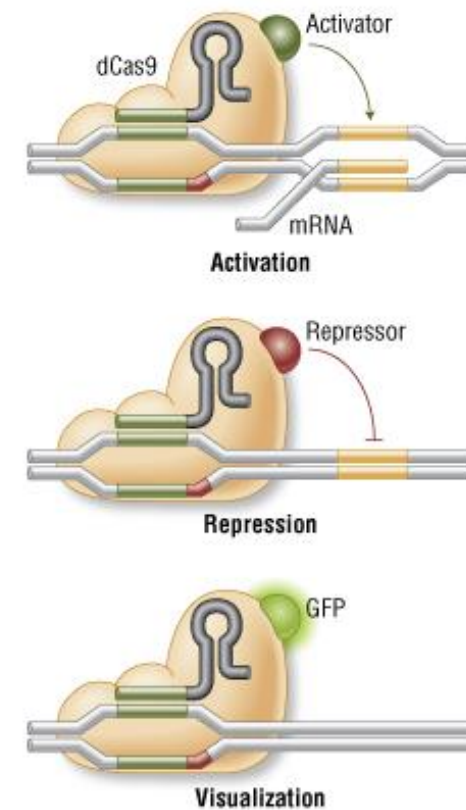

A. Wild-type Cas9 nuclease site specifically cleaves double-stranded DNA activating double-strand break repair machinery. In the absence of a homologous repair template non-homologous end joining can result in indels disrupting the target sequence. Alternatively, precise mutations and knock-ins can be made by providing a homologous repair template and exploiting the homology directed repair pathway.

B. Mutated Cas9 makes a site specific single-strand nick. Two sgRNA can be used to introduce a staggered double-stranded break which can then undergo homology directed repair.

C. Nuclease-deficient Cas9 can be fused with various effector domains allowing specific localization. For example, transcriptional activators, repressors, and fluorescent proteins.

# lncRNA - long non-coding RNA

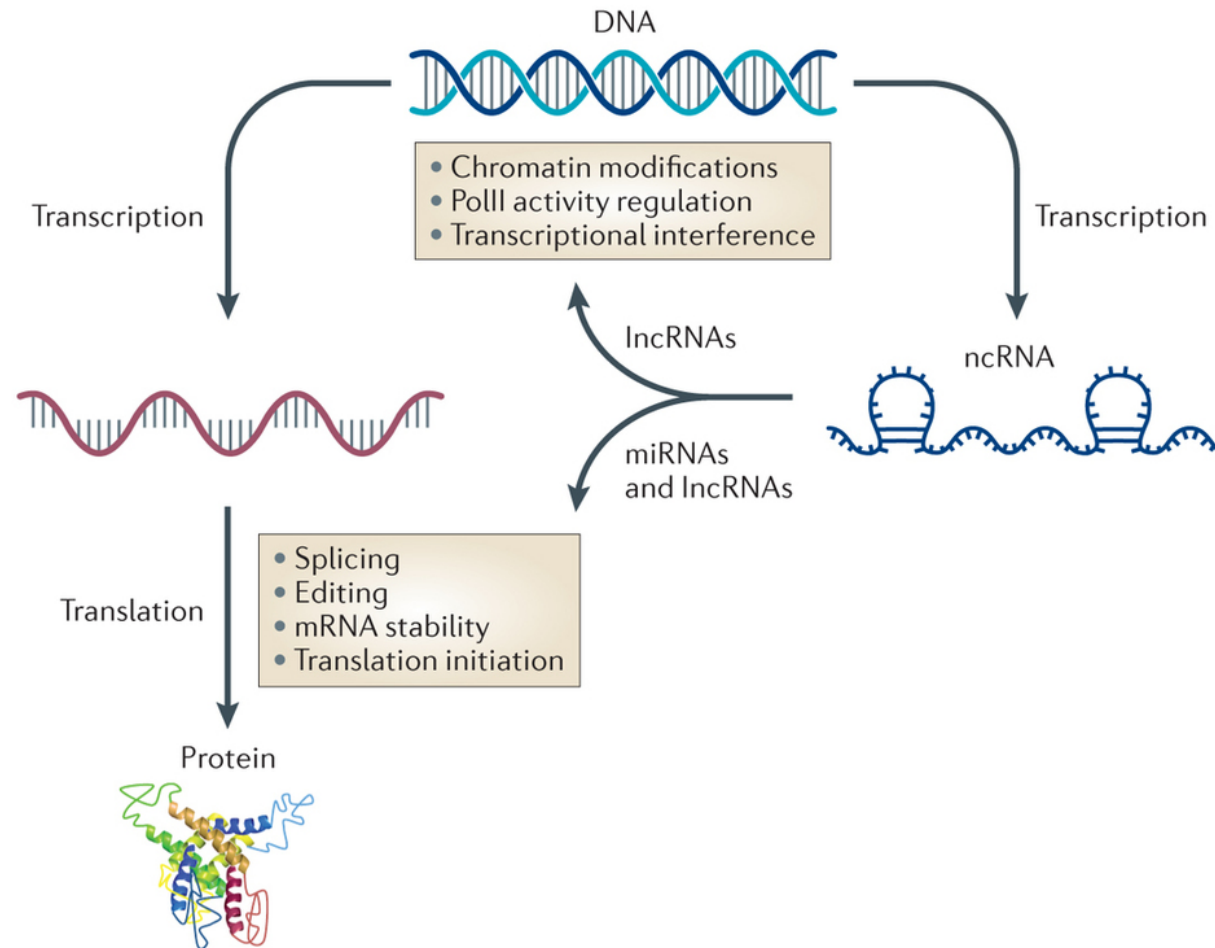

Long non-coding RNAs (long ncRNAs, lncRNA) are non-protein coding transcripts longer than 200 nucleotides.<sup>[1]</sup> This somewhat arbitrary limit distinguishes long ncRNAs from small regulatory RNAs such as microRNAs (miRNAs), short interfering RNAs (siRNAs), Piwi-interacting RNAs (piRNAs), small nucleolar RNAs (snoRNAs), and other short RNAs.<sup>[2]</sup>

# Long ncRNAs in the regulation of gene transcription

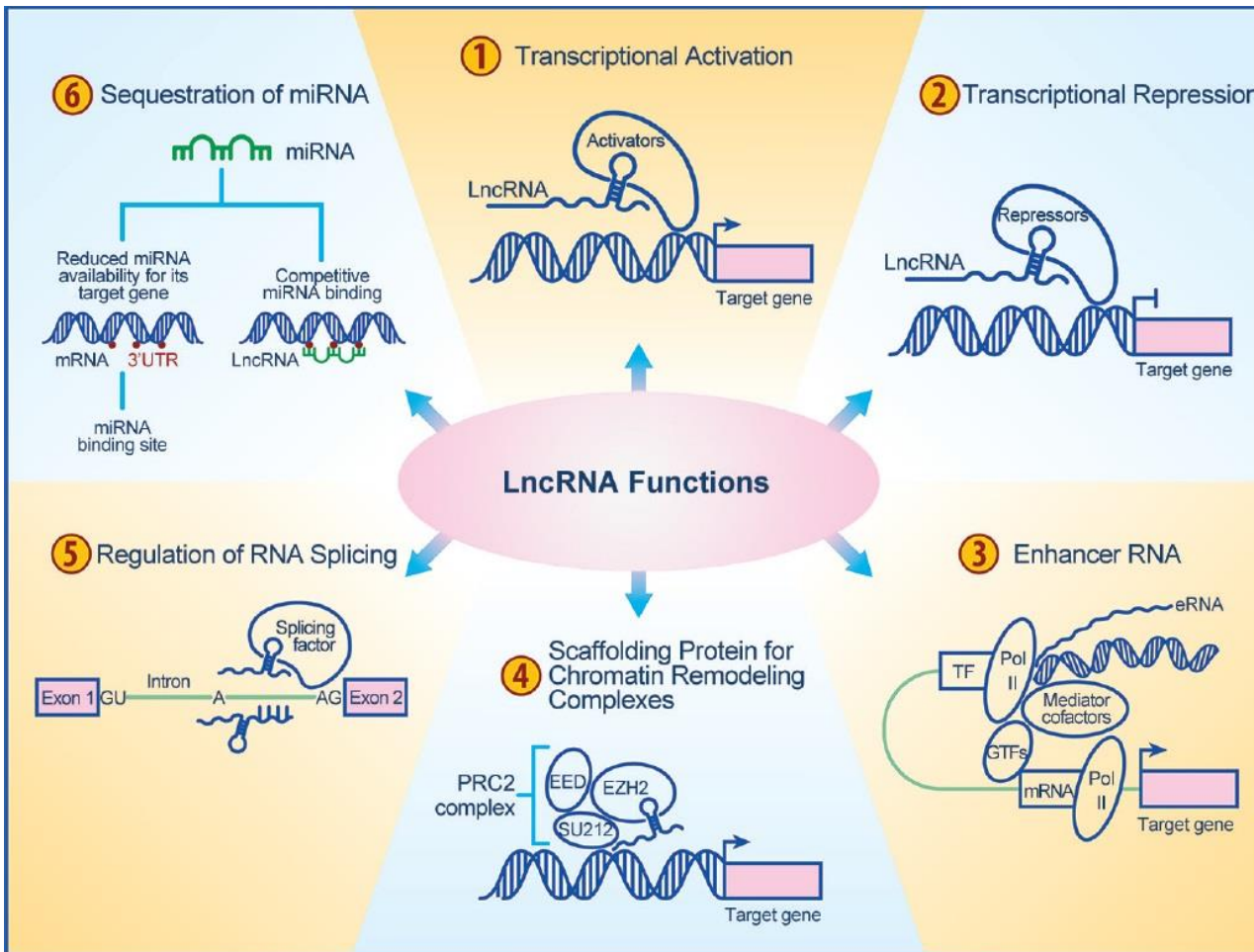

## Long ncRNAs in gene-specific transcription

In eukaryotes, RNA transcription is a tightly regulated process. NcRNAs can target different aspects of this process, targeting transcriptional activators or repressors, different components of the transcription reaction including [RNA polymerase \(RNAP\) II](#) and even the DNA duplex to regulate gene transcription and expression ([Goodrich 2006](#)). In combination these ncRNAs may comprise a regulatory network that, including transcription factors, finely control gene expression in complex eukaryotes.