

M U N I

Modern Extraction and Isolation Methods

**Faculty of Pharmacy MU
Department of Natural Drugs**

prof. PharmDr. Karel Šmejkal, Ph.D.

M U N I

Introduction to Extraction and Isolation

Why to extract?

- Content of active compounds in drug low
- Content of active compounds variable
- Presence of unwanted compounds
- Drug not acceptable because of bad organoleptic properties
- The amount for direct preparation of application form/administration too big
- Better possibility of dosage
- Better compliance of patient

Content compounds

- Main active compounds
- Supporting content compounds
- Ballast compounds

- The aim of extraction:
 - **Remove ballast substances, to maintain main and supporting content compounds, the obtain extract rich in target substance**

Traditional processing of medicinal plants, their parts and drugs

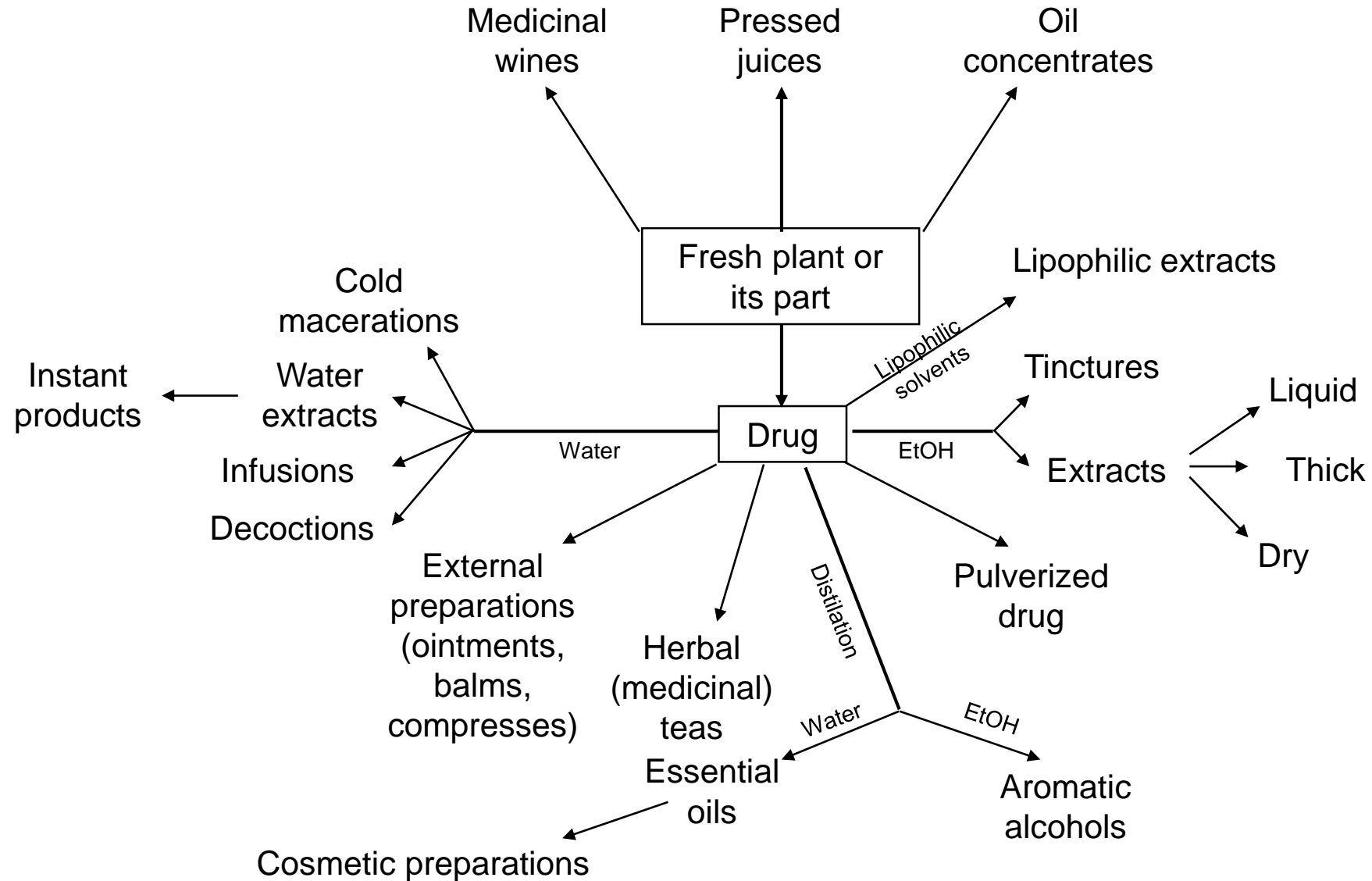

Methods of standardization

Analytical techniques for determination of markers and standardization

Determination of class of compounds

Total phenolics, total flavonoids, total alkaloids...

Amount of volatile substances (essential oil quantification)

Common utilization of color reactions

Fast, simple, cheap

Possible false-positive results, possible falsification

Requirements for marker:

- 1) Bioactivity
- 2) Sufficient content
- 3) Physico-chemical stability

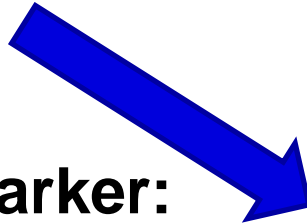

Combination of analytical technique and biological activity

Single compounds as markers

- HPLC-DAD, HPLC-MS, GC-MS
- Quantification of one or more compounds
- Precise, more expensive, low chance of falsifying

Extraction - Fick diffusion law

$$\Delta n / \Delta t = - (DA/h) \times (c_0 - c)$$

- $\Delta n / \Delta t$ – velocity of diffusion
- **D** – diffusion coefficient based on temperature and diameter of diffusing particles
- **A** – diffusion space (surface)
- **h** – diffusion layer
- **($c_0 - c$)** – concentration gradient

Improved effectiveness of extraction

- **Maceration** (one batch method – periodic)
 - Decantation, centrifugation, filtration

Matrix effects

Desintegration of material
Meating
Stirring
Repetition of process
Solvent selection
Sonication

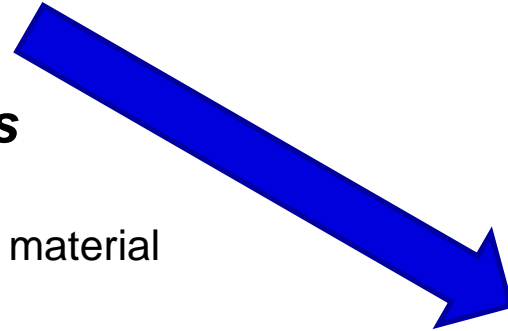

Extraction - Fick diffusion law

$$\Delta n / \Delta t = - (DA/h) \times (c_0 - c)$$

- $\Delta n / \Delta t$ – velocity of diffusion
- **D** – diffusion coefficient based on temperature and diameter of diffusing particles
- **A** – diffusion space (surface)
- **h** – diffusion layer
- $(c_0 - c)$ – concentration gradient

Improved methods (semicontinual)

- Percolation
- Digestion
- Variations on Soxhlet extractor

Solid-liquid extraction techniques

– Conventional extraction techniques

- maceration, percolation, squeezing, counter-current extraction, extraction through Soxhlet, distillation, etc.
- high quantities of expensive and pure solvents, a low selectivity of extraction; a high solvent evaporation rate during the process; long extraction times, thermal decomposition of thermolabile compounds

– Unconventional (innovative) extraction techniques

- ultrasound-assisted extraction (UAE), supercritical fluid extraction (SFE), microwave-assisted extraction (MAE), extraction with accelerated solvent, solid phase microextraction, enzyme-assisted extraction, and rapid solid-liquid extraction dynamic (RSLDE) via the Naviglio extractor

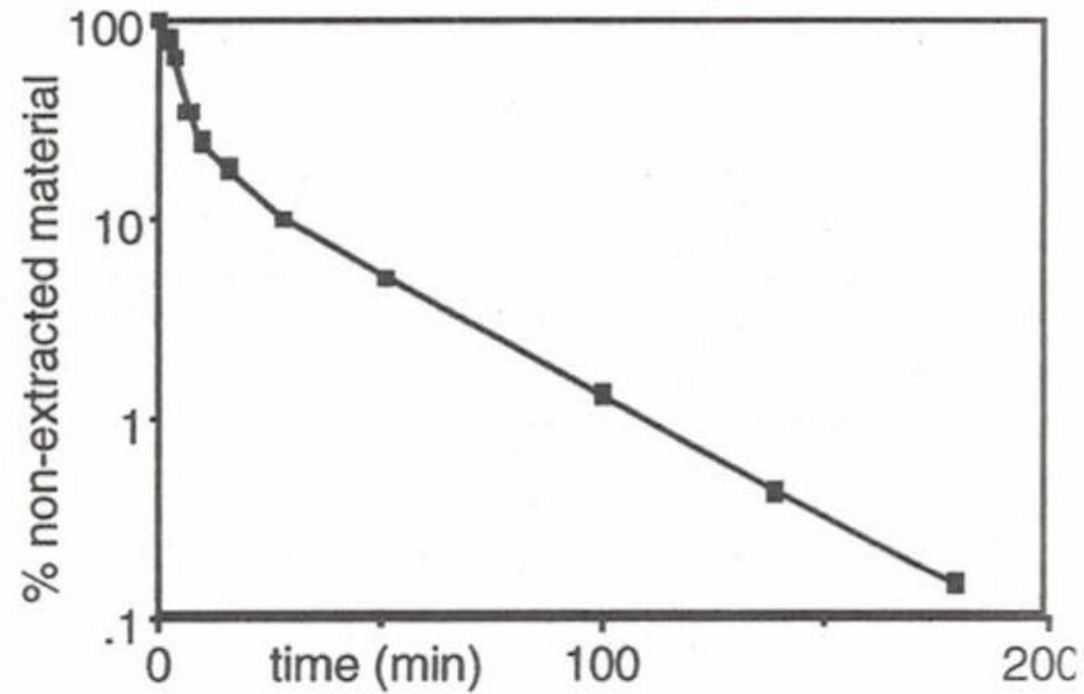
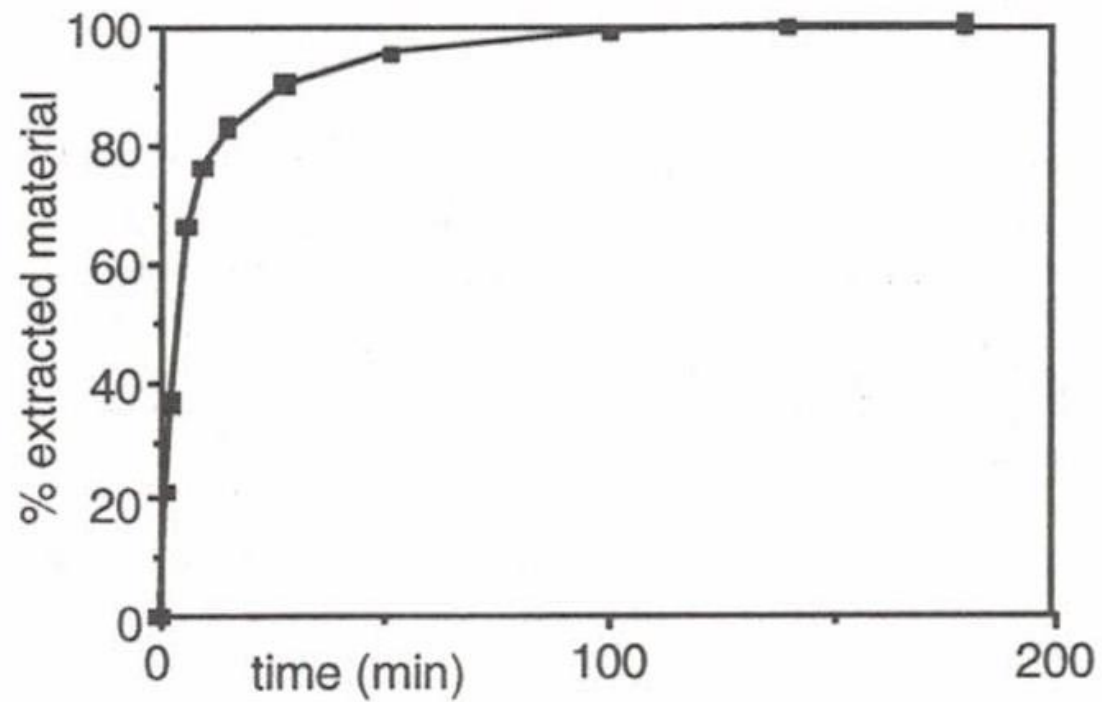

Water steam distillation

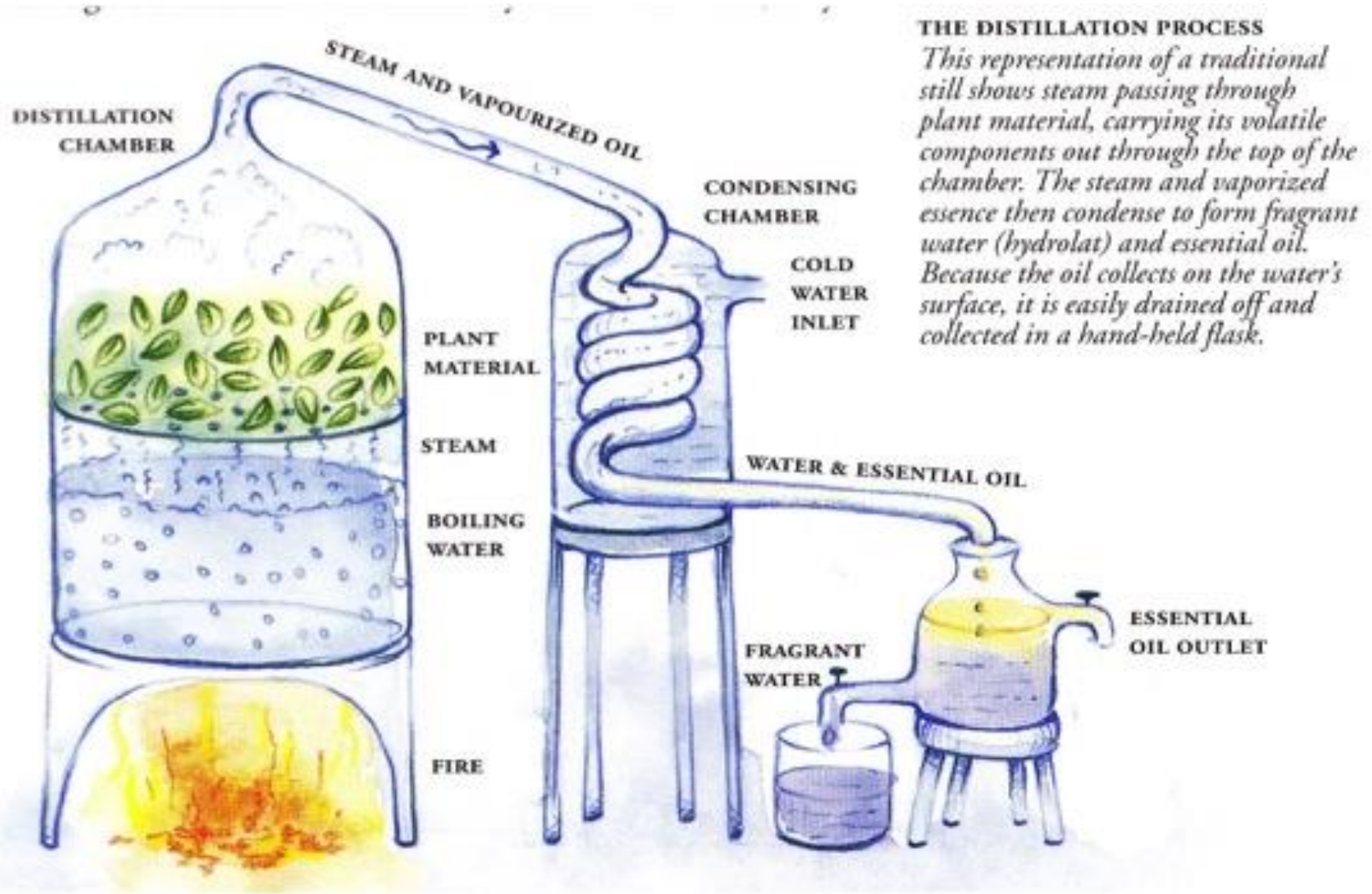

Dalton's law

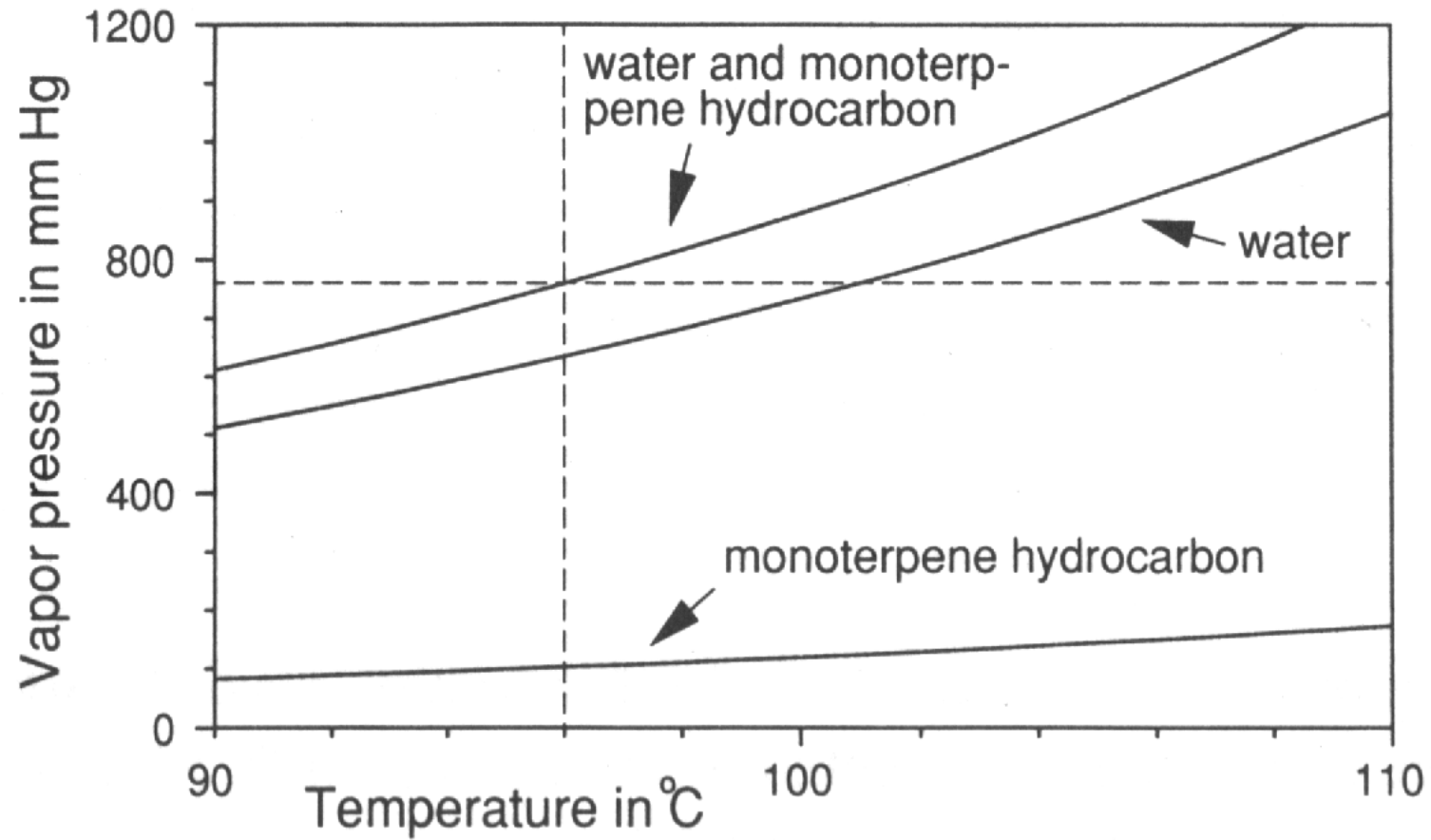

Steam distillation

Suitable for water-insoluble substances, only volatile compounds

Selective
Simple
Cheap

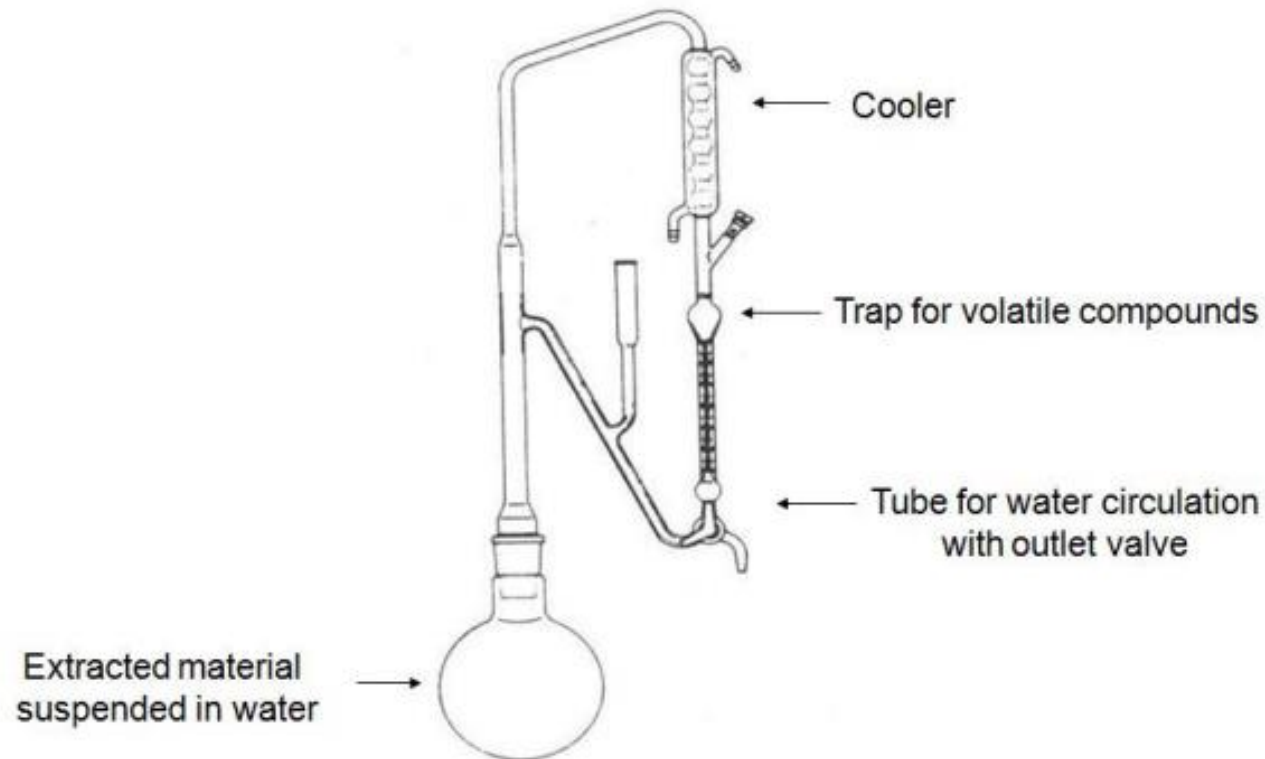

Products of steam distillation

- Essential oils
 - Eucalyptus, tea-tree oil, camphora
- Hydrolates
 - Rose water
 - Orange blossom water
- Aromatic spirits

Table 1: Table of analytes suitable for steam-distillation extraction.

Analyte	Matrix	Quantification Method	Related Norms
Protein (nitrogen), TKN, TVBN	Food, beverages, pharmaceuticals, feed, waste water	Potentiometric / Colorimetric Titration	AOAC 2001.11 AOAC 920.87 ISO 937 ISO 3188
Ammonium, nitrite, nitrate (Devarda), urea	Fertilizer, soil, cosmetics, hair dye	Potentiometric / Colorimetric Titration	AOAC 892.01 AOAC 955.04 83/514/EEC
Alcohol	Wine, beer, spirits	Densitometer	EC 2870/2000
Volatile acids	Wine, juice	Potentiometric Titration	OIV-MA-AS313-02
Sulfite, Sulfur dioxide	Wine, beer, dried fruits, seafood	Potentiometric Titration	AOAC 962.16
Cyanide, Amygdalin	Food, feed, waste water	Complexometric Titration	ISO 2164-1975, AOAC 915.03
VDKs	Beer	UV-Vis Spectrometry	
Phenol	Soil, waste water	UV-Vis Spectrometry	ISO 6439:1990 DIN 38409-H16-3
Formaldehyde	Textiles, maple sirup	UV-Vis Spectrometry	ISO 14184-1 AOAC 964.21
Limonene (essential oils)	Juice, fragrances, hops	Redox Titration	

Equipment



lavender



The Front



The Side

Supercritical fluid extraction

- **Extraction with utilization of supercritical fluids**
- **Supercritical fluid**

Pressure and temperature over critical values

Physical properties form a transition between the properties of gases and liquids

Density close to liquids → good dissolving ability

Diffusion constant close to gases → rapid mass transfer

Viscosity lower than liquid → advantage of better flow properties

Low surface tension → easy material penetration

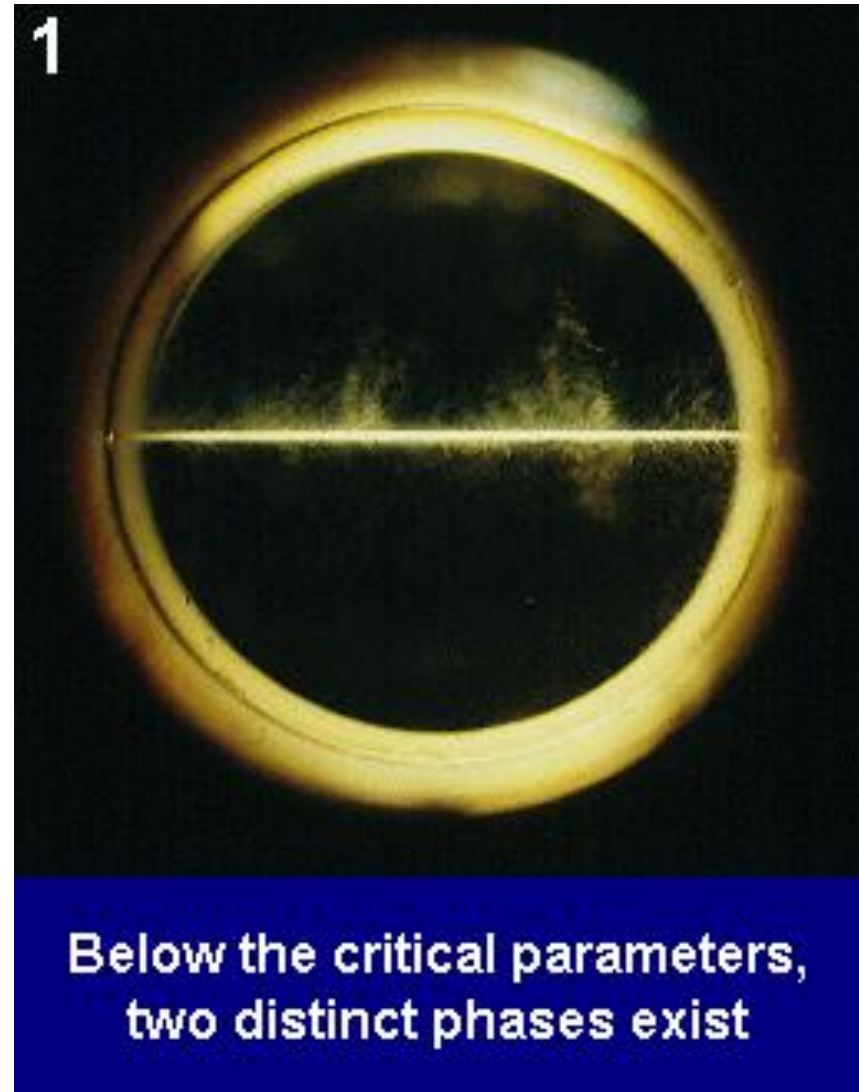
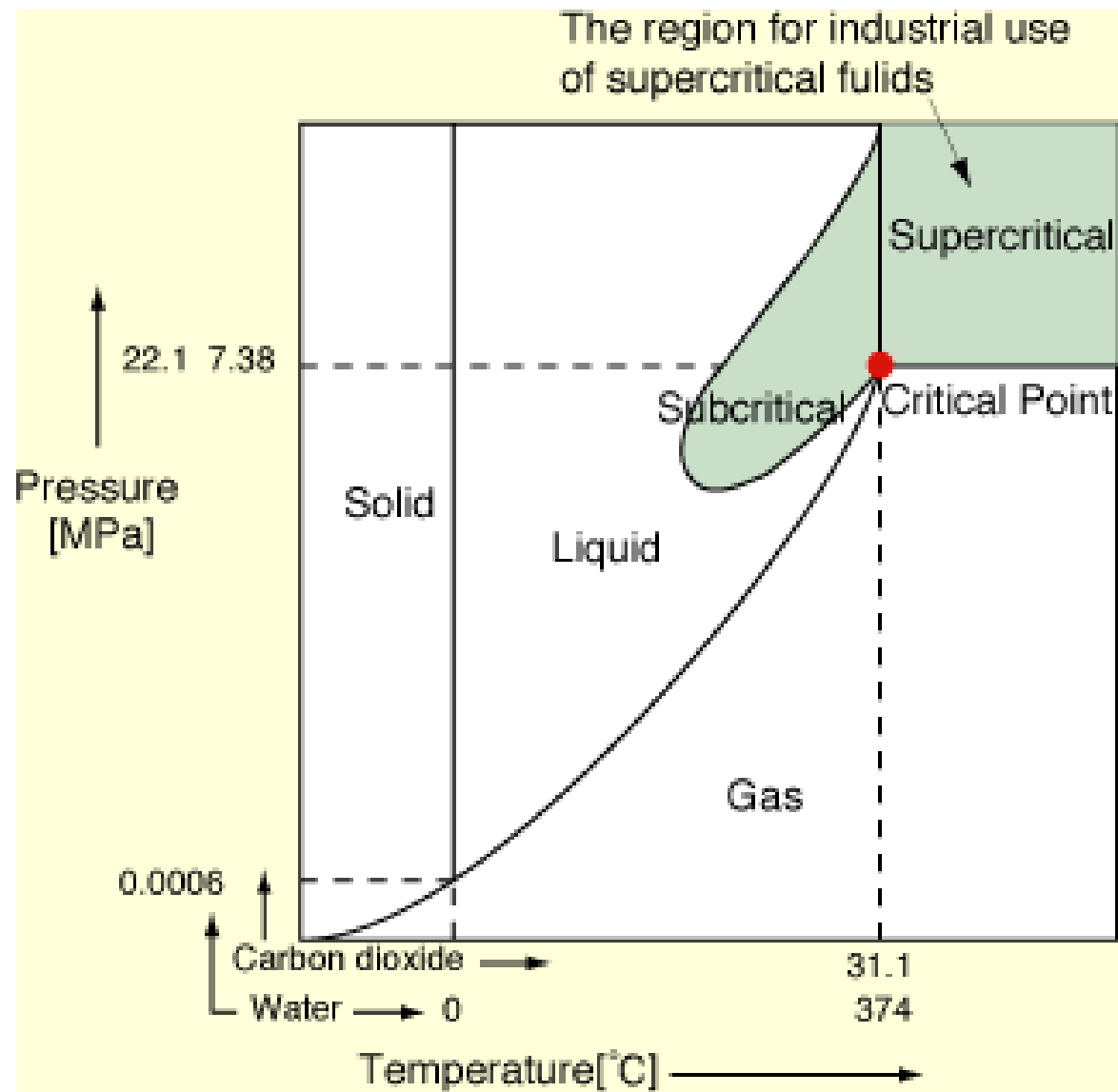

Supercritical fluid extraction

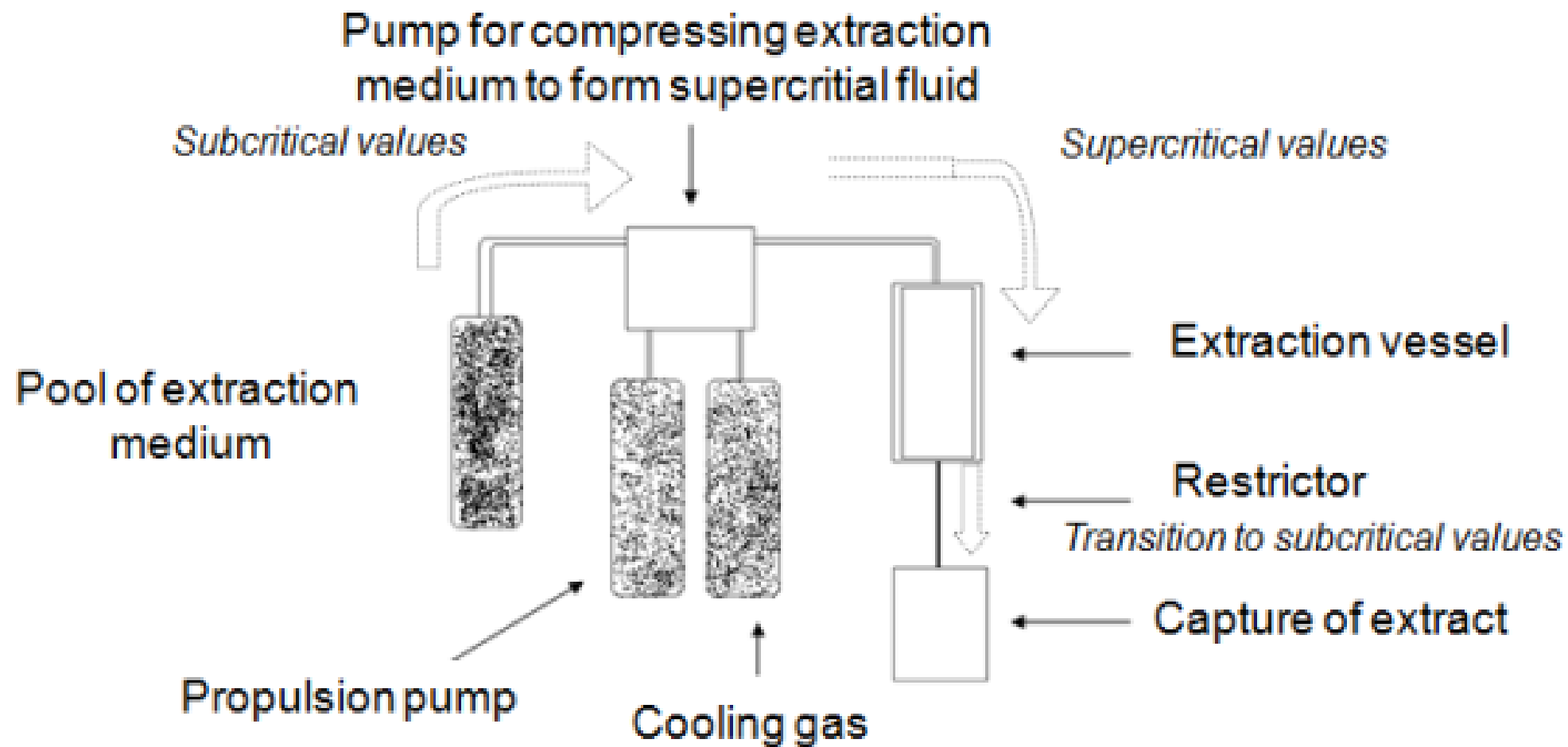

Advantages of SFE:

Gentle technique.

Ideally, no organic solvents are needed.

Ecologically harmless.

Cheap.

Fast.

Possibility of automation.

Changes of solvation strength by changes of pressure.

CO₂ – non-flammable, non-explosive, easily available, cheap, environmentally friendly, advantageous supercritical region (T=31.1 °C; P=7.28 MPa), suitable for the extraction of low polar substances (essential oils, oils, waxes, carotenoids)

– Utilization:

Hop extraction. Decaffeination of coffee. Extraction of taxol from *Taxus brevifolia*. Extraction of essential oils and spices. Non-pharmaceutical purposes

Disadvantages of SFE:

Less suitable for polar compounds.

More demanding instrumentation.

Requires the use of high pressures.

Less suitable for leaf extraction.

Extraction tuning issues.

Difficult extraction of fresh material (water content).

SFE



Accelerated solvent extraction (ASE)

- Increased extraction yields and reduced time
- An increased diffusion
- Liquids operating above their boiling temperature while being maintained in a liquid state by the increase in pressure
- A cylindrical steel container, the extracting solvent is introduced
- The temperature of the system is raised above the boiling point of the solvent, which is maintained in the liquid state thanks to a simultaneous increase in pressure (the vial is sealed to resist high pressure values: 100–200 bar)
- Not suitable for thermally labile substances

Accelerated solvent extraction (ASE)

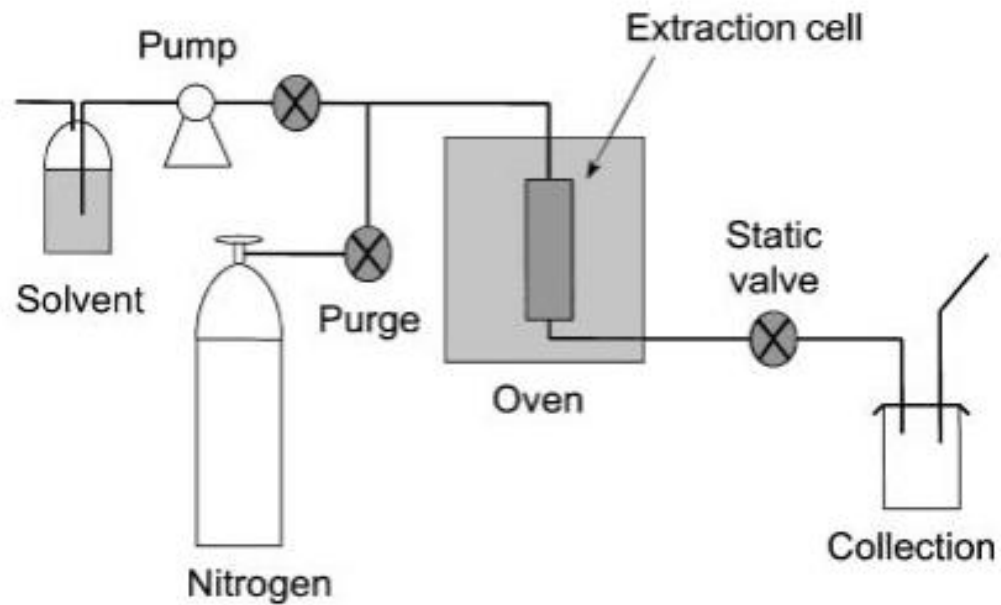
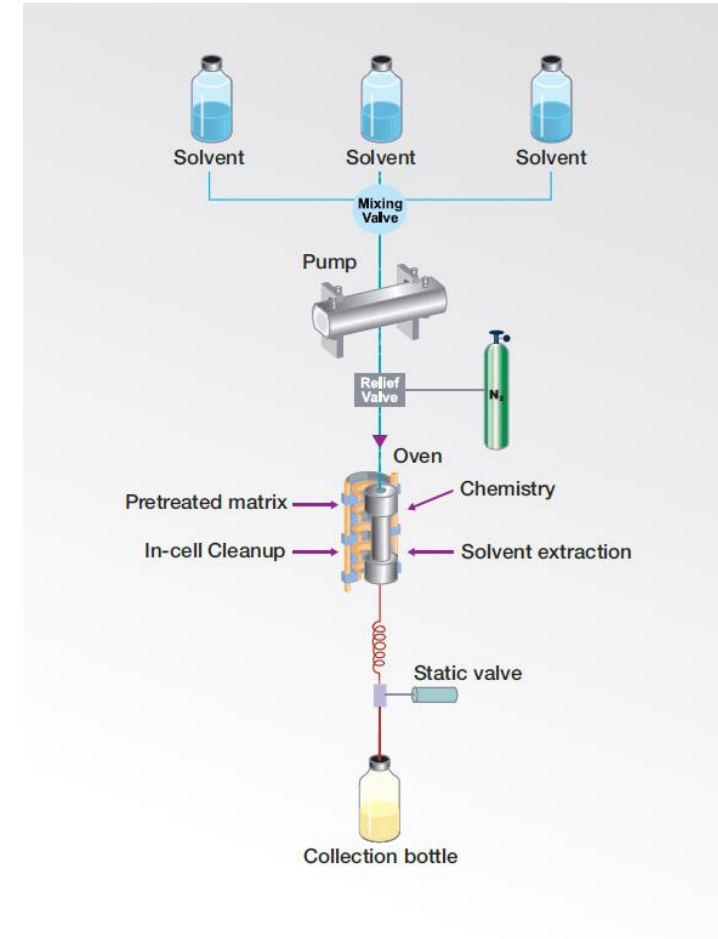

Figure 5. Scheme of an accelerated solvent extraction (ASE) system (from Richter *et al.*, 1996).



<https://www.thermofisher.com/cz/en/home/industrial/chromatography/chromatography-sample-preparation/automated-sample-preparation/accelerated-solvent-extraction-ase.html>

<https://www.thermofisher.com/order/catalog/product/083114>

Ultrasound assisted extraction

- An innovative technique, used in different settings
- “Clean technology”
- Use of low solvent volumes
- Short Ets
- Few instrumental requirements
- Low economic and environmental impact
- Technique employs ultrasonic waves frequencies between 20 kHz and 10 MHz
 - power ultrasound (20–100 kHz), characterized by a high intensity, used for extraction and processing applications
 - signal or diagnostic ultrasound (100 kHz–10 MHz), employed as a clinical diagnostic technique, and for control and quality assessment
- Acoustic cavitation (AC)

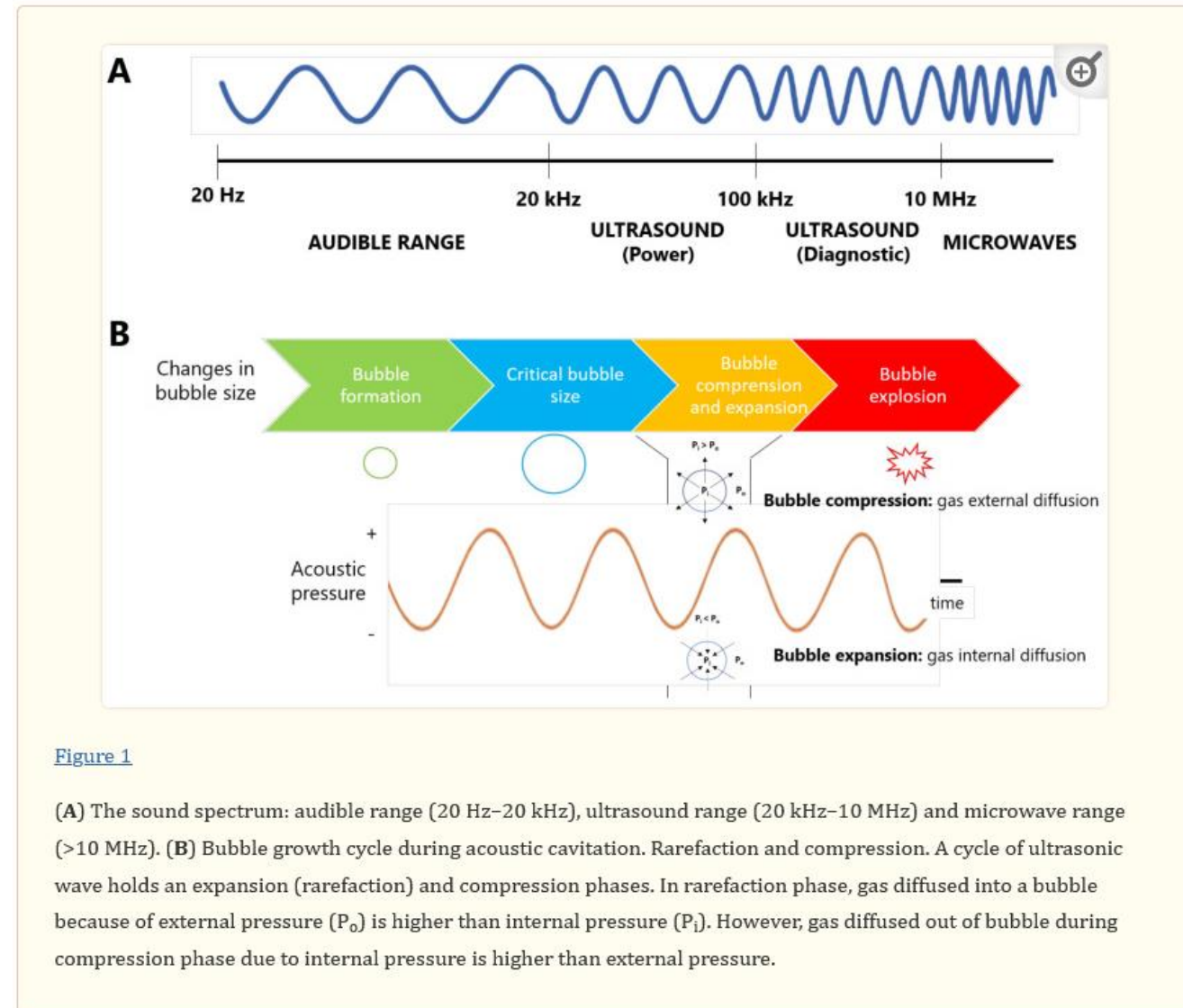

Ultrasound assisted extraction (UAE)

– UAE-Associated Mechanisms

- Fragmentation → the reduction of matrix particle size guided by the ultrasonic action → increases the solid surface area to develop mass transfer, driving to better extraction yields
- Erosion → the release of solid structures from the matrix into the extractive solvent, caused by the collapse of cavitation bubbles
- Sonocapillary → an enhanced penetration of solvent into the canals and pores of the matrix
- Detexturation → the solid matrix destruction
- Sonoporation → an increase in cell membranes permeability, forming of membrane pores
- Local shear stress → generation of shear forces onto the matrix surface, causing the later rupture of its structures and the extraction of inner compounds in the solvent

– Relevant Parameters Associated with UAE

- Physical parameters - power, frequency, and ultrasound intensity, related with the ultrasound equipment – ET, shape and size of ultrasonic reactors
- Medium parameters - the solvent nature and its properties (polarity,, viscosity, surface tension, solvent vapor pressure), extraction time, the presence of gases, new green solvents for lipophilic extraction → ionic liquids and deep eutectic solvents
- Matrix parameters
 - type of matrix, structure, pre-treatment, particle size, or solid-liquid ratio

Ultrasound assisted extraction

Advantages

- Similar results as extraction by pressing (squeezing)
- High speed
- Economic advantage
- Relatively low-cost technology involved

Disadvantages

- The system heats up due to the prolonged treatment
- The solid matrix is completely crushed → difficult to separate the mass from extract
- The use of ultrasound energy of more than 20 kHz may influence the active phytochemicals through the formation of free radicals.

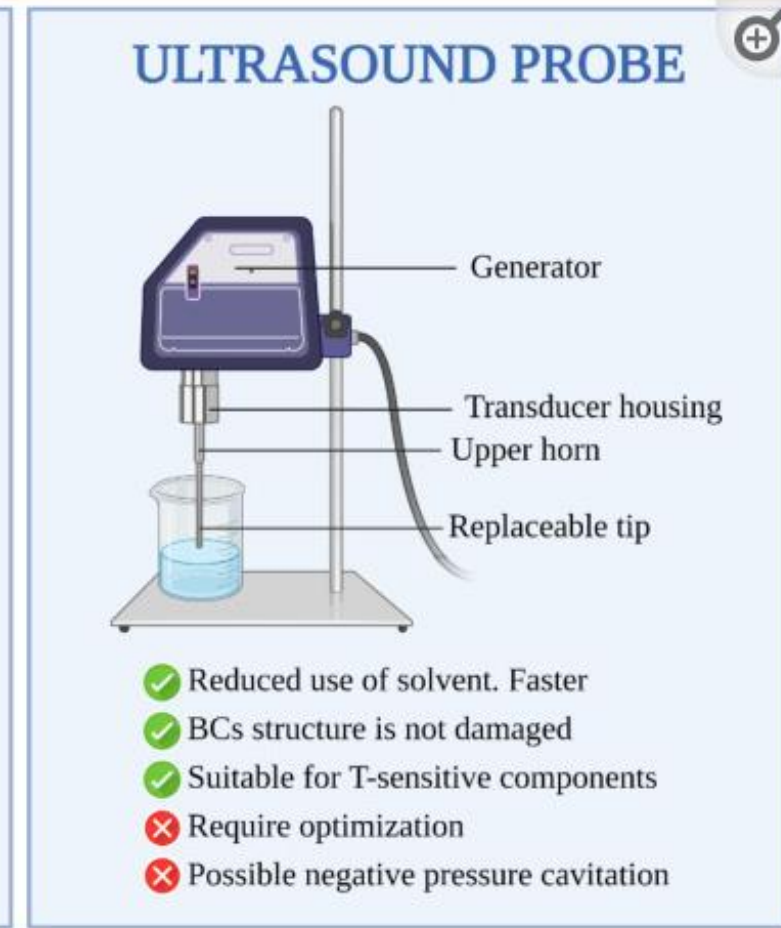
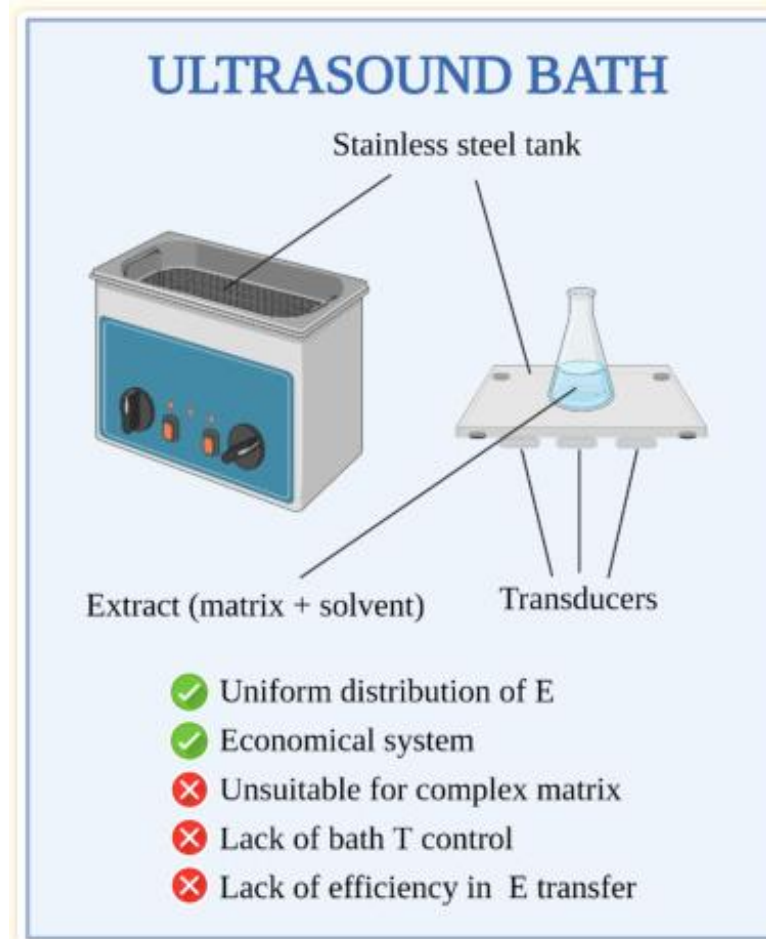

Microwave assisted extraction

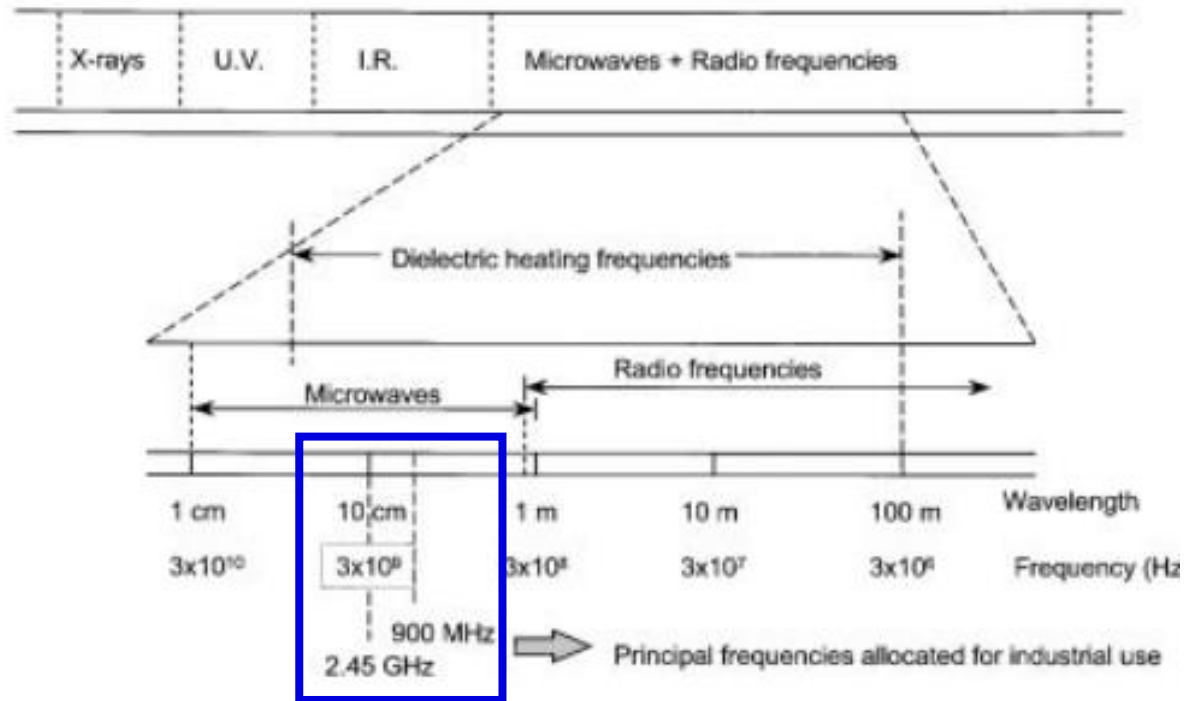

Figure 1. The electromagnetic spectrum.

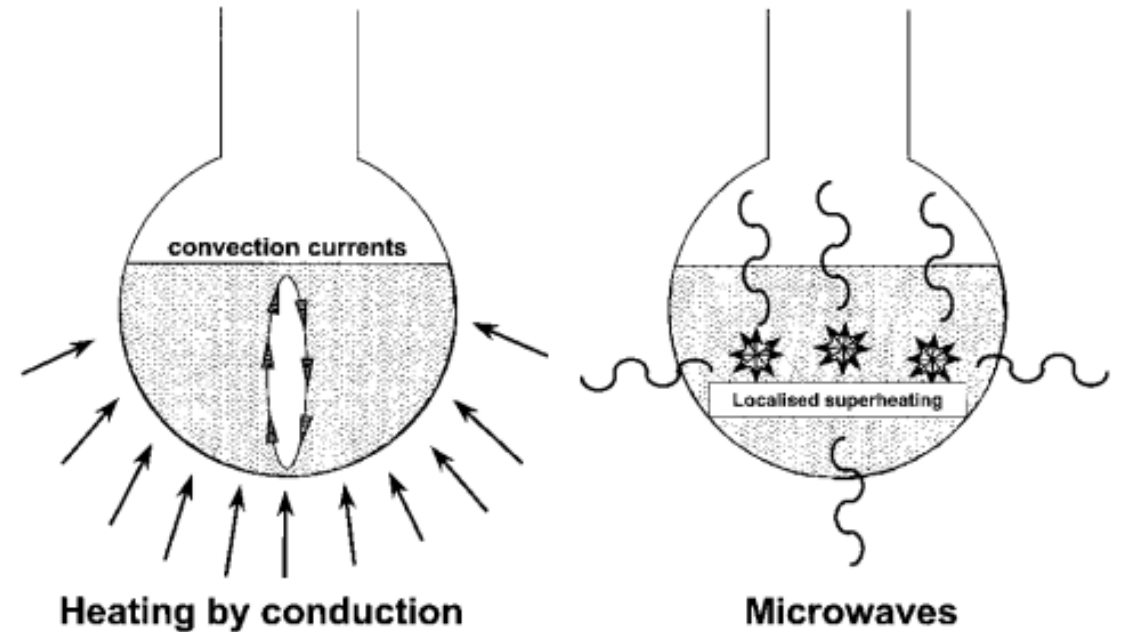

Figure 2. Scheme of the heating principle by conduction in the classical method of extraction and by microwave irradiation in microwave-assisted extraction.

Microwave assisted extraction

- Microwaves at 2.45 GHz
- Electric field causes heating

- Dipolar rotation

Molecules with dipole moment (permanent or induced), both in solvent and solid

Oscillation caused collisions and interactions with surrounding molecules → deliberation of thermal energy

Larger dielectric constant of solvent – greater heating

- Ionic conduction

Ion currents formation – resistance induces heat

- Extraction

- Disruption of weak hydrogen bonding

- Viscosity decreases effect

- Migration of ions increases solvent penetration into matrix

- In some cases, the matrix itself interacts with microwaves while the surrounding solvent possesses a low dielectric constant and thus remains cold

Advantageous in the case of thermosensitive compounds - the extraction of essential oils, microwaves interact selectively with the polar molecules present in glands, trichomes or vascular tissues. Localised heating leads to the expansion and rupture of cell walls and is followed by the liberation of essential oils into the solvent

Table 1. Dielectric constants and dipole moment values of some commonly used solvents

Solvent	Dielectric constant (20°C)	Dipole moment (25°C) (Debye)
Hexane	1.89	<0.1
Toluene	2.4	0.36
Dichloromethane	8.9	1.14
Acetone	20.7	2.69
Ethanol	24.3	1.69
Methanol	32.6	2.87
Water	78.5	1.87

Microwave assisted extraction

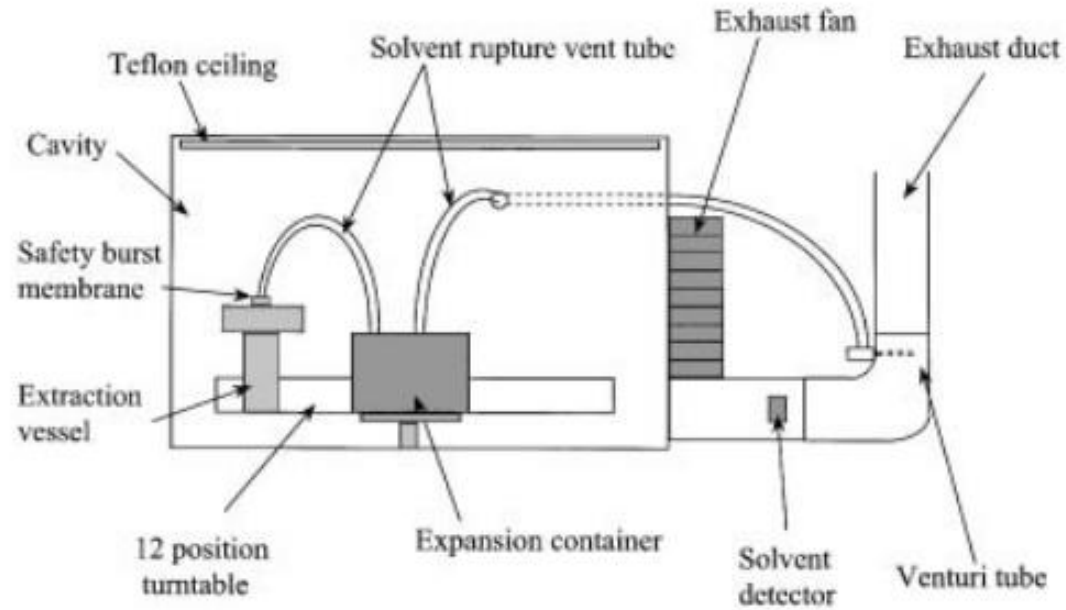

Figure 3. Schematic diagram of a closed-vessel microwave system for extraction.

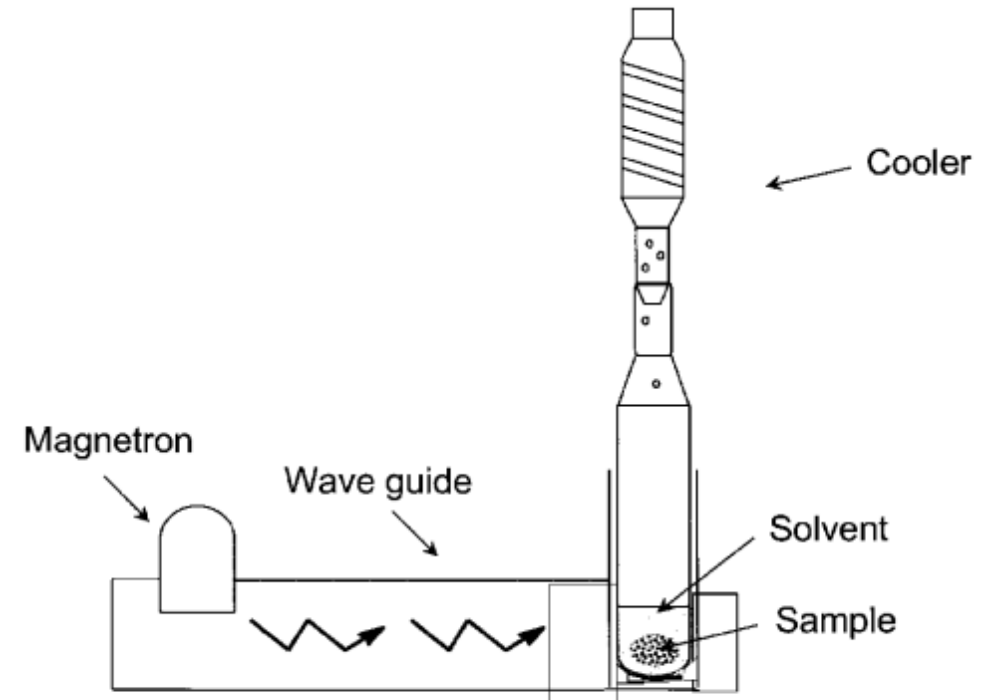

Figure 4. Schematic diagram of an open focused-microwave system for extraction.

– Closed and open wessels

Microwave assisted extraction

– Combination of MAE with different methods

- Maceration
- Percolation
- Distillation

Table 2. Application of MAE to natural product extraction

Compounds	Matrix	System	Extraction conditions	Reference
Vicine, convicine (pyrimidine glycosides)	Faba beans (<i>Vicia faba</i>)	Domestic oven	Methanol:water (1:1); two successive irradiations (30 s) with an intermediate cooling step	Ganzler <i>et al.</i> (1986a, 1986b); Ganzler and Salgò (1987)
Gossypol	Cotton seeds	Domestic oven	Three cycles of irradiation (30 s) with cooling steps in between	Ganzler <i>et al.</i> (1986a); Ganzler and Salgò (1987)
Sparteine (alkaloid)	Lupine seeds	Domestic oven	Four cycles (30 s) with cooling steps in between	Ganzler <i>et al.</i> (1986b, 1990)
Terpenes (linalool, terpineol, citronellol, nerol and geraniol)	Must (<i>Vitis vinifera</i>)	Closed vessels	10 mL dichloromethane; 475 W; 10 min; 90°C	Carro <i>et al.</i> (1997)
Essential oils	<i>Monarda fistulosa</i> , <i>Allium</i> sp.	Modified domestic oven	Hexane	Paré (1990)
Volatile oils	<i>Mentha piperita</i> , <i>Thuja occidentalis</i>	Modified domestic oven	Hexane, alkanes (transparent solvents)	Paré (1994)
Essential oils	Rosemary and peppermint leaves	Domestic oven	Hexane, carbon tetrachloride, toluene; 750 W; <60 s	Chen and Spiro (1994)
Essential oils	Plant leaves	Domestic oven	Hexane; <60 s	Collin <i>et al.</i> (1991)
Essential oils	Fresh leaves of <i>Lippia sidoides</i>	Domestic oven	"High cooking level"; 5 min	Craveiro <i>et al.</i> (1989)
Carotenoids	Paprika powder	Closed vessels	50 W; 120 s; <60°C	Csiktunadi Kiss <i>et al.</i> (2000)
Taxanes (paclitaxel)	Needles of <i>Taxus</i> sp.	Closed vessels	5 g fresh needles pre-soaked with 5 mL water prior to extraction with 10 mL of 95% ethanol; 100% power; 54 s; 85°C	Incorvia Mattina <i>et al.</i> (1997)
Ergosterol	Fungal contaminations	Domestic oven	375 W; 35 s	Young (1995)
Withanolides	<i>lochroma gesnerioides</i> leaves	Open cell, focused	100 mg material pre-soaked with 0.6 mL water prior to extraction with 5 mL methanol; 25 W; 40 s	Kaufmann <i>et al.</i> (2001a)
Cocaine and benzoylecgonine	<i>Erythroxylum coca</i> leaves	Open cell, focused	Methanol; 125 W; 30 s	Brachet <i>et al.</i> (2002)
Alkaloids	<i>Senecio</i> sp.	Closed vessels	65–100°C	Bicchi <i>et al.</i> (1992)

Rapid Solid-Liquid Dynamic Extraction (RSLDE)

- a negative gradient of pressure between the inner material and the outside of the solid matrix (high pressure inside and low pressure outside; Naviglio's principle).
- When the gradient of pressure is removed, the liquid flows out of the solid in a very fast manner and carries out all substances not chemically bonded to the main structure of the solid.

an "active" process → the gradient of pressure forces out the molecules

techniques based on diffusion and osmosis
→ "passive" processes, molecules are not forced out of the matrix

An extractive cycle consists of both static and dynamic phases. During the static phase, the liquid is maintained under pressure at about 10 bar on the solid to be extracted and is left long enough to let the liquid penetrate inside the solid and to balance the pressure between the inside and the outside of the solid (about 1–3 min). After this, at the beginning of the dynamic phase, the pressure immediately drops to atmospheric pressure, causing a rapid flowing of liquid from the inside to the outlet of the solid matrix. At this moment, there is a suction effect of the liquid from the inside towards the outside of the solid. This rapid displacement of the extracting solvent transports the extractable material (compounds not chemically linked) outwards. The cycles can be repeated until the solid runs out. Experimental tests carried out to date on more than 200 vegetables have shown that, working at a pressure of about 10 bar, most solid matrices, regardless of the degree of crumbling, can be extracted using about 30 extractive cycles (two-minute static phase; two-minute dynamic phase) that are completed in two hours. Furthermore, the reproducibility of the extraction on the same matrix in terms of yield was proven, and experiments were carried out to compare this method with other extraction techniques, which showed that RSLDE had a higher recovery and a higher quality of extract, and in no case was the alteration of thermolabile substances induced

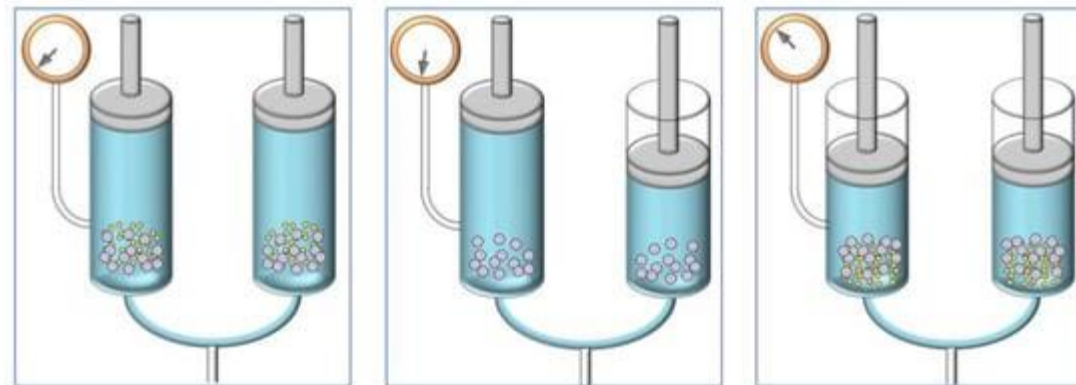
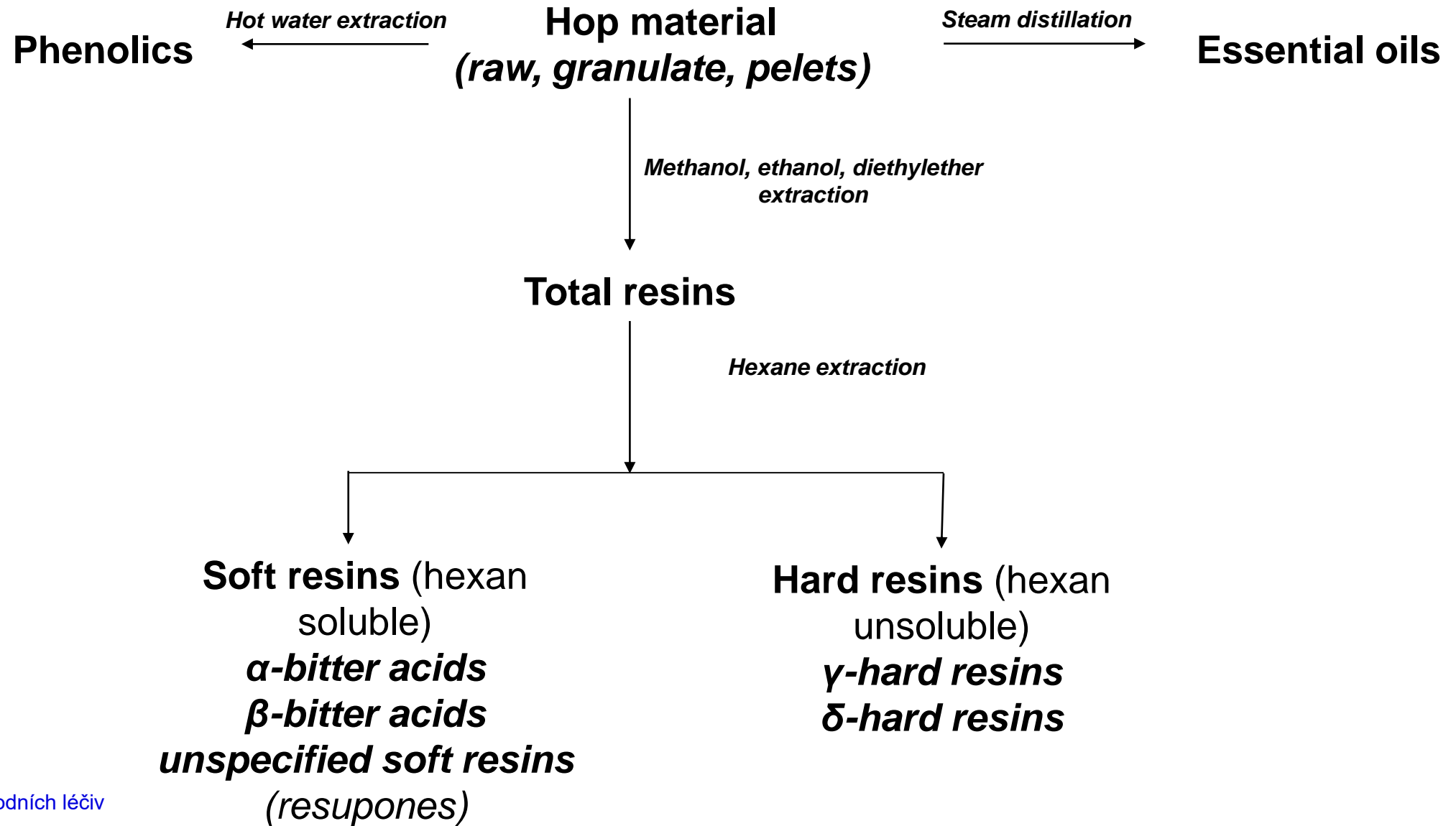

Figure 1. Schematic representation of the Naviglio extractor consisting of two extraction chambers connected via a conduit: the first two images show the dynamic phase, while the third image the static phase.

Comparison of different extraction techniques

Extraction Technique	Solvent	Granulometry	Time	Yield	Quality Extracted	Extract Stability
Squeezing	Indifferent	Not important	Minimum	Exhaustive	Poor	Poor
Maceration	Fundamental	Important	Long	Exhaustive	Great	Great
Decotion	Fundamental	Important	Long	Exhaustive	Great	Great
Percolation	Fundamental	Important	Middle	Partial	Good	Good
Soxhlet	Fundamental	Important	Long	Exhaustive	Poor	Poor
SCD	Indifferent	Not important	Middle	Partial	Poor	Poor
MAE	Fundamental	Not important	Middle	Partial	Poor	Poor
UAE	Fundamental	Not important	Middle	Partial	Great	Great
SFE	Indifferent	Not Important	Middle	Exhaustive	Poor	Poor
ASE	Fundamental	Not important	Minimum	Exhaustive	Poor	Poor
RSLDE	Indifferent	Not important	Minimum	Exhaustive	Great	Great

Hop processing



Hop products and extracts

Products

- Mechanical products – compressed hop, granulates

Extracts

- Ethanol (MW assisted, Rapid Solid-Liquid Dynamic Extraction (RSLDE) – Naviglio's principles)
 - Extract containing besides α -acids, β -acids and hop essential oils also phenolics and tannins
 - 90% ethanol, possible fractionation to get hop tannins (water soluble)
- CO₂
 - Supercritical or subcritical – effectivity/yield/conditions
 - pure hop resin extract containing α -acids, β -acids and hop essential oils.
- Steam distillation (MW assisted)
 - pure extract hop essential oils
- Vacuum distillation and chromatographic purification of CO₂ extracts

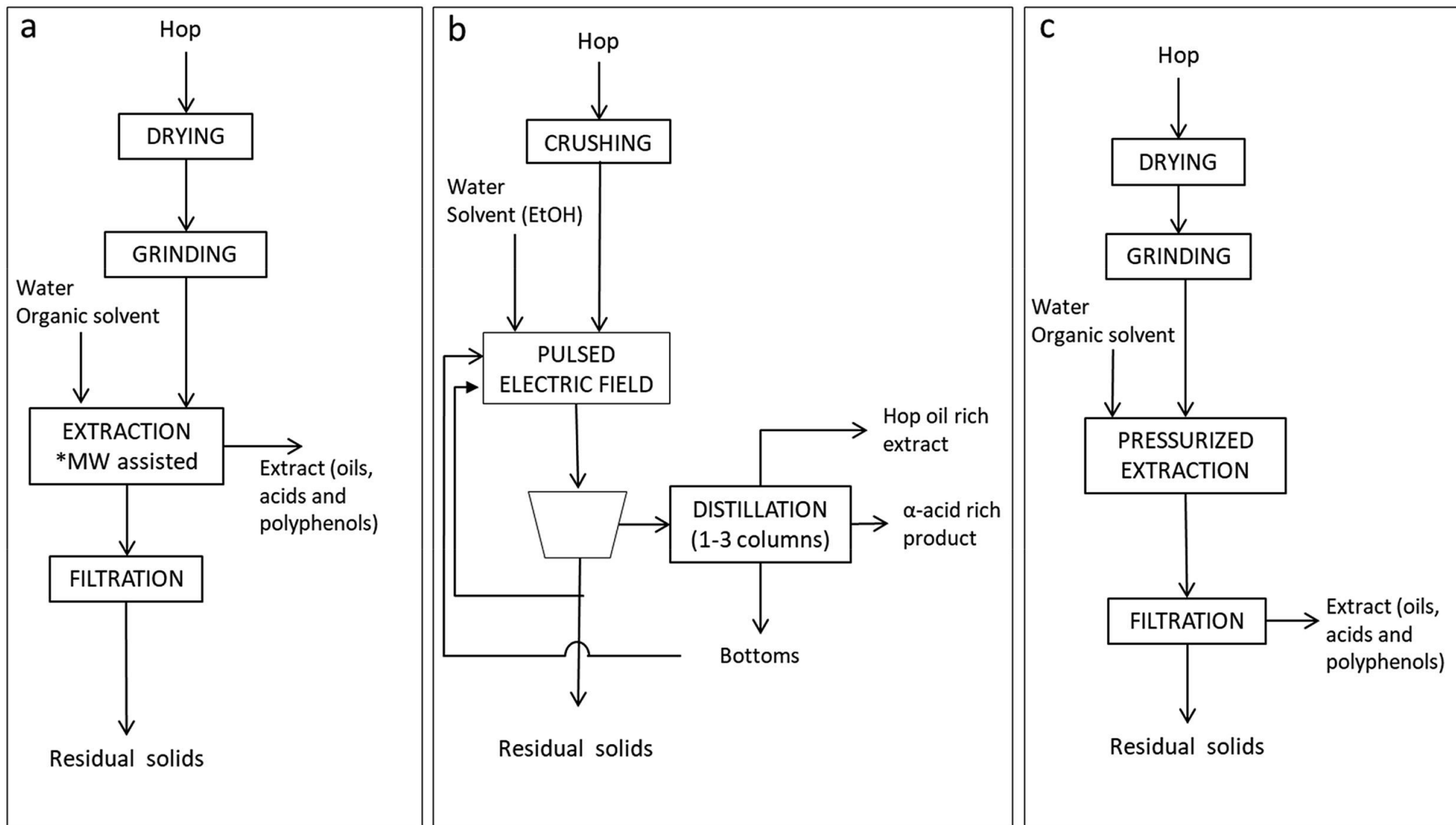

Extraction of hop components conventionally or assisted by intensified technologies, **a) solvent extraction** optionally assisted by microwave ([Jeliazkova et al., 2018](#); [Tyśkiewicz et al., 2018](#)), **b) extraction assisted by pulsed electric field** ([Held & Stanis, 2018](#)), and **c) pressurized extraction**

<https://doi.org/10.1016/j.tifs.2019.08.018>.

Table 2. Examples of the influence of the operational conditions with dense CO₂ on the extraction of hop components.

Operational conditions	Composition of the extract	Reference
Liquid CO₂		
5–6.1 MPa, 16–25 °C	Oils, α-acids (>40%), β-acids	Laws et al., 1977
One stage supercritical CO₂		
8–11 MPa, 40–60 °C, pure CO ₂	Essential oil	Van Opstaele et al., 2012a; Katono et al., 2018
	Essential oil, α acids, β acids	Del Valle et al., 2003; Zanoli & Zavatti, 2008; Formato et al., 2013; Kupski et al., 2017
Two stages supercritical CO₂		
1 8–9 MPa, 50 °C	Essential oil (floral)	Goiris et al., 2002; Van Opstaele et al., 2012b
2 11 MPa, 50 °C	Essential oils (spicy, sesquiterpenoids)	
1 15 MPa, 40 °C. Sep. 1.5 MPa, 20 °C	Essential oil	Zeković et al., 2007; Byelashov et al., 2018
2 25–30 MPa, 40–48 °C. Sep. 1.5 MPa, 20 °C	Acids, α-acids (41%)	
1 28–30 MPa, 50 °C	Essential oils and bitter acids	Forster et al., 2003; Jakowski et al., 2015
2 85–90 MPa, 75–90 °C, pure CO ₂ or EtOH-mod. (20 wt%). Sep.: 6–7 MPa, 40–60 °C	Xanthohumol	
1 20 MPa, 40 °C	Essential oils and bitter acids	He et al., 2005
2 25 MPa, 50 °C, EtOH-mod.	Flavonoids	
1 alcohol, acetone or mixtures, soaking in CO ₂ (2.5–6 MPa)	Xanthohumol	Rójs and Kozłowski, 2016
2 sc-CO ₂ (25–55 MPa, 40–85 °C). Sep.: 5–7 MPa, 17–40 °C		

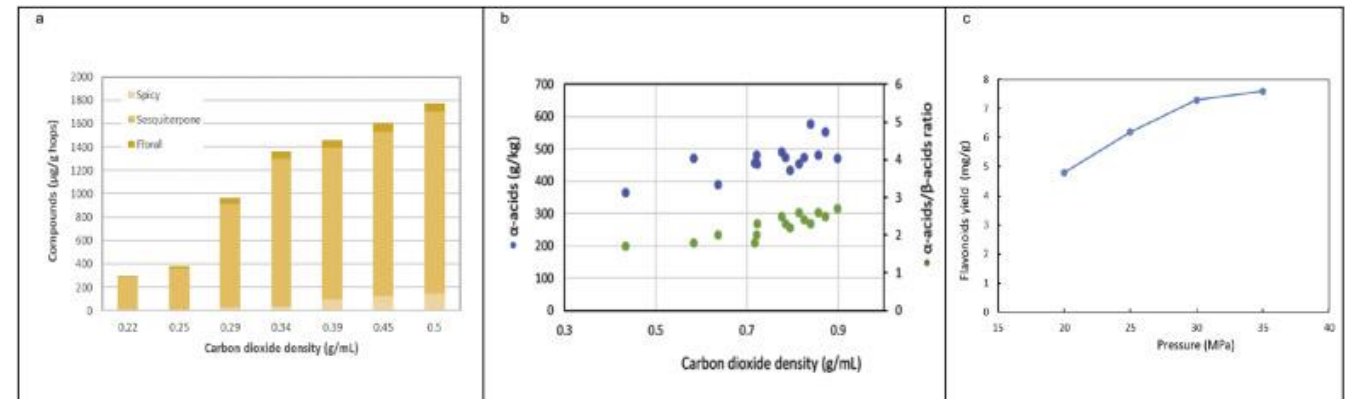

Fig. 2. Effect of solvent density during supercritical CO₂ extraction of a) essential oils (Van Opstaele et al., 2012a), b) bittering compounds (Del Valle et al., 2003) from hop pellets and c) effect of pressure during sc-CO₂ extraction using ethanol (70%) as cosolvent, on the phenolic yield from waste hops (He et al., 2005).