

Supramolecular Pharmacy

4. Artificial anion transporters

Ondřej Jurček

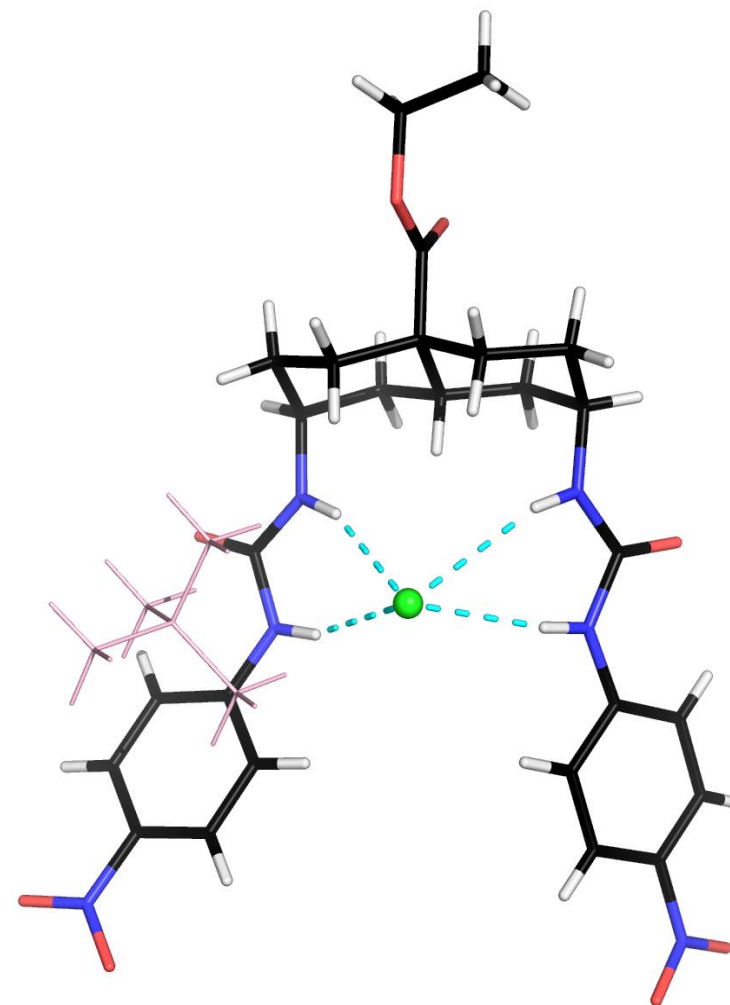

Selectivity of cation complexation

Molecular recognition is based on strong and selective binding:

- size complementarity between the cation and host cavity
 - electrostatic complementarity between the cation and the host binding site
 - degree of preorganisation and donor group orientation
 - chelate ring size
 - cation binding kinetics
 - solvent (polarity, H-bonding, coordination), and cation and host
 - free energies of solvation
 - counteranion and its interactions with solvent, cation (and host)
 - enthalpic and entropic contributions to the cation-host interaction
-
- based on the complex stability and cation exchange kinetics the hosts may be classified as **cation receptors** (slow kinetics, large stability constant) and **cation carriers** (fast kinetics, lower stability)

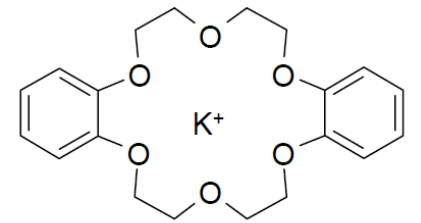

Pedersen 1967

Introduction to anion complexation

- Katapinands (1968) – macrobicyclic hosts capable of binding anions (du Pont, C. H. Park and H. E. Simmons)
- Later F. P. Schmidtchen, J.-M. Lehn, etc.
- 1980s boom in development of anion receptors

Anion importance :

- **Chlorides** - major component of the oceans and it is the dominant anion in biological extra-cellular fluids
- **Nitrate** (from N_2 oxidation) and **sulfate** (from burning organosulfur compound containing fossil fuels) are key components in acid rain
- **Hydrogen carbonate** and **carboxylates** are also key biological anions, while **carbonates**, **phosphates** and **silicates** are the major anions in biomineralised materials such as the exoskeletons of radiolarian, and in bone

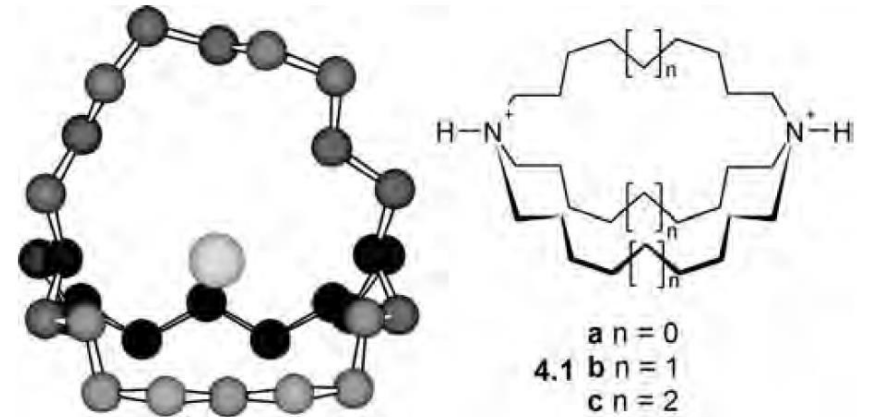

Anion importance

- **Phosphates** and **nitrates** in fertilizers are beneficial to agriculture but also major pollution hazards since such bioavailable sources of phosphorus and nitrogen are often biolimiting, *i.e.*, rate of microorganism growth is limited by the amount of these elements that are present
- Highly soluble and mobile $^{99}\text{TcO}_4^-$ and ClO_4^- , or arsenate: technetium-99 is a β -emitter with a half-life of 213,000 years and is a product of the nuclear fuel cycle, formed in ca. 6 % fission yield and can leach from nuclear waste storage facilities. Perchlorate was used extensively as an explosive and rocket propellant.
- Anions are crucial in biological systems – perhaps this is why imbalances in their concentration have such serious effects. 70-75 % of enzyme substrates and cofactors are anions, very often phosphate residues (as in ATP and ADP) or as inorganic phosphate (H_2PO_4^-). Chloride anion is the major extracellular anion, and it is responsible for the maintenance of ionic strength (cystic fibrosis).

Cystic fibrosis

- inherited disorder that causes severe damage to the lungs, digestive system and other organs in the body
- no functional copies (alleles) of the gene cystic fibrosis transmembrane conductance regulator (CFTR)
- the product of this gene (the CFTR protein) is a chloride ion channel important in creating sweat, digestive juices, and mucus.
- it regulates flow of Cl^- and H_2O
- developing supramolecular chloride transporters to treat the conditions

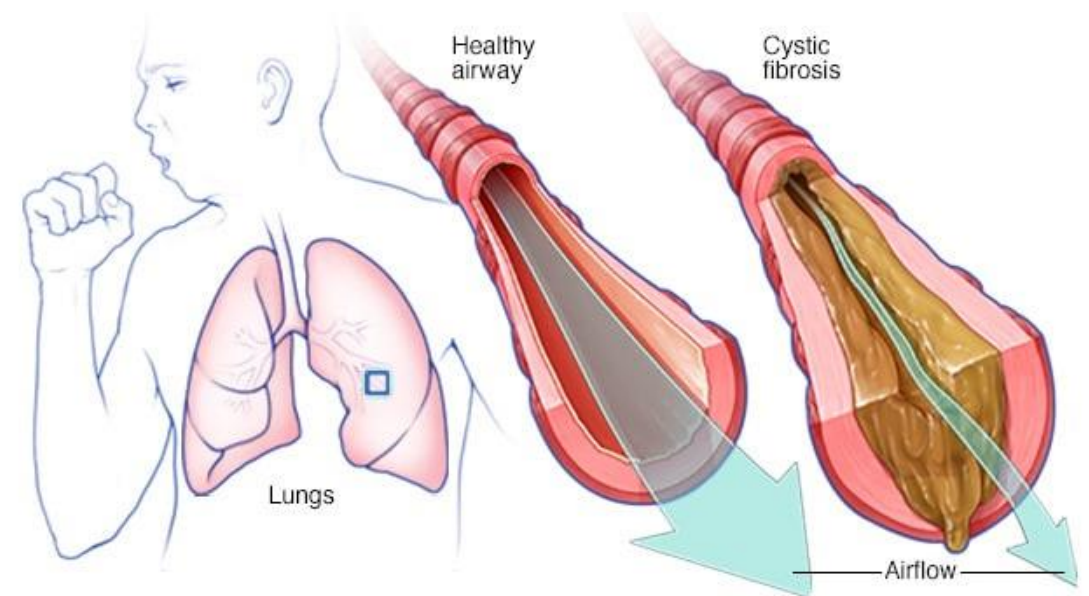
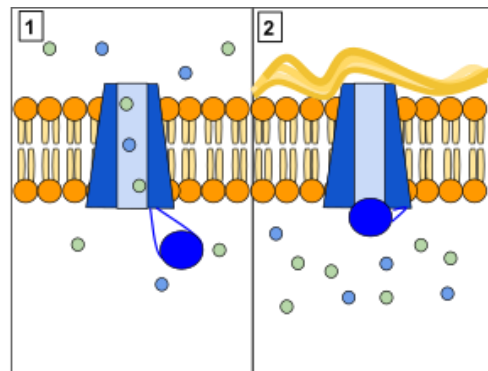

© MAYO FOUNDATION FOR MEDICAL EDUCATION AND RESEARCH. ALL RIGHTS RESERVED.

Challenges in anion transport

- Development in the area is relatively slower than cation transport
- Primarily based on preorganisation, complementarity, solvation and size and shape effects
- BUT anions are relatively large and therefore require receptors of considerably greater size than cations, *e.g.*, one of the smallest anions, F^- is comparable in ionic radius to K^+
- Even simple inorganic anions occur in a range of shapes and geometries, *e.g.* spherical (halides), linear (SCN^- , N_3^-), planar (NO_3^- , $PtCl_4^{2-}$), tetrahedral (PO_4^{3-} , SO_4^{2-}), octahedral (PF_6^- , $Fe(CN)_6^{3-}$) as well as more complicated examples as in the case of biologically important oligophosphate anions.

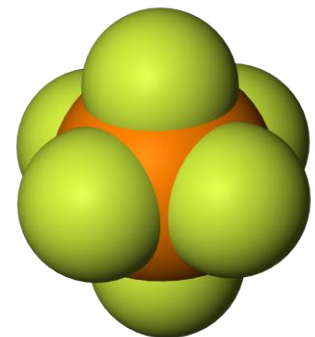
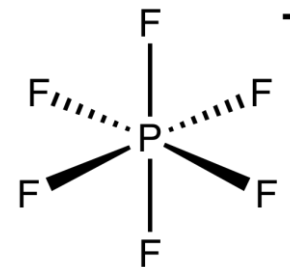
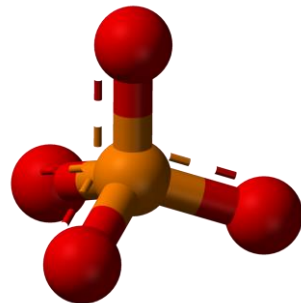
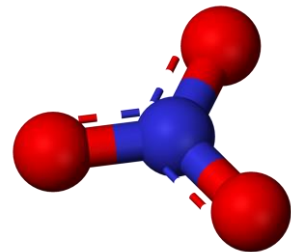

Challenges in anion transport

- In comparison to cations of similar size, anions have high free energies of solvation and hence anion hosts must compete more effectively with the surrounding medium
- Many anions exist only in a relatively narrow pH window, which can cause problems especially in the case of receptors based upon polyammonium salts where the host may not be fully protonated in the pH region in which the anion is present in the desired form.
- Anions are usually coordinatively saturated and therefore bind only via weak forces such as hydrogen bonding and van der Waals interactions, although they can form dative bonds.

Hofmeister series

- Easing the situation is division of anions based on their hydrophobicity
- Ability of anions to „salt out“ proteins, which is also correlated with hydration of anions

Weakly hydrated (hydrophobic)

Strongly hydrated (hydrophilic)

Anions: organic anions > ClO_4^- > I^- > SCN^- > NO_3^- > ClO_3^- ...

> Br^- > Cl^- >> F^- , IO_3^- > CH_3CO_2^- , CO_3^{2-} > HPO_4^{2-} , SO_4^{2-} > citrate³⁻

Cations: $\text{N}(\text{CH}_3)_4^+$ > NH_4^+ > Cs^+ > Rb^+ > K^+ > Na^+ > H^+ > Ca^{2+} > Mg^{2+} , Al^{3+}

- Any cationic molecule that acts as a host for anions is in competition with the counter-cation (particularly in non-polar solvents where ion pairing can be very significant)
- Citrate increases solvent surface tension and decrease the solubility of nonpolar molecules (salt out); in effect, they strengthen the hydrophobic interaction

Hofmeister series



Anion receptors/transporters in nature

- At least 14 mitochondrial anion transport systems have been identified including systems involving flux of ADP, ATP, citrate, phosphates, **glutamate**, fumarate, maleate, oxaloacetate and halides.
- The structure of a chloride channel protein was reported in 2002 and, along with earlier work on potassium channels, led to the award of a share of the 2003 Nobel Prize in Chemistry to Roderick MacKinnon
- In biochemical anion binding, the enzyme or protein host is always part of a functioning biological system, e.g. in biocatalysis or anion transport.
- Natural anion binding systems must not only have high affinity for their target anion and low affinity for other species present in the cell or extracellular fluid (thermodynamic selectivity) but must also complex and release their substrates rapidly and at the appropriate time (kinetic selectivity).

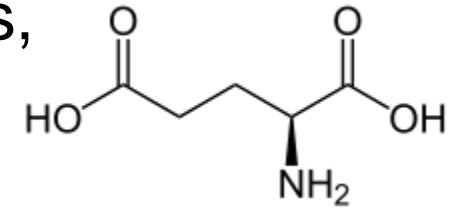

Anion binding proteins

- Phosphate binding protein (PBP) binds HPO_4^{2-} which is held in place by a total of 12 hydrogen bonding interactions with N/O...O distances between 2.62 and 2.92 Å. Seven are from NH groups from the protein main chain or arginine side chain residues, four are from OH groups (two serine and two threonine), and one involves an oxygen atom from a carboxylate anion (Asp56), which acts as a hydrogen bond acceptor (crystal structure).
- Arginine fork motif
- Guanidinium, the protonated form of guanidine, is an excellent anion binding site because it remains protonated over an extremely wide pH range
- Three amide NH pocket = nest

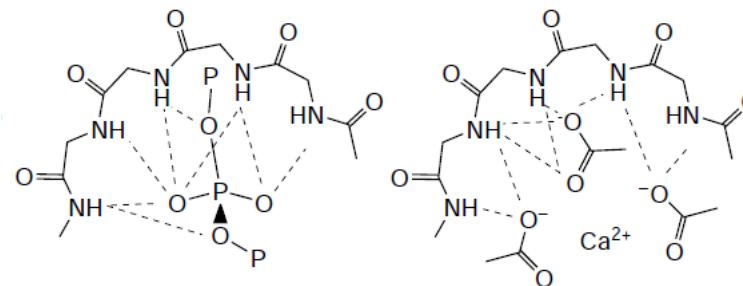
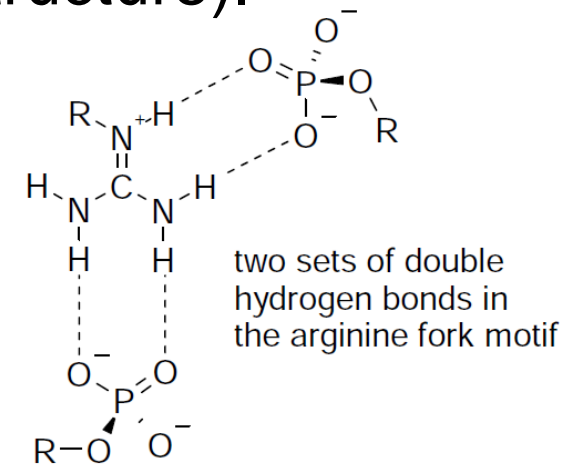
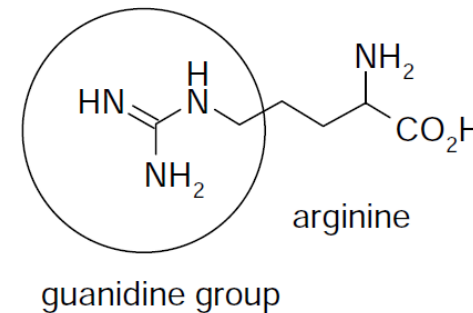

Concepts in anion host design

- Preorganization - significant contribution to anion binding comes from dispersion and electrostatic interactions, which are non-directional, and so in some sense the whole host is a binding site
- Challenge – coordinatively saturated nature of anions or lack of specific HB functionality, especially for halides, which behave approximately like spherical charges and have a highly versatile coordination geometry without specific binding sites

Katapinands – low binding constants, low preorganization

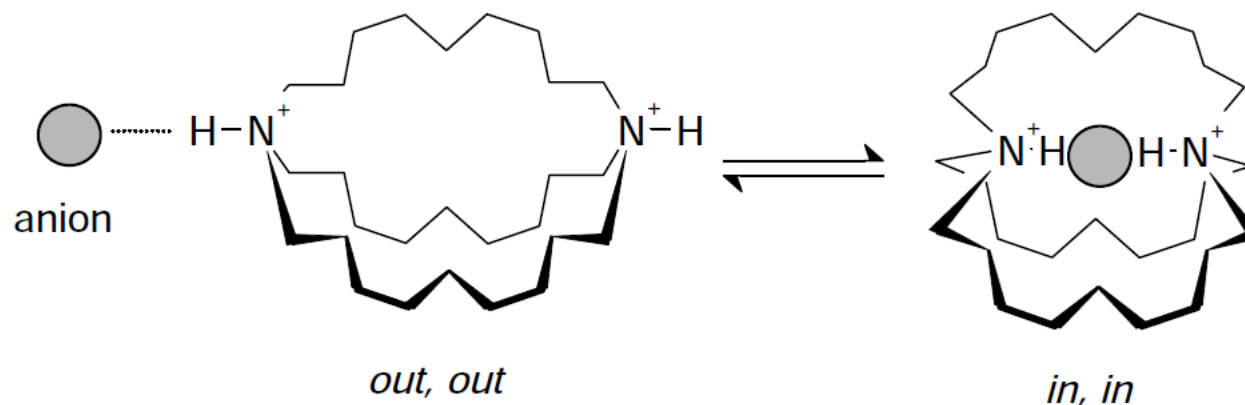

Important issues to anion binding

- The negative charge suggests that both neutral, and especially positively charged, hosts will bind anions.
- Ion pair is held together through electrostatic interactions, which are non-directional and so all anions will be attracted to hosts on an electrostatic basis – competition between original counter cation and the host.
- The vast majority of anions are Lewis bases, thus hosts containing Lewis acidic atoms, such as organo boron, mercury or tin compounds, or metal cations in general, might make the basis of a suitable host by formation of coordinate bonds (HB also possible N-H \cdots Cl, e.g. katapinands).
- Anions are highly polarisable and so van der Waals interactions will be significant (importance of contact surface area).
- Anions generally have high solvation energies and so, to an even greater degree than cation binding, the solvent effects the binding constant (generally, 10^2 - 10^3 M $^{-1}$ in water)
(increasing H₂O < DMSO < MeCN < CHCl₃ < CCl₄)

Important issues to anion binding

- coordination number and geometry of a bound anion
- wide variety of anion coordination geometries are known,
- the number of interactions an anion is able to form increases with its size
- pH of environment plays a role
- major features of preorganization, complementarity, solvation and size and shape effects also apply to anion host design

Soccer ball cryptand

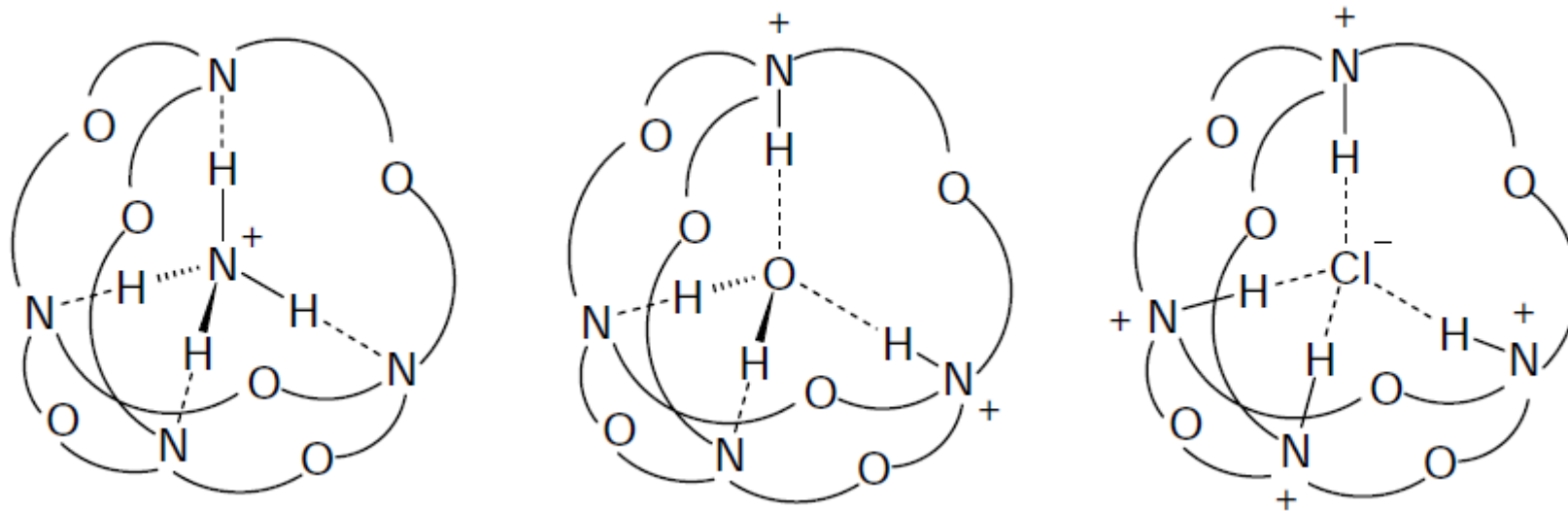

Anion binders

Structural features for anion binders:

- Cationic anion binders
- Neutral anion binders
- Metal containing anion binders

Extended binding mode:

- Ion pair receptors

Molecular scaffold:

- Trialkylbenzene motif
- Bambusurils
- Cholapods
- Etc.

Cationic artificial anion binders

Ammonium based podands

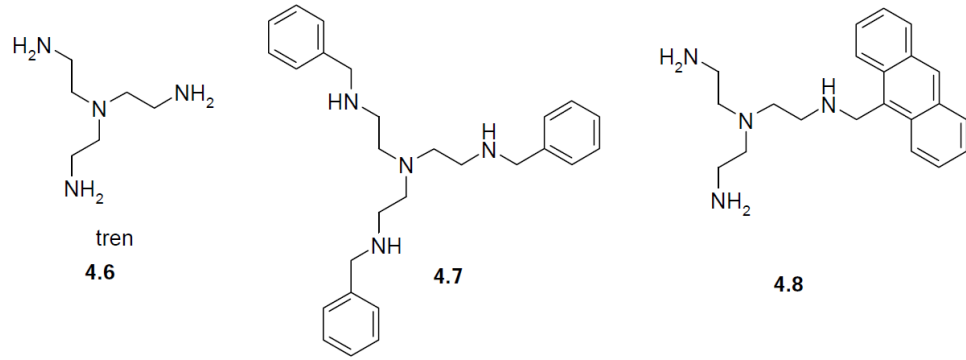

Tetrapyrrools

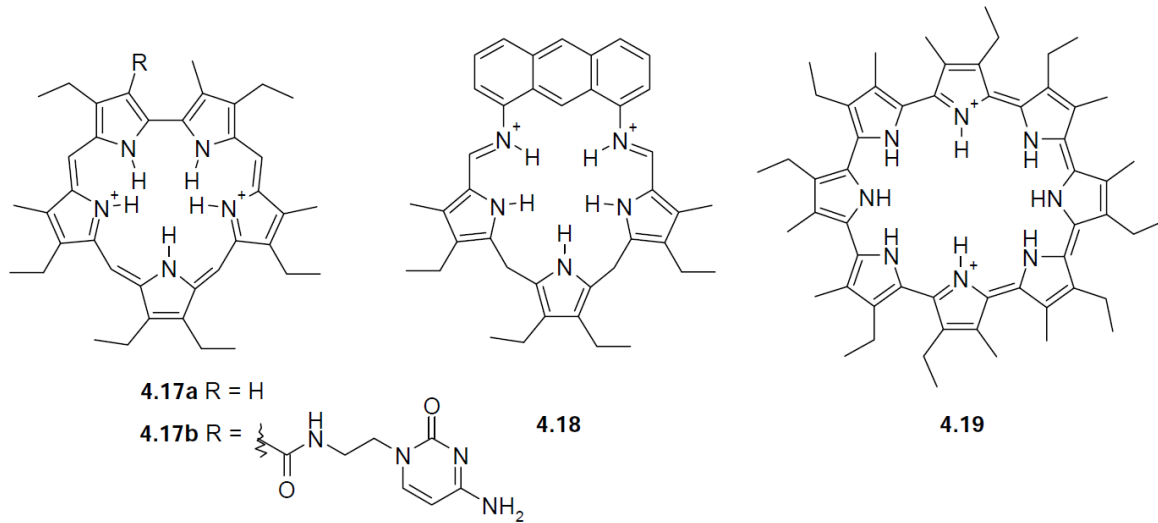

Azacorands

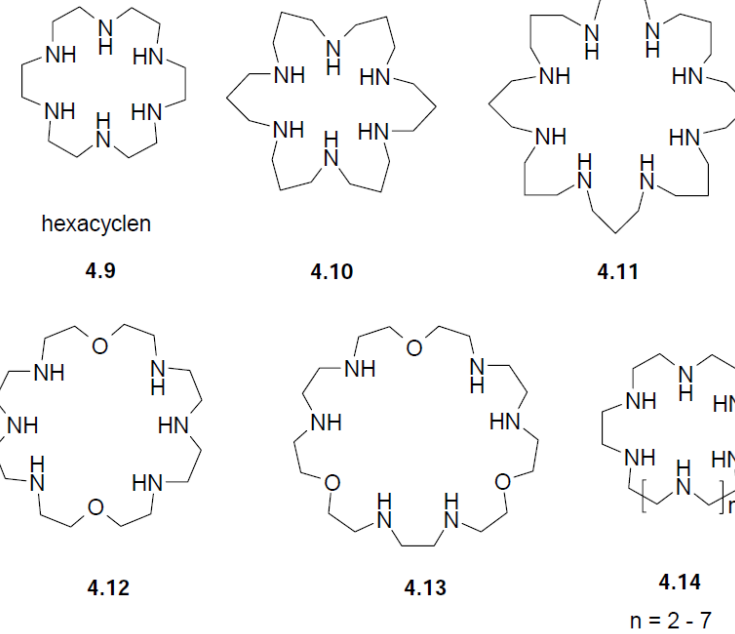
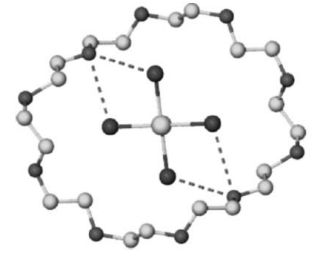

Podands

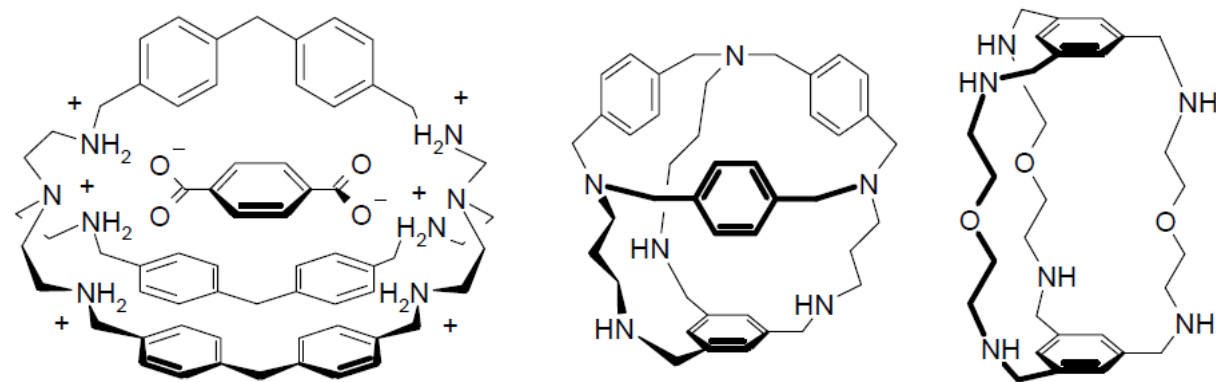

Cationic artificial anion binders

Cationic guanidium based receptors

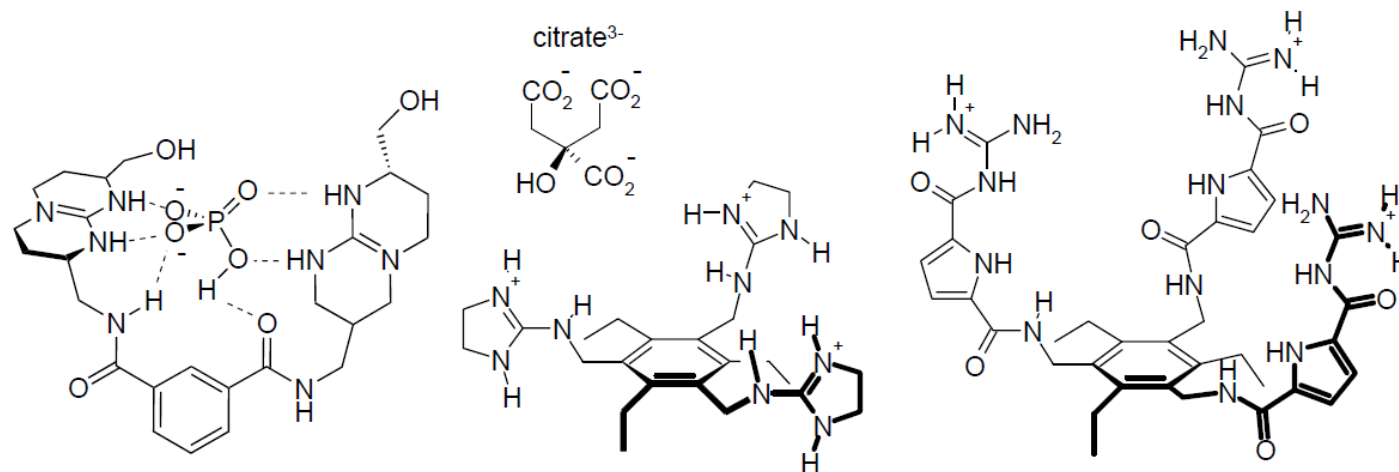
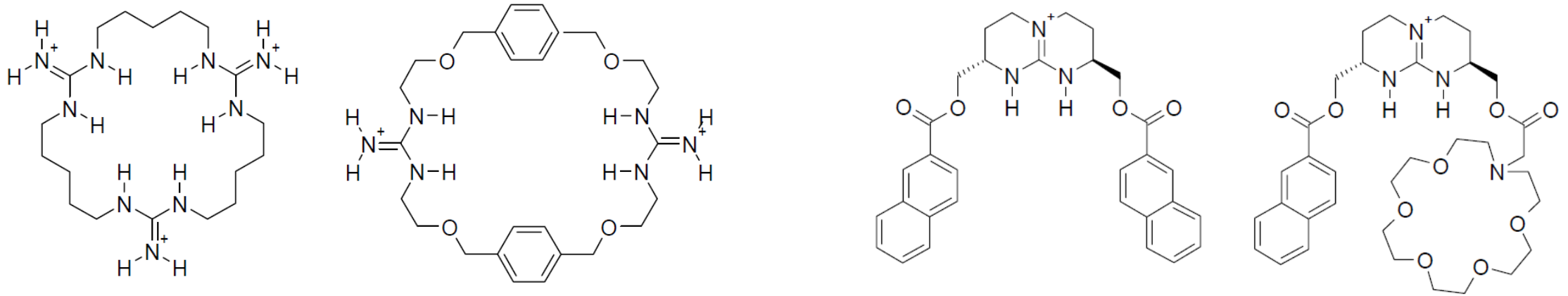

Neutral artificial anion binders

- non-directional nature of electrostatic forces means that all anions are bound with some degree of strength, which can reduce anion selectivity in cationic receptors
- additional directional interactions, such as hydrogen bonds, are too weak to overcome the electrostatics
- cationic hosts have always anion which competes for the binding site – neutral lack this
- in fact, neutral binder must bind both the anion and its counter-cation and so is formally a host for an ion pair
- better membrane transport properties because of the higher lipophilicity

Zwitterionic

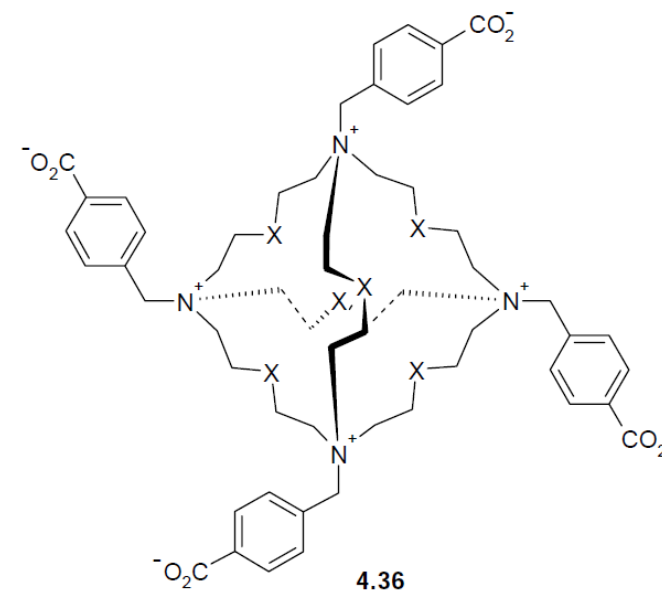
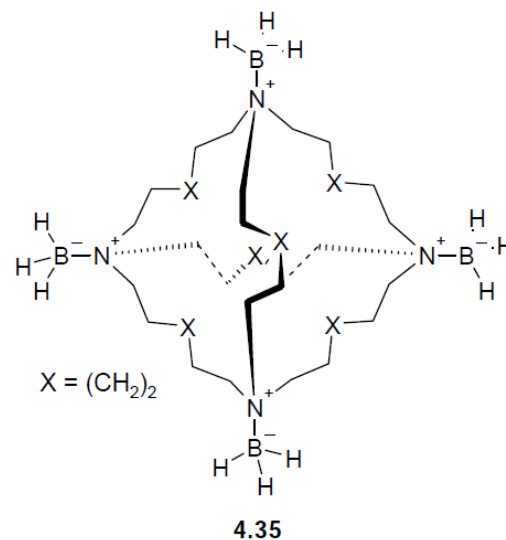

Neutral artificial anion binders

Amide based – analogous to protein binding

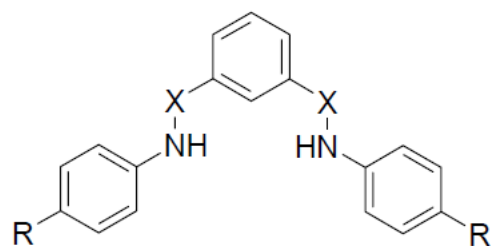

4.37a R = H, X = CO

4.37b R = n-Bu, X = CO

4.37c R = H, X = SO₂

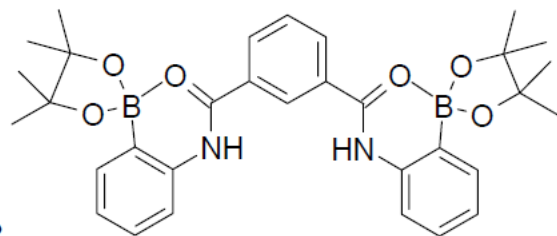

4.38

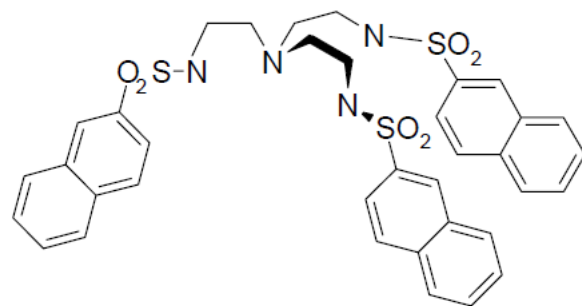
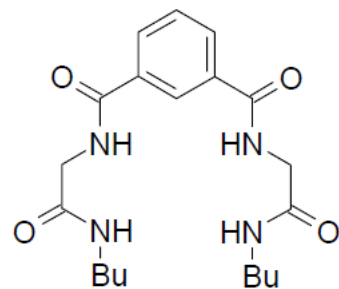

4.40

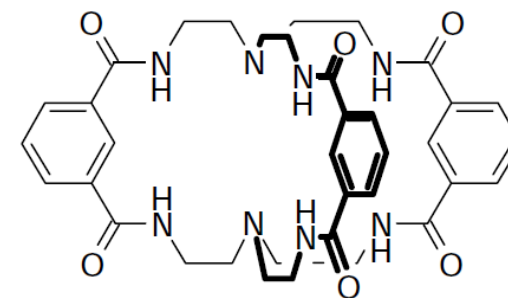
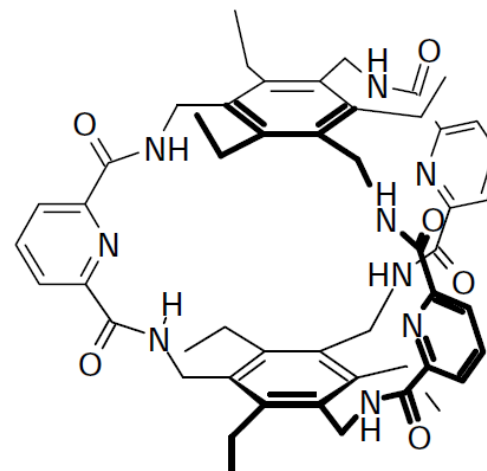
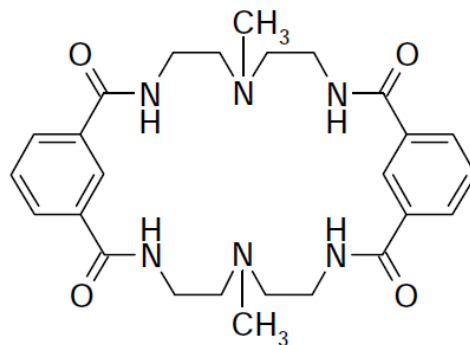

Neutral artificial anion binders

Urea and thiourea derivatives

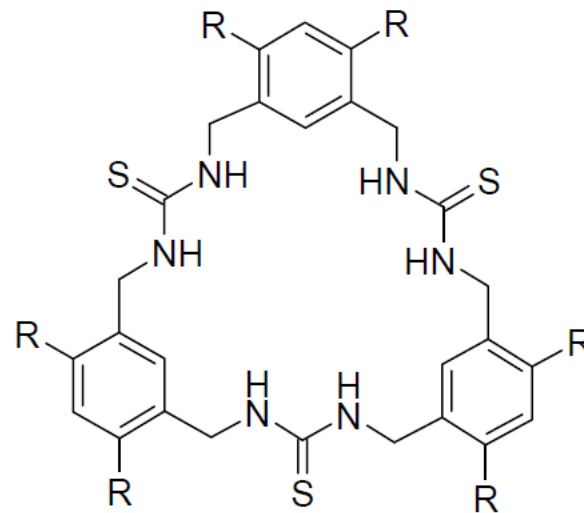
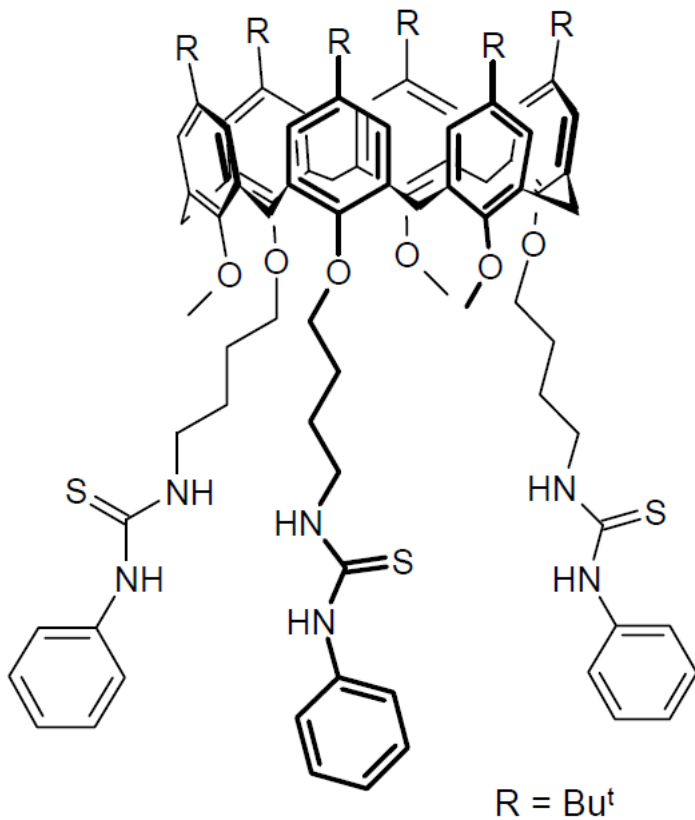
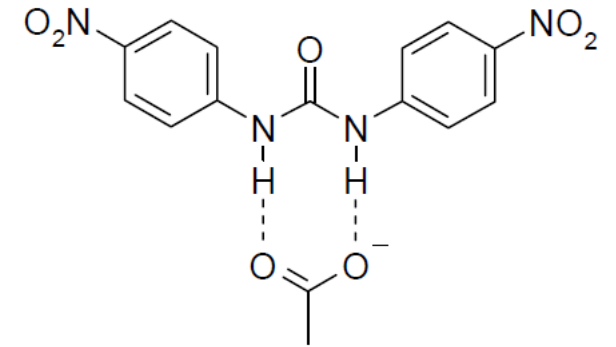
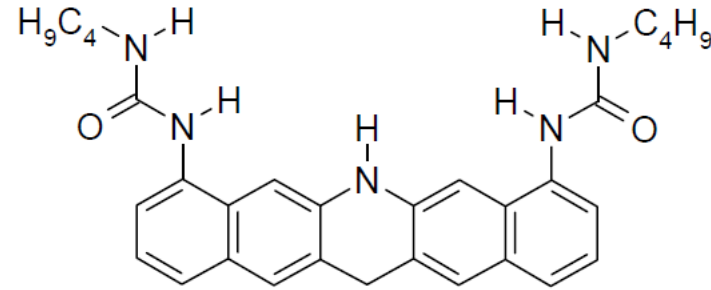

4.48a R = H

4.48b R = C₂H₅

Neutral artificial anion binders

Pyrrole derivatives

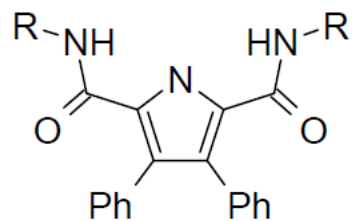
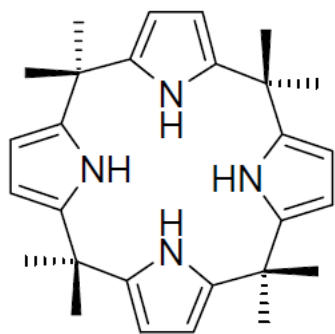

R = alkyl, nitrophenyl *etc.*

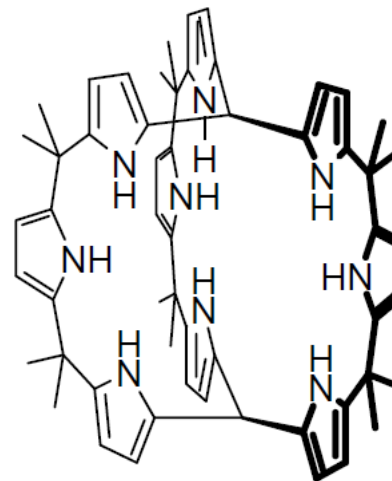
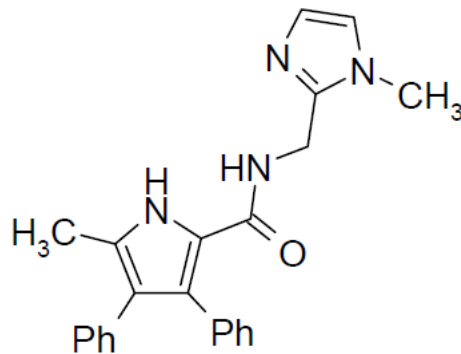

Peptide based derivatives

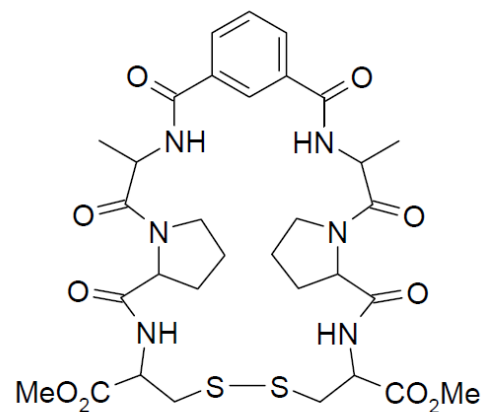
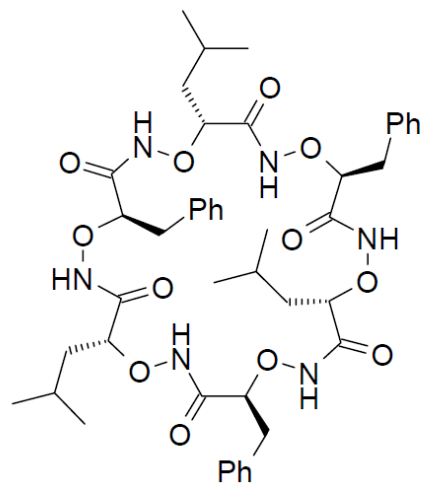

Squaramides

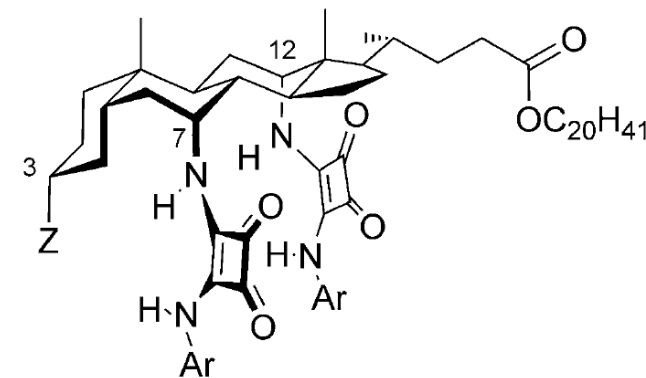
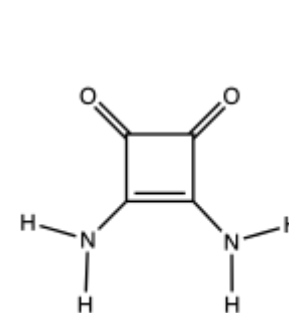
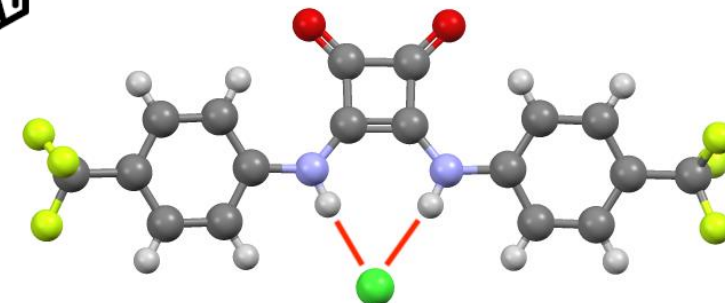

Metal containing receptors

1. Those in which an inert or labile metal centre plays a structural role
2. Those in which an inert or labile the metal is a key component of the anion binding site
3. Those in which an inert or labile metal acts as part of a redox, luminescent or colorimetric reporter or sensing group

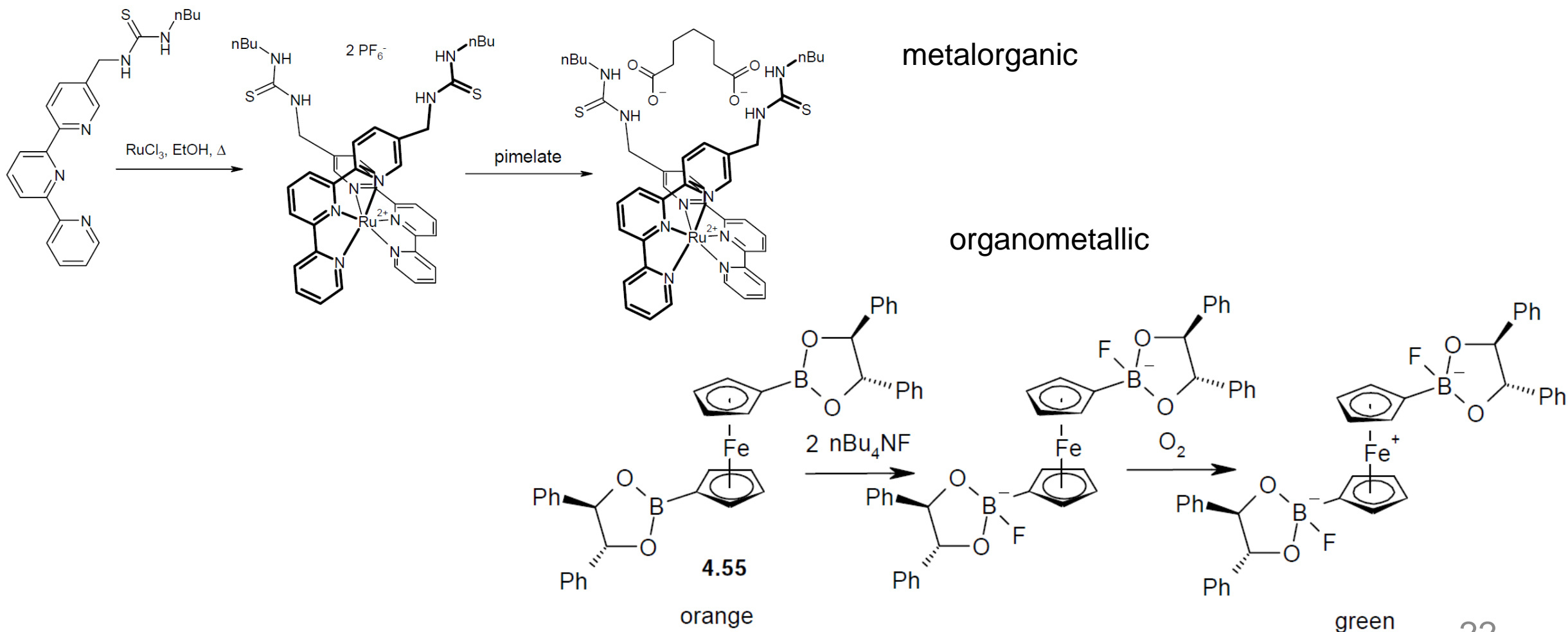

Metal containing receptors

Anticrown

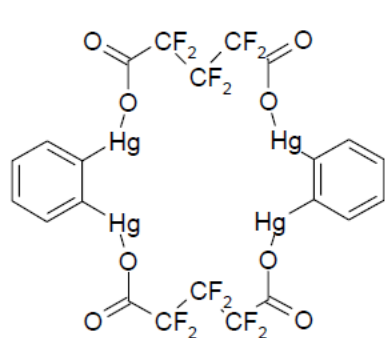

4.79

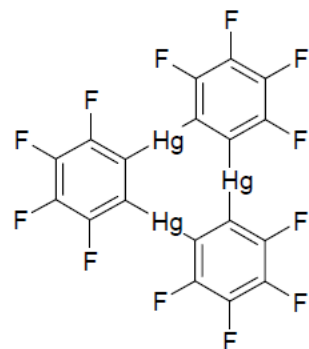

4.80

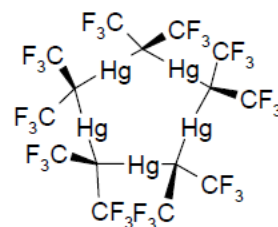

4.81

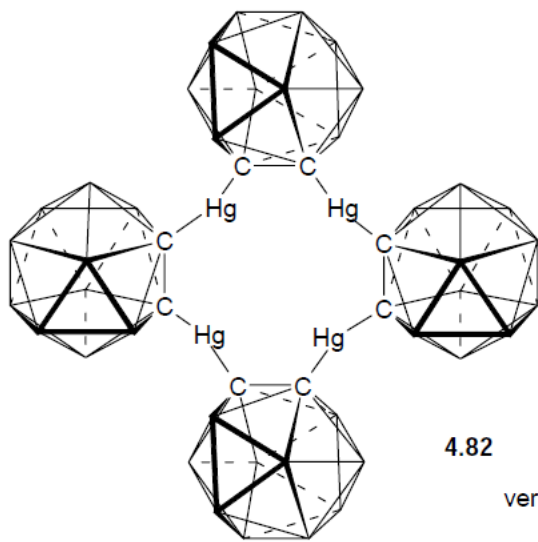

4.82

[12]mercuracarborand-4

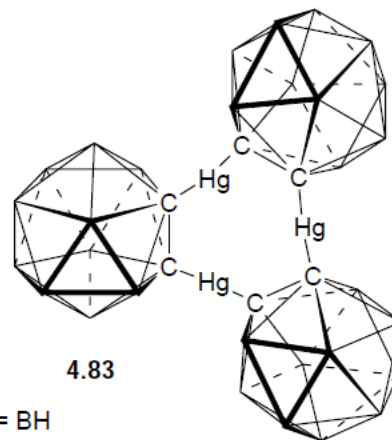

4.83

[9]mercuracarborand-3

vertices = BH

18-Crown-6

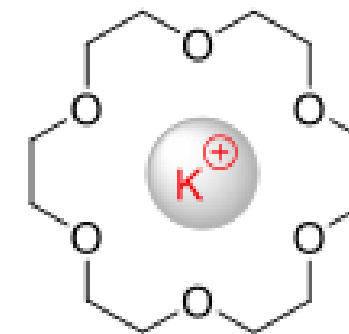

Ion pair hosts

- Biological systems, so called symport (system capable to transport simultaneously both cations and anions across membranes) provide inspiration for ion pair receptors
- Capable to bind simultaneously labile (metal) cations and anions to give an overall neutral complex
- Typically, ion pair hosts have two or more different binding sites or binding of one species may create a binding site for another (cascade complexes)
- In polar solvents solvation energy overcomes the electrostatic attraction between cation and anion → solvent separated ion pairs
- In less polar media ion pairs are often poorly solvated → contact ion pairs → breaking the attraction between cation and anion may be enthalpically unfavourable

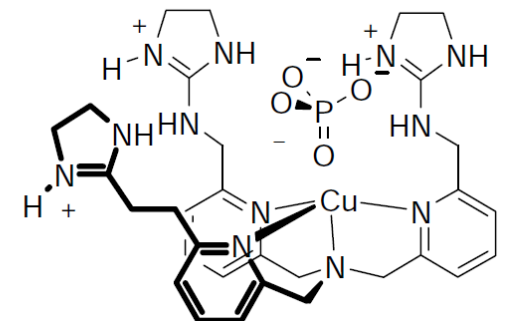
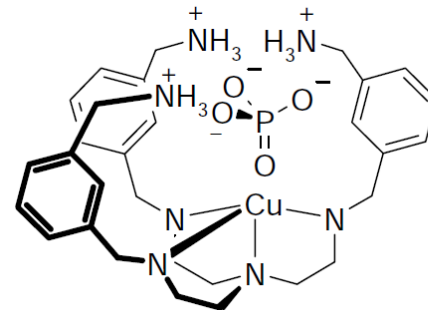

Ion pair receptor from our lab

- Salophen

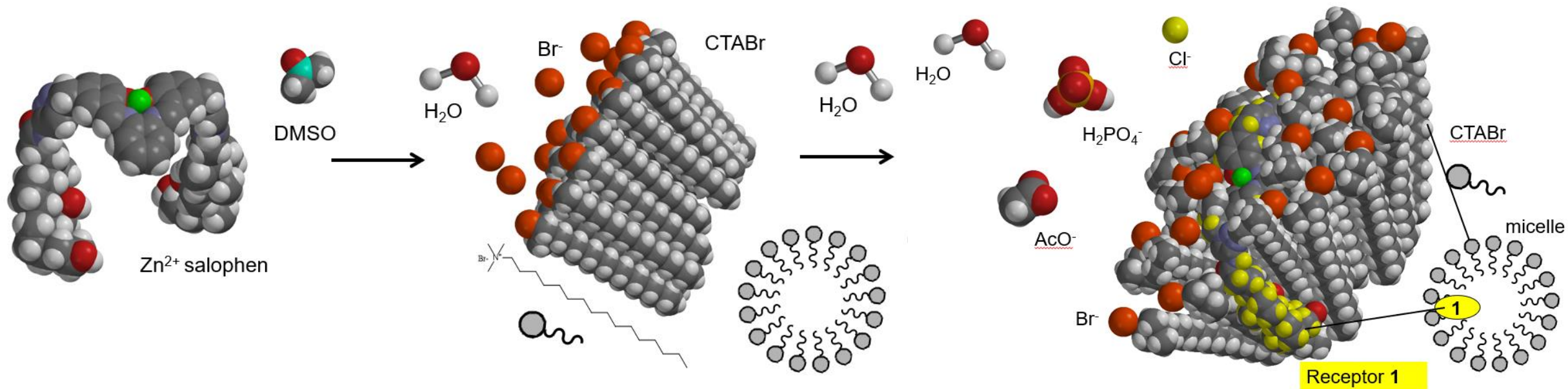
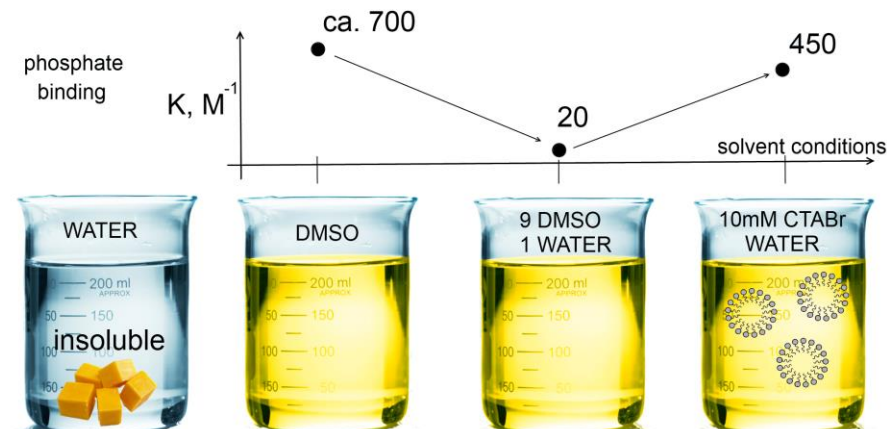
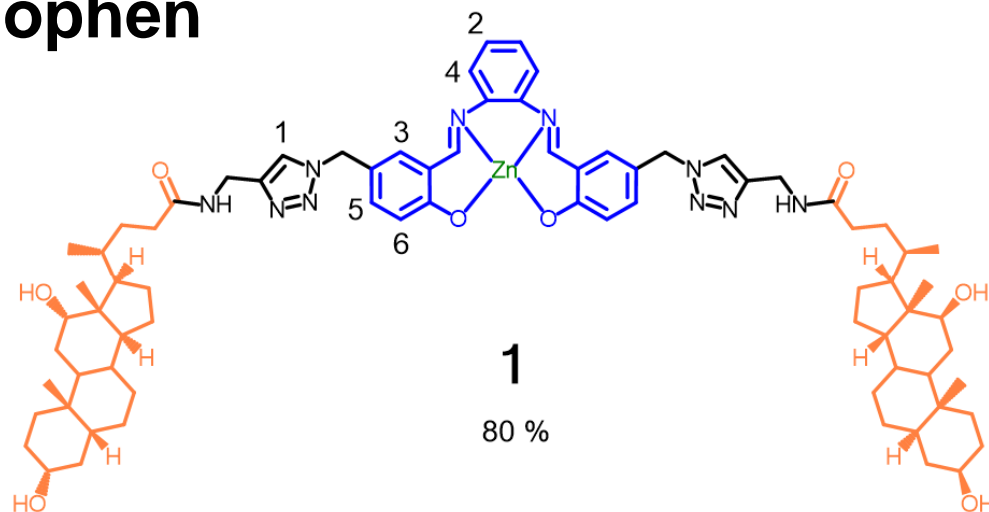

Anion (chloride) transport study

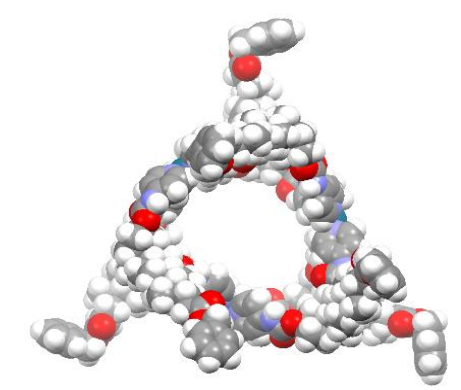
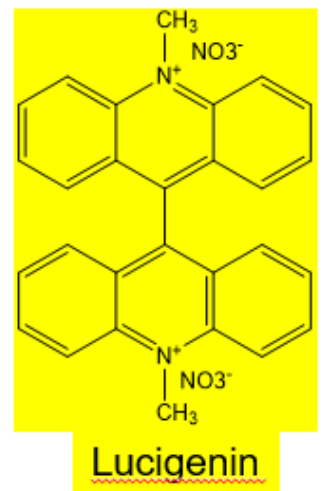
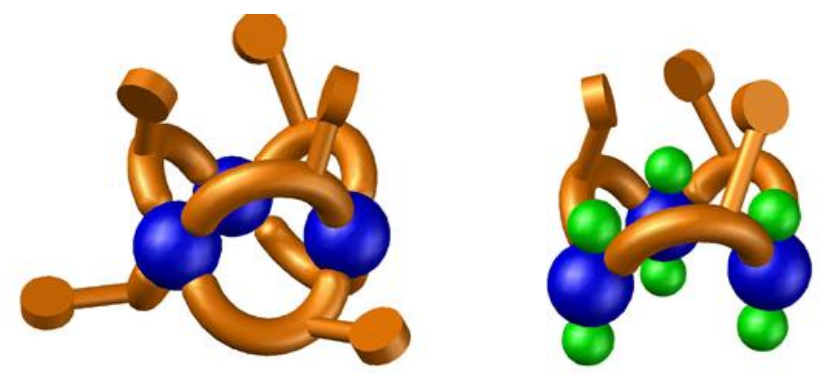
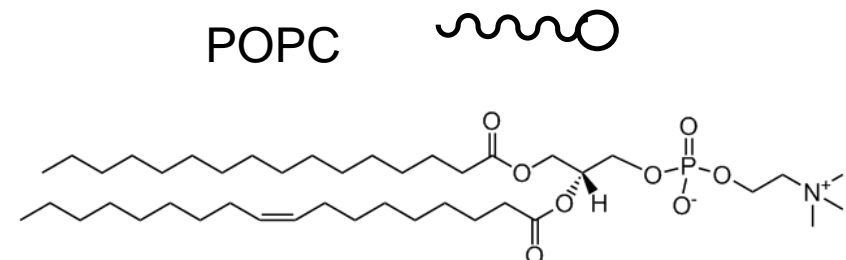
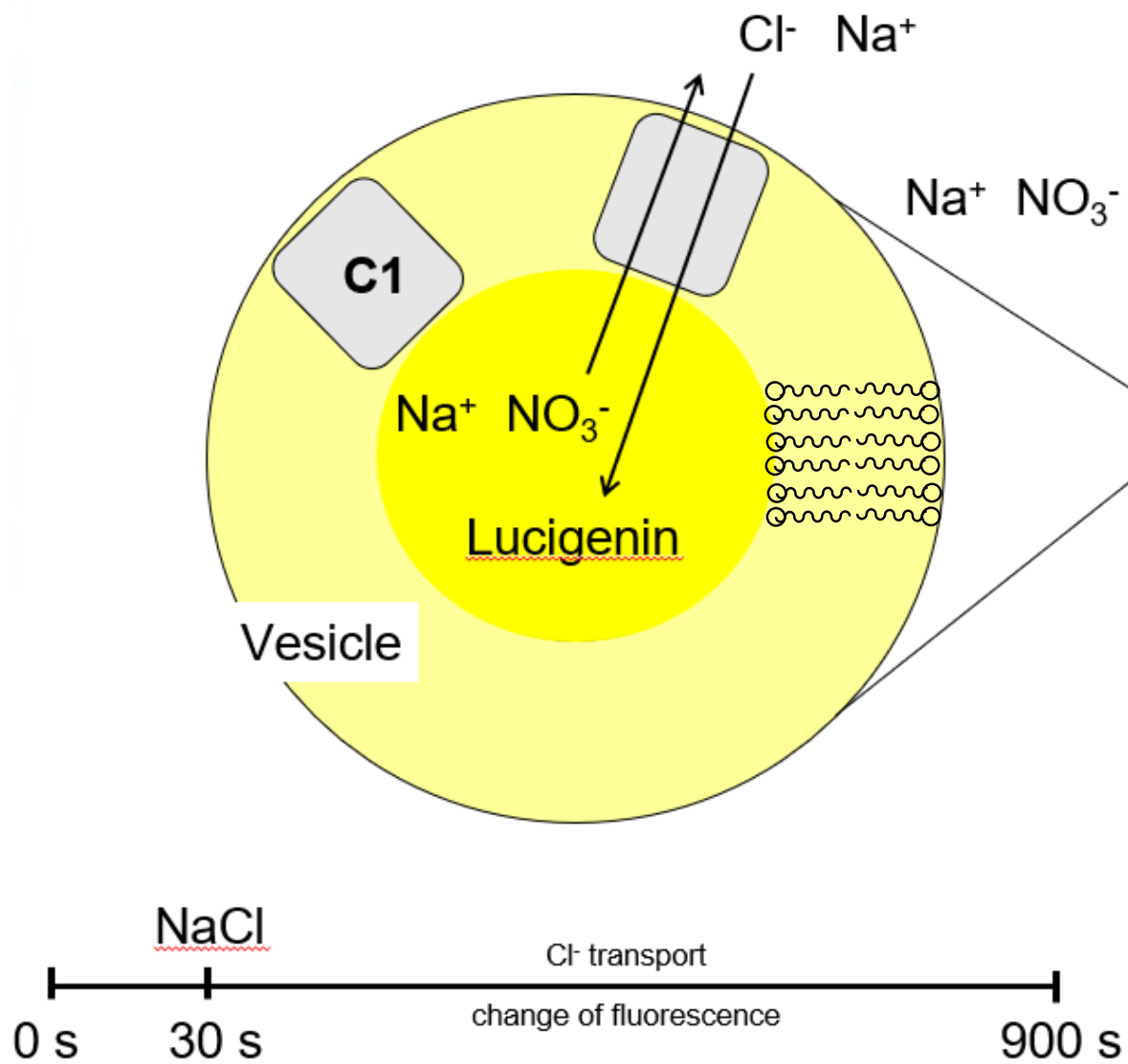

Vesicle preparation

1. Mix POPC, cholesterol and anion transporter soln.
2. Evaporate solvents
3. Re-dissolve in aqueous NaNO_3 soln. of dye (lucigenin)
4. Stirr for 1 h (vesicle formation)
5. Freeze-thawing (breaking down multilamellar vesicles)
6. Sizing (formation of vesicles smaller than 200 nm, extruder)
7. Size exclusion separation (removal of small vesicles and free dye)
8. Measure transport
9. Data processing

7.

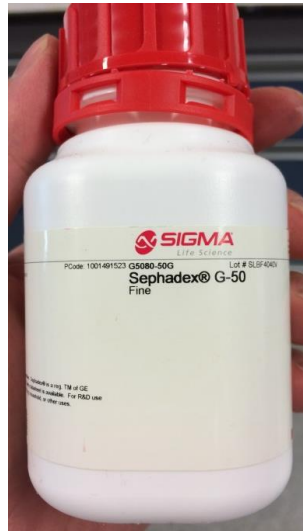

6.



8.

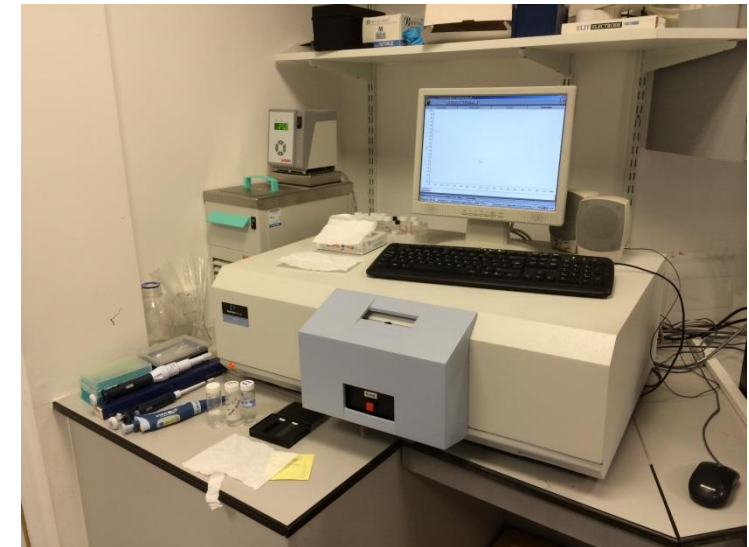

Channels or transporters?

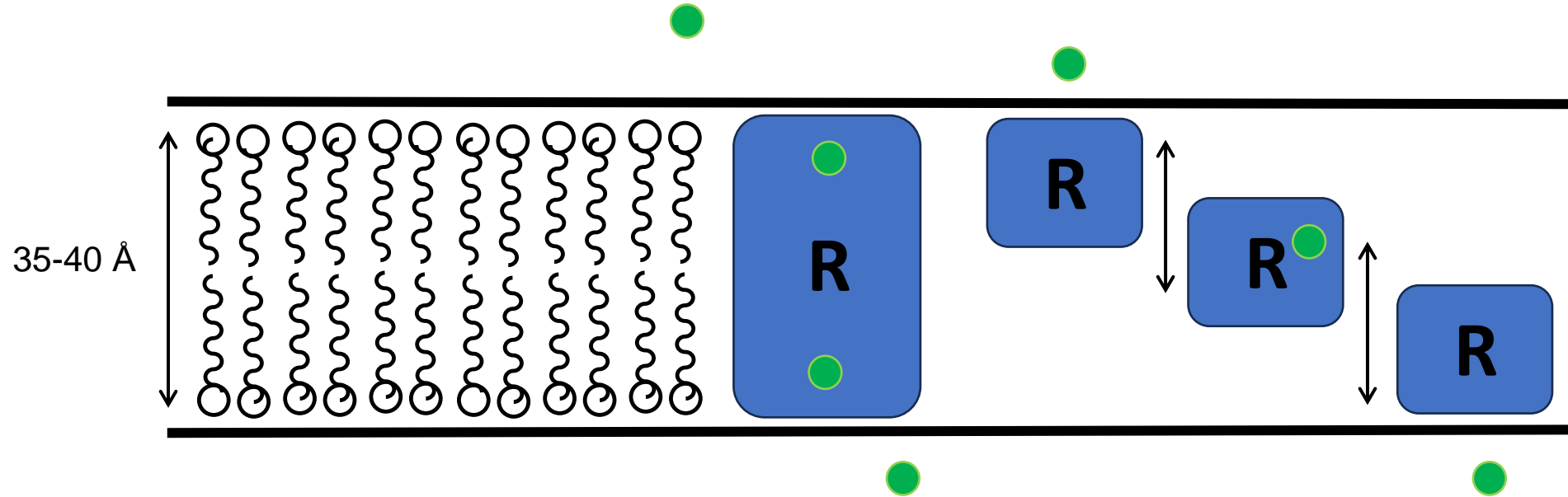

Thickness of the wall of POPC + cholesterol vesicle = 35-40 Å

Transport, deliverability, channel or transporter...?

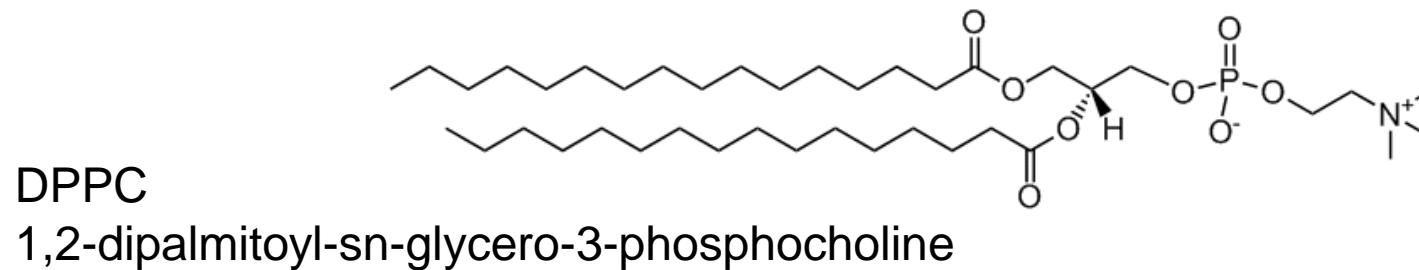
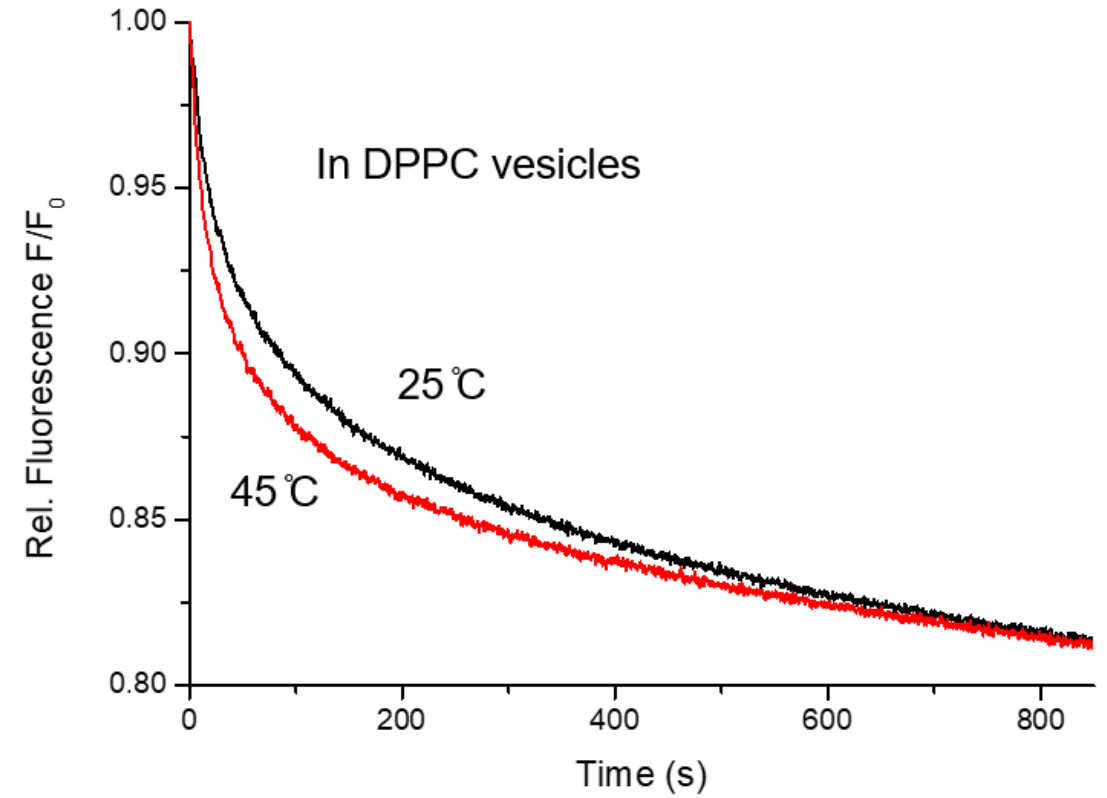
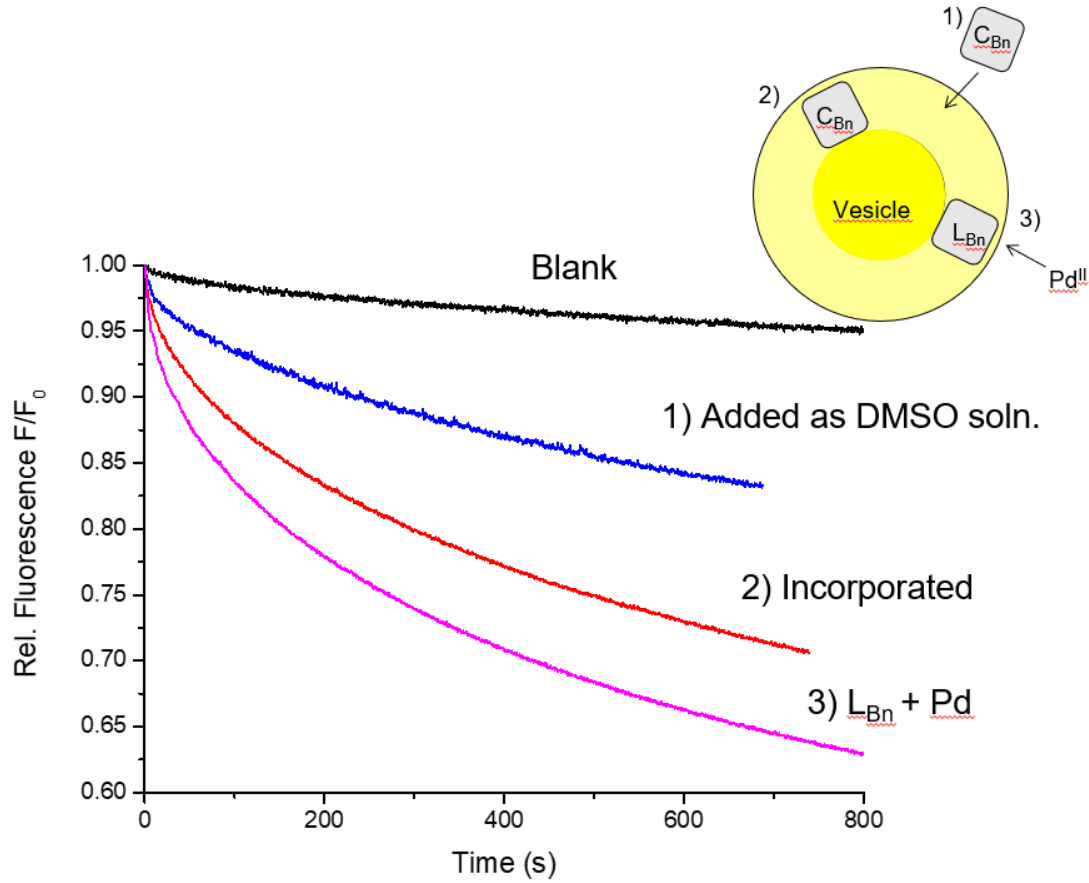

Common core molecular scaffolds

Trialkylbenzen motif

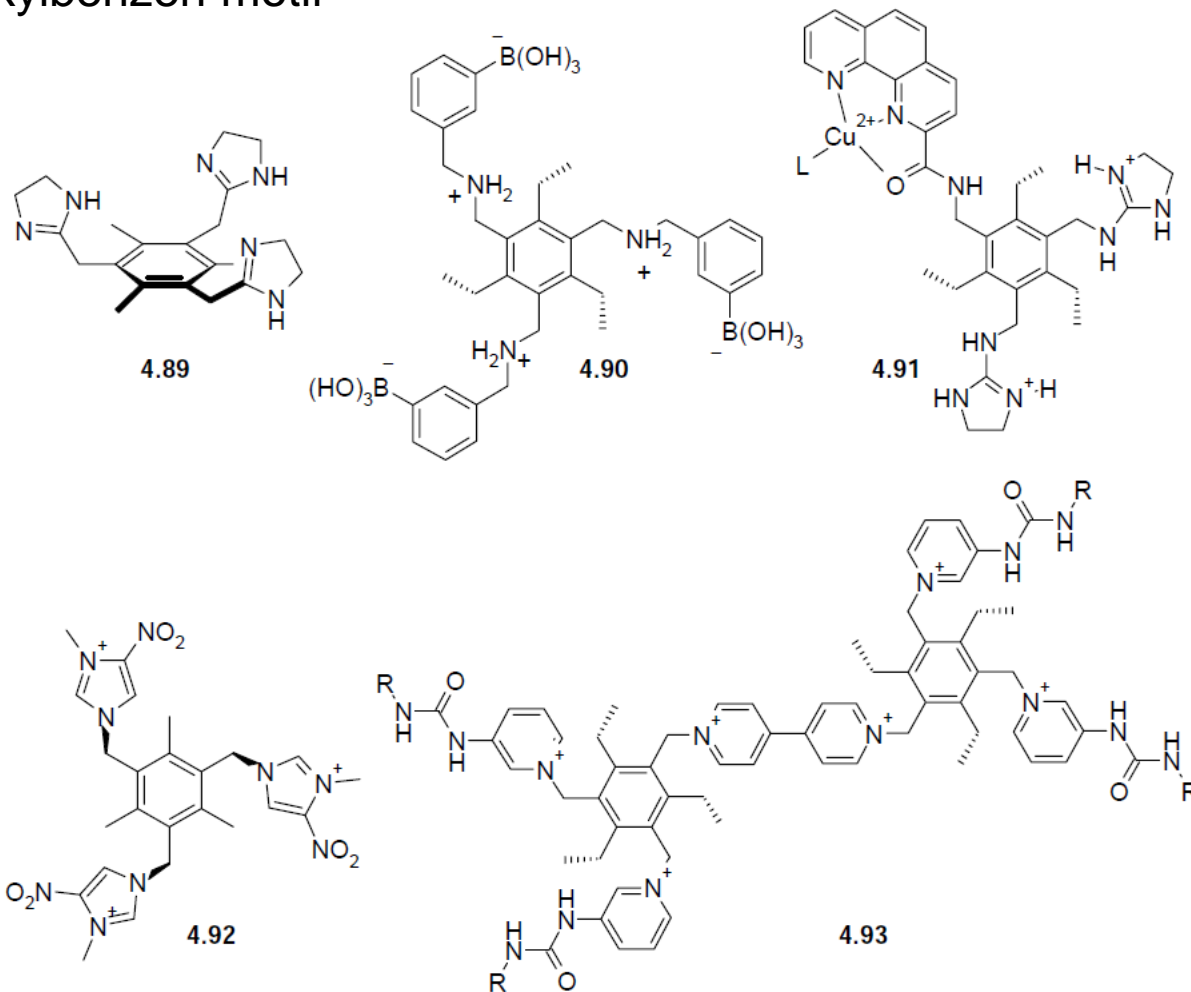

Common core molecular scaffolds

Bambusurils

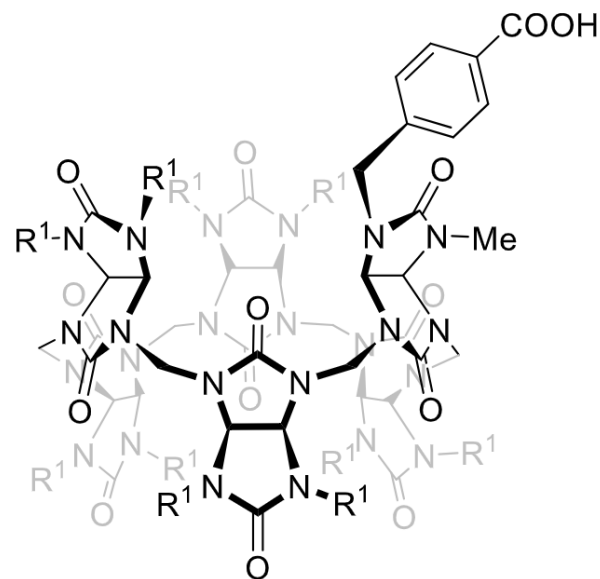
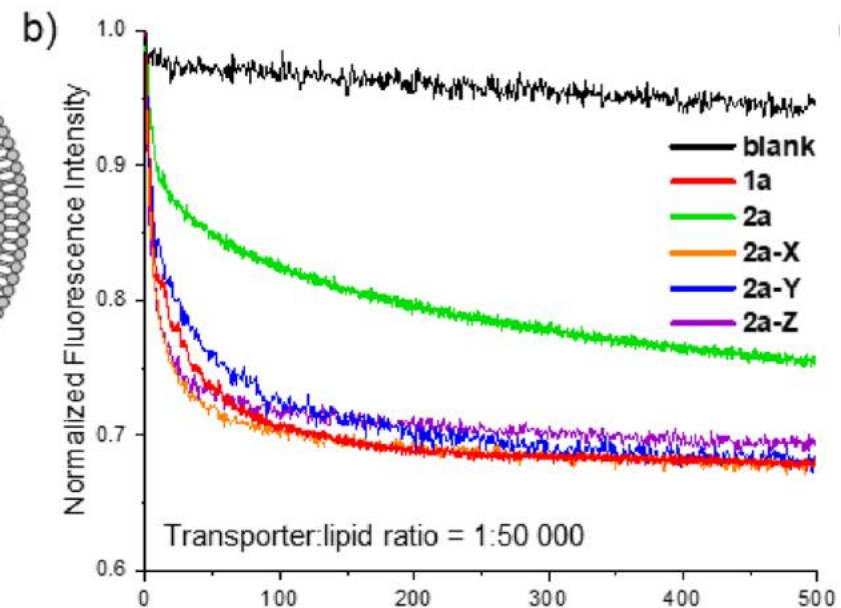
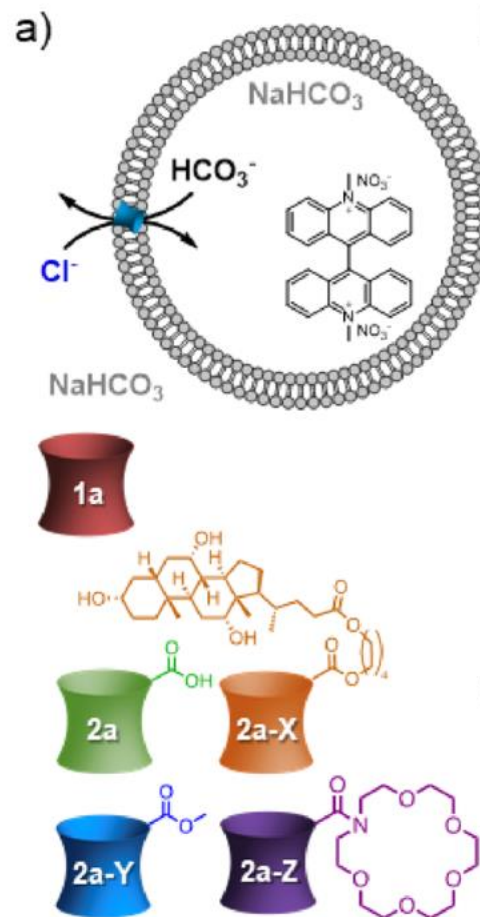
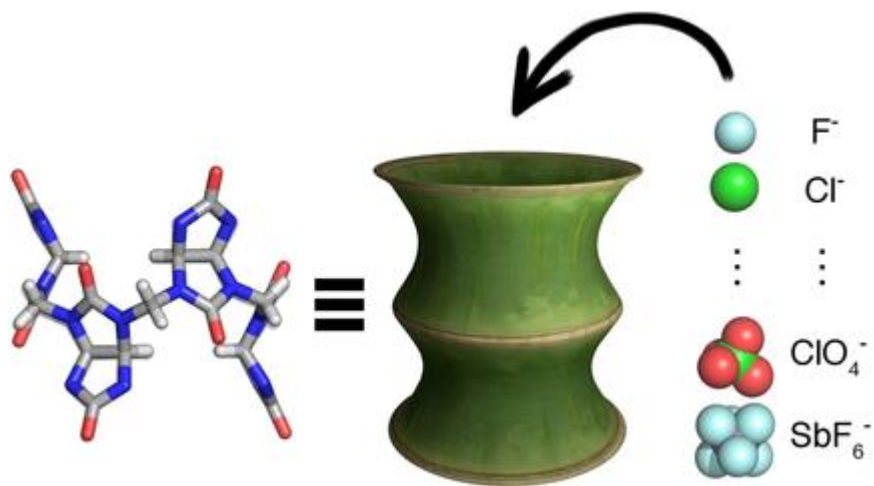

Bile acid as scaffold of unsymmetric chiral ligands

- Enterohepatic circulation, transmembrane transport activity

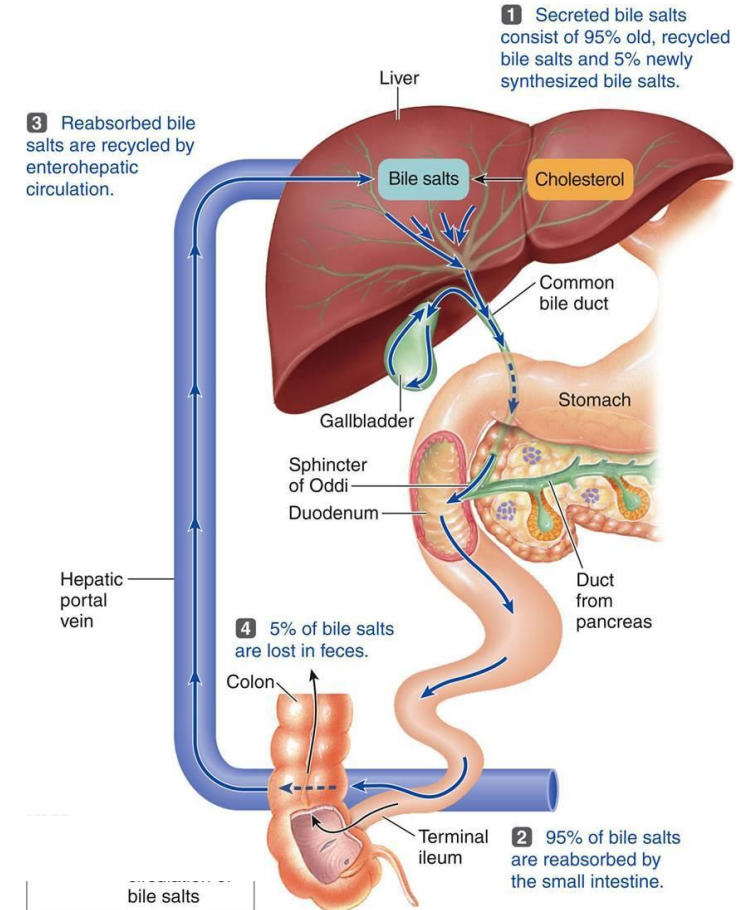
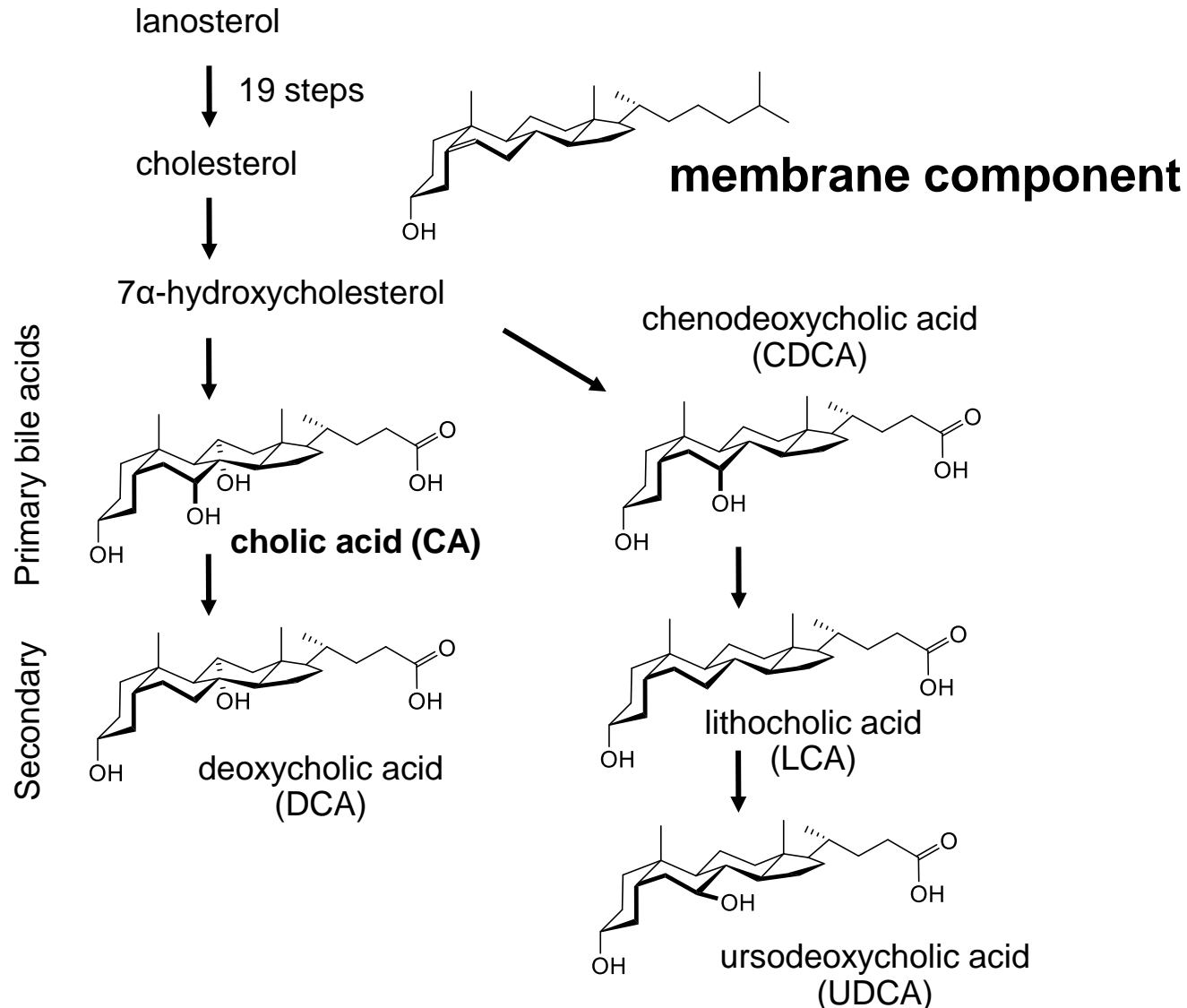

Common core molecular scaffolds - cholapods

- Anion podand-type receptors based on bile acid scaffold
- Bile acids provide high degree of rigidity, chirality for possible chiral resolution, but also affinity towards cellular membrane

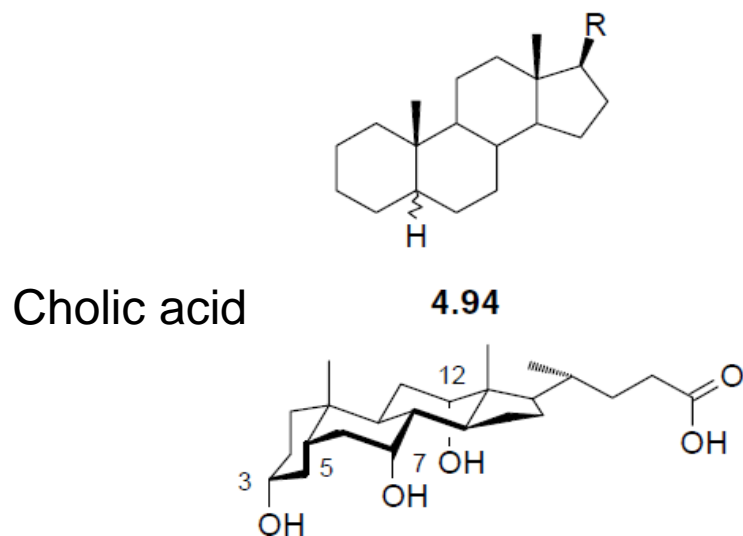

1st rigid cholapod

Cl⁻ binding in chloroform is 92,000 M⁻¹

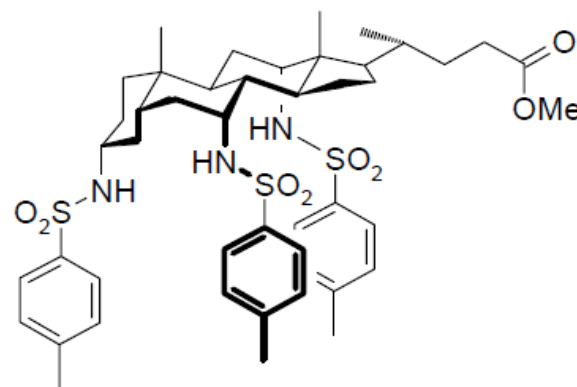

Cholapods

- Anion podand-type receptors based on bile acid scaffold
- Bile acids provide high degree of rigidity, chirality for possible chiral resolution, but also affinity towards cellular membrane

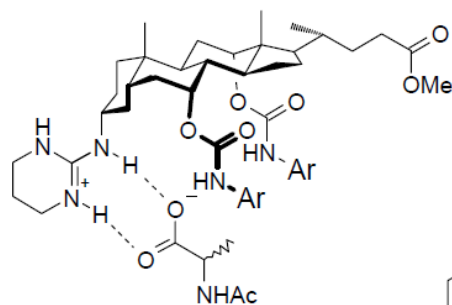

4.98

(with chiral amino acid derived guest)

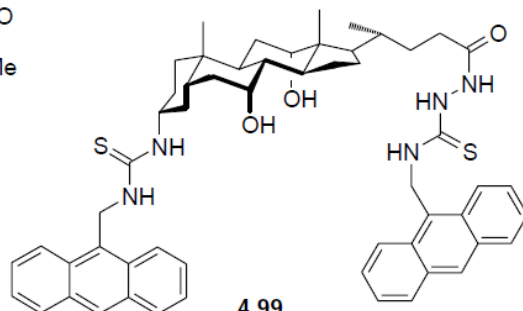

4.99

4.99: glutamate, $K_a = 6 \times 10^6 \text{ M}^{-1}$ in the competitive MeOH/water 1:1

4.100: 3320, 990 and 250 M^{-1} to fluoride, chloride and bromide

4.101a: selective to Cl^- ; **4.101b:** selective to acetate

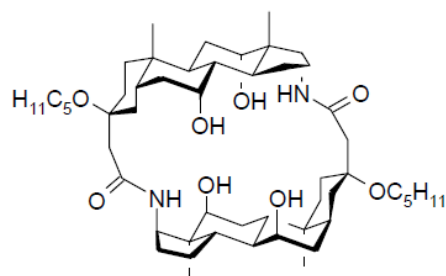

4.100

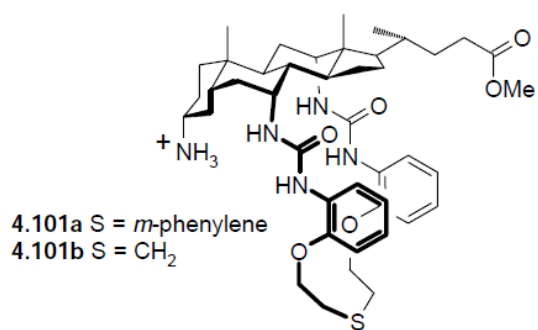

4.101a S = *m*-phenylene

4.101b S = CH_2

Cholapods

- Anion podand-type receptors based on bile acid scaffold

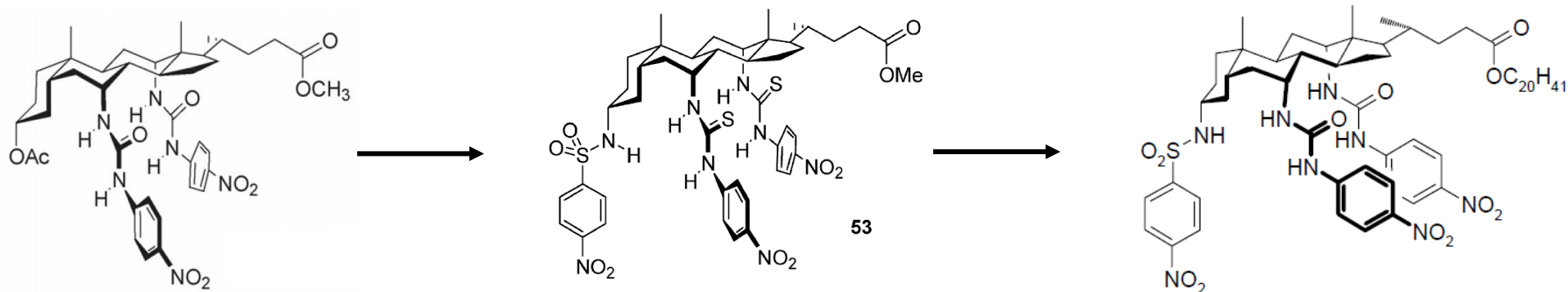

$$K_a (\text{Cl}^-, \text{CHCl}_3) = 5.2 \cdot 10^8 \text{ M}^{-1}$$

$$K_a (\text{Cl}^-, \text{CHCl}_3) = 10^{11} \text{ M}^{-1}$$

$$K_a (\text{Cl}^-, \text{CHCl}_3) = 10^{11} \text{ M}^{-1}$$

efficient chloride transporter!

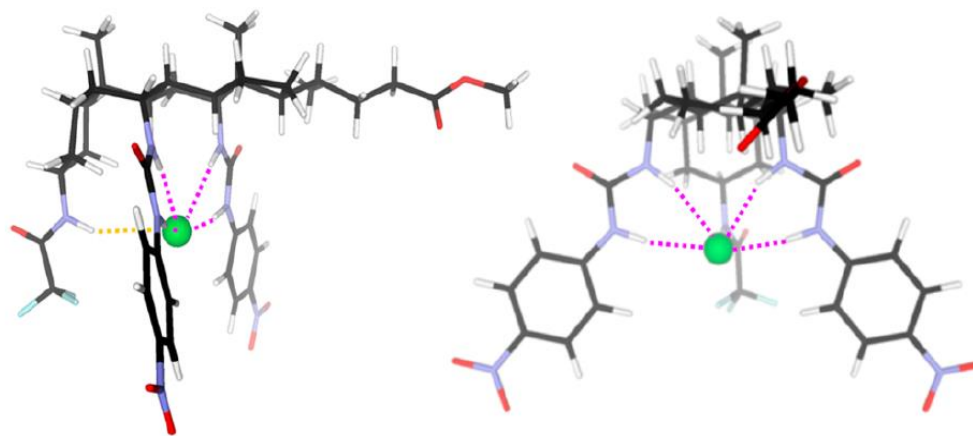

Cholapods and steroid-inspired *trans*-decalins

- Anion podand-type receptors based on bile acid scaffold
- Changing an ester side-chain in this new system revealed a surprising effect, whereby increased length and/or lipophilicity resulted in substantially raised activity

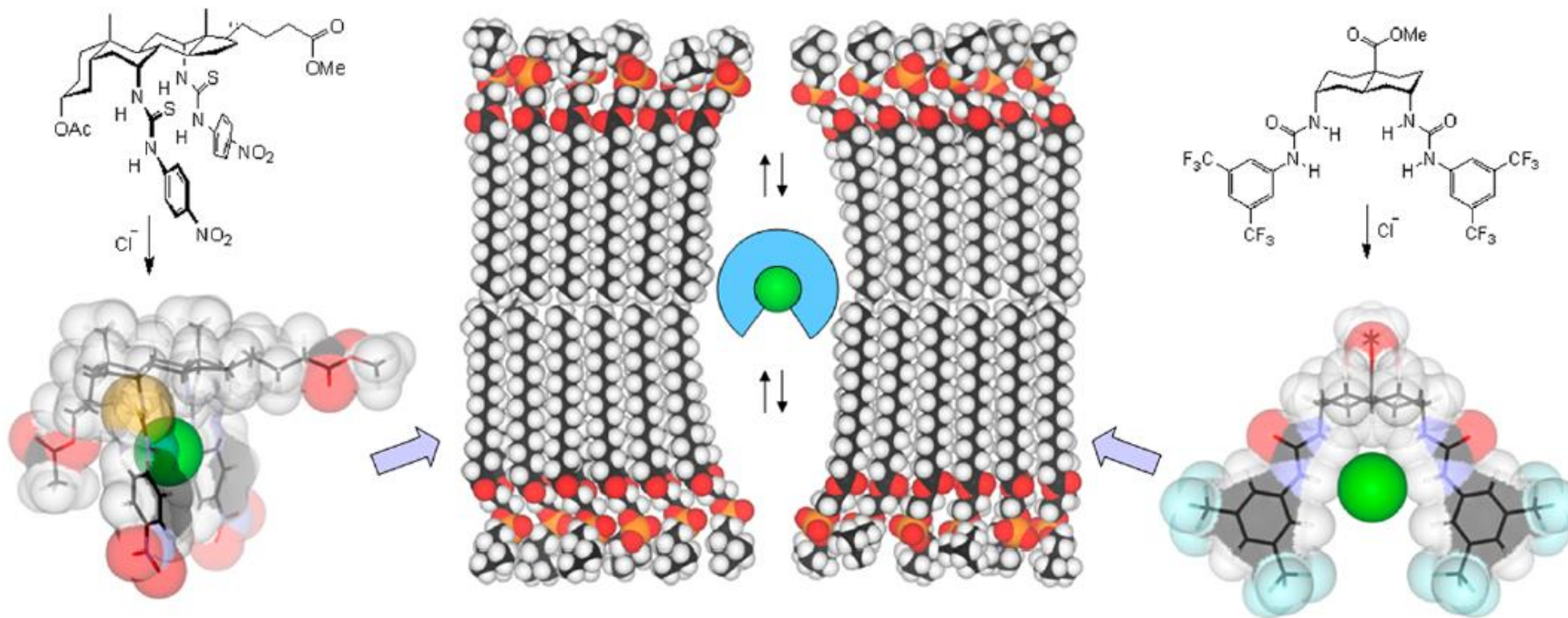

Cholapods and decalins

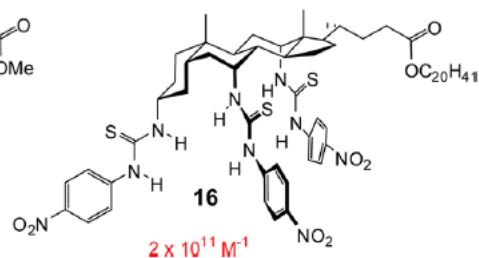
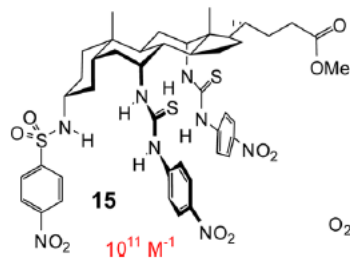
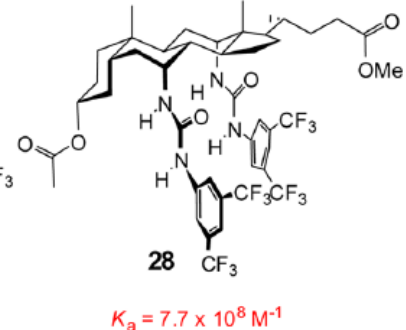
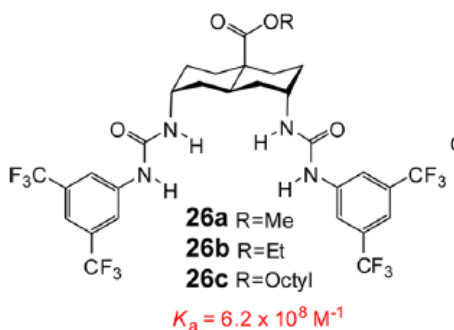
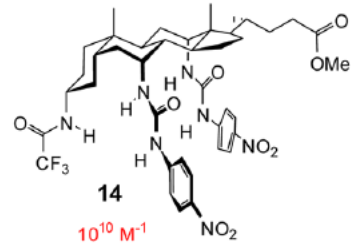
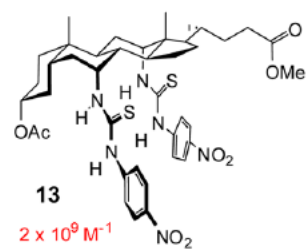
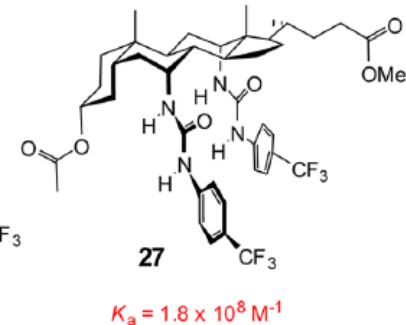
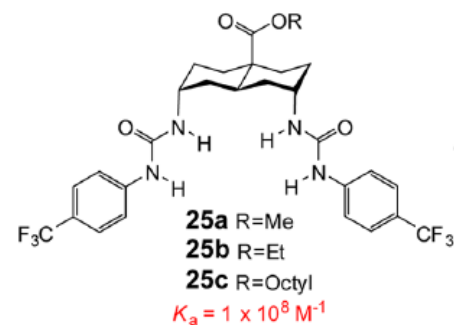
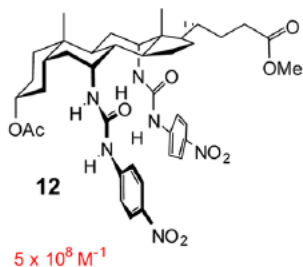
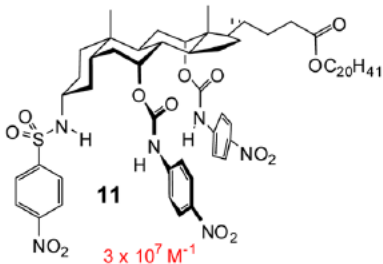
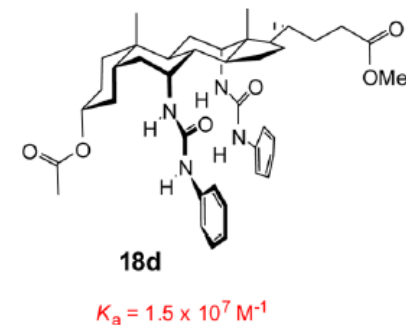
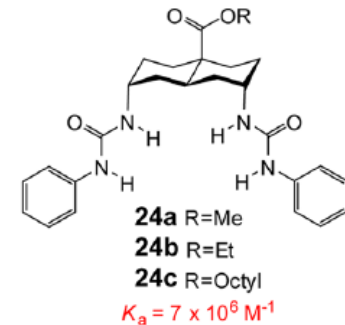
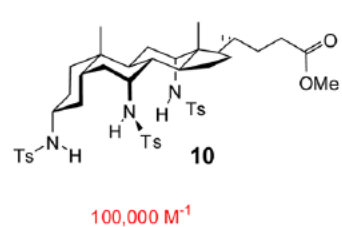
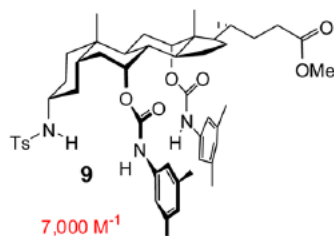

The most potent artificial anion transporter (anionophore)

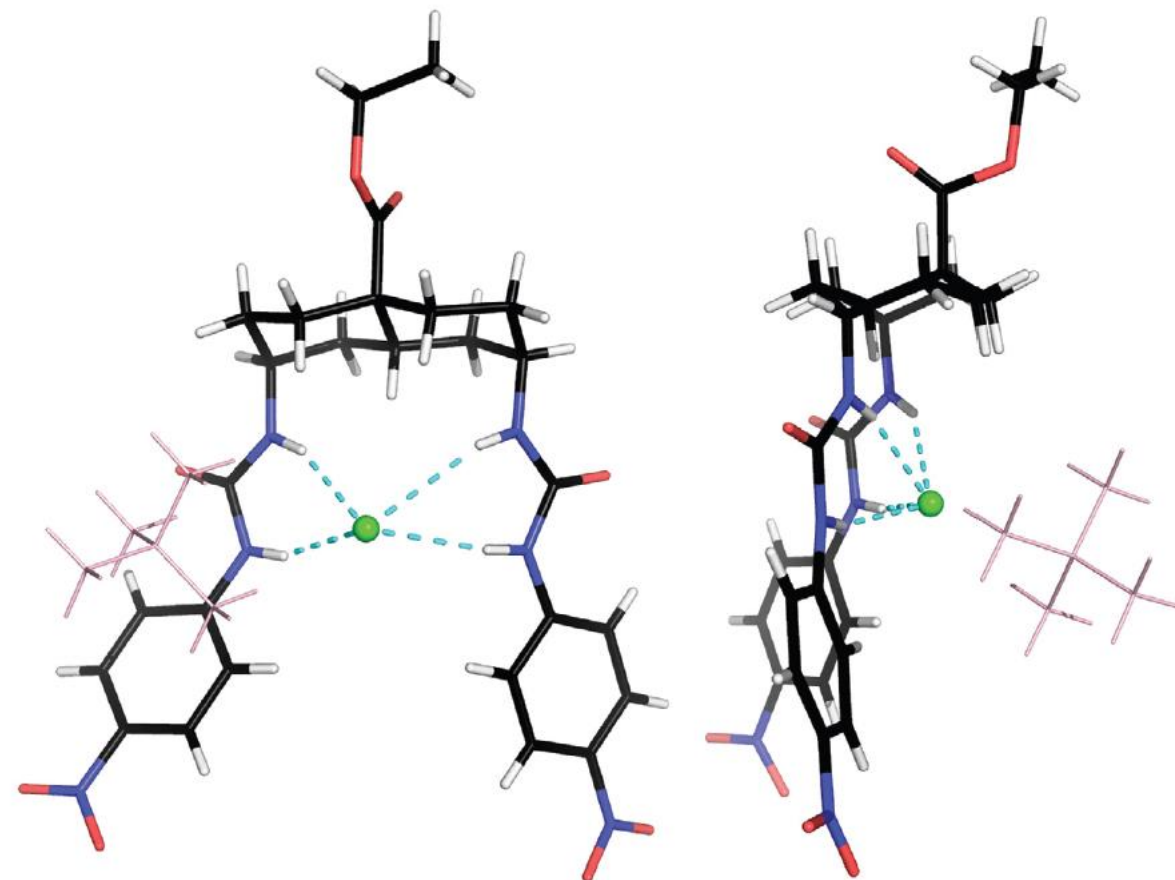
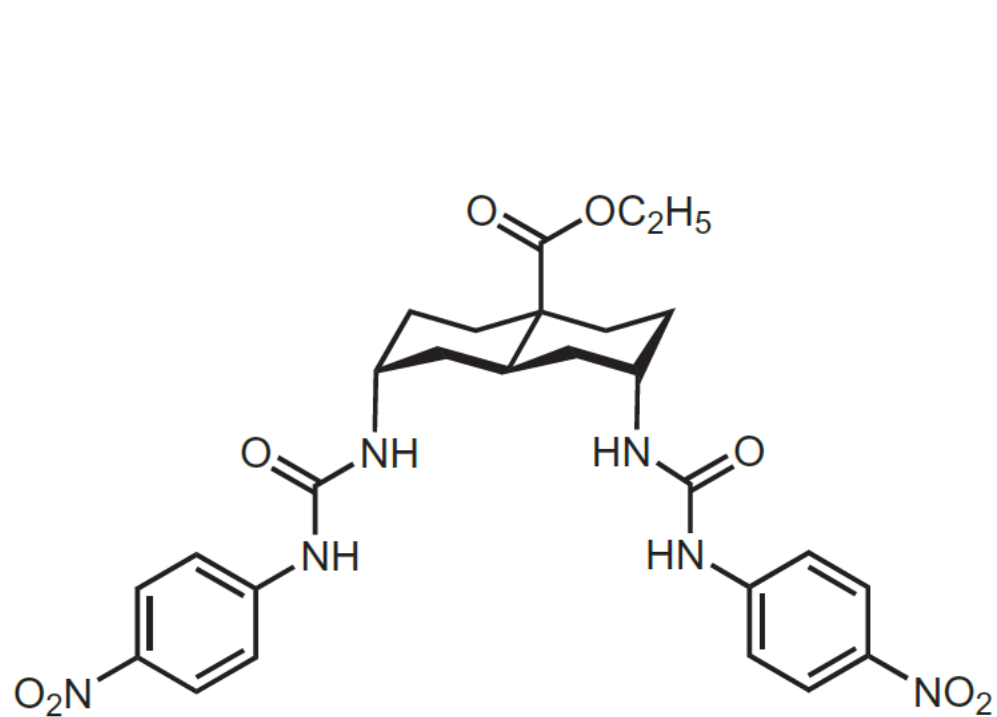

Anionophores

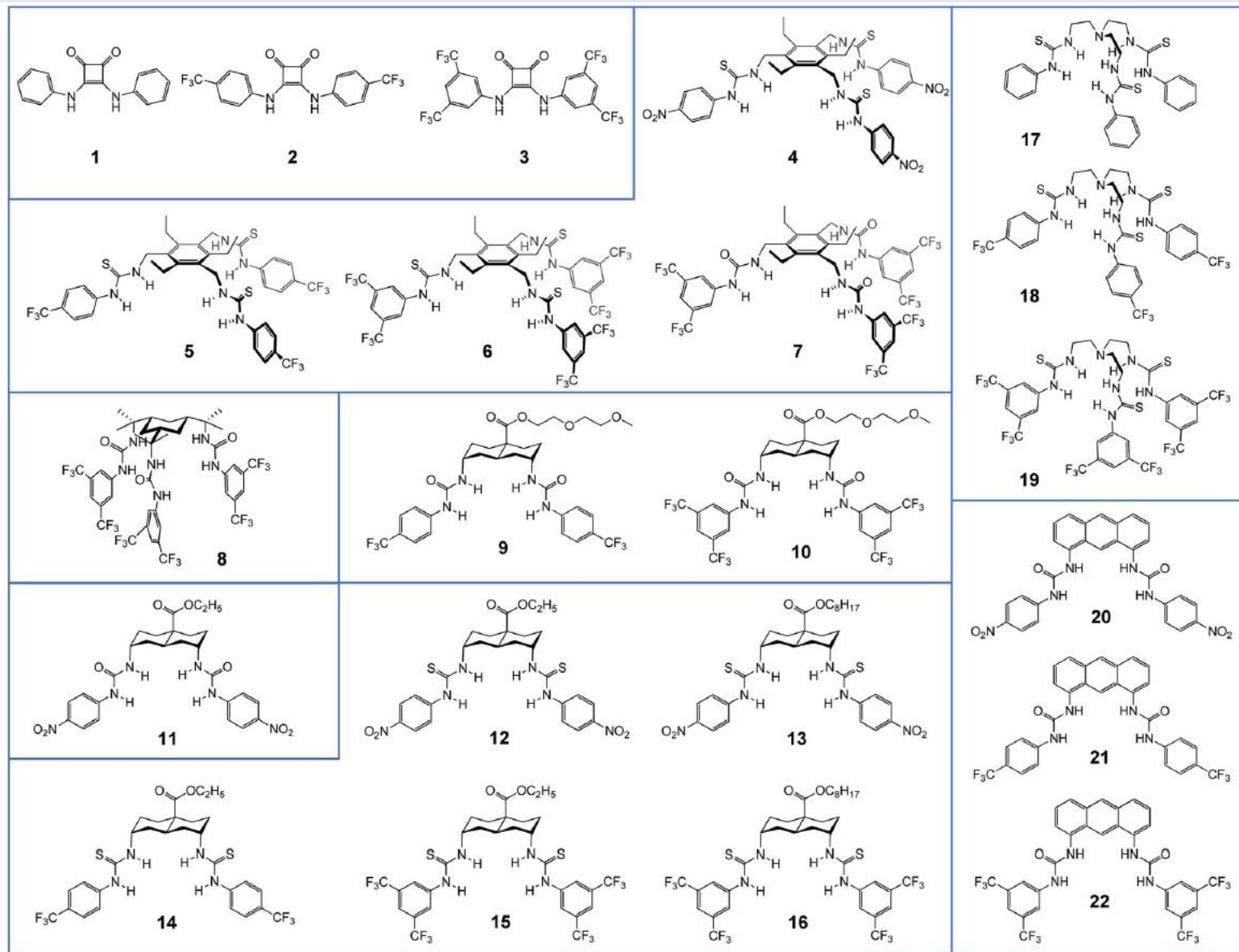

Anionophores

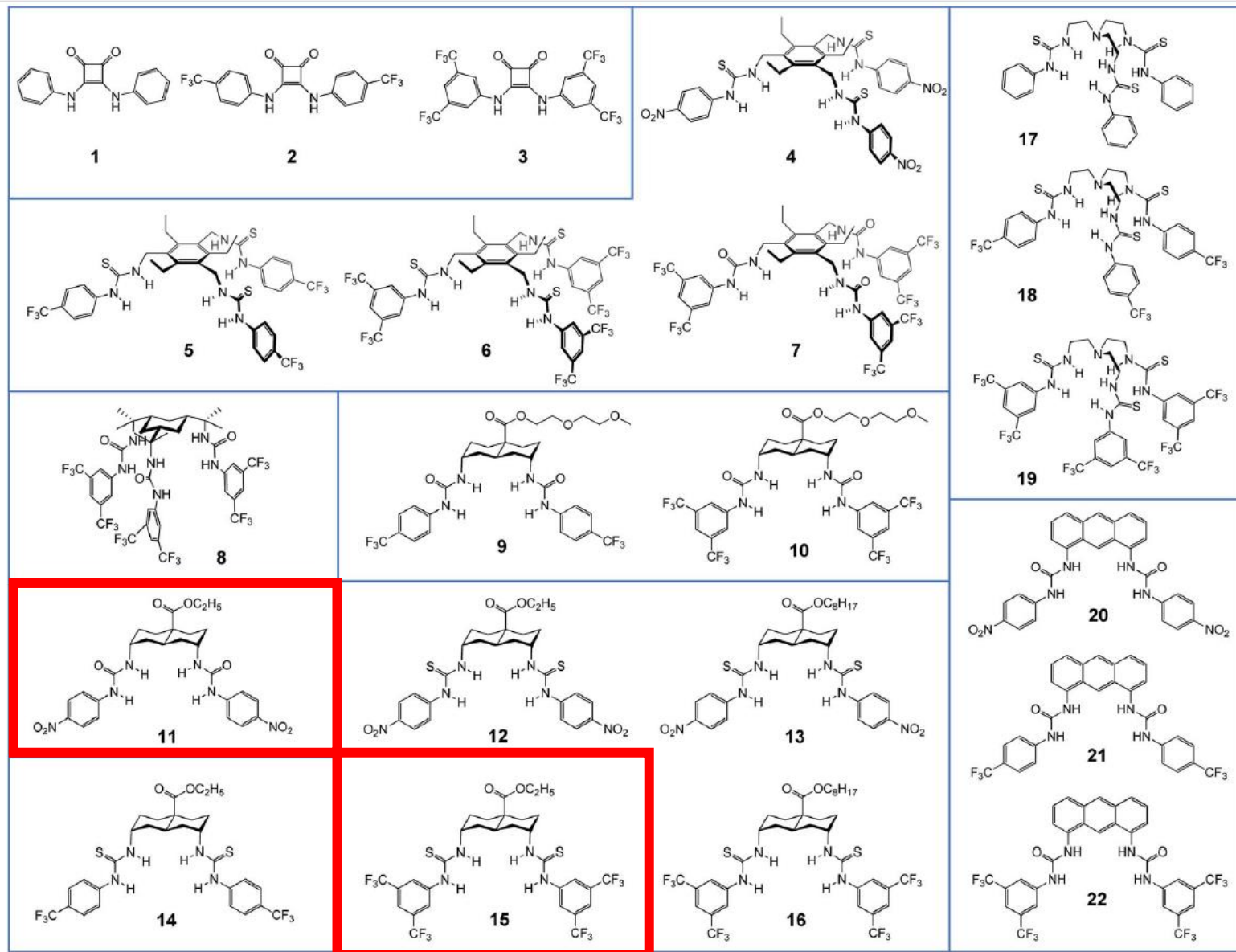

Cystic fibrosis

- inherited disorder that causes severe damage to the lungs, digestive system and other organs in the body
- no functional copies (alleles) of the gene cystic fibrosis transmembrane conductance regulator (CFTR)
- the product of this gene (the CFTR protein) is a chloride ion channel important in creating sweat, digestive juices, and mucus.
- it regulates flow of Cl^- and H_2O
- developing supramolecular chloride transporters to treat the conditions

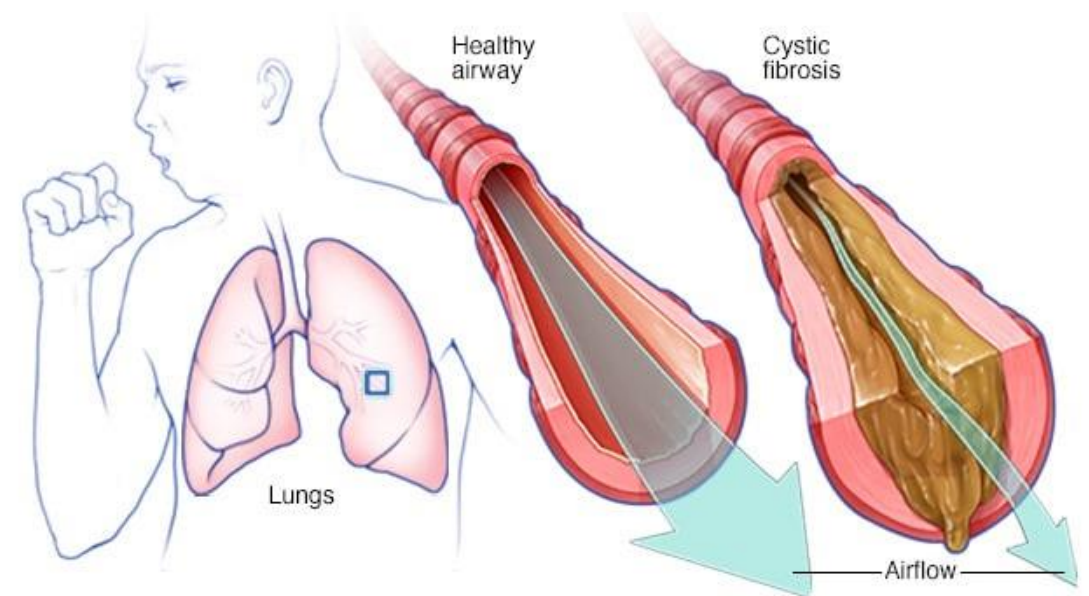
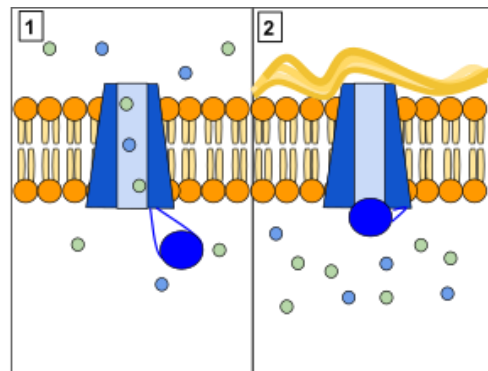

© MAYO FOUNDATION FOR MEDICAL EDUCATION AND RESEARCH. ALL RIGHTS RESERVED.

Current treatment for cystic fibrosis

- Generally, to suppress infections and inflammatory processes: antibiotics, corticosteroids
- For several specific mutations (4–5% cases): FDA approved ivacaftor (2012) or combinations with lumacaftor (2015), tezacaftor (2018), elexacaftor (2019)
- EMA approved Kaftrio = iva-, teza-, and elexacaftor (2020)
- drugs act as a chaperone during protein folding and increase the number of CFTR proteins that are trafficked to the cell surface

ivacaftor

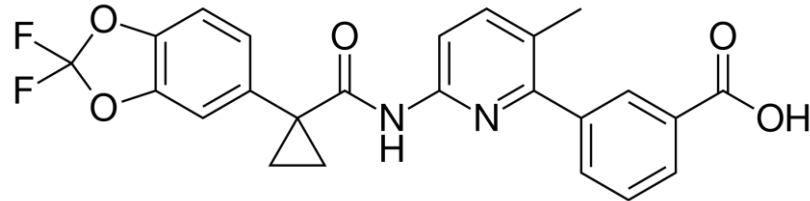
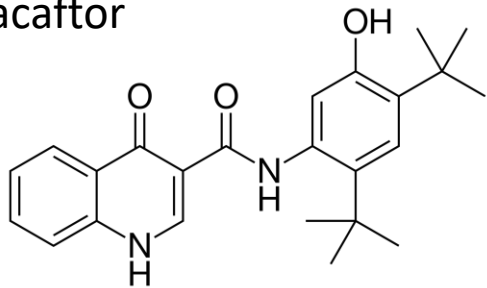

lumacaftor

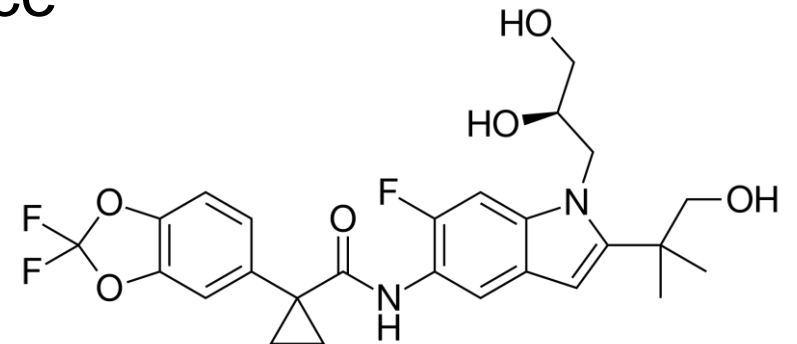

tezacaftor

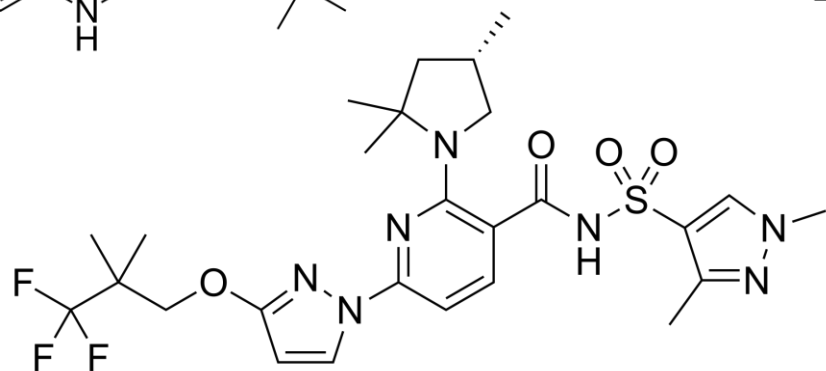

elexacaftor

Challenges in biomedical applications

- Developing efficient anionophore can bring universal solution to all mutations of cystic fibrosis
- A practical anionophore should be deliverable to cell membranes and must therefore be dispersible in water. Very high lipophilicities may therefore be counterproductive. High molecular weights are also disadvantageous, especially if one aims for orally active agents.
- For therapeutic applications, there are further challenges (e.g., delivery to relevant cell membranes, retention in membranes), but if these problems can be solved the impact would be considerable.

In the next class...

The supramolecular chemistry of life

Thank you for your attention!