

Dějiny Řecka I. seminář

6. TÉMA ŘECKÁ ARCHITEKTURA

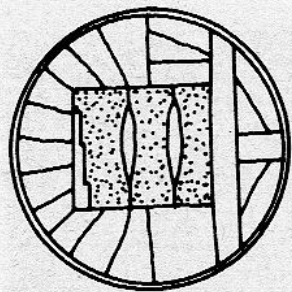

PARTHENÓN, ATHÉNY



1

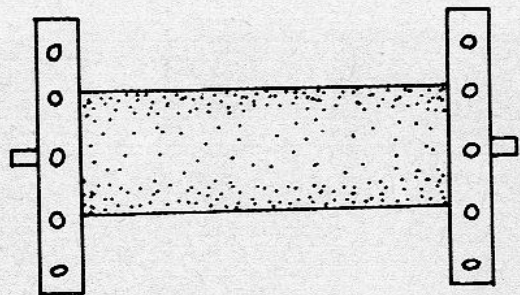

2

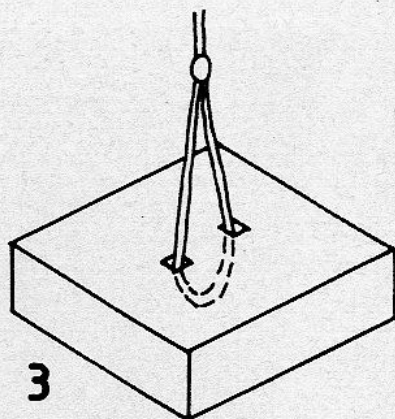

3

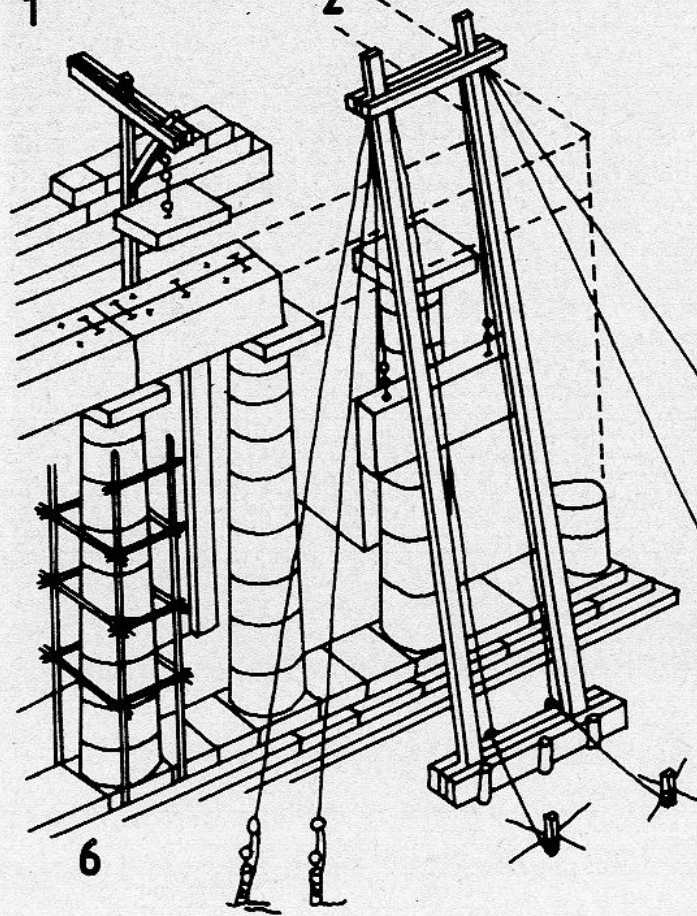

6

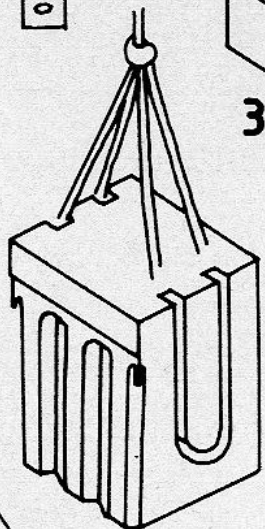

4

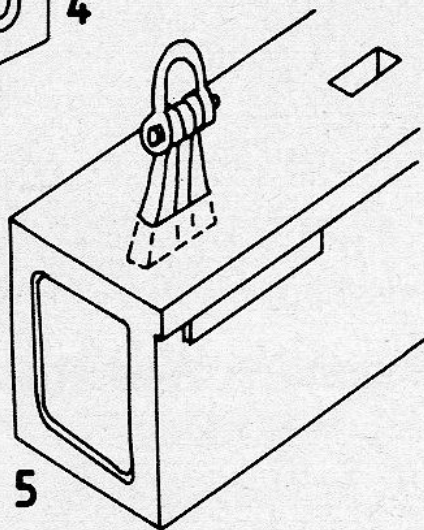

5

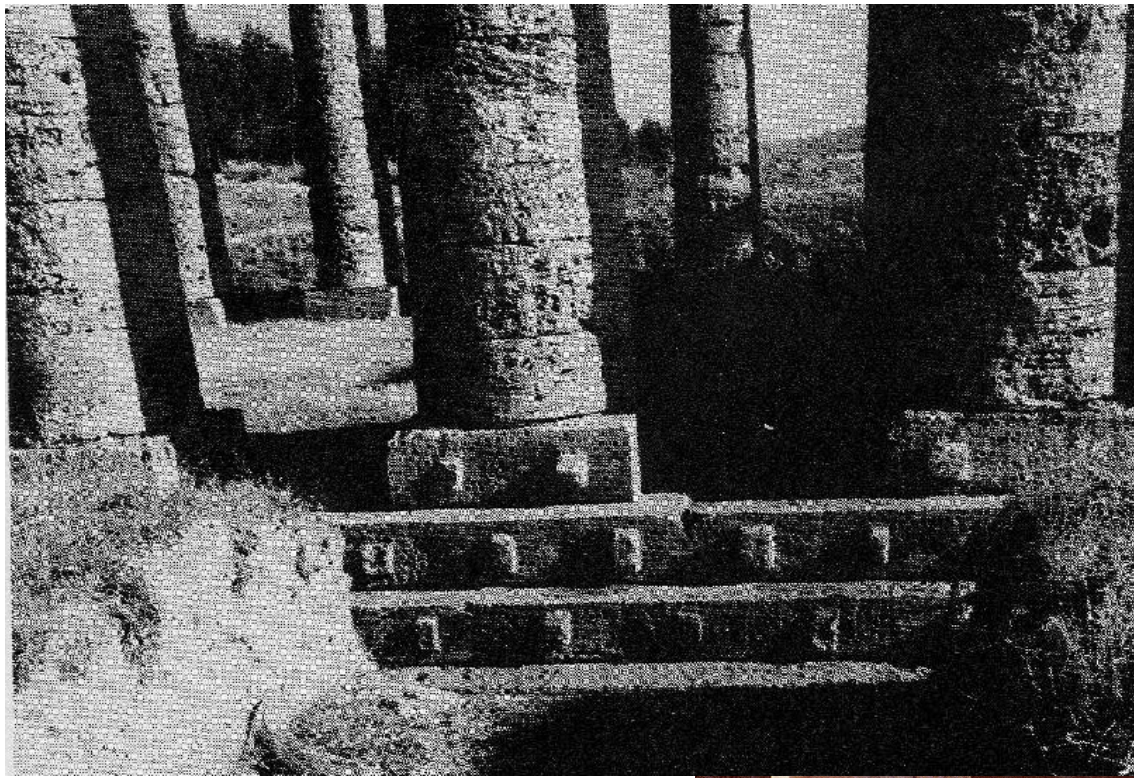

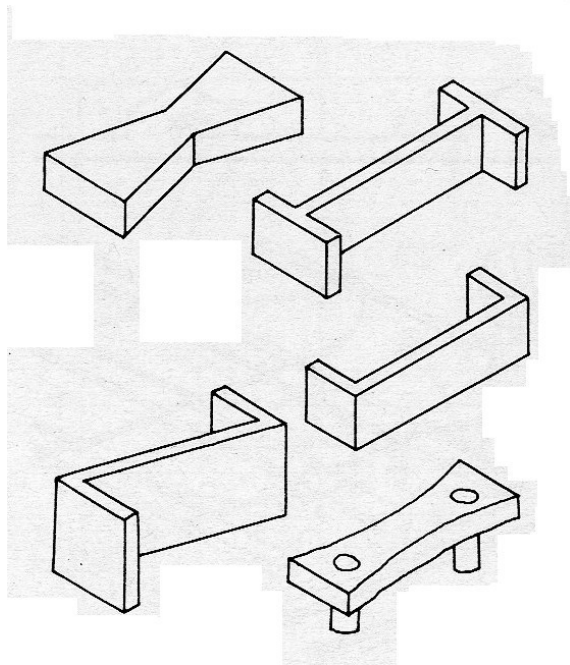
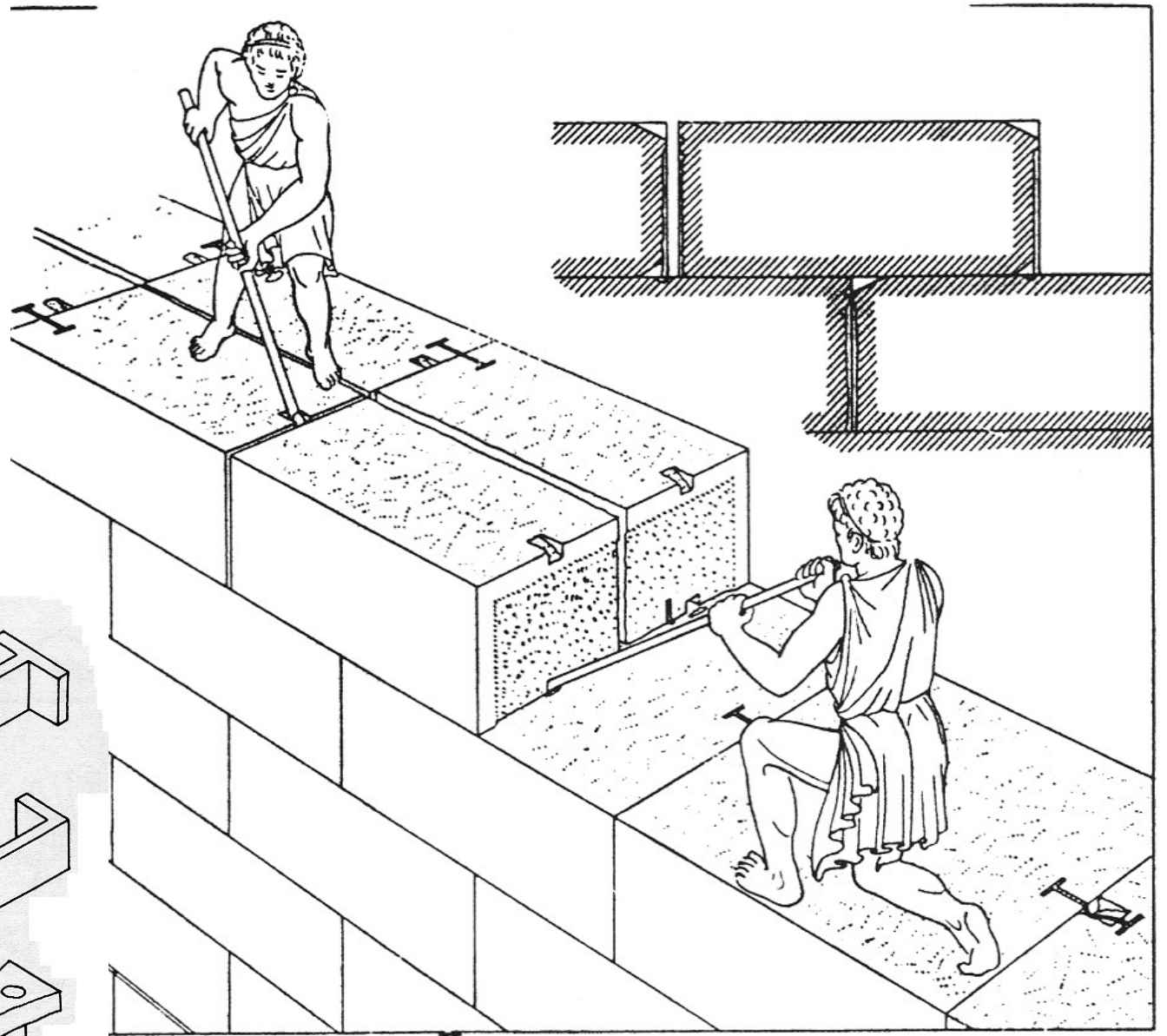

štít
střecha

kladí

sloupy
zed'

podnož

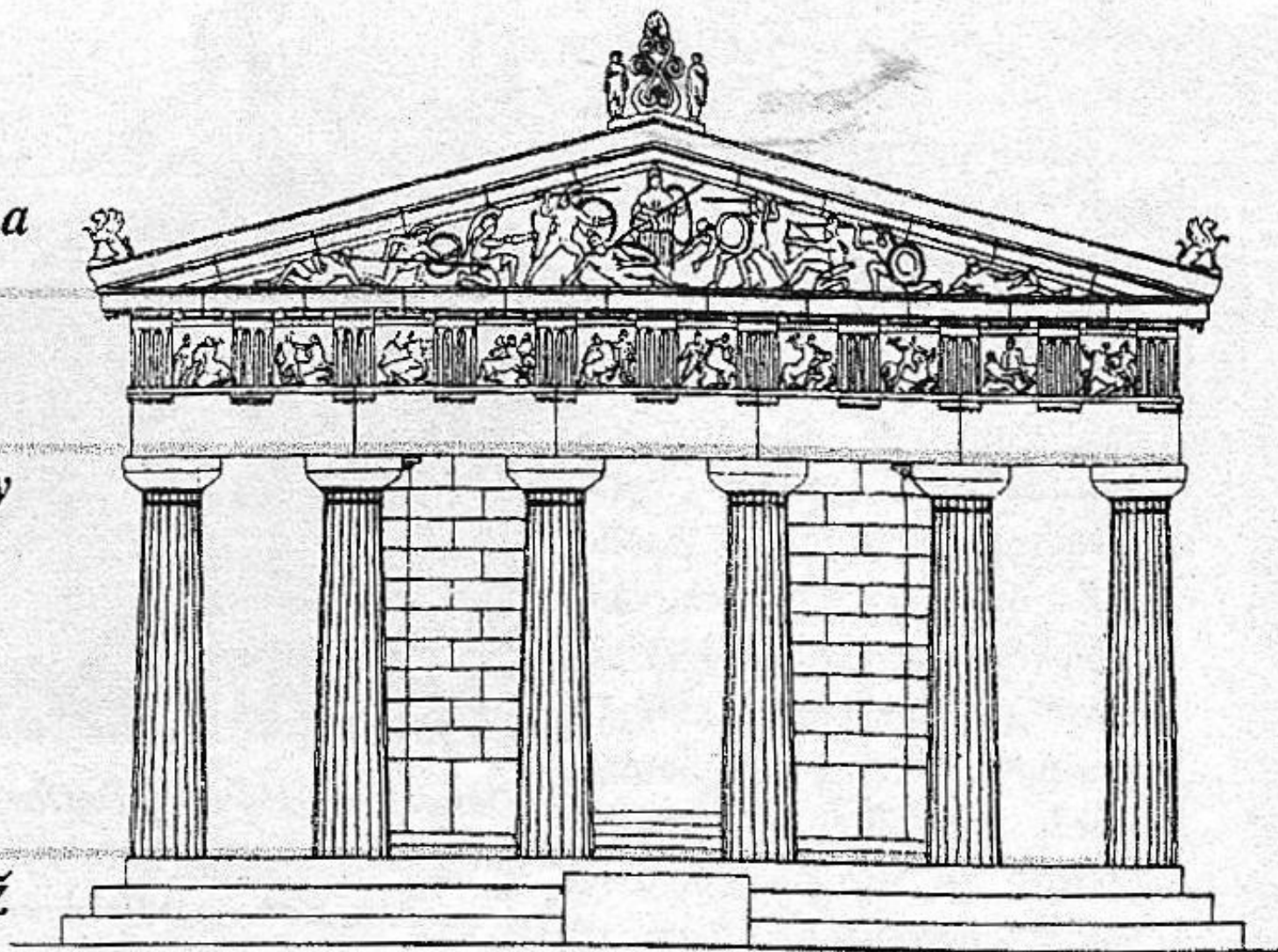

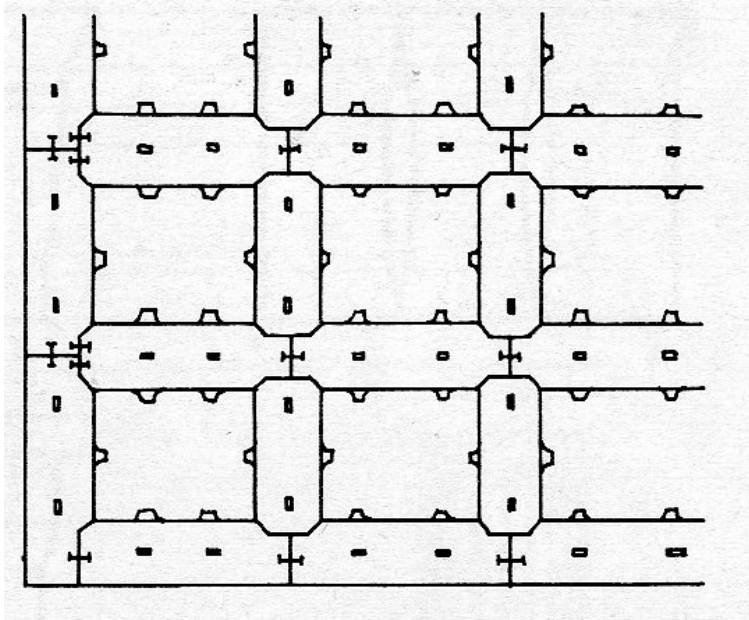
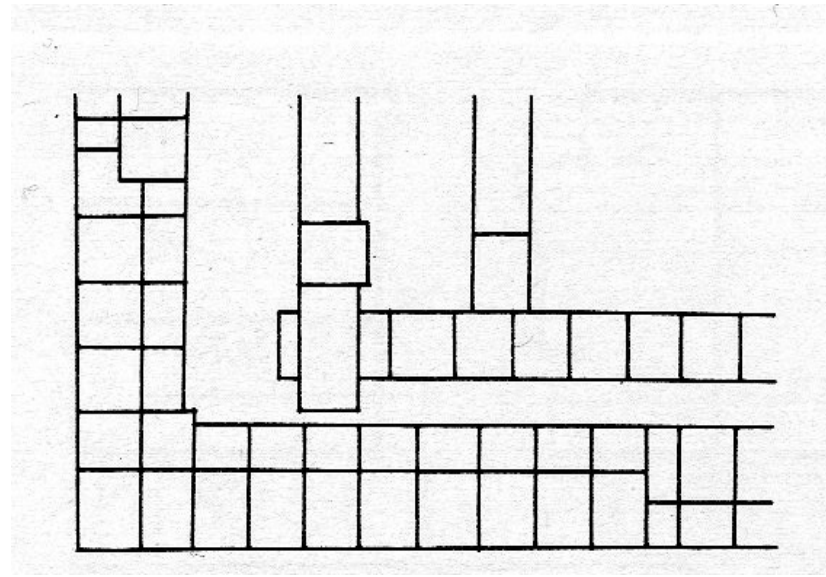
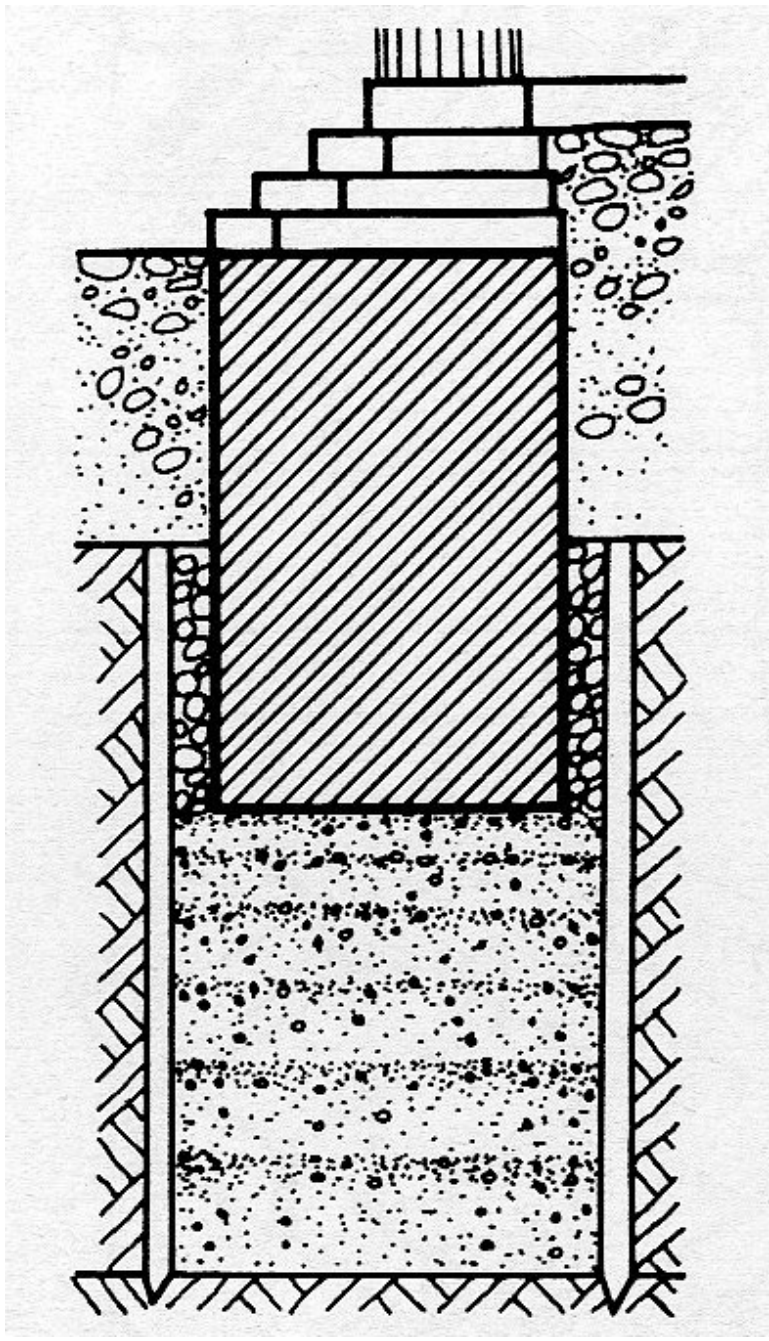

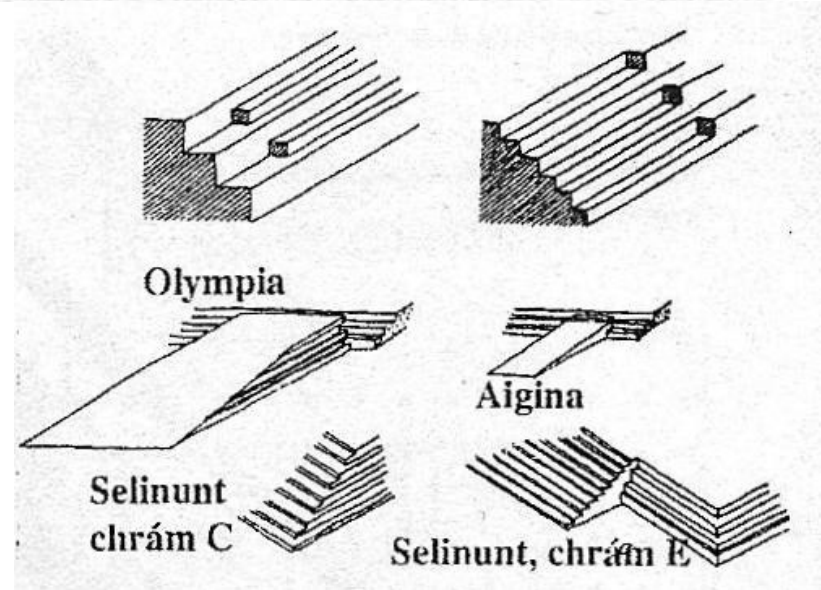
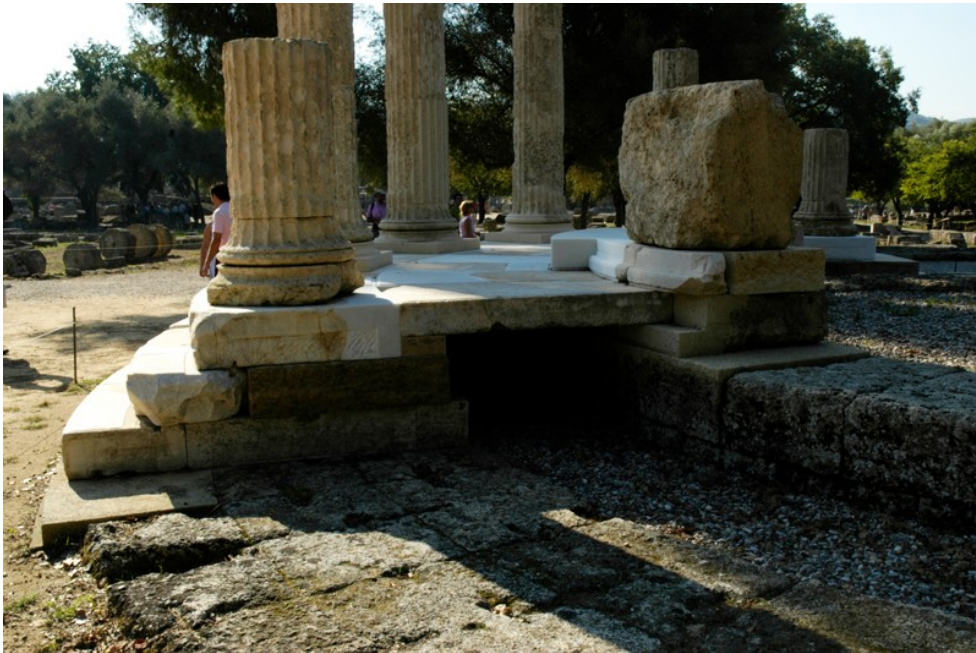
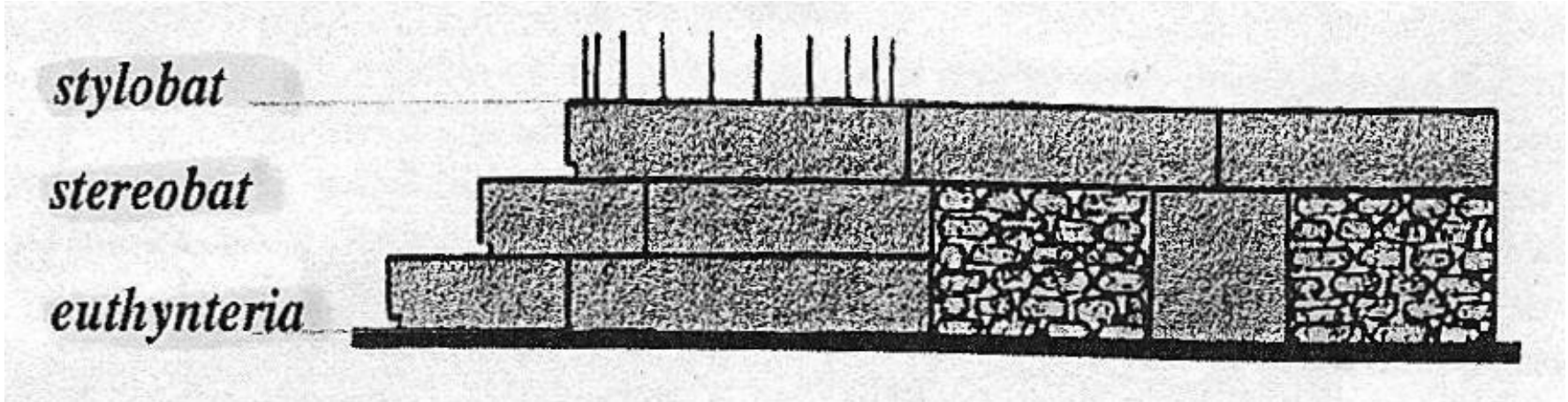



schéma vyklenutí stylobatu
(Parthenón, Athény)



Řecké enplekton.

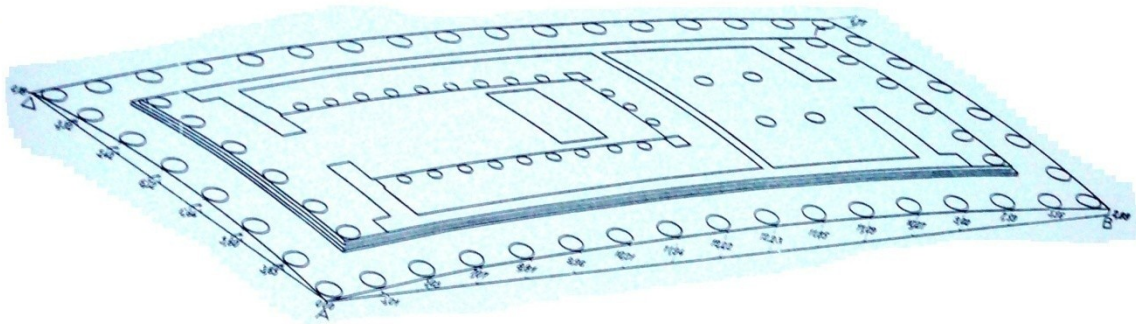
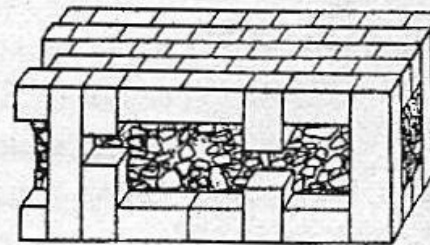
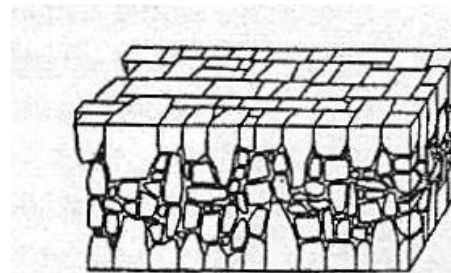
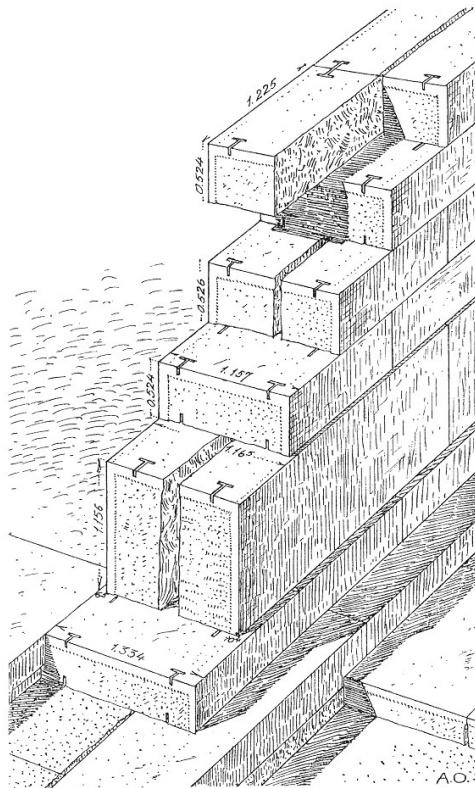
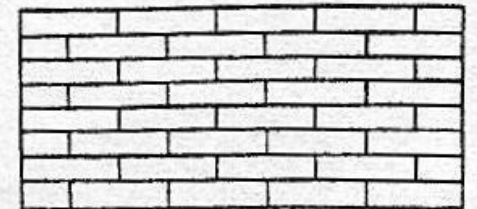

ISODOMON

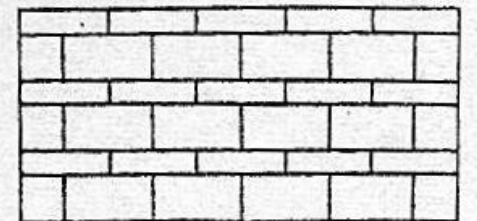

PSEUDOISODOMON

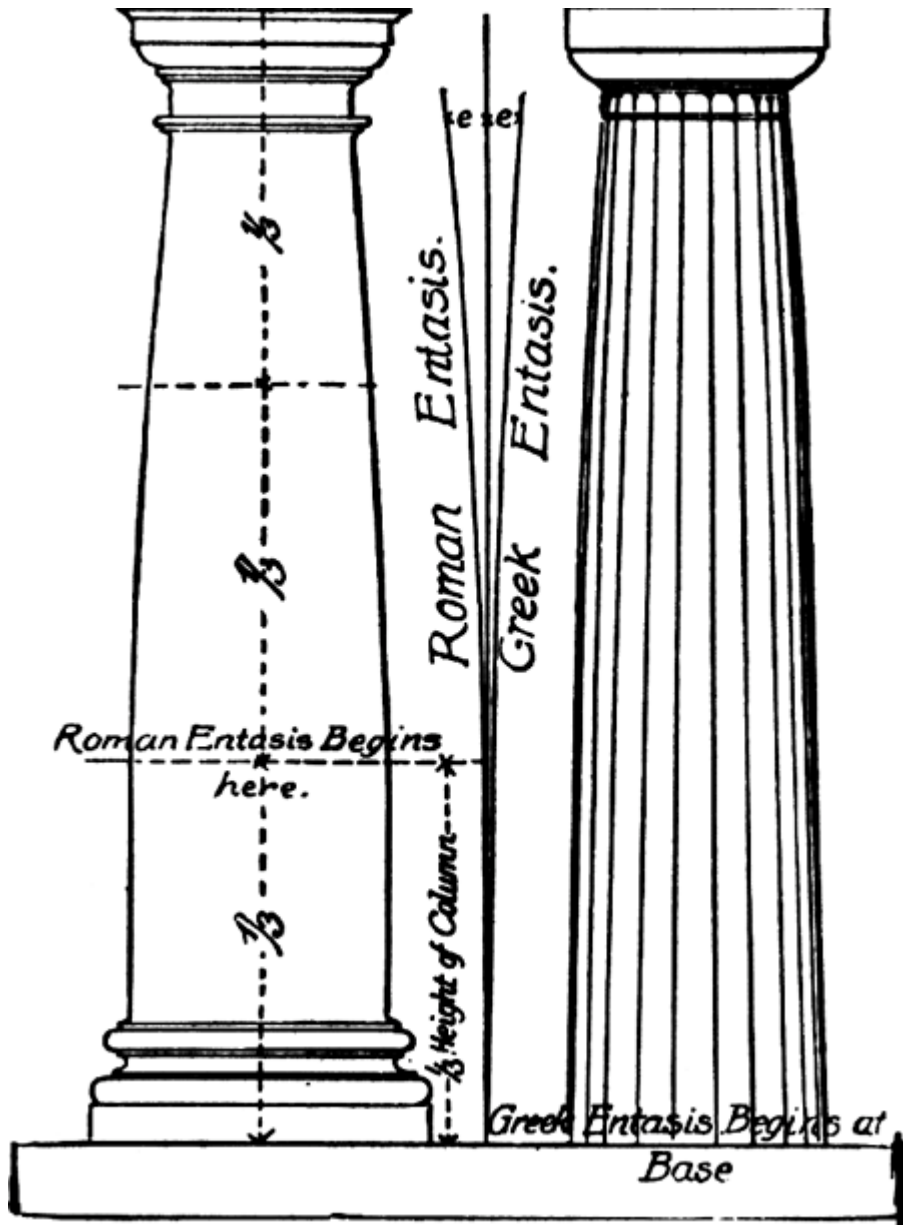

Diagram 1

The temple as it visually appears with correction

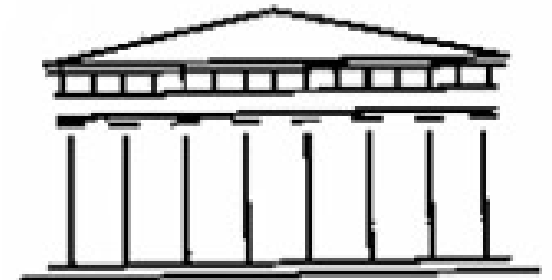

Diagram 2

The temple as it would appear without correction

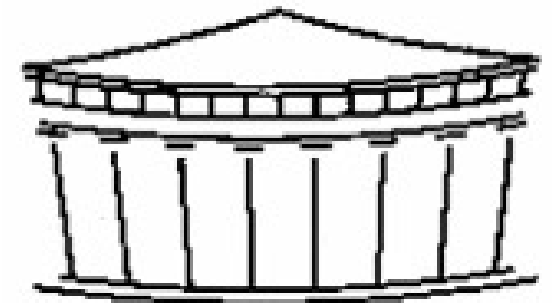
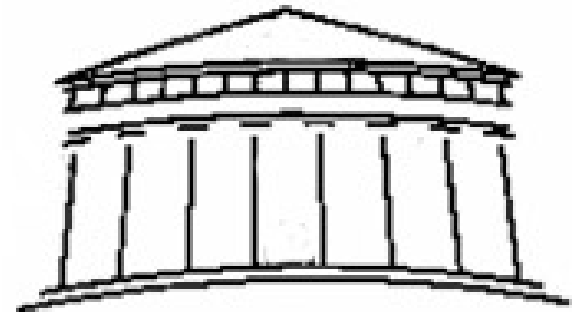
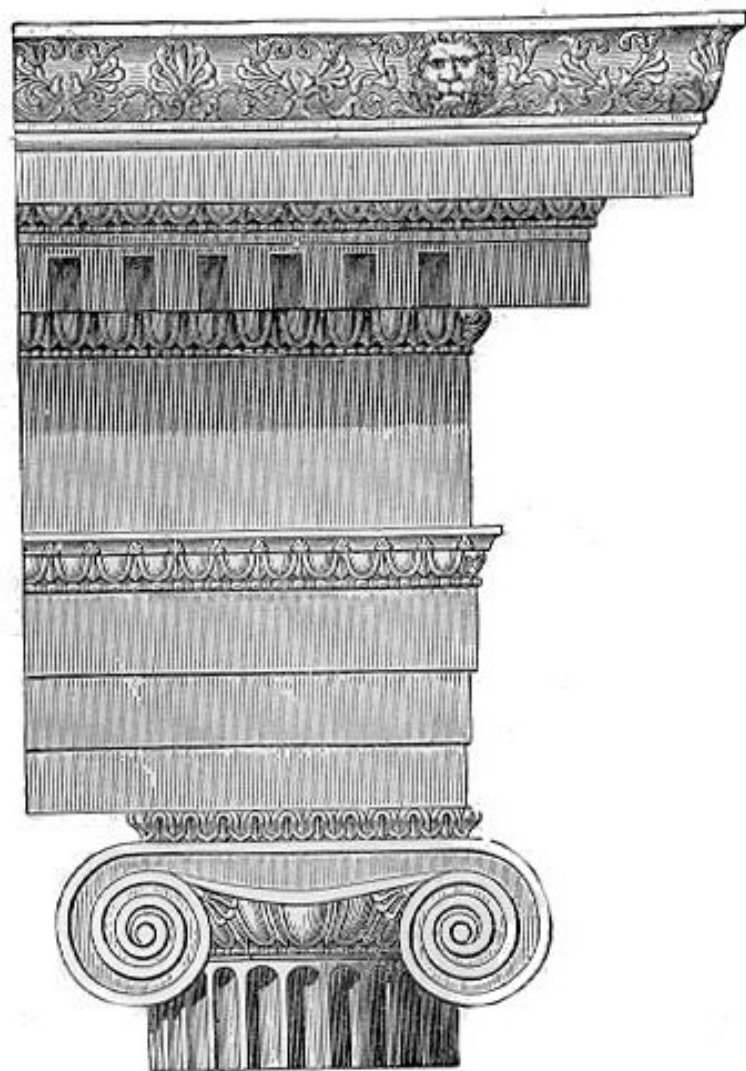
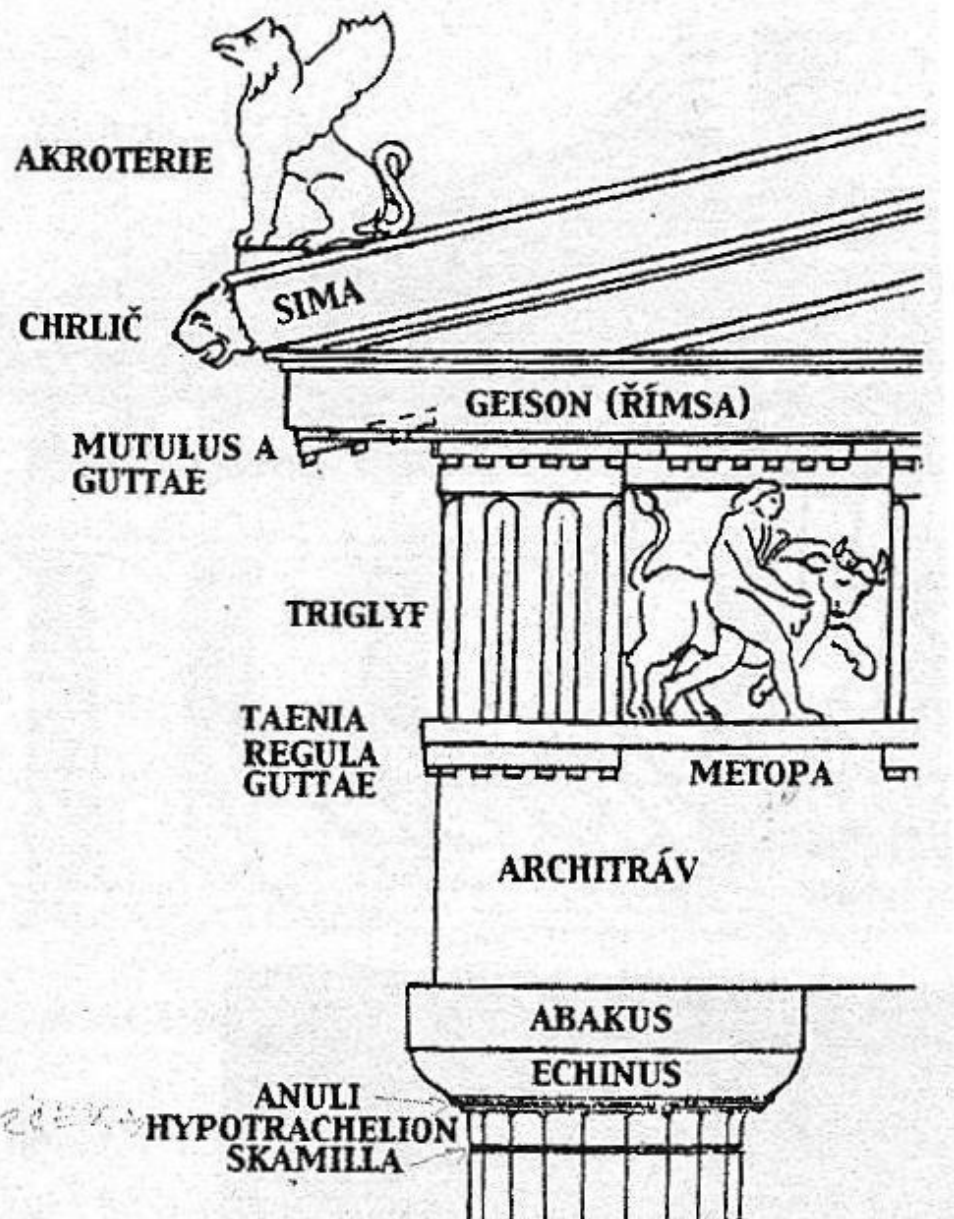

Diagram 3

The temple as it is actually built with Correction



Optical Correction (Entasis) In Doric Temples



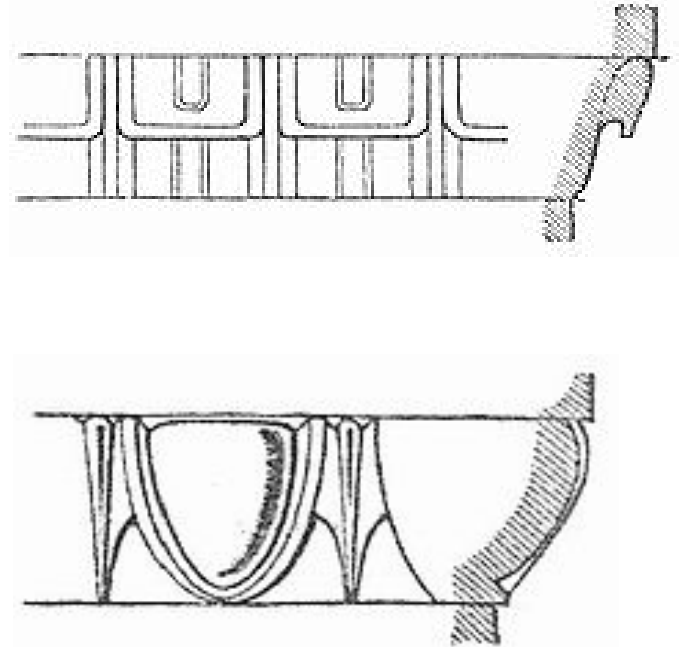
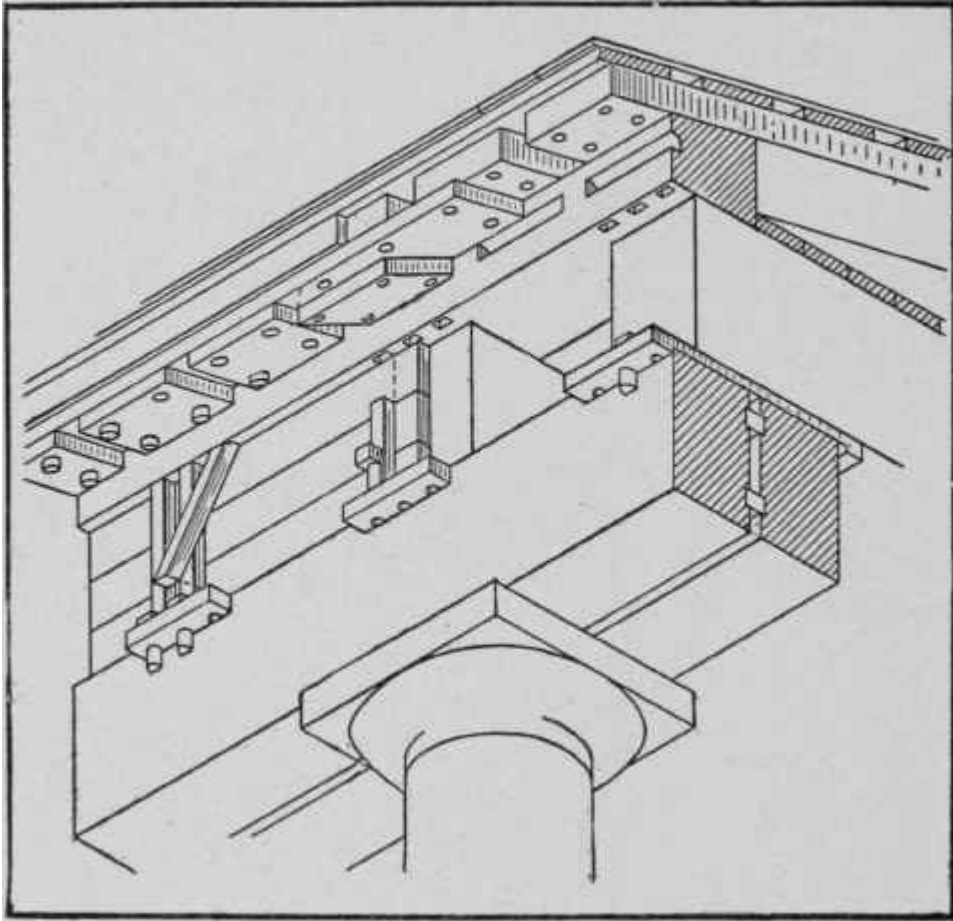
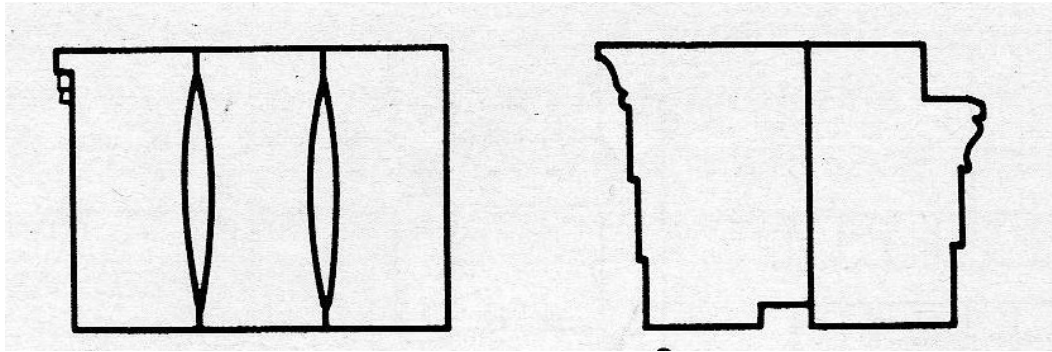

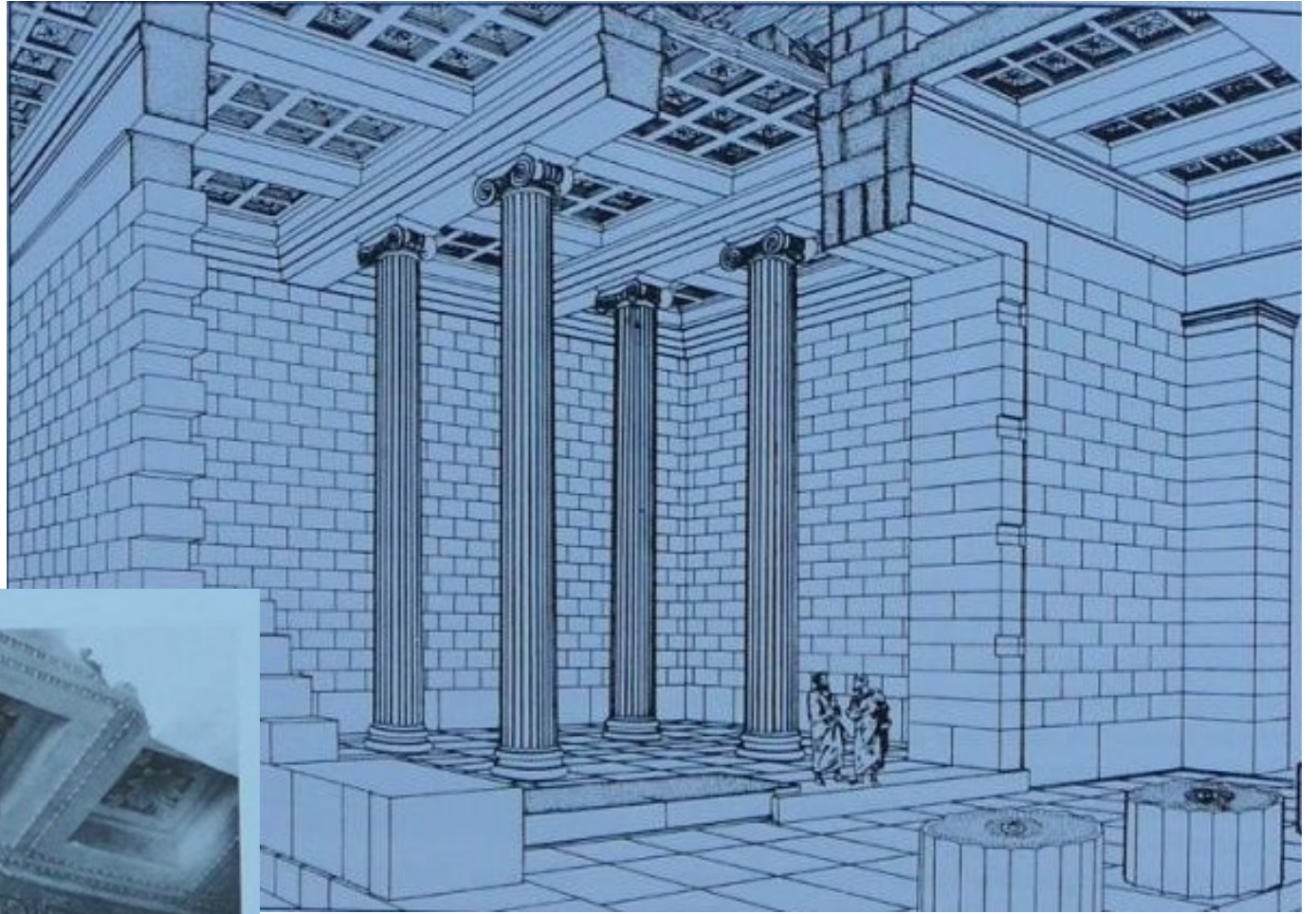

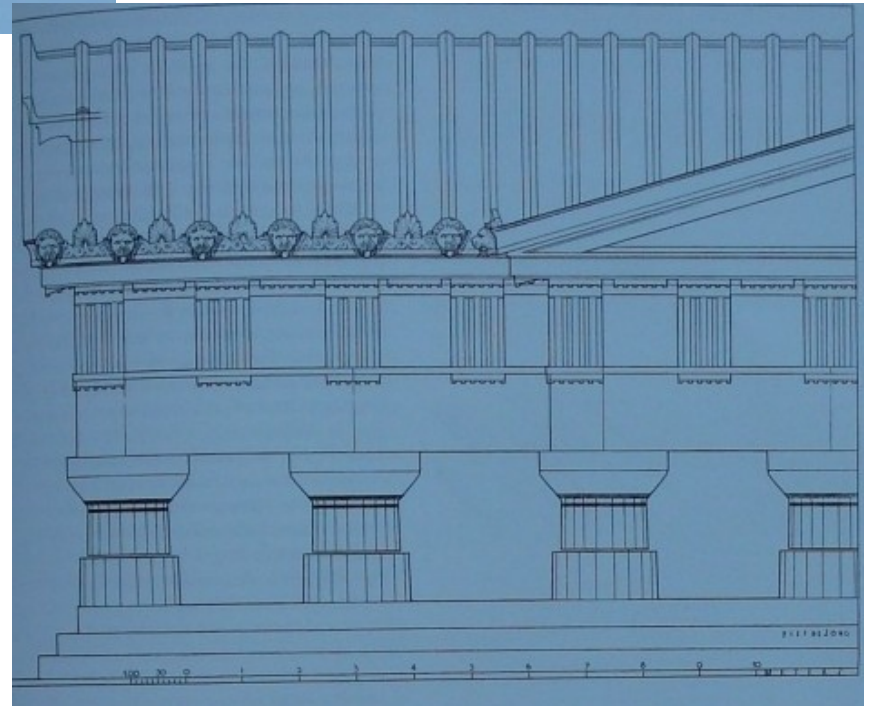
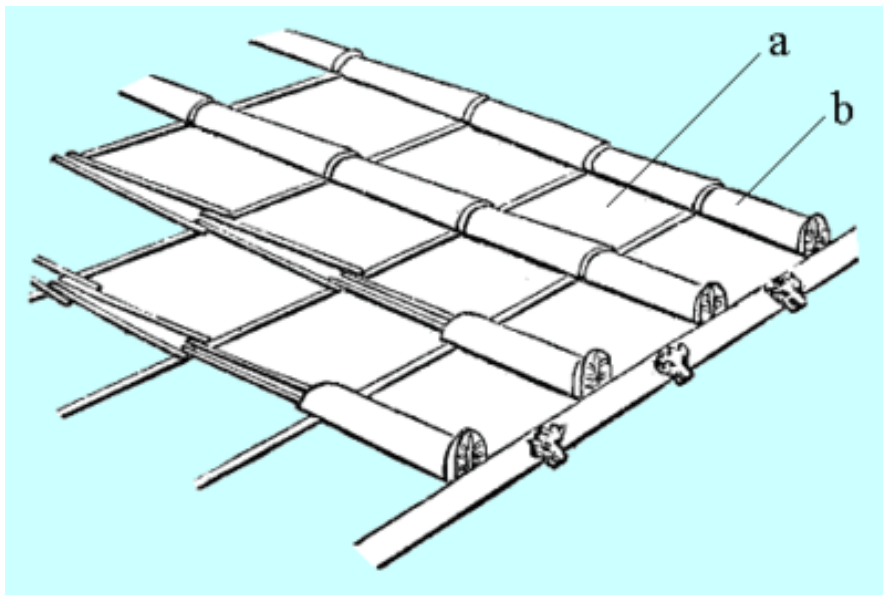
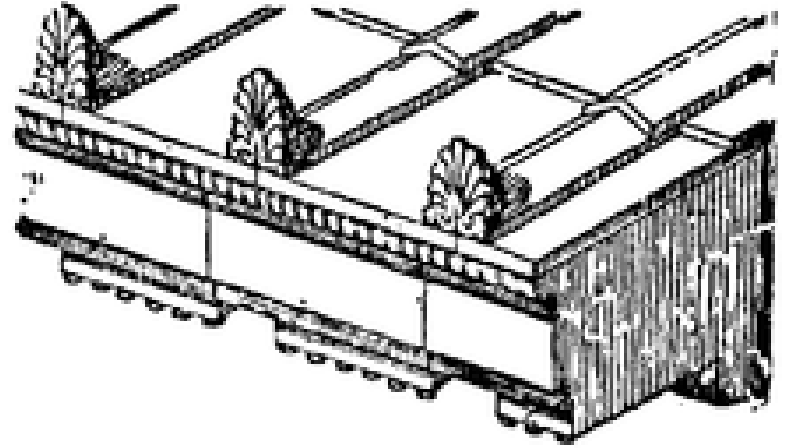
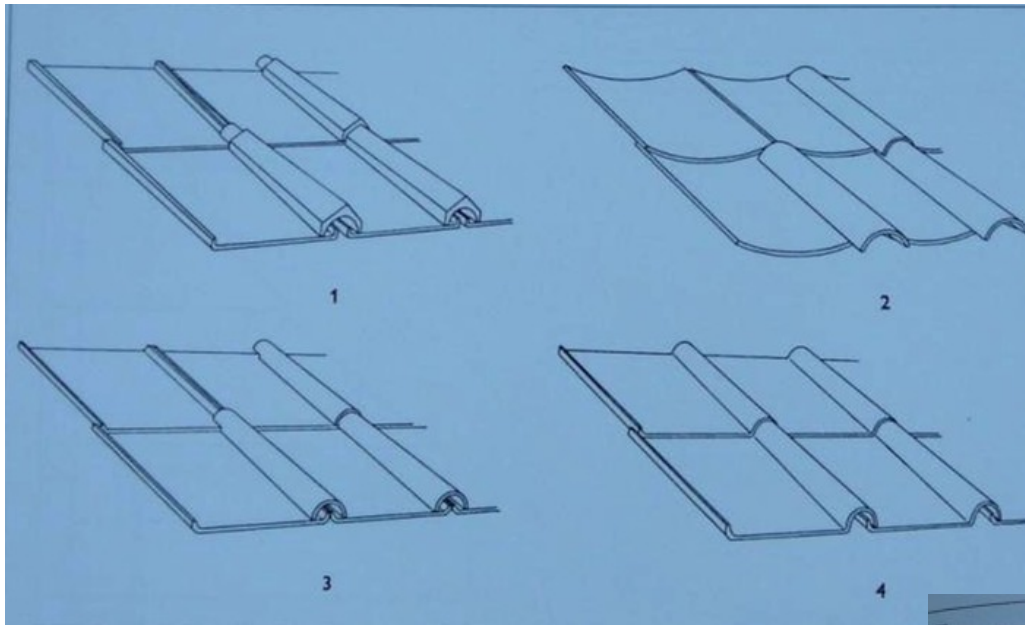



1

2



6



5



7



3



4

九



Nemea, 1:6

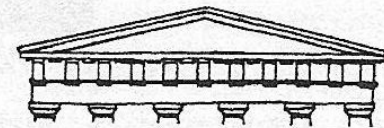

Athény, Hefaisteion 1:6

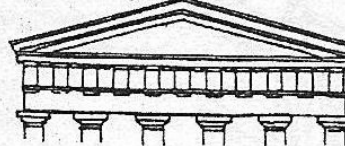

Selinunt 1:6



Athény, Parthenon 1:7

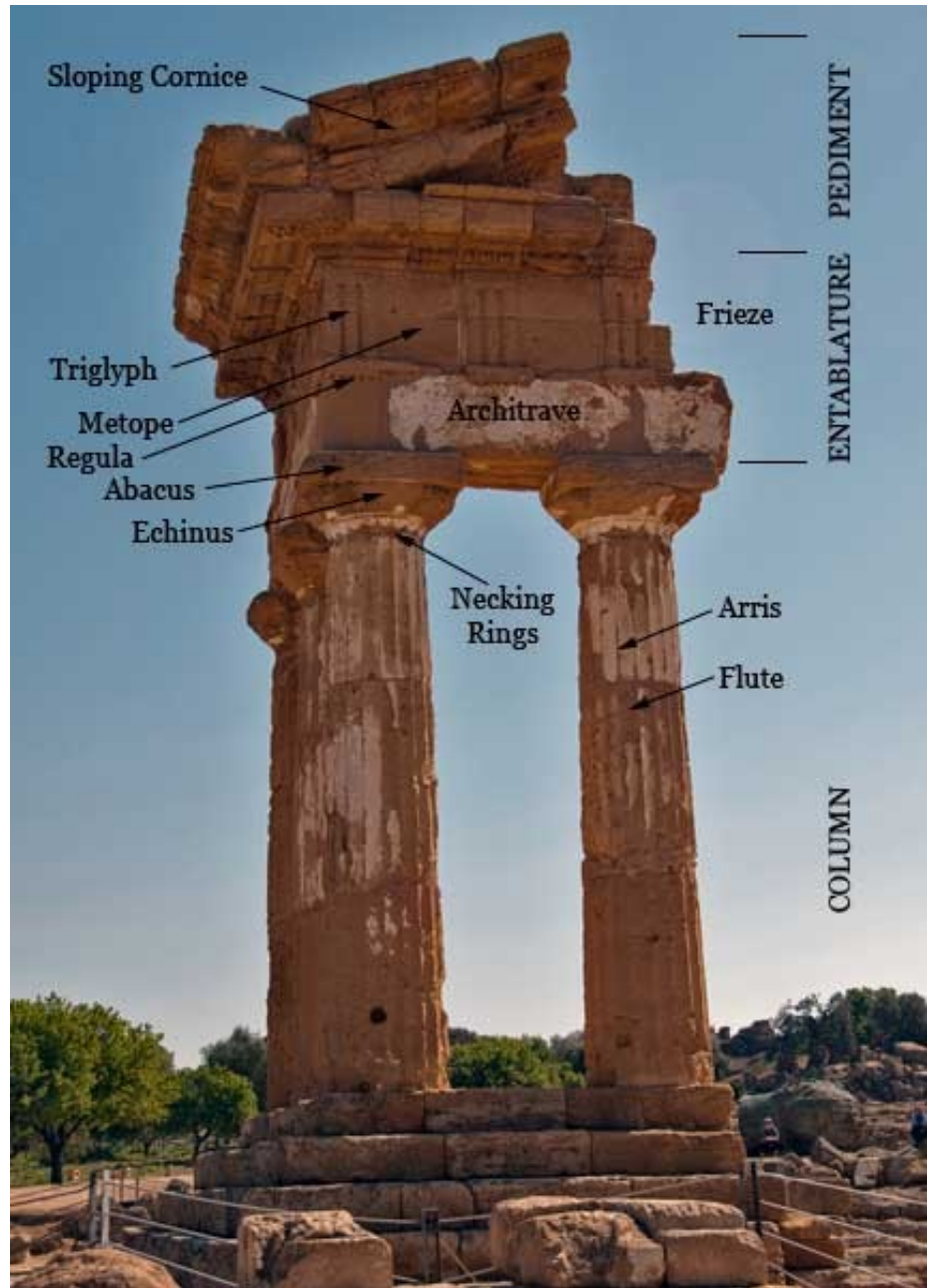
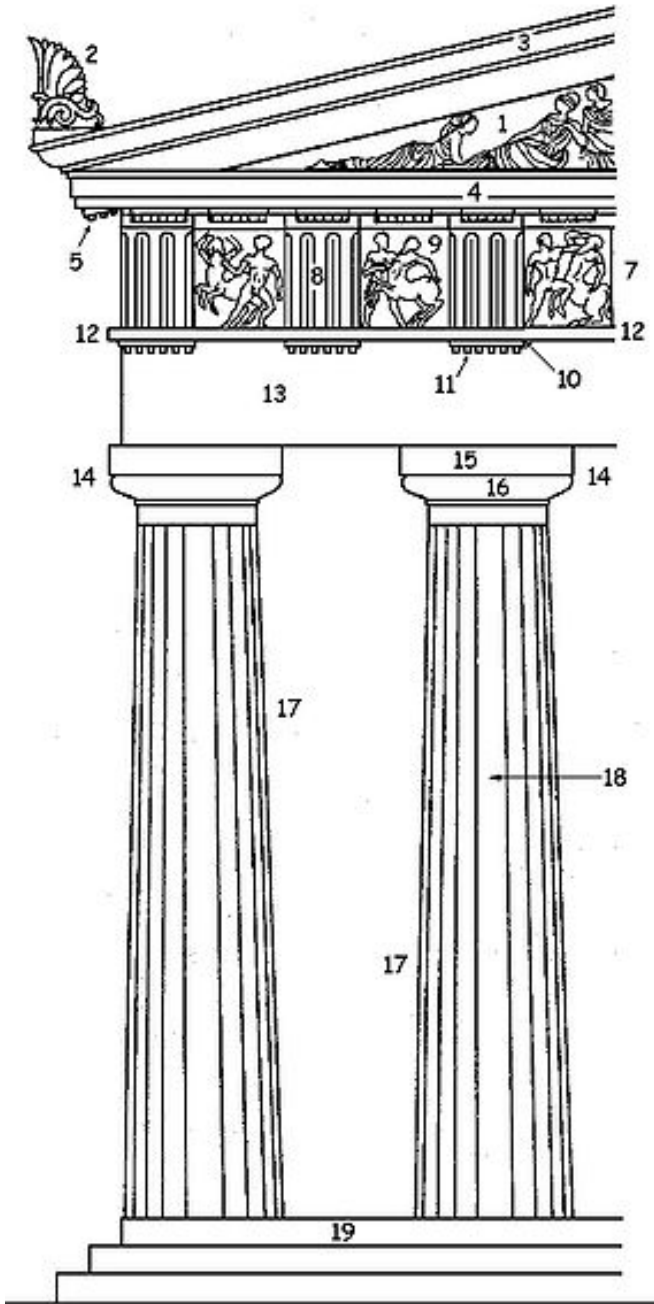

IONIC ORDER

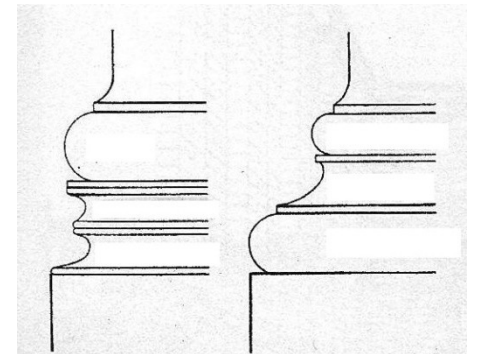
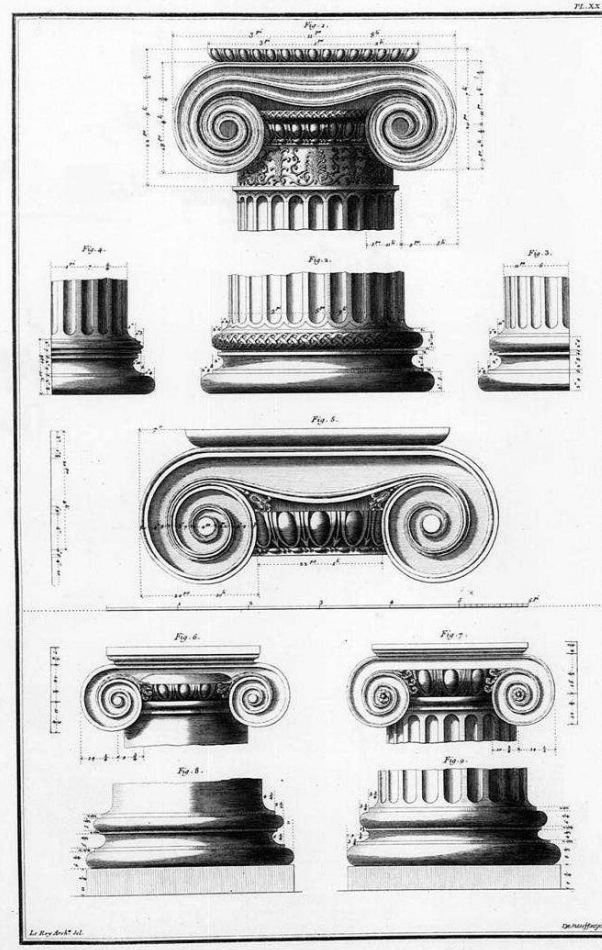
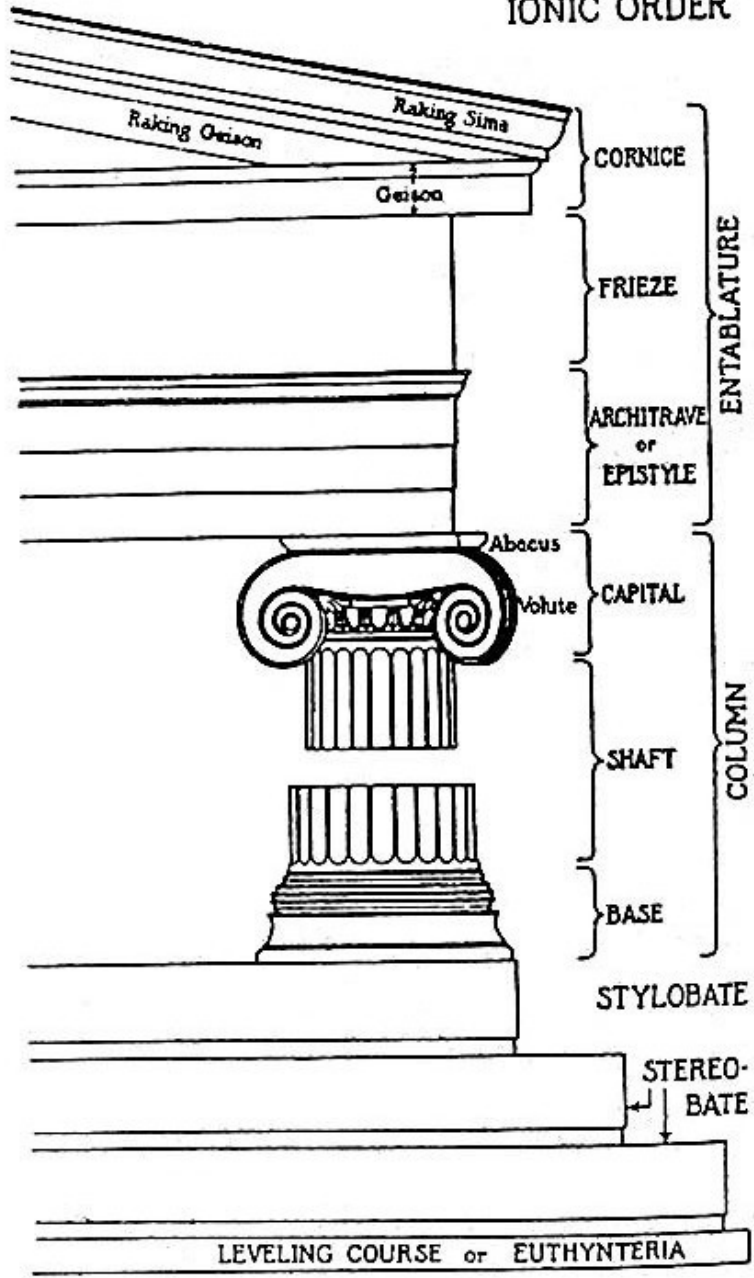

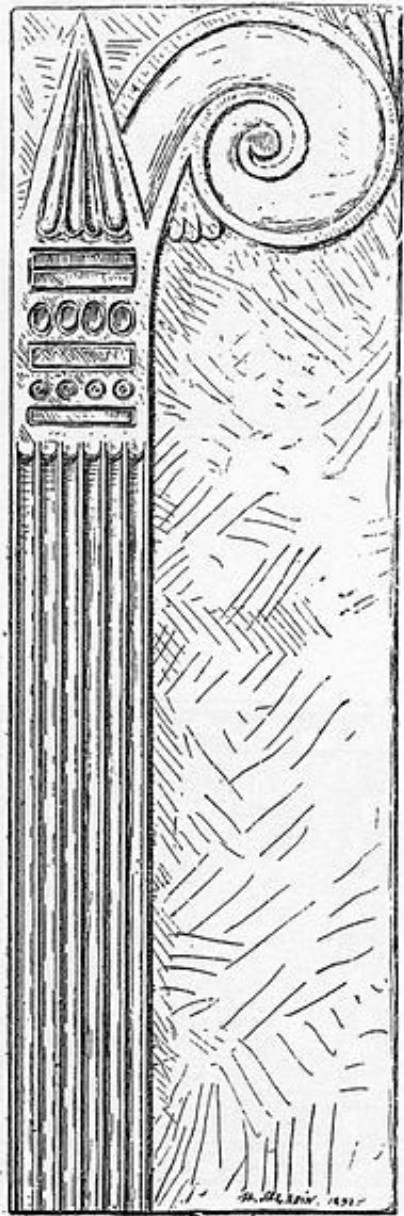

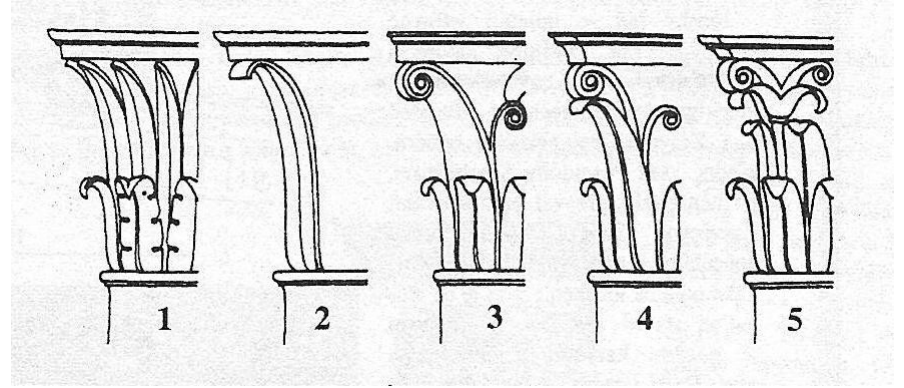
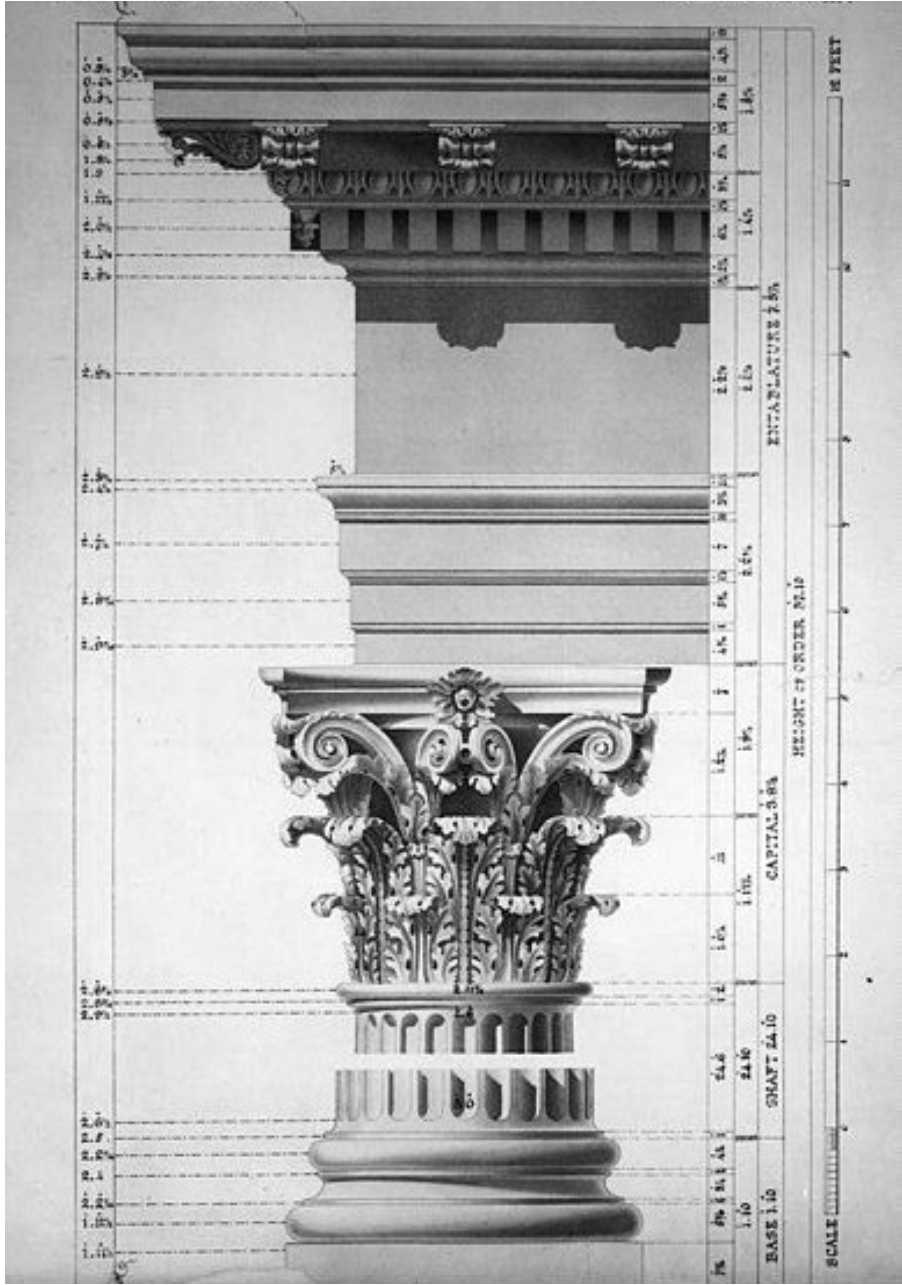



antentempel



dubbele
antentempel

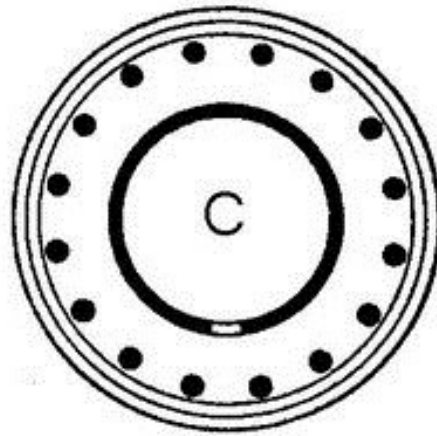

tholus



prostylus



amphiprostylus

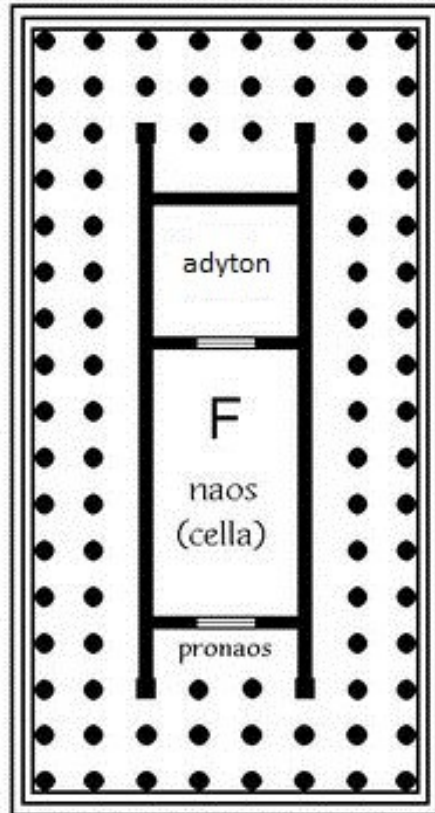

dipterus

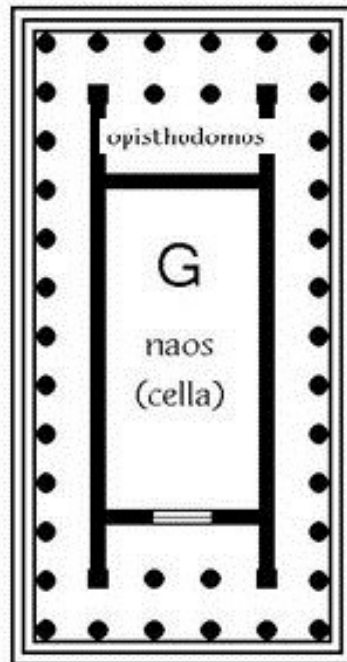

peripterus

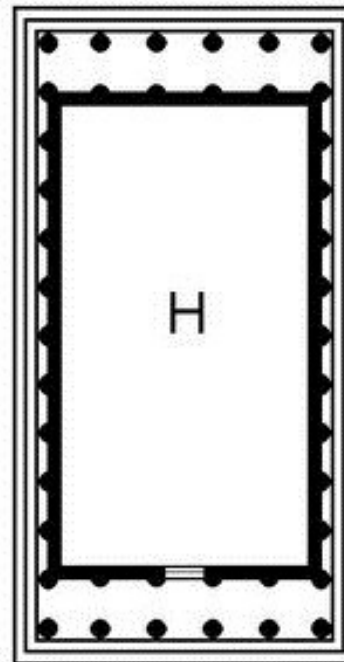

pseudoperipterus

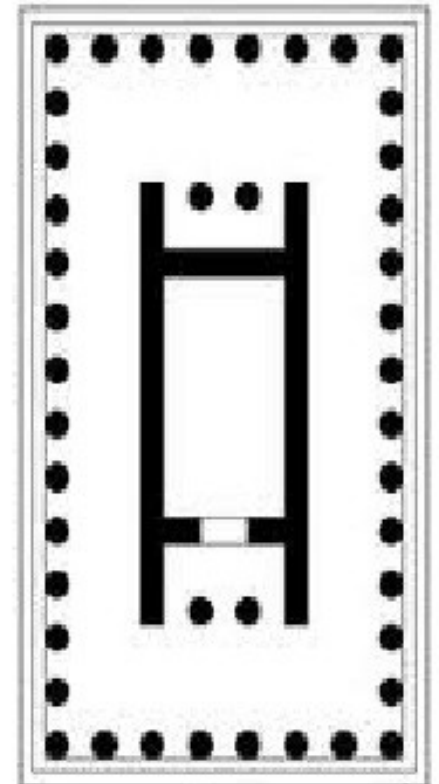

pseudodipterus

LITERATURA

- VITRUVIUS. *Deset knih o architektuře*. Praha: Svoboda, 1979.
- VLČEK, Pavel. *Dějiny architektury pravěku a starověku*. Praha: Nakladatelství ČVUT, 2005.
- BAHNÍK, Václav. *Slovník antické kultury*. Praha: Svoboda, 1974.
- SVOBODA, Ludvík. *Encyklopedie antiky*. Praha: Academia, 1973.
- NEW PAULY ONLINE, *Litterae ante portas*