

Dějiny Řecka I. seminář

4. TÉMA OLYMPIE A OLYMPIJSKÉ HRY



Greece and the Aegean during the Dark Ages (12th – 9th cents. BC); the most important sites

- | | | |
|---|---|-------------------------------------|
| ● Important settlement | Chronology: | Finding - places of imported goods: |
| ○ Settlement (with / without architectural finds) | ▨ Late Helladic (12th / early 11th cents.) | ┃ Orient |
| ⌂ Necropolis / tomb | ▤ Sub - Mycenaean / Sub - Minoan (early - mid 11th cent.) | ⌘ Cyprus |
| ⌂ Sanctuary | ▥ Proto - geometric (mid 11th cent. – c. 900 BC) | ⌚ Italy, Europe |
| ⌂ Centre of pottery production | ▧ Geometric (Early, Middle) (9th – early 8th cents.) | Mykenai Ancient name |
| ? ⌂ Identification uncertain | ▩ Dating certain / uncertain | Çömlekçi Modern name |
| | | (Rhodos) Island |



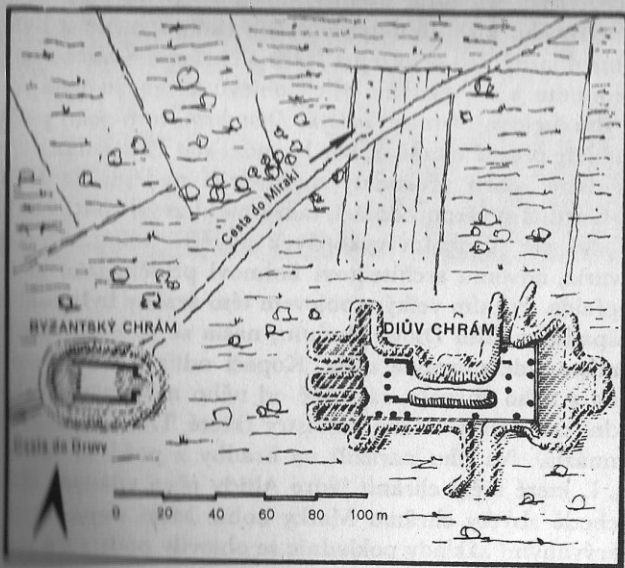

Vykopávky v Olympii. Vlevo stav po francouzských výkopech roku 1829, vpravo po dvou sezónách německých výkopů roku 1887. Poloha stadiónu a jiných sportovních staveb nebyla tehdy ještě známa

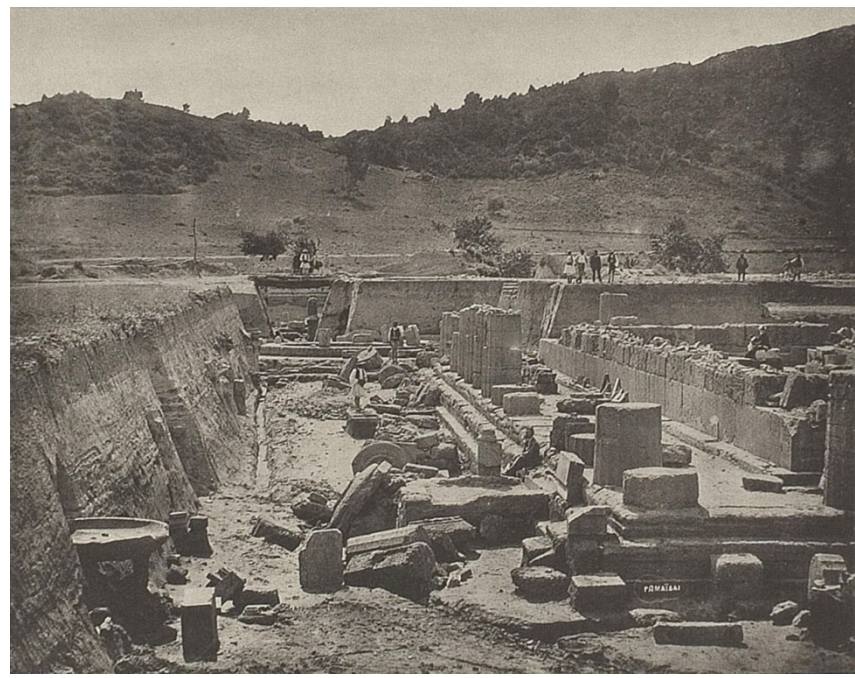
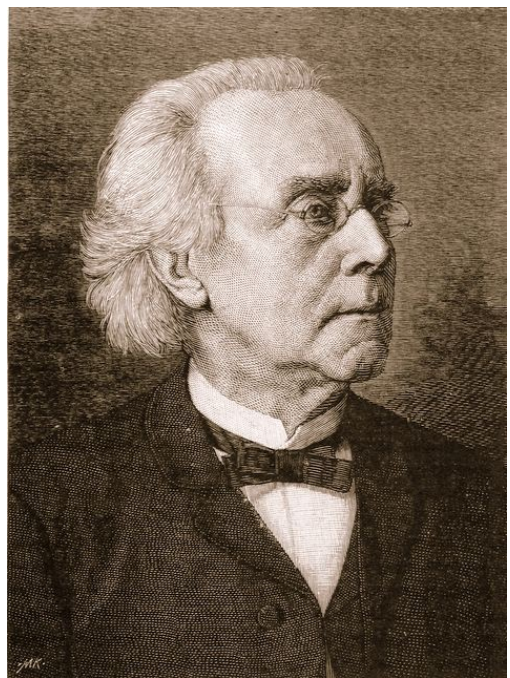
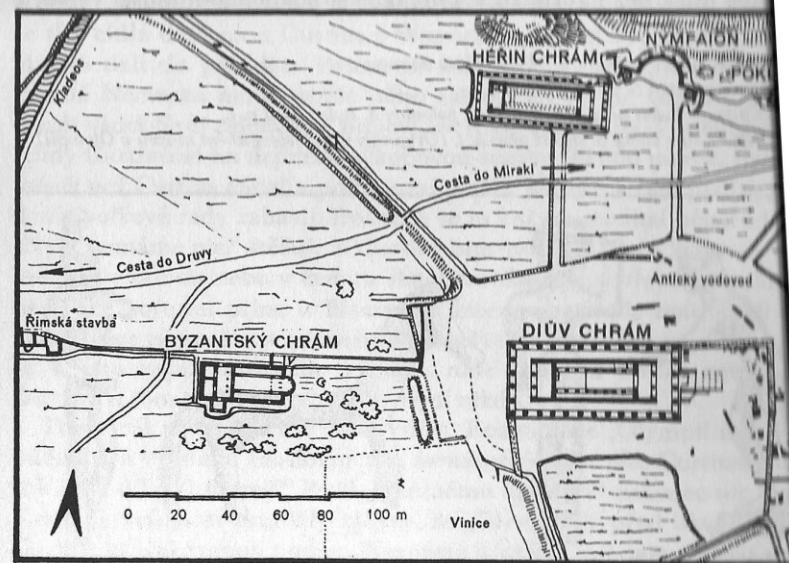

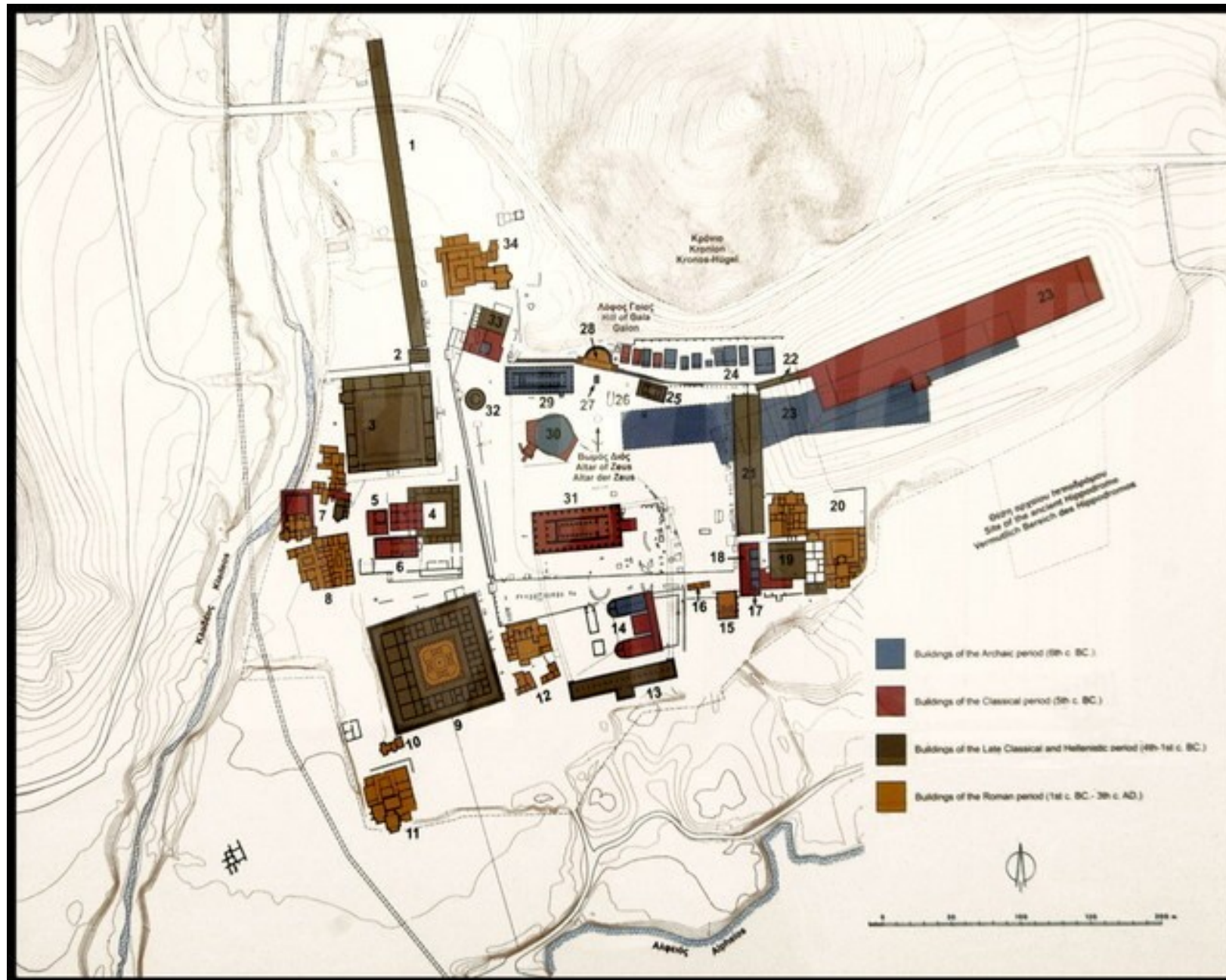

1. Gymnasium
2. Propylon
3. Palaestra
4. Theokleion
5. Heron
6. Pheidias' workshop
7. Kladeos baths
8. Roman Guest Accomodation
9. Leonidion
10. Ἰατρῶν Ἀσκήσιον
11. SW Baths-Athlet's Club
12. Southern Baths
13. Southern Colonnade
14. Bouleuterion
15. Odeion
16. Arch of Nero
17. Sanctuary of Hestia
18. SE building
19. Greek Building
20. Octagon
21. Echo Colonnade
22. Krypte
23. Stadion
24. Treasuries
25. Metroon
26. Prehistoric apsidal building II
27. Altar of Hera
28. Nymphaion
29. Herain
30. Pelopion
31. Temple of Zeus
32. Philoppeion
33. Pnythaeion
34. Building of a Roman House



An aerial view of Olympia, Greece





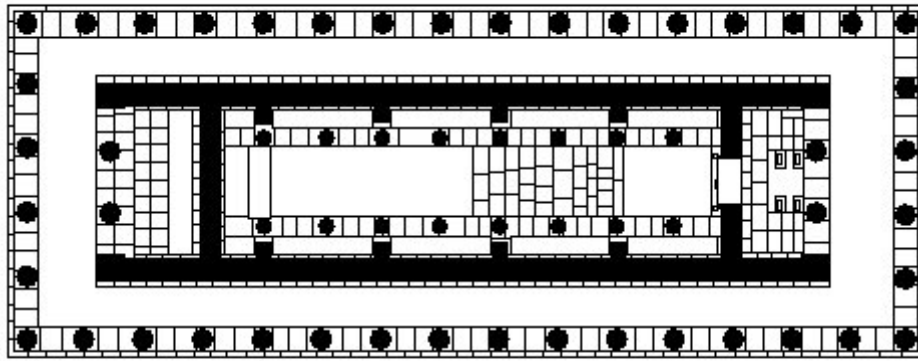

0 1 10 m. ↑



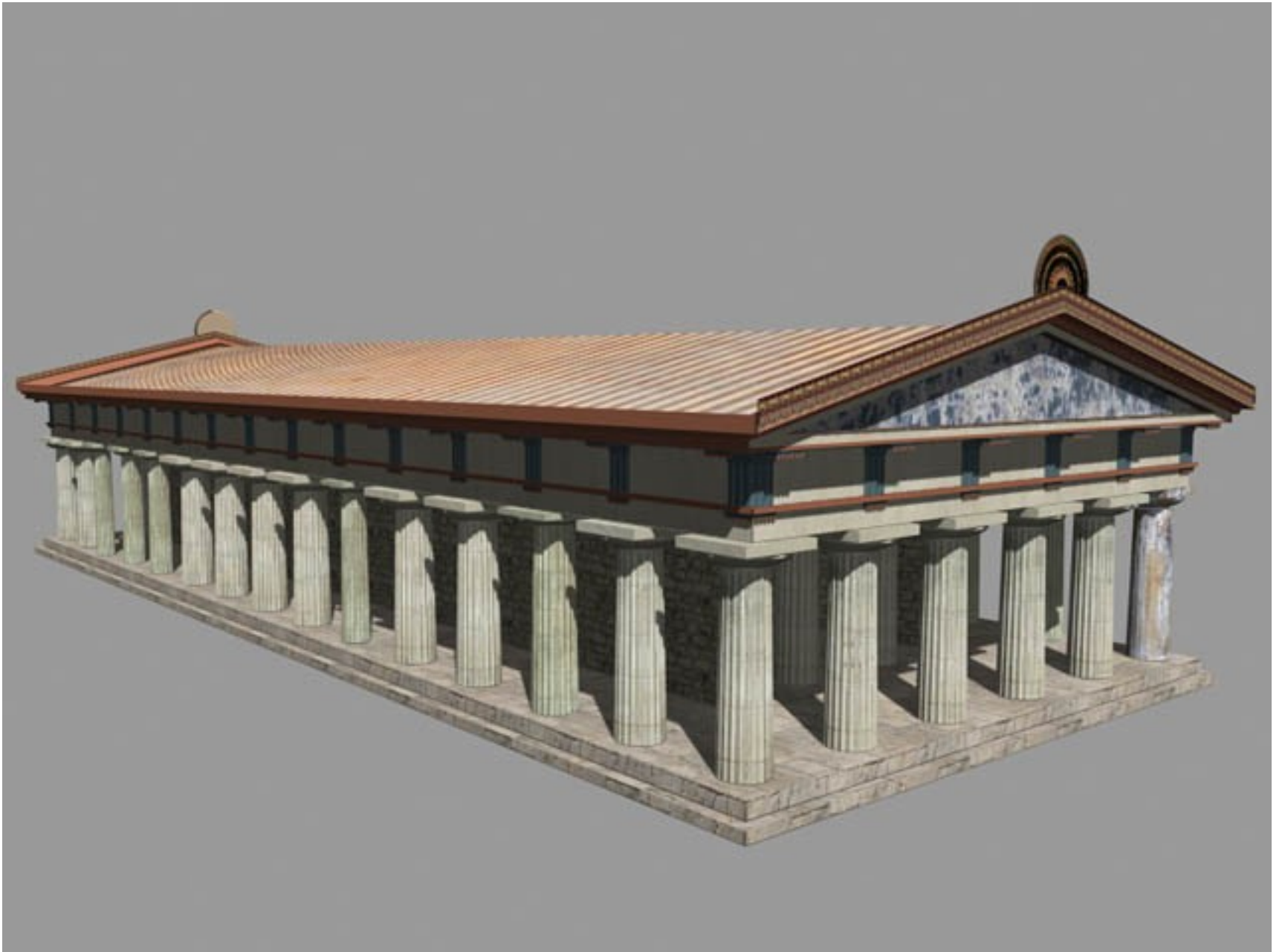



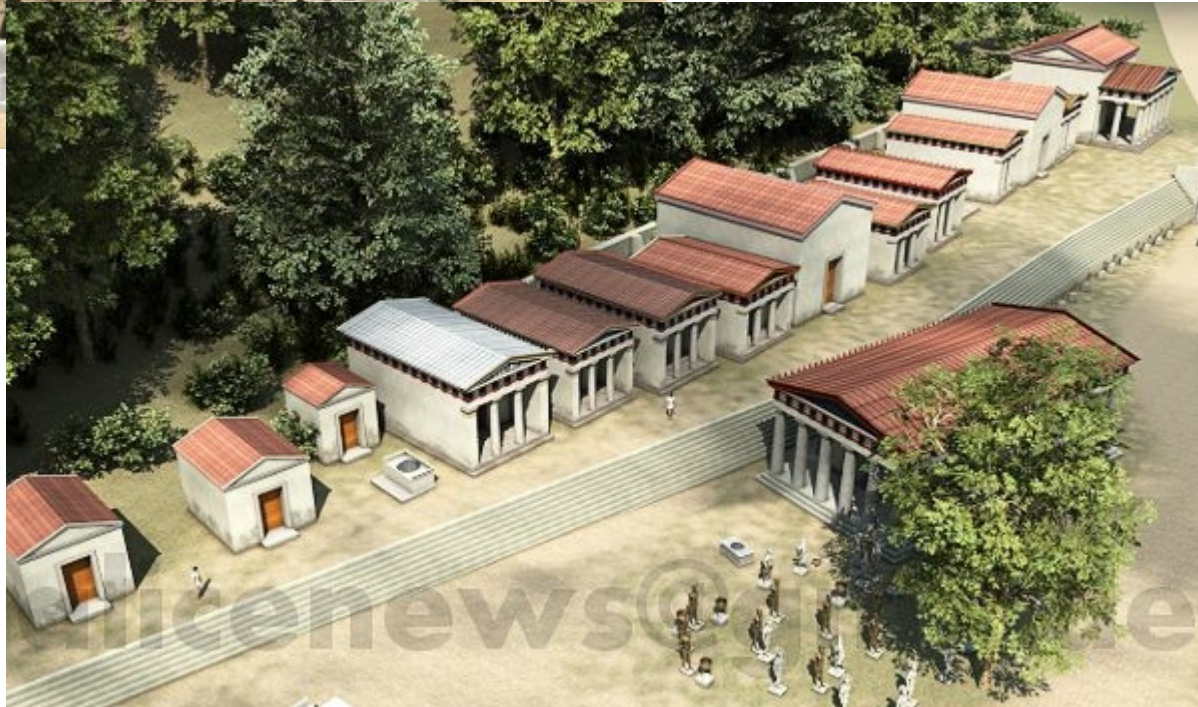
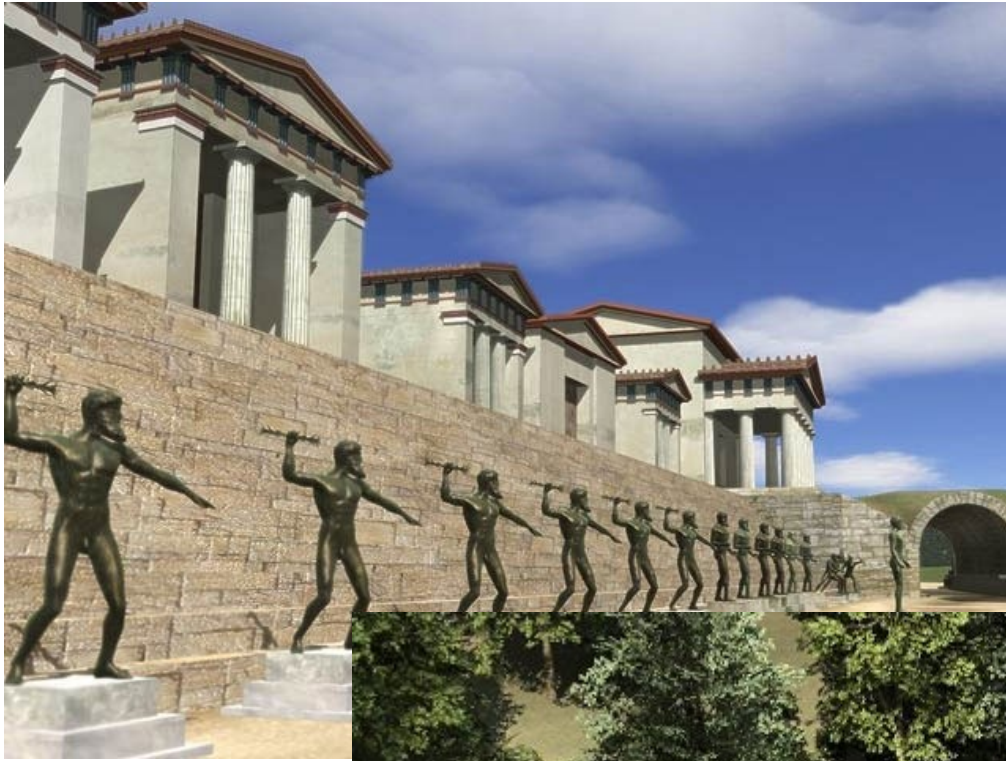

Olympia, Pelopeion

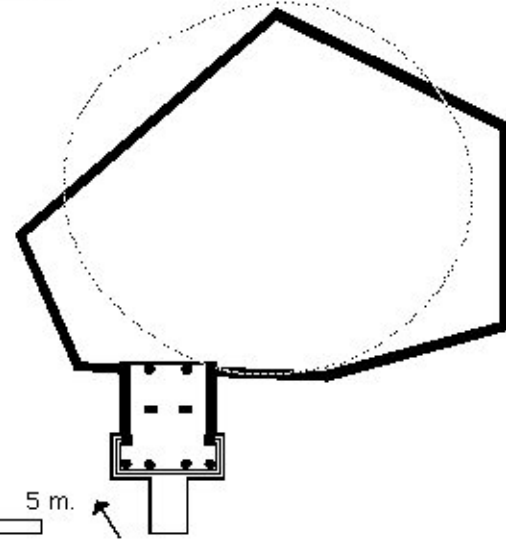
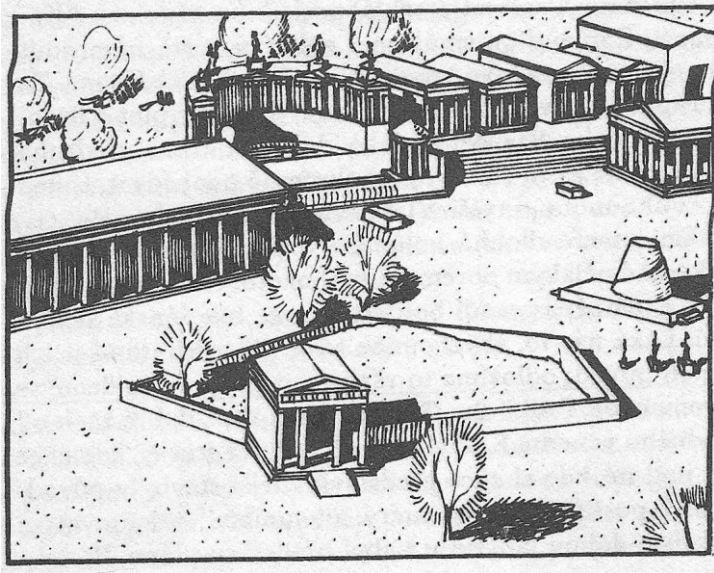



Olympia, Bouleuterion

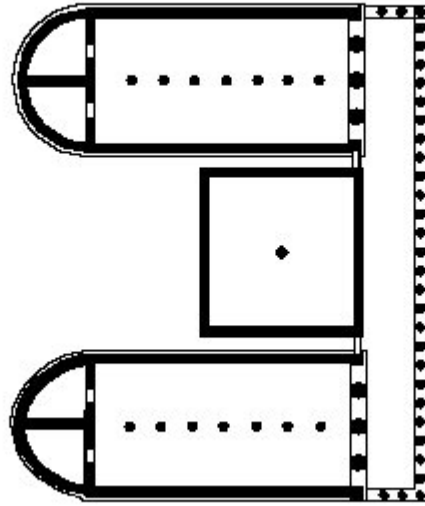

0 10 m.



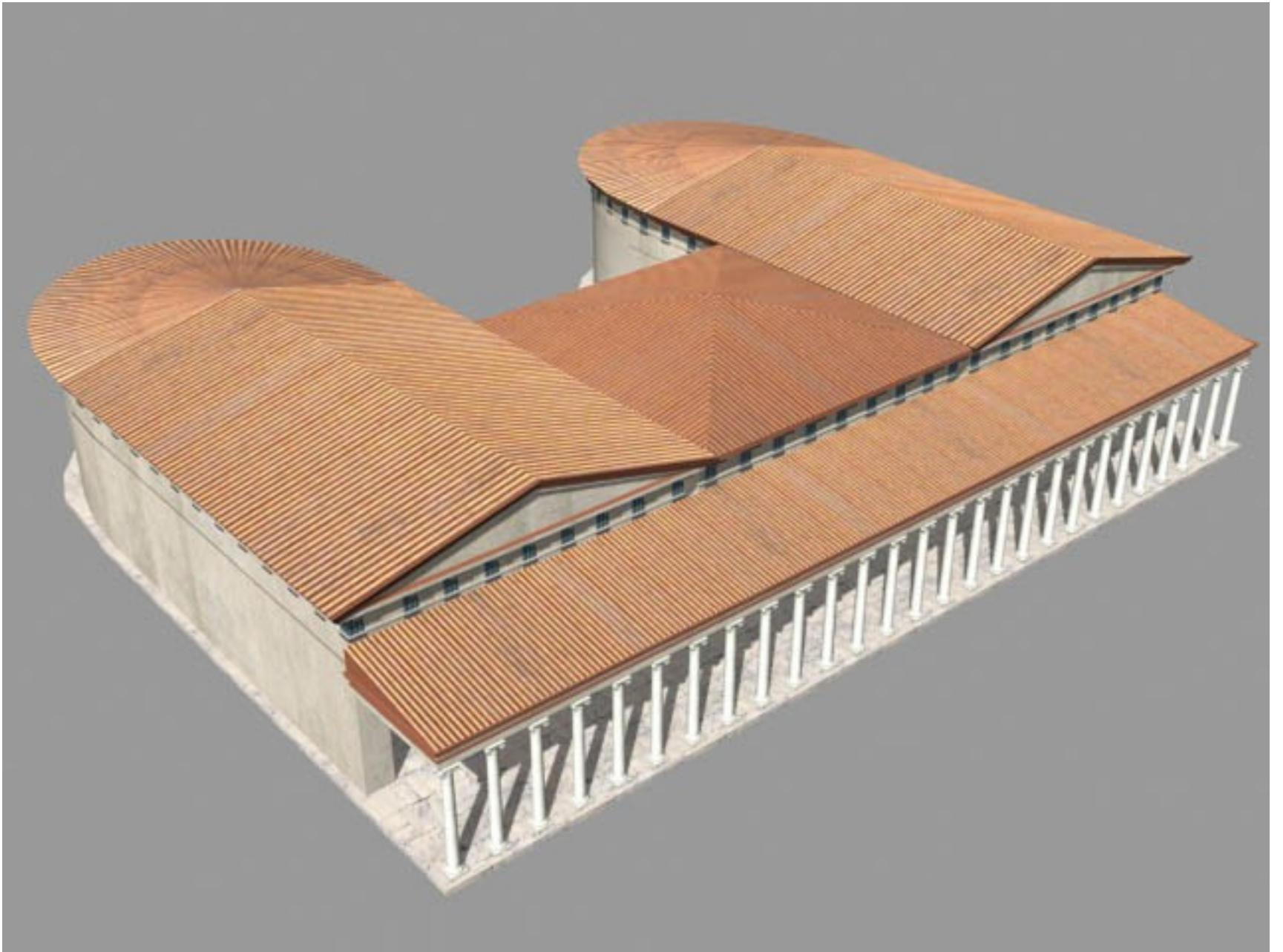

Olympia, Temple of Zeus

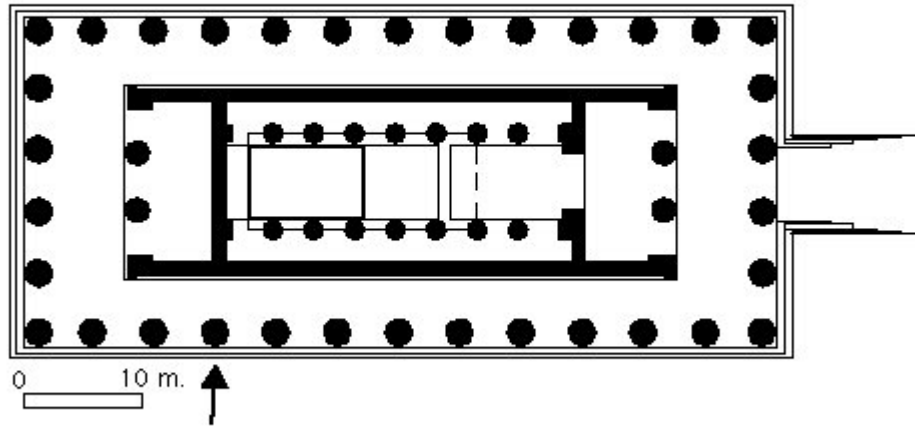





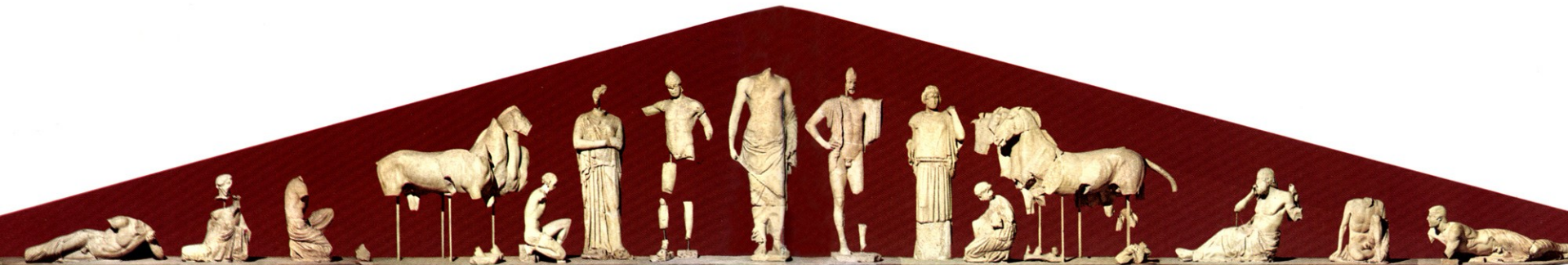

Alpheios or Kladeos

Diviner

Charioteer

Horses from Oinomaos' or Pelops' chariot

Kneeling youth (Myrtilos?)

Sterope or Hippodameia

Pelops

Zeus

Oinomaos

Hippodameia or Sterope

Kneeling girl

Horses from Oinomaos' or Pelops' chariot

Old diviner (Iamos?)

Crouching youth (possibly Arkas)

Kladeos or Alpheios





Lapith woman Old Lapith woman Lapith Centaur Lapith woman Centaur and Lapith Theseus Centaur Lapith woman Apollo Deidameia and Centaur Eurytion Peirithoos Lapith and Centaur Lapith woman and Centaur Lapith Old Lapith woman Lapith woman

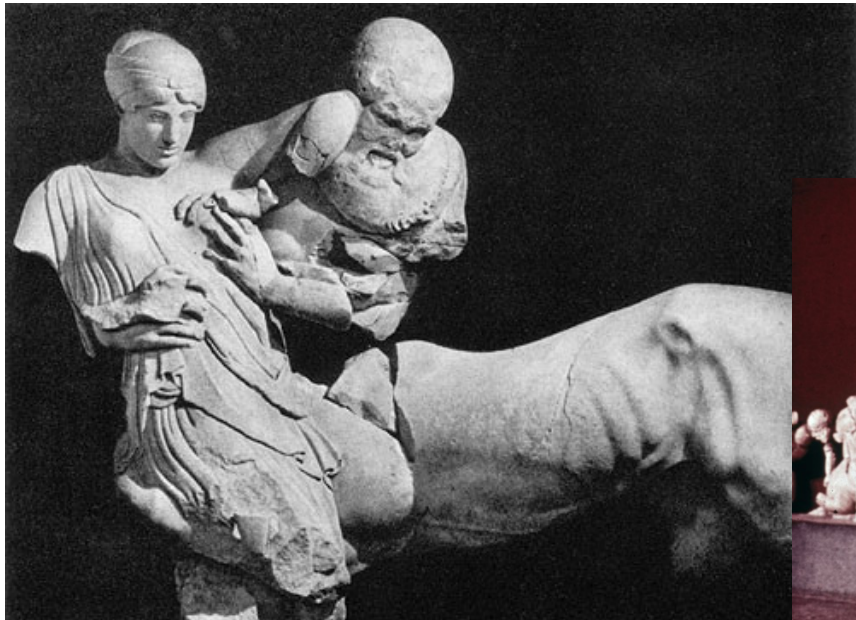

Athena

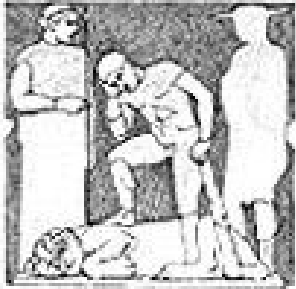

Athena

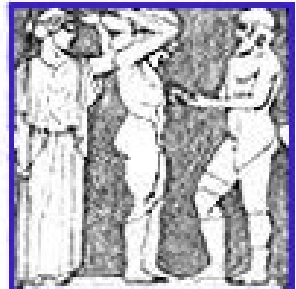
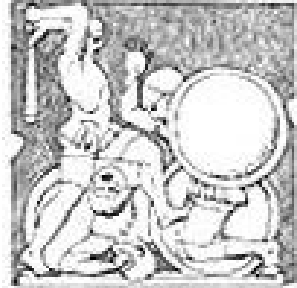
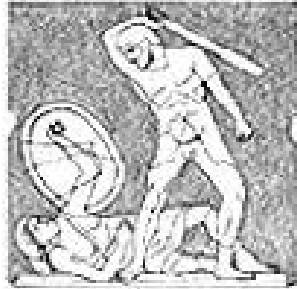
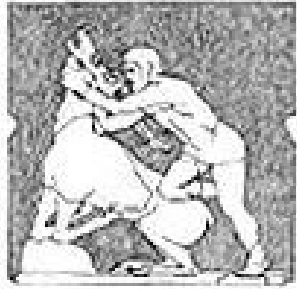
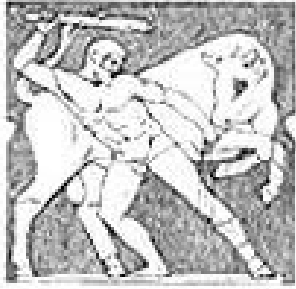

Athena

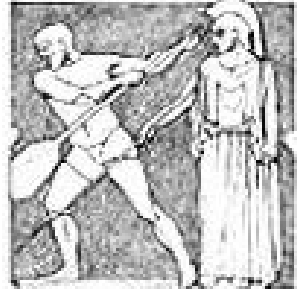
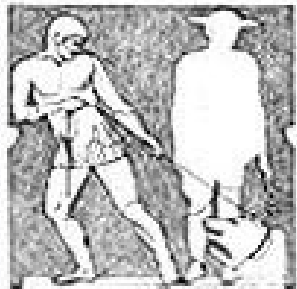

Athena



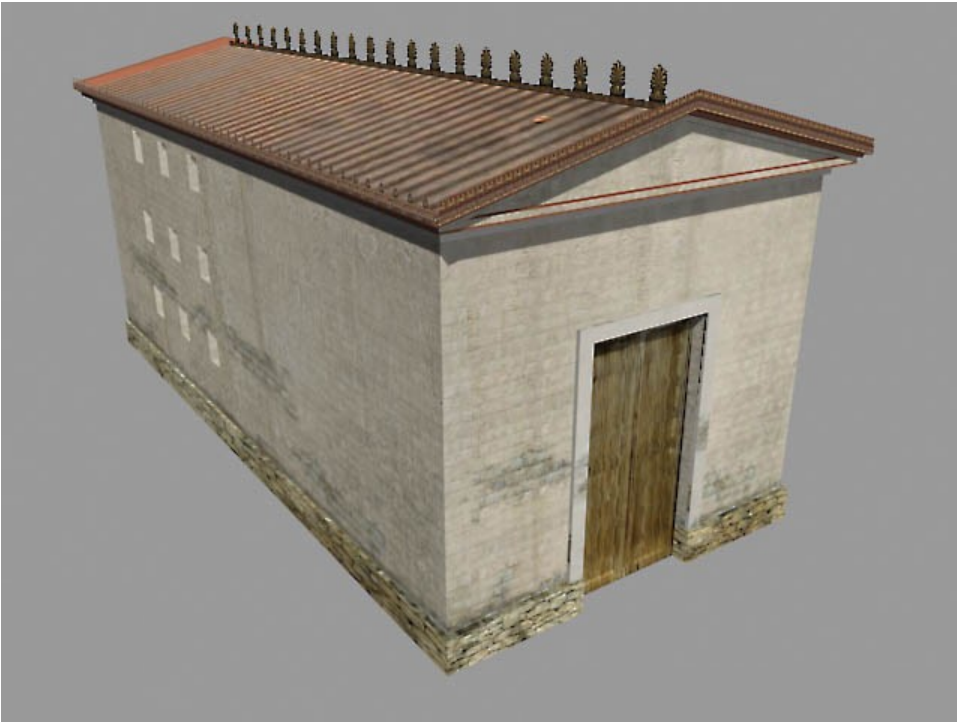



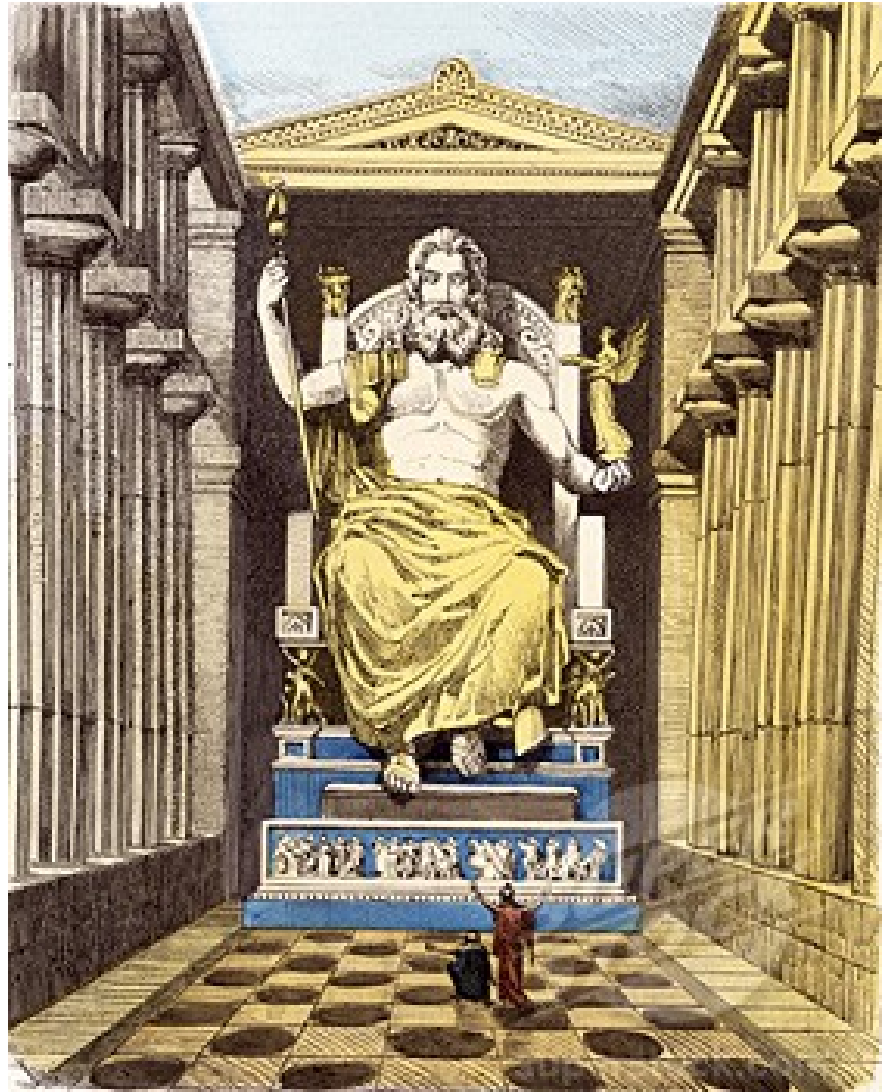



Olympia, Metroon

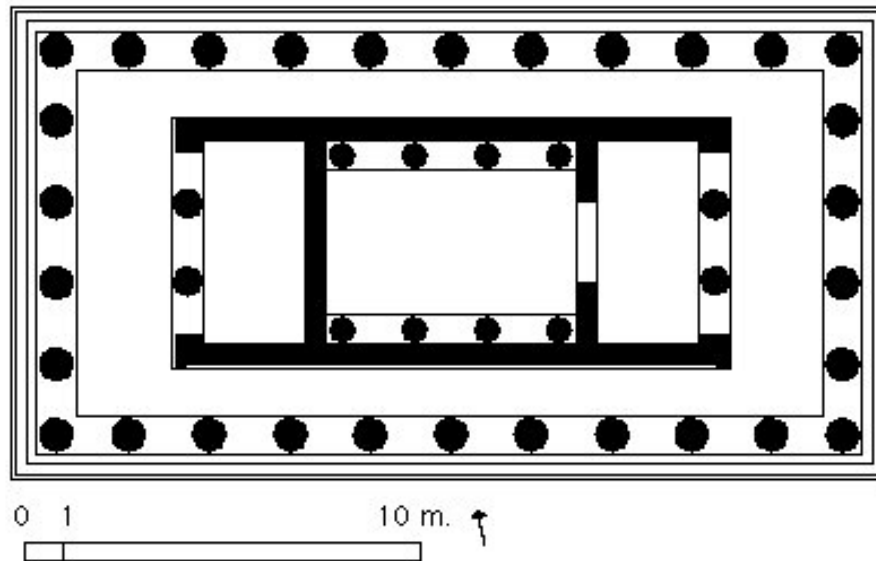



ח

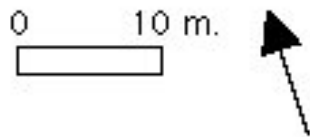
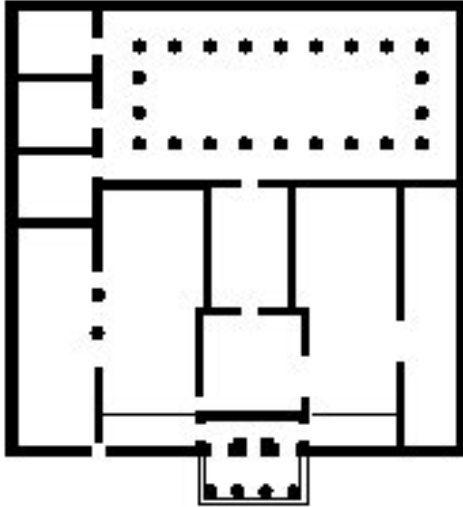

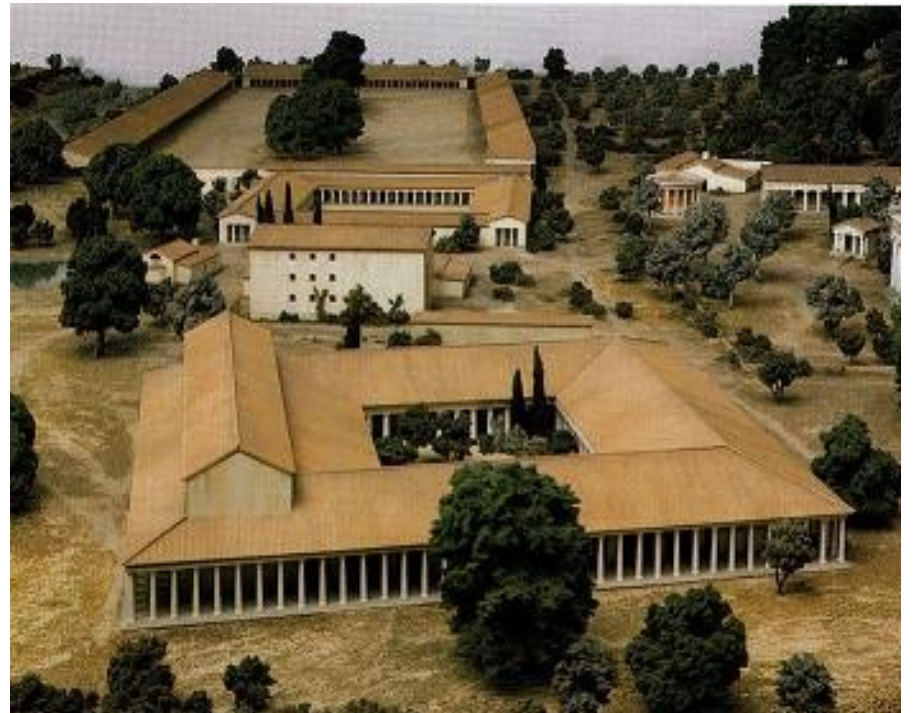
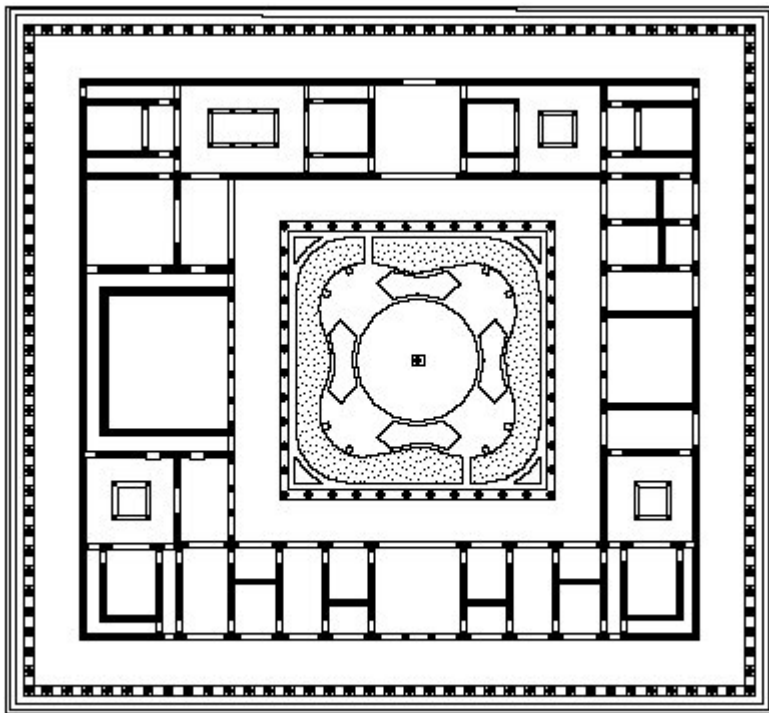

0 20 m



Olympia, Echohall (Painted Stoa)

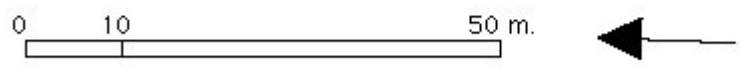
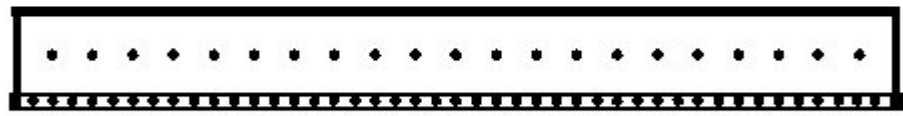

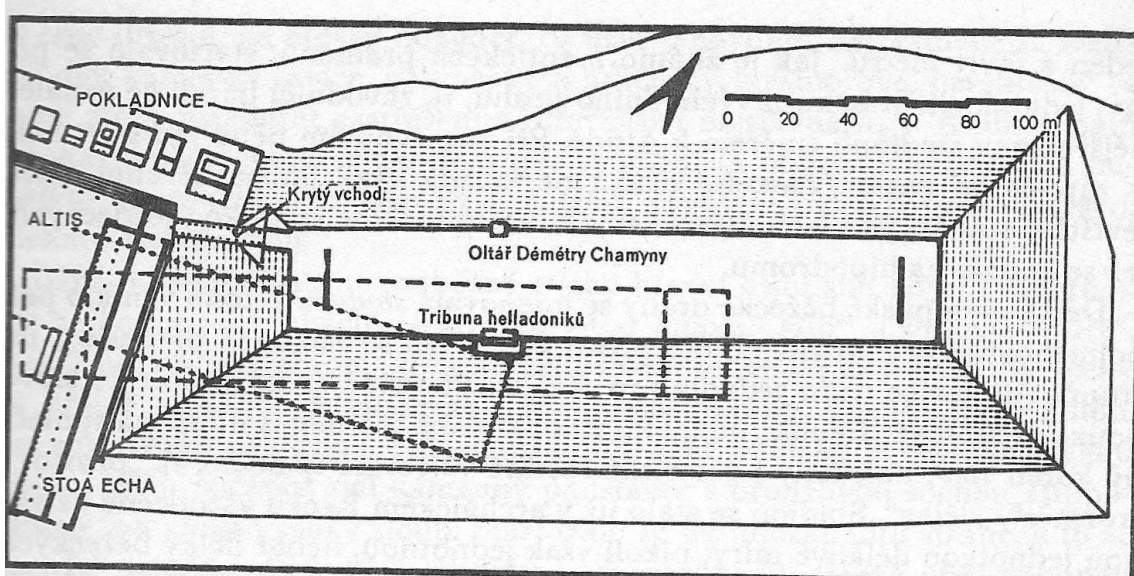

© shunya.net



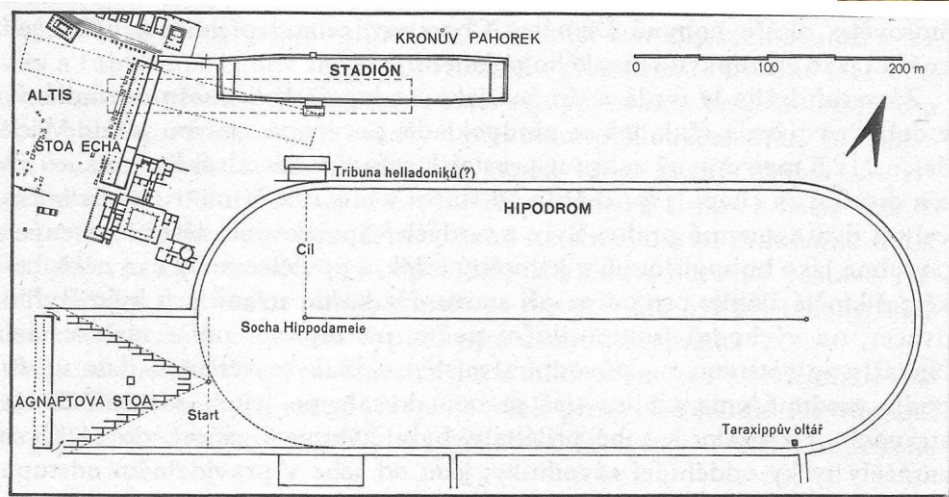
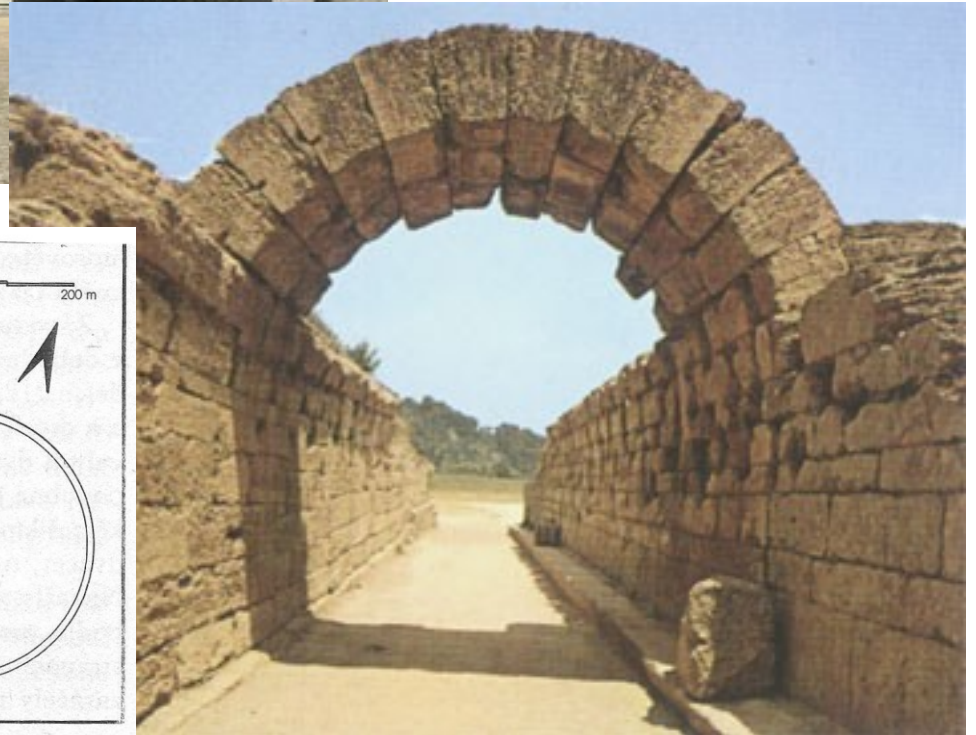

Olympia, Philippeion

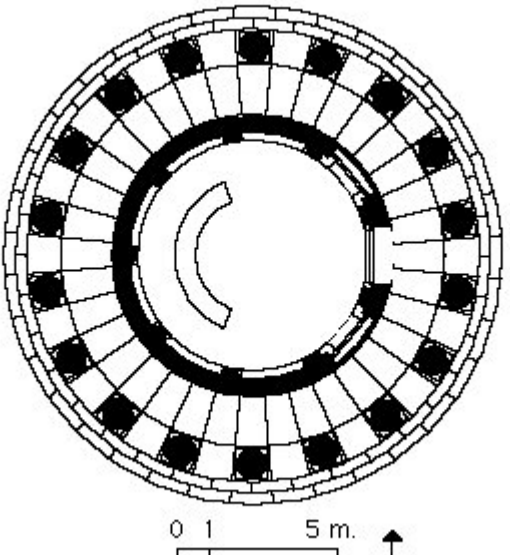

Olympia, Palaestra

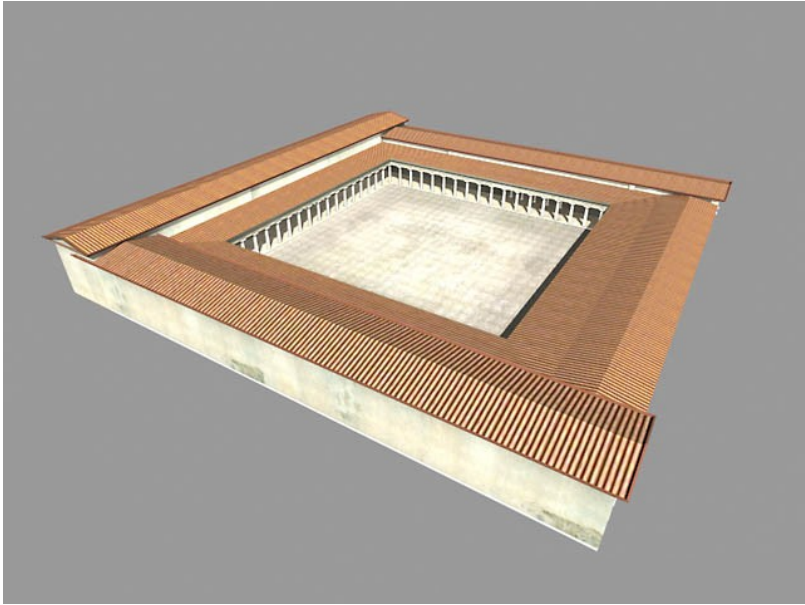
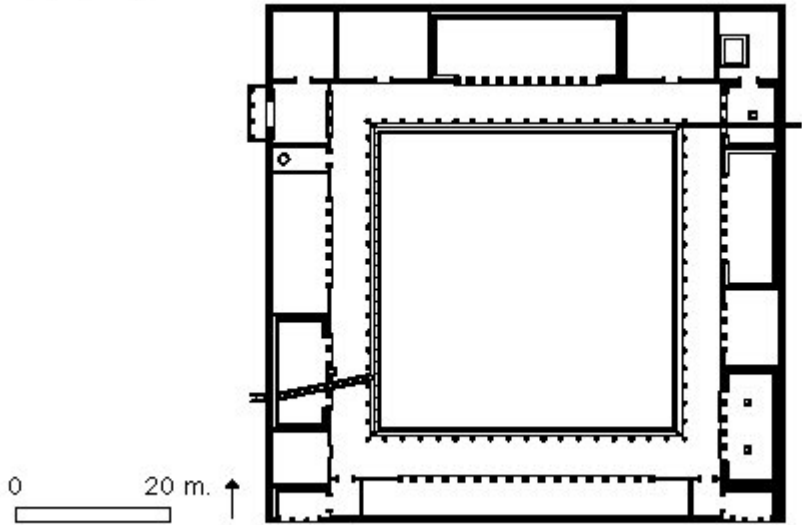

Olympia, Gymnasium

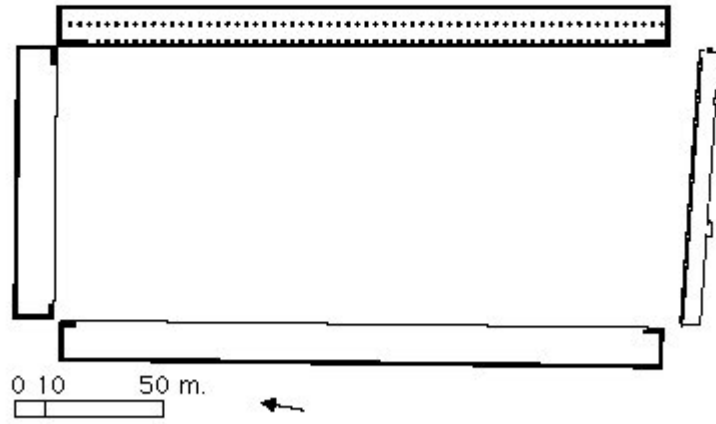

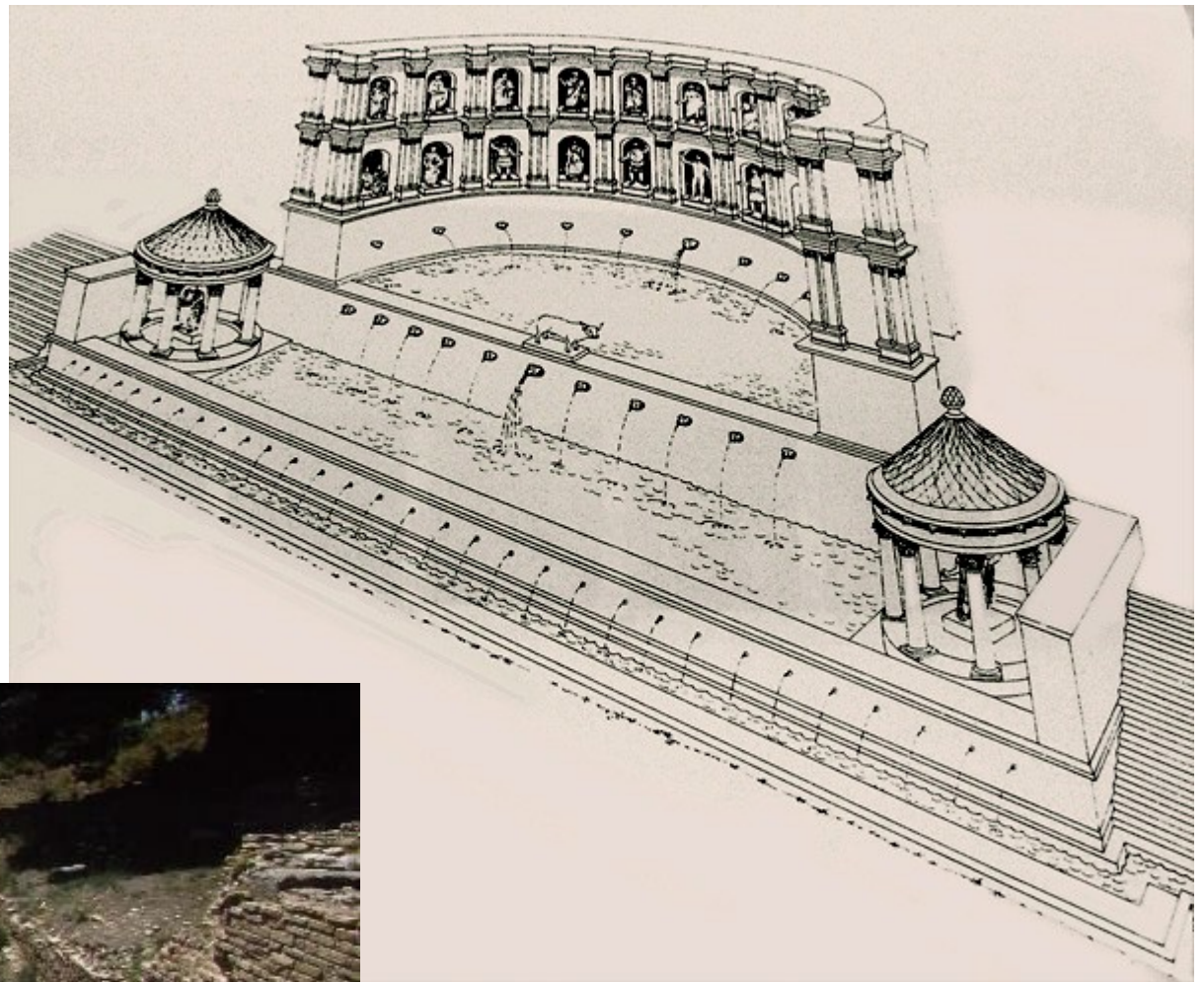



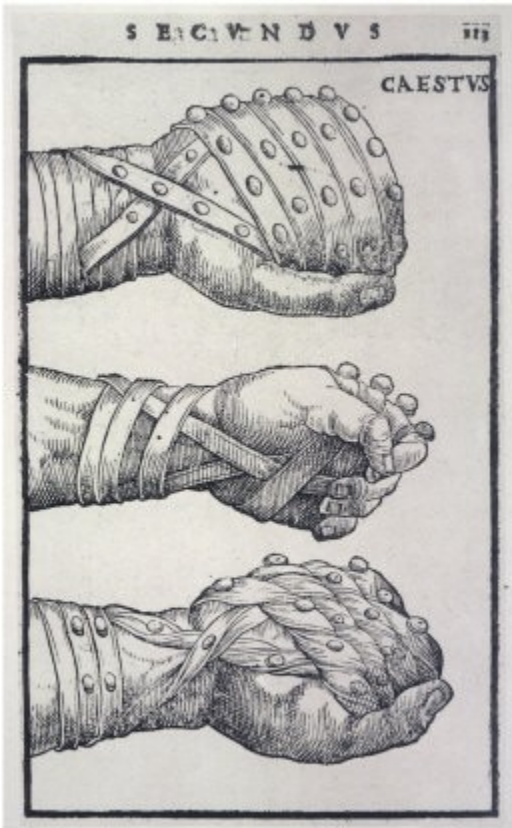
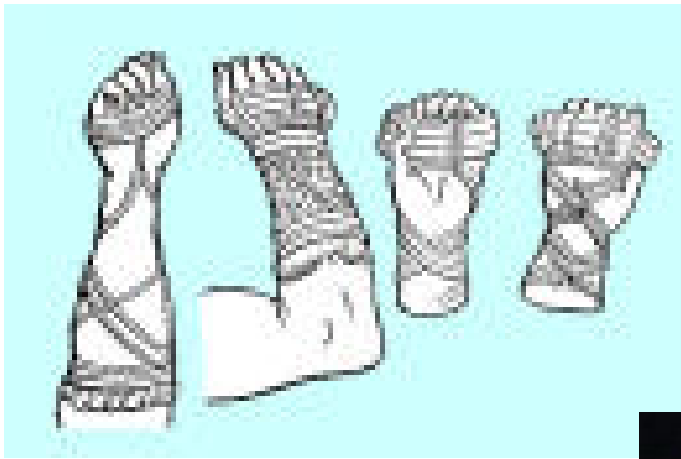

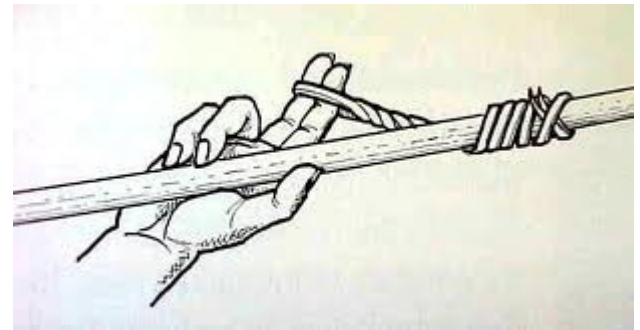

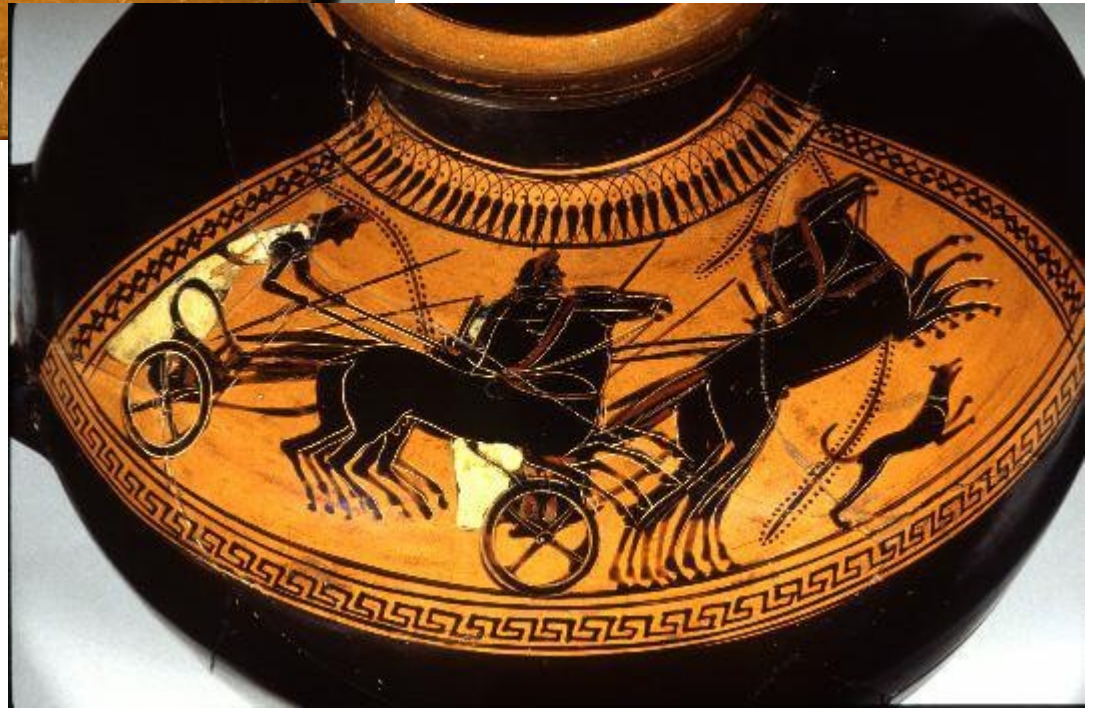
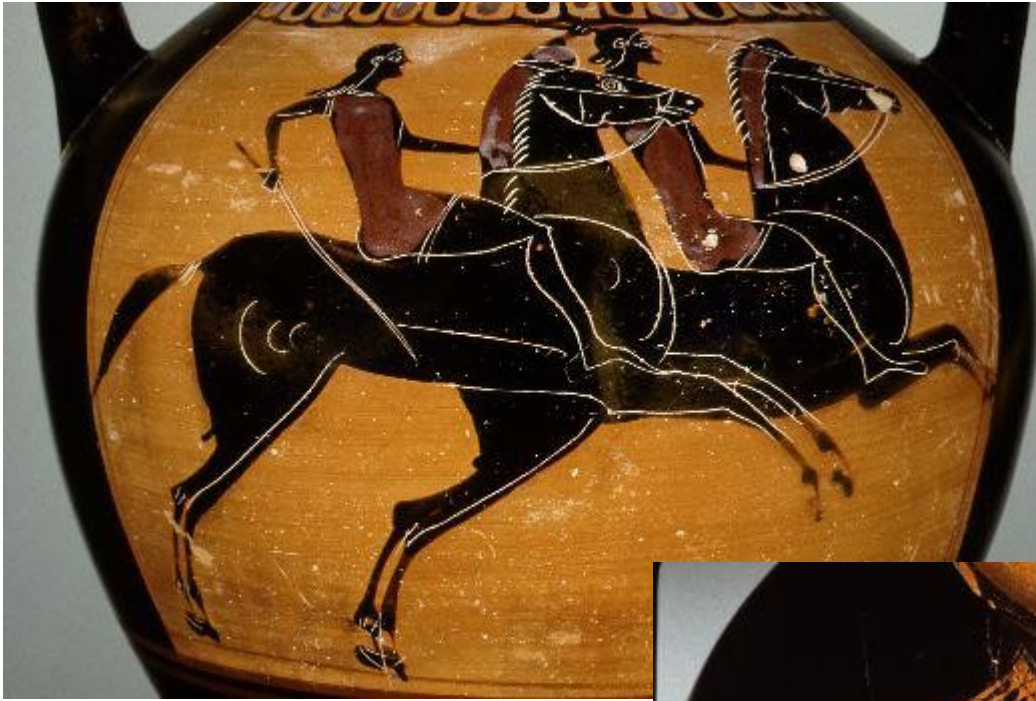

LITERATURA

- ZAMAROVSKÝ, Vojtěch. *Vzkříšení Olympie*. Praha: Olympia, 1980.
- BAHNÍK, Václav. *Slovník antické kultury*. Praha: Svoboda, 1974.
- SVOBODA, Ludvík. *Encyklopedie antiky*. Praha: Academia, 1973.
- NEW PAULY ONLINE, *Litterae ante portas*