

# Theophil Hansen (1813 Kodaň – 1891 Vídeň)



- Studia – Bauakademie Kodaň
- 1838 cesta Německo (Berlín, Drážďany, Mnichov), Benátky a do Atén za bratrem
- 1846 u Förstera ve Vídni
- 1850 sňatek s Försterovou dcerou, konflikty
- 1852 rozchod s Försterem
- 1868-1883 profesor na akademii
- Od 1884 svobodný pán von Hansen

# Karl F. Schinkel

Berlín divadlo, 1818-1821  
Altes Museum, 1823-1830



# Leo von Klenze

## Valhala u Řezna, 1841

### Propylaje Mnichov 1846-62



# Hvězdárna, Atény, 1842

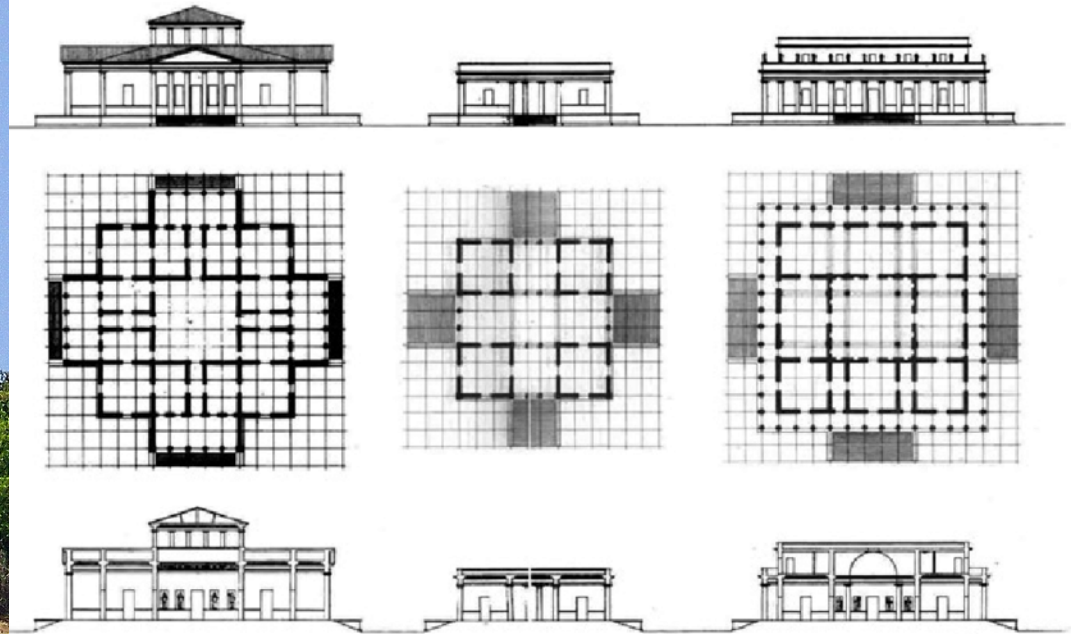

# Nemocnice, Patras, 1857



# Akademie, Atény, 1856-1875

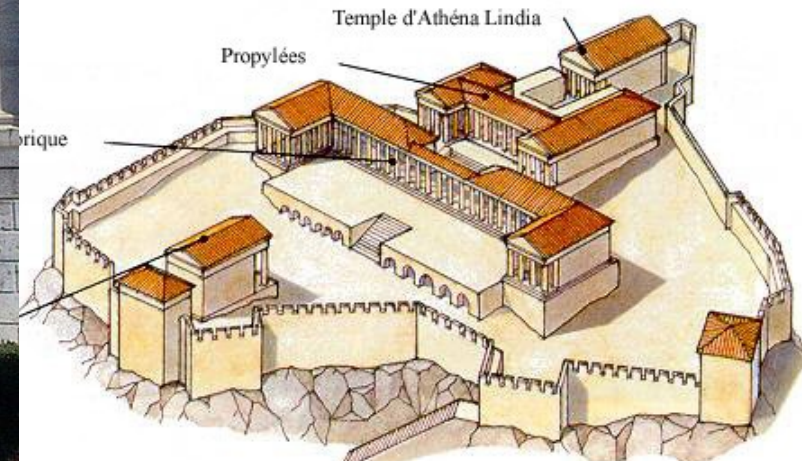
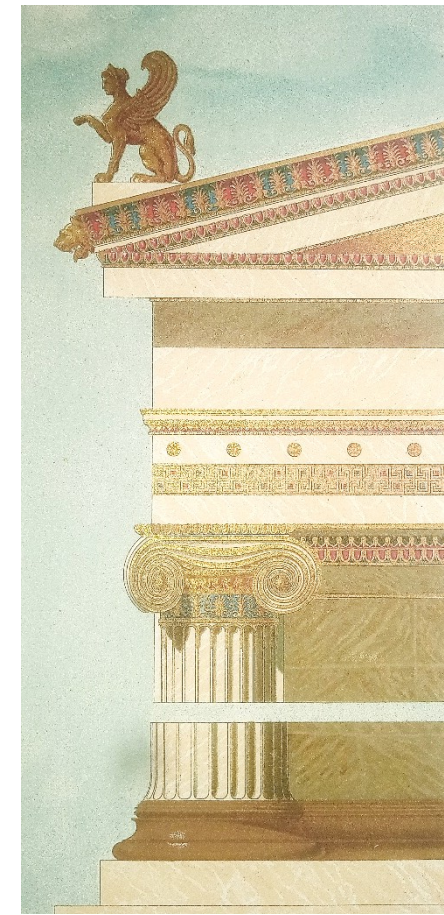

# Vojenské muzeum 1850-57 v Arsenalu

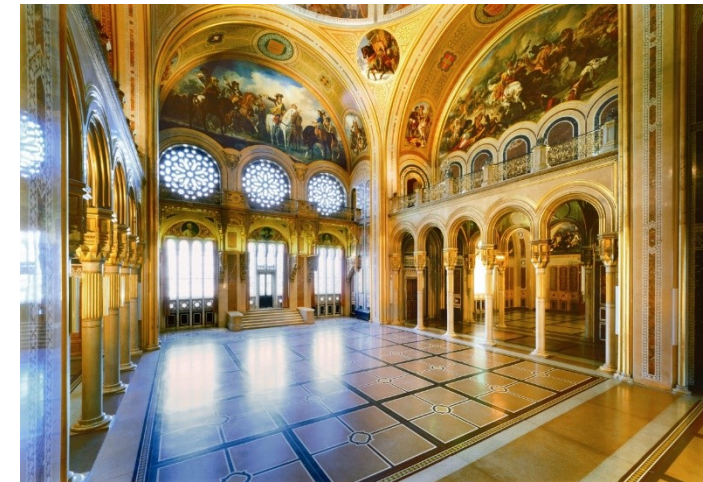
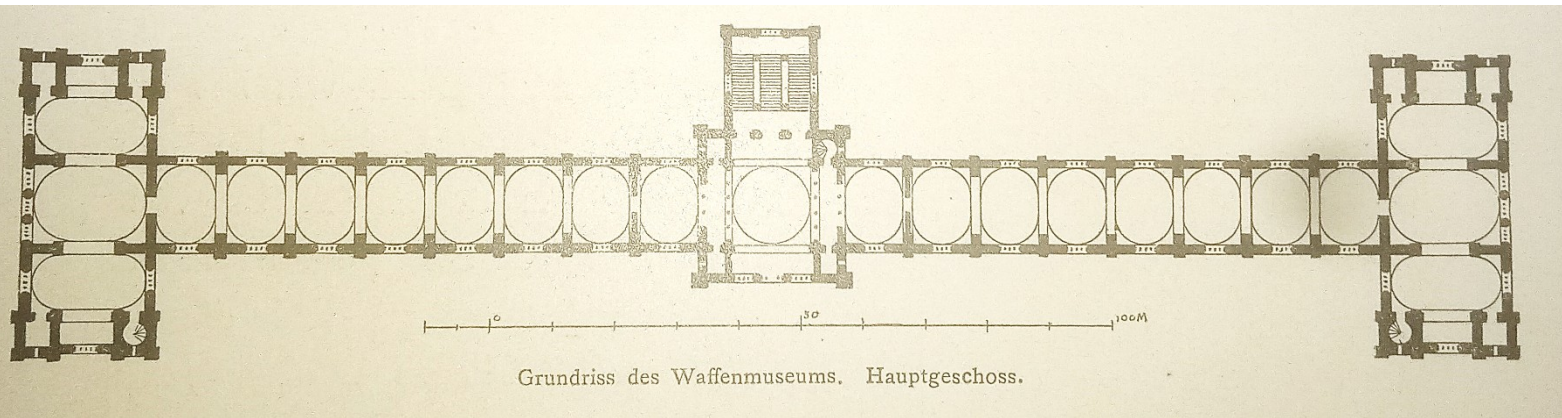

# Řecký kostel ve Vídni, 1856-60

# Hřbitovní evangelický kostel Vídeň, 1857-58

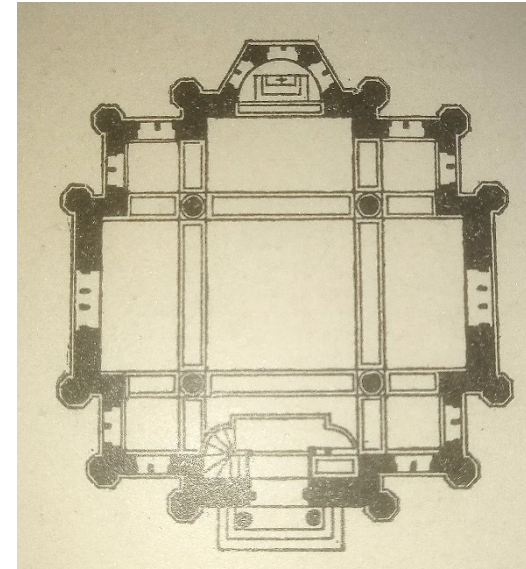
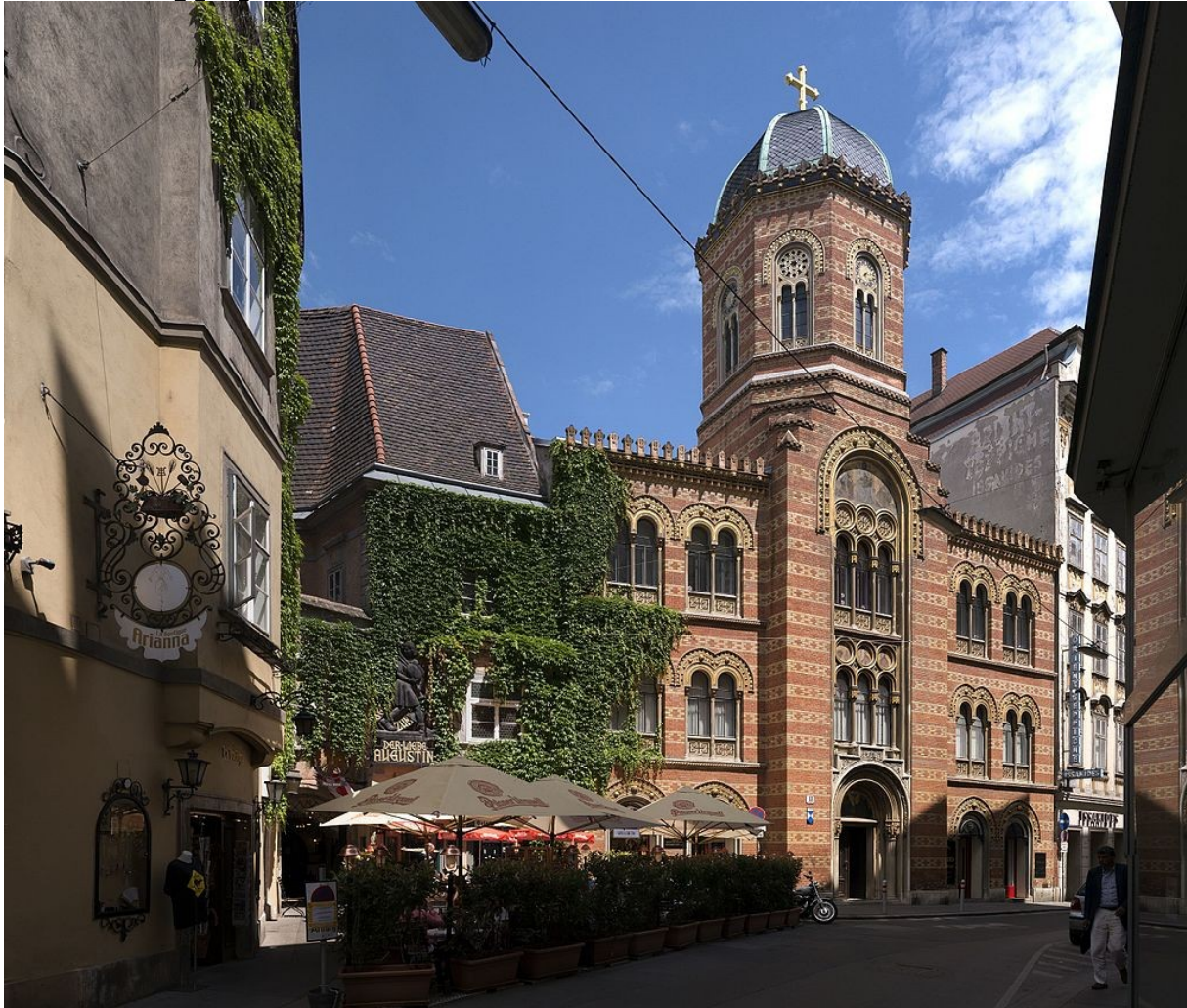



# Dům válečných invalidů, Lvov, 1854-63

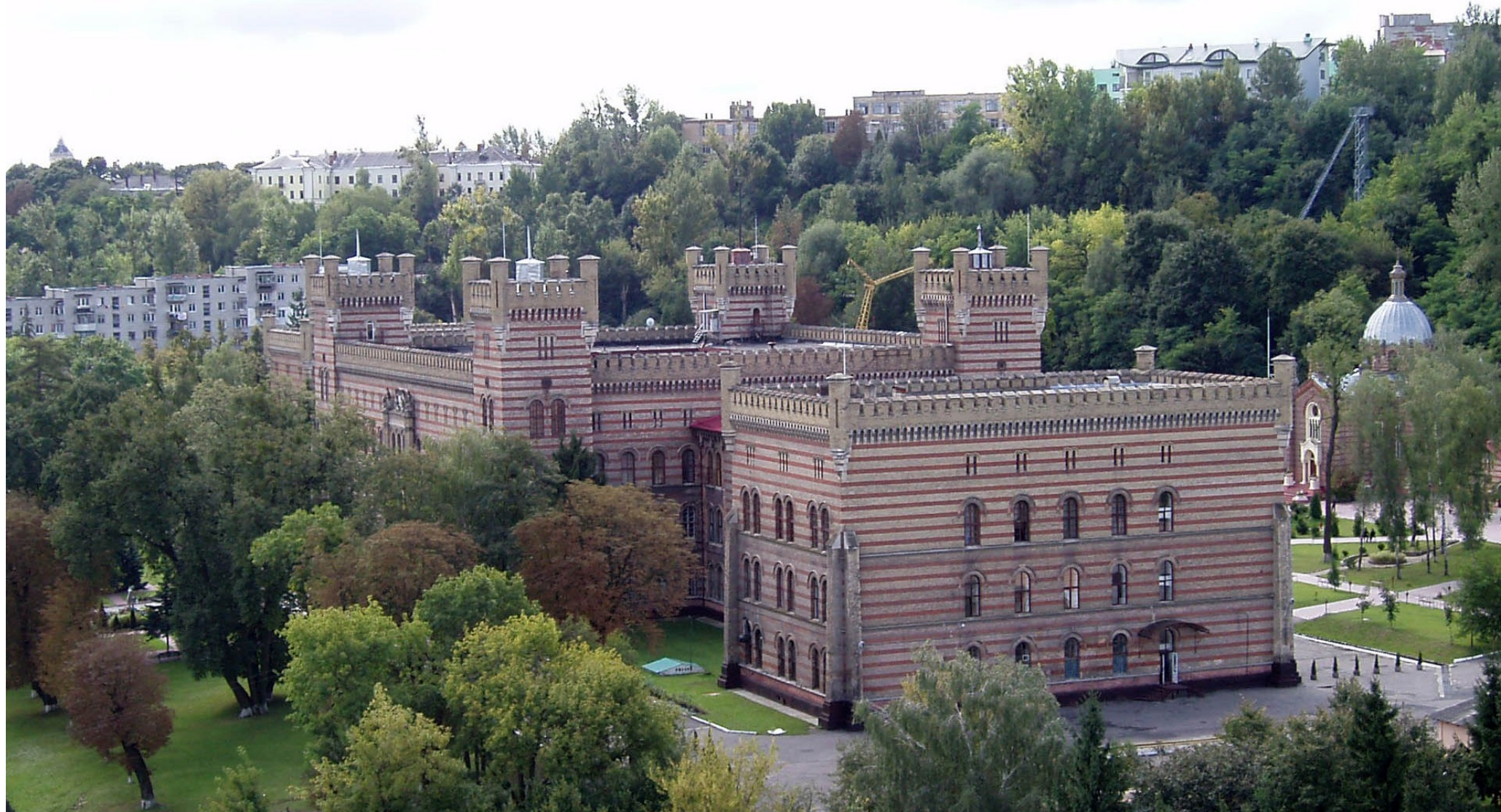

# Kežmarok, evangelický kostel, 1873-90



# Zámek Hernstein, 1856-8

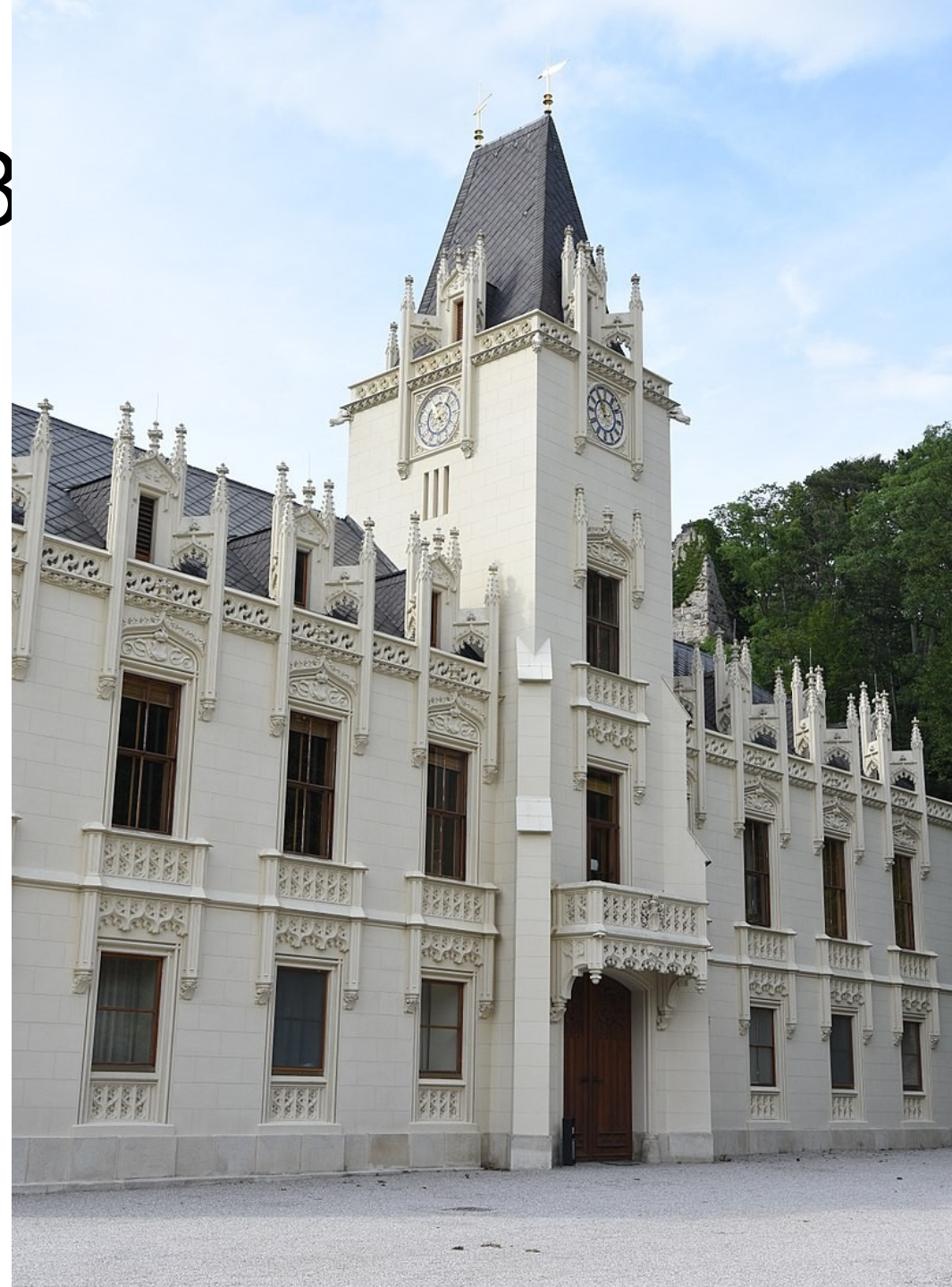

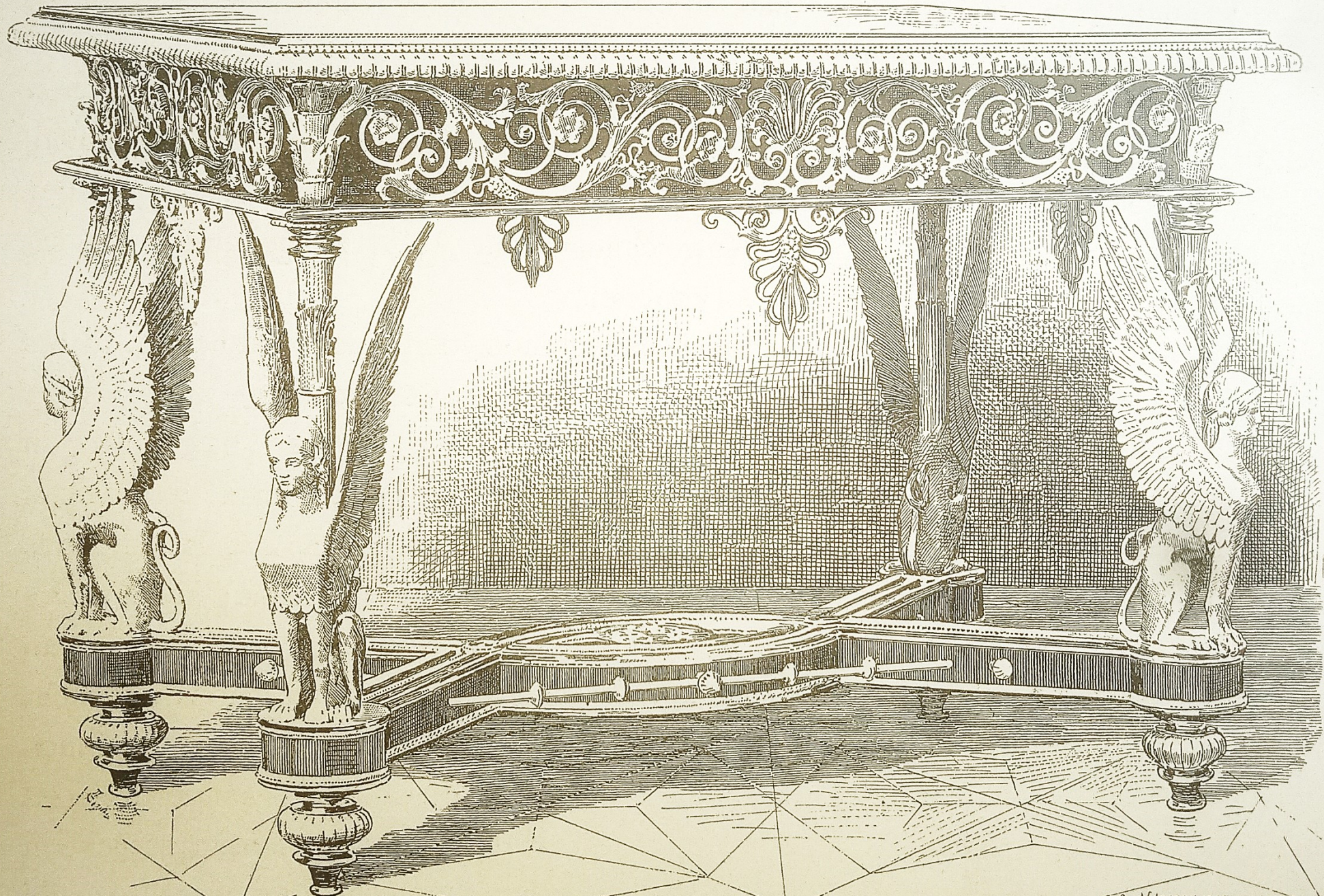

# Nemocnice u sv. Anny s kaplí, 1865-68

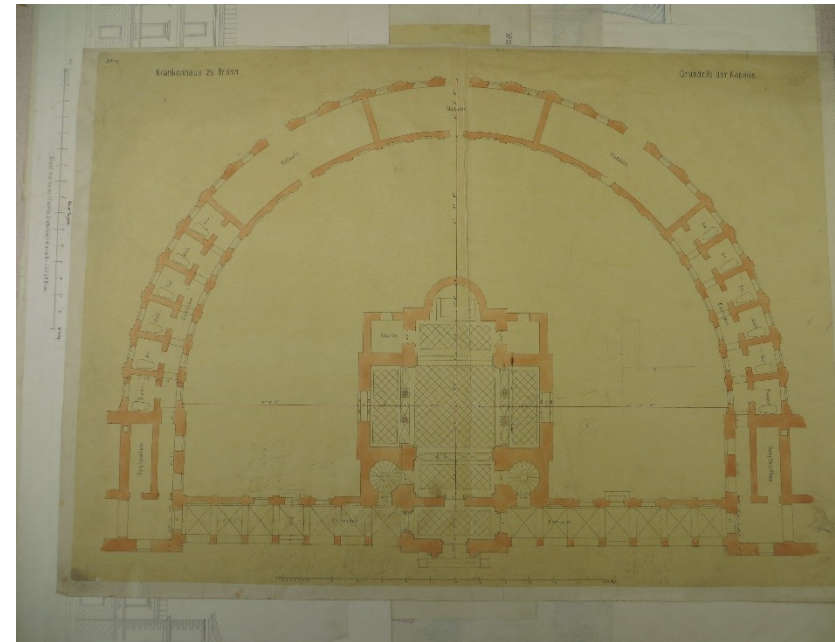
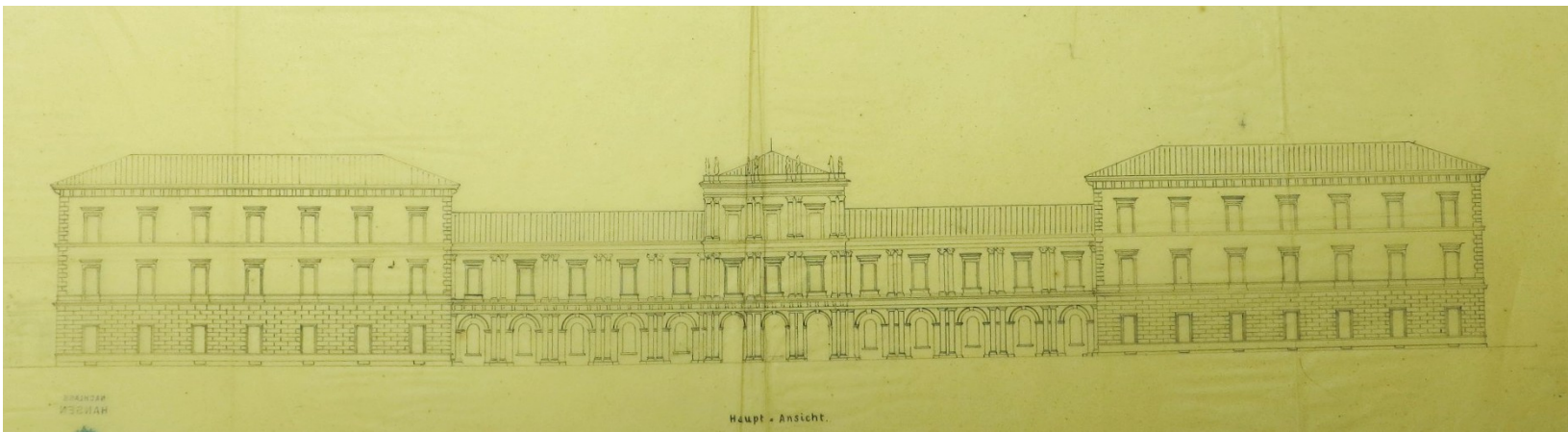
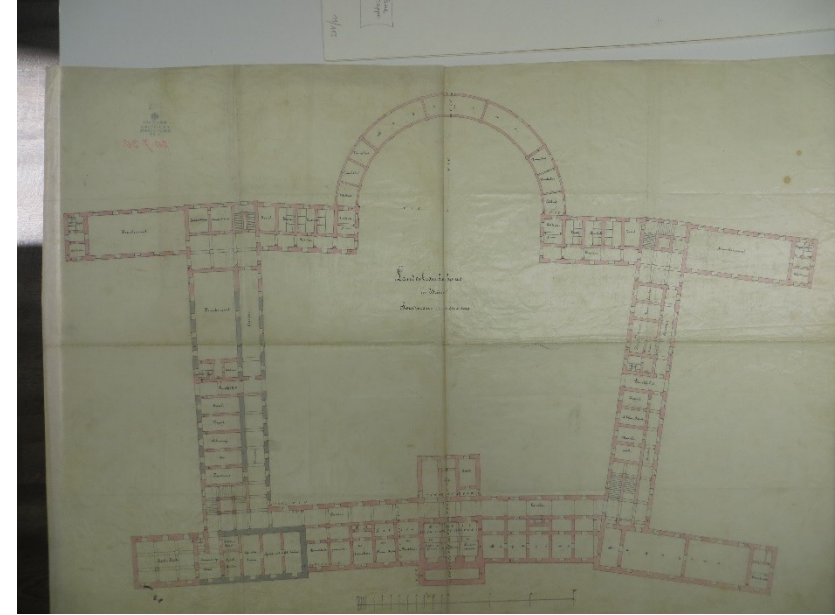

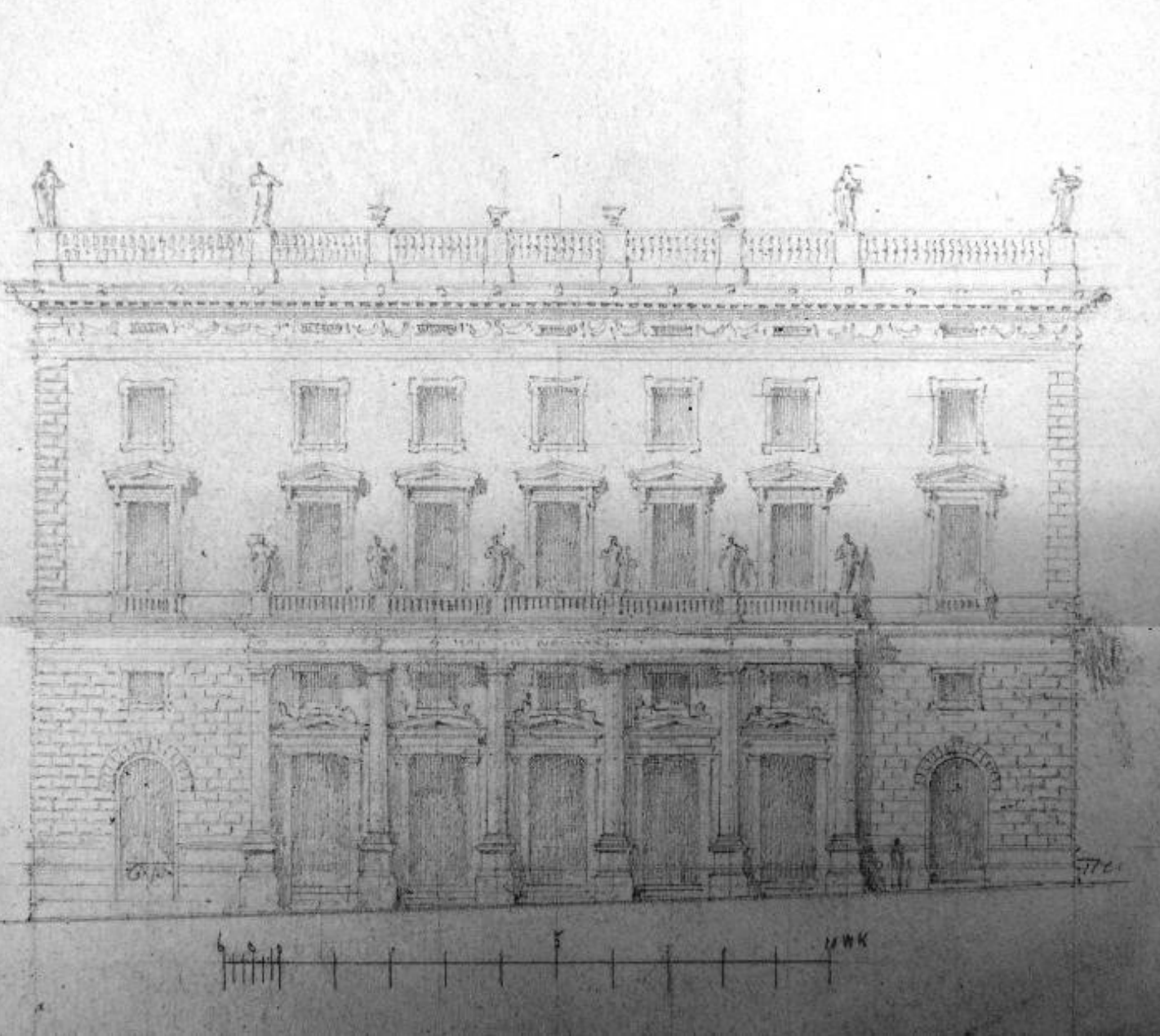





Fig. 1403.

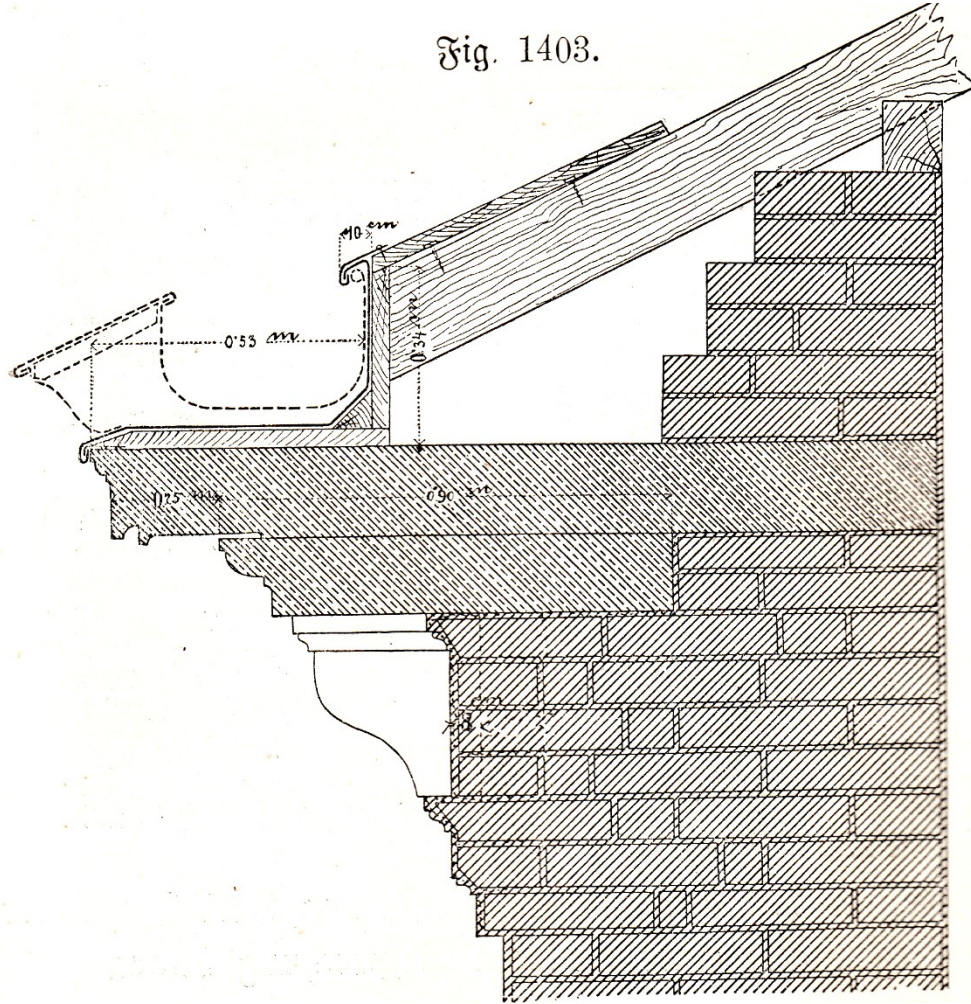

Fig. 1404.

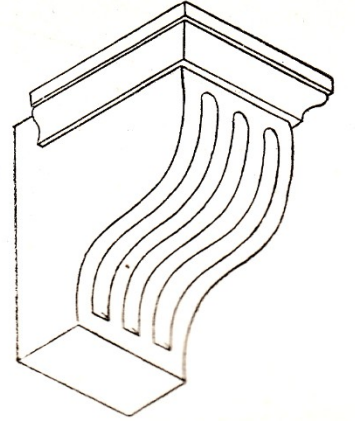
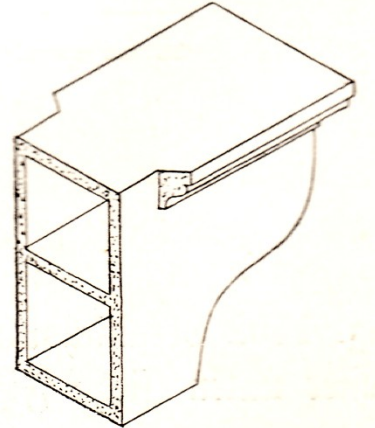
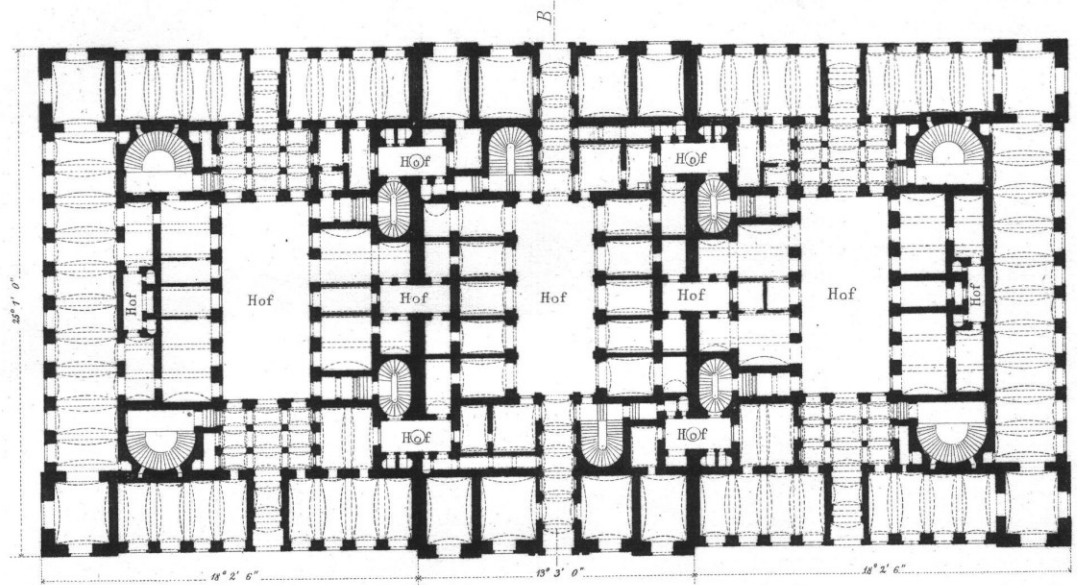

Fig. 1405.









Ringstrasse.

Grundriss des I. Stockes.

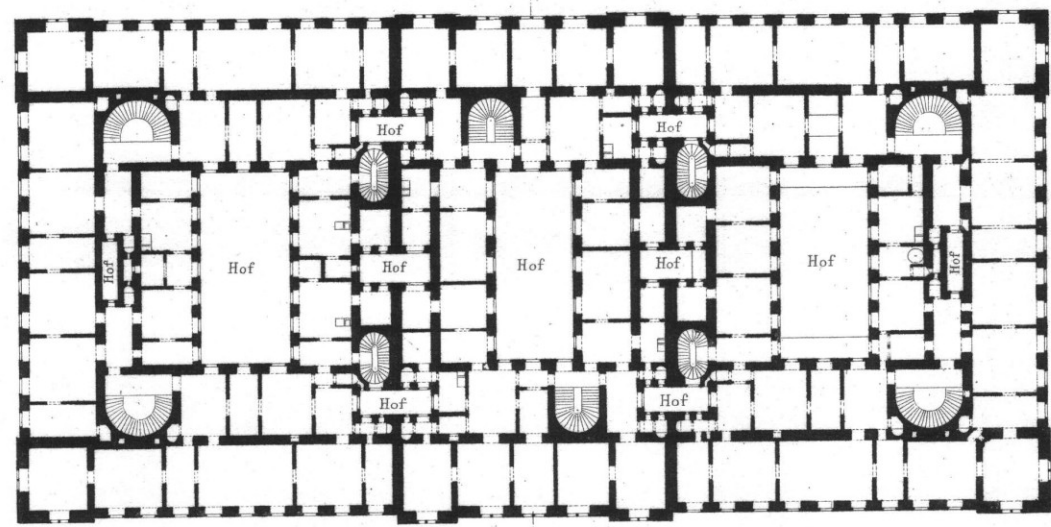

# Evangelická škola, 1859



# Musikverein 1863 a Burza 1868-77



VON H. H. H. H.  
Erdgeschoss.

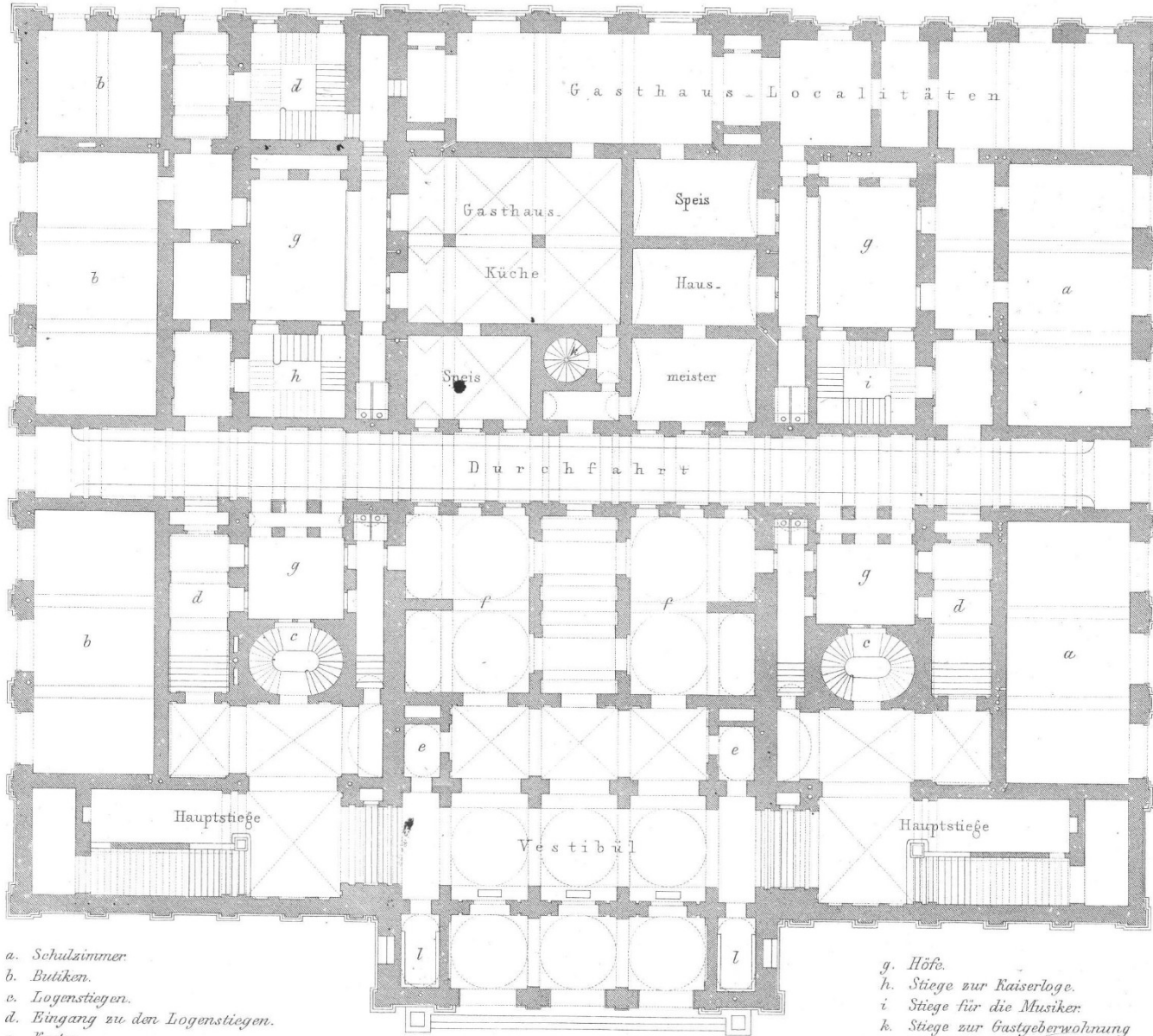

- a. Schulzimmer
- b. Butiken.
- c. Logenstiegen.
- d. Eingang zu den Logenstiegen.
- e. Bänke.
- f. Garderobe.

- g. Höfe.
- h. Stiege zur Kaiserloge.
- i. Stiege für die Musiker.
- k. Stiege zur Gastgeberwohnung im Mezzanin.
- l. Pissoirs.

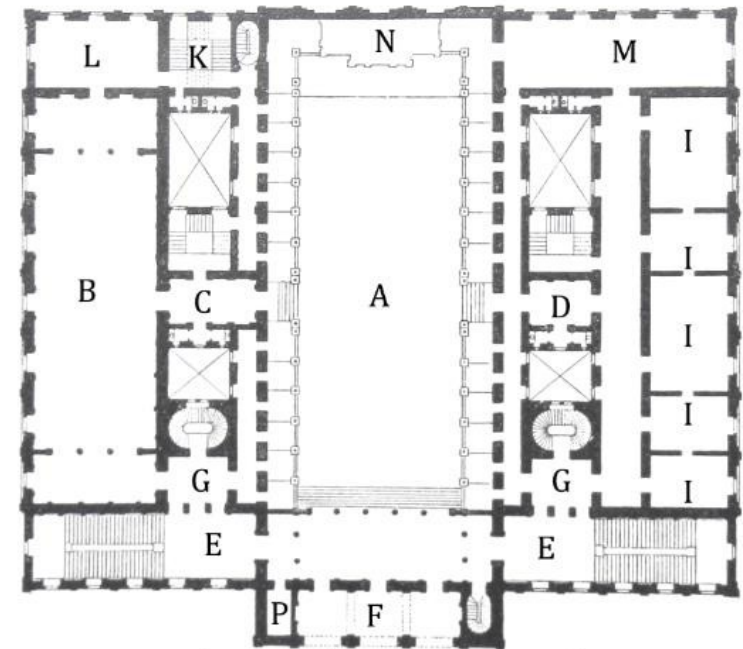

# Parlament 1873-83





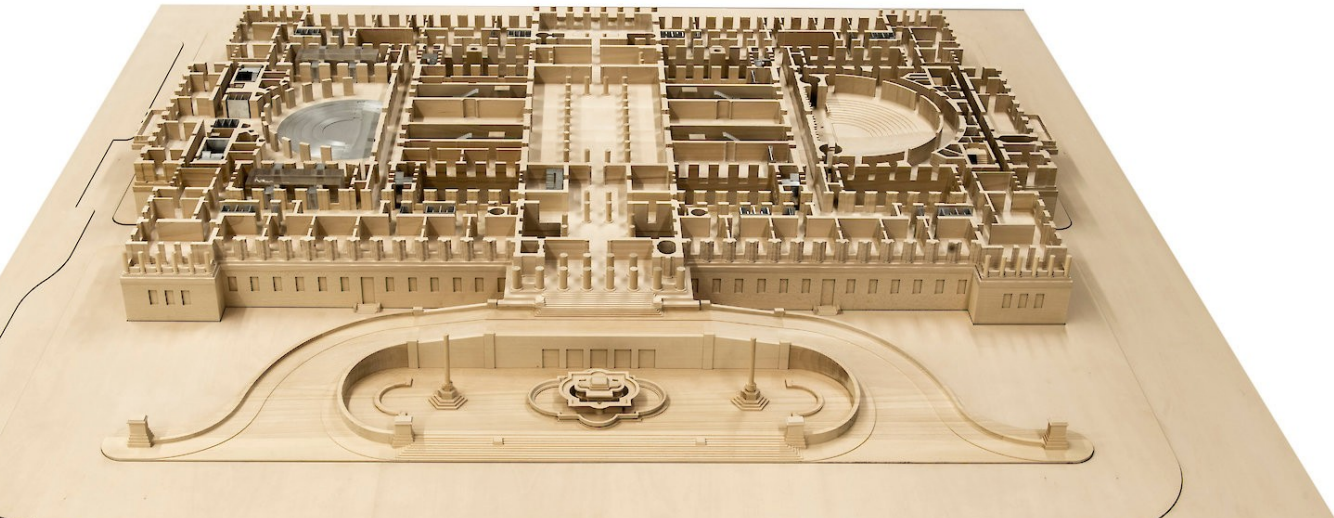



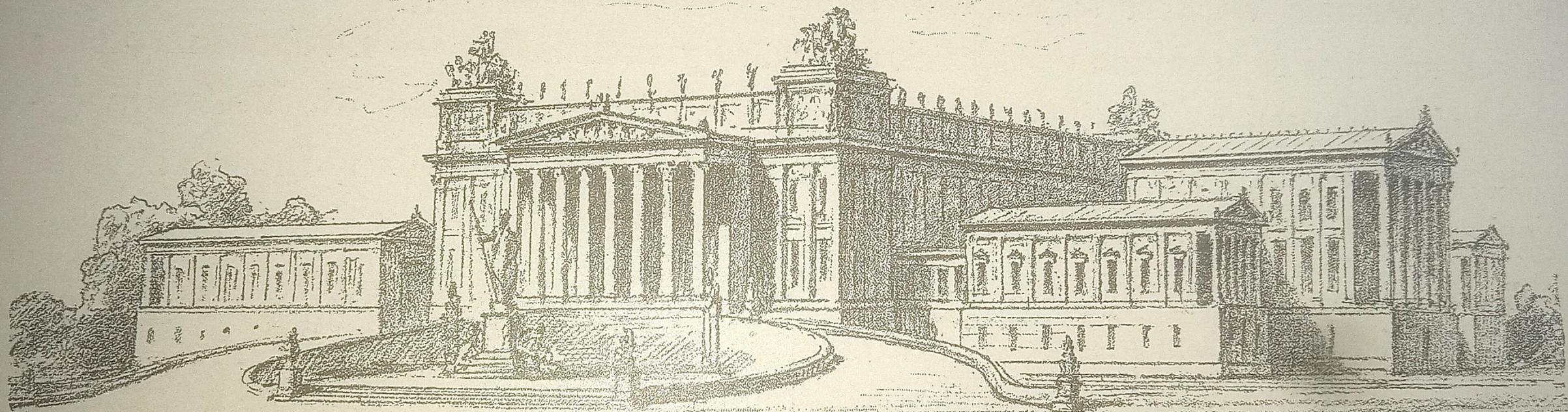

Entwurfsskizze für das Reichstagsgebäude in Berlin.

Herrenhaus  
Haupt-Ansicht.

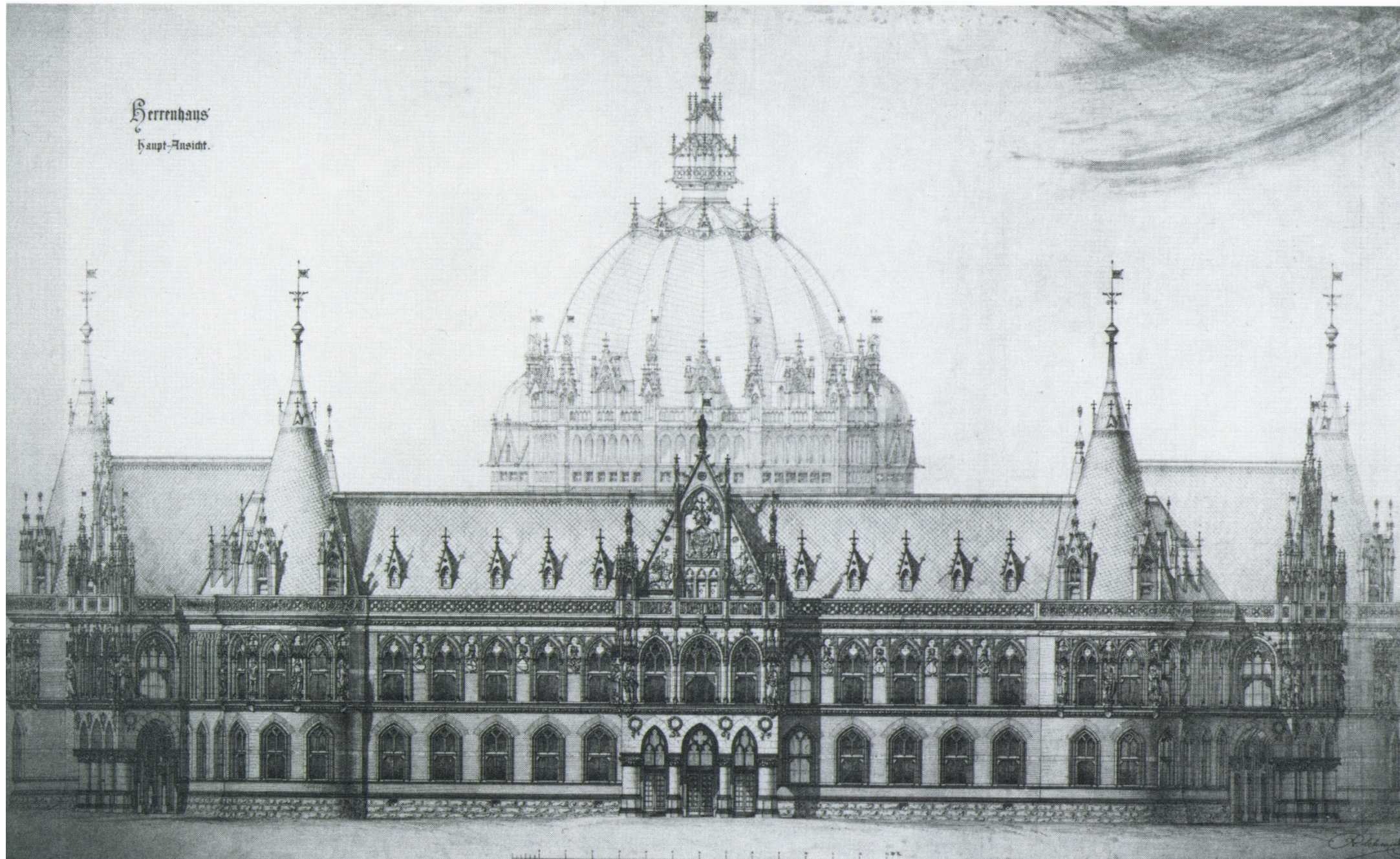

# Alois Prastorfer 1846-1910

## Vrátnice hřbitova, Brno 1881-1883



Dům sochaře  
Johanna Tomoly,  
1885



# Dům Červeného krize 1884-86



# Vojtěch Dvořák 1852-1925 a Karel Welzl (1854-1918)

Průmyslová škola 1899-1901



# Besední dům Jihlava, 1892

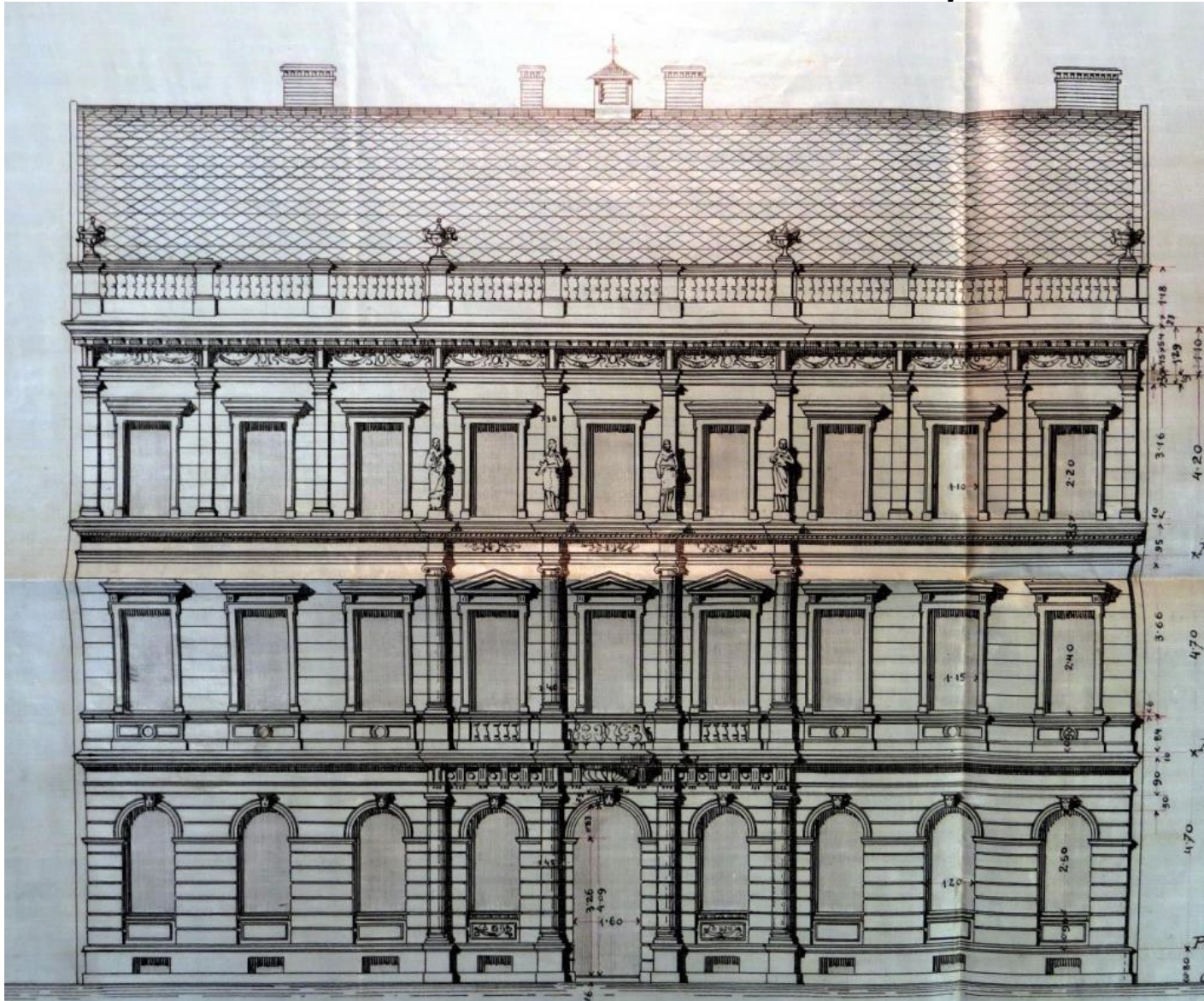





# Jan Koula – Sokolovna Český Brod, 1884



# Karel Welzl, Kostel sv. Rodiny, 1902

