

Dějiny civilizace 10. – 13. století

potraviny

kovy

literatura

- Hoffman, František, 1992: České město ve středověku.
- Dějiny hmotné kultury I (2), 1985.

potravinářská řemesla

- zpracování obilí
 - mlynáři
 - krupníci
 - pekaři
 - sladovníci
 - pivovarníci
- lihovarníci

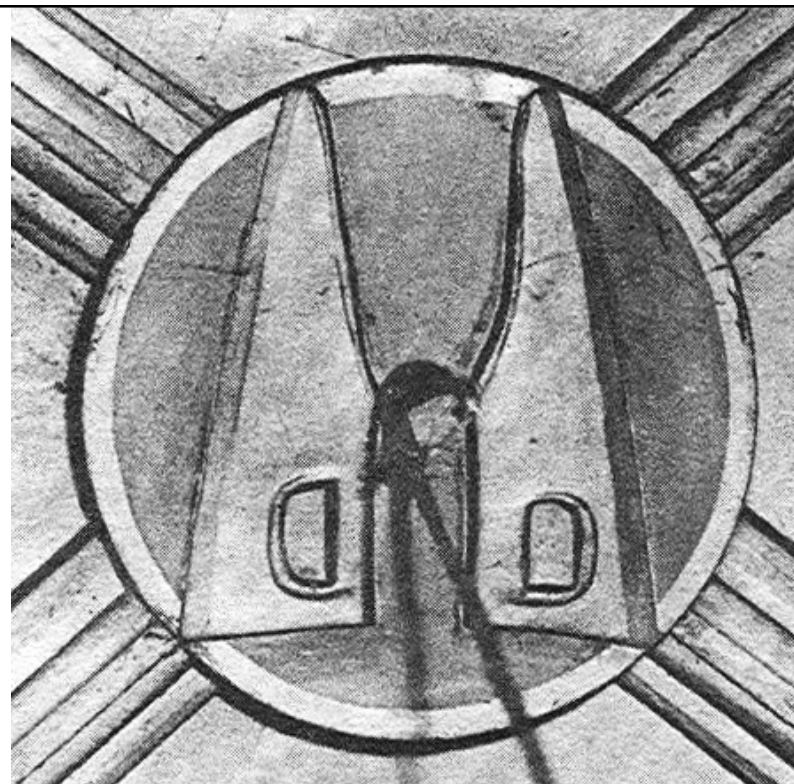

- řezníci
 - huntýři
 - uzenáři
 - drobníci
 - vedlejší produkty
 - lojovníci
 - svíčkáři
 - mydláři
 - olejníci



■ rybáři

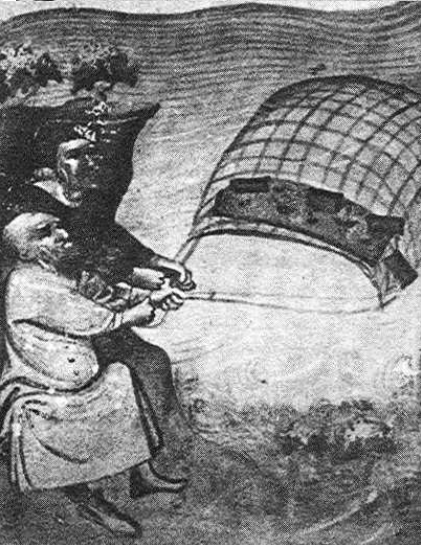

strava

- moučné pokrmy
- mléčné pokrmy
- maso
- zelenina, ovoce
- koření
- sůl
- nápoje
- sladidla

- hody
- postní jídla
- stolování

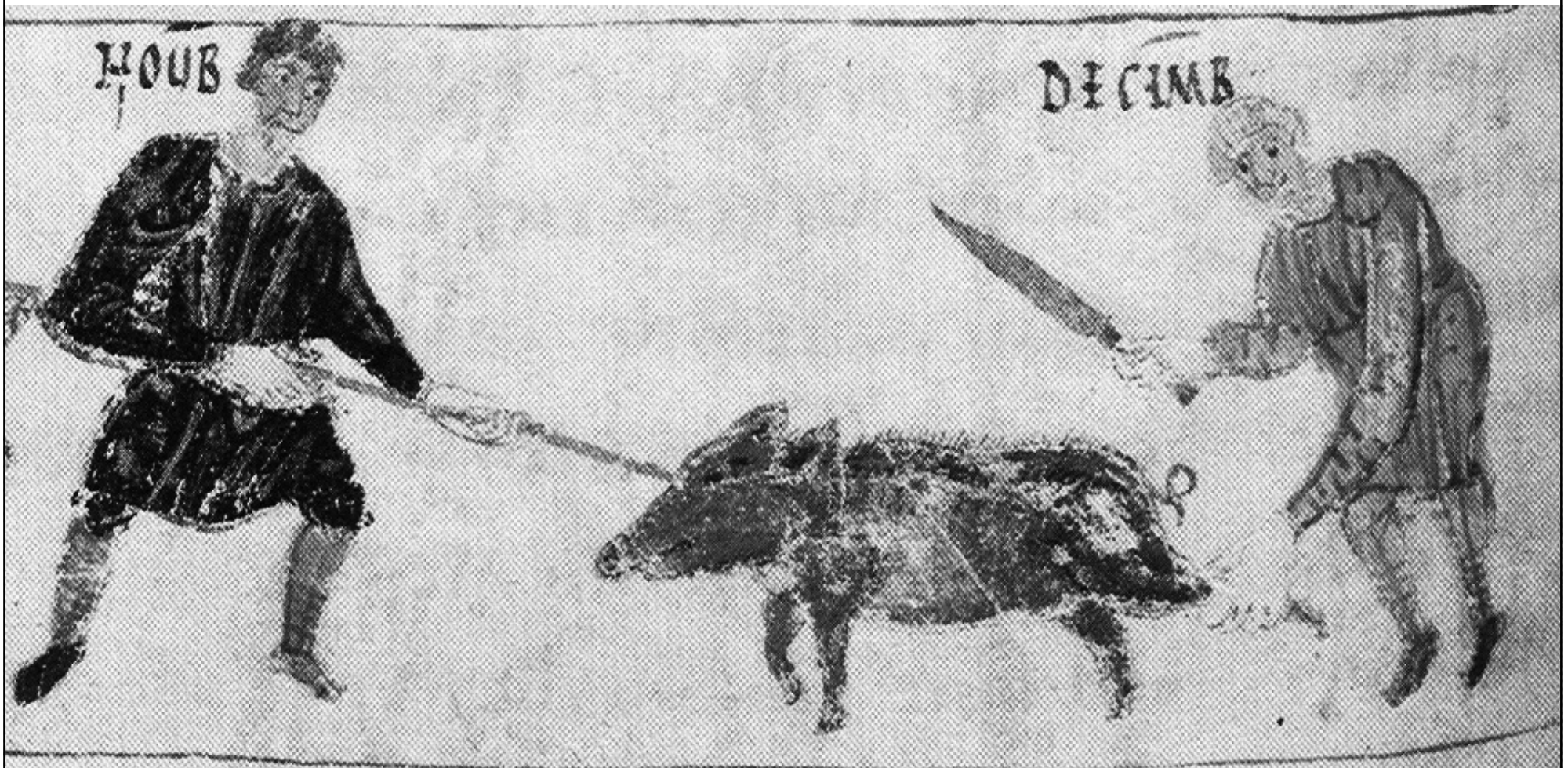

kovodělná řemesla

- černá řemesla
- bílá řemesla

kováři

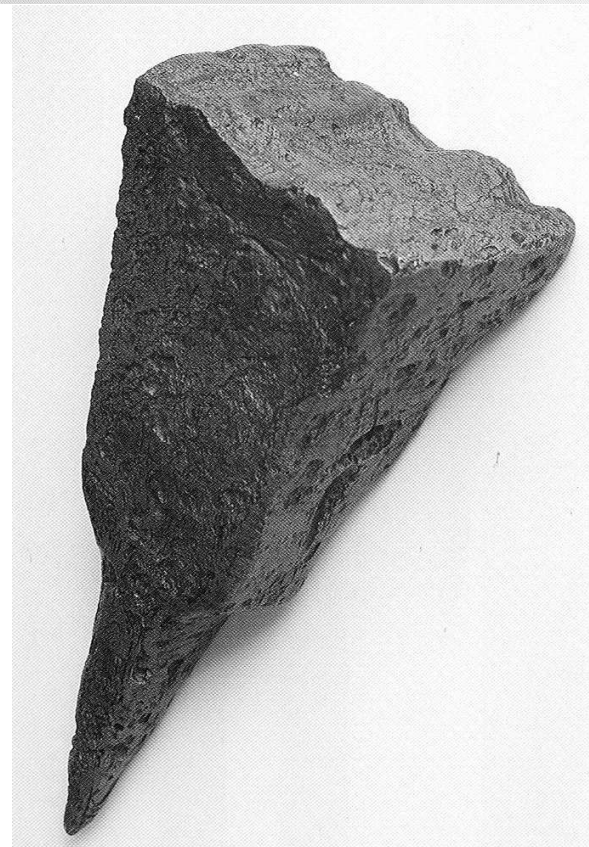

zámečníci

- zámek
 - závěsný
 - svorníkový
 - třmenový
- klíč
 - zásuvný
 - otočný

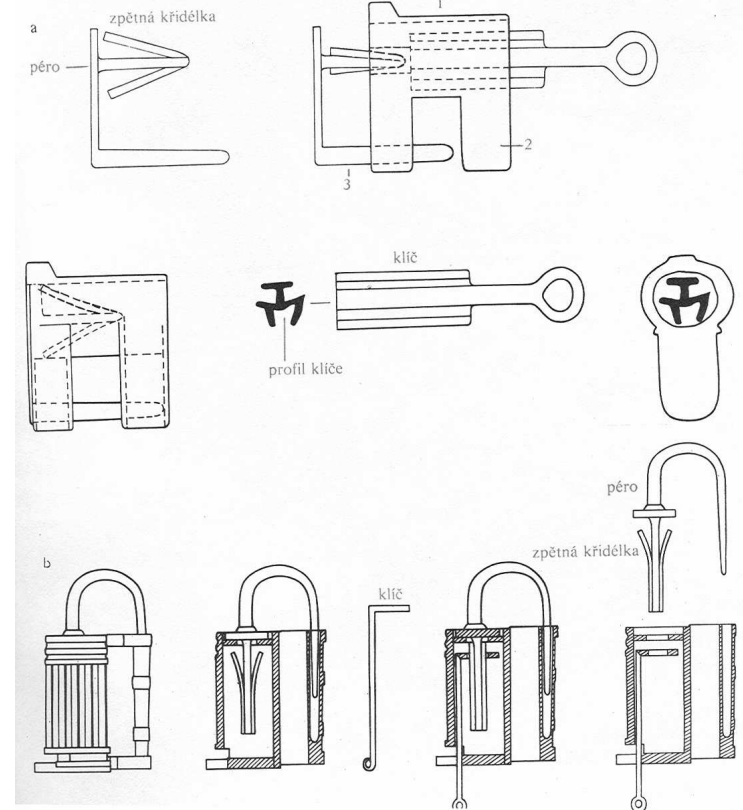

TŘMENOVÝ

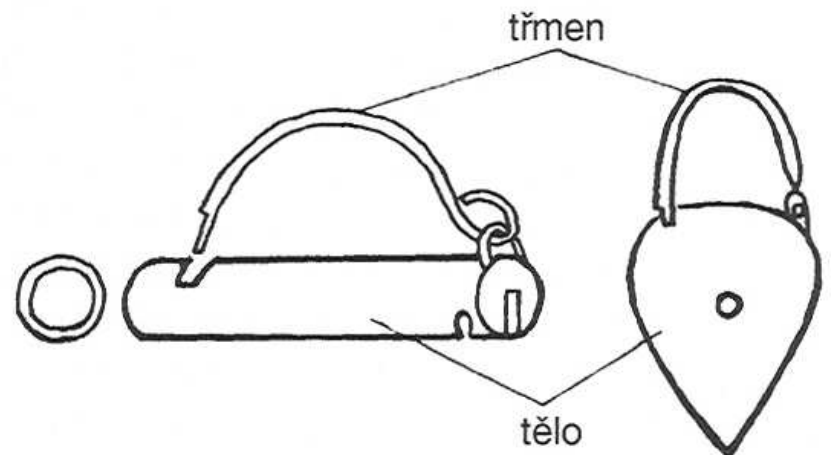

SVORNÍKOVÝ

ZÁMKOVÁ ČÁST

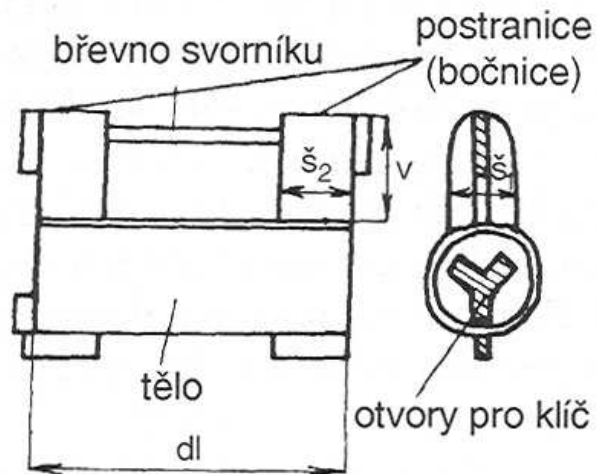

SVORNÍKOVÁ ČÁST

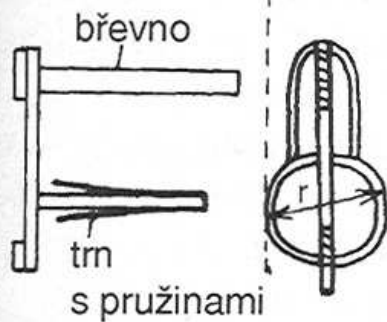

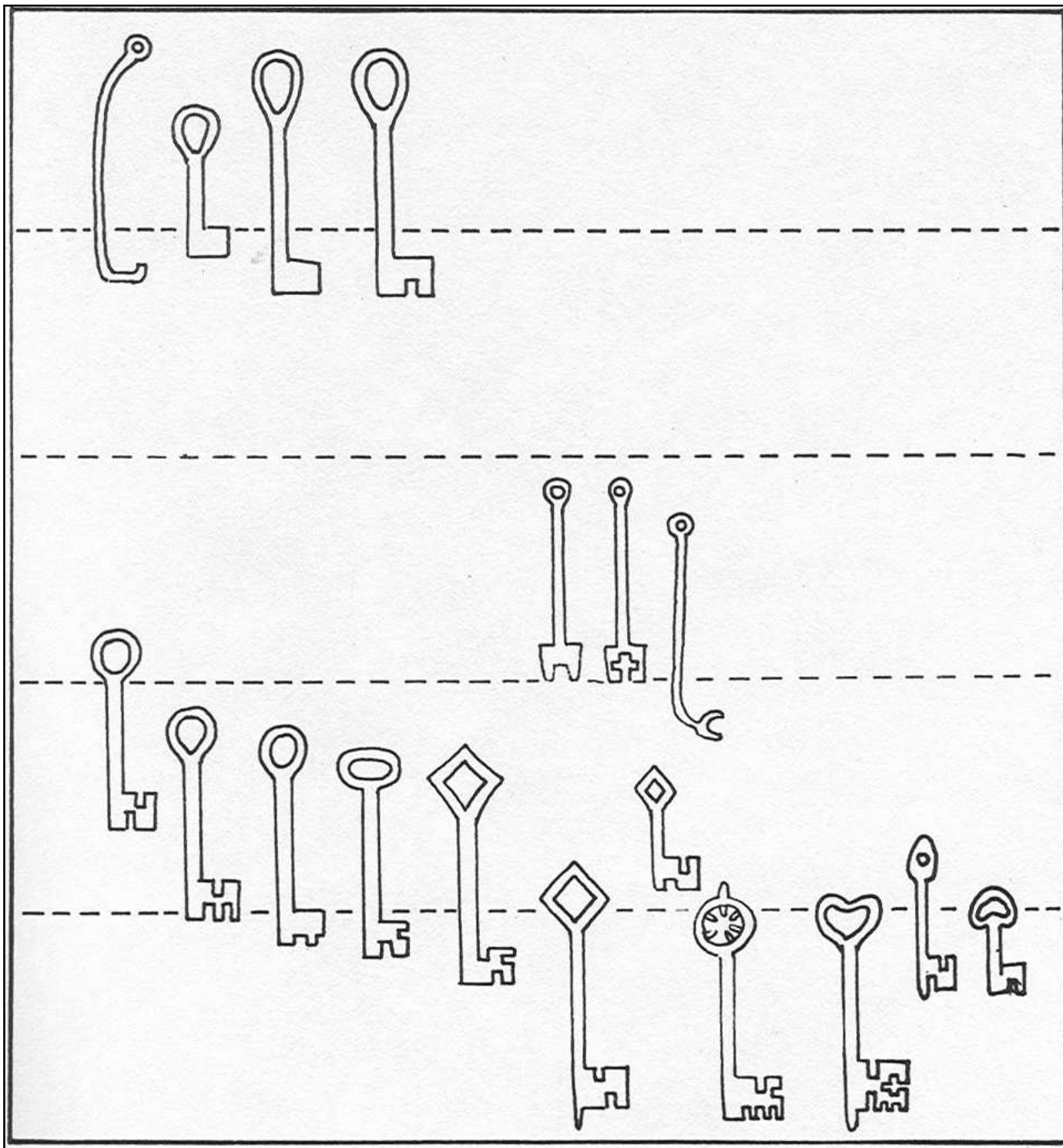

1000

1100

1200

1300

1400



I. závěsné

svorníkové

třmenové

pružinové

závorkové

pružinové

závorkové

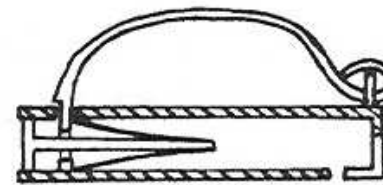
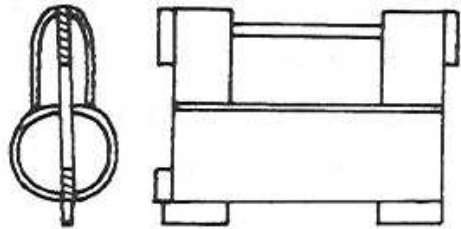
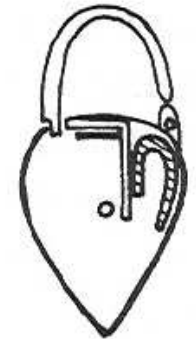
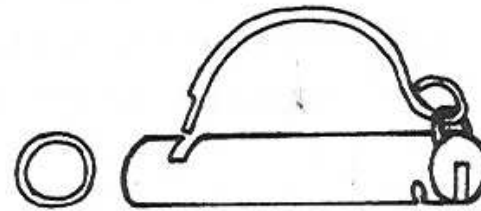
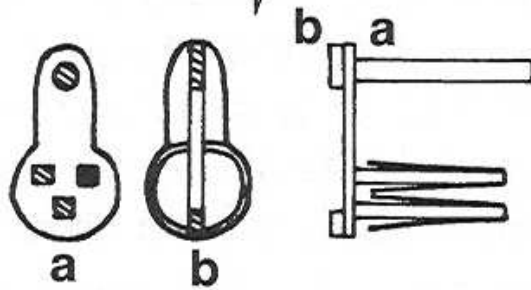

typ I

typ II

typ III

- kovolitci
- kovotepci

