

# Dějiny civilizace 10. – 13. století

Český stát

## literatura

- Durdík, T. 1999: Ilustrovaná encyklopedie českých hradů. Praha.
- Le Goff, J. – Schmitt, J. – C. 1999.: Encyklopedie středověku. Praha.
- Nodl, M.-Šmahel, F. 2002: Člověk českého středověku.
- Plaček, M. 2001: Ilustrovaná encyklopedie moravských hradů, hrádků a tvrzí. Praha.

# Čechy okolo roku 1000

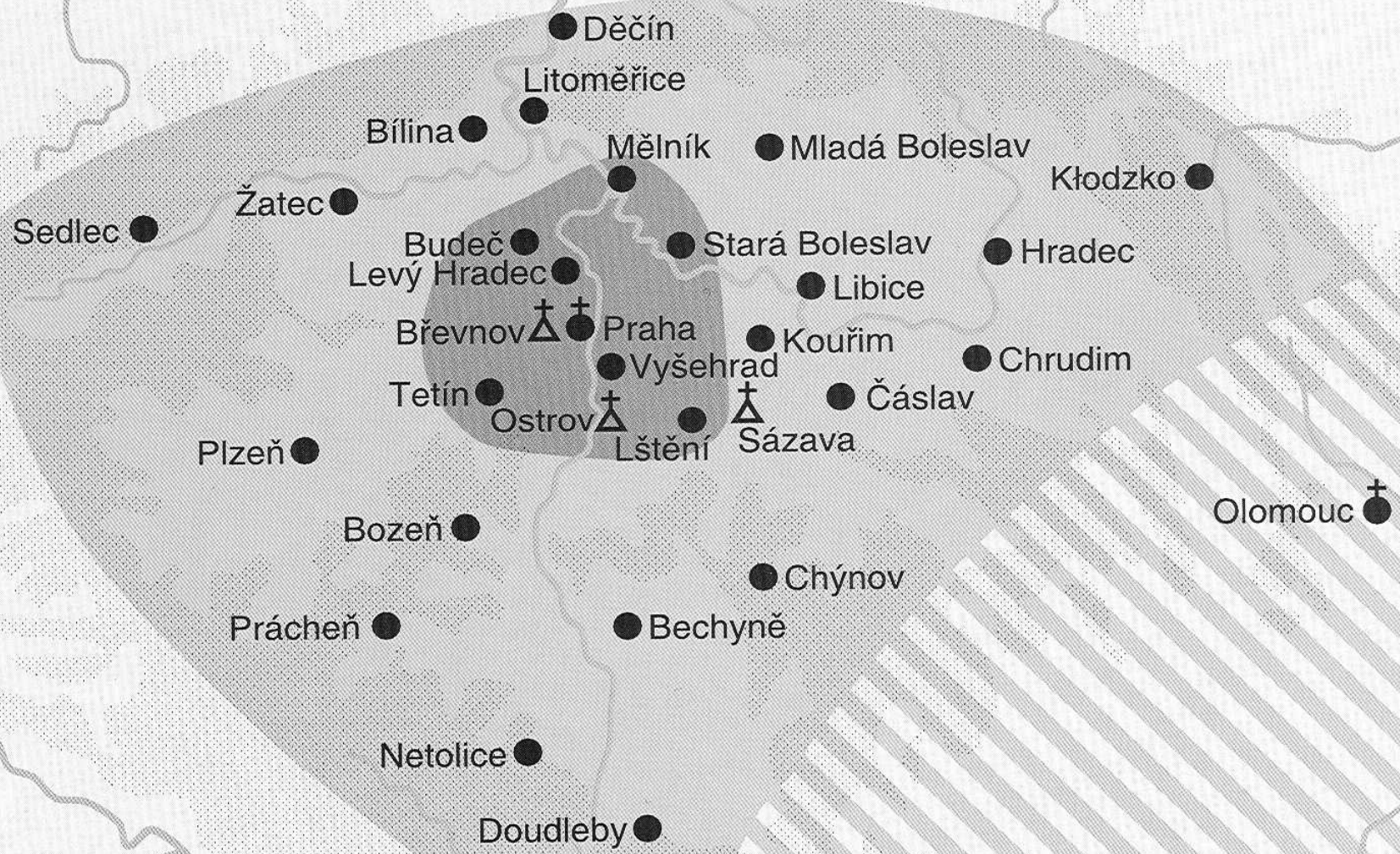
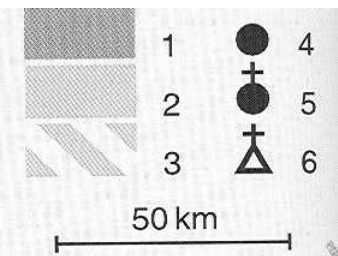

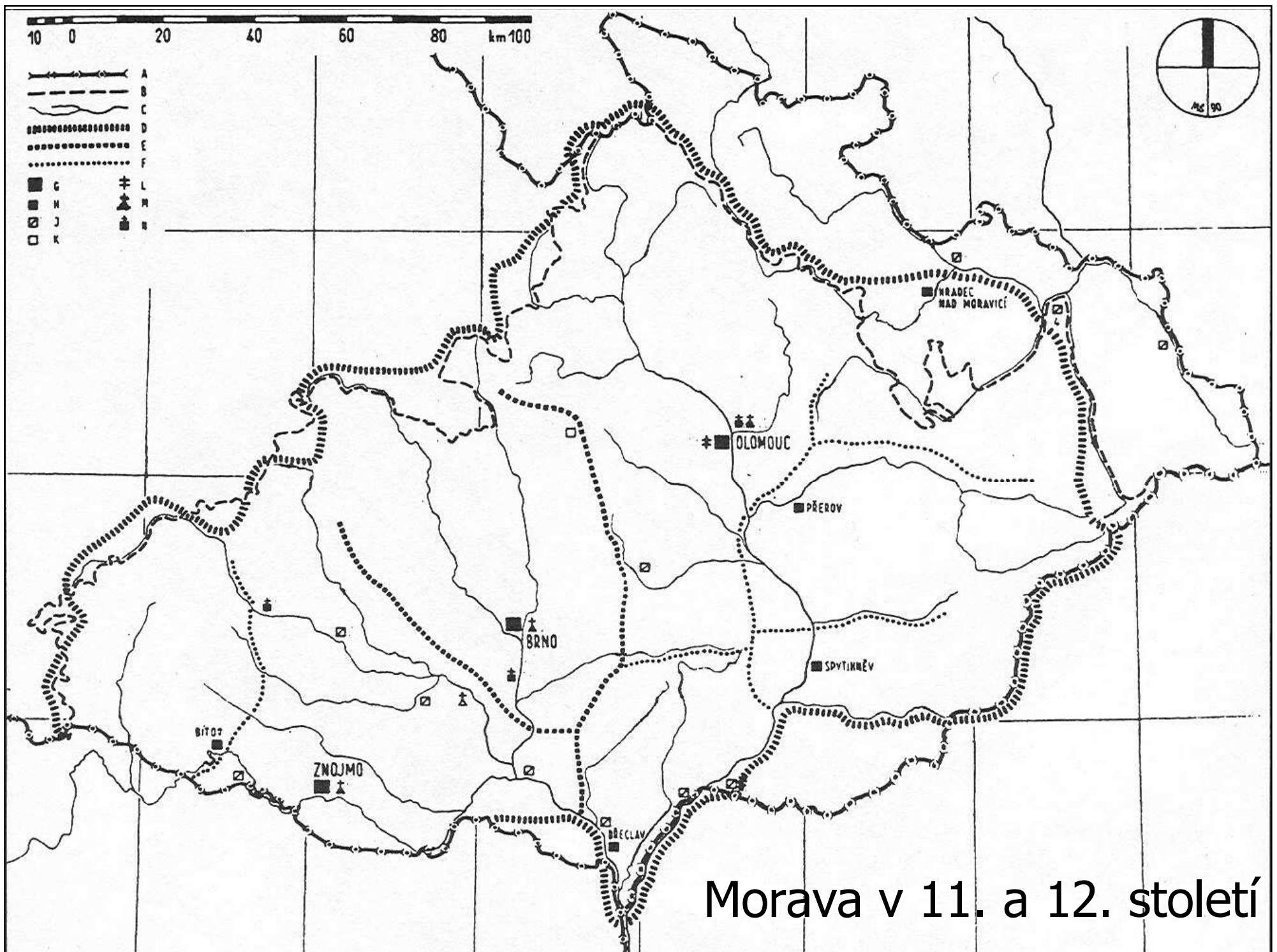

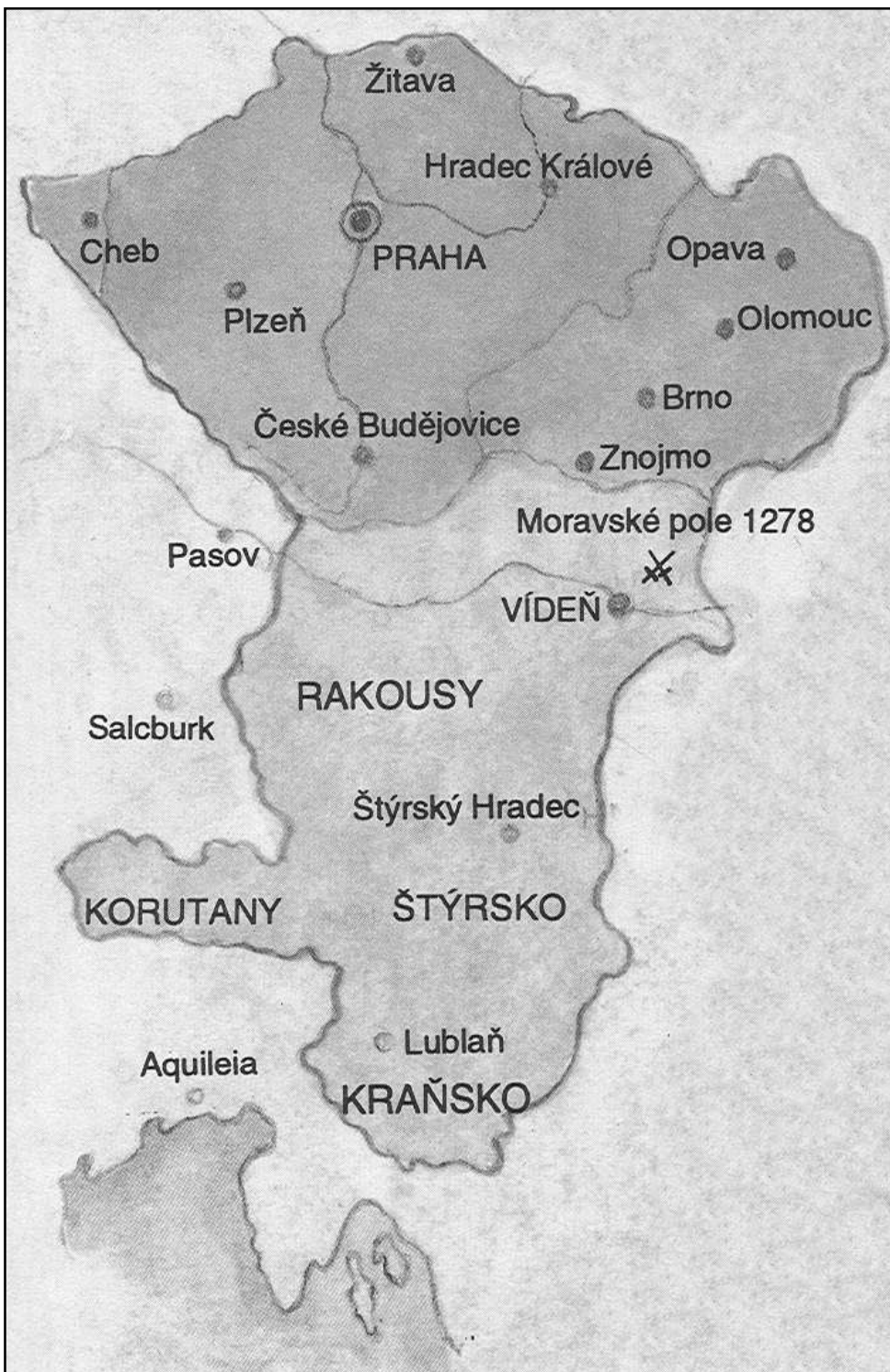

- Český stát za Přemysla Otakara II.
- Český stát za Václava II. a Václava III.

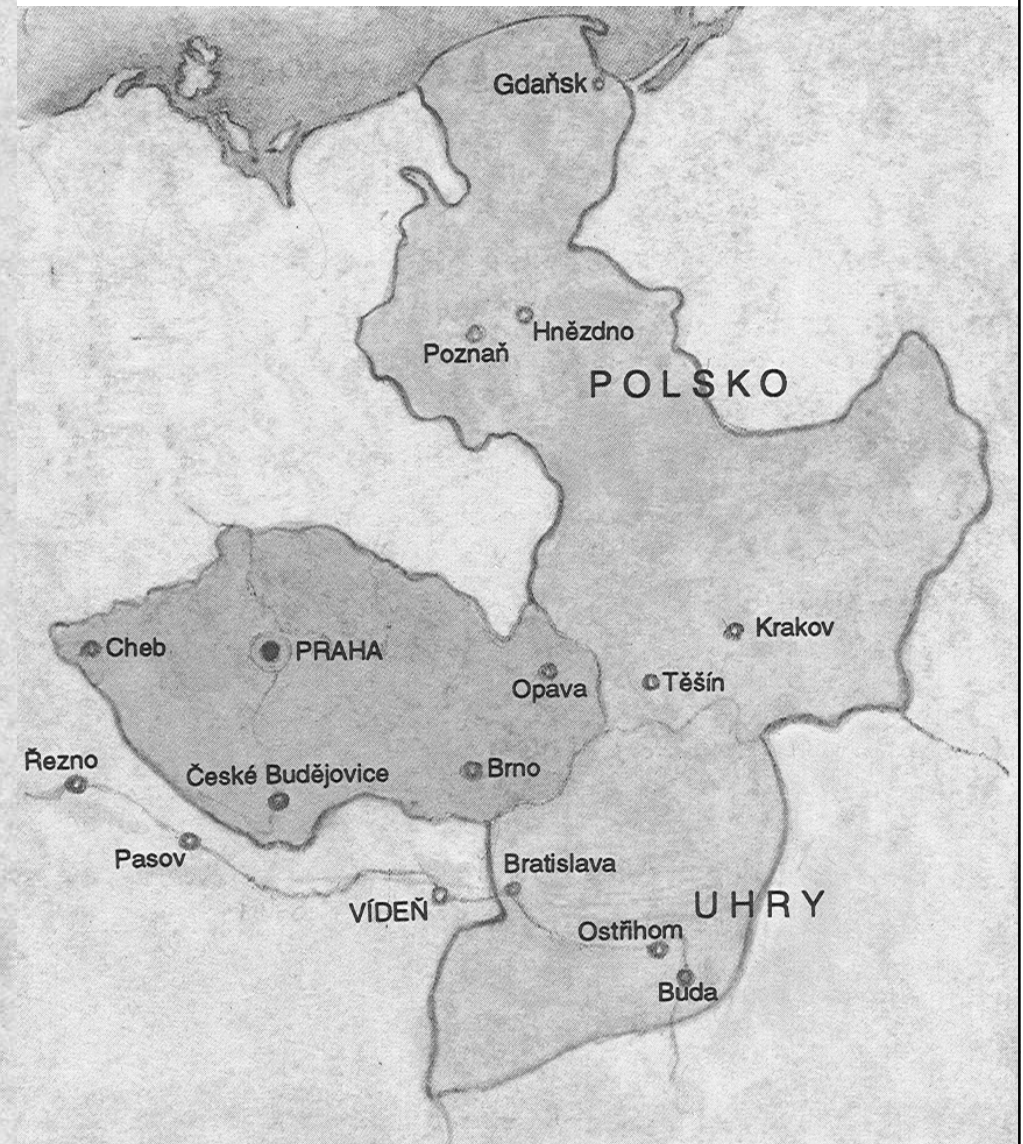



# Svatá říše římská

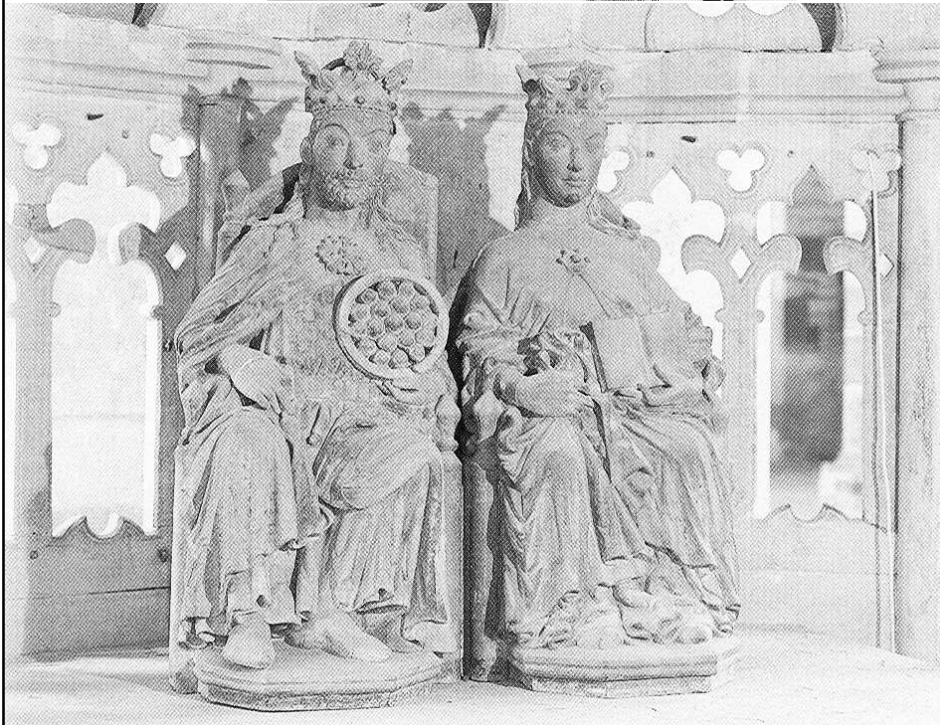
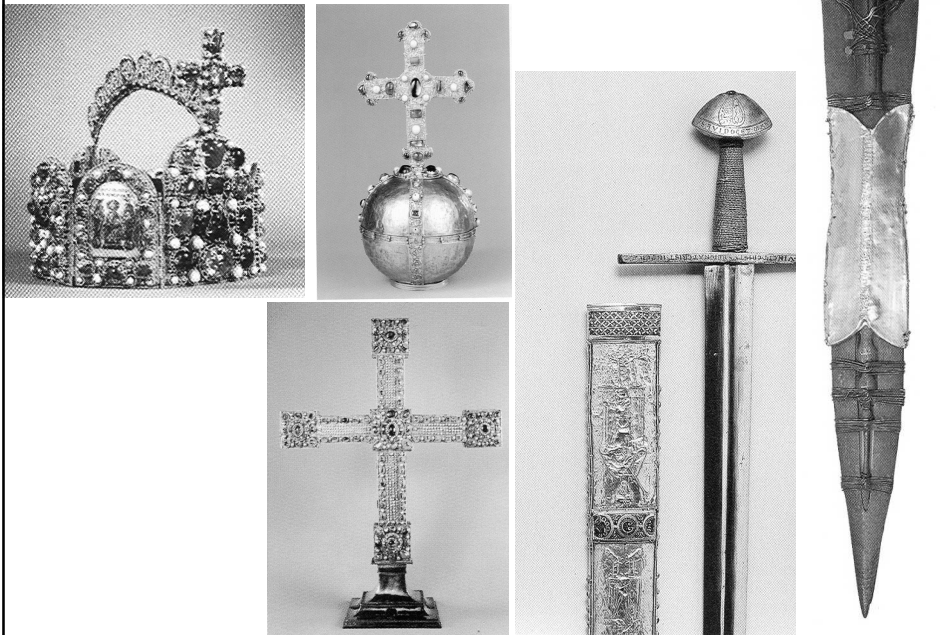

# panovník

## ■ kníže

- praporec
- přilbice
- štít

## ■ král

- koruna
- žezlo
- jablko

## ■ dvůr

- komorník
- kancléř
- notář
- maršálek
- dvorský sudí
- jídlonoš
- číšník
- mečník
- kuchař



## velmoži - šlechta

- páni
- rytíři
- zemani
- vladykové
- zemské desky
- zemský soud
- dominium generale
- dominium speciale

# sídla

- hradiska
- dvorce
- hrady
  - hrad přechodného typu
  - hrad s obvodovou zástavbou
  - francouzský kastel
- bergfritová dispozice

hradiska

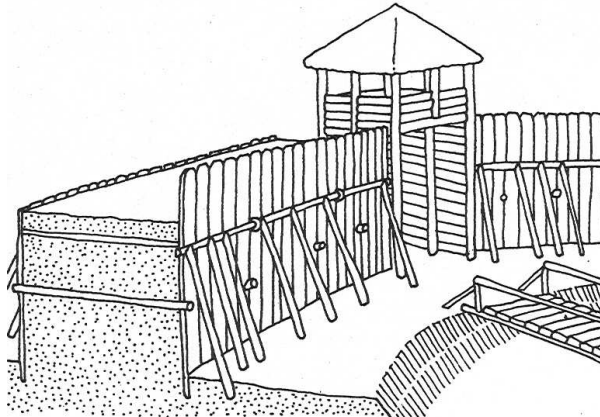
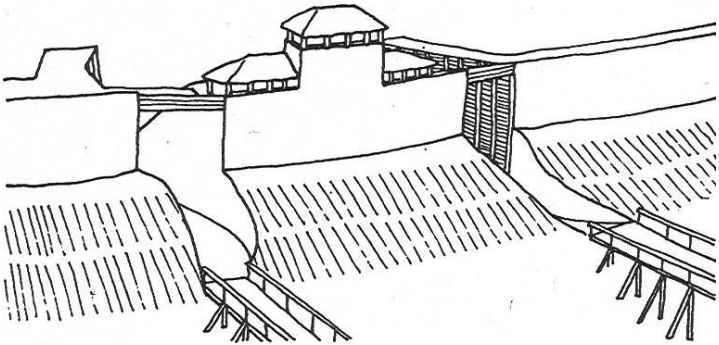
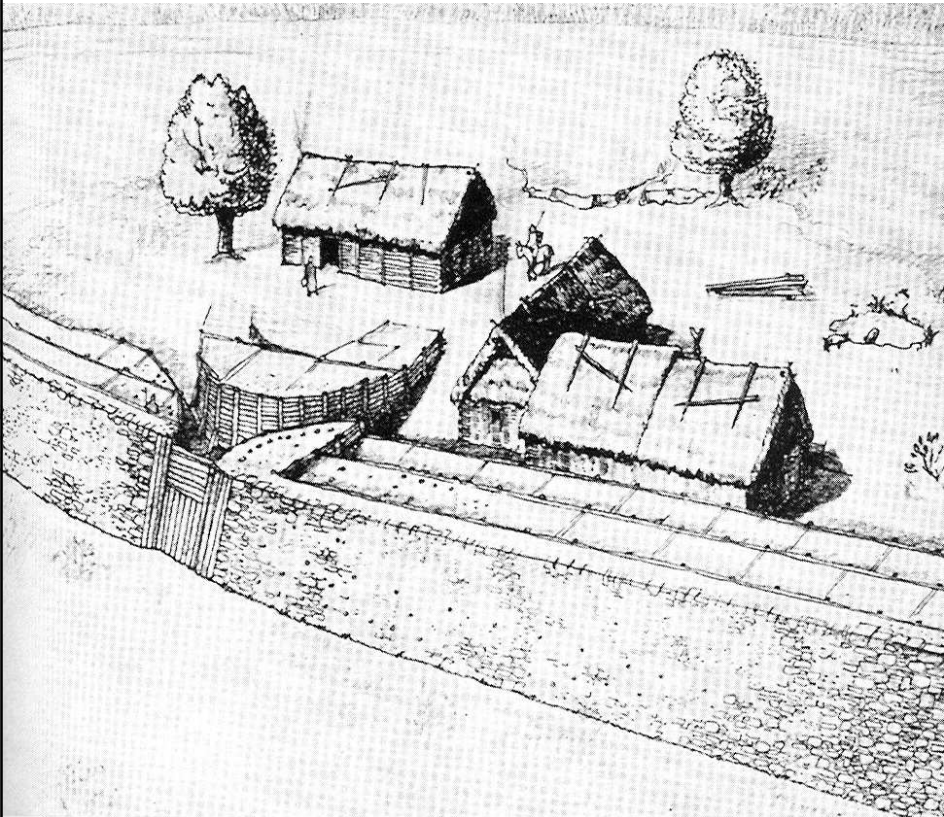
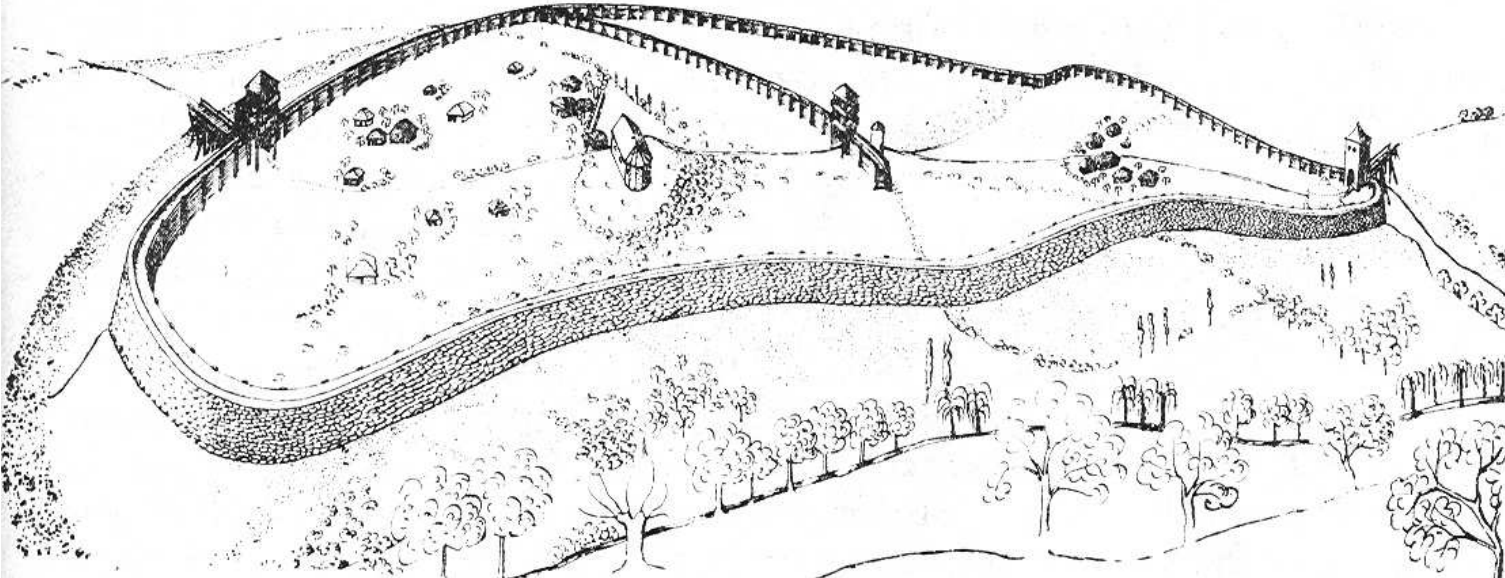

valy

■ roštová konstrukce

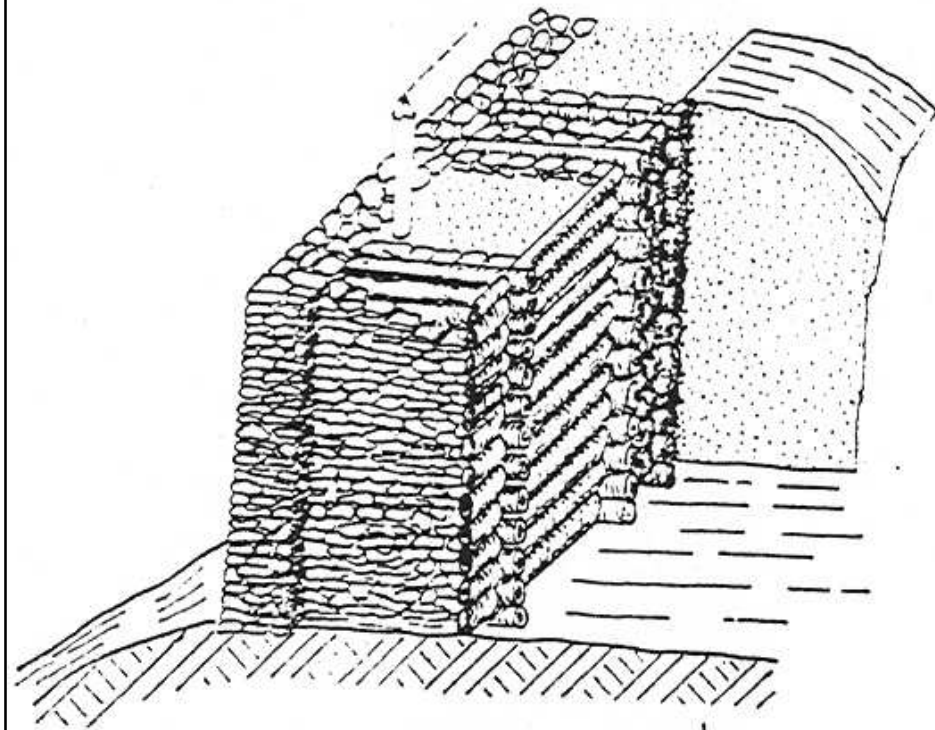
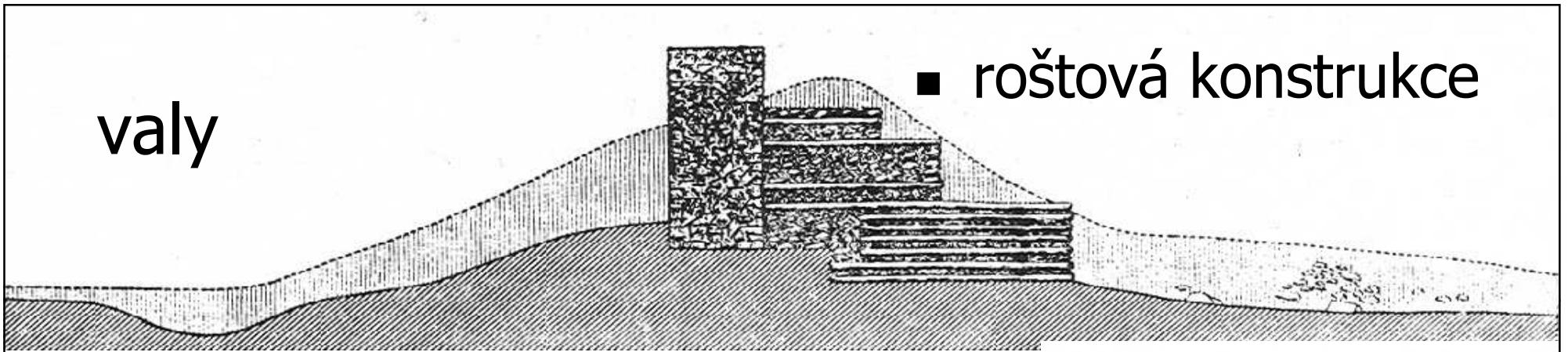

■ komorová konstrukce

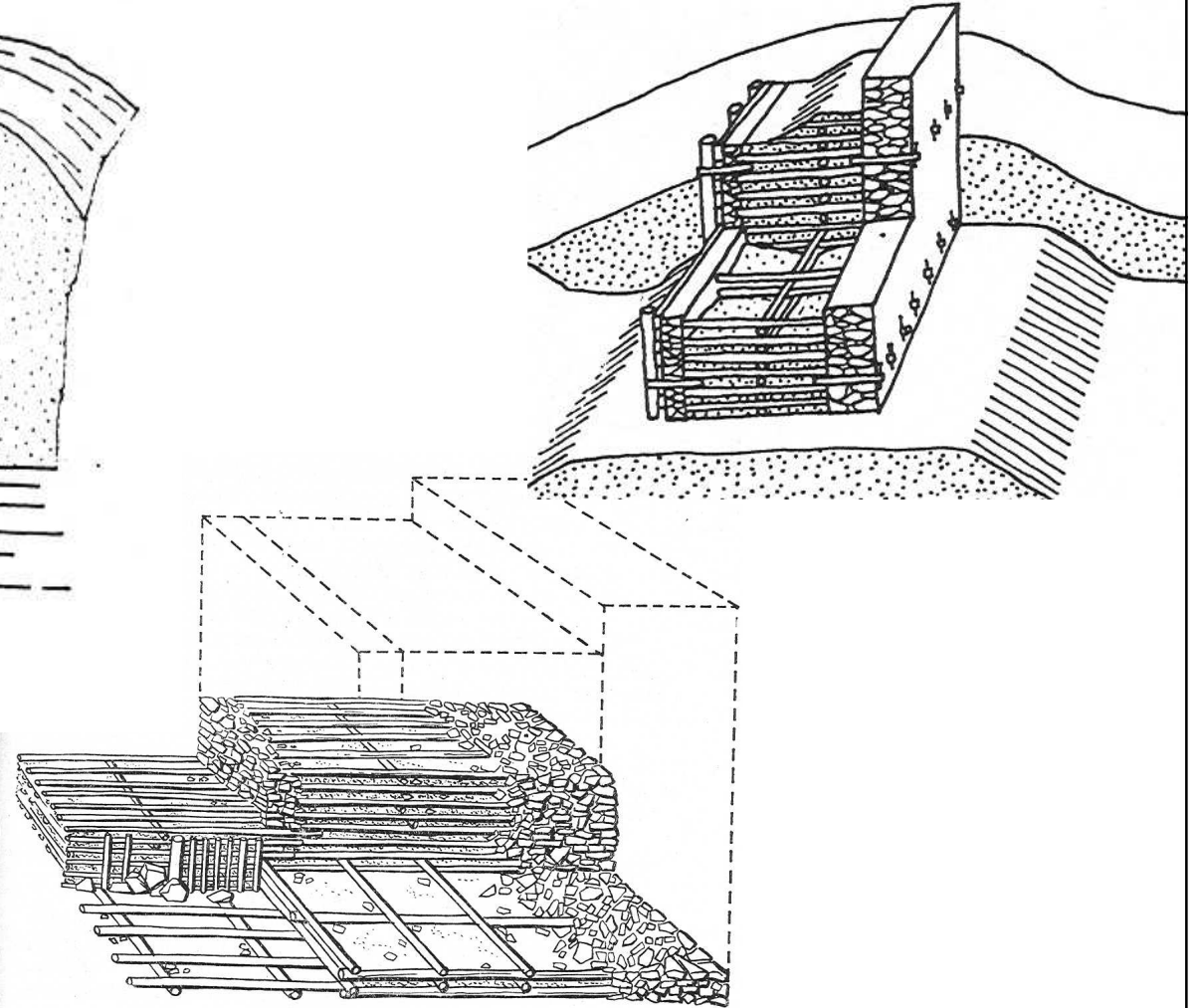

dvorce

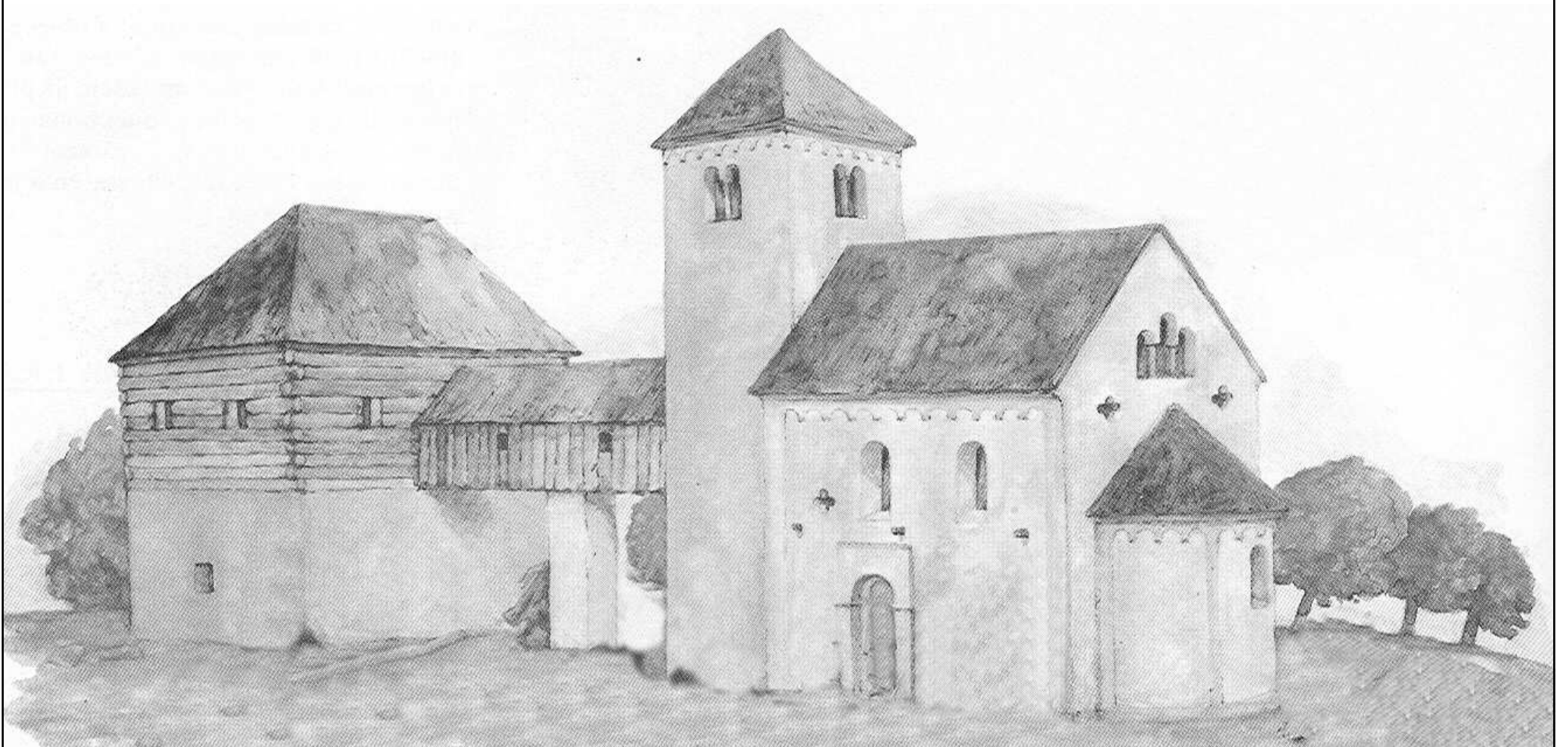

# Pražský hrad

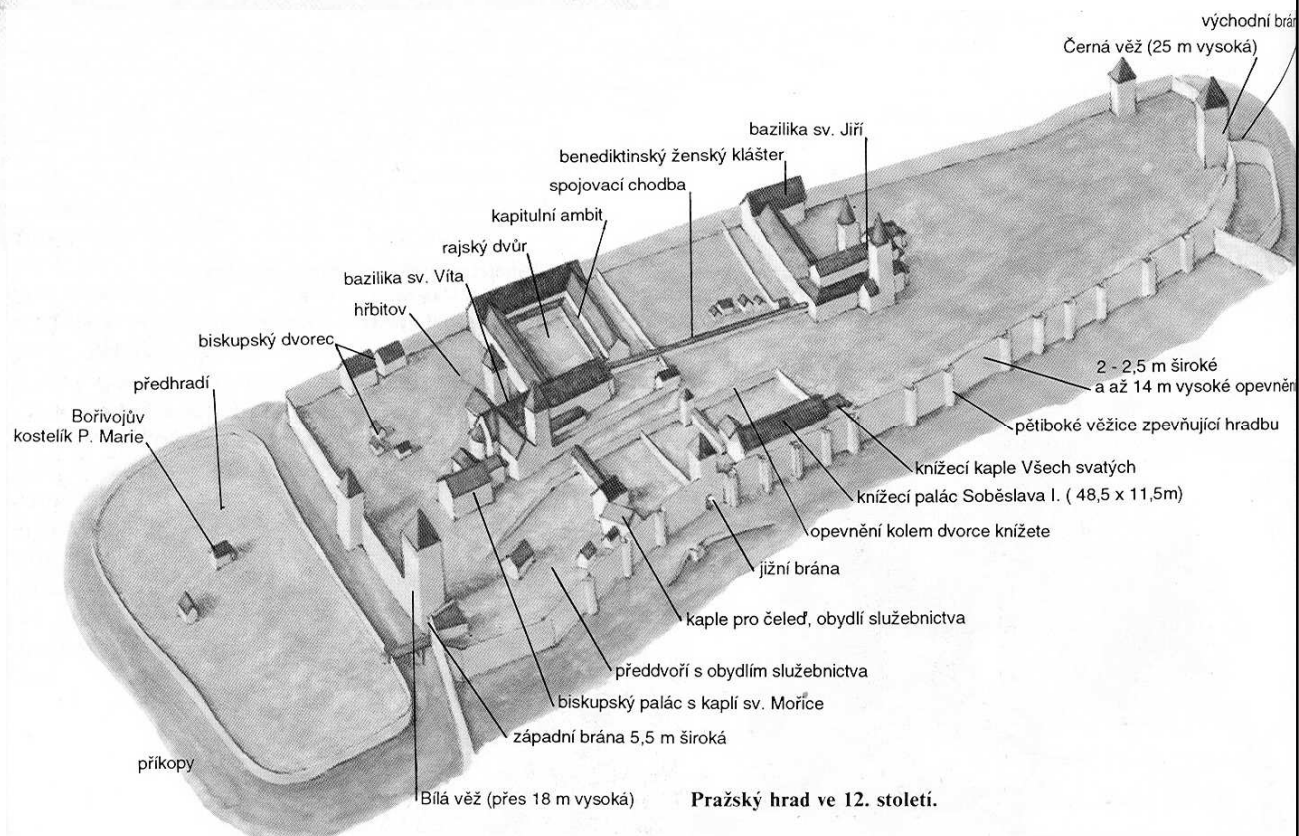
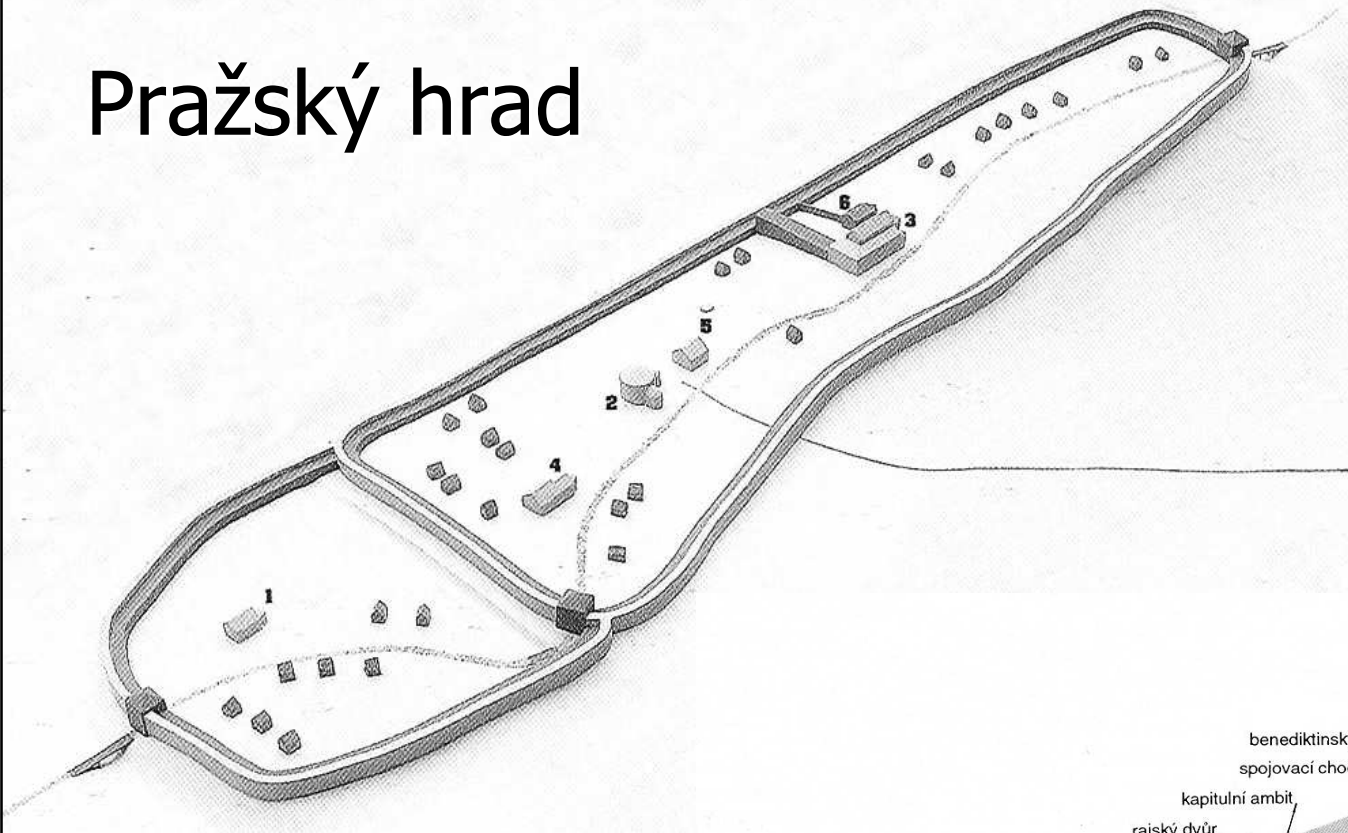

# Hnězdno

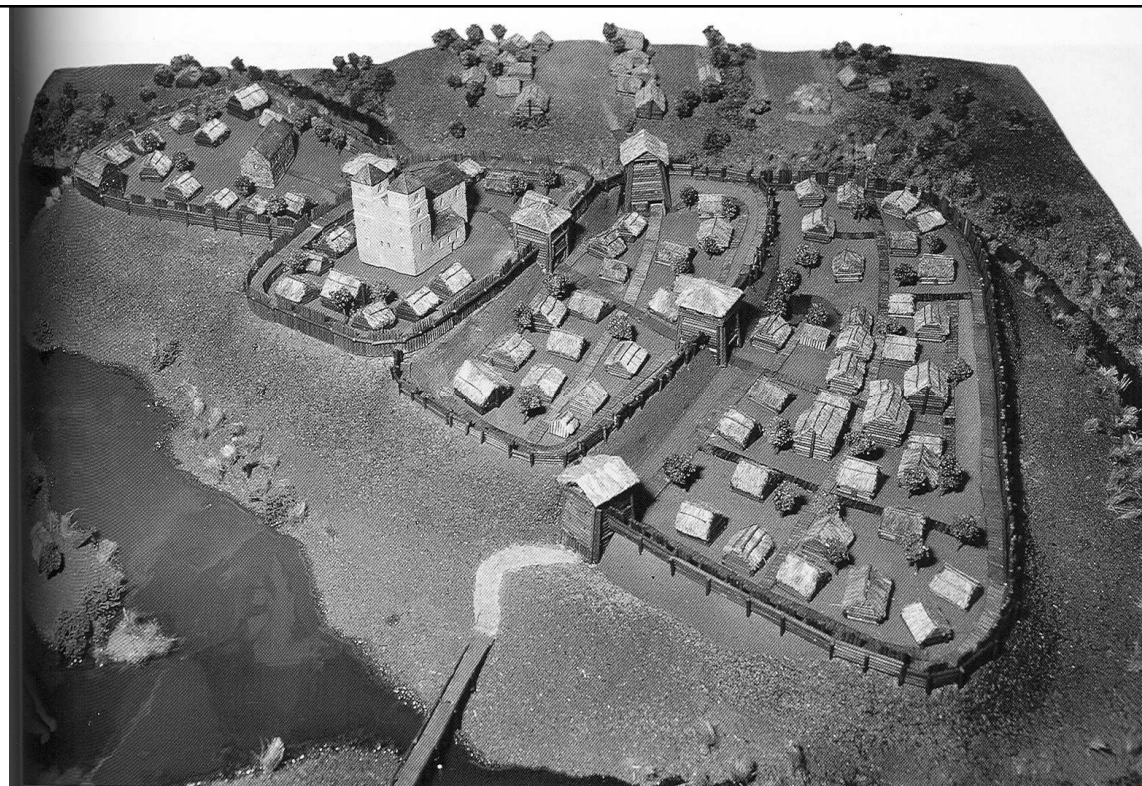

**Hnězdno.** Hradiště bylo založeno na nízkém pahorku zvaném Lechova hora obklopeném mokřinatým terénem mezi dvěma jezery.

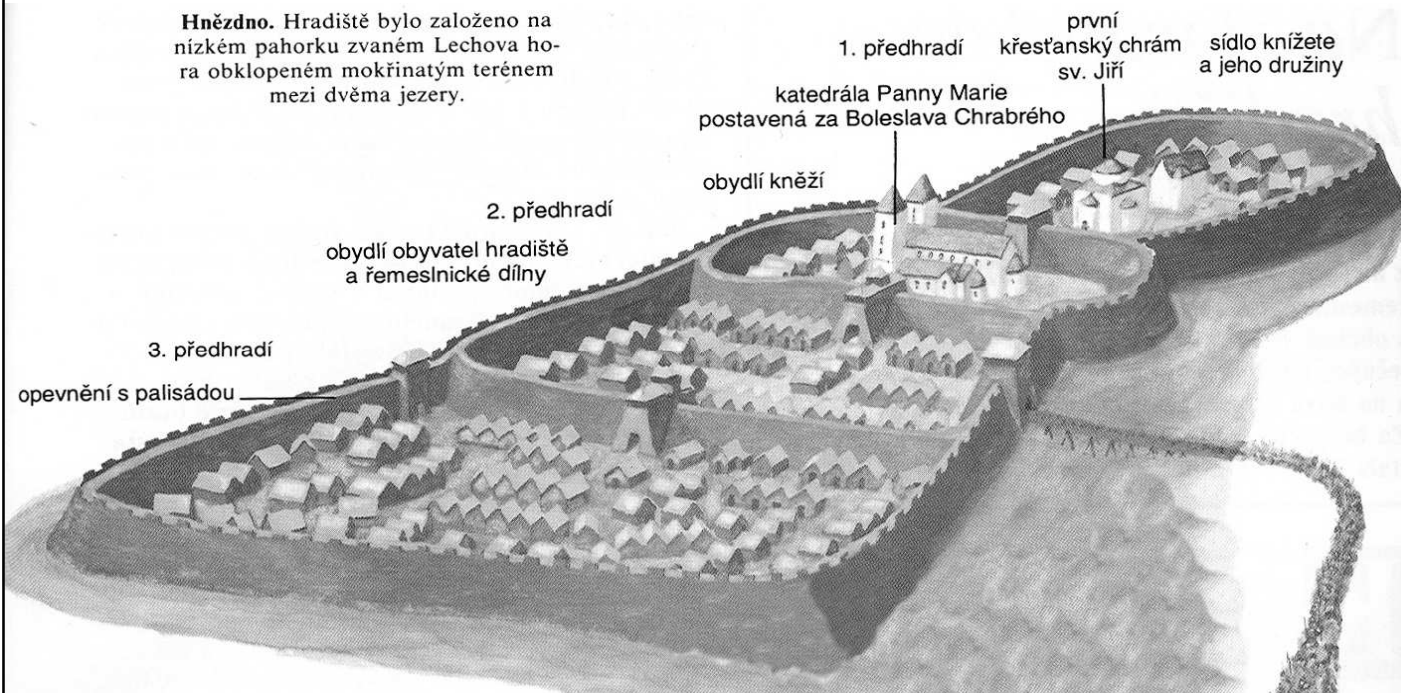

# palácové stavby

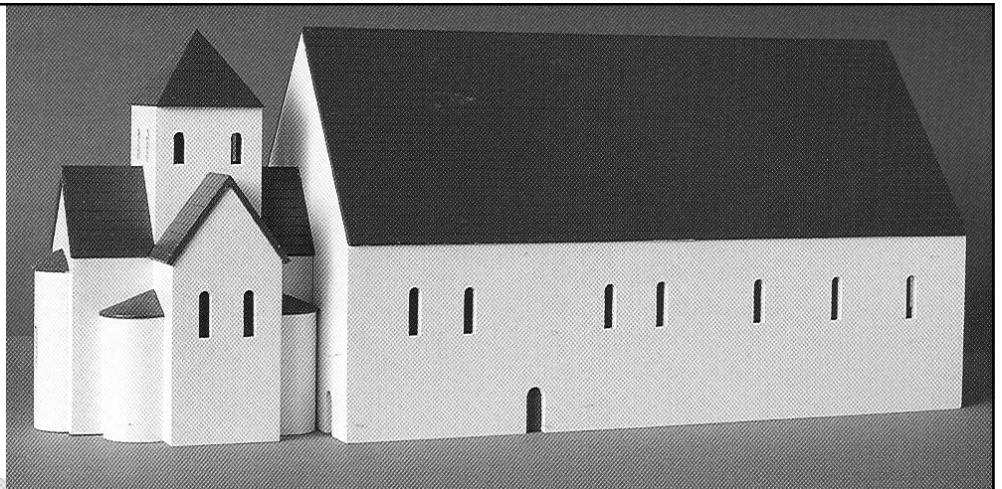

# Krakov





hrady  
přechodného typu

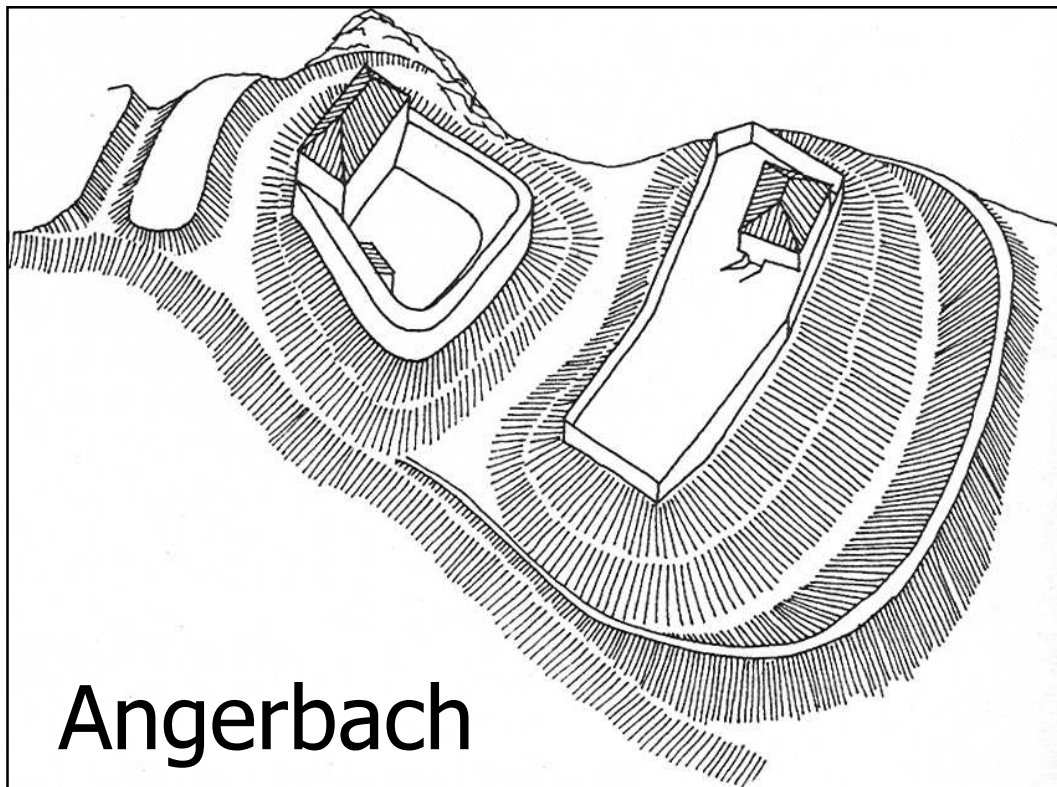

Angerbach

Týnec  
nad Sázavou

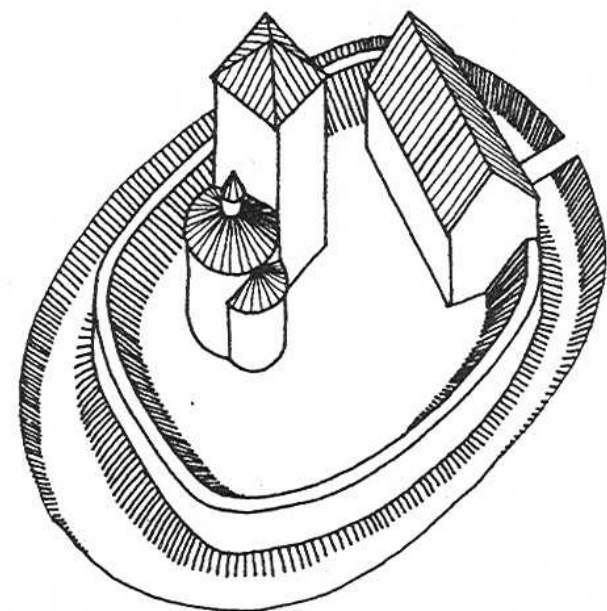
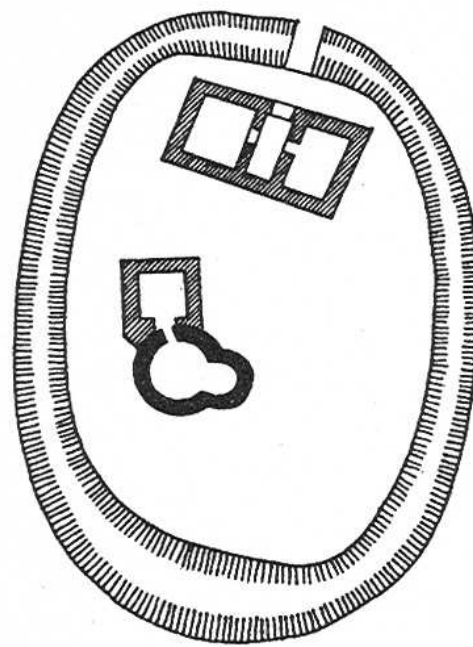

Křivoklát

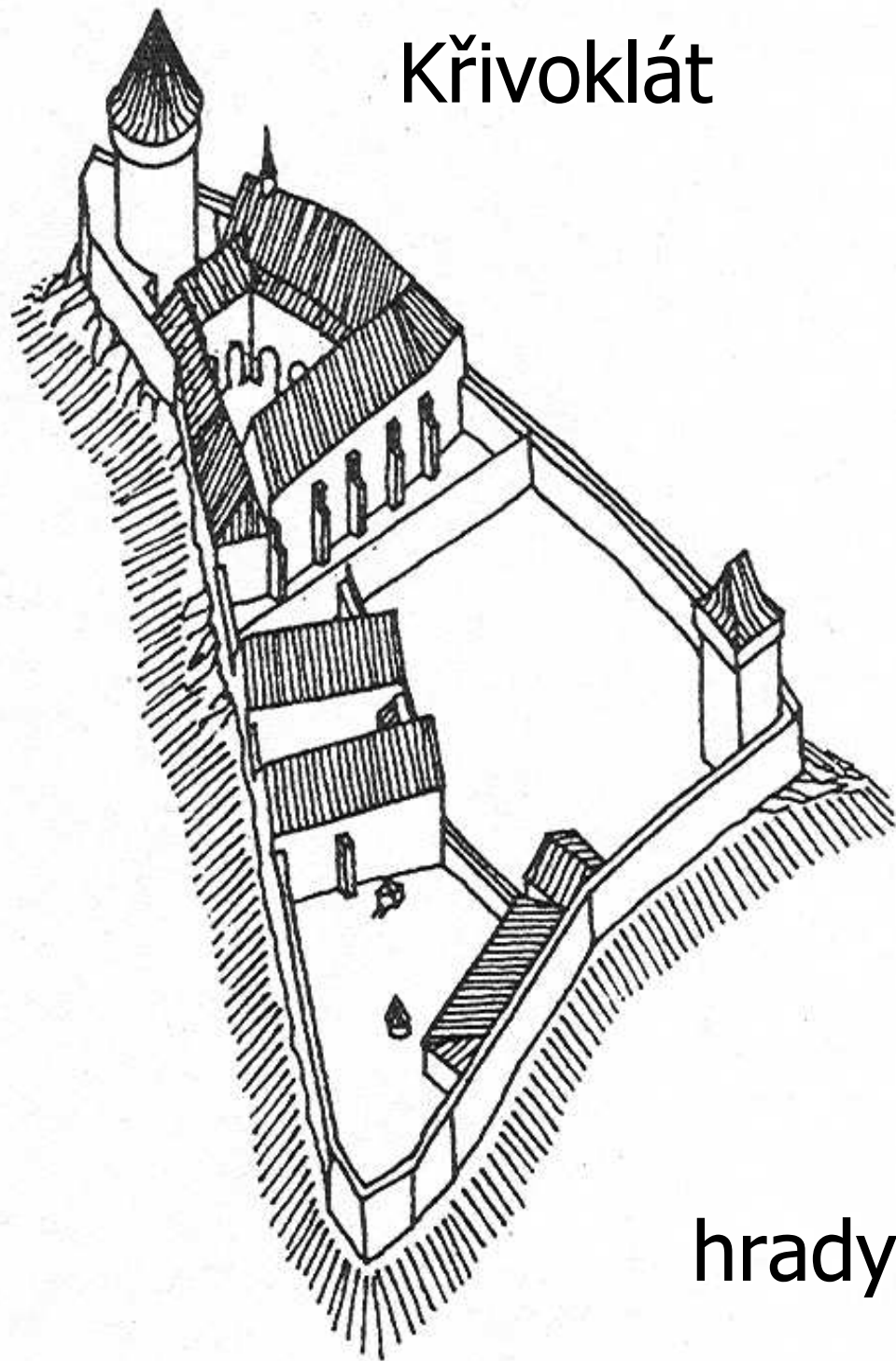

Jivno

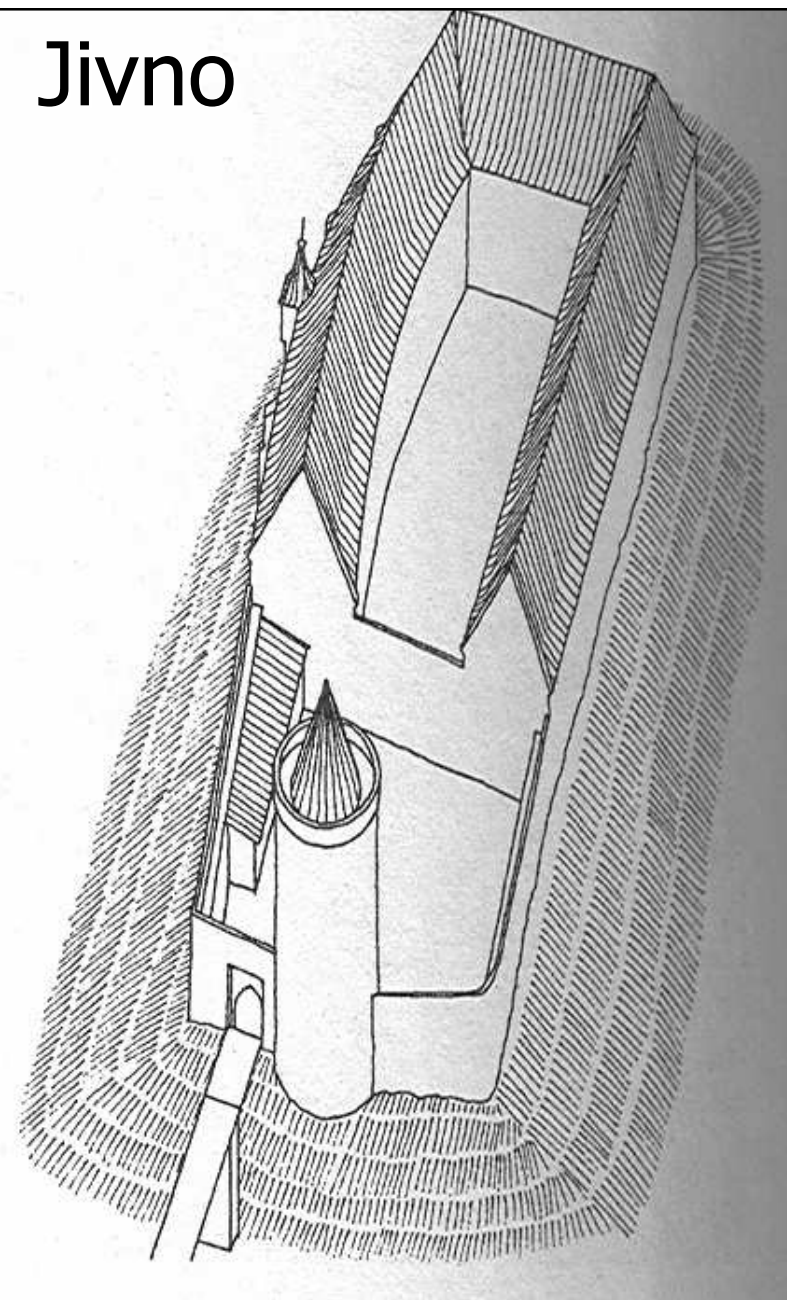

hrady s obvodovou zástavbou

# Špilberk

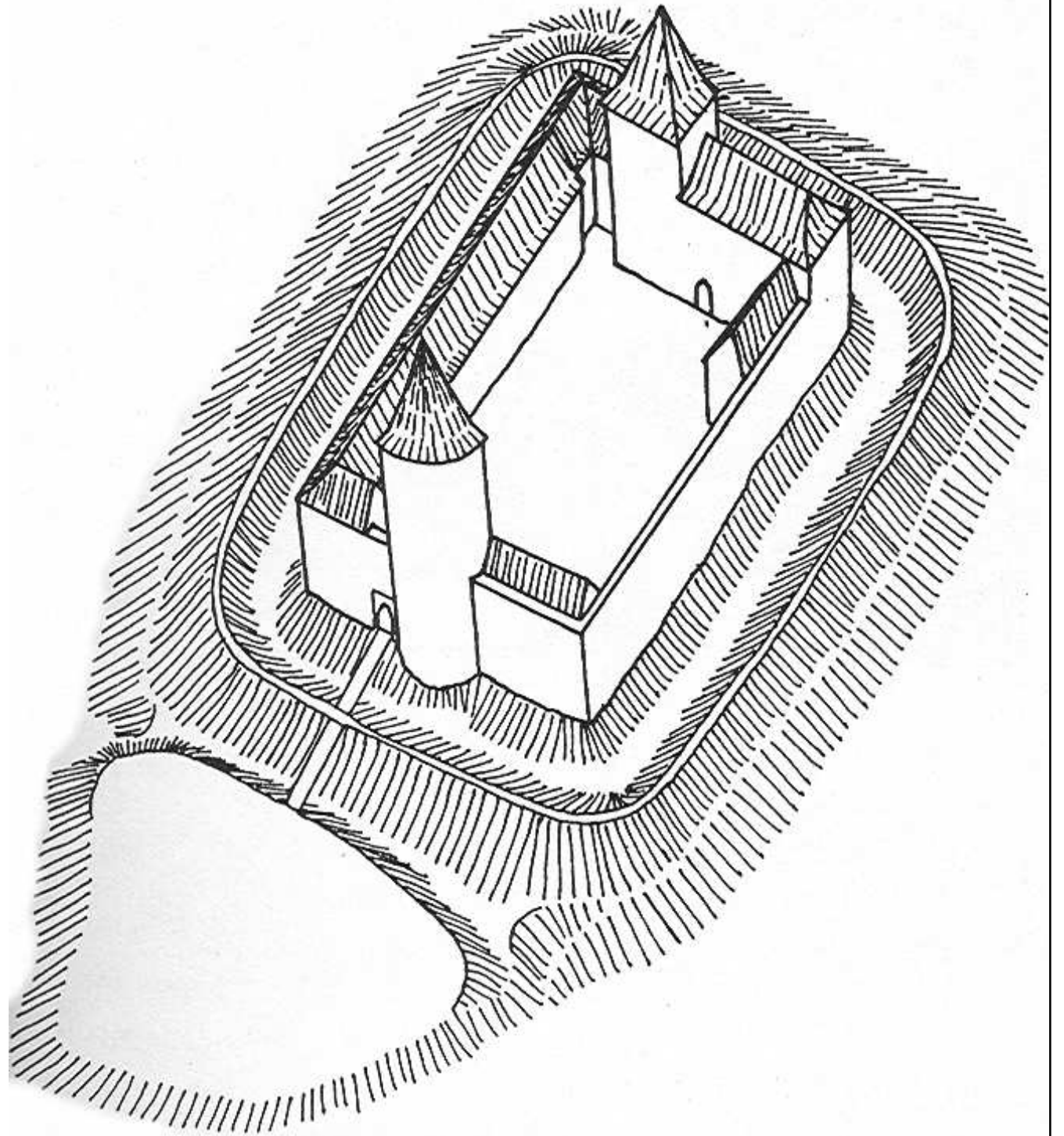

# pasivní a aktivní obrana

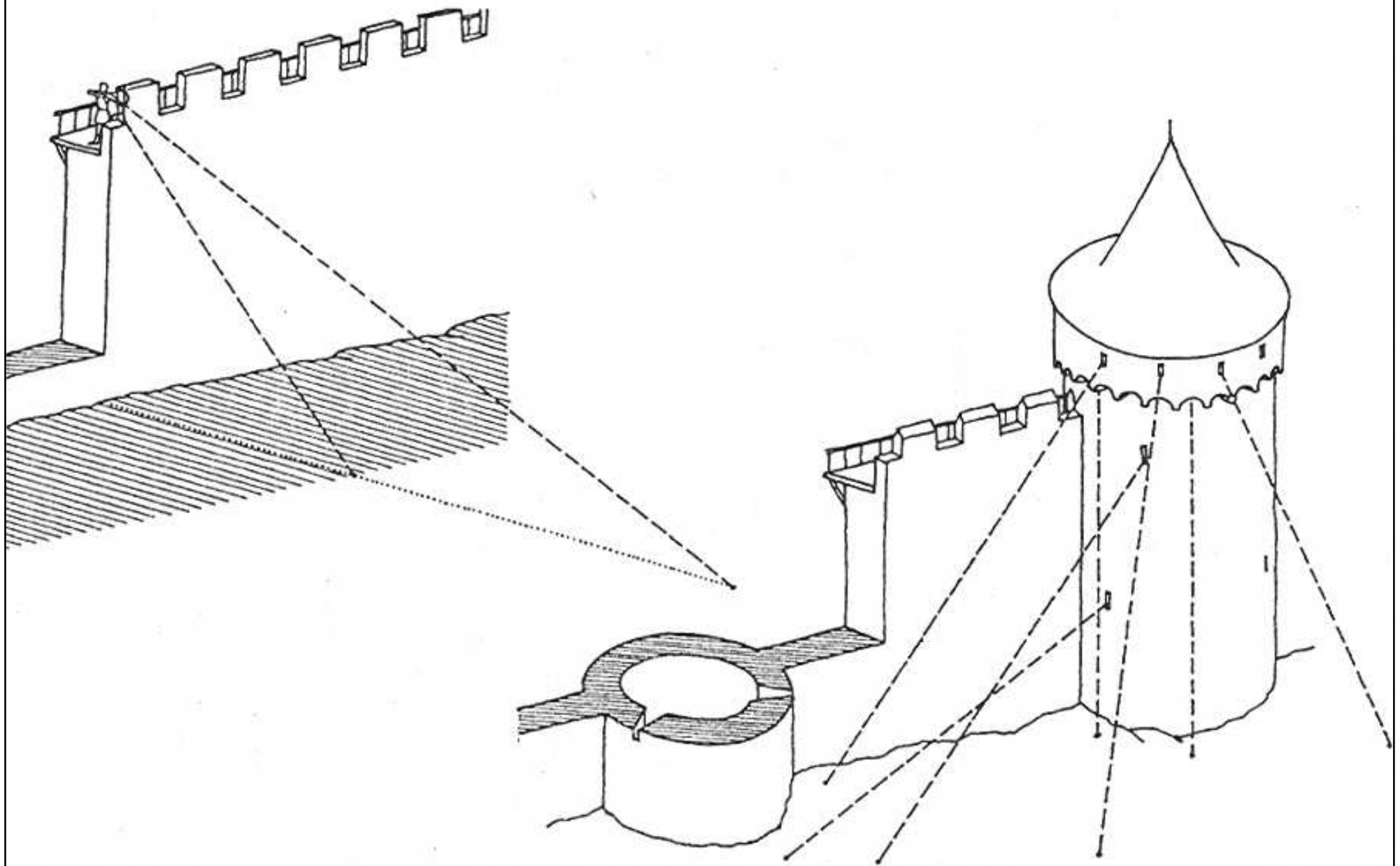

francouzský kastel

Týřov

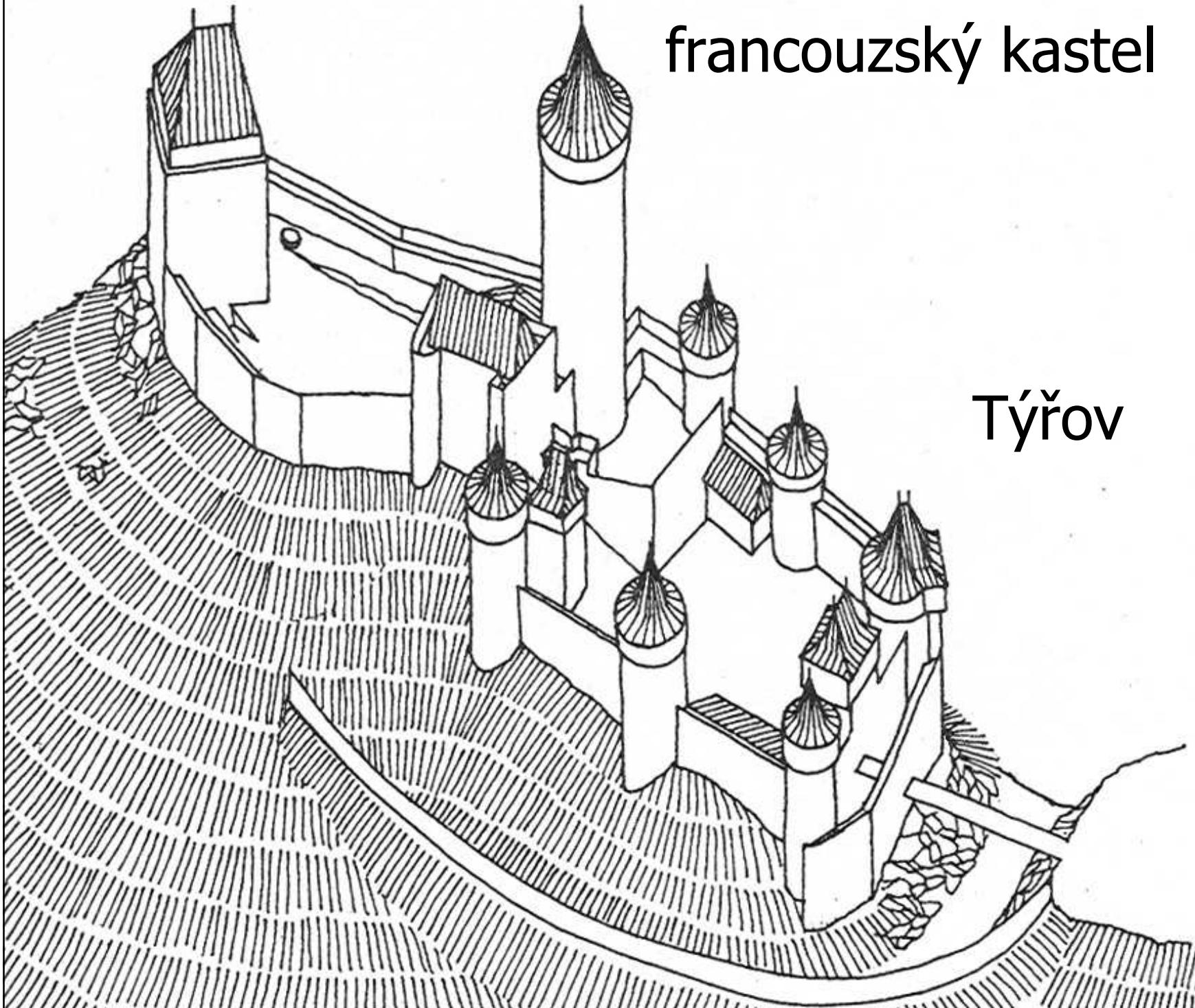

# bergfritová dispozice

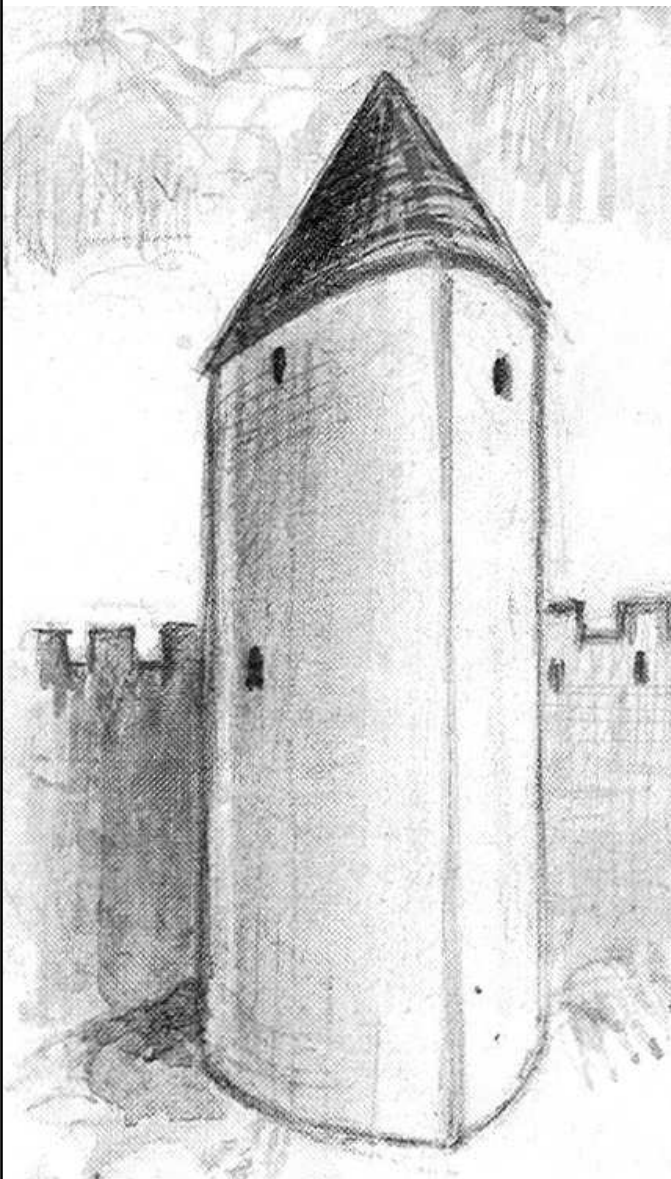

věž s břitem

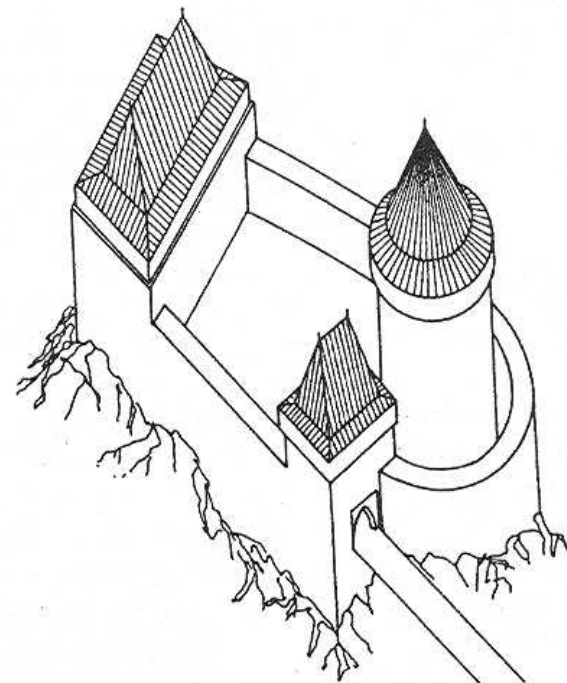
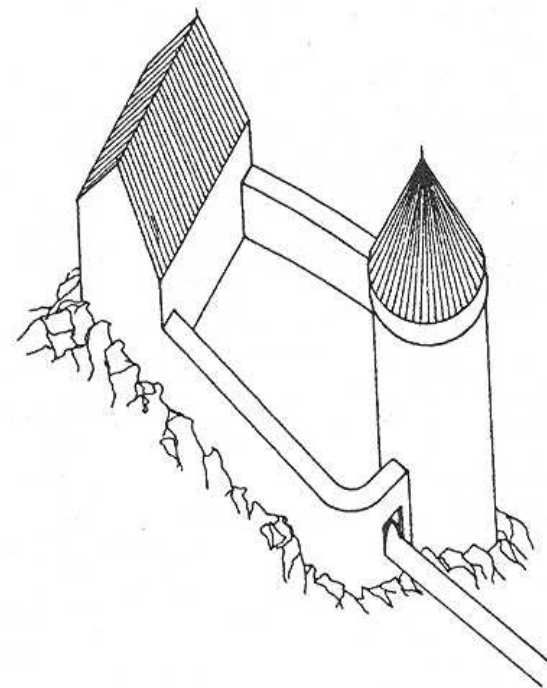

tvrz

Martinice

