

# Dějiny civilizace 10. – 13. století

vesnice

## literatura

- Le Goff, Jacques, 1999: Středověký člověk a jeho svět. Praha.
- Nový, Luboš a autorský kolektiv, 1974: Dějiny techniky v Československu do konce 18. st. Praha, 63 – 146.
- Seibt, Ferdinand, 2000: Lesk a bída středověku. Praha.
- Vařeka, Michal, 2000: Archeologie středověkého domu I. Praha.

Mstěnice

2. polovina 11. – 1. polovina 12. století

vesnice

- rychta
- farní kostel
- fara
- hřbitov
- krčma
- kovárna
- mlýn
- trvz

Mstěnice

10. – 1. polovina 11. století



# kovárna

- kovadlina
- výheň
- měch
- kladivo
- kleště

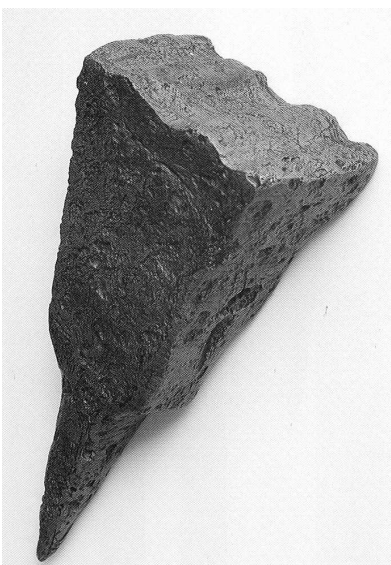



# mlýn

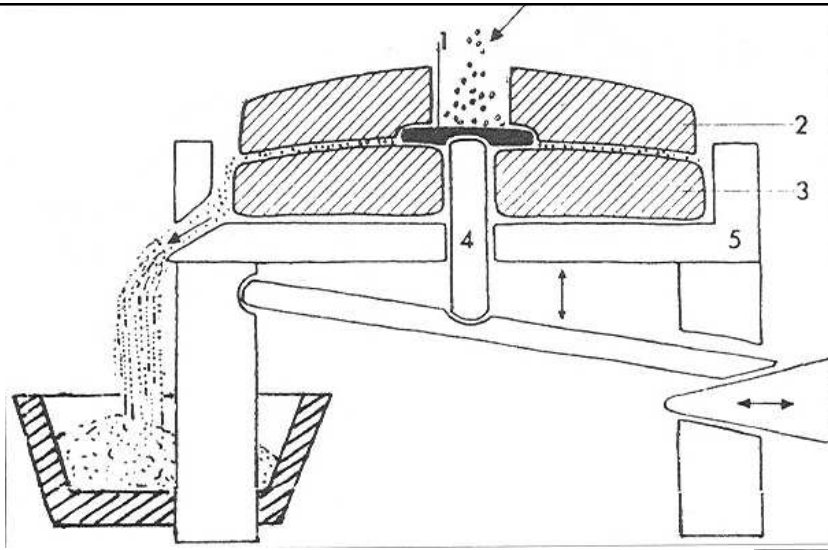

## ■ ruční

– rotační mlýnek (žernov)

– stoupa

## ■ vodní

## ■ větrný

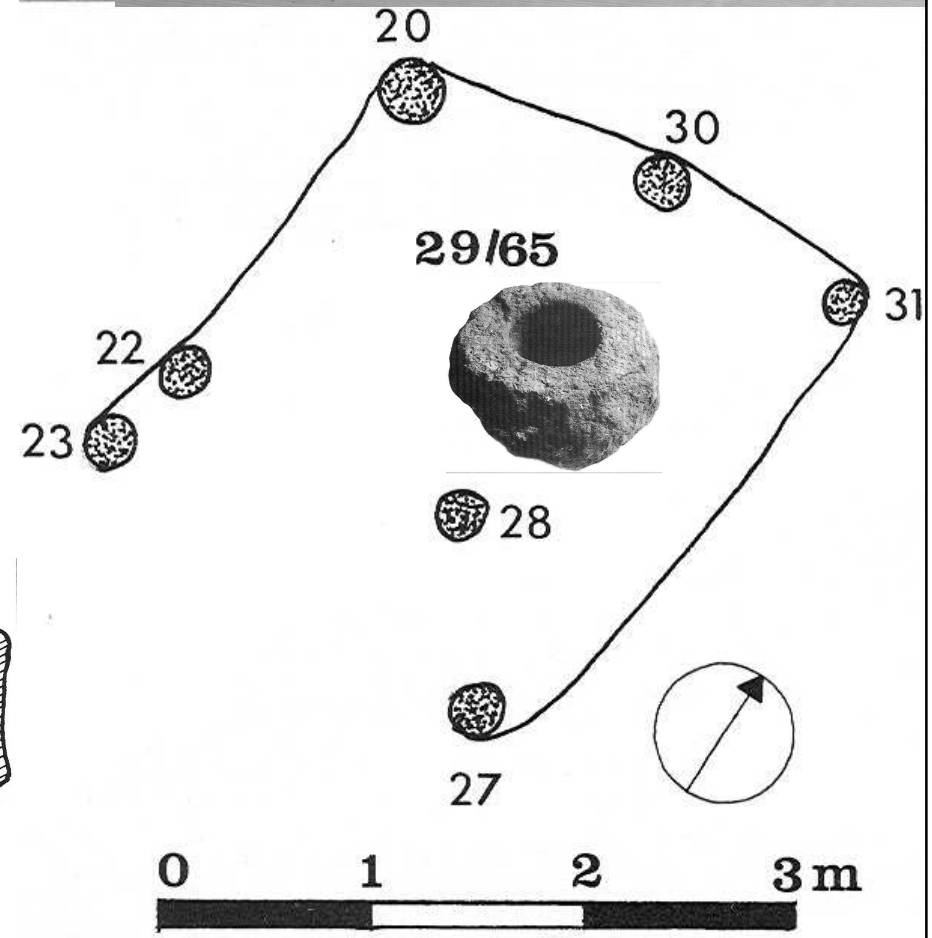
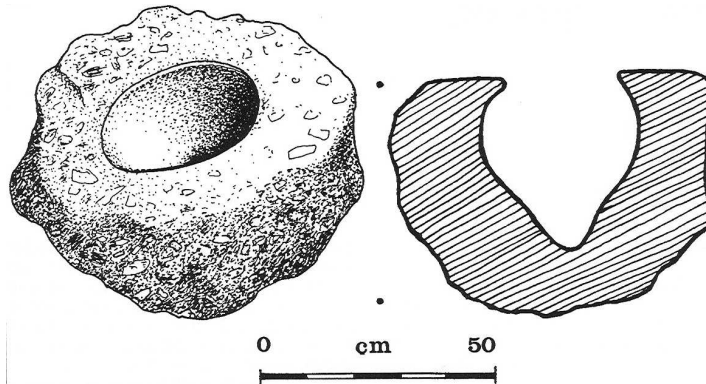

# vodní mlýn



mlýnská stolice

nasýpací koš

běhoun

spodní kámen

paleční převod

paleční kolo

vodní kolo

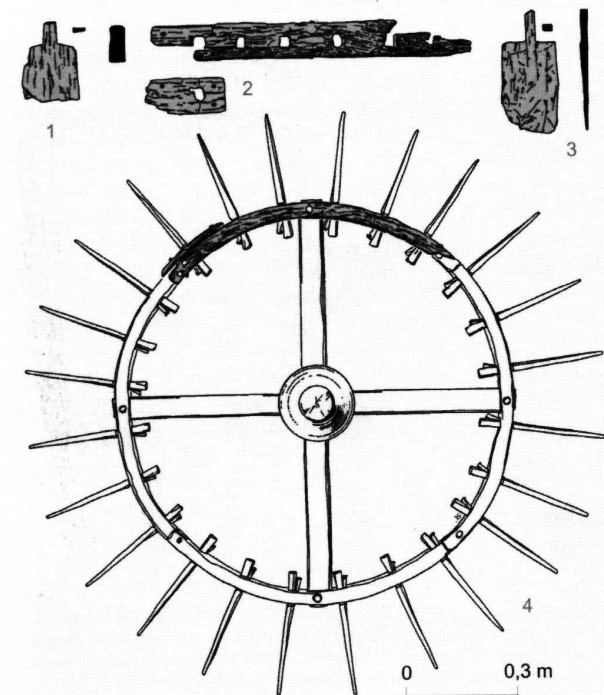

# větrný mlýn

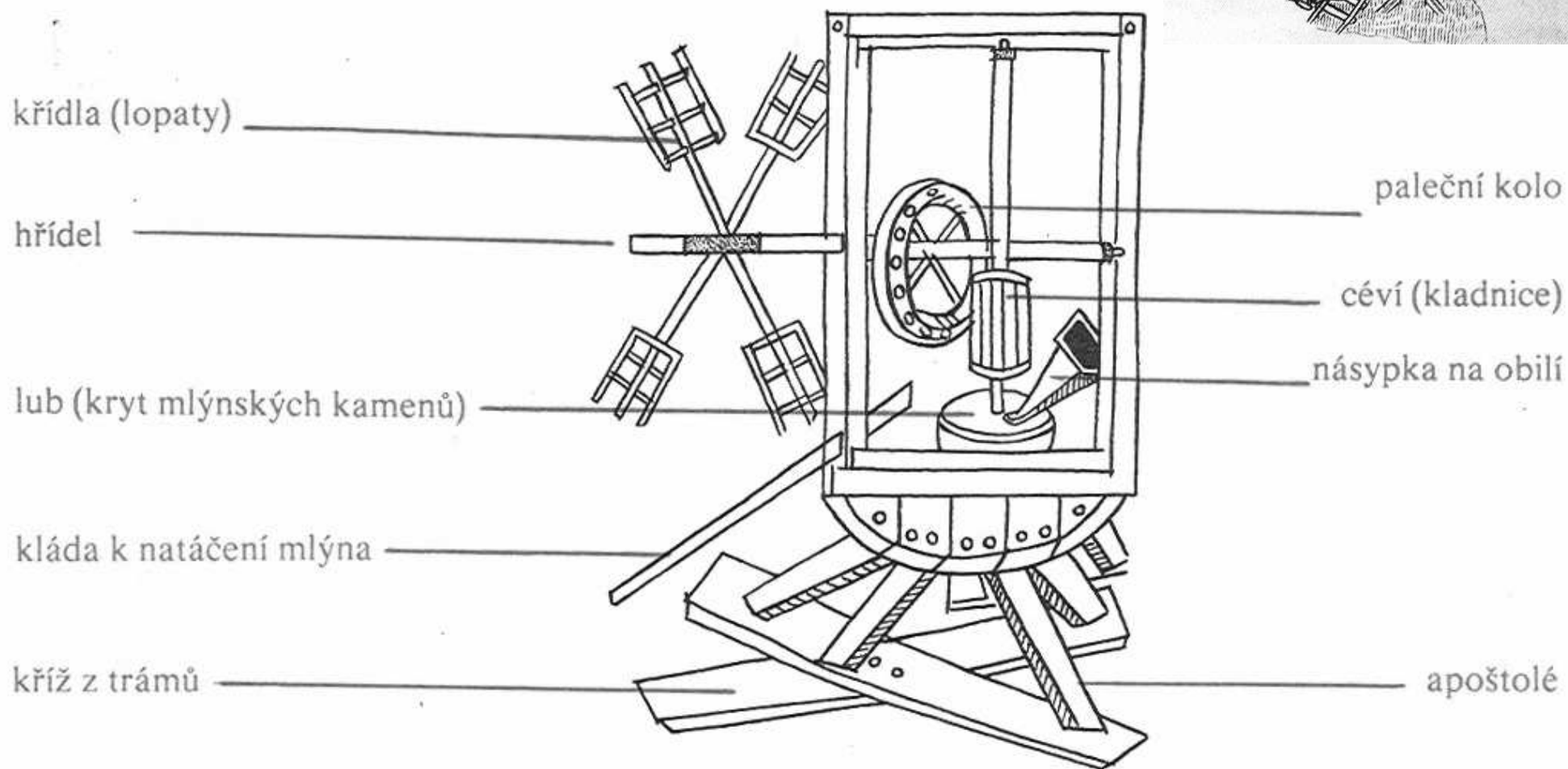

# sociální struktura

- pán
- svobodník
- poddaný
- nápravník
- farář

# půda

- v přímém užívání pána
- v pronájmu rolníků
- ve společném užívání
- lesy
- vodní toky

# výměra

- lán
- strych, korec
  - násevek
- jitro
  - záhon
  - brázda

# vesnický dům

## ■ zahloubený

- zemnice
- polozemnice

## ■ nadzemní

- roubený
- kůlový

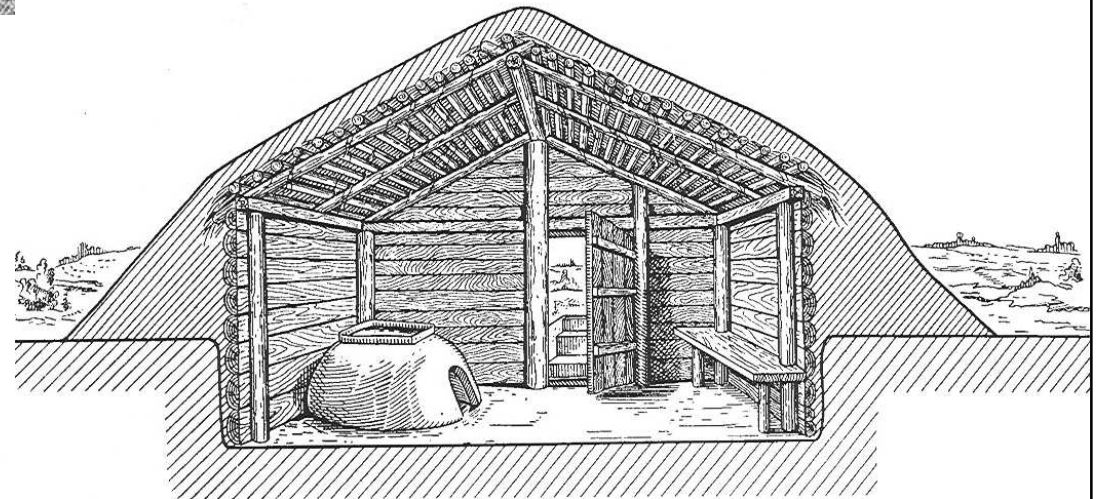
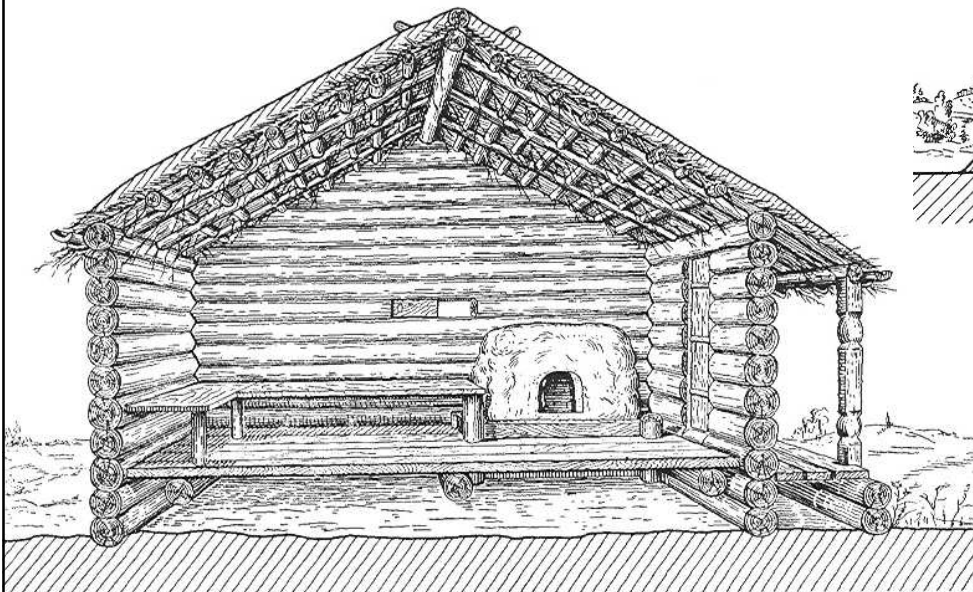
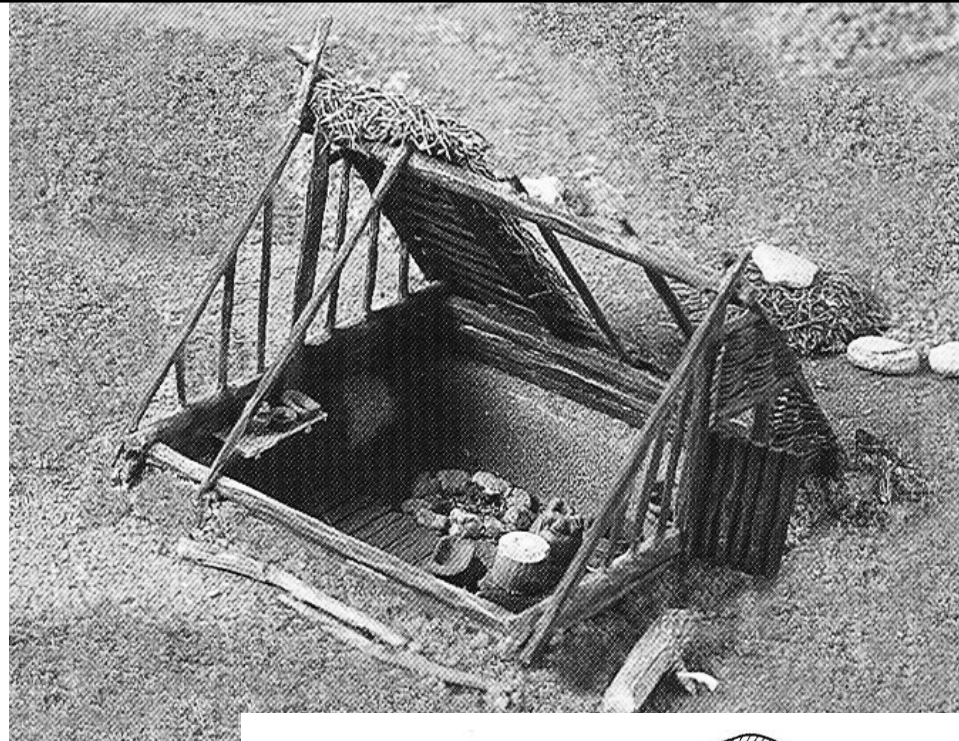



# trojdílný dům

- světnice
  - síň
  - komora nebo chlív
- 
- vstup ve štítové stěně světnice (A)
  - vstup v okapové stěně světnice (B)

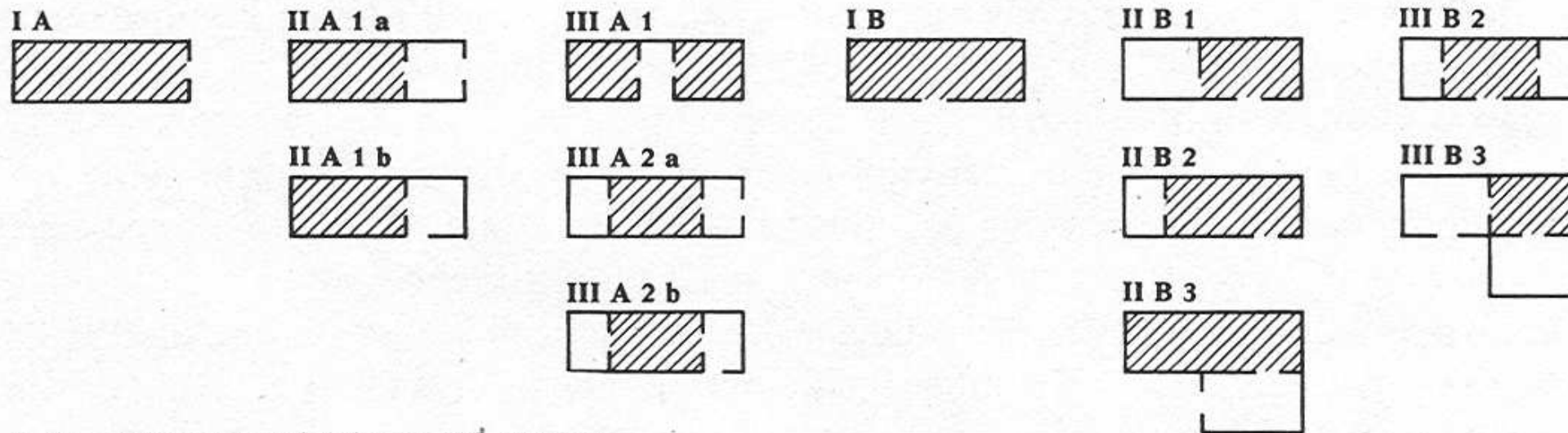

I–III JEDNOTLIVÁ VÝVOJOVÁ STADIA

■ VYTÁPĚNÁ MÍSTNOST

usedlost



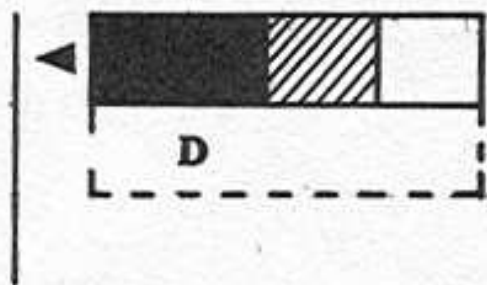

USEDLOST  
JEDNOTRAKTOVÁ -  
ŘADOVÁ

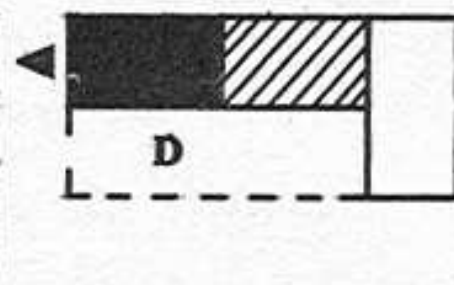

USEDLOST  
DVOUSTRANNÁ  
(HÁKOVÁ)

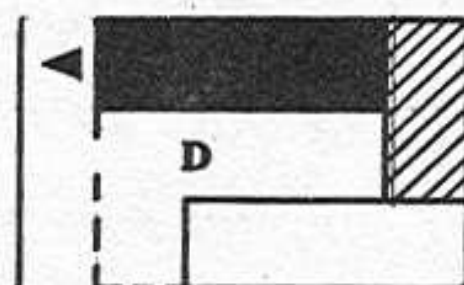

USEDLOST  
TROJSTRANNÁ  
(PODKOVOVITÁ)

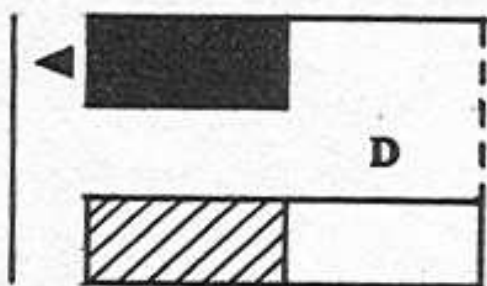

USEDLOST  
PÁROVÁ

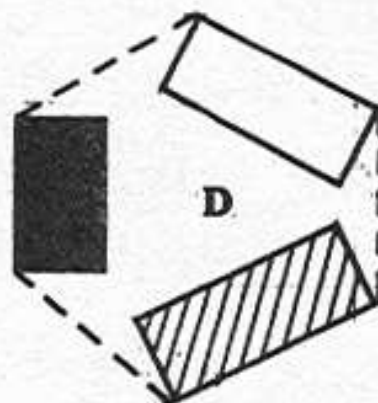

USEDLOST  
ROZPTÝLENÁ  
(HROMADNÁ)

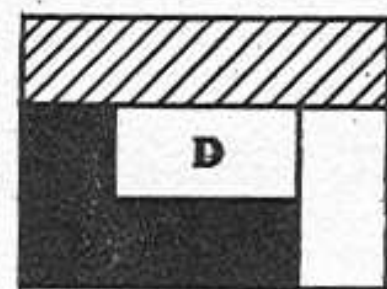

USEDLOST  
ČTYŘSTRANNÁ

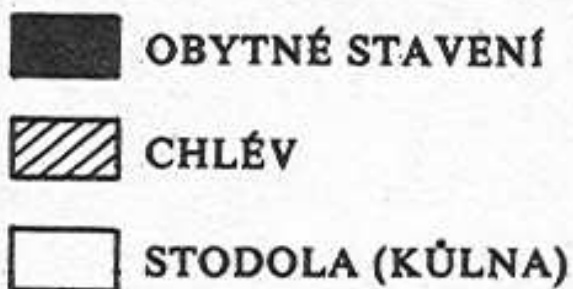

D  
DVŮR

ŠIPKOU VYZNAČENA ORIENTACE  
(KE KOMUNIKACI NEBO K NÁVSI)



# hospodářské stavby

- obilní jámy (zásobnice)
- sýpky
- stodoly
- kůlny
- chlévy
- sklepy
- pece

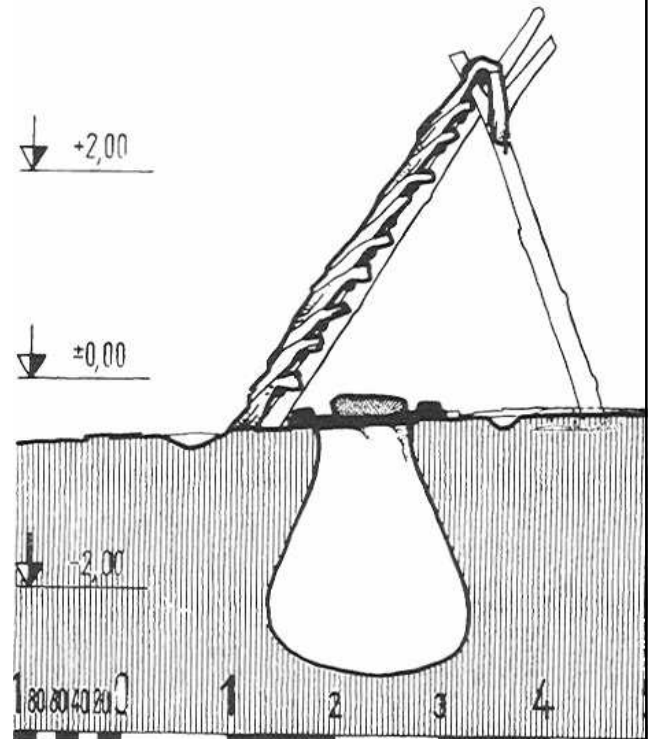
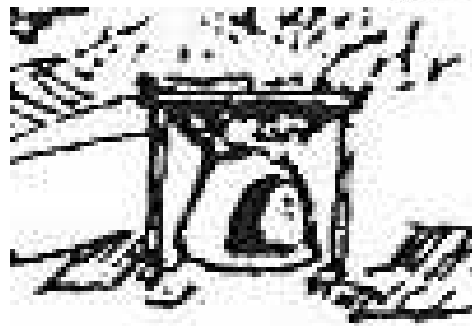
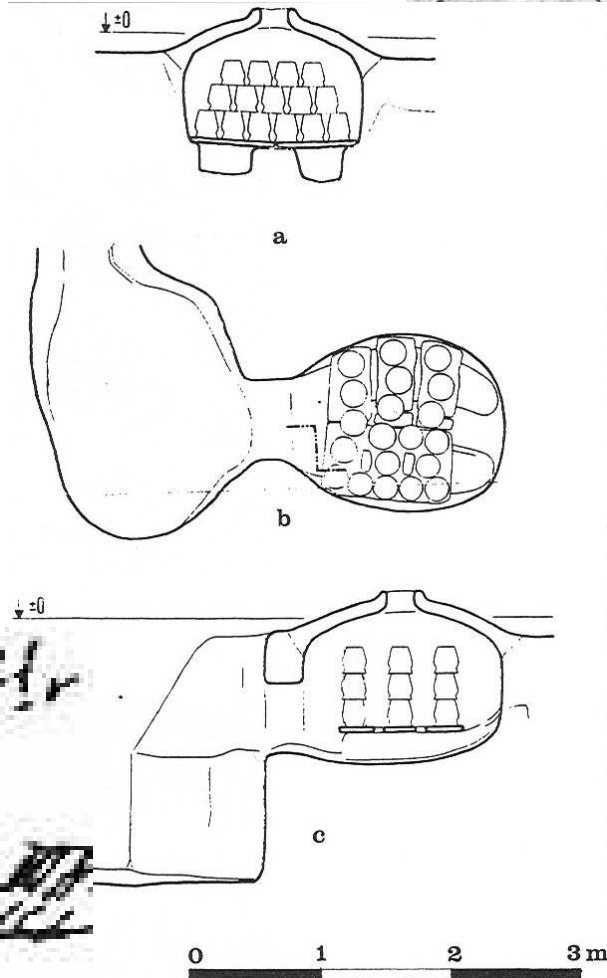
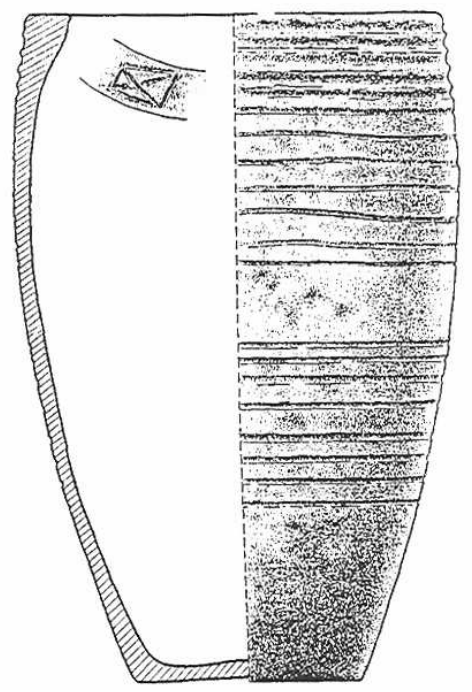

# zemědělská půda

- klučení
- trojpolní hospodaření
  - ozim
  - jař
  - úhor

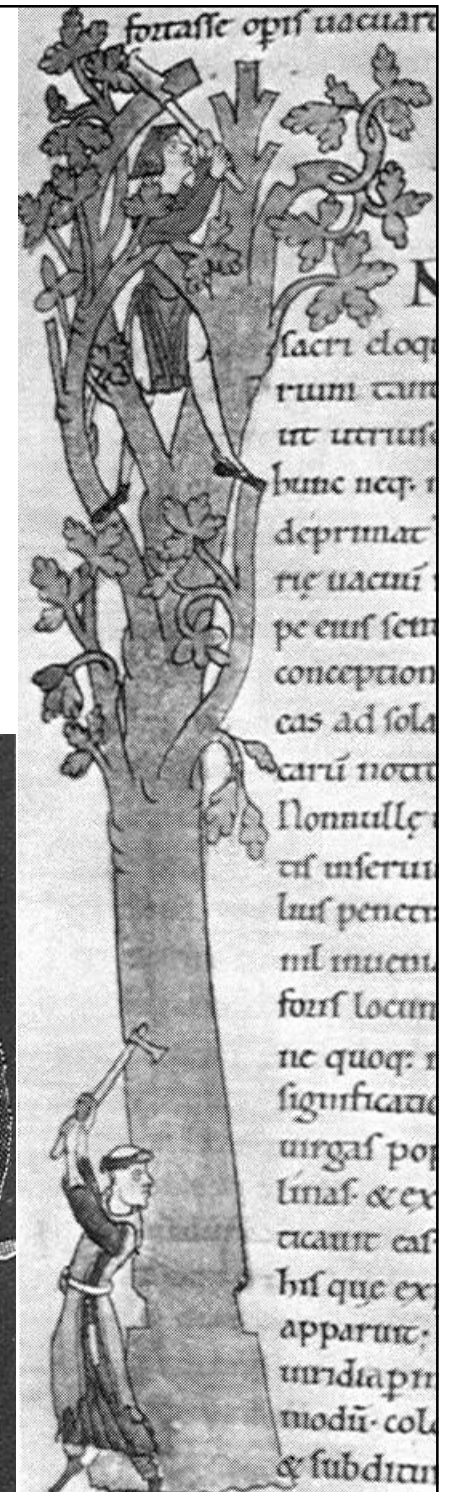
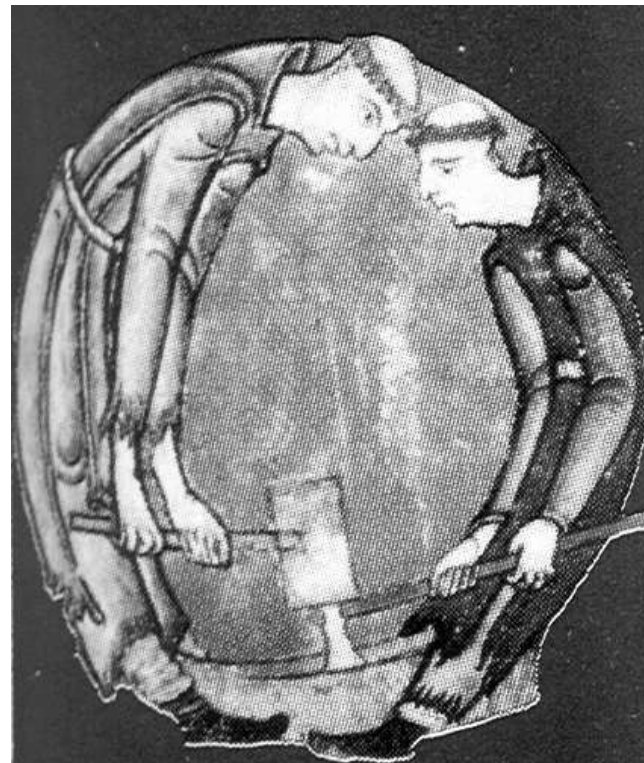
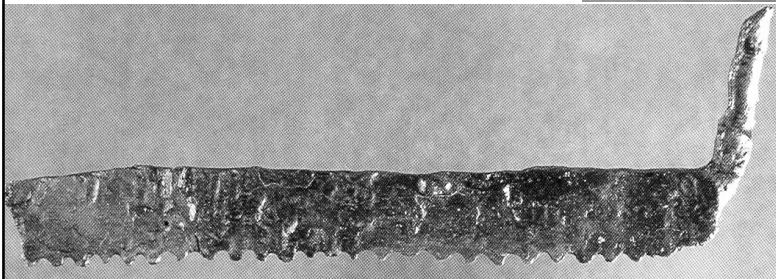

# polní práce

- orba
- vláčení
- setí
- sklizeň

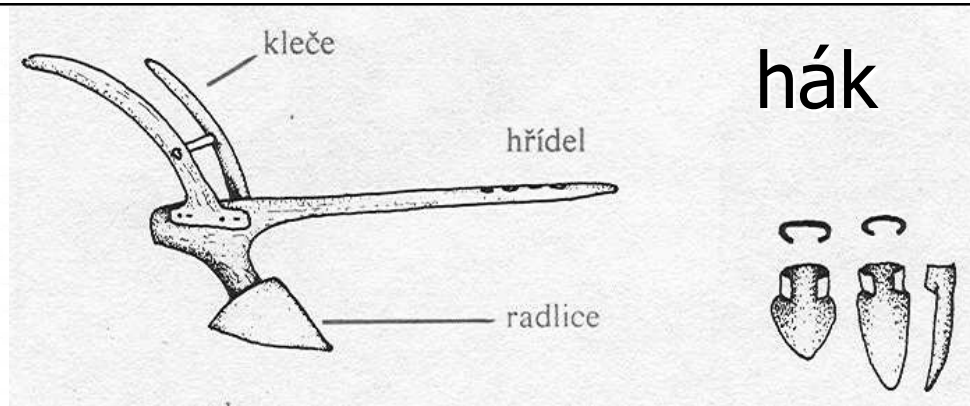

radlice

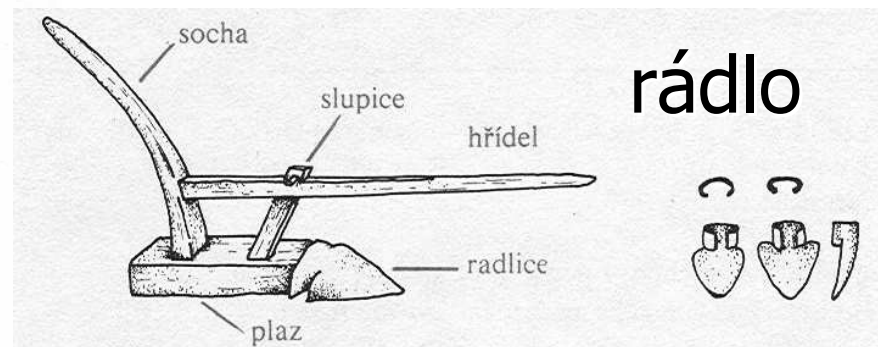
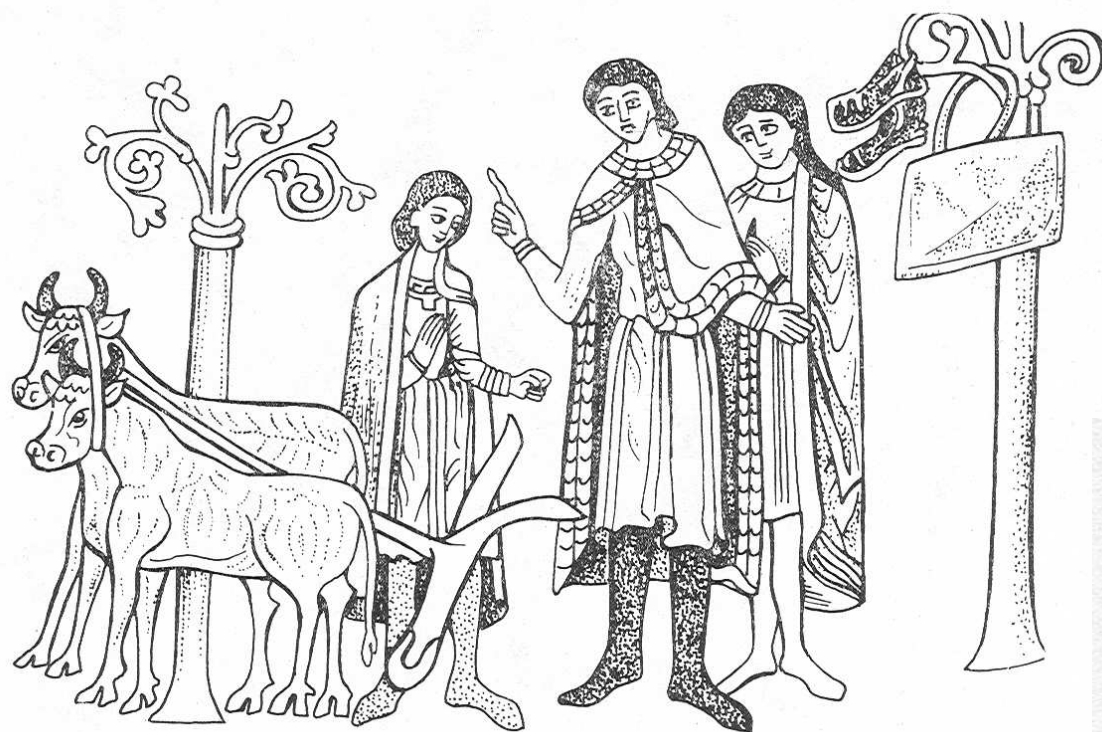
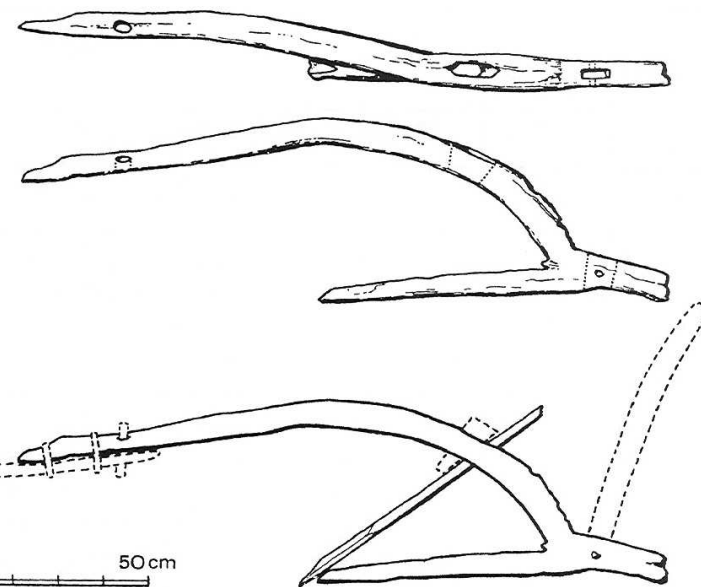



# nákolesník

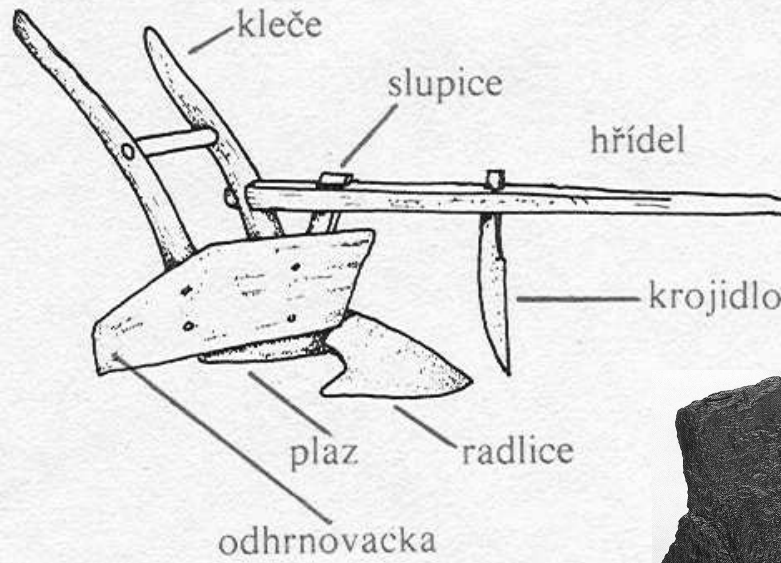
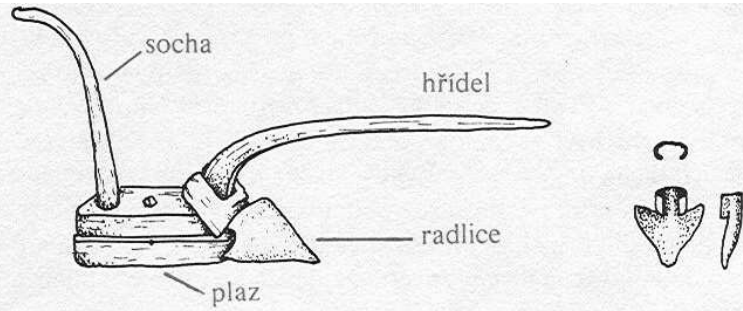

# pluh

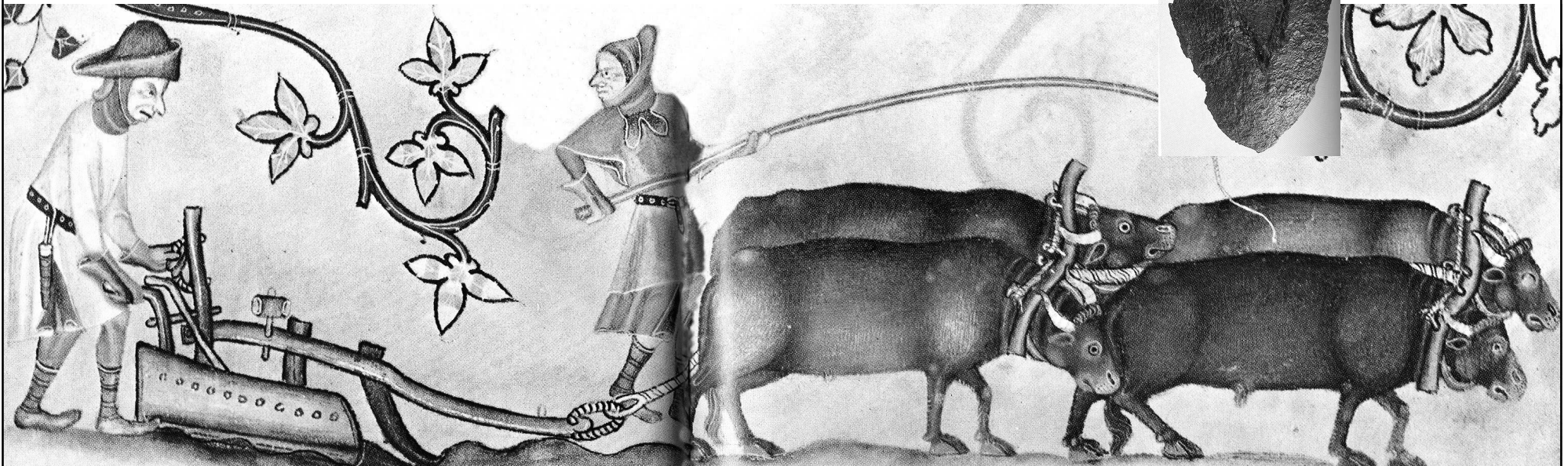
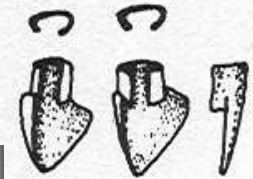

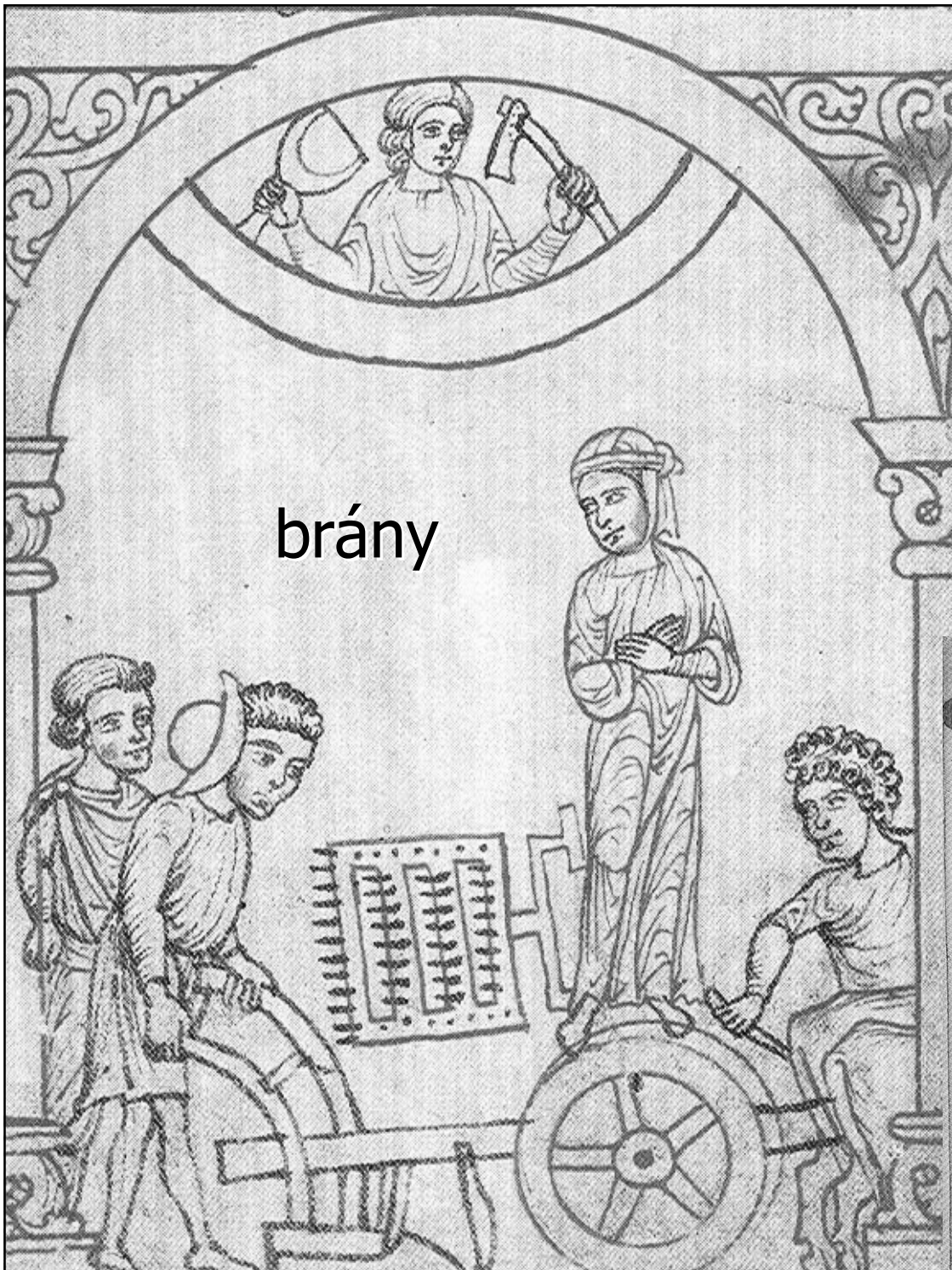

setí







srpy

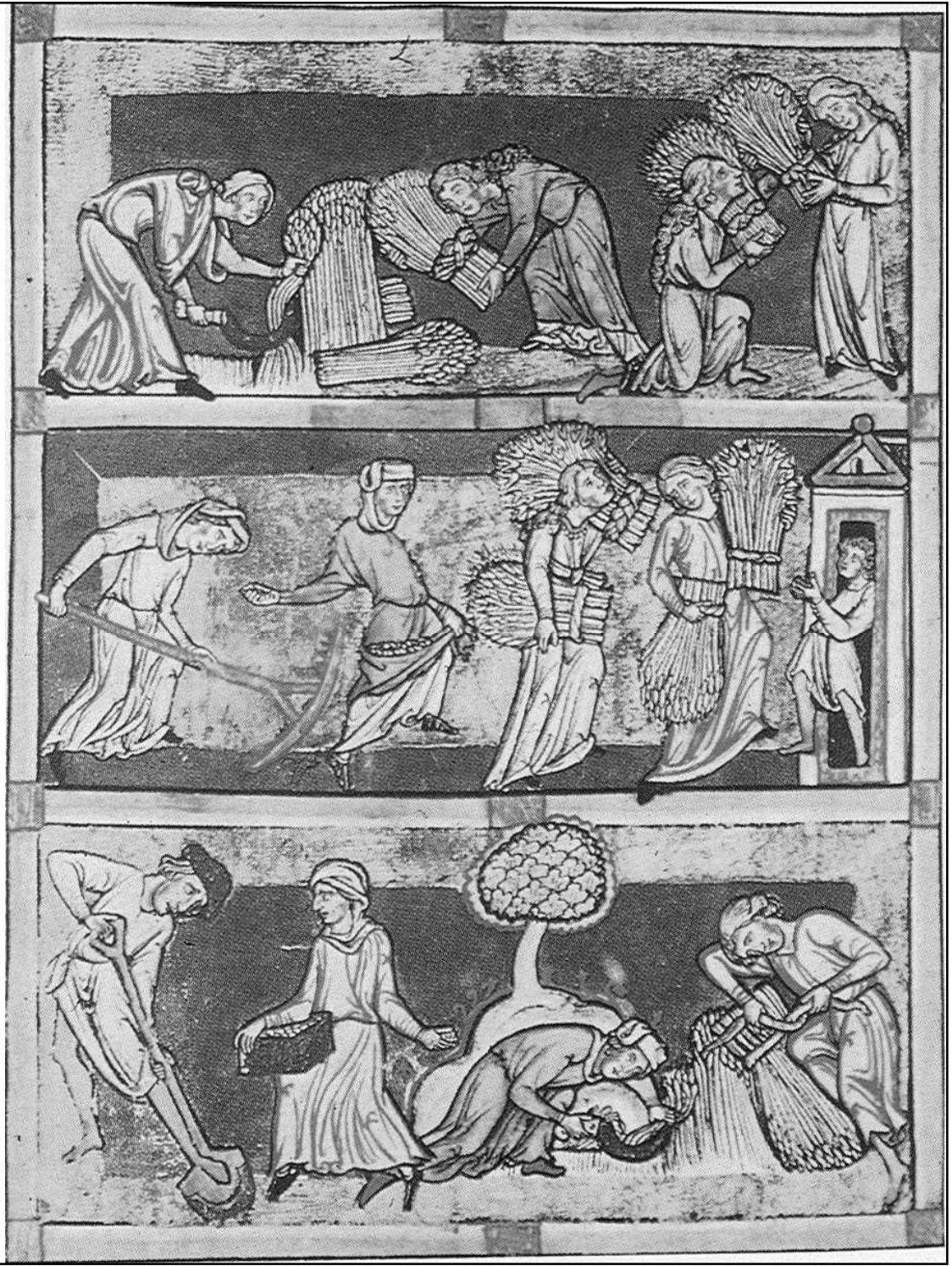

žně

potah

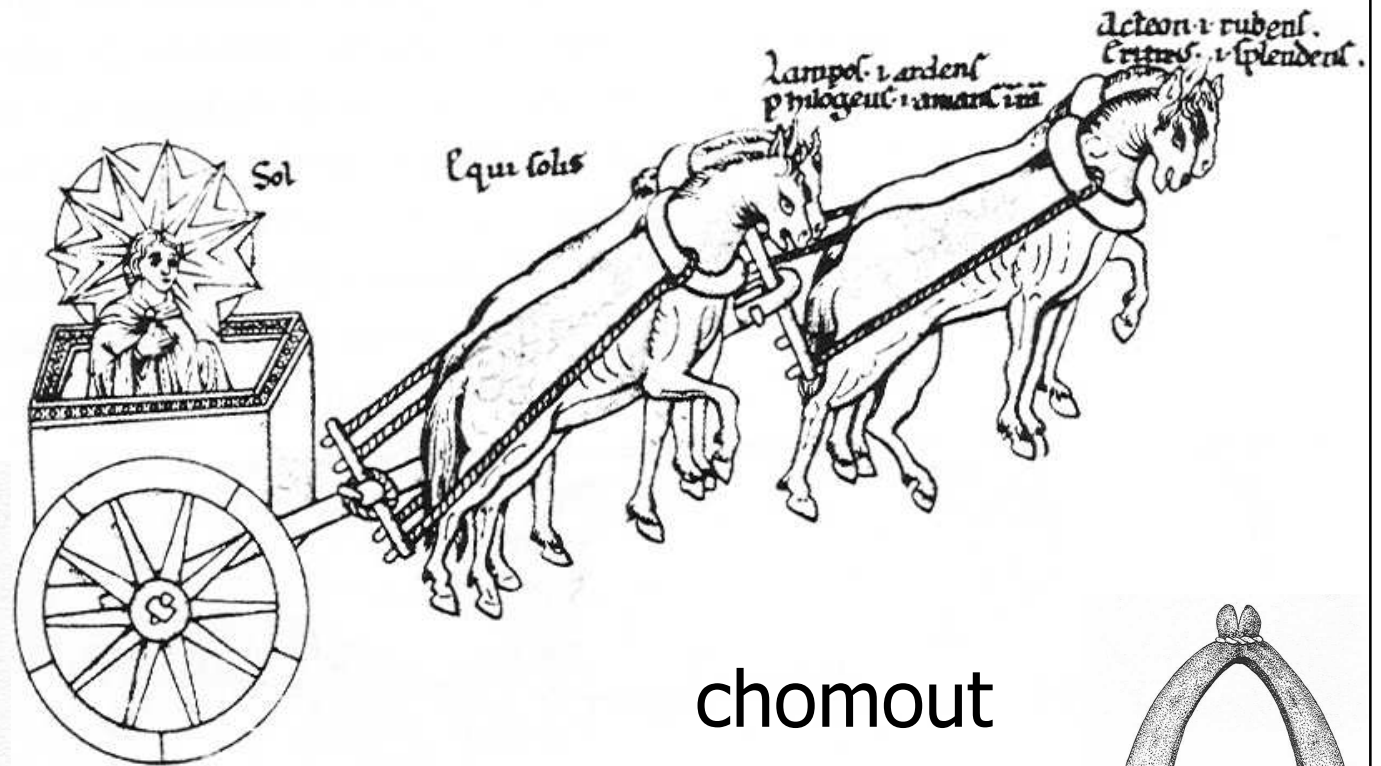
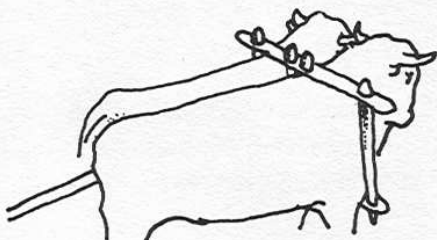
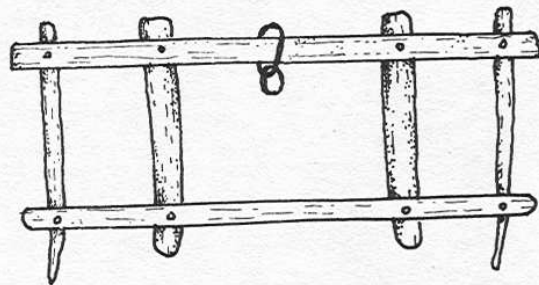
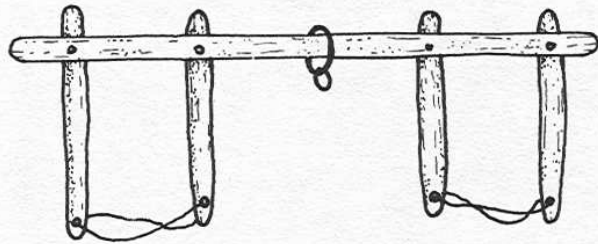

jho



chomout

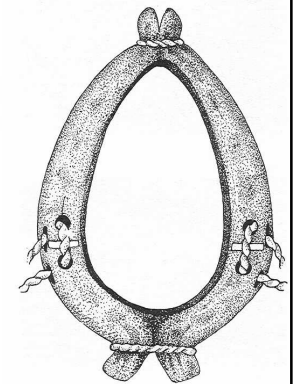

# nářadí

- kosa
- hrábě
- rýč
- lopata
- vidle
- cep
- motyka

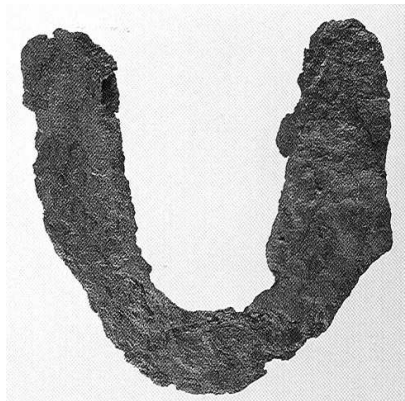
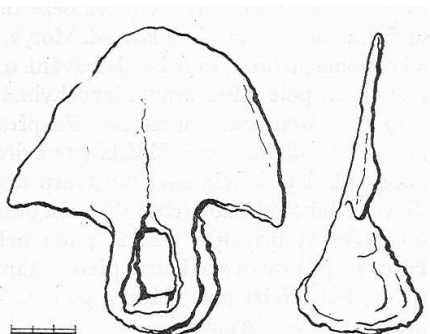
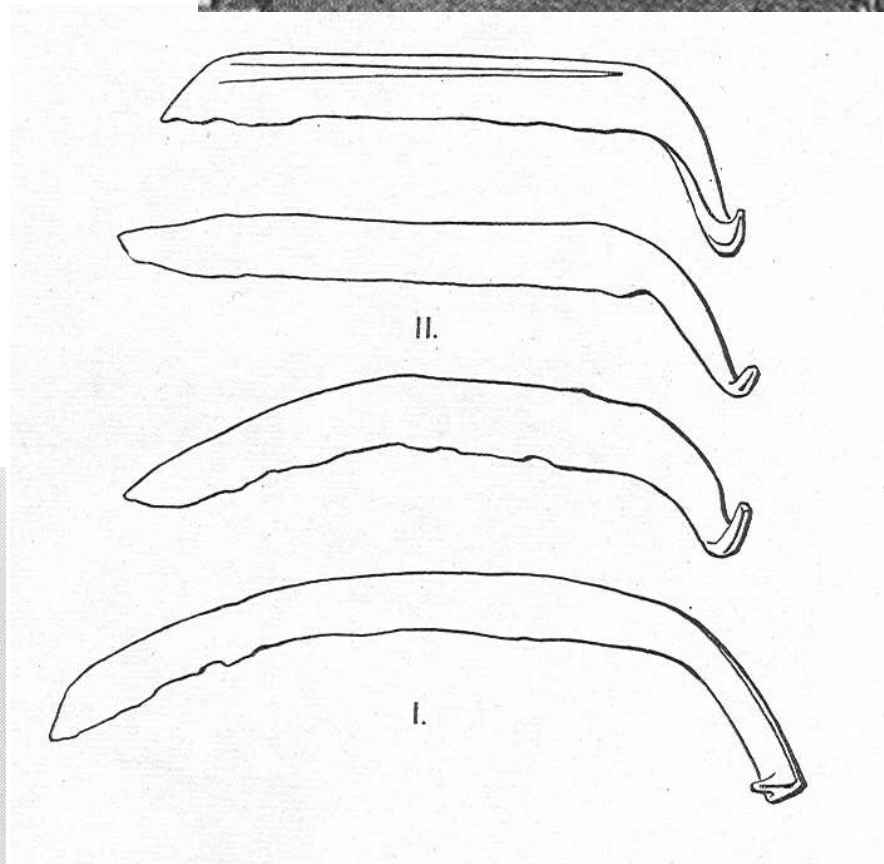



# vinařství

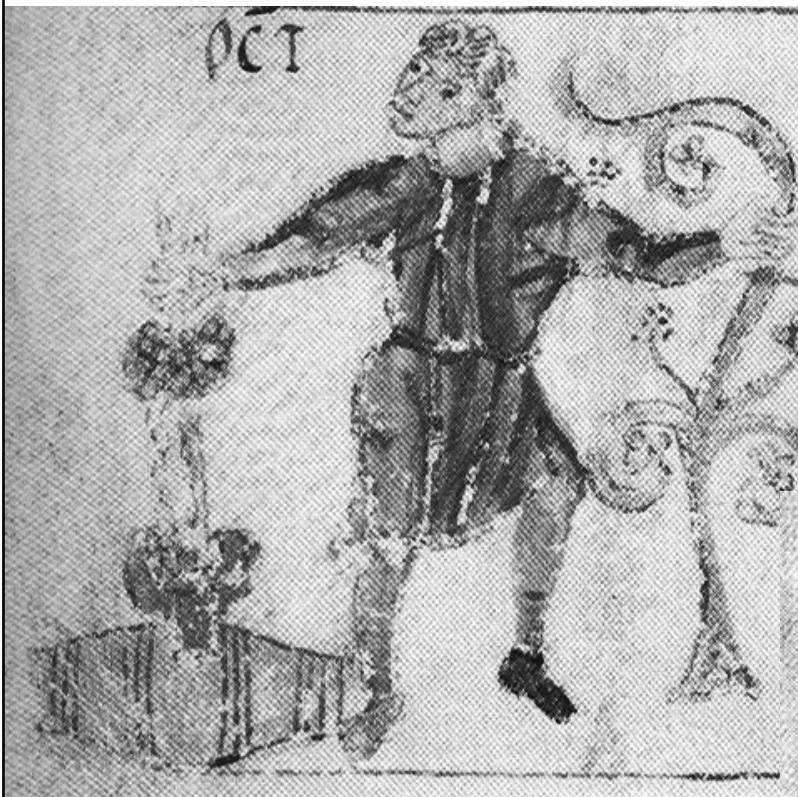

■ vinařský nůž

■ lis

