

Doba římská a stěhování národů



Periodizace DŘ

- **starší DŘ**

- **0-180 n.l.**

horizont plaňanských pohárů **35 -10 př.n.l.**

horizont Marobudovy říše, spony s očky

10 př.n.l. – 50 n.l. – hl. Čechy

– horizont markomanských válek **150 – 180 n.l. – hl.**

Morava

- **mladší DŘ**

– **180 – 300 n.l.**

- **pozdní DŘ**

– **300 – 375 n.l.**

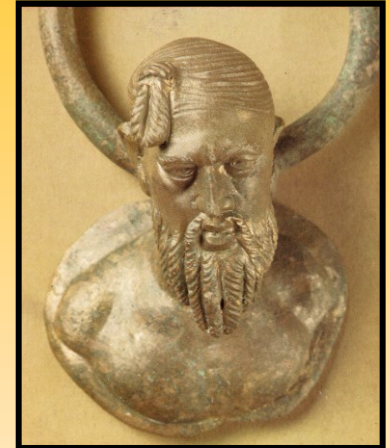

Periodizace DSN

- **časná DSN**

- přechodný stupeň **375 – 410**
- starší stupeň vinařické skupiny – Čechy; horizont Smolín **410 – 440 – horizont Hunské říše**
- přechodný stupeň 430 – 470
- mladší stupeň vinařické skupiny – Čechy; **440 - 480 – posthunský horizont (Ostrogóti, Herulové)**



- **pozdní DSN**

- přechodný stupeň 470 – 500
- **480 – 568** čelákovická skupina, Langobardi



Hlavní rysy DR

- barbaricum versus římská říše (ŘŘ) a její provincie
- žárová pohřebiště (+ knížecí hroby – Mušov...)
- kontakty s ŘŘ (obchodní, vojenské...)
- stopy římského vojska
- antické písemné prameny
- jména kmenů a vládců
- první germánská říše (Marobud)

Hlavní rysy DSH

- Pohřebiště (žárová přechází do kostrových) + bohaté hroby (Smolín, Blučina, Žuráň)
- 3 oblasti vývoje na našem území
 - střední a SZ Čechy - Vinařická skupina
 - J a Z – Čechy – skupina Přešťovice – Friedenhain
 - Morava – působení hunského kmenového svazu
- přelom 5./6. století – příchod Langobardů

Doba římská



PR

- převaha kremace
- deformování předmětů ukládaných do hrobu
 - osobní šperk
 - výzbroj
 - toreutika
 - potraviny – zvířecí maso (prase, tele, kuře, aj.)

pohřebiště:

- žárová
 - popelnicové hroby
 - jámové hroby
 - Třebusice, Přešťovice, Dobřichov-Pičhora, Kostelec na Hané, Kostolná
- birituální
 - Mikulov

Doba římská

- **bohaté kostrové hroby**
 - ve starší DŘ – horizont – **lubieszewský**
 - minimum zbraní
 - bohatá výbava (římské „importy“, ostruhy)
 - výdřeva hrobové komory
 - v mladší DŘ – horizont – **Leuna – Hasleben**
 - se zbraněmi a další bohatou výbavou (domácího původu)
- **bohaté žárové hroby**
 - v bronzových nádobách, římské importy, zbraně, osobní šperk
- **nerituální hroby**
- **kenotafy**

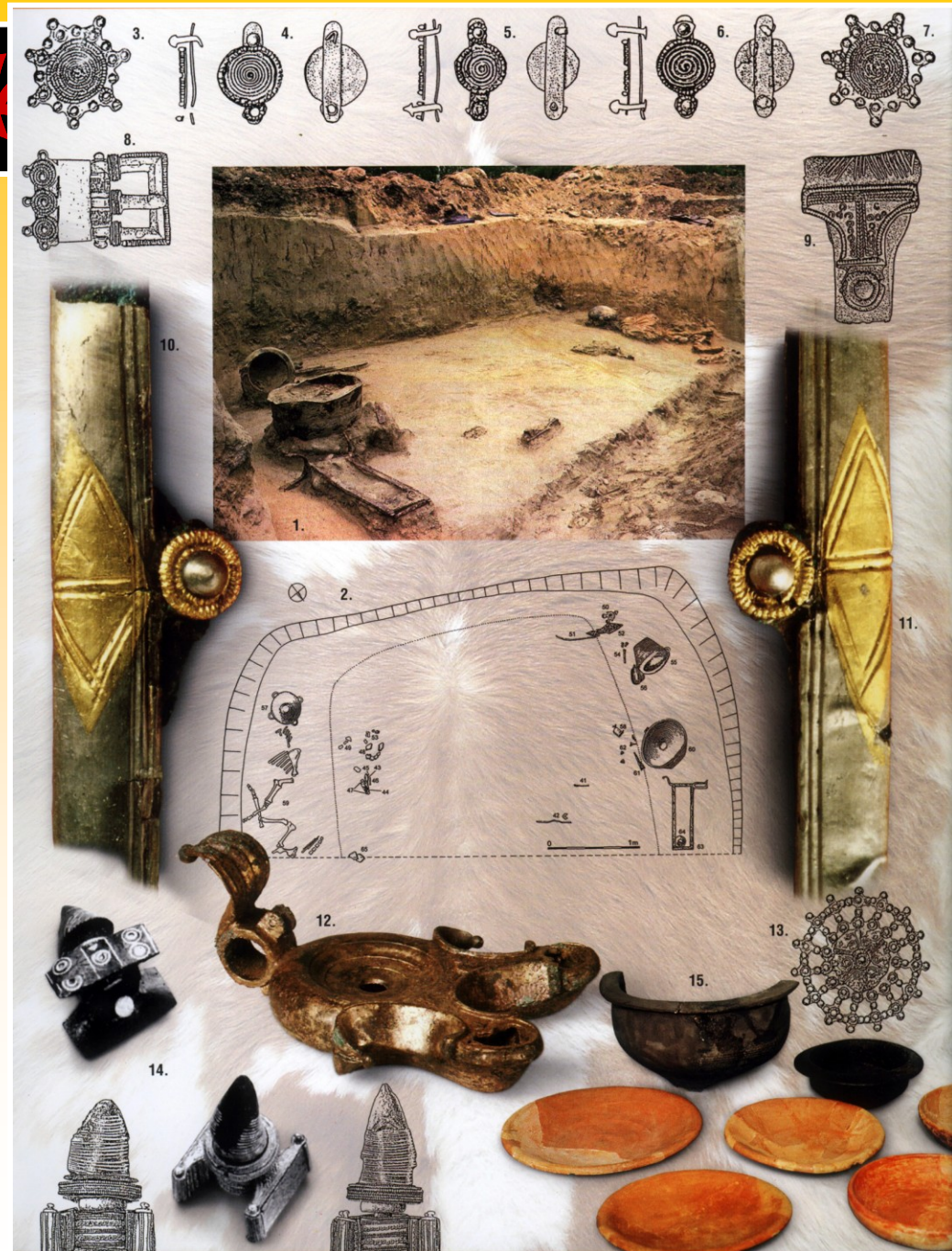

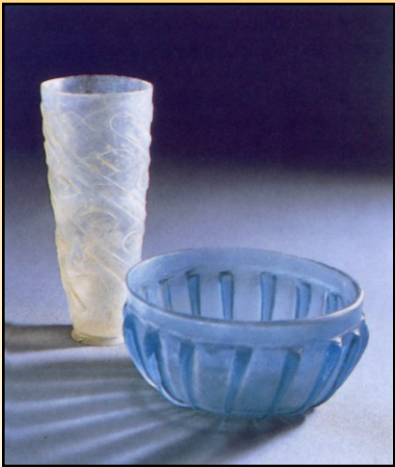
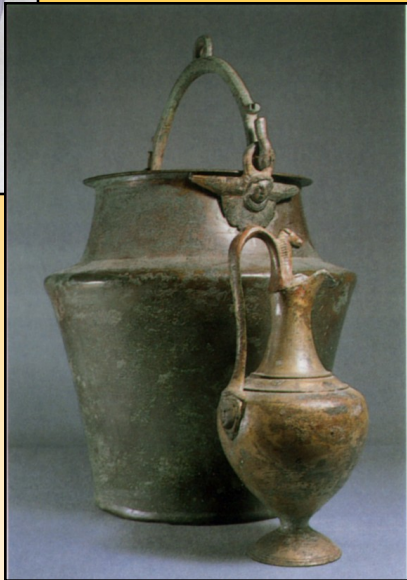

sídlíšte

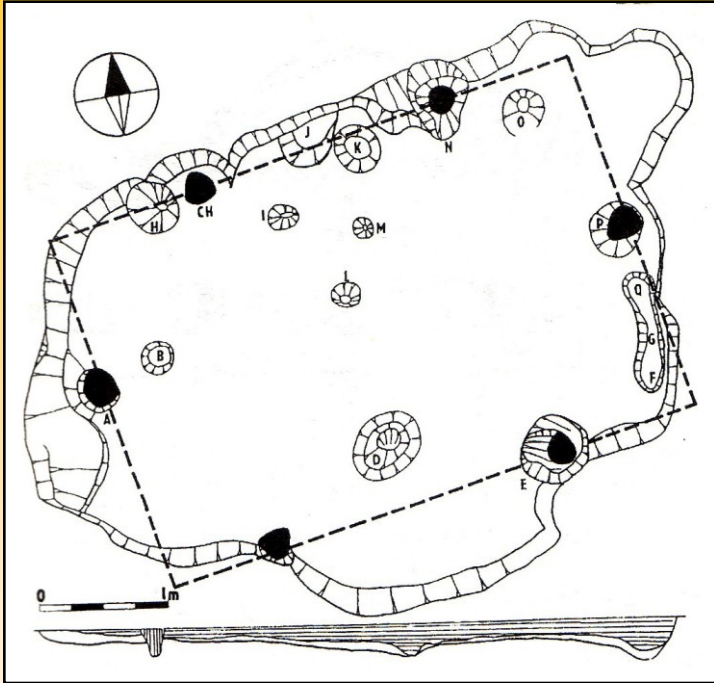

- nížinná neopevněná
- **lokality:** Vyškov, Mlékojedy, Březno, Holubice, Mušov – U sv. Jana

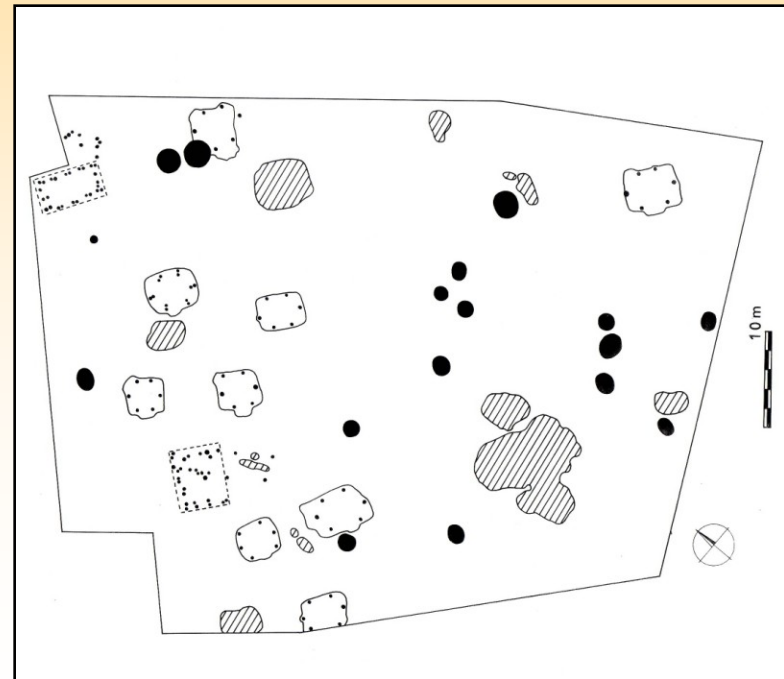

keramika

- **tvary:** hrnce, misky, teriny, lahve, pohárky, cedníky; tyglíky
- přesleny, tkalcovská závaží
- **typy:** plaňanská, jiříkovická (šedá na kruhu)
- v roce robená, točená na kruhu
- hrnčířství
 - **pece** – osamoceně nebo dílna (Jiříkovice, Olomouc-Neředín)

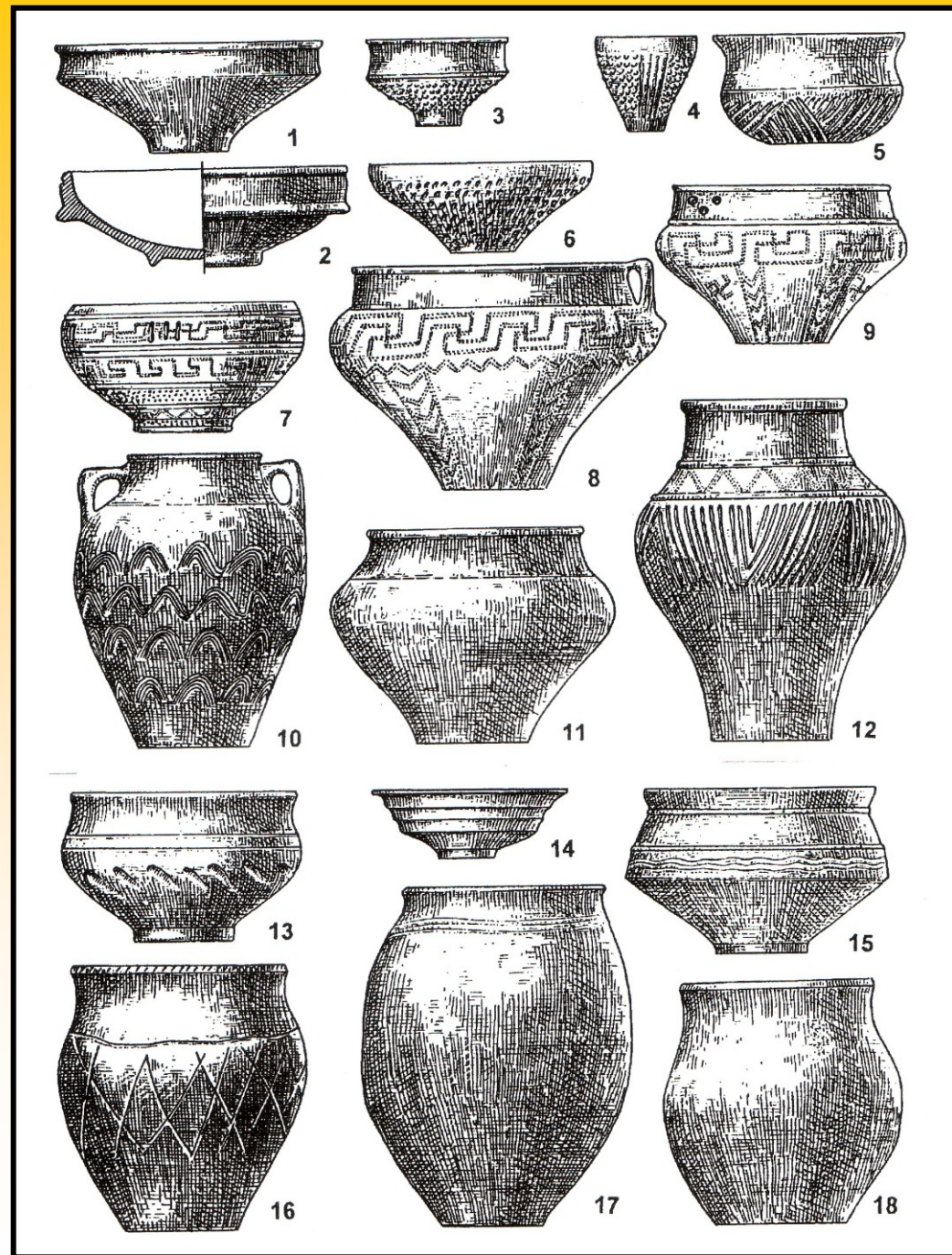
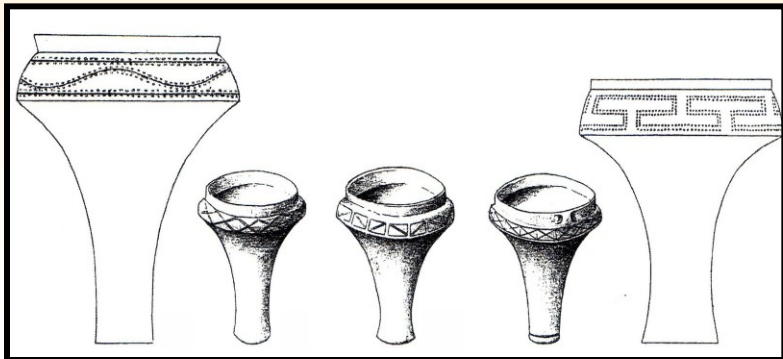

Spony

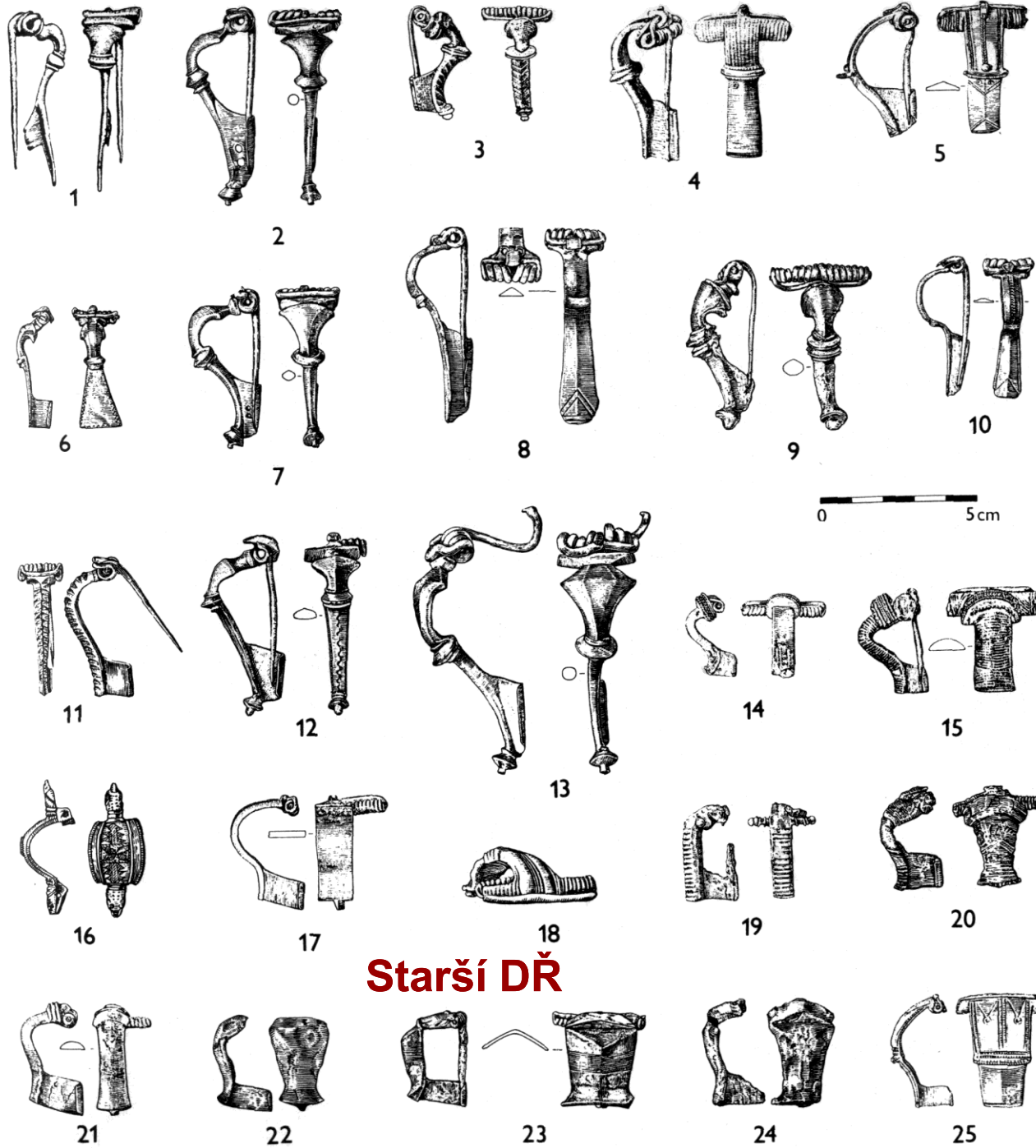

Spony

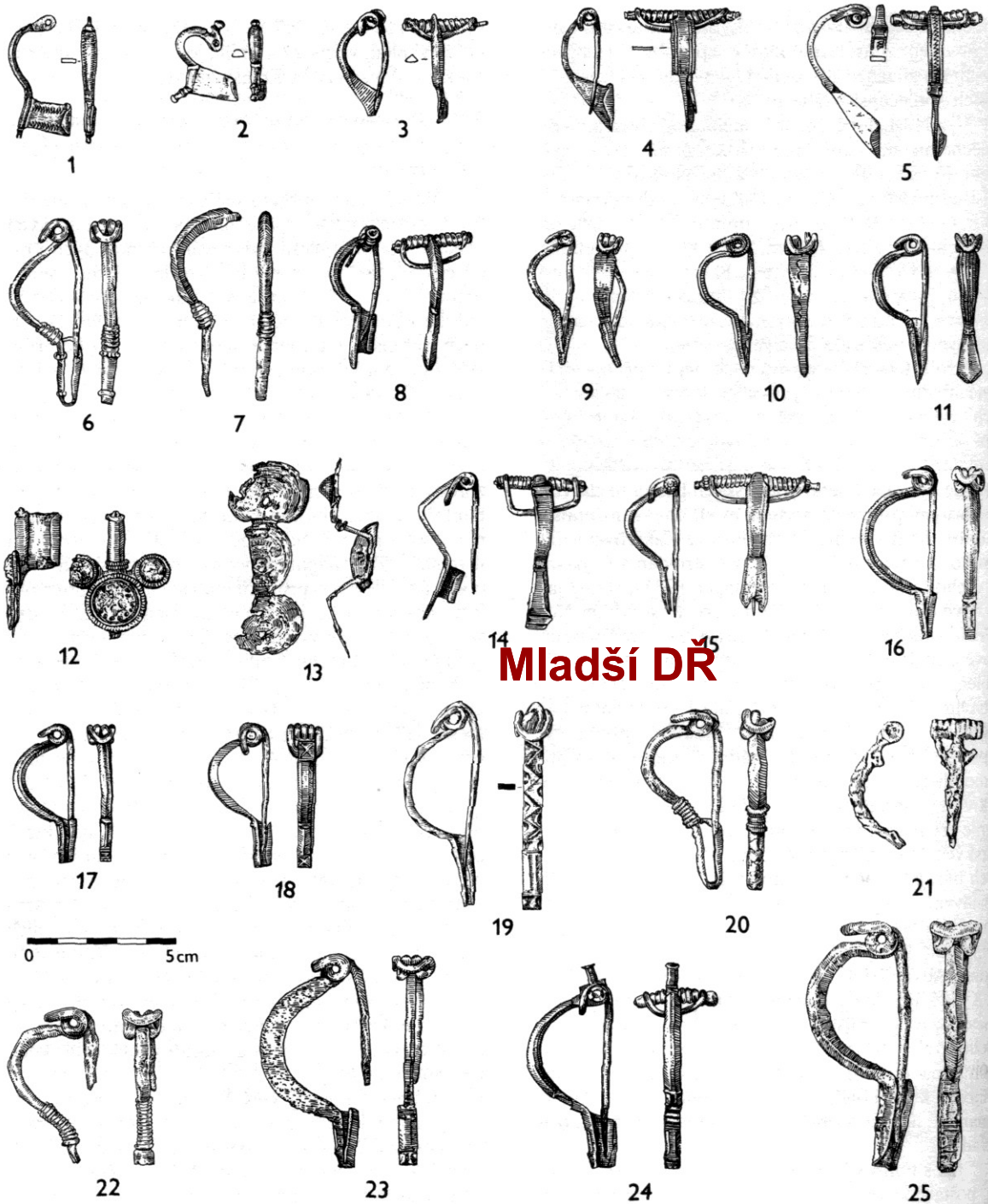
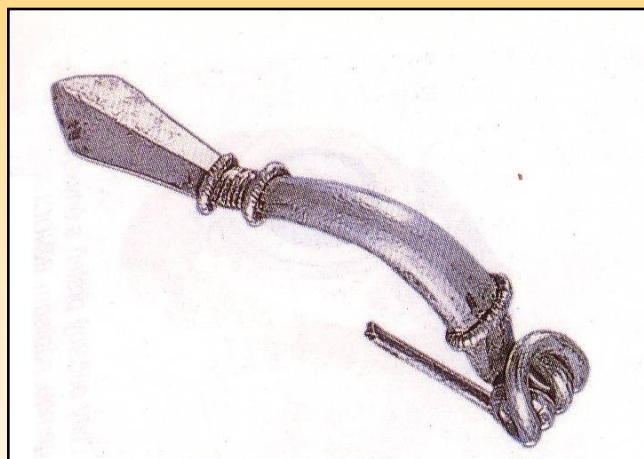

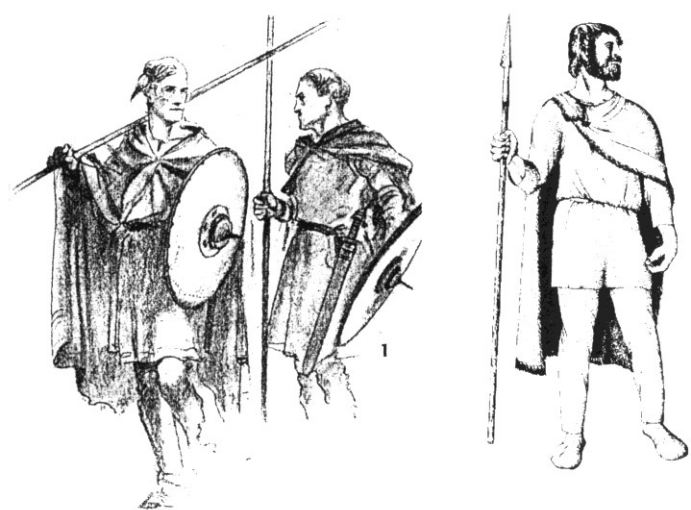

- meč
- kopí
- oštěp
- štít
- luk a šípy
- sekery



výzbroj



Římské „importy“

- **Toreutika** – typologie podle Eggerse
- kotle, vědra, pánve, naběračky, cedníky, konvice, aj.)



Římské „importy“

- **Terra sigillata** (typologie podle Draggendorfa)
 - z dílen ve Westerndorf, Lezoux, Rheinzabern
- **Terra nigra**
- **Provinciální keramika**

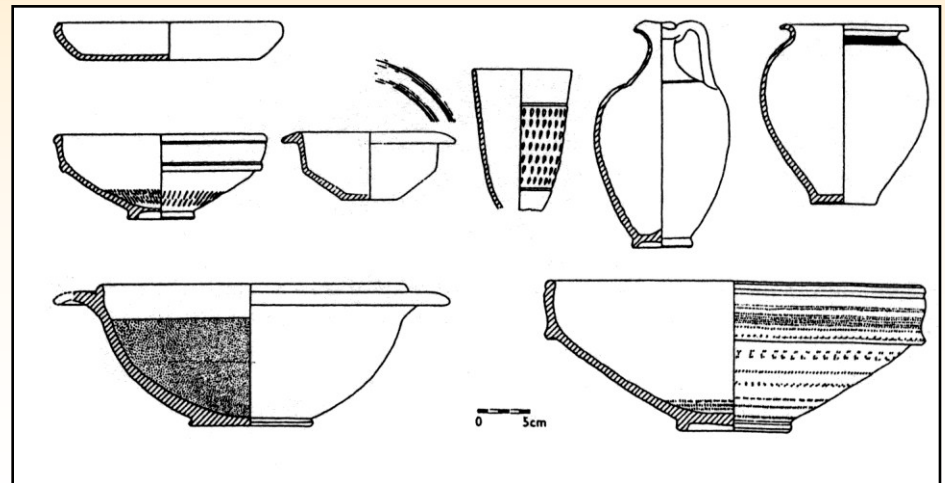
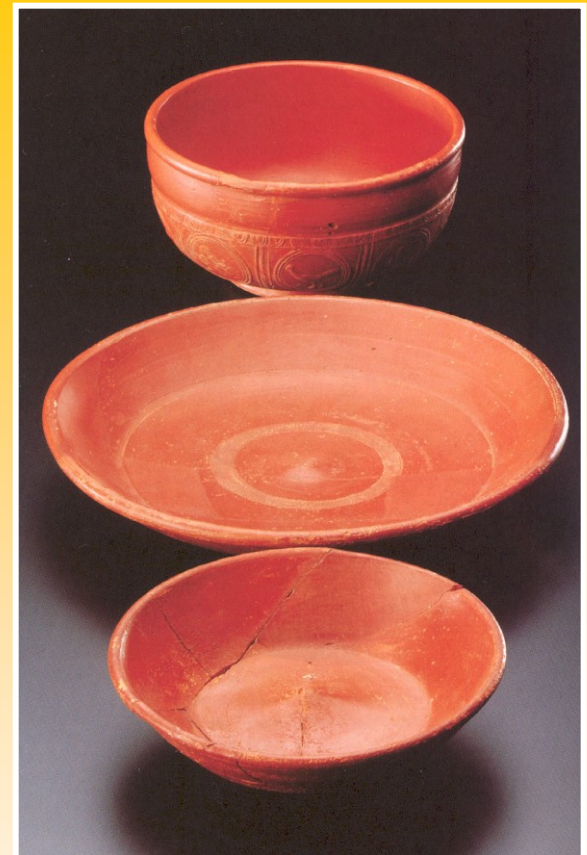

Římské sklo



- nádoby
- perly

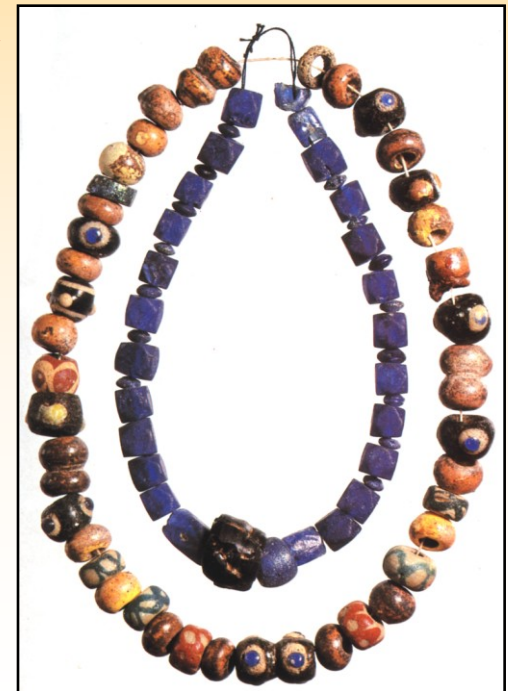

Římské mince





provinciální spony

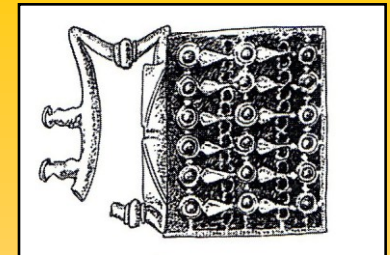
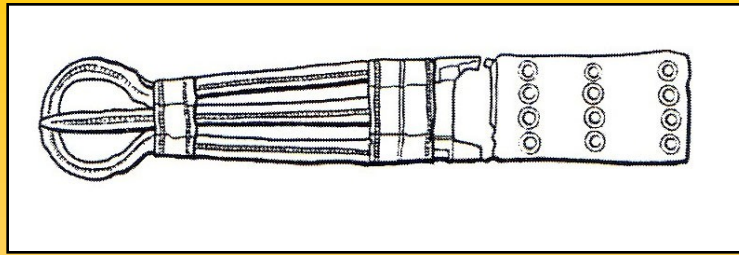

kování opasků

výzbroj

- lorica hamata, squamata
- meče s kruhovou rukojetí
- štíty – polokulovité štítové puklice

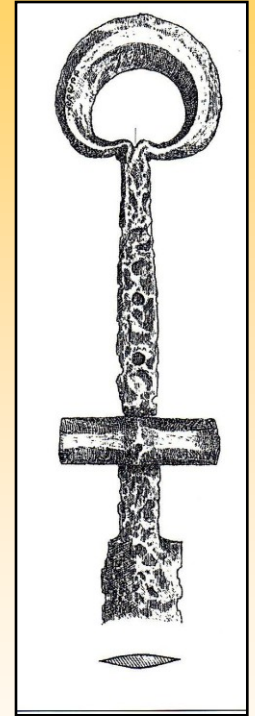
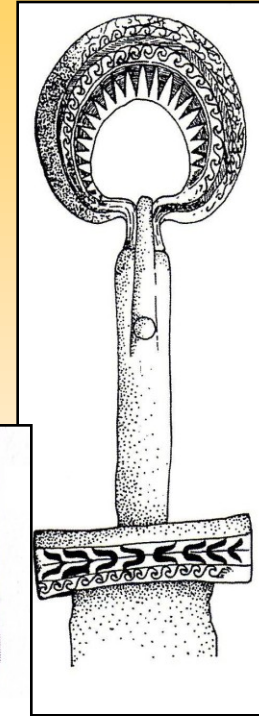
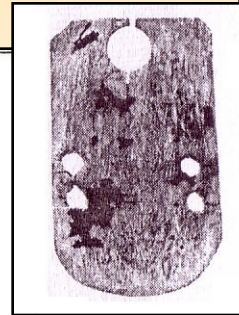
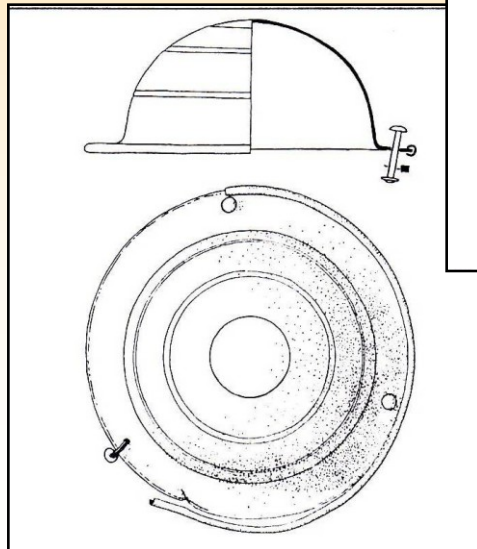

Provincie a LIMES ROMANUS

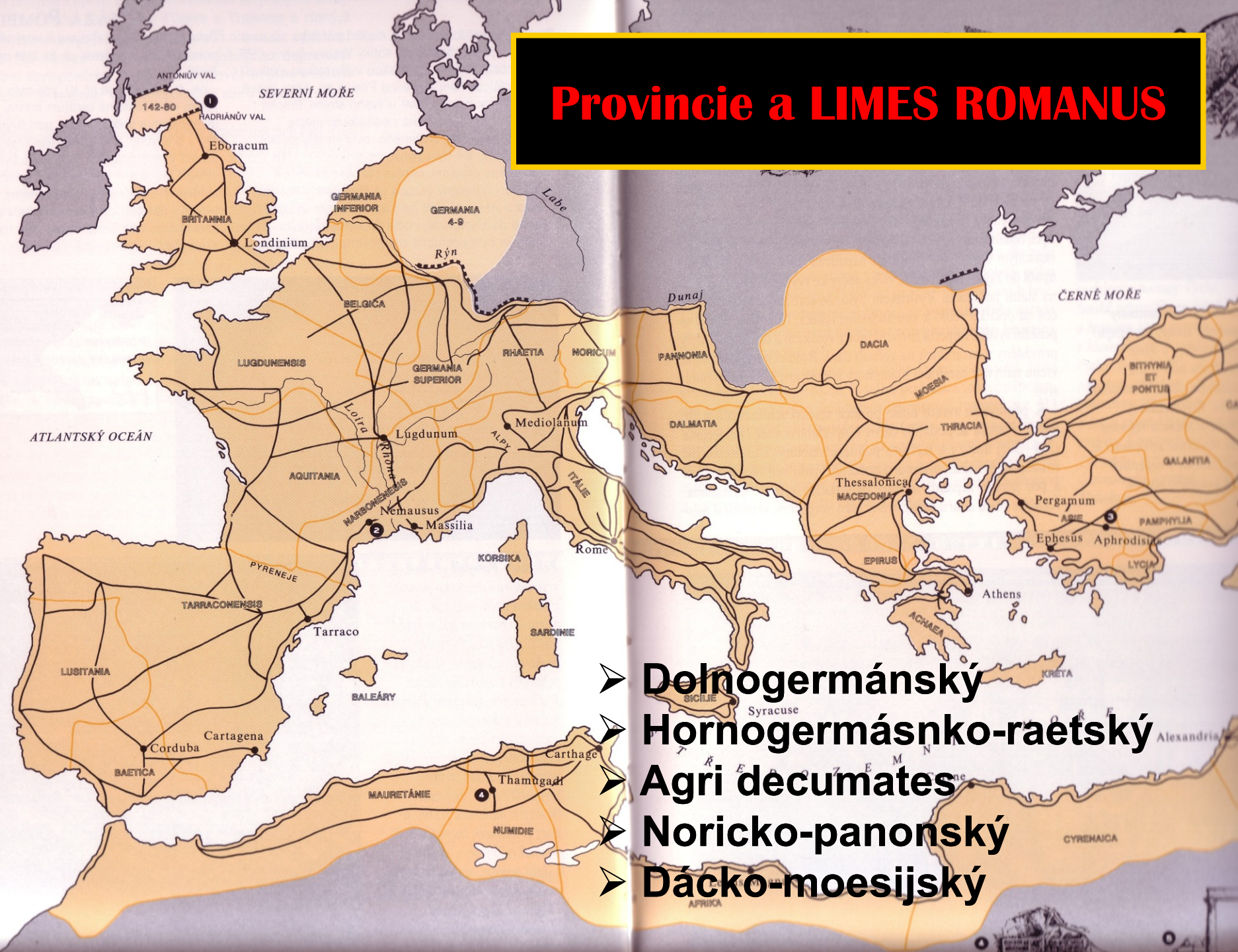

- **Dolnogermánský**
- **Hornogermánsko-raetský**
- **Agri decumates**
- **Noricko-panonský**
- **Dácko-moesijský**

Limes romanus a provincie

- přirozená (řeka) nebo uměle vybudovaná hranice ŘŘ (Flaviovcí, Trajan, Hadrian; po roce 9 ustálení hranice na Rýně a Dunaji)
 - **umělá**: val, příkop, nebo i palisáda a zeď

- **castrum (legionářský tábor)**
- **castel (auxiliární tábor)**
- **burgus**
- **v blízkosti civilní stavby (canabae; civilní města – municipium)**



Legie a auxilie

- **Legie** (10 kohort, 30 manipulů, 60 centurií)
 - 6000 vojáků a 120 jezdců (equites)
 - zbraně a služby (technické oddíly: tesaři, kováři, zbrojíři)
 - pěchota – těžká, lehká
- pomocné sbory: **auxilie** (500 – 1000 mužů; ala – jízdní oddíl; turmae - čety)

noricko-panonský limit

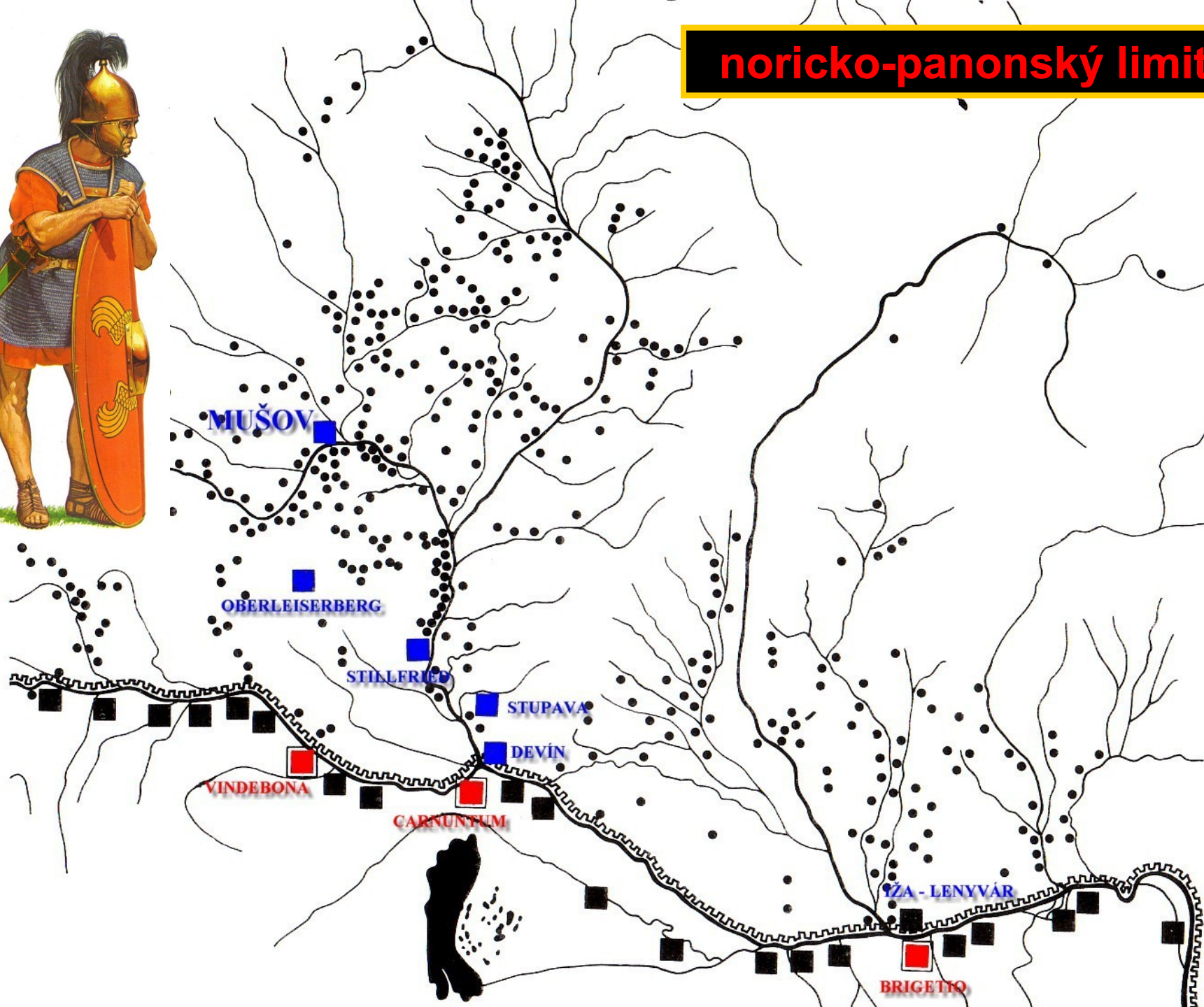

- půdorys castelu pomocné jednotky v Künzingu (Qintana)

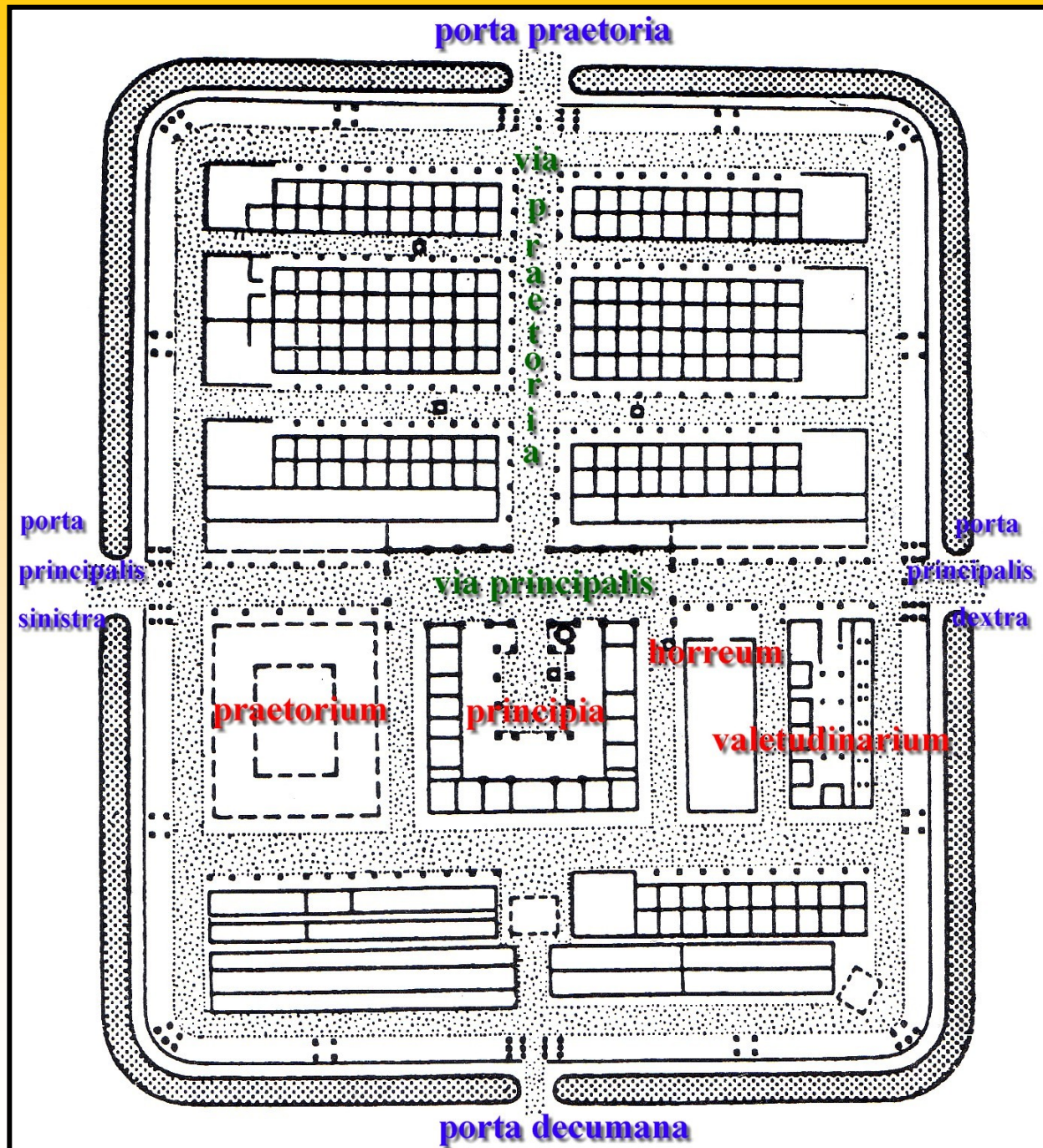

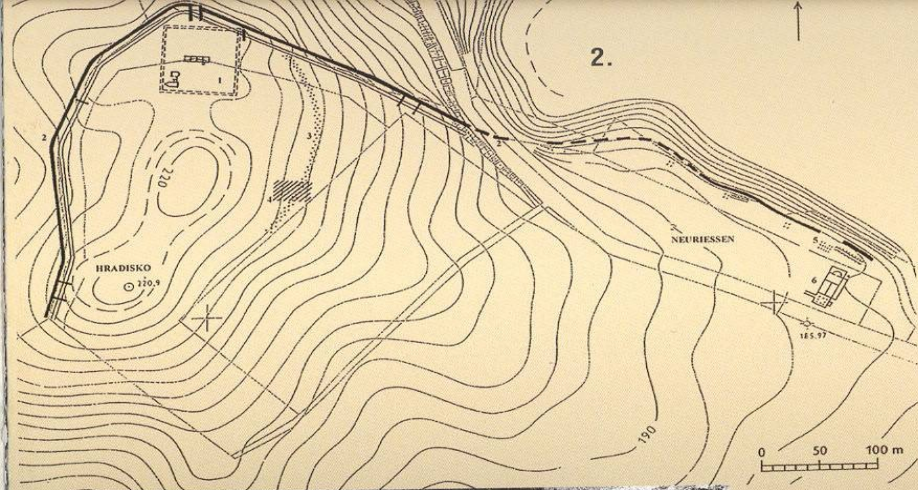

4.



Mušov

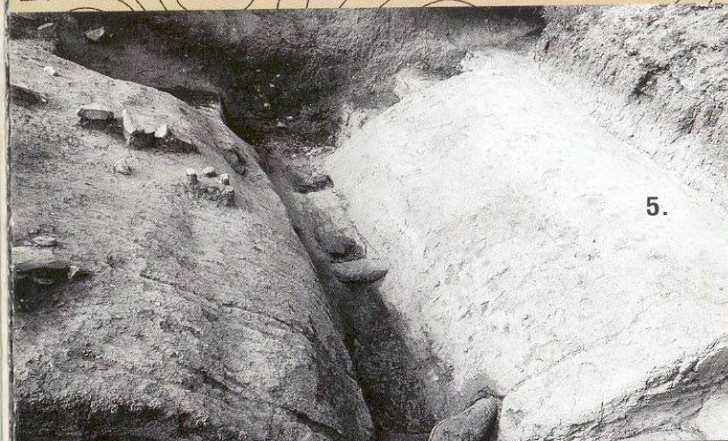

5.

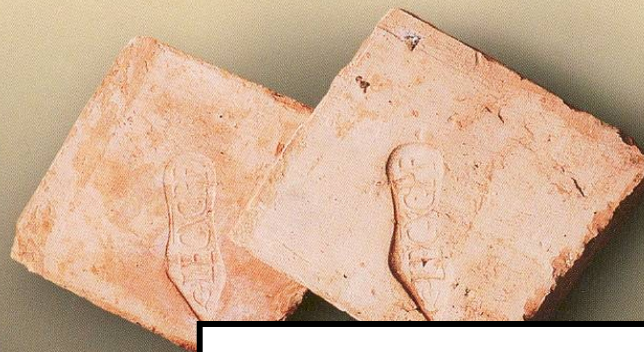

- **Burgstall (80 km od Vindebony) – vojenské využití**
 - cihly s kolcem X. Gemina Pia Fidelis a XIII. Legie
 - praetoria, balneum (podpodlažní topení – hypocaustum)
 - fabrica (dílny)
- **Neuriessen (min. 5 pochodových táborů), řím. stavba**



6.

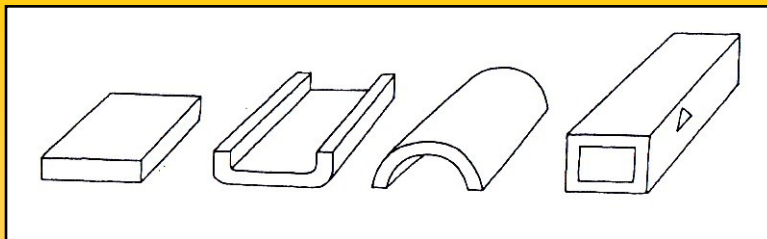

lateres imbrex

tegulae tubuli

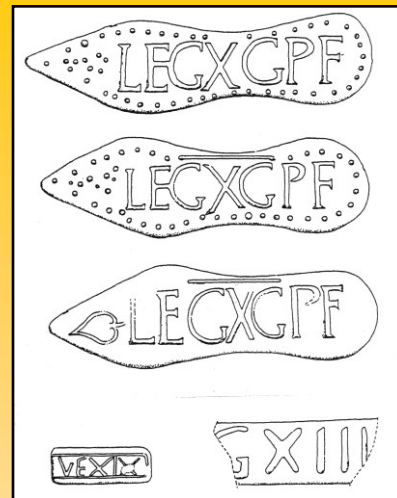

hypocaustum

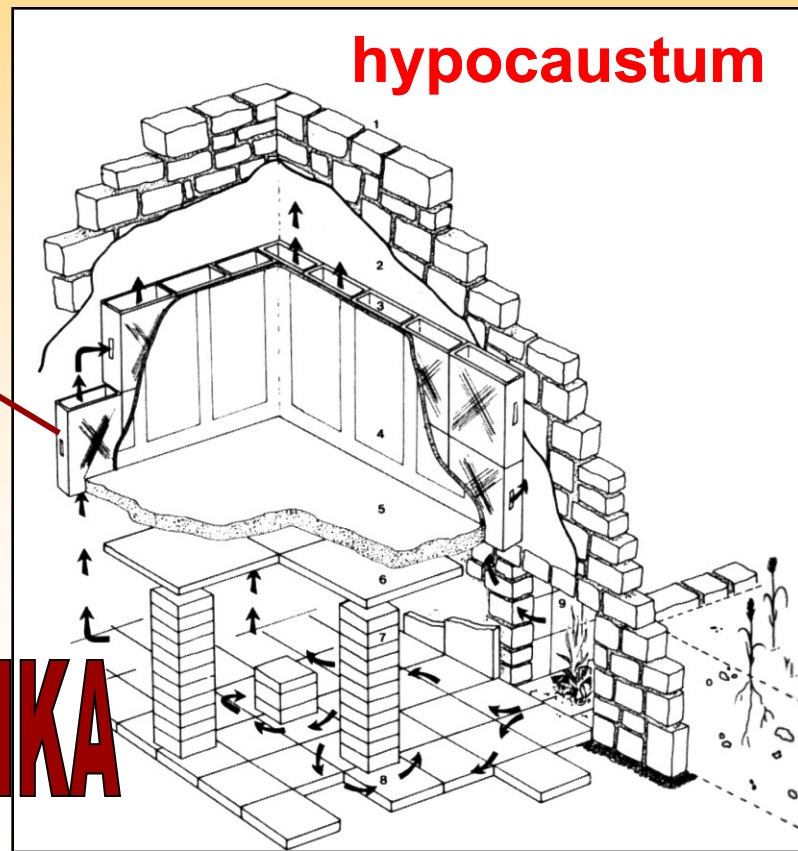

STAVEBNÍ KERAMIKA

pochodové tábory

Mušov, Brno-Modřice,
Olomouc-Neředín, Ivaň,
Přibice

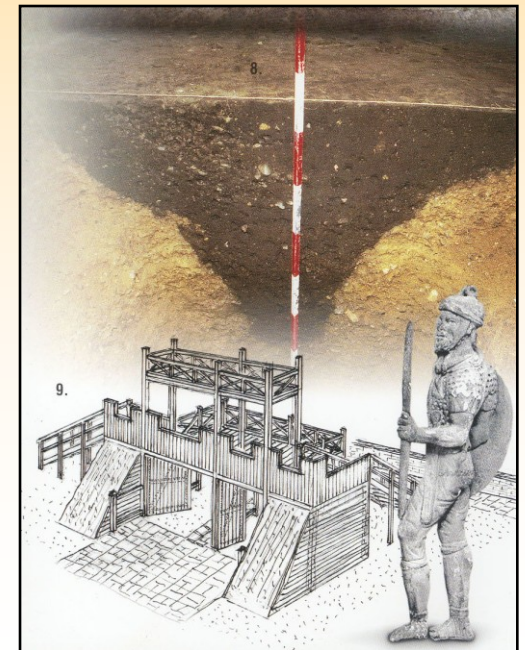
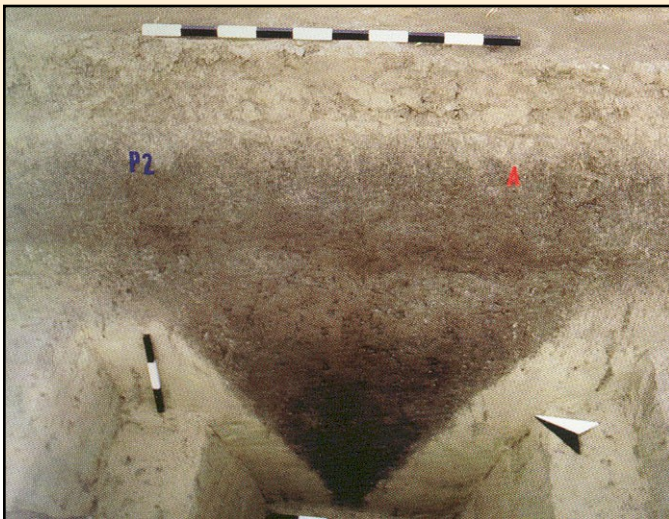

ŘÍMSKÉ VOJÁKO - LEGIE

- lorica hamata (kroužkové)
- lorica squamata (šupinové)
- lorica segmentata (lamelové)

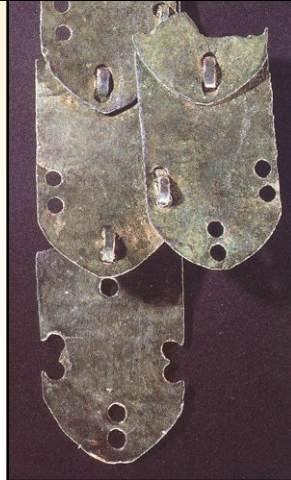
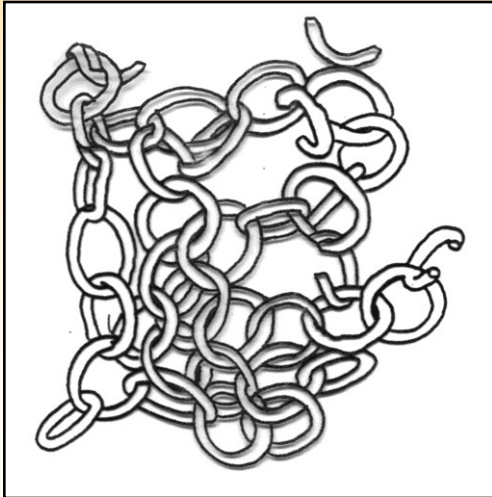
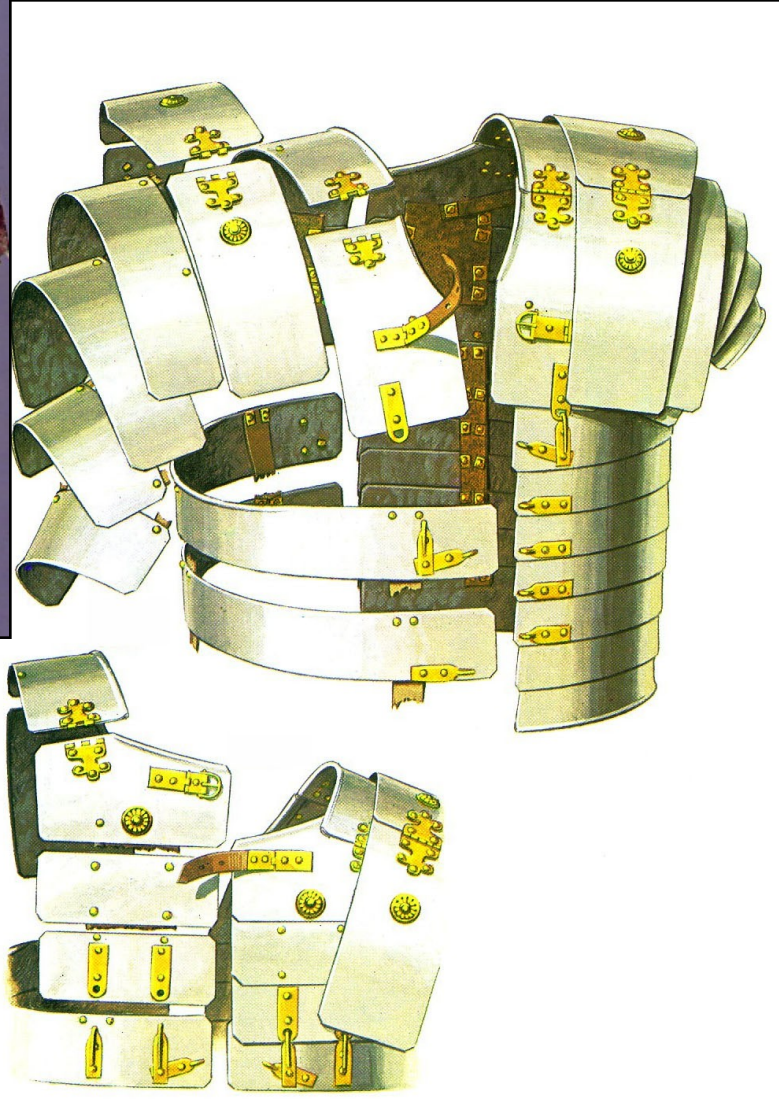



maskovité jezdecké

PŘILBY

přilby pěchoty

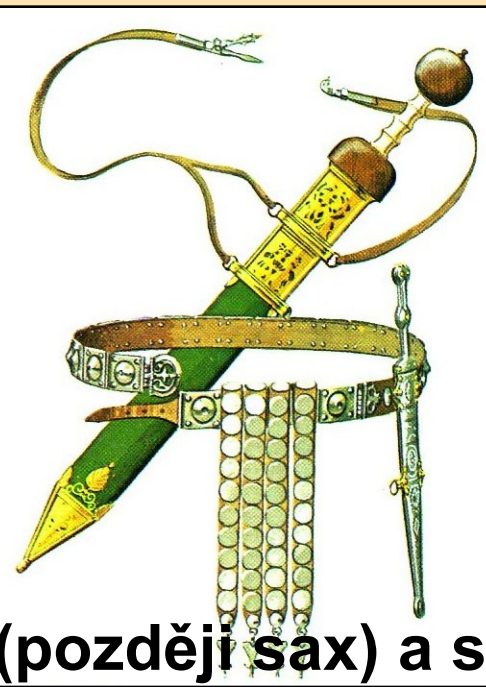
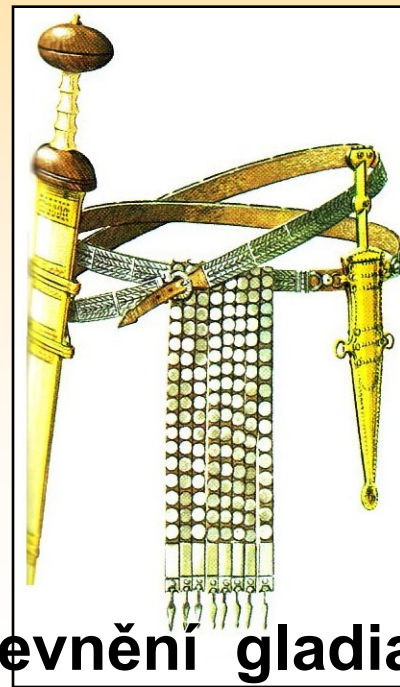

cingulum a upevnění gladia (později sax) a spathy (meče)



pilum



kopí



pugio (dýka)

PROVINCIÁLNI SPONY

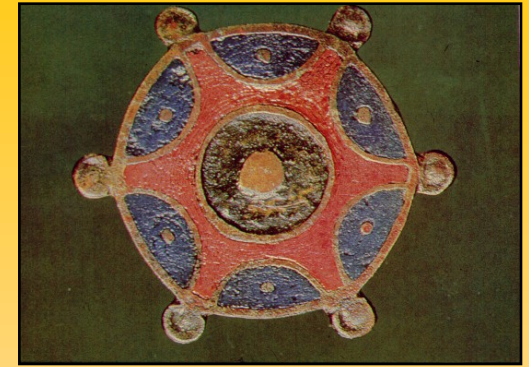

Aucissa
emailové
kolínkovité



DSH

PR

- kostrový
 - zbytky rakví
 - s kruhovými příkopy
 - bohaté hrobky
 - Strachotín
- výbava:
 - spony: stříbrné (gótské) (zlačené) plechové spony velkých rozměrů
 - ozdoby s polyedrickými korály
 - na Slovensku - cikádovité spony

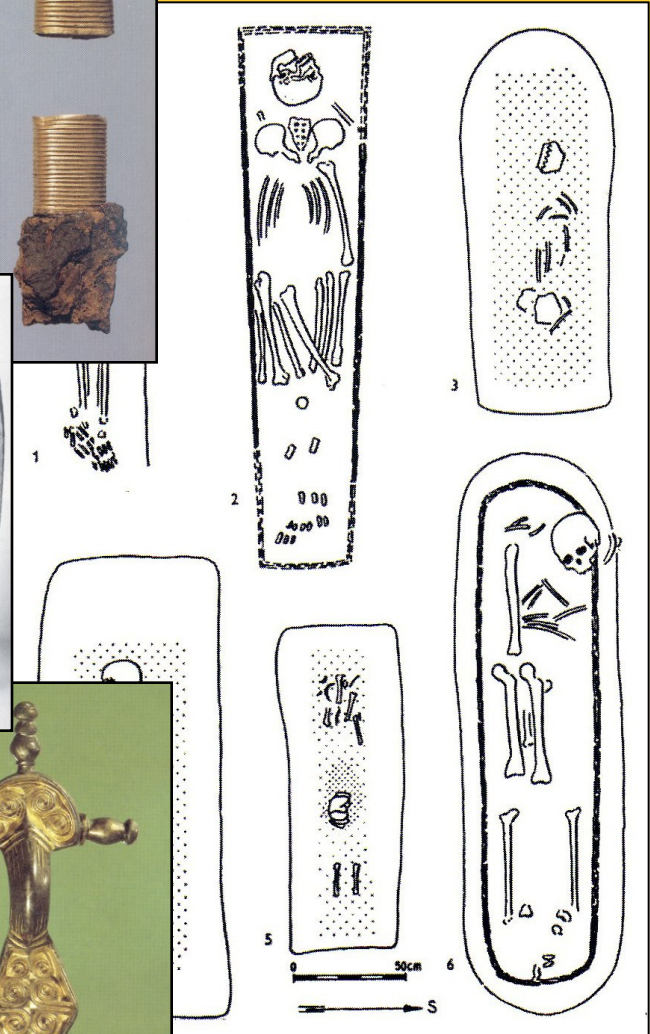
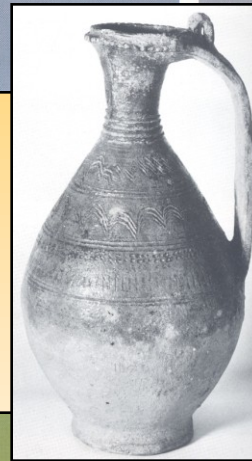

sídliště

- zlechovský typ – úpadková keramika
 - chaty se 6 kůly
 - chaty bez kůlů, aj.
- sídliště – Březno u Loun, Velké Němčice
- výšinná sídliště (Znojmo, Líšeň) – asi bez opevnění

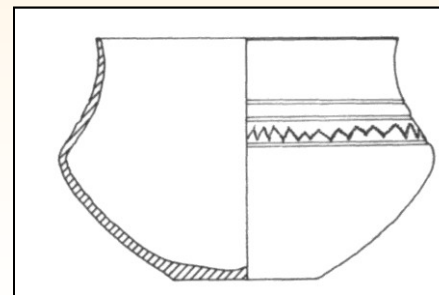
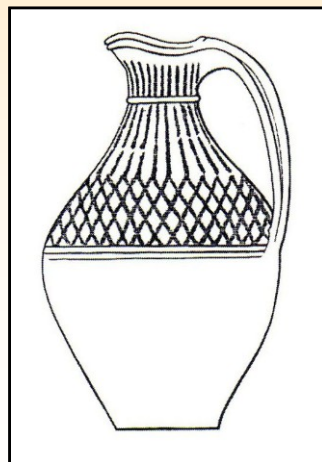
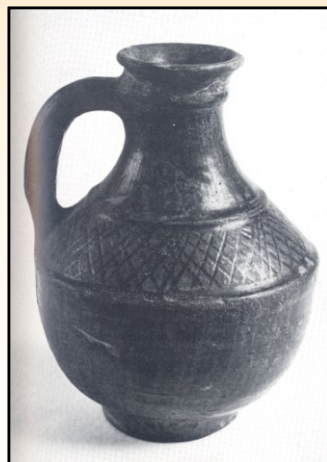
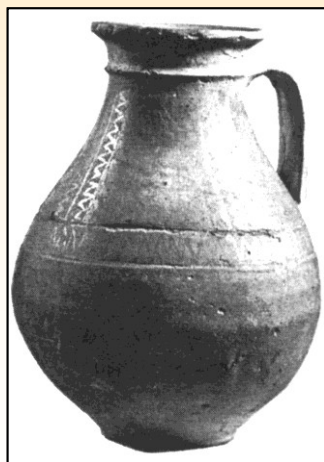
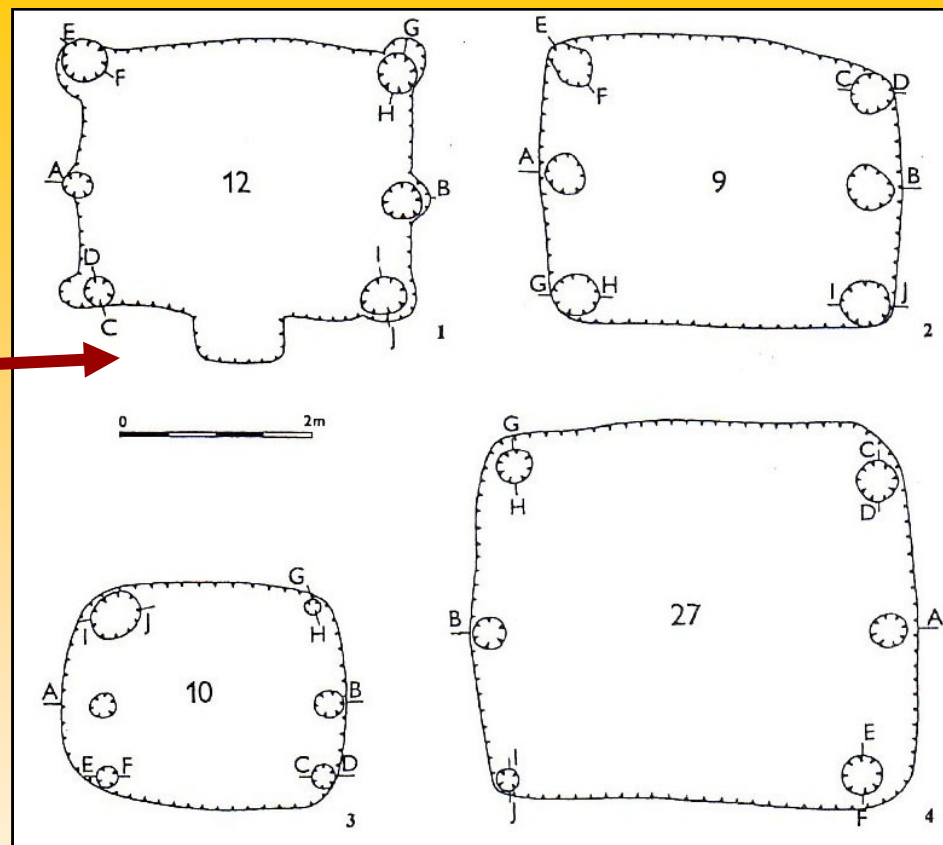

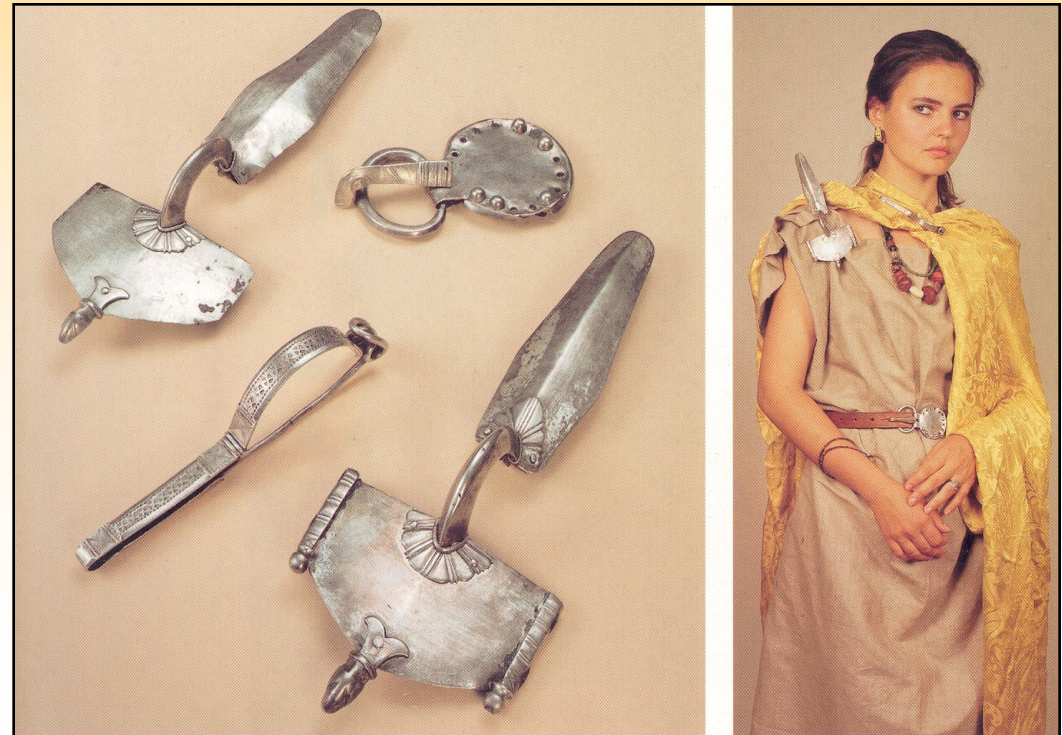
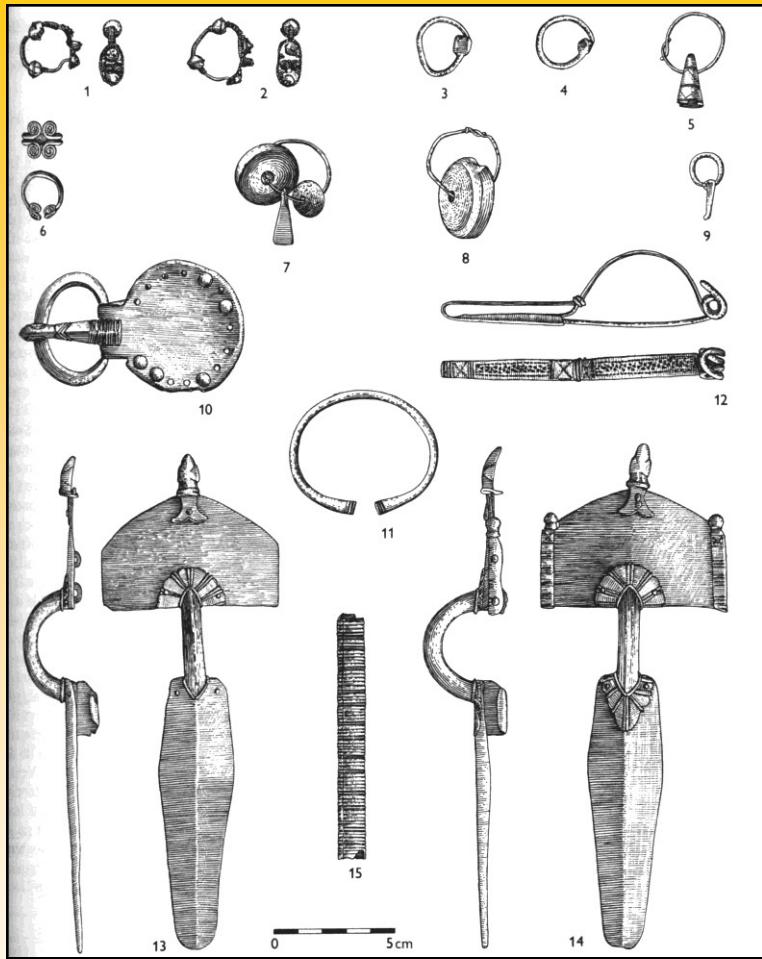

Smolín

Horizont Smolín

Hunové

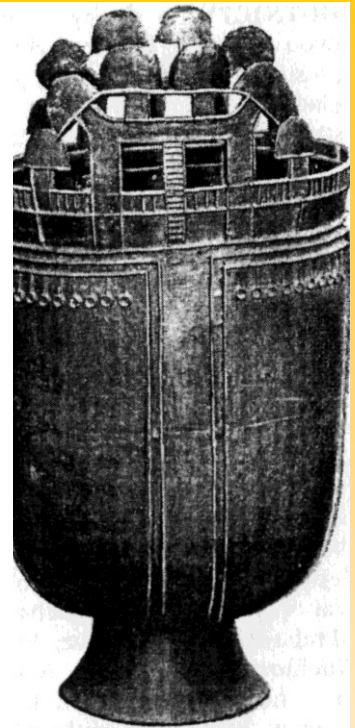
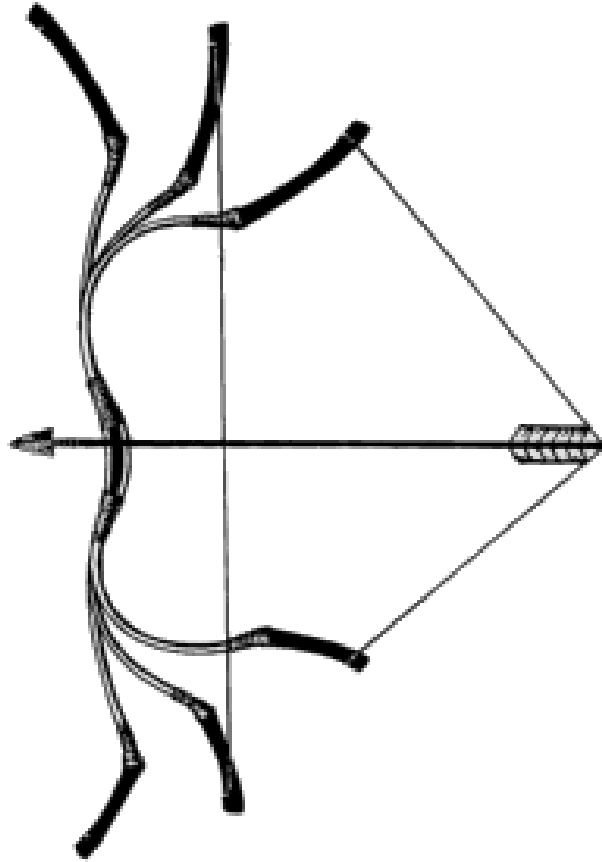

Dějiny Hunů

- Rozpínavost Číny způsobila zánik říše Žuan-žuan a Hunové se vydali k západu
- 375 napadli říši Ostrogótů u Černého moře a vtrhli do Evropy
- K jejich kmenovému svazu se přidalo i mnoho jiných kmenů, hlavně Germáni (Góti, Herulové, Vandalové)
- 434 sjednoceni pod nadvládou krále Attily, který vytváří kmenový svaz s centrem v Karpatské kotlině
- 451 Attila poražen Římany a jejich spojenci vedenými vojevůdcem Aetiem
- 453 Attila otráven na své svatbě
- 454 Attilovi synové poraženi germánskými kmeny a Hunové se stahují na východ

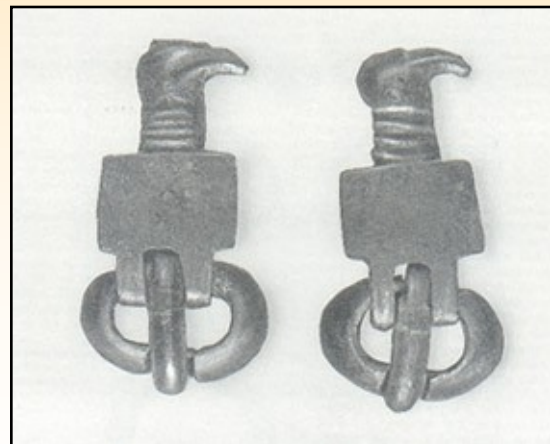
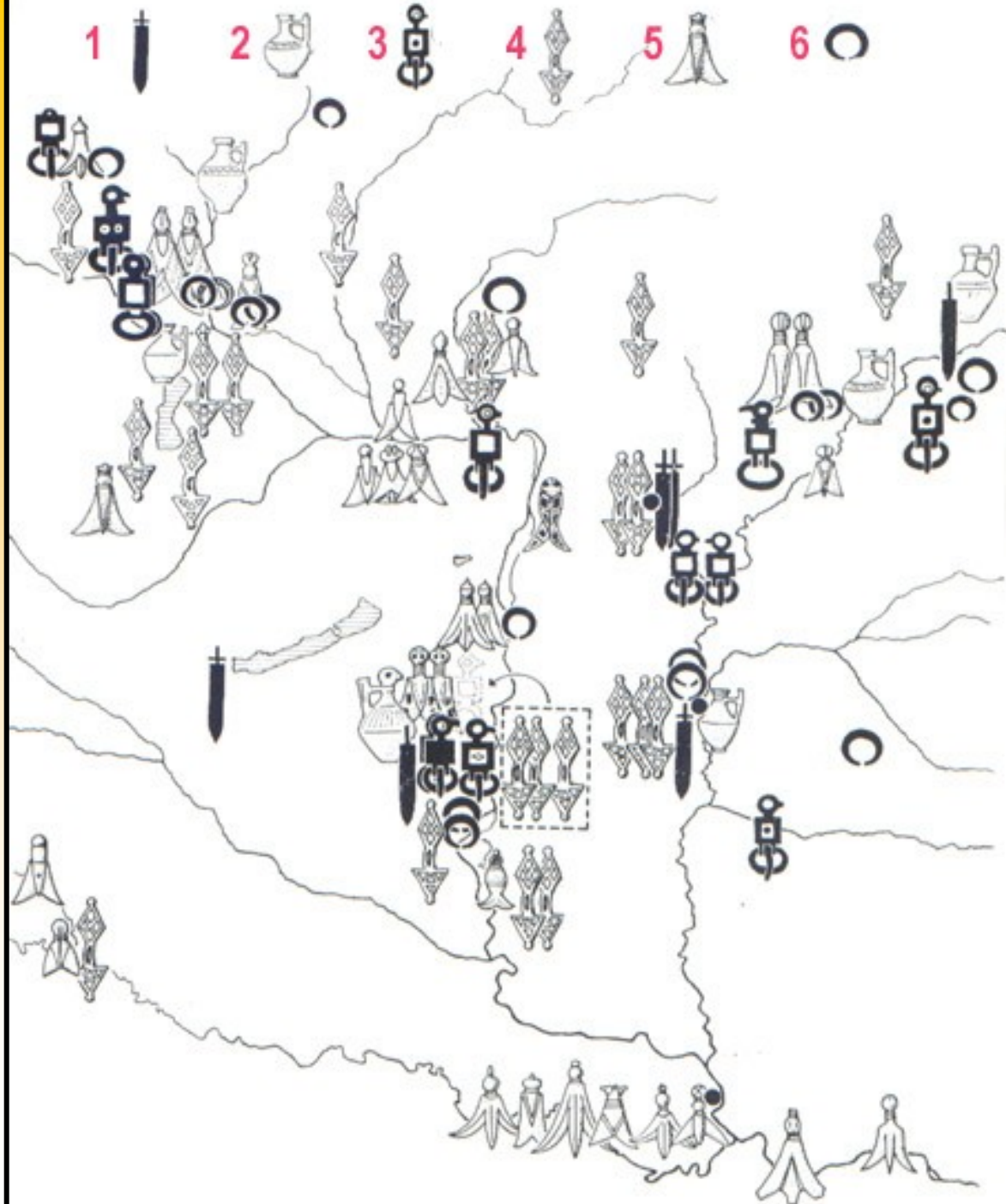

Blučina

- složka:
 - domácí
 - stepní
 - římská

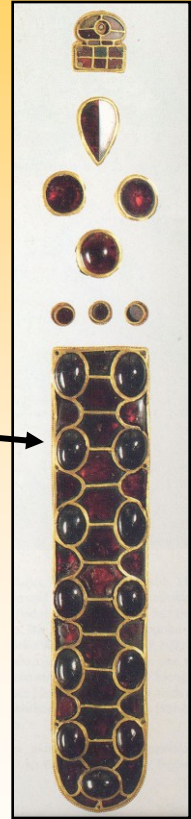
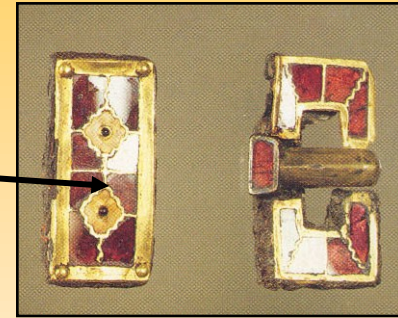
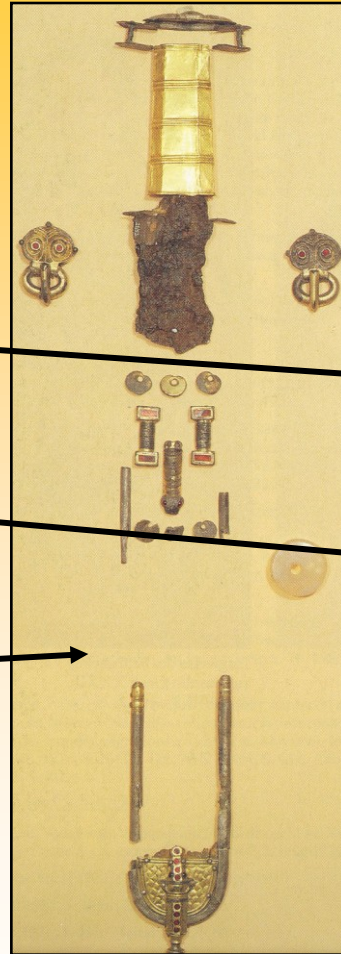
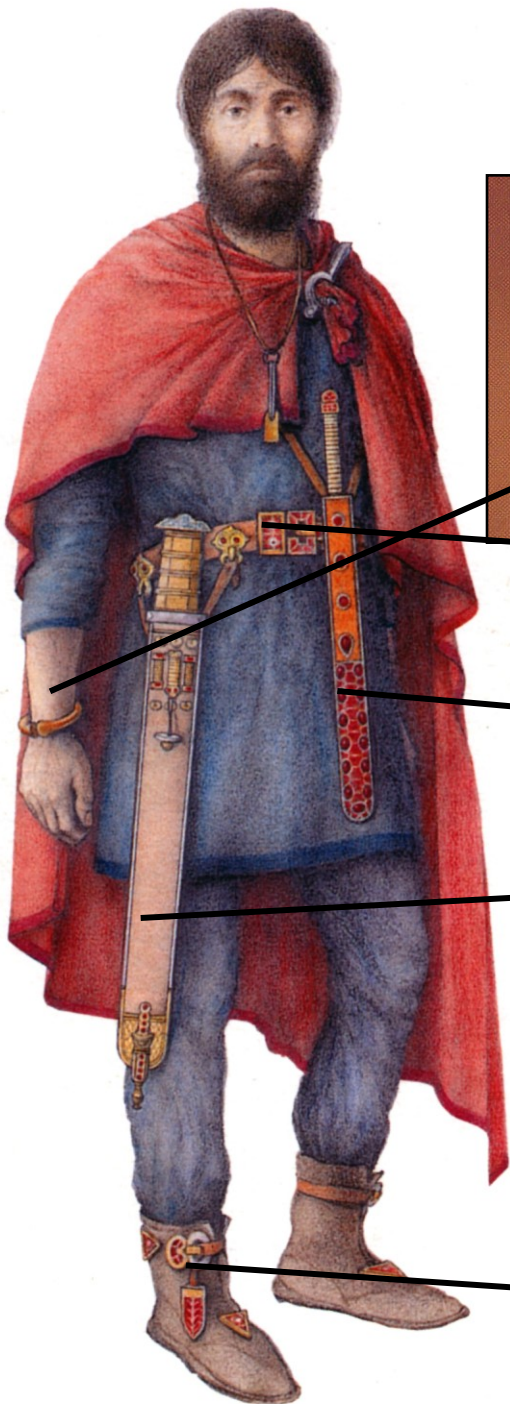

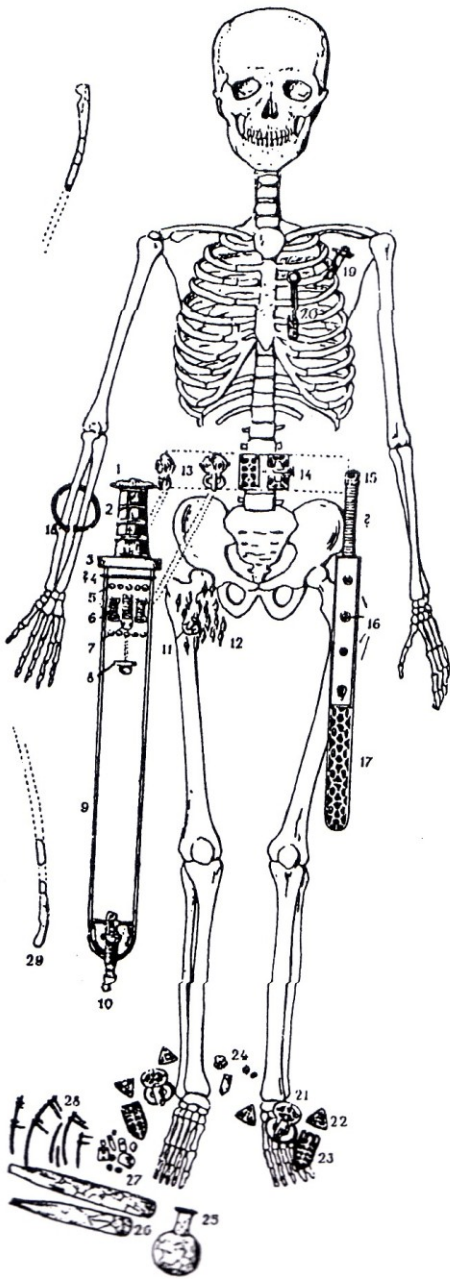

- orientace V-Z
- muž 35-40 let
- výbava
 - zbraně (spatha, sax, 15 železných hrotů šípů, kostěné obložení reflexního luku)
 - kování jezdeckého bičíku, kování sedla
 - náramek (zlatý)
 - stříbrná samostřílová spona s cibulovitými knoflíky
 - kostěný hřeben
 - 3 skleněné nádoby
- datace: 450 – 480
- etnicita: snad Herul

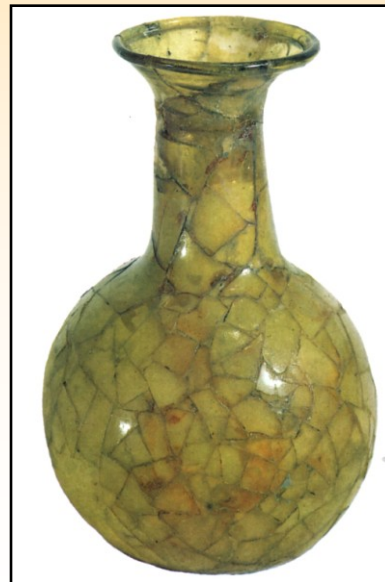

LANGOBARDI

- polabští Germáni
- v první polovině 5.st
posun podél toku
Labe na J
- spony: 3 časové horizonty

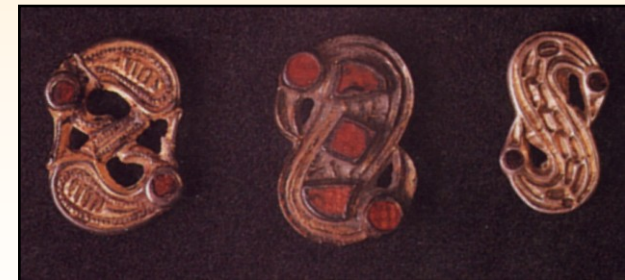
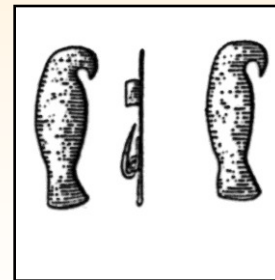

Dějiny Langobardů

- počátkem 5. století táhnou z dolního Polabí k jihu, procházejí Čechami k Dunaji
- 488 doloženi u Dunaje v Rugilandu (Waldwiertel?) pod panstvím Herulů, vládl jim král Klafo
- Král Tato porazil 508 Heruly a založil říši Langobardů ve středním Podunají
- Král Wacho říši rozšiřoval, snad pohřben na Žuráni
- Král Alduin přesunul Langobardy do Karpatské kotliny, kde bojoval s Gepidy
- Král Alboin pozval na pomoc Avary, s jejichž pomocí, sice Gepidy porazil, ale 568 ocházejí Langobardi do Itálie



tkací meč

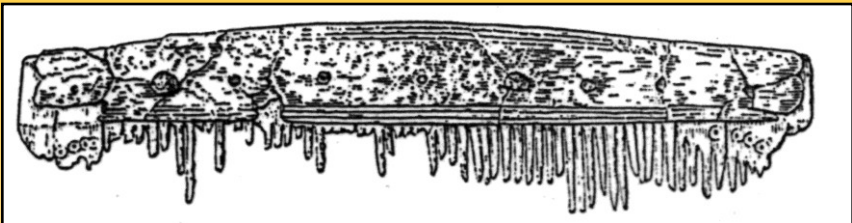

hřeben



klíč

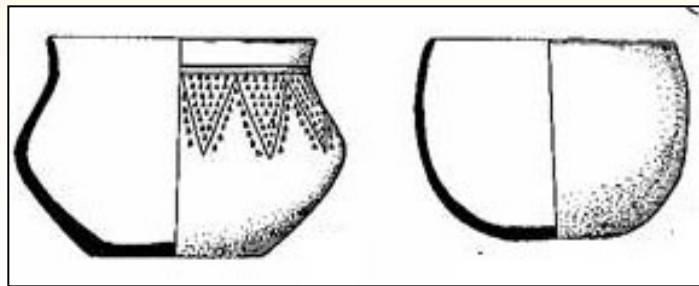
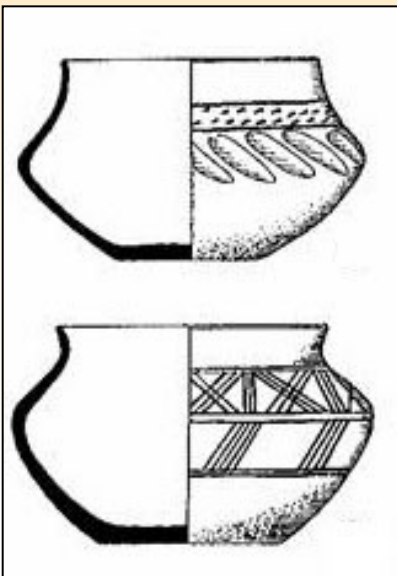

Ženské hroby



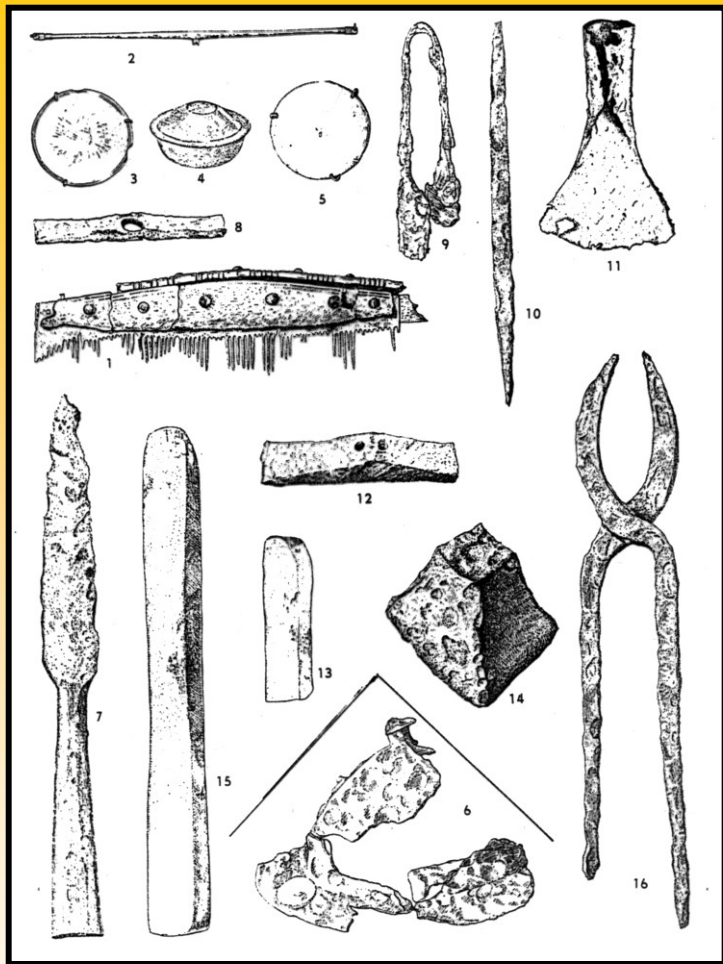

BRNO - KOTLÁŘSKÁ

Mužské hroby

MILITÁRIA

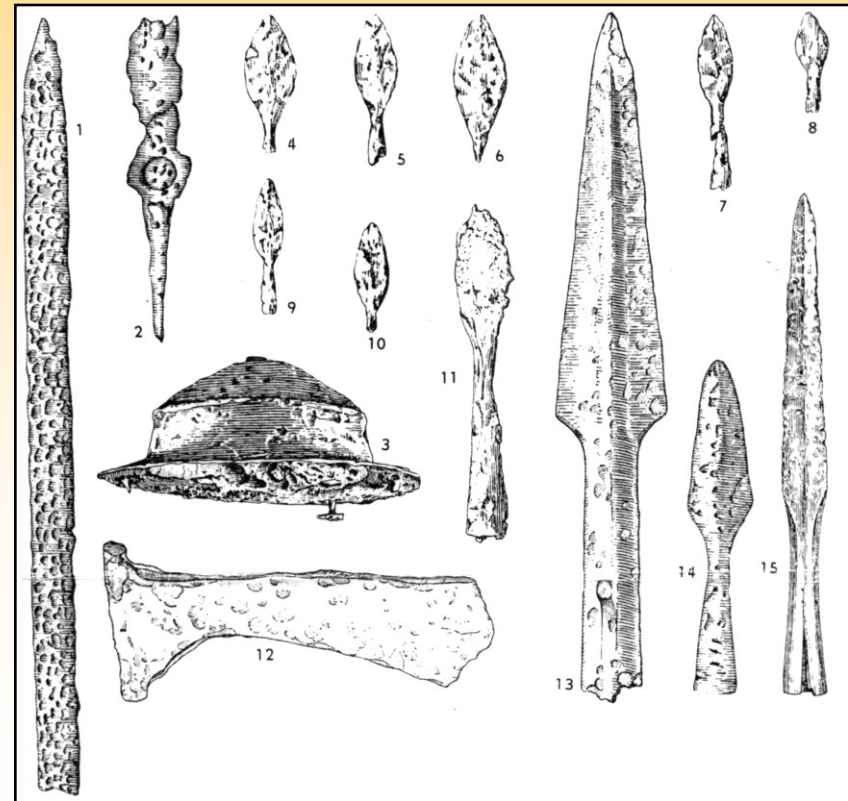
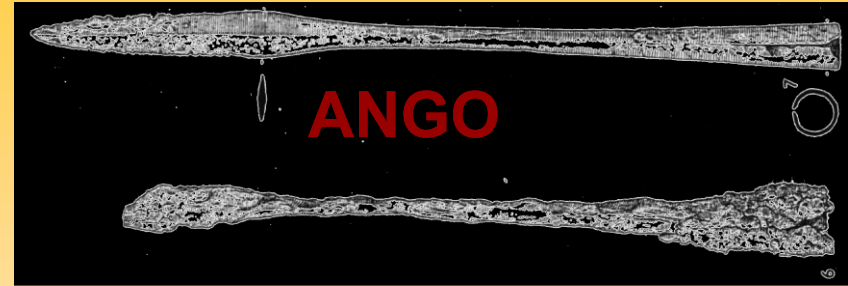
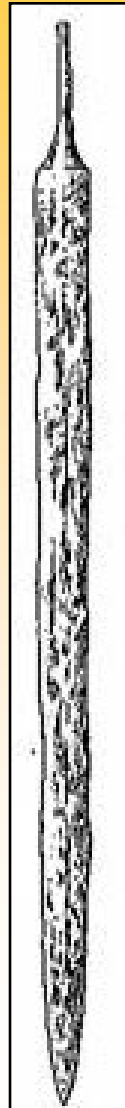

ŽURÁŇ

