

Doba římská a stěhování národů



Periodizace DR

časná DŘ (35/25 př. n. l.-50/70 n. l.)

a) 35/25 – 10/5 př. n. l.

horizont plaňanských pohárů

b) 10/5 př. n. l. – 40/50. n. l.

horizont Marobudovy říše, horizont spon s očky

c) 150/160 – 180/200 n. l.

horizont markomanských válek, hl. Morava

starší DŘ (50/70–180/200 n. l.)

mladší doba římská (180/200-300/320 n. l.)

pozdní DŘ (300/320-380/400 n. l.)



Hlavní rysy DR

- barbaricum x římská říše (ŘŘ) a její provincie
- kontakty s ŘŘ (obchodní - importy, vojenské – stopy římského vojska,...)
- antické písemné prameny - jména kmenů a vládců
- první germánská říše (Marobud)
- žárová pohřebiště (+ knížecí hroby – Mušov...)

Doba římská



PR

- převaha kremace
- deformování předmětů ukládaných do hrobu
 - osobní šperk
 - výzbroj
 - toreutika
 - potraviny – zvířecí maso (prase, tele, kuře, aj.)

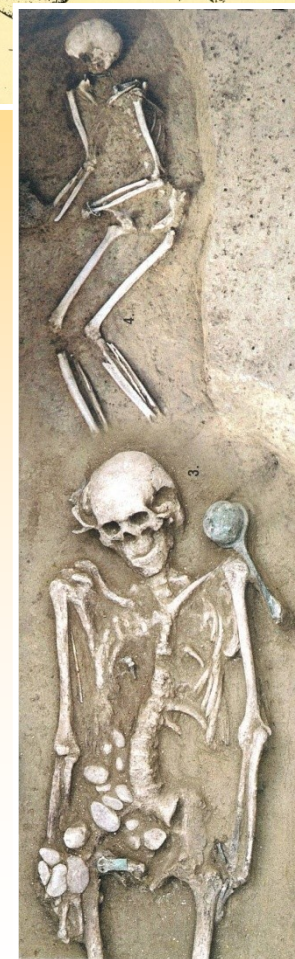

pohřebiště:

- žárová
 - popelnicové hroby
 - jámové hroby
 - Třebusice, Přešťovice, Dobřichov-Pičhora, Kostelec na Hané, Kostolná
- birituální
 - Mikulov

Doba římská

- **bohaté kostrové hroby**
 - ve starší DŘ – horizont – **lubieszewský**
 - minimum zbraní
 - bohatá výbava (římské „importy“, ostruhy)
 - výdřeva hrobové komory
 - v mladší DŘ – horizont – **Leuna – Haßleben**
 - se zbraněmi a další bohatou výbavou (domácího původu)
- **bohaté žárové hroby**
 - v bronzových nádobách, římské importy, zbraně, osobní šperk
- **nerituální hroby**
- **kenotafy**



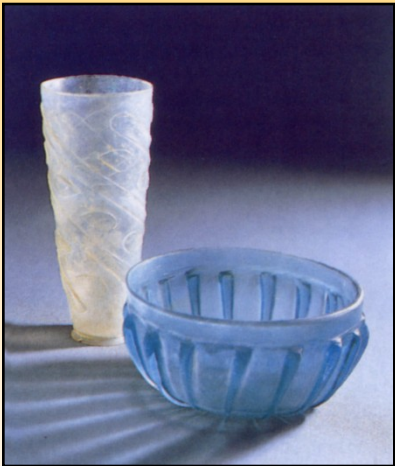
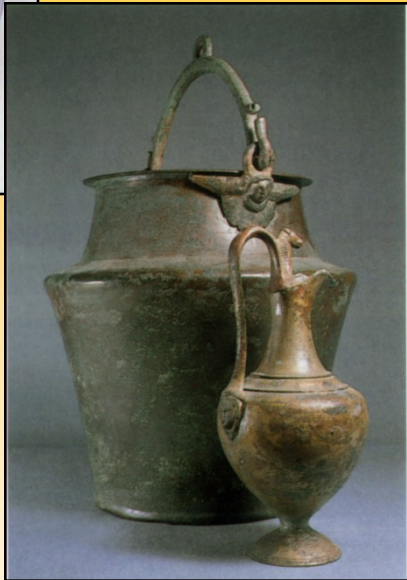

Sídliště

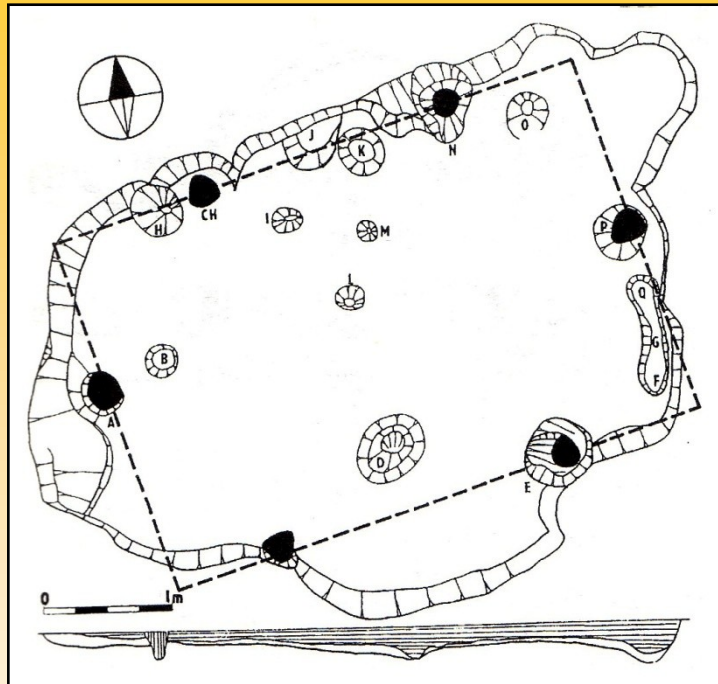

- nížinná neopevňená
- **lokality:** Vyškov, Mlékojedy, Březno, Holubice, Mušov – U sv. Jana

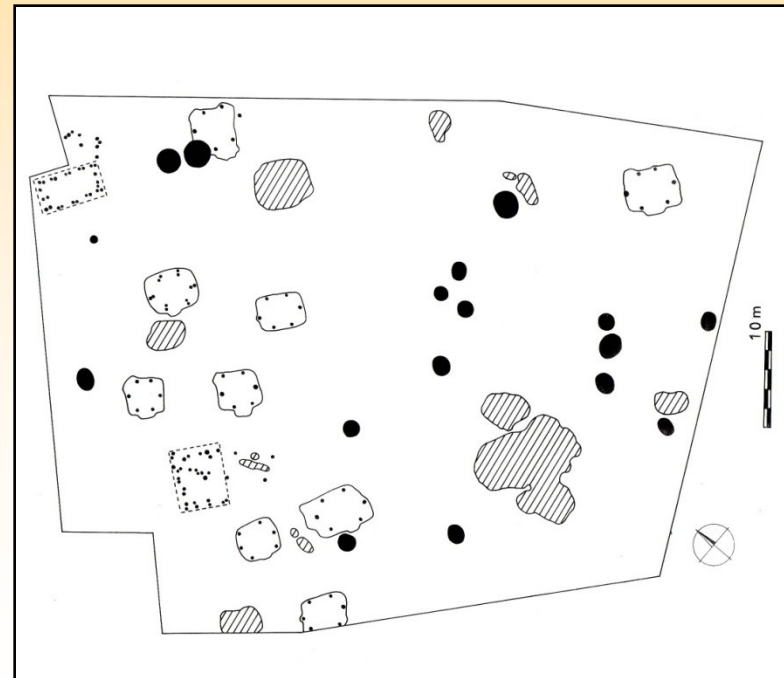

Keramika

- **tvary:** hrnce, misky, teriny (hluboké mísy), lahve, pohárky, cedníky; tyglíky
- přesleny, tkalcovská závaží
- **typy:** plaňanské poháry, jiříkovická (šedá na kruhu)
- v roce robená, točená na kruhu
- hrnčířství
 - **pece** – osamoceně nebo dílna (Jiříkovice, Olomouc-Neředín)

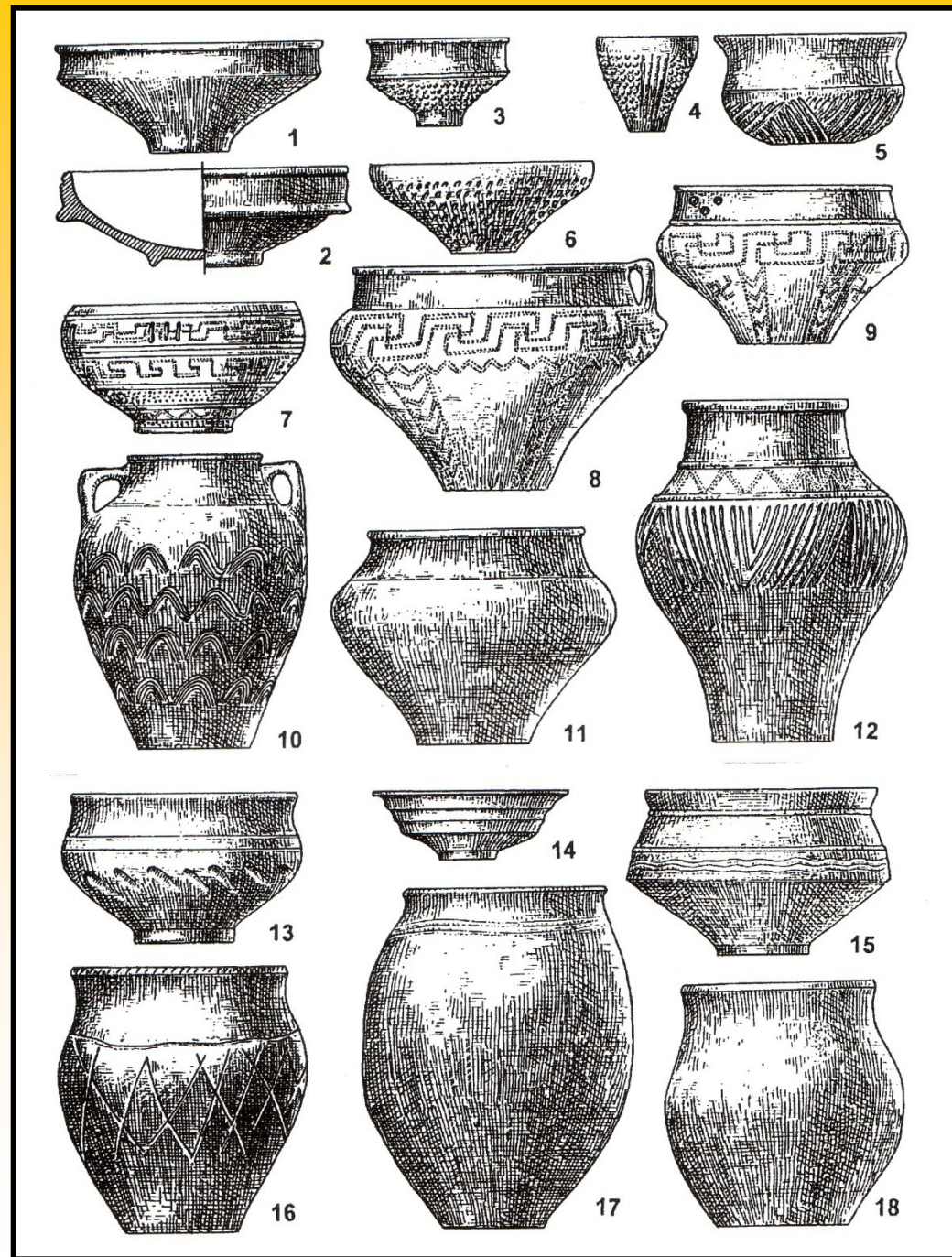
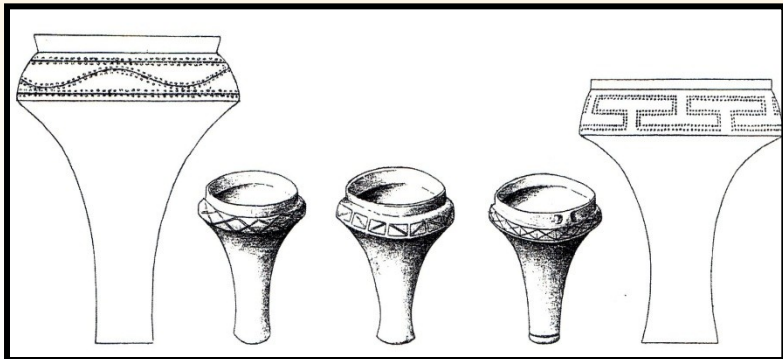

Spony

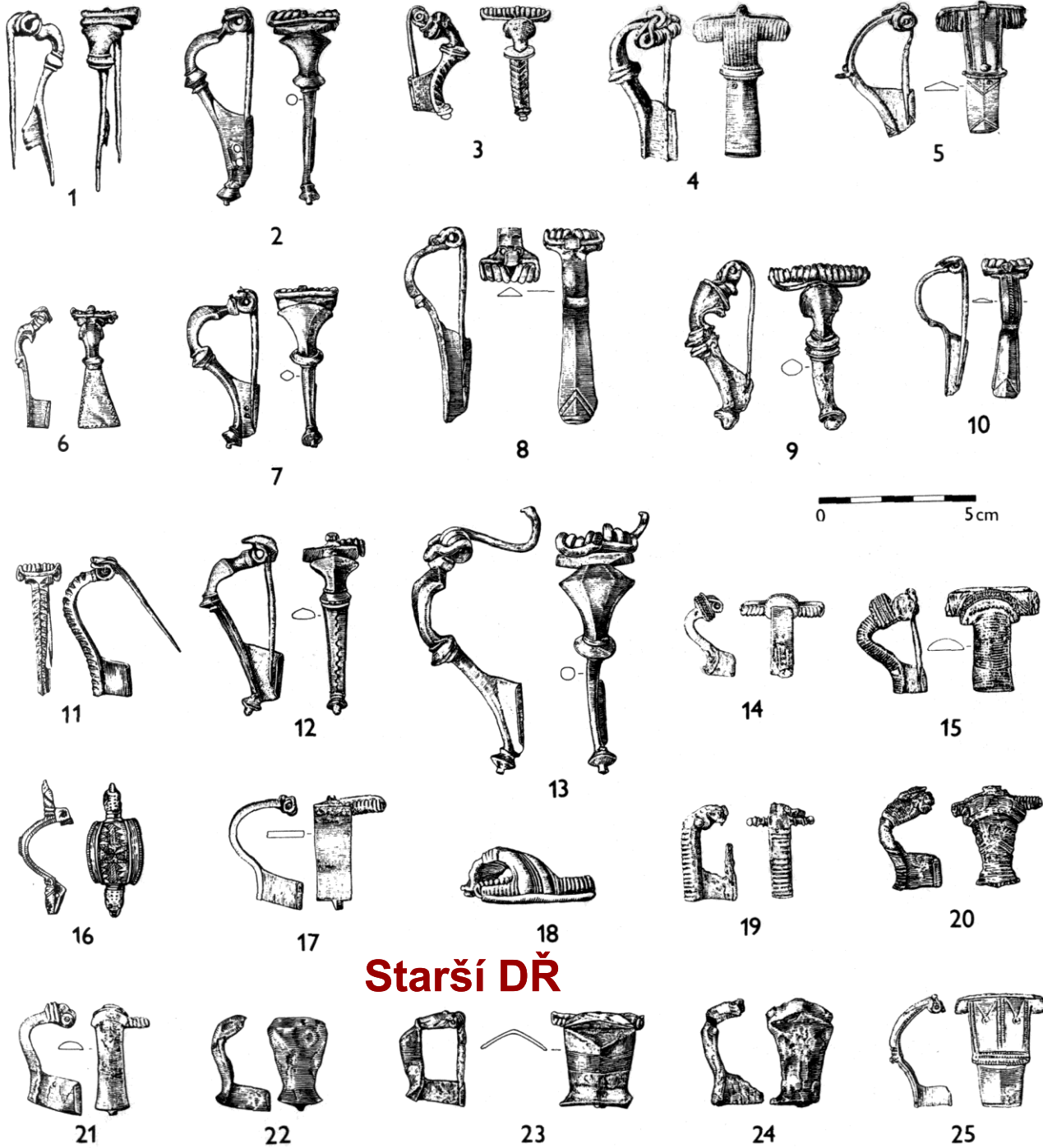

Spony

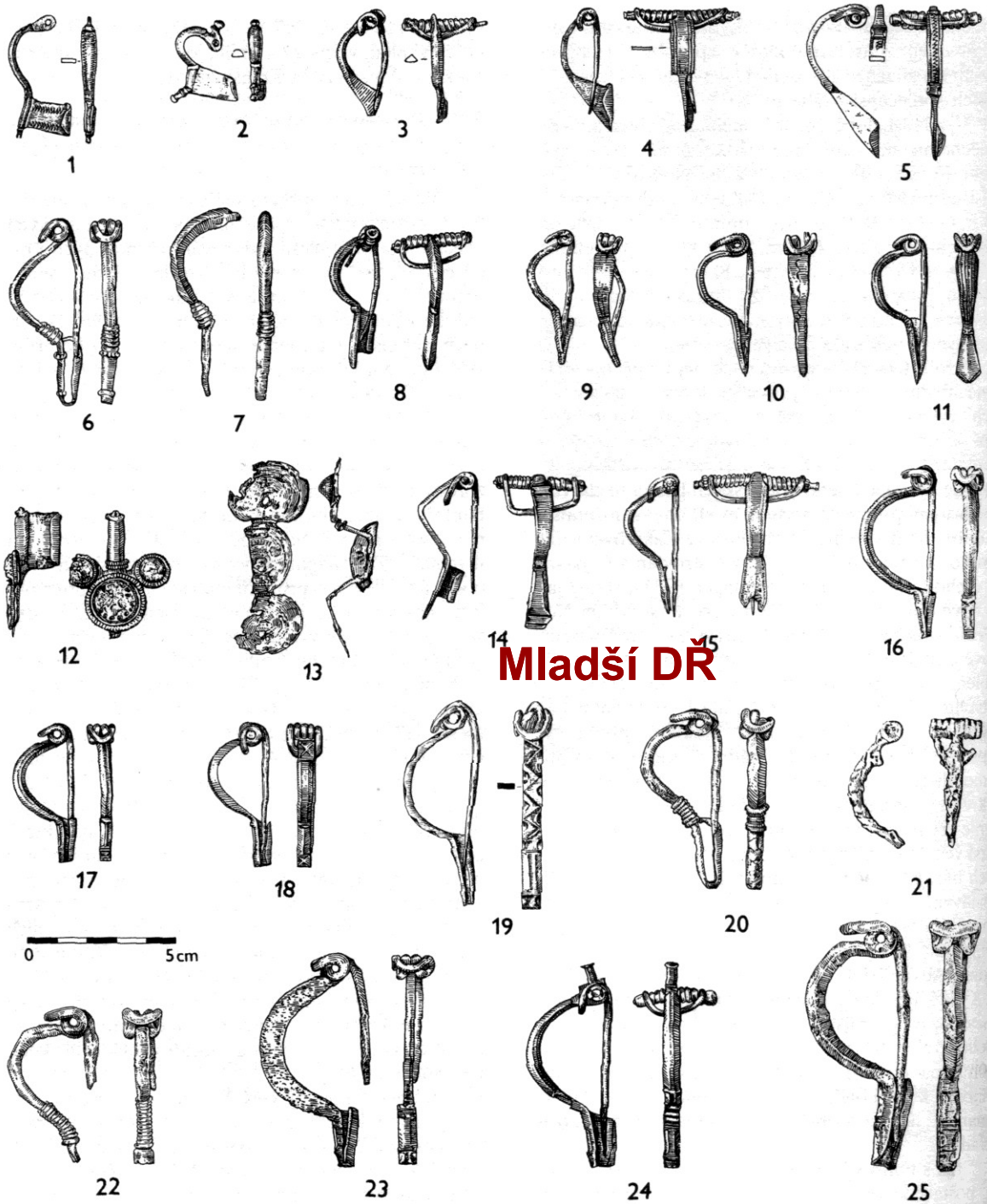
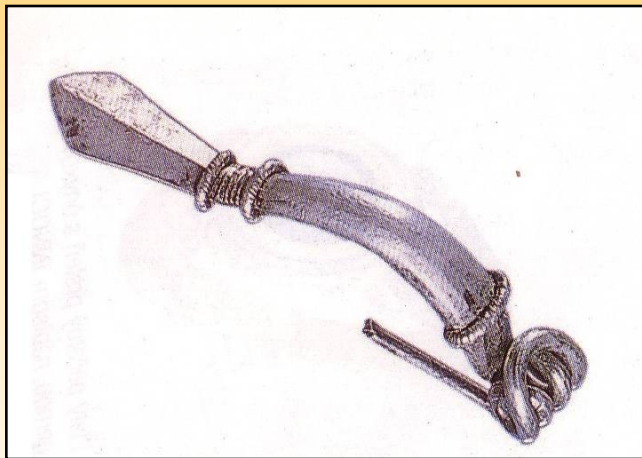

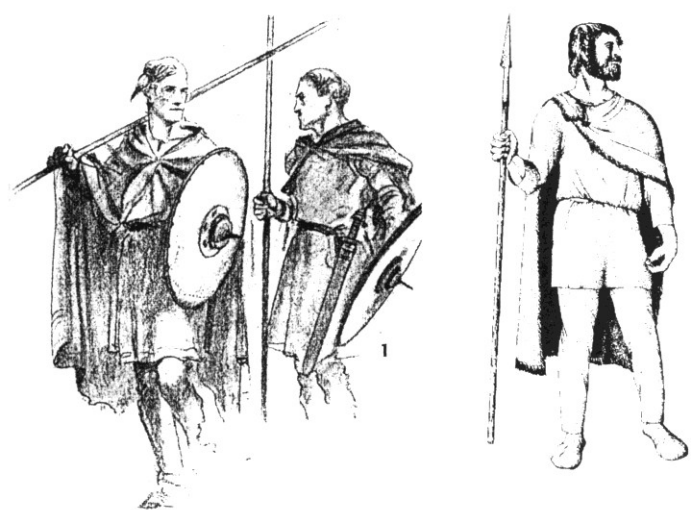

- meč
- kopí
- oštěp
- štít
- luk a šípy
- sekery



výzbroj



Římské „importy“

- **Toreutika** – typologie podle Eggerse
- kotle, vědra, pánve, naběračky, cedníky, konvice, aj.)



Římské „importy“

- **Terra sigillata** (typologie podle Draggendorfa)
 - z dílen ve Westerndorf, Lezoux, Rheinzabern
- **Terra nigra**
- **Provinciální keramika**

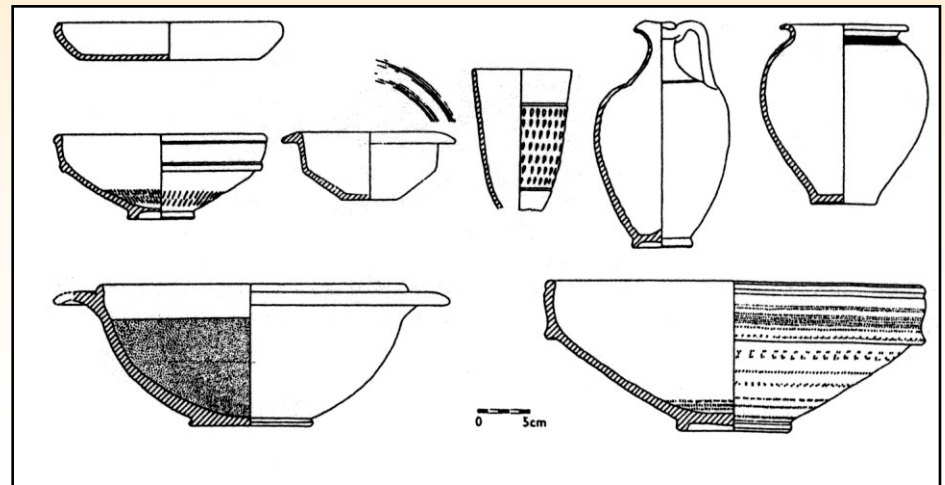
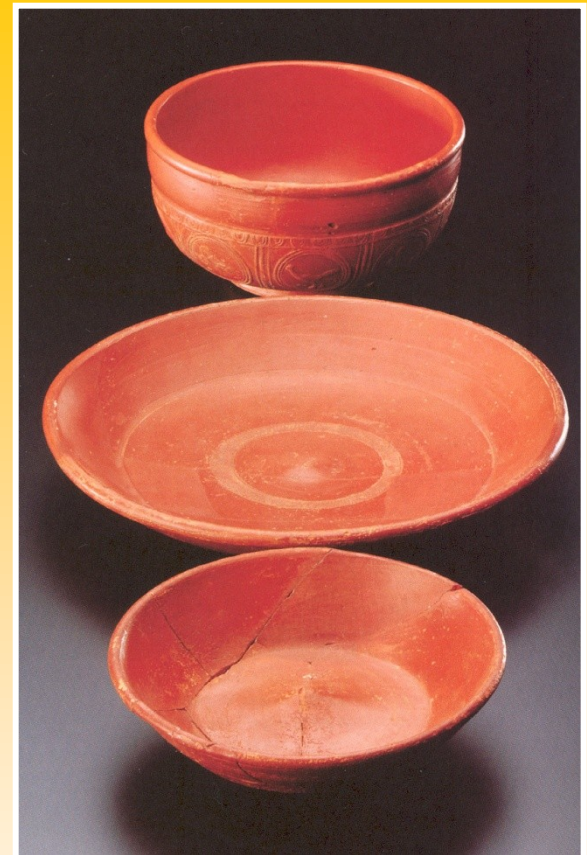

Římské sklo

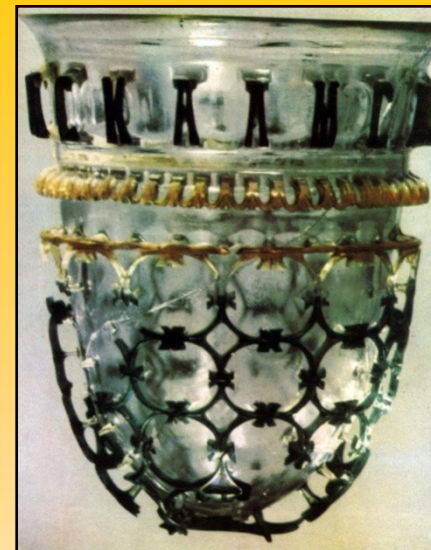
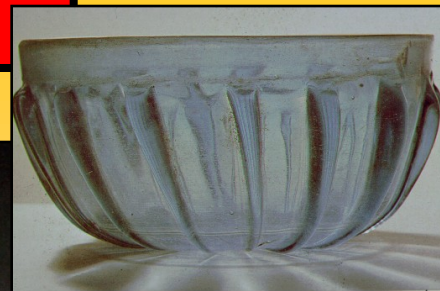

- nádoby
- perly

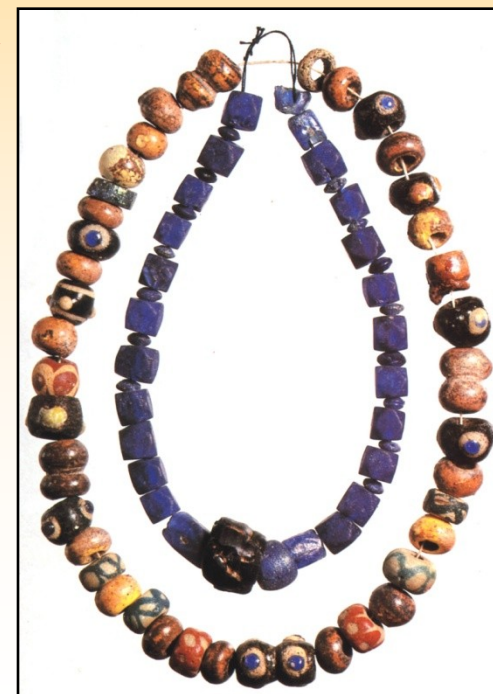

Římské mince

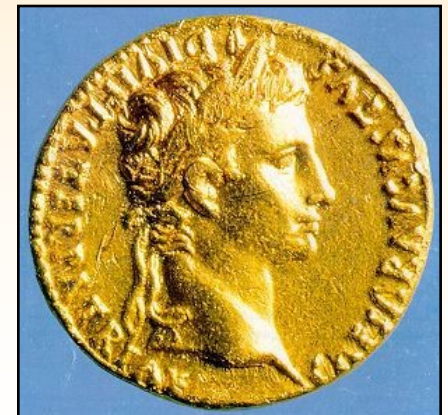



provinciální spony

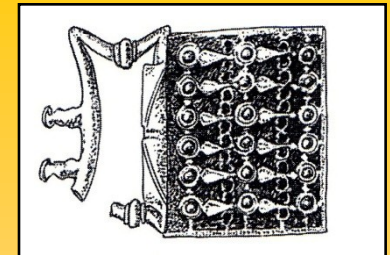
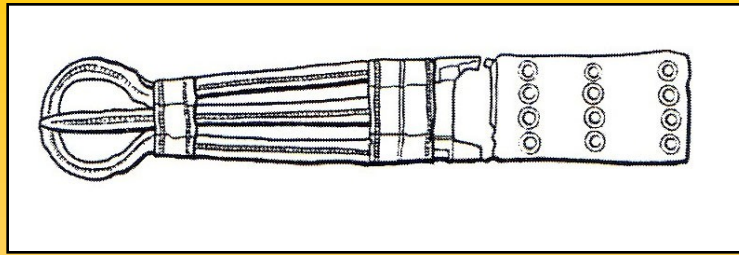

kování opasků

výzbroj

- lorica hamata, squamata (kroužkový a šupinový pancíř)
- meče s kruhovou rukojetí
- štíty – polokulovité štítové puklice

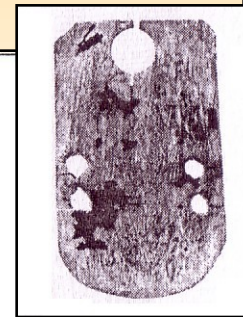
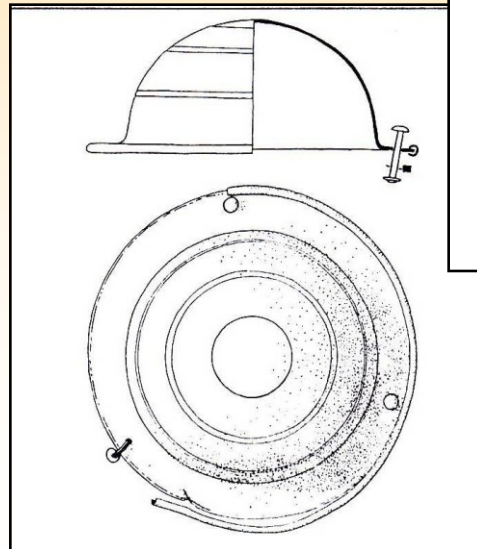
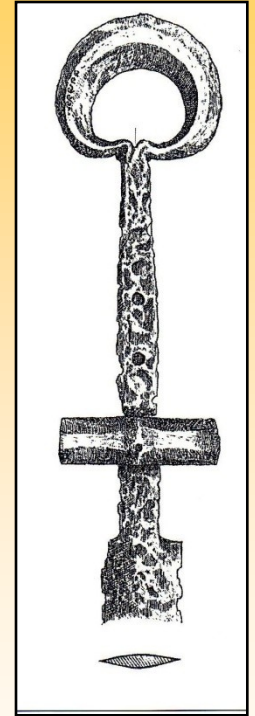
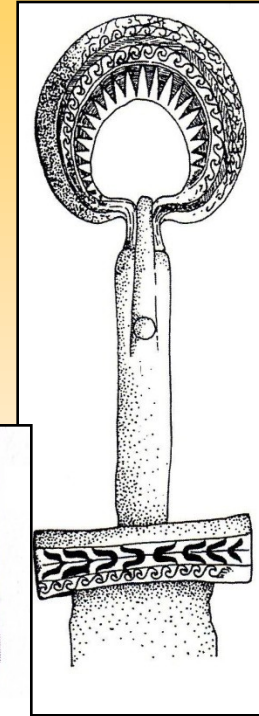

Provincie a LIMES ROMANUS

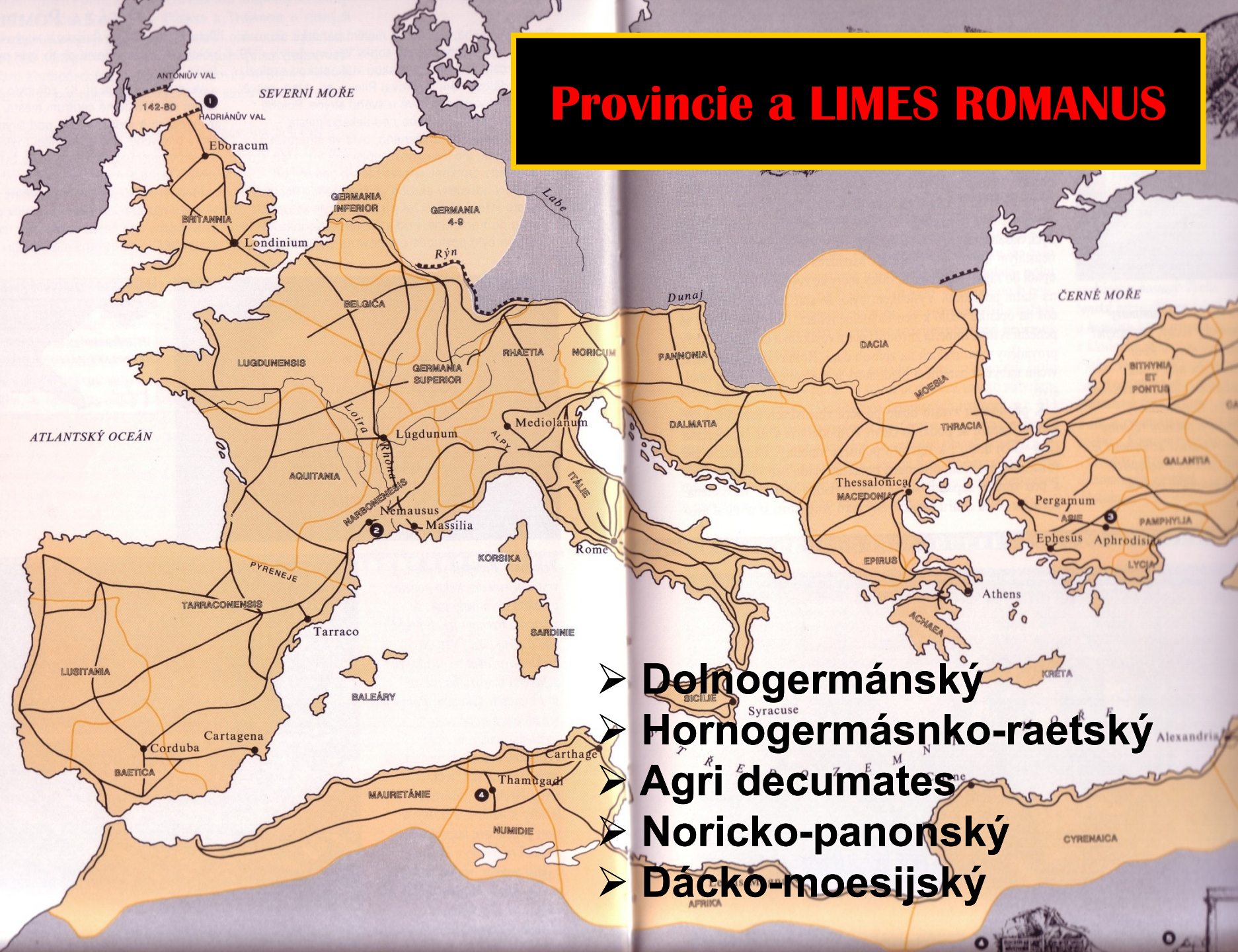

- **Dolnogermský**
- **Hornogermánsko-raetský**
- **Agri decumates**
- **Noricko-panonský**
- **Dácko-moesijský**

Limes romanus a provincie

- přirozená (řeka) nebo uměle vybudovaná hranice ŘŘ (Flaviovcí, Trajan, Hadrian; po roce 9 ustálení hranice na Rýně a Dunaji)
 - **umělá**: val, příkop, nebo i palisáda a zeď

- **castrum (legionářský tábor)**
- **castel (auxiliární tábor)**
- **burgus**
- **v blízkosti civilní stavby (canabae; civilní města – municipium)**



Legie a auxilie

- **Legie** (10 kohort, 30 manipulů, 60 centurií)
 - 6000 vojáků a 120 jezdců (equites)
 - zbraně a služby (technické oddíly: tesaři, kováři, zbrojíři)
 - pěchota – těžká, lehká
- pomocné sbory: **auxilie** (500 – 1000 mužů; ala – jízdní oddíl; turmae - čety)

noricko-panonský limit

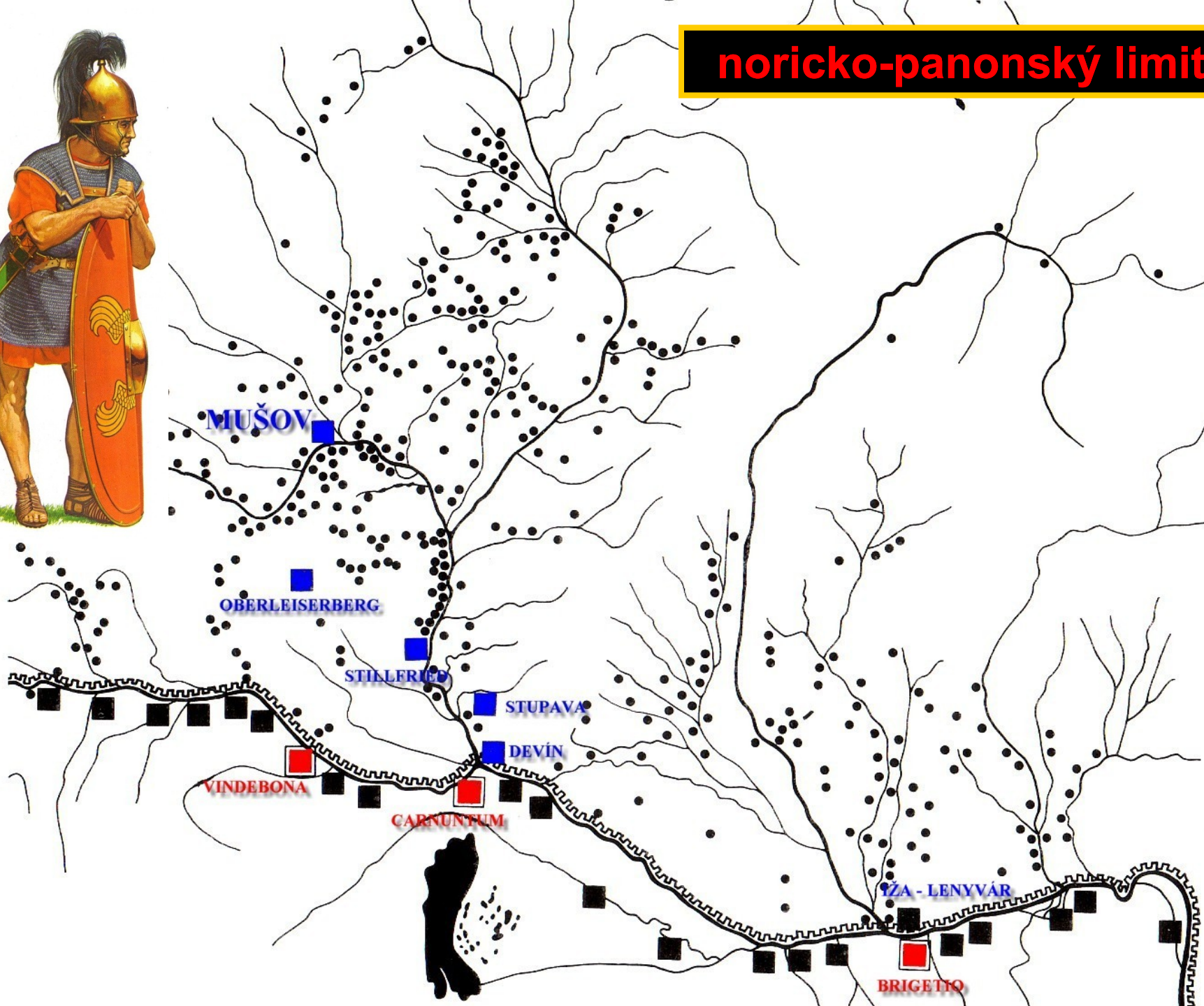

- půdorys castelu pomocné jednotky v Künzingu (Qintana)

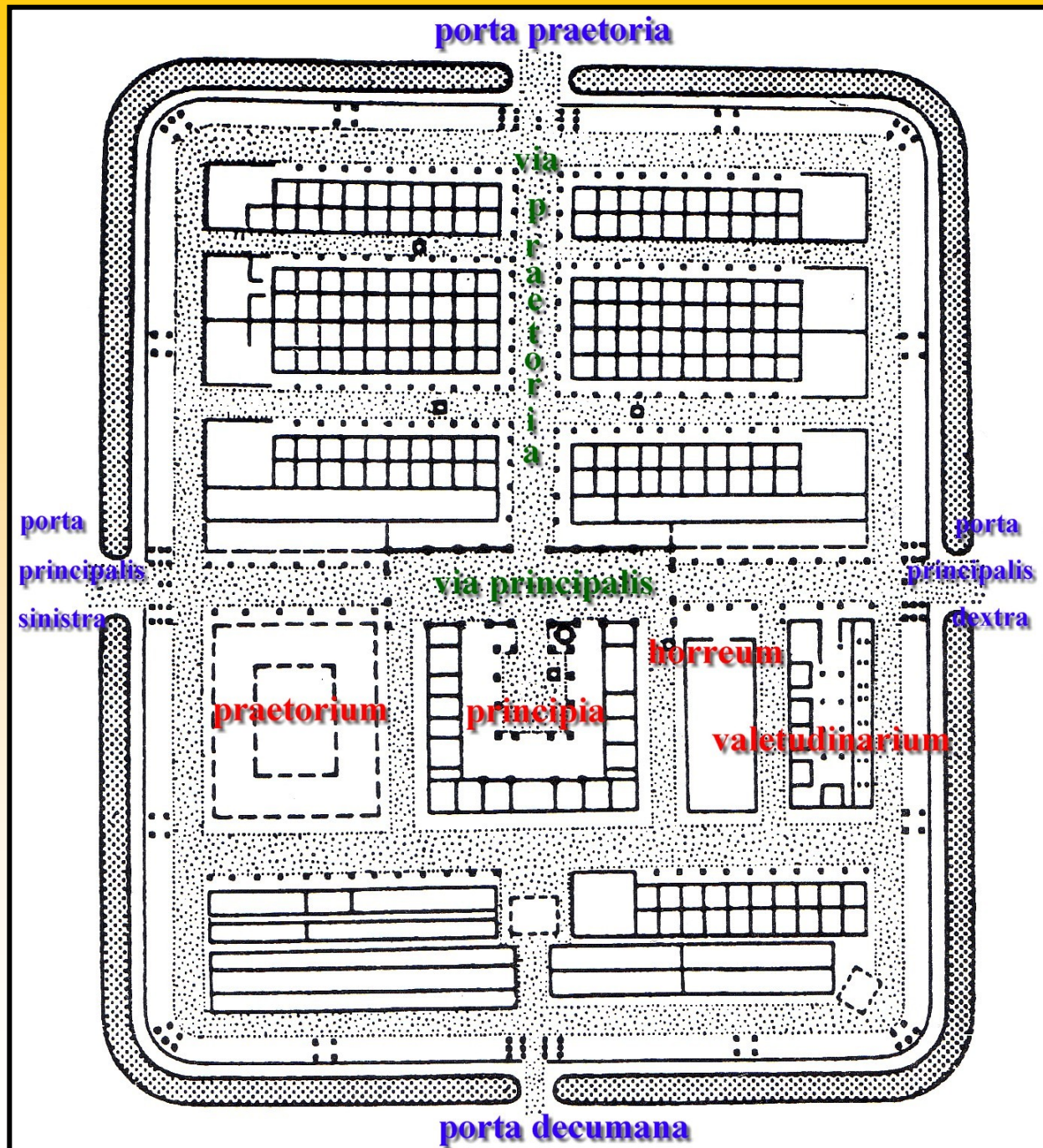

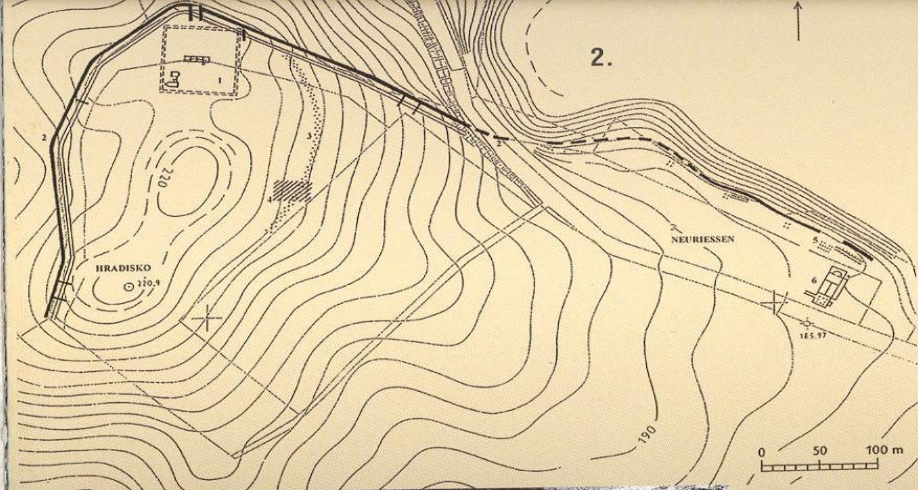

Mušov

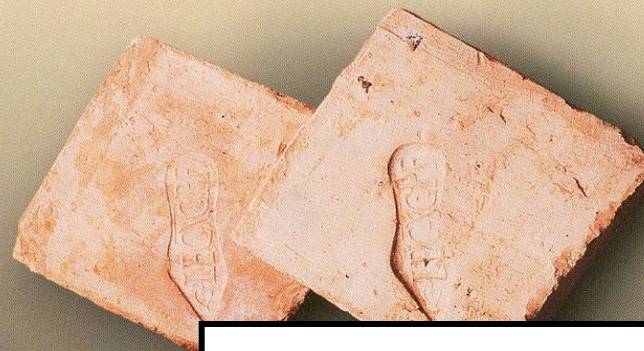
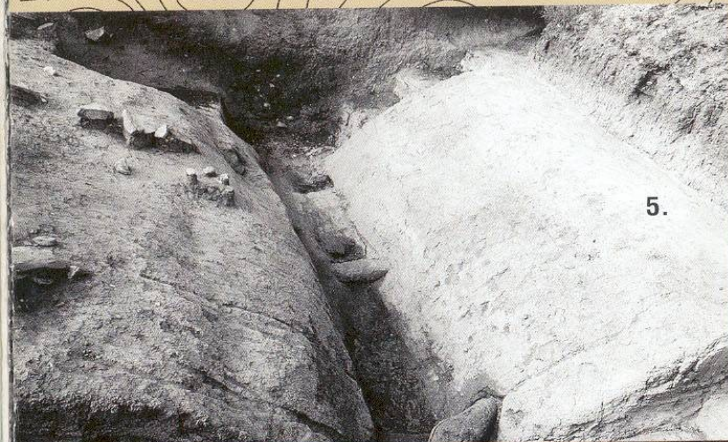

- **Burgstall (80 km od Vindebony) – vojenské využití**
 - cihly s kolcem X. Gemina Pia Fidelis a XIII. Legie
 - praetoria, balneum (podpodlažní topení – hypocaustum)
 - fabrica (dílny)
- **Neuriessen (min. 5 pochodových táborů), řím. stavba**



6.

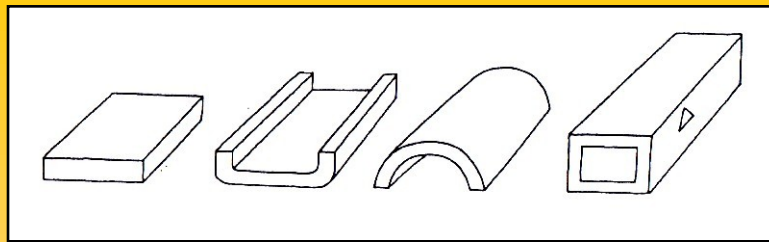

lateres imbrex

tegulae tubuli

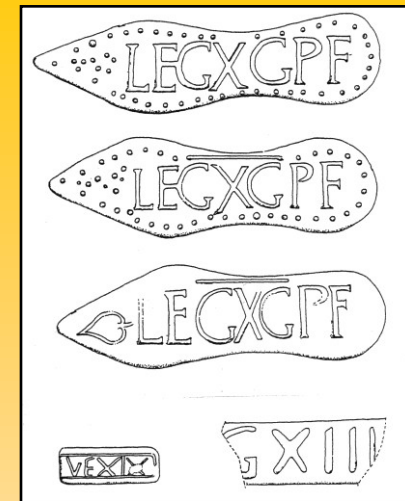

hypocaustum

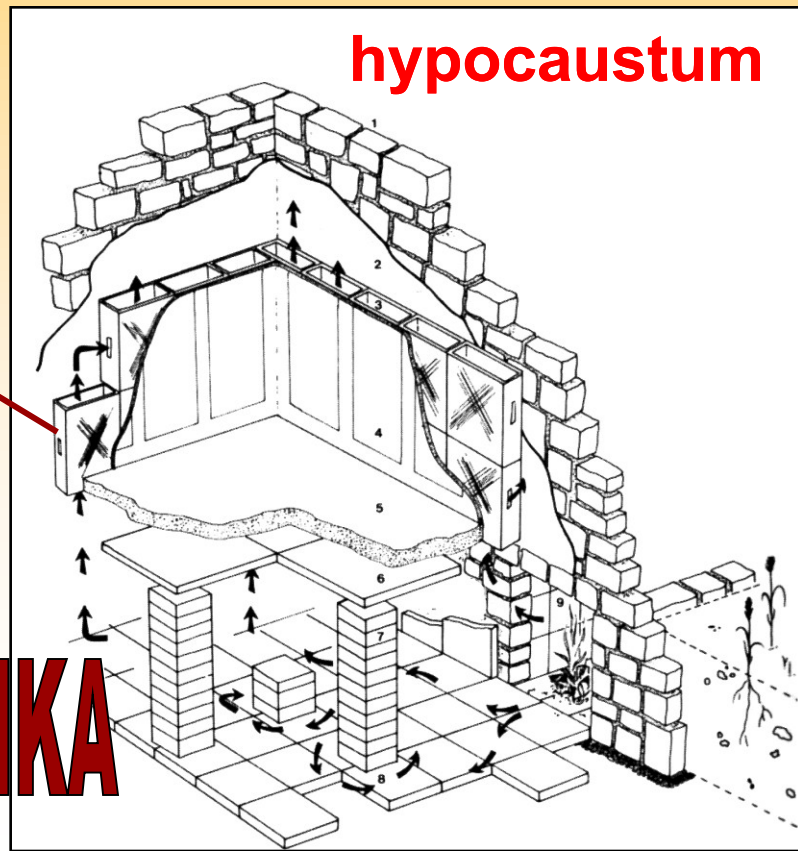

STAVEBNÍ KERAMIKA

pochodové tábory

Mušov, Brno-Modřice,
Olomouc-Neředín, Ivaň,
Přibice

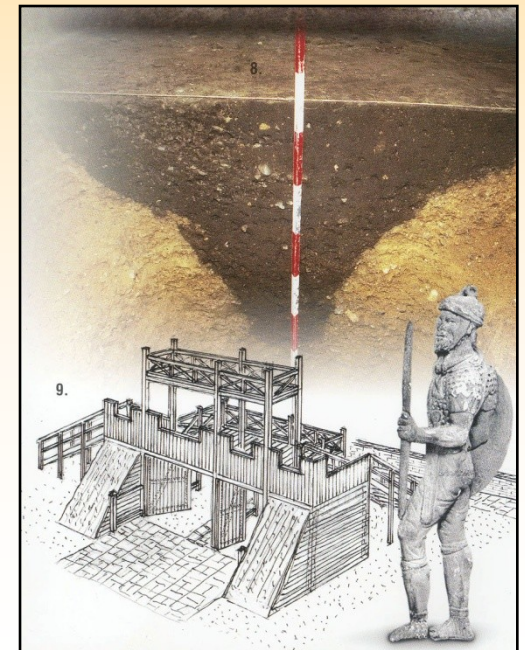

ŘÍMSKÉ VOJSKO - LEGIE

- lorica hamata (kroužkové)
- lorica squamata (šupinové)
- lorica segmentata (lamelové)

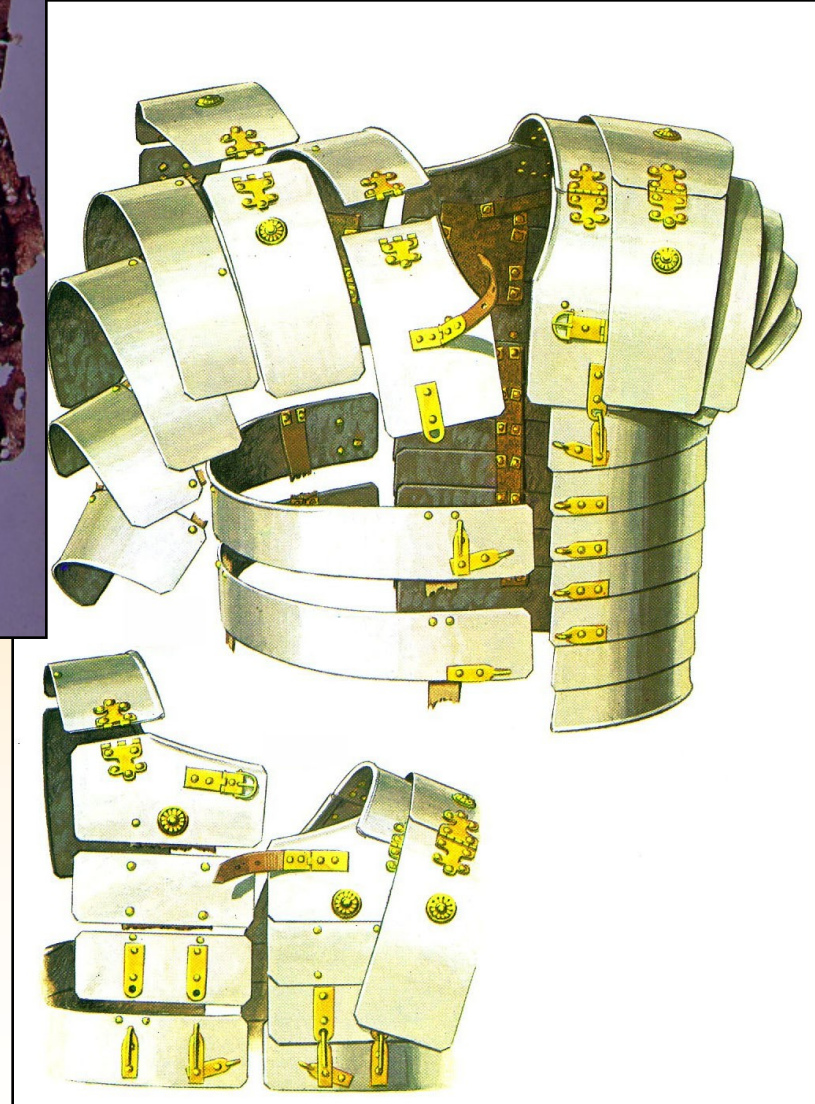
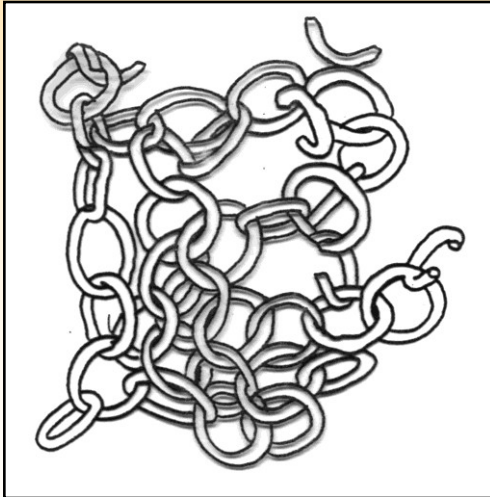



maskovité jezdecké

PŘILBY

přilby pěchoty

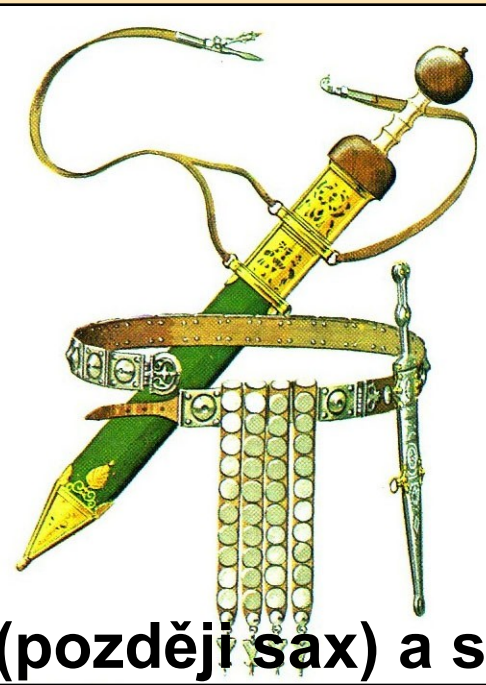
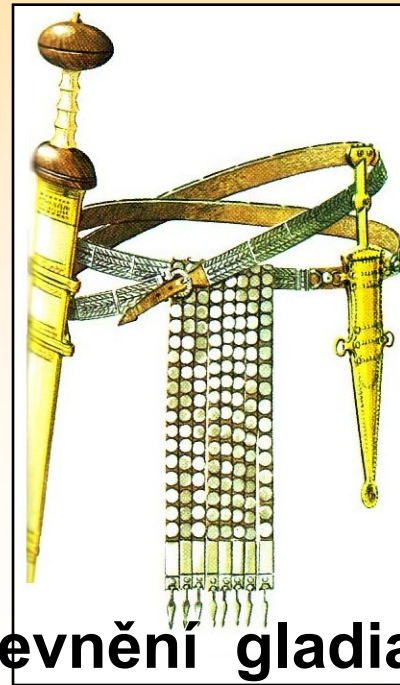

cingulum a upevnění gladia (později sax) a spathy (meče)



pilum



kopí



pugio (dýka)

PROVINCIÁLNI SPONY

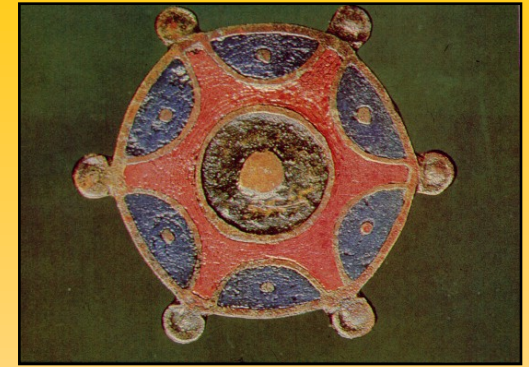

- Aucissa (1)
- emailové (2)
- kolínkovité (3)



Periodizace DSN

Časná doba stěhování národů D
(380/400-480/490)

Pozdní doba stěhování národů E
(480/490-560/580?)



Podrobná periodizace DSN (zvýrazněny důležité termíny)

| Morava (J. Tejral) | | | Čechy (E. Drobejar) | | |
|--------------------|------------------|-----------------------------------|---------------------|------------------|--|
| D1 | 380/400-410/420 | Přechodný stupeň | D1 | 380/400-410/420 | Přechodný stupeň |
| D2 | 410/420-440/450 | Částečně tzv. Attilův horizont | D2 | 410/420-440/450 | Starší stupeň vinařické skupiny |
| D2/D3 | 430/440-470/480 | Přechodný stupeň, hrob Smolín | | | |
| D3 | 450-480/490 | | D3 | 440/450-480/490 | Mladší stupeň vinařické skupiny |
| D3/E | 470-500/510 | Časně merovejský přechodný stupeň | | | |
| E | 500/510- cca 568 | Langobardi | E | 480/490-560/580? | Časný stupeň merovejské kultury |

Hlavní rysy DSN

- Pohřebiště (žárová přechází do kostrových) + bohaté hroby (Smolín, Blučina, Žuráň)
- 3 oblasti vývoje na našem území
 - střední a SZ Čechy - **Vinařická skupina** (Praha-Zličín, Praha – Bubeneč/Podbaba)
 - J a Z – Čechy – skupina **Přešťovice – Friedenhain** (Přešťovice) (jen D1-D2)
 - Morava – působení hunského kmenového svazu (D2)
- přelom 5./6. století – příchod Langobardů

Pohřební rítus

PR

- kostrový
 - zbytky rakví
 - s kruhovými příkopy
 - bohaté hrobky
- výbava:
 - spony: stříbrné (gótské) (zlačené) plechové spony velkých rozměrů
 - ozdoby s polyedrickými korály
 - na Slovensku - cikádovité spony

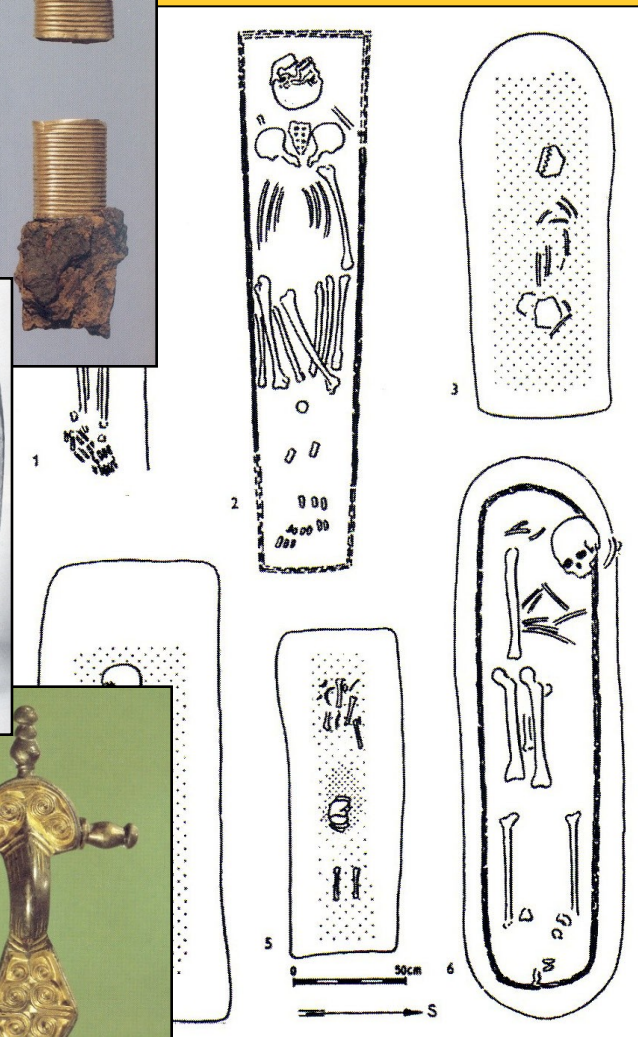
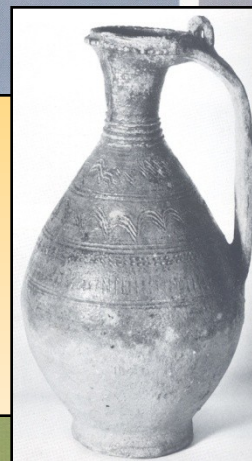

Sídliště

- zlechovský typ – jednodušší hrubší keramika
 - chaty se 6 kůly
 - chaty bez kůlů, aj.
- sídliště – Březno u Loun, Velké Němčice
- výšinná sídliště (Znojmo, Líšeň) – asi bez opevnění

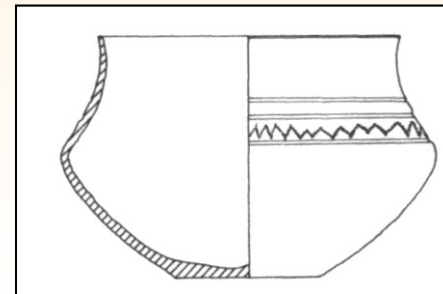
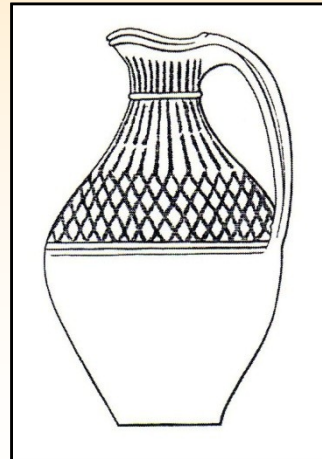
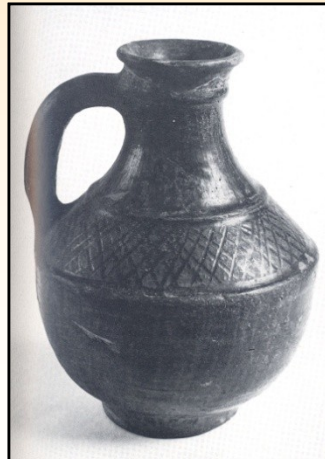
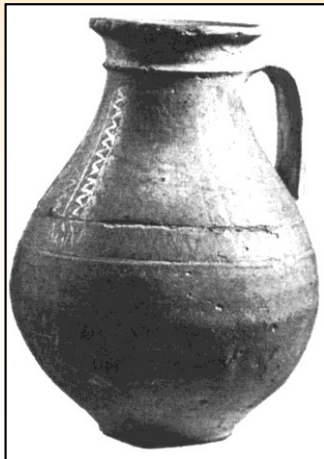
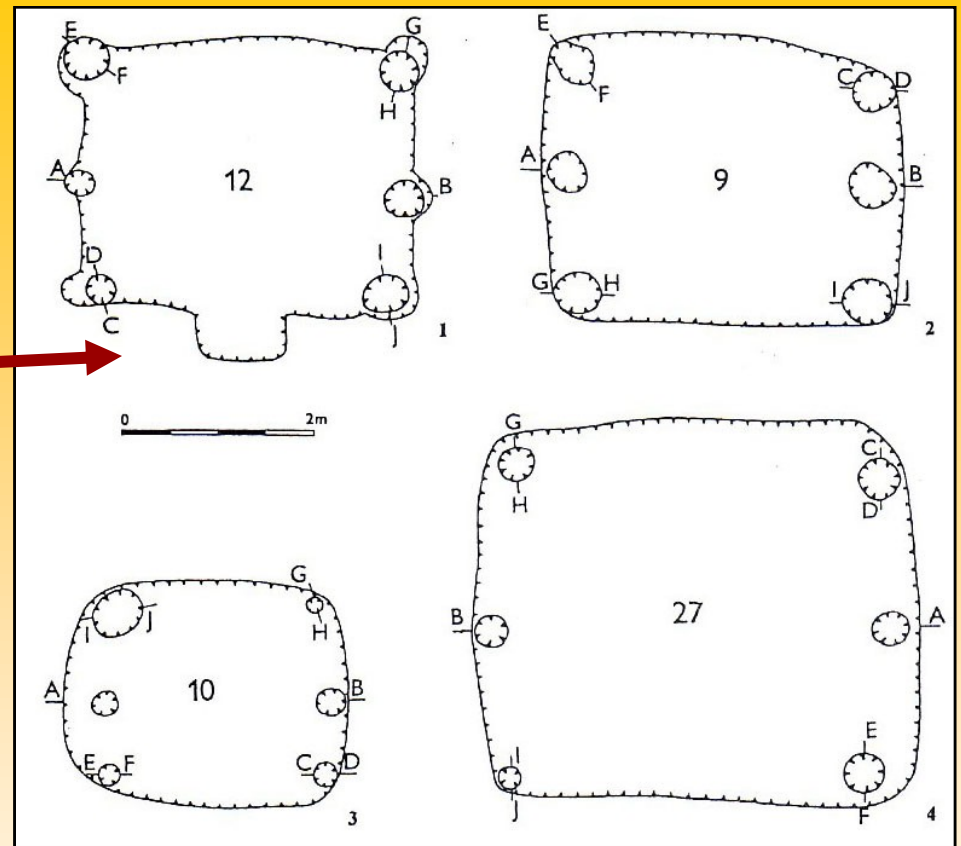

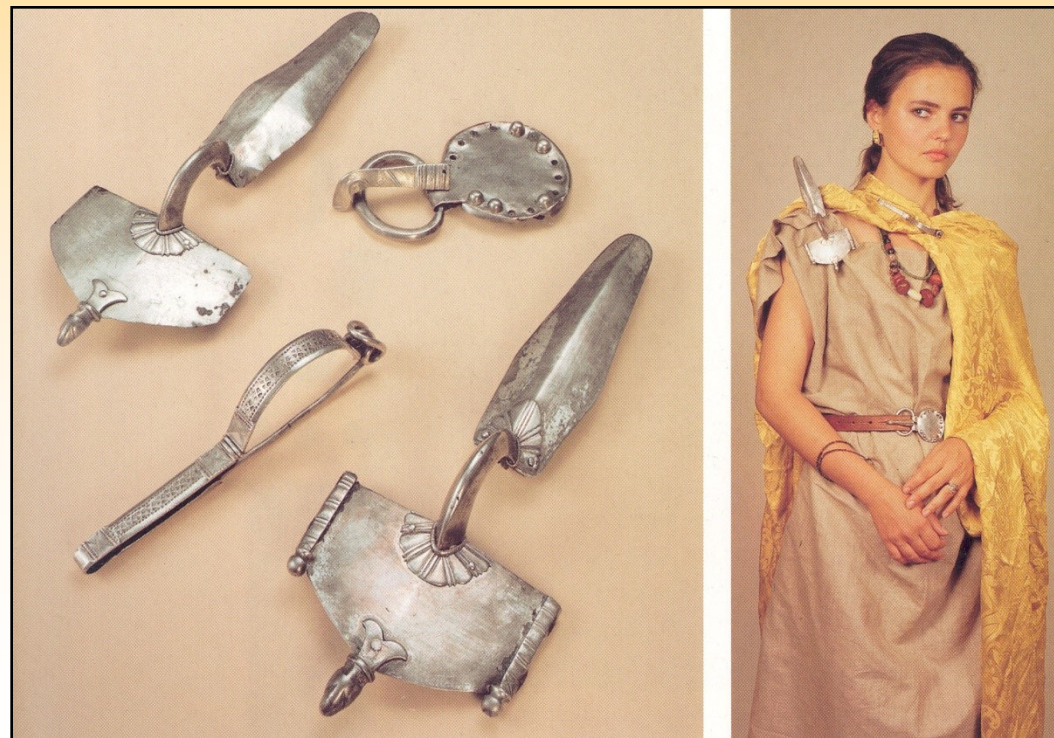
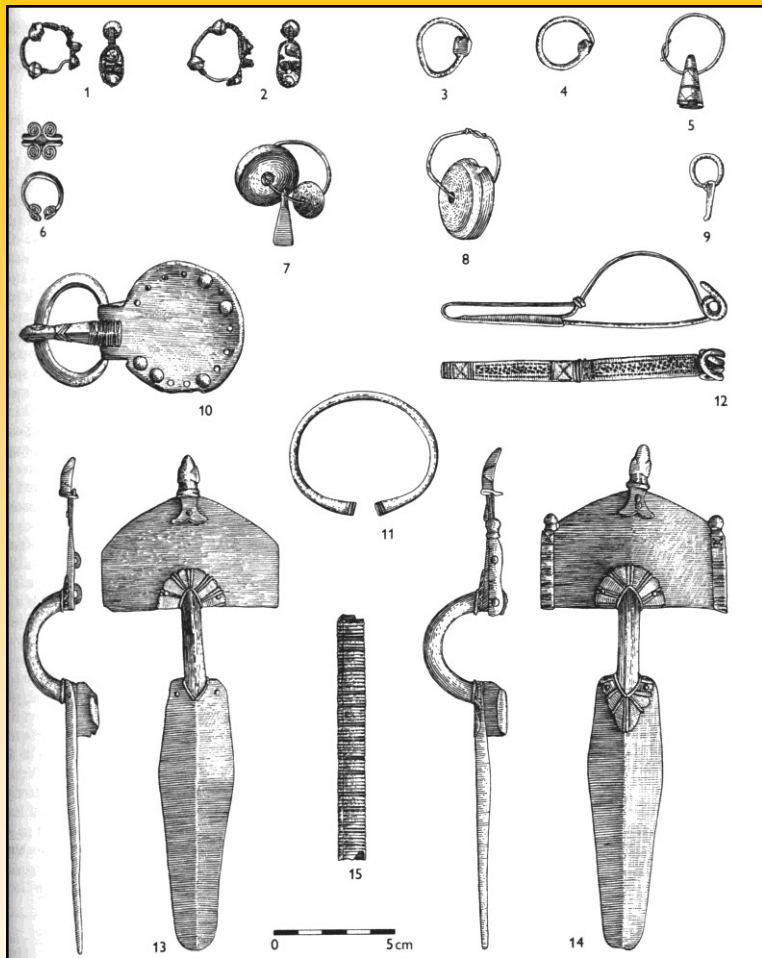

Smolín

Horizont Smolín

Hunové

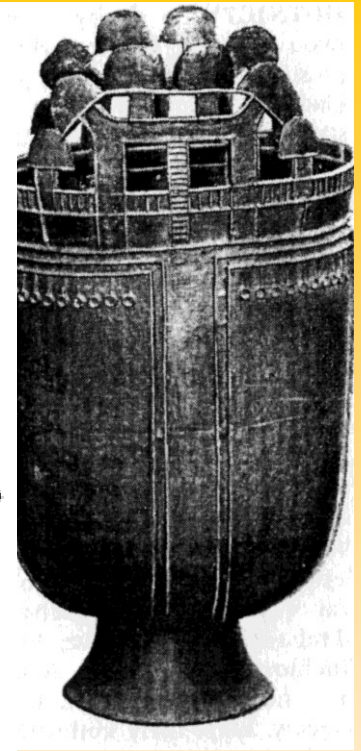
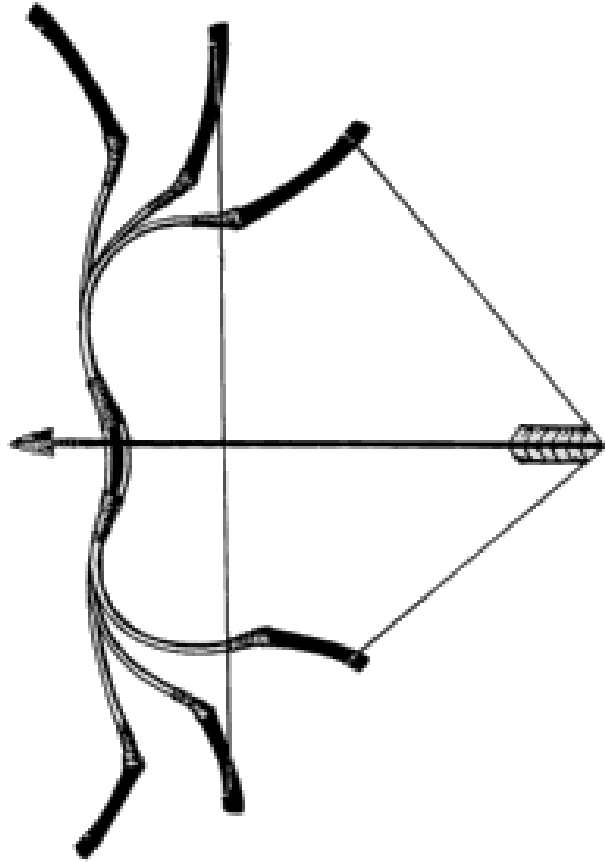

Dějiny Hunů

- Otázkou je jejich podíl na říši Žuan-žuan v 3.-4. st. n. l.
- 375 napadli říši Ostrogótů u Černého moře a vtrhli do Evropy
- K jejich kmenovému svazu se přidalo i mnoho jiných kmenů, hlavně Germáni (Ostrogóti, Gepidové, Alani, Rugiové,..)
- 434 sjednoceni pod nadvládou krále Attily, který vytváří kmenový svaz s centrem v Karpatské kotlině
- 451 Attila poražen Římany a jejich spojenci vedenými vojevůdcem Aetiem (Katalaunská pole)
- 453 Attila otráven na své svatbě
- 454 Attilovi synové poraženi germánskými kmeny (bitva na Nedau) a Hunové se stahují na východ

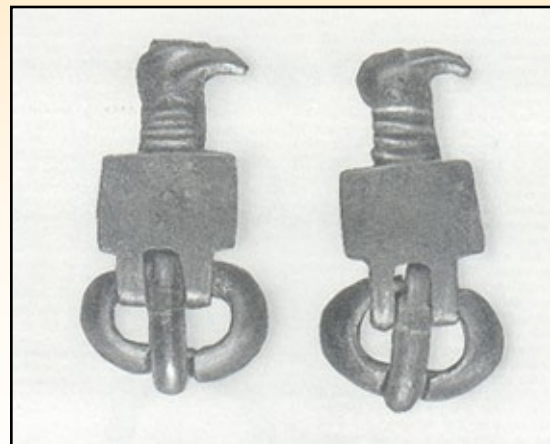
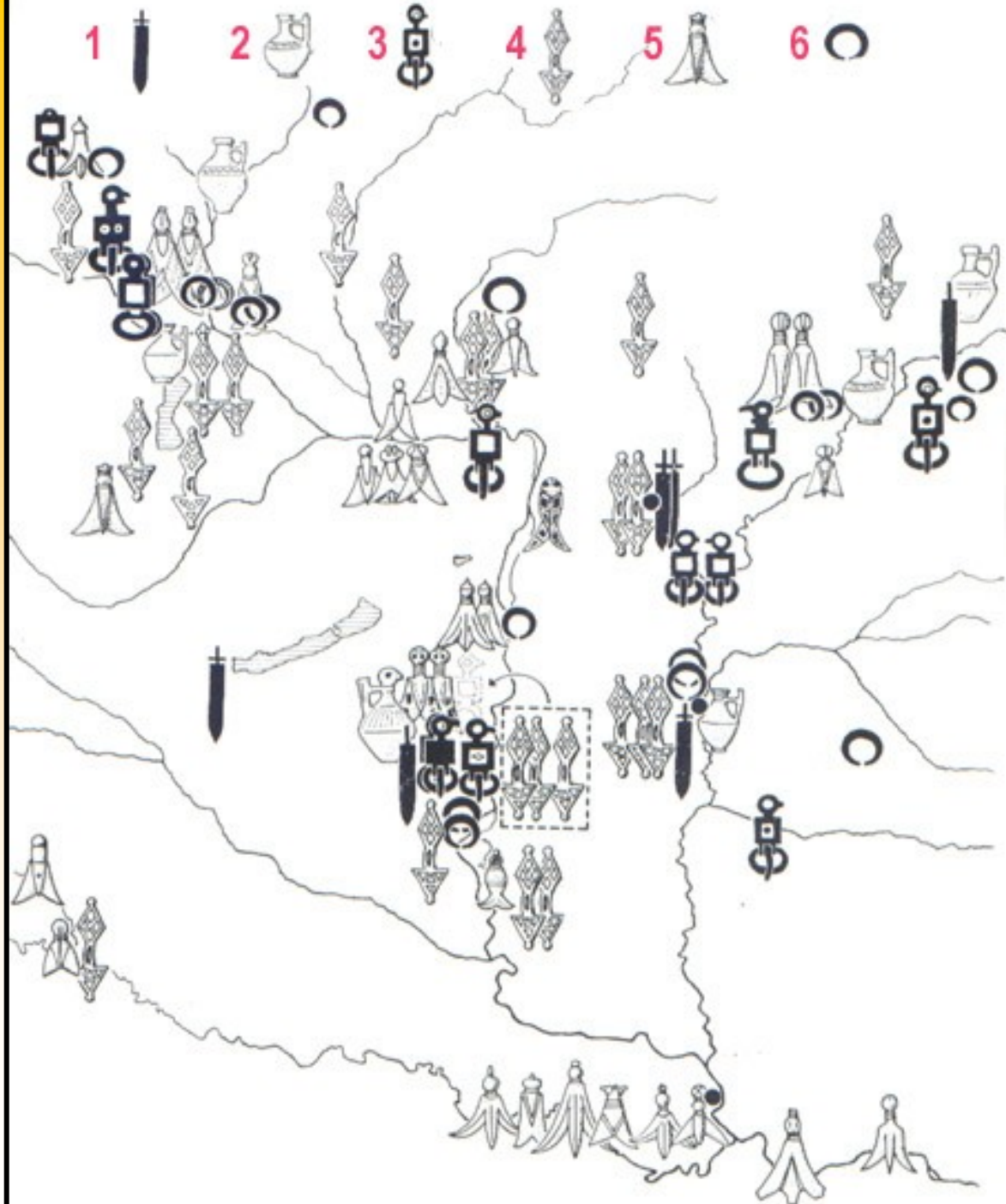

Blučina

- složka:
 - domácí
 - stepní
 - římská

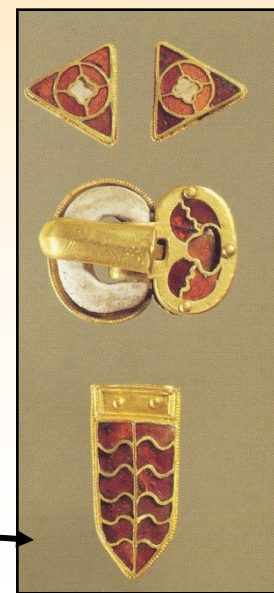
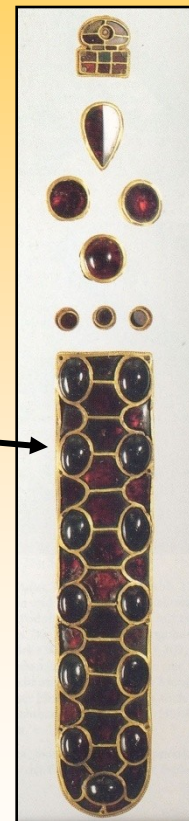
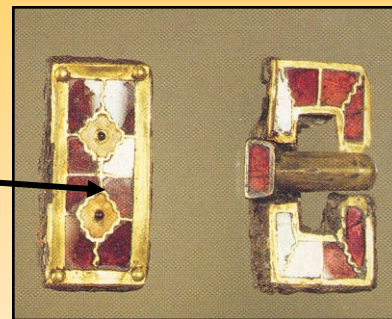
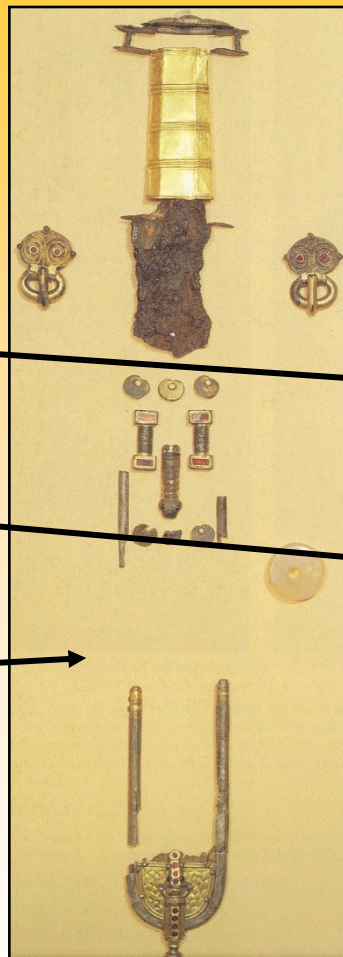
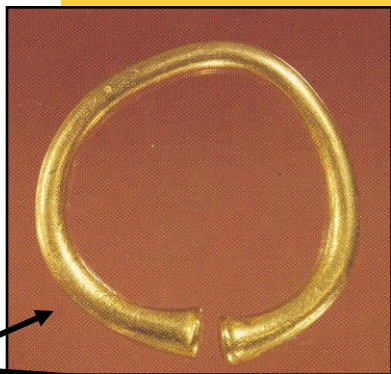
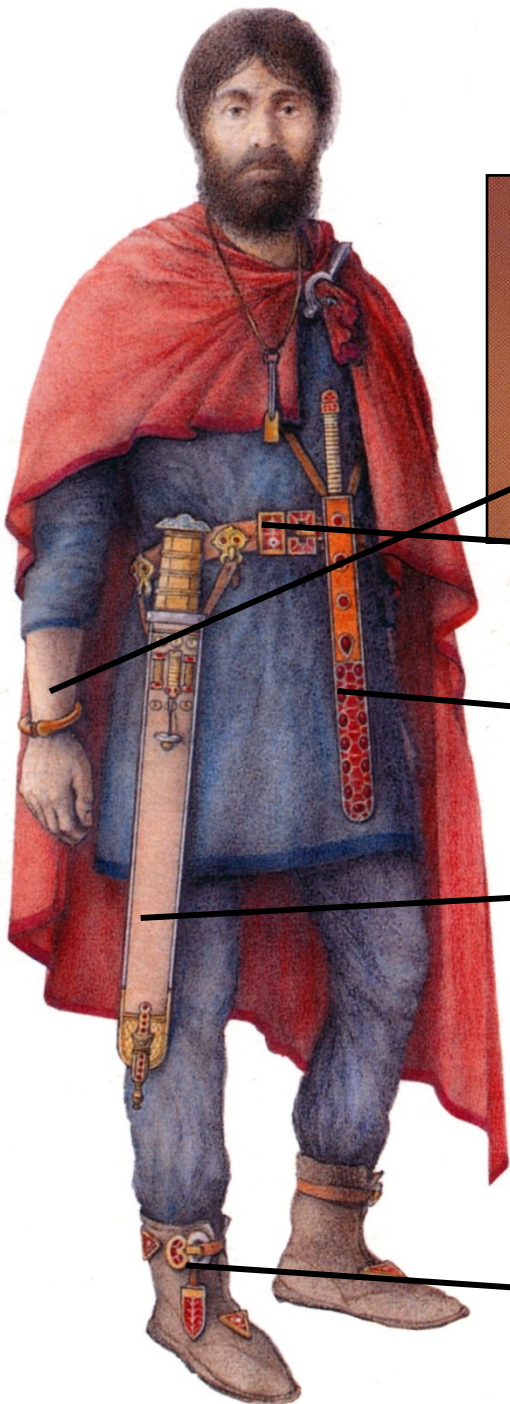

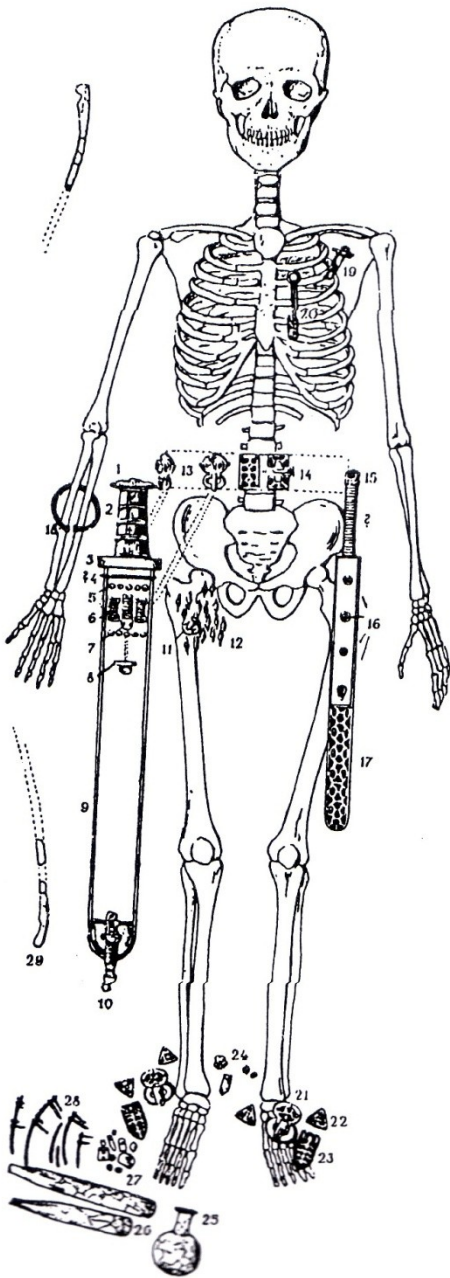

- orientace V-Z
- muž 35-40 let
- výbava
 - zbraně (spatha, sax, 15 železných hrotů šípů, kostěné obložení reflexního luku)
 - kování jezdeckého bičíku, kování sedla
 - náramek (zlatý)
 - stříbrná samostřílová spona s cibulovitými knoflíky
 - kostěný hřeben
 - 3 skleněné nádoby
- datace: 450 – 480
- etnicita: snad Herul

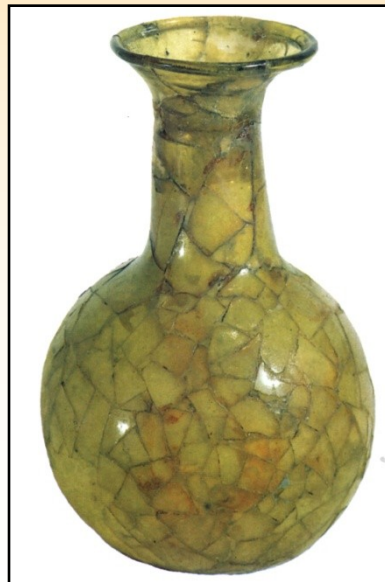

LANGOBARDI

- polabští Germáni
- v první polovině 5.st posun podél toku Labe na J
- spony: 3 časové horizonty
- kostrová pohřebiště (Šaratice, Šakvice)

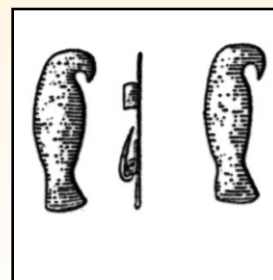

Dějiny Langobardů

- v 2. polovině 5. století táhnou z dolního Polabí k jihu, procházejí Čechami k Dunaji
- 488 doloženi u Dunaje v Rugilandu (Waldwiertel) pod panstvím Herulů, vládl jim král Klačo
- Král Tato porazil 508 Heruly a založil říši Langobardů ve středním Podunají
- Král Wacho říši rozšiřoval, snad pohřben na Žuráni
- Král Alduin přesunul Langobardy do Karpatské kotliny (zisk Pannonie 546), kde bojoval s Gepidy
- Král Alboin pozval na pomoc Avary, s jejichž pomocí sice Gepidy porazil, ale 568 odcházejí Langobardi do Itálie



tkací mečik

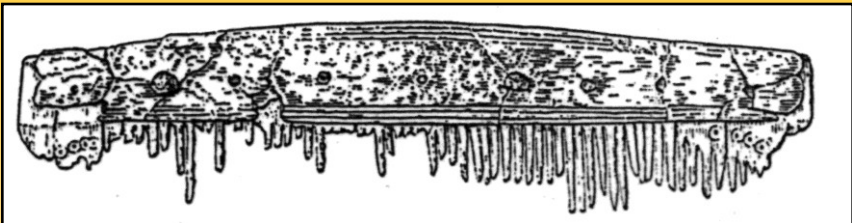

hřeben

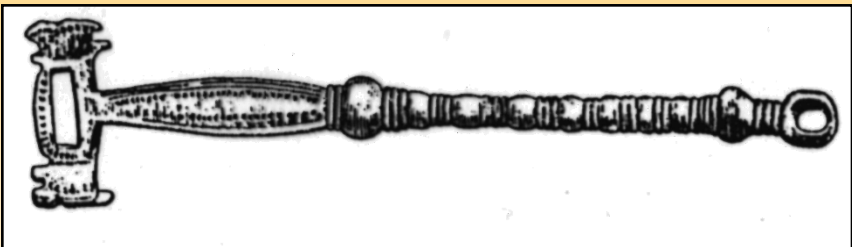

klíč

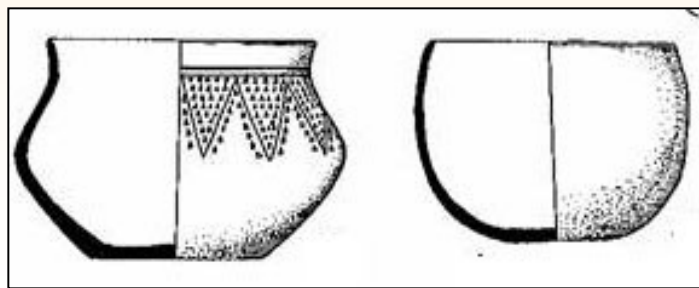
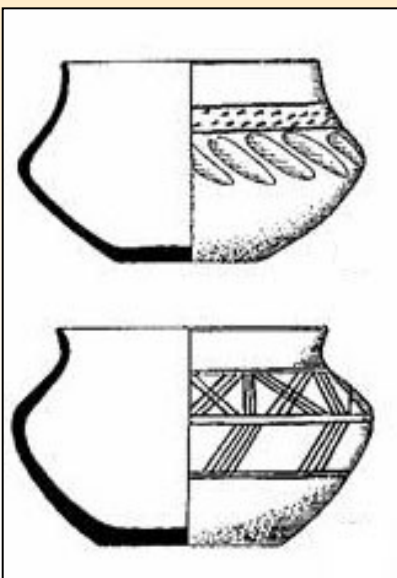

Ženské hroby



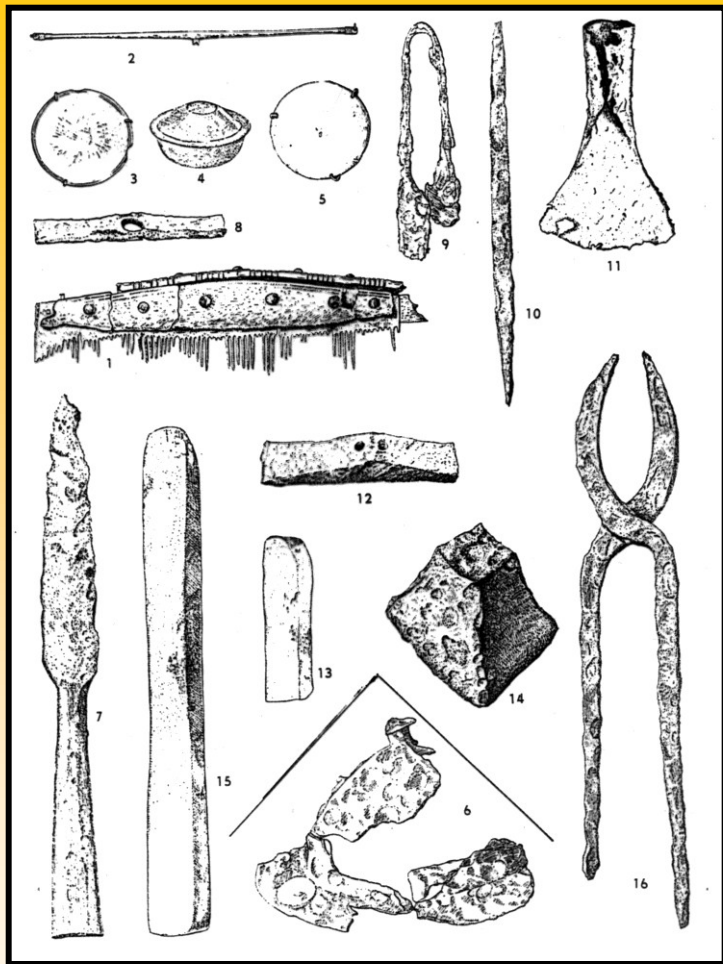

BRNO - KOTLÁŘSKÁ

Mužské hroby

MILITÁRIA

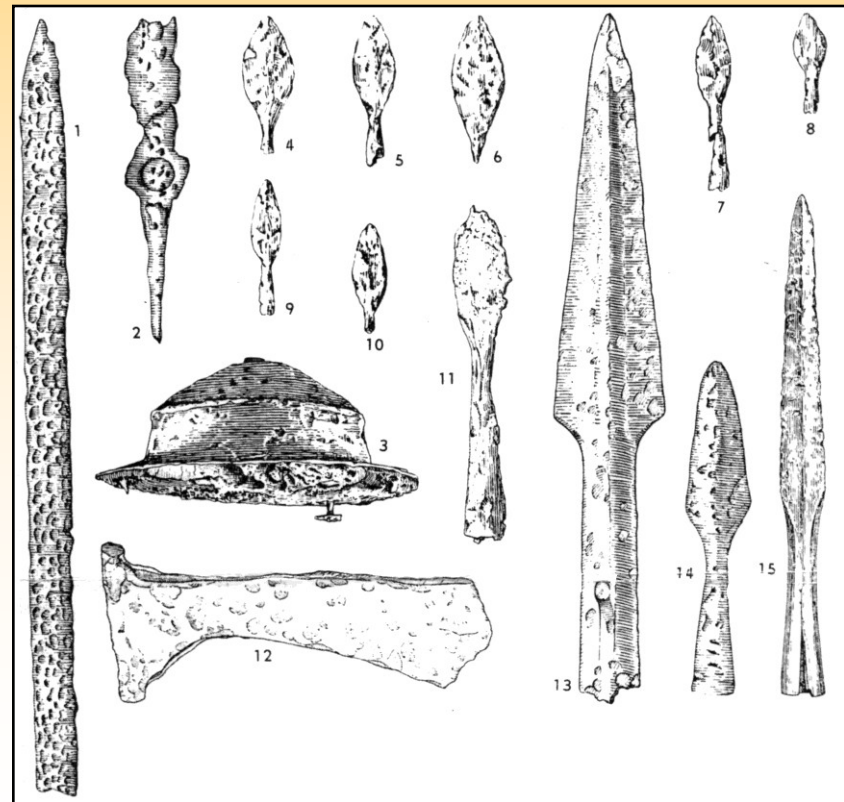
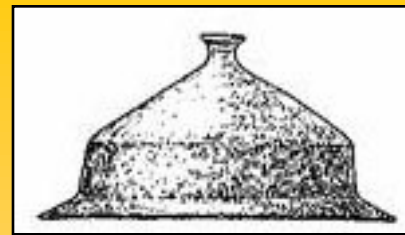

Mohyla Žuráň



pyxida



**pletencem zdobený trám z
konstrukce pohřební komory**

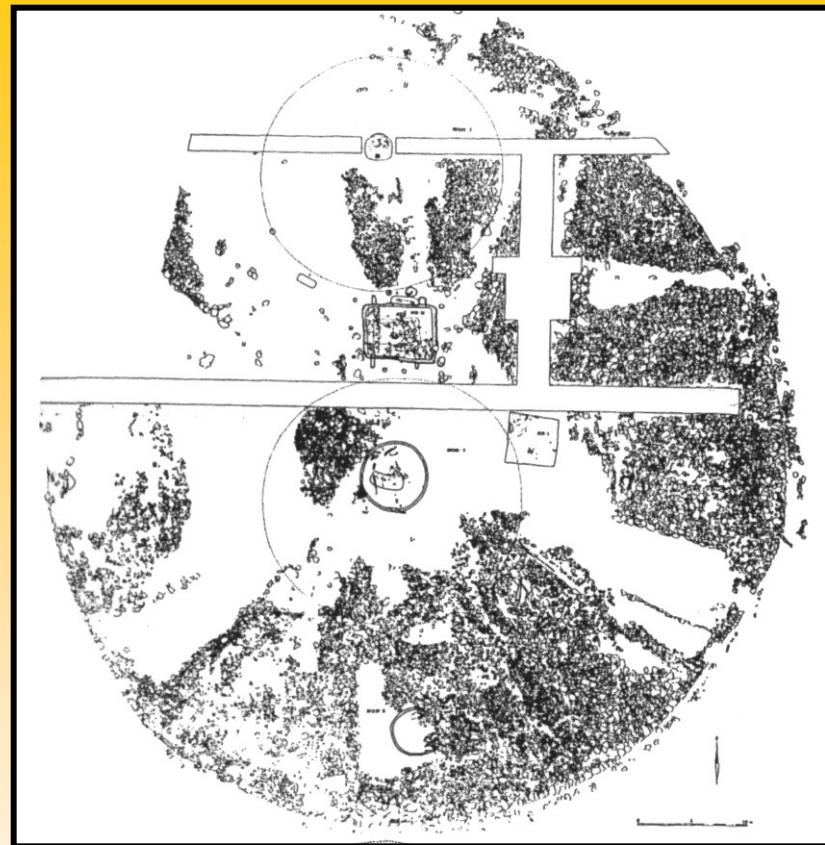

**půdorys
mohyly**

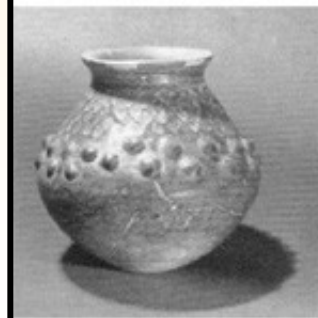

Shrnutí

- Periodizace Doby římské a Doby stěhování národů
- Charakteristika období
- Pohřební ritus, pohřebiště, bohaté hroby
- Typy sídlišť
- Germánská keramika a zbraně, římské importy
- Římané – limes romanus, římské vojsko, římský vojenský zásah na našem území
- Hunové a Langobardi – dějiny, hmotná kultura

Děkuji za pozornost