

THE UNIVERSITY OF CHICAGO
ORIENTAL INSTITUTE PUBLICATIONS
VOLUME LXIII

THE UNIVERSITY OF CHICAGO PRESS · CHICAGO 37

CAMBRIDGE UNIVERSITY PRESS, LONDON, N.W. 1, ENGLAND

W. J. GAGE & CO., LIMITED, TORONTO 2B, CANADA



a



b



c



d



e



f



g

TWO LARGE VATS FROM A SHRINE OF THE LARSA PERIOD AT TELL ASMAR (SEE PLS. 128-29). SCALE 1:10 (EXCEPT f).

THE UNIVERSITY OF CHICAGO
ORIENTAL INSTITUTE PUBLICATIONS
VOLUME LXIII

POTTERY FROM
THE DIYALA REGION

BY PINHAS DELOUGAZ



THE UNIVERSITY OF CHICAGO PRESS · CHICAGO · ILLINOIS

THIS PUBLICATION IS ONE OF A GROUP PLANNED TO PRESENT AS A WHOLE THE WORK OF THE
ORIENTAL INSTITUTE'S IRAQ EXPEDITION IN THE DIYALA REGION • THE PROPOSED TITLES ARE:

FOUR ANCIENT TOWNS IN THE DIYALA REGION
PRIVATE HOUSES AND GRAVES IN THE DIYALA REGION
THE TEMPLE OVAL AT KHAFĀJAH (OIP LIII)
PRE-SARGONID TEMPLES IN THE DIYALA REGION (OIP LVIII)
THE GIMILSIN TEMPLE AND THE PALACE OF THE RULERS AT TELL ASMAR (OIP XLIII)
OLD BABYLONIAN PUBLIC BUILDINGS IN THE DIYALA REGION
SCULPTURE OF THE THIRD MILLENNIUM B.C. FROM TELL ASMAR AND KHAFĀJAH (OIP XLIV)
MORE SCULPTURE FROM THE DIYALA REGION (OIP LX)
STRATIFIED CYLINDER SEALS FROM THE DIYALA REGION
POTTERY FROM THE DIYALA REGION (OIP LXIII)
MISCELLANEOUS OBJECTS FROM THE DIYALA REGION

COPYRIGHT 1952 BY THE UNIVERSITY OF CHICAGO • ALL RIGHTS
RESERVED • PUBLISHED 1952 • COMPOSED AND PRINTED BY
THE UNIVERSITY OF CHICAGO PRESS • CHICAGO • ILLINOIS • U.S.A.

TO
THE MEMORY OF
RIGMOR JACOBSEN
HAROLD D. HILL
CALVIN W. McEWAN

FOREWORD

THE advance of knowledge brings burdens as well as rewards. In archeology it is usual for the first surprise of new discoveries to be followed by the recognition of a few distinct phases which in their succession give a rough and ready outline of cultural development. But if work continues, an increasing number of transitional phenomena swamp the clarity of such divisions; the blacks and whites appear to be variously shaded grays; the blunt succession must be reinterpreted as a series of gradual changes, as the interplay of survival and innovation. In the present publication Mr. Delougaz has undertaken this laborious task in dealing with the pottery found on our four sites between the years 1930 and 1938. The advance achieved can best be judged by comparing his results with the two publications which represent the earlier state of our knowledge: *Studies in Ancient Oriental Civilization* No. 4 (1932) and *Oriental Institute Communications* No. 20 (1936). If the picture drawn in the present publication is new in that it reflects the course of the actual development, it shares, necessarily, the latter's complexity.

At the very outset Mr. Delougaz was faced with the difficulty that no satisfactory method for dealing with such a vast amount of material was known. Flinders Petrie had evolved a purely empirical system, which worked well enough within narrow limits, but which lacked precision and could be neither refined nor expanded because of its illogical, purely practical nature. Yet—and this is a measure of Petrie's genius—his system has not been improved upon or superseded for forty years. But the quantity and the variety of the pottery with which Mr. Delougaz had to deal made the adoption of another system imperative. And we believe that he has succeeded in evolving a completely new type of classification which is logical and yet adaptable to any given group of ceramic remains. It is, moreover, as simple as one may reasonably expect of a system capable of doing justice to all the diversification of the potters' produce.

In the first chapter the system of classification is explained; it is applied to our discoveries in Plates 140-99. In the second chapter our pottery, from the Protoliterate period to the age of Hammurabi, is described period by period. In the third chapter readers will find the essential features of this ceramic development summarized, not only as it is evidenced by our own discoveries, but also by those made elsewhere. The catalogue of pottery forms also includes references to similar pieces found on other sites. Thus the student of comparative archeology, the fieldworker, and the curator of a museum may, we hope, be able to utilize our material for their several purposes with the least difficulty. We hope furthermore that they may be stimulated to undertake the study of those subjects which, as Mr. Delougaz indicates in his third chapter, invite further research.

H. FRANKFORT

CHICAGO, ILLINOIS
March 1947

PREFACE

THE aim of the present publication is to present as complete a record as possible of the pottery recovered from the four ancient sites of Khafajah, Tell Asmar, Tell Agrab, and Ishchali in the Diyala region.

The majority of the material was discovered by the Iraq Expedition of the Oriental Institute, which held the concession for excavations in this region from 1930 to 1937. During that period the various branches of the Expedition conducted seven consecutive campaigns at Khafajah (1930-37), six campaigns at Tell Asmar (1930-35), two at Tell Agrab (1935-37), and two at Ishchali (1934-36). Two more seasons at Khafajah under the joint auspices of the University Museum (University of Pennsylvania) and the American Schools of Oriental Research, in the spring of 1937 and the winter of 1937/38, brought to light a considerable amount of additional material, particularly some fine specimens of polychrome "Jamdat Nasr" type and "scarlet ware" pottery. By mutual consent of the above mentioned institutions this additional material is included in the present publication.

By including in a single volume the pottery from the four sites we follow the general plan for publishing the archeological results of the Iraq Expedition—a plan that aims to present these results in a series of books, each devoted to a single category of finds from all the sites and disregarding, as far as possible, the accidentals in the progress of digging.

Unlike a work devoted to the interpretation of previously published archeological finds, for which the material can be chosen to suit a particular line of argument and all that is not essential to this argument may be ignored, the present publication, being primarily a record of new discoveries in the field, allows no such freedom of selection. Indeed, the more we learn of Near Eastern pottery, the clearer it becomes that little value can be attached to preconceived abstract theories as to which of the characteristics of a newly discovered group of pottery may prove archeologically significant; hence, we found no justification for omitting any material which was adequately recorded in the field. This and the fact that our finds are the result of an aggregate of nineteen digging campaigns at four different sites, each containing ruins of widely differing dates and character, account for the considerable bulk and variety of material included in this volume.

The scope and character of this material made it impractical to deal in the text with every individual specimen recorded. Consequently, we endeavored to adopt a method of publication which, in addition to a general chronological survey, should allow for the presentation of the available information concerning each of the recorded specimens in a comparatively simple manner. For this purpose a system of classification had first to be devised to serve as a basis for cataloguing and for a systematic arrangement of the drawings of pottery forms.

The principles of such a system are the subject of the first chapter. Their outlines were first proposed by the writer in 1935 and were subsequently applied by him in recording the pottery found at Khafajah. In the last season of the Iraq Expedition in the field (1936/37) Mr. Seton Lloyd accepted this method for dealing with some of the pottery from Tell Agrab. Guided by the experience afforded by these practical applications the writer considerably modified some details, especially those which were originally based on theoretical considerations, to suit the specific character of the pottery actually found.

The writer is well aware of the fact that the resulting system, as presented here, may have certain limitations and shortcomings. If, nevertheless, an appeal is made that archeologists who may find enough merit in this system to justify its application to their own material

should refrain from introducing individual alterations and improvements, it is only to prevent the hopeless confusion that must follow such a course. For, to quote the scholar who was the first to attempt a systematic classification of pottery: "Such principles may be arbitrary, but yet they must be kept up, or else a *corpus* would become so confused that identification of forms would be difficult."¹

The second chapter is devoted to a general description of the pottery in chronological order. In it we examine the more important types and attempt to trace their development and disappearance. The pottery from the various sites is treated as a whole, since the distance between them is not great enough to warrant the surmise of a large degree of independent local development. Indeed, in our estimate, the variations in types of similar date from the different sites are no greater than those found in different parts of a single site and are largely accounted for by accidental elements in the excavations. By examining the pottery from the four sites for each period some of the gaps in the material from one site are filled in by evidence obtained from another.

The third chapter is devoted to general observations and conclusions. The remainder of the book consists of a list of pottery forms by periods and phases, catalogues, indexes, and illustrations. A general plan of each of the excavated sites and a map showing the location of the major sites in Mesopotamia are also included.

Although the aim is to present our pottery as completely as possible, the present publication is by no means an exhaustive study covering all the archeological conclusions and implications which can be derived from the material. Such a study must be based to a large extent on comparisons with related evidence from other sites and, in view of the range of our finds, would be far beyond the scope of the present work. For the most part parallels from other sites are mentioned in the text only when relevant for the better understanding of our own material and in a few instances when the new evidence necessitates modification of previously held views. When references for such parallels are not given along with the discussion, they may be found in the catalogue of pottery forms. This catalogue is arranged according to the system of classification described in the first chapter and is printed opposite the drawings of pottery forms (Pls. 140-199). The colored plates (Pls. 1-16), the photographs (Pls. 17-132), and a group of drawings of designs on painted pottery (Pls. 133-39) are each arranged roughly in chronological order to correspond to the text of chapter ii. The field number, exact provenience, and date of all sherds included in these illustrations are given in the catalogue of illustrated sherds and other clay objects (pp. 162-66), which is arranged in numerical order according to plate number.

To some extent the various parts of this book are independent as a result of our wish to meet the needs of the general student, who may be interested only in a chronological survey of the pottery, and of the specialist, who may require detailed information concerning some specific aspects of the material. Yet, essentially the different parts are complementary, for only their combination presents a complete record of our finds.

Work of several members of the Oriental Institute's Iraq Expedition, of the Joint Expedition of the University Museum and the American Schools of Oriental Research, and of the Oriental Institute's staff in Chicago is embodied in this volume. The photographs of the pottery from Tell Asmar, Tell Agrab, and Ishchali were taken by Mrs. Rigmor Jacobsen. The work of Dr. Conrad Preusser, Dr. Neilson C. Debevoise, Dr. Calvin W. McEwan, Count Alexander zu Eltz, Mr. Leslie Grant, Dr. Abraham Bergman, and Mr. John Tobler is represented in the photographs of the Khafajah pottery. The color plates are reproduced after paintings by Miss G. Rachel Levy, Dr. Alberto Davico, and Mr. Bartow Müller. To the schematic drawings nearly all the members of the expeditions contributed at one time or

¹ W. M. Flinders Petrie, *Corpus of Prehistoric Pottery and Palettes* (London, 1921) p. 5.

another. However, the great majority were drawn by Miss G. Rachel Levy at Tell Asmar and Mr. Hamilton D. Darby at Khafajah. Mr. Luin W. Hough has photographed several of the specimens which are in the Oriental Institute Museum and has moreover contributed most of the prints used for reproduction. Mr. J. Swanson of Work Projects Administration Official Project No. 665-54-3-257 and Mr. Carl Dinella transferred field drawings to make up the plates of pottery forms. Miss Elizabeth Stefanski and Mrs. Hilde Erwin assisted in preparing parts of the manuscript. Mrs. Ruth S. Brookens, Miss Nancy Purtill, and Mrs. Elizabeth B. Hauser spared no effort in helping to shape different parts of the manuscript and shared in the tedious task of checking the text and catalogues against the original field records. Mrs. Hauser, in the final editing of the book as a whole and in seeing it through the press, contributed valuable suggestions for its improvement.

To all those mentioned as well as to his colleagues in the field and at home who let him benefit by their suggestions and friendly criticism, the writer is deeply indebted for their respective contributions to this publication.

P. DELOUGAZ

CHICAGO, ILLINOIS
September 1947

TABLE OF CONTENTS

	PAGE
LIST OF ILLUSTRATIONS	xvii
LIST OF ABBREVIATIONS	xxi
I. A SYSTEM OF POTTERY CLASSIFICATION	1
Pottery in Archeological Research	1
Bases for Pottery Classification	2
Material	2
Technique of Manufacture	3
Surface Finish and Decoration	3
Form	3
Classification and Designation of Forms	4
Definition of Ten Major Groups	5
Detailed and Abbreviated Classifications	6
Subdivision of Ten Major Groups	7
Proportions	10
Accessories	16
Base	17
Rim, Neck, and Shoulder	17
Other Accessories	17
Size	18
Classification and Designation of Other Characteristics	19
Surface Finish and Decoration	19
Provenience and Date	21
Complete Composite Marking	22
Application of the System	22
Size	23
General Shape	23
Proportions and Accessories	25
Pottery Records	25
II. DESCRIPTION OF THE POTTERY	27
Introductory Remarks	27
Region and Sites	27
Range and Distribution	27
Technical Qualities	31
Fabric	31
Manufacture	32
Surface Finish	33
The Protoliterate Period	34
The Earliest Pottery	34
Early Polychrome Ware and Related Vessels	35
Pouring Vessels	37
Crude Bowls, Disks, and Oval Dishes	39
Unpainted and Polychrome Four-lugged Vessels	39
Miscellaneous Utensils	41
Theriomorphic Ritual Vases	43

TABLE OF CONTENTS

	PAGE
Monochrome-painted Pottery	44
Four-lugged Jars	44
Spouted Jars	46
Miscellaneous Vessels	47
Late Polychrome (Jamdat Nasr) Ware	48
Early Dynastic I	52
Unpainted Pottery	52
Spouted Jars	52
Four-lugged Jars	53
"Flowerpots"	55
Stands and Braziers	55
Solid-foot Goblets	56
Single-lugged Jars	57
Gray Pottery	58
Miscellaneous Pottery	58
Painted Pottery	60
Scarlet Ware	60
All-over Painted Vessels and Monochrome-painted Pottery	72
Groups of Protoliterate and Early Dynastic I Pottery	73
Early Dynastic II	80
Painted Pottery	80
Unpainted Pottery	80
Large Jars with Plastic Ridges	80
Spouted Vessels	80
Stands and Braziers	81
Jar Covers and Unusual Utensils	81
Ordinary Household Pottery	82
Flasks	83
Jars with Upright Handles	83
"Fruit Stands"	85
Ritual Utensils	85
Early Dynastic III	87
Jars with Upright Handles	87
"Fruit Stands"	90
Hollow Stands	91
Spouted Vessels	91
Ritual Vessels	93
Bowls	94
Jars with Flat and Ring Bases	95
Storage Jars	97
Vessels Adapted for Suspension	97
Vessels with Convex or Pointed Bases	99
Miscellaneous Small Pots	100
Braziers and "Crucibles"	100
Studded Ware	102
Varia	102
Architectural Fixtures	104
Historical Periods	105
The Protoimperial Period	105
The Agade Period	109
End of Gutium and Ur III	113
The Isin-Larsa Period	114
The Old Babylonian Period	122

TABLE OF CONTENTS

	XV
	PAGE
III. COMPARISONS AND CONCLUSIONS	125
The Protoliterate Period	125
Diyala Pottery	125
Some Related Pottery from Outside the Diyala Region in Southern Mesopotamia	127
Origin of Some Characteristic Protoliterate Wares	130
Polychrome Pottery	130
Monochrome-painted Pottery	132
Pottery with Reserved-Slip Decoration	133
North Mesopotamian Connections	133
Egyptian Connections	134
Pottery Types in Primitive Mesopotamian Writing	135
Early Dynastic I	135
Continuity between Protoliterate and Early Dynastic I Pottery	135
Typical Early Dynastic I Pottery	136
Related Pottery from Outside the Diyala Region in Southern Mesopotamia	137
Related Pottery in Elam	139
North Mesopotamian Connections	141
Early Dynastic II	141
Diyala Pottery	141
Related Pottery from Outside the Diyala Region	142
Early Dynastic III	142
Diyala Pottery	142
Related Pottery from Elsewhere	144
The Protoimperial Period	145
The Agade Period	147
End of Gutium and Ur III	148
The Larsa Period	148
The Old Babylonian Period	150
EXPLANATION OF THE CATALOGUE OF POTTERY FORMS (SEE PLS. 140-99)	152
POTTERY FORMS BY PERIODS AND PHASES	156
Protoliterate <i>c</i>	156
Protoliterate <i>d</i>	156
Protoliterate <i>d</i> or Early Dynastic I	156
Early Dynastic I	156
Early Dynastic II	157
Early Dynastic II or III	158
Early Dynastic III	158
Early Dynastic III or Protoimperial	159
Protoimperial	159
Agade	159
Agade or Late Gutium-Ur III	160
Late Gutium-Ur III	160
Late Gutium-Ur III or Larsa	160
Larsa	160
Larsa or Old Babylonian	161
Old Babylonian	161
CATALOGUE OF ILLUSTRATED SHERDS AND OTHER CLAY OBJECTS	162
INDEX OF FIELD NUMBERS	167
GENERAL INDEX	180

LIST OF ILLUSTRATIONS

Frontispiece. TWO LARGE VATS FROM A SHRINE OF THE LARSA PERIOD AT TELL ASMAR

PLATES

1. PAINTED AND BURNISHED VASE, ONE OF THE EARLIEST SPECIMENS FROM KHAFAJAH
2. TWO VESSELS FROM KHAFAJAH
3. TWO VESSELS WITH MONOCHROME DECORATION
4. FOUR PAINTED POTSDHERDS
5. VASE OF THE PROTOLITERATE PERIOD FOUND IN THE FIRST TEMPLE OVAL AT KHAFAJAH
6. SHOULDER OF A LARGE VASE OF THE PROTOLITERATE PERIOD FROM KHAFAJAH
7. BIRD-VASE FOUND IN AN EARLY DYNASTIC II LEVEL OF THE SMALL TEMPLE AT KHAFAJAH
8. FOUR PAINTED VASES FROM KHAFAJAH ILLUSTRATING THE TRANSITION FROM JAMDAT NASR POLYCHROME TO SCARLET WARE
9. THREE SCARLET-WARE VASES FROM EARLY DYNASTIC I LEVELS AT KHAFAJAH
10. DEVELOPMENT OF DESIGNS ON A RESTORED SCARLET-WARE VASE FROM KHAFAJAH
11. RESTORED SCARLET-WARE VASE FROM TELL AGRAB
12. RESTORED SCARLET-WARE VASE FROM TELL AGRAB
13. ONE OF THE EARLIEST SPECIMENS OF SCARLET WARE FROM KHAFAJAH
14. DEVELOPMENT OF DESIGNS ON VASE SHOWN IN PLATE 13
15. ONE OF THE LATEST SPECIMENS OF SCARLET WARE FROM KHAFAJAH
16. RED-PAINTED VASE OF THE END OF EARLY DYNASTIC I FROM KHAFAJAH
17. 'UBAID REMAINS FROM TELL AGRAB AND KHAFAJAH, PROTOLITERATE SHERDS FROM KHAFAJAH
18. PROTOLITERATE POTTERY FROM KHAFAJAH
19. SPOUTED JARS OF THE PROTOLITERATE PERIOD FROM KHAFAJAH
20. PROTOLITERATE POTTERY FROM KHAFAJAH AND A FRAGMENTARY VESSEL FROM TELL KHUBAIR
21. CRUDE BOWLS OF PROTOLITERATE c FROM KHAFAJAH
22. FOUR-LUGGED JARS OF THE PROTOLITERATE PERIOD FROM TELL AGRAB AND KHAFAJAH
23. PROTOLITERATE POTTERY FROM KHAFAJAH
24. UNUSUAL VESSELS OF THE PROTOLITERATE PERIOD FROM KHAFAJAH
25. A BIRD-VASE AND A BULL-VASE FROM SIN TEMPLE III AND IV AT KHAFAJAH
26. TWO MORE VIEWS OF BULL-VASE SHOWN IN PLATE 25
27. PAINTED BIRD-VASE FROM SMALL TEMPLE VI AT KHAFAJAH, PROBABLY A SURVIVAL FROM THE PROTOLITERATE PERIOD
28. MONOCHROME-PAINTED FOUR-LUGGED JARS FROM SIN TEMPLE I AND III AT KHAFAJAH
29. FRAGMENTS OF MONOCHROME-PAINTED AND POLYCHROME FOUR-LUGGED JARS FROM SIN TEMPLE I AND III AT KHAFAJAH
30. MONOCHROME-PAINTED SPOUTED VASE FROM THE EARLIEST SHRINE OF THE ABU TEMPLE AT TELL ASMAR
31. FRAGMENTS OF MONOCHROME-PAINTED SPOUTED JARS OF THE PROTOLITERATE PERIOD FROM KHAFAJAH
32. MONOCHROME-PAINTED VESSELS OF THE PROTOLITERATE PERIOD FROM KHAFAJAH
33. VASE OF PROTOLITERATE LATE POLYCHROME WARE FOUND IN TEMPLE OVAL I AT KHAFAJAH
34. VASE OF PROTOLITERATE LATE POLYCHROME WARE FROM KHAFAJAH
35. VASES OF PROTOLITERATE LATE POLYCHROME WARE FROM KHAFAJAH
36. LATE POLYCHROME WARE OF THE PROTOLITERATE PERIOD FROM KHAFAJAH
37. ED I SPOUTED JARS FROM TELL AGRAB AND KHAFAJAH
38. ED I SPOUTED JARS FROM KHAFAJAH AND TELL AGRAB
39. ED I VESSELS WITH RESERVED-SLIP DECORATION, FROM KHAFAJAH AND TELL ASMAR
40. PLAIN FOUR-LUGGED NECKLESS JARS FROM SIN TEMPLE V AT KHAFAJAH AND ARCHAIC SHRINE II AT TELL ASMAR

41. FOUR-LUGGED NECKLESS JARS WITH INCISED DECORATION, FROM ARCHAIC SHRINE III AT TELL ASMAR AND HILL B(?) AT TELL AGRAB
42. FRAGMENTS OF ED I FOUR-LUGGED NECKLESS JARS WITH INCISED DECORATION, FROM TELL ASMAR AND TELL AGRAB
43. SHERDS FROM HOUSES 9 OR 8 AT KHAFAJAH
44. ED I VASES FROM KHAFAJAH AND TELL ASMAR
45. ED I "FLOWERPOTS" AND STANDS FROM KHAFAJAH, TELL ASMAR, AND TELL AGRAB
46. ED I SOLID-FOOT GOBLETS FROM KHAFAJAH AND TELL ASMAR
47. SINGLE-LUGGED JARS FROM KHAFAJAH AND TELL AGRAB, PROBABLY ALL OF ED I DATE
48. GRAY POTTERY AND A STONE VESSEL OF ED I, ORANGE BURNISHED SHERDS FROM AN ED III LEVEL
49. ED I UTENSILS FROM KHAFAJAH
50. MISCELLANEOUS UTENSILS OF ED I AND II FROM TELL ASMAR AND KHAFAJAH
51. FRAGMENTS FROM THE SHARA TEMPLE AT TELL AGRAB AND TEMPLE OVAL II AT KHAFAJAH
52. TRANSITIONAL SCARLET-WARE JARS FROM TELL AGRAB AND A VASE OF SCARLET WARE PROPER FROM TELL ASMAR
53. TRANSITIONAL SCARLET-WARE SHERDS FROM TELL AGRAB
54. SCARLET-WARE VASES FROM HOUSES 11 AT KHAFAJAH AND FROM TELL AGRAB
55. SCARLET-WARE JARS FROM KHAFAJAH AND TELL AGRAB
56. SCARLET-WARE VASES FROM KHAFAJAH AND TELL AGRAB
57. SCARLET-WARE VASE FROM TELL AGRAB AS RESTORED IN THE IRAQ MUSEUM
58. SCARLET-WARE FRAGMENTS FROM TELL AGRAB
59. RESTORED SCARLET-WARE VASE FROM KHAFAJAH
60. RESTORED SCARLET-WARE VASE FROM KHAFAJAH
61. TWO MORE VIEWS OF VASE SHOWN IN PLATE 60
62. SCARLET-WARE VASE FROM KHAFAJAH AS RESTORED IN THE BRITISH MUSEUM AND DRAWING OF PRESERVED PARTS OF THE DESIGN
63. PROTOLITERATE AND ED I REMAINS FROM THE D 15:3 SOUNDING AT TELL ASMAR
64. PROTOLITERATE AND ED I MATERIAL FROM THE H 18:14 SOUNDING AT TELL ASMAR
65. ED I POTTERY FROM TELL AGRAB
66. LARGE ED I AND II JARS FROM TELL ASMAR AND KHAFAJAH
67. ED II SPOUTED JARS FROM KHAFAJAH AND TELL ASMAR
68. ED II STANDS FROM TELL AGRAB AND TELL ASMAR
69. LARGE BRAZIER WITH BOWL, FROM SMALL TEMPLE VI AT KHAFAJAH
70. UTENSILS OF THE EARLY DYNASTIC PERIOD FROM TELL AGRAB, KHAFAJAH, AND TELL ASMAR
71. ED II VESSELS FROM KHAFAJAH
72. COMMON HOUSEHOLD JARS FROM HOUSES 6 AND 5 AT KHAFAJAH
73. COMMON HOUSEHOLD JARS FROM HOUSES 5 AND 4 AND TWO RED-PAINTED JARS FROM HOUSES 6 AT KHAFAJAH
74. ED II VESSELS FROM KHAFAJAH
75. FLASKS FROM KHAFAJAH, PROBABLY ALL OF ED II DATE
76. UPRIGHT-HANDLED JARS OF ED I AND II FROM TELL ASMAR AND KHAFAJAH
77. UPRIGHT-HANDLED JARS FROM ED II AND III GRAVES AT KHAFAJAH
78. ED II UPRIGHT-HANDLED VASES FROM KHAFAJAH
79. UPRIGHT-HANDLED JARS FROM GRAVES OF HOUSES 3 AT KHAFAJAH
80. UPRIGHT-HANDLED JARS FROM ARCHAIC SHRINE IV AT TELL ASMAR AND HOUSES 3 AND 2 AT KHAFAJAH
81. "FRUIT STANDS" FROM ED II AND III GRAVES AT KHAFAJAH
82. "CULT WAGON" FROM SIN TEMPLE VIII AT KHAFAJAH
83. DRAWINGS OF "CULT WAGON"
84. UPRIGHT-HANDLED JARS FROM TELL AGRAB AND KHAFAJAH
85. LARGER-SCALE VIEWS OF SHOULDERS OF JARS SHOWN IN PLATES 79 *b* AND 80 *b*
86. UPRIGHT HANDLES WITH INCISED DECORATION
87. UPRIGHT HANDLES WITH INCISED AND PLASTIC DECORATION

88. ED III "FRUIT STANDS" FROM KHAFAJAH
89. FRAGMENTS OF ED III "FRUIT STANDS" WITH INCISED DECORATION, FROM TELL ASMAR AND KHAFAJAH
90. SPOUTED JARS FROM GRAVES OF HOUSES 3 AT KHAFAJAH
91. FRAGMENTS OF DOUBLE-SPOUTED VESSELS FROM TELL ASMAR AND KHAFAJAH, A SINGLE-SPOUTED VESSEL AS FOUND IN TEMPLE OVAL II AT KHAFAJAH
92. SNAKE-DECORATED FRAGMENTS OF PROTOLITERATE TO LARSA DATE FROM KHAFAJAH AND TELL ASMAR
93. UNUSUAL SPOTTED JARS OF ED III FROM KHAFAJAH
94. ED II to LARSA(?) THERIOMORPHIC VESSELS AND FRAGMENTS FROM TELL AGRAB, TELL ASMAR, AND KHAFAJAH
95. ED III FRAGMENTS WITH INCISED AND PLASTIC DECORATION, FROM KHAFAJAH
96. ED III BOWLS FROM TELL ASMAR AND KHAFAJAH
97. CONICAL BOWLS WITH INNER RIMS AND BOWLS WITH CONVEX BASES, FROM TELL ASMAR AND KHAFAJAH, PROBABLY ALL OF ED III DATE
98. SMALL HOUSEHOLD JARS FROM TELL ASMAR AND KHAFAJAH, PROBABLY ALL OF ED III DATE
99. MEDIUM-SIZED HOUSEHOLD JARS FROM KHAFAJAH, OF ED II-III AND PROTOIMPERIAL(?) DATE
100. JARS FROM TELL ASMAR AND KHAFAJAH, PROBABLY ALL OF ED III DATE
101. VESSELS WITH SUSPENSION DEVICES, FROM TELL ASMAR AND KHAFAJAH, OF ED III AND PROTOIMPERIAL(?) DATE
102. SMALL VESSELS FROM KHAFAJAH AND TELL ASMAR, OF ED III AND PROTOIMPERIAL DATE
103. SMALL ED III VESSELS FROM KHAFAJAH
104. FRAGMENTS OF ED III AND PROTOIMPERIAL BRAZIERS FROM KHAFAJAH AND TELL ASMAR, A PROTOIMPERIAL(?) "KITCHEN RANGE" FROM TELL ASMAR
105. TWO BRAZIERS PROBABLY FROM KHAFAJAH, VESSELS OF RIBBED AND STUDDED WARES FROM TELL ASMAR
106. AN ED III(?) BOWL FROM KHAFAJAH AND UNUSUAL FRAGMENTS OF ED III, AGADE(?), AND LARSA DATE FROM KHAFAJAH AND TELL ASMAR
107. VESSELS USED AS "JEWEL BOXES" OR "SAFES" FROM TELL ASMAR AND KHAFAJAH, OF ED II-III AND LARSA DATE
108. LARGE JAR WITH PERFORATION IN BASE, USED IN CONNECTION WITH HORIZONTAL DRAIN IN HOUSES 3 AT KHAFAJAH
109. VERTICAL DRAIN IN HOUSES 4 AT KHAFAJAH
110. TWO ED III SPOUTS FROM KHAFAJAH, TWO CONICAL BOWLS AND PROTOIMPERIAL VESSELS FROM TELL ASMAR
111. ROUND-BOTTOMED BOTTLES OF PROTOIMPERIAL AND GUTIUM-UR III TIMES FROM TELL ASMAR
112. BOTTLES AND OTHER POTTERY FROM TELL ASMAR, PROBABLY ALL OF PROTOIMPERIAL DATE
113. MISCELLANEOUS POTTERY OF AGADE AND GUTIUM-UR III TIMES FROM TELL ASMAR
114. AGADE AND GUTIUM-UR III UTENSILS FROM TELL ASMAR
115. STORAGE JARS FROM TELL ASMAR, OF PROTOIMPERIAL(?) AND AGADE DATE
116. BRAZIER FOUND AT TELL ASMAR PROBABLY IN HOUSES IV *a* AND CLAY MINIATURE MODEL FROM BISMAYAH
117. BRAZIERS OF GUTIUM-UR III AND LARSA(?) TIMES AND AN EARLY AGADE "KITCHEN RANGE," ALL *in situ* AT TELL ASMAR
118. "CRUCIBLE" AND BRAZIER OF GUTIUM-UR III TIMES AND A LATE LARSA "WASH BASIN," ALL *in situ* AT TELL ASMAR
119. JARS FROM TELL ASMAR, PROBABLY ALL OF LARSA DATE
120. MISCELLANEOUS UTENSILS FROM TELL ASMAR, PROBABLY ALL OF LARSA DATE
121. MISCELLANEOUS UTENSILS FROM TELL ASMAR, OF AGADE(?) AND LARSA DATE
122. SMALL JARS WITH SUSPENSION LOOPS AND A FRAGMENT OF INCISED GRAY WARE FROM TELL ASMAR, ALL OF LARSA DATE
123. SHERDS OF INCISED GRAY WARE FROM TELL ASMAR, OF GUTIUM-UR III(?) AND LARSA DATE
124. SHERDS OF INCISED GRAY WARE FROM TELL ASMAR, ALL OF LARSA DATE

LIST OF ILLUSTRATIONS

125. SHERDS OF INCISED GRAY WARE FROM TELL ASMAR, ALL OF LARSA DATE
 126. UNUSUAL SHERDS OF VARIOUS PERIODS, MOSTLY LARSA, FROM KHAFAJAH AND TELL ASMAR
 127. "COLUMN"-DECORATED FRAGMENTS FROM KHAFAJAH AND TELL ASMAR, OF ED III, PROTO-
 IMPERIAL, AND LARSA DATE
 128. THE SNAKE JAR BEFORE AND AFTER REMOVAL OF COVER
 129. THE SNAKE JAR WITH COVER STILL IN POSITION
 130. LIDS, A STRAINER SPOUT, AND TWO LAMPS, MOSTLY OF LARSA DATE
 131. CLAY TOOLS OF THE LARSA PERIOD FROM TELL ASMAR
 132. THIN-WALLED VESSELS OF THE OLD BABYLONIAN PERIOD FROM KHAFAJAH
 133. POLYCHROME POTTERY FROM KHAFAJAH, TELL AGRAB, AND TELL ASMAR, PROBABLY ALL PROTO-
 LITERATE
 134. MONOCHROME-PAINTED POTTERY FROM PROTOLITERATE LEVELS AT KHAFAJAH AND ED I LEVELS
 AT TELL ASMAR
 135. SHOULDER DESIGNS ON SCARLET-WARE VASES FROM TELL AGRAB
 136. SCARLET WARE FROM KHAFAJAH AND TELL ASMAR
 137. BODY DESIGN ON A SCARLET-WARE VASE FROM TELL AGRAB, SCARLET-WARE SHERDS FROM TELL
 AGRAB AND KHAFAJAH
 138. SUGGESTED RESTORATION OF BODY DESIGN ON A SCARLET-WARE VASE FROM KHAFAJAH NOW IN THE
 BRITISH MUSEUM
 139. INCISED SHOULDER DESIGN ON AN ED III UPRIGHT-HANDLED JAR FROM KHAFAJAH, FRAGMENTS OF
 A UNIQUE PAINTED VESSEL OF THE PROTOIMPERIAL PERIOD FROM TELL ASMAR
 140-99. DRAWINGS OF POTTERY FORMS
 200. CONTOUR MAP OF KHAFAJAH SHOWING EXCAVATED AREAS
 201. CONTOUR MAP OF TELL ASMAR SHOWING EXCAVATED AREAS
 202. CONTOUR MAP OF MOUND A AT TELL AGRAB SHOWING EXCAVATED AREAS
 203. CONTOUR MAP OF EXCAVATED AREAS AT ISHCHALI
 204. MAP SHOWING LOCATION OF MAJOR SITES IN MESOPOTAMIA

TEXT FIGURES

	PAGE
1. SCHEMATIC FORMS CHARACTERIZING GROUPS .0 TO .7 OF THE TEN MAJOR DIVISIONS OF POTTERY FORMS	5
2. HYPOTHETICAL VESSELS OF SHAPE .07 REPRESENTING THE TEN MAJOR RATIOS BETWEEN MAXIMUM HEIGHT AND MAXIMUM WIDTH	12
3. CHART SHOWING RANGE OF VARIATION IN HEIGHT FOR THE SAME WIDTH IN EACH OF THE TEN PROPORTIONAL GROUPS	13
4. A SCALE FOR DETERMINING THE CIPHERS WHICH DENOTE THE VARIOUS PROPORTIONS OF ANY VESSEL	14
5. DIAGRAM ILLUSTRATING USE OF THE SCALE TO DETERMINE CIPHER DENOTING RATIO BETWEEN MAXIMUM HEIGHT AND MAXIMUM WIDTH	15
6. DIAGRAM ILLUSTRATING USE OF THE SCALE TO DETERMINE CIPHER DENOTING RATIO BETWEEN MAXIMUM HEIGHT AND MAXIMUM WIDTH	15
7. TWO HYPOTHETICAL VESSELS OF SHAPE .57 WITH THE SAME RATIO BETWEEN MAXIMUM HEIGHT AND MAXIMUM WIDTH BUT DIFFERING IN OTHER PROPORTIONS	15
8. DIAGRAM ILLUSTRATING USE OF THE SCALE TO DETERMINE CIPHER DENOTING RATIO BETWEEN WIDTH OF OPENING AND MAXIMUM WIDTH OF A VESSEL	16
9. DIAGRAM ILLUSTRATING USE OF THE SCALE TO DETERMINE CIPHER DENOTING POSITION OF MAXI- MUM DIAMETER IN RELATION TO HEIGHT OF A VESSEL	16
10. FOUR HYPOTHETICAL VESSELS, EACH PAIR CONSISTING OF TWO WHOSE EXTERIOR CONTOURS ARE IDENTICAL BUT WHOSE DESIGNATIONS DIFFER ON THE BASIS OF CONSTRUCTIONAL DETAILS	24

TABLES

I. CHART OF THE TEN MAJOR GROUPS OF POTTERY FORMS AND THEIR SUBDIVISIONS	11
II. DEFINITIONS OF THE DIGITS USED IN THE ABBREVIATED POTTERY CLASSIFICATION	18
III. STRATIGRAPHIC CORRELATION OF ALL EXCAVATIONS ON THE DIYALA SITES	<i>at end</i>

LIST OF ABBREVIATIONS

- AAA* Annals of archaeology and anthropology (Liverpool, 1908——).
- AASOR XXI-XXII* ALBRIGHT, WILLIAM FOXWELL. The excavation of Tell Beit Mirsim. III. The Iron Age (American Schools of Oriental Research. Annual XXI-XXII [New Haven, 1943]).
- AJ* The antiquaries journal (London, 1921——).
- AJA* American journal of archaeology (Baltimore etc., 1885——).
- AS* No. 11 JACOBSEN, THORKILD. The Sumerian king list (Chicago. University. The Oriental Institute. Assyriological studies, No. 11 [Chicago, 1939]).
- BASOR* American Schools of Oriental Research. Bulletin (South Hadley, Mass., 1919——).
- Cros, Tello* CROS, GASTON. Mission française de Chaldée. Nouvelles fouilles de Tello (Paris, 1910-14).
- Frankfort, Studies I* FRANKFORT, H. Studies in early pottery of the Near East. I. Mesopotamia, Syria, and Egypt and their earliest interrelations (Royal Anthropological Institute of Great Britain and Ireland. Occasional papers, No. 6 [London, 1924]).
- Genouillac, Telloh* GENOULLAC, HENRI DE. Fouilles de Telloh. I. Époques présargoniques. II. Époques d'Ur III^e dynastie et de Larsa (Paris, 1934-36).
- Ghirshman, Sialk I* GHIRSHMAN, ROMAN. Fouilles de Sialk, près de Kashan, 1933, 1934, 1937 I (Paris. Musée du Louvre. Département des antiquités orientales. Série archéologique IV [Paris, 1938]).
- Gimilsin Temple* FRANKFORT, H., LLOYD, SETON, and JACOBSEN, THORKILD. The Gimilsin Temple and the Palace of the Rulers at Tell Asmar (*OIP* XLIII [1940]).
- Heinrich, Fara* HEINRICH, ERNST. Fara; Ergebnisse der Ausgrabungen der deutschen Orient-Gesellschaft in Fara und Abu-Hatab 1902/03 (Berlin, 1931).
- ILN* The illustrated London news (London, 1842——; New York ed.).
- JNES* Journal of Near Eastern studies (Chicago, 1942——).
- Kish IV* WATELIN, L. CH., and LANGDON, S. Excavations at Kish IV (Paris, 1934).
- Kleinfunde* HEINRICH, ERNST. Kleinfunde aus den archaischen Tempelschichten in Uruk (Deutsche Forschungsgemeinschaft, Berlin. Ausgrabungen . . . in Uruk-Warka I [Leipzig, 1936]).
- Mackay, Kish "A"* MACKAY, ERNEST. Report on the excavation of the "A" cemetery at Kish, Mesopotamia, and A Sumerian palace and the "A" cemetery at Kish, Mesopotamia (Field Museum of Natural History. Anthropology, Memoirs I 1-2 [Chicago, 1925-29]).
- Mackay, Jemdet Nasr* MACKAY, ERNEST. Report on excavations at Jemdet Nasr, Iraq (Field Museum of Natural History. Anthropology, Memoirs I 3 [Chicago, 1931]).
- Mém.* France. Délégation en Perse. Mémoires (Paris, 1900——).
- MJ* Pennsylvania. University. University Museum. The museum journal (Philadelphia, 1910——).
- More Sculpture* FRANKFORT, H. More sculpture from the Diyala region (*OIP* LX [1943]).
- OIC* Chicago. University. The Oriental Institute. Oriental Institute communications (Chicago, 1922——).
- OIC* No. 16 FRANKFORT, H. Tell Asmar, Khafaje, and Khorsabad. Second preliminary report of the Iraq Expedition (1933).
- OIC* No. 19 FRANKFORT, H. Oriental Institute discoveries in Iraq, 1933/34. Fourth preliminary report of the Iraq Expedition (1935).

- OIC* No. 20 FRANKFORT, H. Progress of the work of the Oriental Institute in Iraq, 1934/35. Fifth preliminary report of the Iraq Expedition (1936).
- OIP* Chicago. University. The Oriental Institute. Oriental Institute publications (Chicago, 1924—).
- OIP* XLIII See *Gimilsin Temple*.
- OIP* XLIV See *Sculpture*.
- OIP* LIII See *Temple Oval*.
- OIP* LVIII See *Pre-Sargonid Temples*.
- OIP* LX See *More Sculpture*.
- OIP* LXI BRAIDWOOD, ROBERT J., and BRAIDWOOD, LINDA S. Excavations in the Plain of Antioch. I. The earlier assemblages (in preparation).
- Pre-Sargonid Temples* DELOUGAZ, PINHAS, and LLOYD, SETON. Pre-Sargonid temples in the Diyala region (*OIP* LVIII [1942]).
- RA* Revue d'assyriologie et d'archéologie orientale (Paris, 1884—).
- SAOC* Chicago. University. The Oriental Institute. Studies in ancient oriental civilization (Chicago, 1931—).
- SAOC* No. 23 McCOWN, DONALD E. The comparative stratigraphy of early Iran (1942).
- Sculpture* FRANKFORT, H. Sculpture of the third millennium B.C. from Tell Asmar and Khafājah (*OIP* XLIV [1939]).
- Starr, Nuzi* STARR, RICHARD F. S. Nuzi. Report on the excavations at Yorgan Tapa near Kirkuk, Iraq, conducted by Harvard University in conjunction with the American Schools of Oriental Research and the University Museum of Philadelphia, 1927-31. I. Text. II. Plates and plans (Cambridge, Mass., 1939 and 1937).
- Temple Oval* DELOUGAZ, PINHAS. The Temple Oval at Khafājah (*OIP* LIII [1940]).
- Tépé-Giyan* CONTENAU, GEORGES, and GHIRSHMAN, ROMAN. Fouilles du Tépé-Giyan, près de Néhavend, 1931 et 1932 (Paris. Musée du Louvre. Département des antiquités orientales. Série archéologique III [Paris, 1935]).
- UE* Joint Expedition of the British Museum and of the Museum of the University of Pennsylvania. Ur excavations (London, 1927—).
- UE* I HALL, H. R., and WOOLLEY, C. L. Al-Ubaid (1927).
- UE* II WOOLLEY, C. L. The royal cemetery (1934).
- UVB* Deutsche Forschungsgemeinschaft, *Berlin*. . . Vorläufiger Bericht über die von der Notgemeinschaft der deutschen Wissenschaft in Uruk-Warka unternommenen Ausgrabungen. Philos.-hist. Klasse. Abhandlungen (Berlin, 1930—).
- WVDOG* Deutsche Orient-Gesellschaft, *Berlin*. Wissenschaftliche Veröffentlichungen (Leipzig, 1900—).
- WVDOG* XXXIX ANDRAE, WALTER. Die archaischen Ishtar-Tempel in Assur (1922).

I

A SYSTEM OF POTTERY CLASSIFICATION

POTTERY IN ARCHEOLOGICAL RESEARCH

THE remains of earthenware vessels scattered on the surface of innumerable mounds in the Near East must have been associated since time immemorial by successive generations of local inhabitants with ruined and abandoned earlier settlements. However, since of all products of human industry there is hardly one of less material value than broken pottery, it is not surprising that potsherds failed to attract special attention until modern times, when new and wider concepts of history and the emergence of archeology as a science focused the interest of explorers and excavators on these humble remains, which gradually came to be considered of fundamental importance in archeological research.

Several factors and characteristics combine to contribute to the paramount importance of pottery in archeology. The potter's craft being one of the most widespread, ancient, and persistent of human crafts, using the most accessible of raw materials—earth and water—its products abound wherever traces of ancient civilizations are encountered. The brittleness of earthenware makes it difficult for ordinary vessels to remain whole and in use for any considerable length of time, but the chemical stability and the lack of intrinsic value of the materials as such help to preserve most of the broken vessels at the localities where they were manufactured and used. Consequently pottery, more than any other class of objects, is likely to remain in its proper archeological context. The constant need for new vessels to replace broken ones and the fact that the raw material, while cheap, imposes little restriction on the craftsman in his choice of form and decoration make his product susceptible to change of fashion, taste, or tradition, reflecting the significant developments in the contemporary material culture.

Among the 19th century's archeological pioneers in Western Asia we believe Loftus was the first to recognize and clearly express the value of pottery for dating purposes,¹ though it seems that neither he nor any of his contemporaries attempted to make use of this recognition. In time, however, the archeological value of pottery became more generally accepted and has, in fact, been repeatedly defined and discussed with various degrees of competence, clarity, and eloquence.² Simultaneously the keeping of methodical records of even ordinary household pottery found at ancient sites gradually came to be considered as a necessary routine in all archeological excavations or explorations under scientific auspices. Thus not only is the value of pottery generally recognized nowadays, but (as in many other instances when a new and potent medium of research is discovered, be it in the realm of abstract ideas or in the sphere of physical phenomena) the limits of its usefulness are not infrequently exaggerated. For example, far-reaching theories concerning cultural and ethnic movements have been based by some archeologists on pottery evidence that seems to others extremely flimsy or entirely irrelevant. From this point of view Frankfort's assertion that "the abuse of ceramic evidence considerably surpasses its use"³ is hardly disputable. Such abuses cannot detract, of course, from

¹ "The invention of the potter appears to have been racked in designing new forms, and their endless variety throughout Chaldaea may eventually prove of much use in determining the age of the ruins where each occurs" (W. K. Loftus, *Travels and Researches in Chaldaea and Susiana* [New York, 1857] p. 201).

² See e.g. the very clear formulation of the subject by John L. Myres in *Cambridge Ancient History* I (2d ed.; Cambridge, 1928) 69–71.

³ Frankfort, *Studies* I iii.

the objective value of pottery as a medium of archeological research. Nor is the ultimate correctness or incorrectness of a theory the sole criterion by which its scientific value is to be judged; for it is a commonplace that a working theory depends on the factual evidence available at any stage of knowledge, and it is therefore to be expected that with the increase of such evidence theories will be modified or even fundamentally revised. As to controversial theories resulting from various interpretations of the same facts, their comparative merits can best be judged when the principles of interpretation on which each is founded are clearly determined.⁴ However, the first concern of an excavator, regardless of his preferences in interpretations and theories, is to present the facts concerning his finds as completely and accurately as possible. This entails not only adequate recording in the field but also a system classification that will make the recorded material easily accessible for comparative studies. The more extensive and varied the material, the more imperative the adoption of a method of classification becomes. It is with the principles of such a system that we now propose to deal.

BASES FOR POTTERY CLASSIFICATION

While any system of classification is to some extent arbitrary, the general character of the one to be chosen must be predetermined by its probable use. In our case, the nature of probable comparative studies of pottery has to be considered.

There are two distinct points of view from which such studies can be undertaken; one may be termed "geographical," the other "stratigraphical." The first, which is concerned mainly with the comparison of material from different geographical regions, was more commonly undertaken in the earlier stages of Near Eastern archeology and is still of fundamental importance in works of general character. In this type of study conclusions are reached mainly on the basis of *similarities* which are considered relevant. In the second type of study the aim is to differentiate between the pottery of various strata in the same locality in order to obtain a basis for comparative dating and to trace, whenever possible, the development of pottery types from earlier into later times. Consequently it is necessary to pay attention to more subtle, less clearly defined details. The important characteristic of such a study in contrast with the first type is that it emphasizes *dissimilarities*.

An archeological report dealing with pottery from a single site, or even, like the present volume, with pottery from a few sites within one region, presents no serious geographical problems, while the elucidation of the stratigraphic problems is usually one of its principal aims. Consequently, the method of classification employed should be directed not so much toward grouping together related types of pottery as toward providing a basis for distinguishing and identifying various degrees of dissimilarity among them.

Having thus determined the general character of the system required, we must choose a set of features to serve as a basis for classification. The characteristics by which pottery vessels can be distinguished may be divided into four major groups: (a) material, (b) technique of manufacture, (c) surface finish, including decoration, and (d) form.

MATERIAL

By "material" we mean the physical and chemical properties of the finished product, which vary, of course, according to the quality of the clay used, the process of purification or levigation employed, the impurities accidentally or purposely added to the raw paste, and the method of firing. Even though under some circumstances the combination of these elements is such as to produce very distinct results which may be characteristic for certain regions or

⁴ An illuminating discussion of pottery interpretation, i.e., of the various characteristics which are significant in the comparative study of pottery, is to be found *ibid.* pp. 1-21, even though later discoveries have caused Frankfort to modify some of the views expressed there.

periods, it is apparent that within restricted regions, where the same sources of clay and the same methods of paste preparation and firing were generally used for considerable lengths of time, the variations discernible in the material are not sufficient to provide a basis for a classification that will answer our purpose.

TECHNIQUE OF MANUFACTURE

From the point of view of the technique of their manufacture, pottery vessels can be divided into hand-fashioned, hand-turned, wheel-turned, and mold-made.

The first group includes all vessels that were fashioned by hand in such a manner as to result in perceptible asymmetry. A certain number of distinct processes come under this term, but since they are not easily distinguishable in the final product they need not be enumerated here. In the second group we include all vessels which were turned in the process of being fashioned but not on a precisely centered apparatus. Some of the more carefully manufactured vessels of this group are not easily distinguishable from those of the wheel-turned group. The latter includes vessels fashioned on a well centered turning apparatus, that is, on some sort of potter's wheel. A common property of such vessels is that their horizontal sections are circular; the centers of these sections form a straight line which is the vertical axis of the vessel and which coincides with the axis of the wheel while the vessel is being fashioned. Many types of potters' wheels are known, but only those varieties which can be traced in their effects on the final product, such as the slow wheel versus the fast wheel, interest us. Other distinctions which are occasionally made in archeological publications, such as those between wheels turned by hand or by foot and speculations as to whether a wheel was weighted or turned by an assistant, would be of some interest in a monograph dealing with the history of this important tool but are irrelevant for our purpose. Mold-made vessels are extremely rare among early Mesopotamian pottery and are mentioned here only for the sake of completeness.

A combination of various ways of manufacture may occasionally be found in one vessel. For instance, the body of a vessel may be wheel-turned, while its base or its accessories, such as spout and handle, may have been fashioned by hand or made in a mold.

It is clear that although the mode of manufacture is an important feature of each vessel, the possible variations are not numerous enough to afford a basis for a detailed classification.

SURFACE FINISH AND DECORATION

Much more satisfactory results can be obtained by basing a classification on the character and appearance of the surfaces of vessels. Indeed, most of the existing comparative studies of pottery are based on the various themes and styles employed in decoration. However, such a basis of classification would exclude all plain vessels, which in many instances are in the vast majority, if not the only ones available for study. Thus we come to the last group of pottery characteristics, namely the forms of vessels.

FORM

Form is not only a property inherent in all vessels without exception but also one whose "endless variety"⁵ affords an adequate basis for detailed classification.⁶ It has rightly been pointed out that form is the "most essential feature, as it is directly dependent on the use which is to be made of the vessel, and which is the reason for its existence."⁷ Furthermore, the

⁵ See Loftus, *loc. cit.*

⁶ Needless to say, this applies only to those vessels of which enough remains to enable us to restore their original shapes with some degree of accuracy. The usefulness of "shapeless" potsherds, which is by no means negligible in normal archeological research, is obviously restricted to the study of material, manufacture, and surface finish or decoration.

⁷ Frankfort, *Studies* I 12.

form of a vessel is determined not merely by utilitarian and technical considerations; it also reflects, to no small extent, tradition and aesthetic preference, which are among the most important elements of all ancient civilizations.

CLASSIFICATION AND DESIGNATION OF FORMS

The acceptance of form as the main basis for pottery classification raises two problems. The first is how to divide the innumerable variety of forms into well defined groups, and the second is what system of designation to employ for specifying them. Various attempts have been made in both directions, mostly in dealing with comparatively small quantities of pottery. However, the methods evolved are not entirely satisfactory, especially for large groups, which continue to grow with new discoveries and thus, theoretically at least, can be considered as unlimited. Such commonly employed terms as "jug," "jar," "cooking-pot," "saucer," "plate," etc. are not only limited in number far below the need but can be misleading since they may imply knowledge of the use—often doubtful—to which any given vessel was put. Designation by letters or numerals has been adopted in some cases. But, while adequate in number and not implying specific use, this method is purely arbitrary and lacks any logical relationship between designation and form. The latter defect can be eliminated by use of a system of designation by decimal numbers somewhat similar to that devised by Dewey for library classification.⁸ In such a system a definite meaning can be attributed to each of the symbols used, and it has the further advantage of allowing for insertion of new numbers when the need arises. The only requisite for such a system is the division of a theoretically unlimited number of objects (books in one instance, pottery forms in our case) into ten major groups, each of these into ten subgroups, etc.

Our definitions of the ten major groups of pottery shapes are based on the geometric elements which form the actual receptacles. Such features as openings, bases, handles, spouts, etc., which, of course, also affect the general appearance of a complete vessel, are not yet taken into account. Moreover, inasmuch as turned vessels constitute the vast majority of the pottery with which we are concerned, we may base our analysis chiefly on the geometric properties of wheel-turned utensils. Hand-turned vessels, that is, those fashioned on an imperfect wheel, may be regarded in principle as approximating those manufactured on a true wheel, the only difference being in the degree of regularity.

Every wheel-turned utensil may be considered as consisting of an infinite number of superimposed extremely thin rings whose centers lie on a straight line which is the vertical axis of the finished vessel and which coincides with the axis around which the wheel revolves while the vessel is being shaped. The manner in which the radii of these rings vary with the height produces the distinct shape of each utensil.⁹ For instance, a vessel in which all the rings are of equal radii is cylindrical; if the radii increase proportionally to the height, the vessel is conical and tapers toward the base; if, on the contrary, the radii decrease in direct proportion to the height, the vessel is also conical but tapers toward the opening. When the radii of these infinitely thin rings increase or decrease otherwise than in direct proportion to the height, the walls of the vessel are curved inward or outward in various ways.¹⁰ Naturally the variation of the radii with the height may change abruptly at various points, thus producing in one vessel combinations of some or all of the above-mentioned geometric characteristics. In other words, the shape of a turned vessel may be considered as consisting of approximately cylindrical,

⁸ See Melvil Dewey, *A Classification and Subject Index for Cataloguing and Arranging the Books and Pamphlets of a Library* (Amherst, 1876).

⁹ I.e., the vertical contour is determined by the function $r = f(h)$.

¹⁰ In the first case the curvature is positive, in the second negative.

conical, and inward- or outward-curving surfaces. These geometric elements and their various combinations may, therefore, serve as a basis for classification of the great majority of pottery forms.

Pottery vessels which have other than circular horizontal sections are classified on a different principle (see p. 10).

The characteristics of a vessel's shape can be conveniently examined in adequate graphic records, to which, indeed, one is limited in publication. The most important of such records is a schematic drawing, the simplest being a vertical projection of the contours of the vessel on a plane.¹¹ However, since this method fails to record the thickness of the walls and the interior contours, a somewhat more elaborate graph representing half of a vertical section of the vessel, passing through its axis, is commonly used. Naturally any convenient scale can be employed, but for purposes of comparison it is preferable to use the same scale for as large a group of vessels as possible.¹²

DEFINITION OF TEN MAJOR GROUPS

We may now proceed to divide all pottery forms into ten major groups marking each group by a digit, from 0 to 9. The selection of the particular form to be designated by each numeral

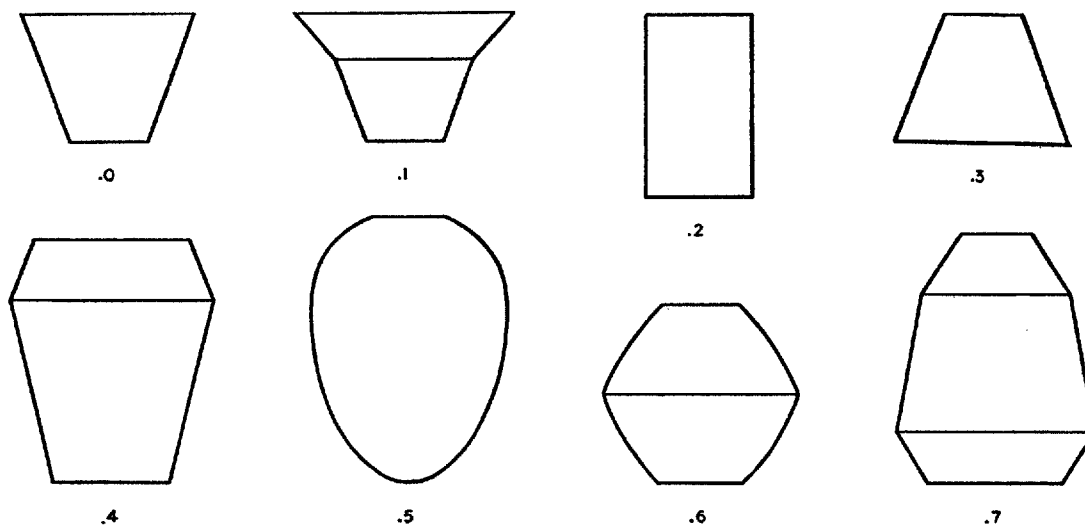

FIG. 1.—SCHEMATIC FORMS CHARACTERIZING GROUPS .0 TO .7 OF THE TEN MAJOR DIVISIONS OF POTTERY FORMS

is an arbitrary matter. This being so, we preferred not to deviate greatly from a general principle established by Petrie, namely, the division of pottery into groups starting "from the most open, such as shallow saucers, to the most closed, such as bottles."¹³ In this preference we were guided not only by our appreciation of Petrie's great contributions to the methodical study of pottery, but also by consideration of the fact that his principles are often followed, whether explicitly or not, by other archeologists. We consequently define the ten major groups as follows (the first eight are characterized by the shapes shown in Fig. 1):

- .0 open vessels tapering toward the base
- .1 vessels consisting of a combination of two open elements both wider at the top than at the bottom

¹¹ Used e.g. in Petrie, *Corpus of Prehistoric Pottery and Palettes*.

¹² For the scales employed in the present publication see p. 26.

¹³ Petrie, *op. cit.* p. 5.

- .2 vessels the whole or the main elements of which approach cylindrical forms
- .3 vessels approximating conical shapes and tapering toward the opening (reverse of .0) and vessels consisting of combinations of two conical elements joined at their narrower parts
- .4 vessels composed of two unequal elements joined at their wider parts, the center of gravity being nearer the opening than the base
- .5 vessels similar to those of the previous group but with the angle between the two elements (body and shoulder) less marked and vessels approaching an ovoid, tapering toward the bottom
- .6 vessels which may in general be considered as being composed of two elements of group .0 joined at their wider parts but which (in contrast to groups .4 and .5) show no marked difference in height between the two elements and are thus more nearly symmetrical, the center of gravity being near the middle
- .7 vessels composed of two or three elements, which may merge into an ovoid but in all cases have the center of gravity of the whole nearer the base than the opening
- .8 vessels with non-circular horizontal sections (i.e., vessels that were not turned, though parts of them may have been so made and joined together)
- .9 vessels in the form of objects (models) or imitating organic forms (vegetal or animal) and unusual combinations

DETAILED AND ABBREVIATED CLASSIFICATIONS

It is clear that definition of the ten major groups is but the first step in building up our system of classification, for each of these groups is only a theoretical approximation—a frame, as it were, into which some actual pottery shape will fit more closely than into others, without necessarily coinciding with it in its entire outline. (This is literally true of the contours shown in Figure 1.) On the basis of these general definitions a system can be developed in one of many ways. Theoretically it is possible to divide each group into ten subgroups, which in turn can be divided independently, and so on indefinitely, as need may be. Such procedure would preserve the main advantage of the decimal system, that is, the possibility of inserting an infinite number of new forms between any two already defined. In practice, however, one has to consider the increasing difficulty of memorizing such independently defined subdivisions, the distinctions between which would become less and less marked with each further step, and the possibility that the designations would become too long and unwieldy. It seems preferable therefore to limit the number of symbols contained in the designations in accordance with practical requirements and to attribute a definite meaning to each of the successive digits so that in all designations digits in the same position will represent the same characteristic.

For very general purposes, such as the compilation of a complete corpus of pottery from a large region or the classification of large and varied museum collections, a detailed classification, employing a main designation with twelve or more symbols as well as additional composite markings (see pp. 19–22), can be used. For dealing with our own material, however, we have devised an abbreviated classification which we trust will meet the ordinary requirements of most archeologists. The designations employed in it consist of seven symbols—a letter and six digits. The subdivision of each of the ten major groups of forms and the definitions of the various symbols given below apply to this abbreviated classification. As to a more complete form of our system, we indicate (in reduced type) only the main lines along which it might be developed, since a detailed exposition would be outside the scope of the present publication.

SUBDIVISION OF TEN MAJOR GROUPS

The subdivision of the major groups described below can be followed in Table I.

.0

The first major group is subdivided as follows:

- .00 regular conical with pronounced taper
- .01 regular conical with slight taper¹⁴
- .02 open with negative vertical curvature
- .03 open with positive vertical curvature and oblique walls
- .04 vessels with positive vertical curvature, the upper part of the walls approaching the perpendicular
- .05 vessels with positive vertical curvature and incurving upper part
- .06 combinations of .02 as lower part and .03, .04, or .05 as upper part
- .07 combinations of .03 or .04 as lower and .00, .01, or .02 as upper part
- .08 corrugated or sinuous vessels of conical shape
- .09 other shapes coming under the general definition of group .0

.1

The second major group is subdivided according to the various combinations of forms described under .0:

- .10 combinations of .00's, .00's and .01's, or .01's in which the angle of inclination of the upper part is greater than that of the lower
- .11 combinations of .00's, .00's and .01's, or .01's in which the upper part is nearer the vertical than the lower
- .12 combination of .02's, the upper part being the wider
- .13 combinations of .03's, .03's and .04's, or .04's, the upper part being the wider
- .14 combinations of .03, .04, or .05 as lower and .01 or .02 as upper part
- .15 combinations of .00's, .00's and .01's, or .01's in which the bottom of the upper part is wider than the top of the lower part
- .16 all possible combinations of .00's, .01's, and .02's in which the bottom of the upper part is narrower than the top of the lower part
- .17 combinations of .05 as lower and .00, .01, .02, or .03 as upper part
- .18 combinations of .08 as lower and .00, .01, .02, .03, or .08 as upper part
- .19 unspecified shapes falling under the general definition of group .1

.2

This group, containing vessels the whole or the main element of which is or approaches a cylinder (see p. 24), is subdivided as follows:

- .20 regular cylinder
- .21 corrugated cylinder

¹⁴ Arbitrarily we assign to the first (.00) group vessels in which the ratio of the difference between the maximum and minimum diameters to the total height is more than $2/5$, and to the second group (.01) those vessels in which this ratio is equal to, or less than, $2/5$. In other words, a being the maximum diameter, b the minimum diameter, and h the height, we have $(a-b)/h > 2/5$ for the first group, and $(a-b)/h \leq 2/5$ for the second group. Since this ratio depends on the inclination of the vessel's walls, our definition of the two groups simply means that the first group contains all vessels of which the angle of inclination from the vertical, α , is such that $\tan. \alpha > 0.2$; i.e., $\alpha > 11^\circ 18' 36''$, and the second group contains all vessels in which the angle of inclination is smaller. A way of determining without resorting to calculation to which of these two groups a vessel belongs is described below (p. 14, n. 18).

- .22 slightly convex (barrel-shaped)
- .23 slightly concave (spool-shaped)
- .24 tapering at the base and flaring at the opening
- .25 combinations of .20 as lower and any of group .0 or .1 as upper part
- .26 two cylindrical elements (.20-.23) the upper of which is the wider
- .27 two cylindrical elements the upper of which is the narrower
- .28 combinations of a cylindrical element as upper and .30, .31, .32, or .33 as lower part
- .29 unspecified forms falling under the general definition of group .2

.3

Four subgroups of this group are reserved for conical vessels tapering toward the opening and five for vessels consisting of two conical elements joined at their narrower parts:

- .30 reverse of .00 or .01, that is, a fairly regular conical shape tapering toward the opening
- .31 reverse of .03, .04, or .06
- .32 reverse of .02 or .07
- .33 reverse of .08 and of any form of group .1
- .34 combinations of two truncated conical shapes, .30 and .00, joined at their narrower bases (usually the lower, .30, being the taller)
- .35 similar combinations with .32 as lower and .02 as upper part
- .36 similar combinations of .30 or .32 as lower and any of the rest of .0 as upper part
- .37 combinations of .31 as lower and .00, .03, or .04 as upper part
- .38 combinations of .31 as lower and .02, .06, or .07 as upper part
- .39 unspecified shapes coming under the general definition of group .3

.4

Of the two elements forming vessels of this group the lower (body) is usually one of the forms coming under group .0, while the upper (shoulder) is normally one of the first four subgroups in .3; the subgroups are defined by the various combinations of such elements:

- .40 body .00 or .01, shoulder .30, with a wide angle between them
- .41 same as .40 but with a sharper angle between body and shoulder
- .42 body .02, .07, or .12, shoulder .32
- .43 body as in .42, shoulder .30 or .31
- .44 body .03 or .04, shoulder .32
- .45 body .00 or .01, shoulder .31
- .46 body .03 or .04, shoulder reverse of .08
- .47 body .08, .12, .13, or .14, shoulder reverse of same
- .48 corrugated vessels of approximately ovoid shape
- .49 vessels consisting of more than two distinct conical elements

.5

The upper element (shoulder) of vessels in this group is nearly always of shape .31, and the differentiation between the various subgroups is based mainly on the shape of the lower part (body) and on the manner in which the two are joined:

- .50 body .03, shoulder .31, with a fairly wide angle between them (steep shoulder)
- .51 same as .50 but with a sharper angle between body and shoulder

- .52 body .04, shoulder .31
- .53 body and shoulder joined without producing a marked angle, body tapering rather sharply toward base
- .54 same as .53 except that body tapers less sharply
- .55 same as .53 and .54, with a less pronounced taper and no distinct line of separation between lower and upper parts
- .56 same as .53, .54, or .55 except that the shoulder is flat, approaching the horizontal near the opening
- .57 lower part .06, upper part .31, with no definite line of separation between them
- .58 similar to .57 with lower part widening near base
- .59 pear-shaped with wider part up

.6

The subdivision of this group is based both on the form of the elements and on the manner in which they are joined:

- .60 two nearly equal parts whose forms may vary from .00 to .04, with the upper element upside down
- .61 lower part .00, .02, or .07, upper part .31 (i.e., reverse of .03, .04, or .06)
- .62 lower part .03 or .04, upper part .32
- .63 more than two elements, the lower and upper belonging to group .0 or reverse and the middle part being any one of the first four shapes in group .2
- .64 ellipsoidal (including spherical) with wide opening¹⁵
- .65 same as .64 with medium opening¹⁵
- .66 same as .64 with narrow opening¹⁵
- .67 ellipsoidal, narrowing fairly symmetrically toward base and opening (combination of .06's)
- .68 ellipsoidal element combined with one of the first four shapes of group .3
- .69 combination of two ellipsoidal elements

.7

Since vessels assigned to this group usually consist of the same elements as those in groups .4 and .5, the only difference being that now the center of gravity is nearer the base, they can be defined in terms of corresponding shapes in those groups:

- .70 reverse of .40, .41, or .49
- .71 reverse of .43
- .72 reverse of .42
- .73 reverse of .44
- .74 reverse of .50, .51, or .52
- .75 reverse of .54 or .55
- .76 reverse of .53 or .56
- .77 reverse of .57
- .78 reverse of .58
- .79 reverse of .59

¹⁵ Wide, medium, and narrow openings are arbitrarily defined as follows: wide opening, with diameter more than .7 of maximum diameter of vessel; medium, with diameter between .4 and .7 of maximum diameter; narrow, less than .4 of maximum diameter. A simple way of determining these groups without resorting to calculation is described below (pp. 15f.).

.8

Vessels belonging to this group, being characterized by their noncircular horizontal sections, are subdivided according to the contours of these sections, which are usually taken at the maximum width of the vessel:

- .80 horizontal section ellipse or combination of two equal circular or elliptical elements
- .81 combination of two unequal circular or elliptical segments
- .82 any curve with one axis of symmetry
- .83 regular polygon or polygons with more than one axis of symmetry
- .84 polygon with one axis of symmetry
- .85 symmetrically fluted or ribbed
- .86 asymmetrical polygon or curve
- .87 like .86 but fluted or ribbed
- .88 multiple vessels (when possible designated according to shape of component vessels also)
- .89 other shapes falling under the general definition of group .8

.9

The last group is subdivided as follows:

- .90 models of implements
- .91 architectural models
- .92 vegetal forms
- .93 insect and reptile forms
- .94 fish forms
- .95 bird forms
- .96 quadruped forms
- .97 human forms
- .98 combinations of inorganic forms
- .99 other combinations

For purposes of more convenient immediate identification the above definitions are summarized graphically in Table I, in which each definition is represented by only one characteristic form. Each horizontal row represents a major group, and the corresponding cipher at the left is therefore the first digit of the identification mark. The second digit, by which any of the subgroups in a major group is identified, appears at the top of each vertical column.

It is to be seen that on the whole the subdivision of each of the ten major groups is independent, there being no general implication attached to the second digit. However, for the sake of simplicity an attempt has been made to associate the various shapes in the vertical columns whenever possible. For instance, in the third column form .12 consists of two elements of .02; .32 is the reverse of .02; .42 consists of two elements, one .02 and the other .32, while .72 in turn is the reverse of .42. Likewise, .77 is the reverse of .57; .79, the reverse of .59; etc.

PROPORTIONS

The most important distinction between the various shapes which correspond to any one of the above-defined subgroups is that of proportion. It is not sufficient, for instance, to denote a vessel as an ellipsoid, for this term includes both tall and squat ellipsoids; likewise a vessel identified as being of shape .07 may be a very shallow platter or a tall cup (Fig. 2). Thus the form of a vessel as identified by two digits remains vague unless its proportions are specified. The proportion most characteristic of any vessel is the ratio of its maximum height to its maximum width. It is clear that such ratios can vary indefinitely.

TABLE I

CHART OF THE TEN MAJOR GROUPS OF POTTERY FORMS AND THEIR SUBDIVISIONS

	0	1	2	3	4	5	6	7	8	9
0										
1										
2										
3										
4										
5										
6										
7										
8							ASYM-METRICAL POLYGON OR CURVE	SECTION AS IN 86 BUT ALSO FLUTED OR RIBBED	MULTIPLE VESSELS	OTHER COMBINATIONS
9	IMPLEMENT MODELS	ARCHITECTURAL MODELS	VEGETAL FORMS	INSECT AND REPTILE FORMS	FISH FORMS	BIRD FORMS	QUADRUPED FORMS	HUMAN FORMS	COMBINATIONS OF INORGANIC FORMS	OTHER COMBINATIONS

In order to extend the decimal system of marking so as to designate the relation between height and width by a single digit it is necessary first to divide all possible ratios into ten groups and then to assign a digit to each. As a preliminary all theoretically possible forms are divided into two classes, "squat" and "tall." The first includes all forms in which the height is less than the width, the second all forms in which the height is equal to or more than the width. Each of these two classes is then subdivided into five groups. In the first class subdivi-

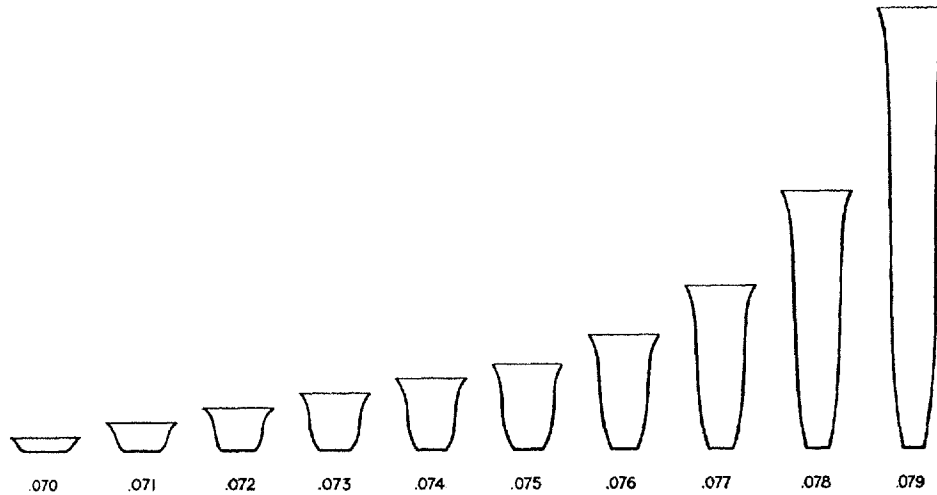

FIG. 2.—HYPOTHETICAL VESSELS OF SHAPE .07 REPRESENTING THE TEN MAJOR RATIOS BETWEEN MAXIMUM HEIGHT AND MAXIMUM WIDTH.

sion is based on the ratio of height to maximum width, and each of the five groups is marked by a digit, as follows:

- 0 height less than $1/5$ of maximum width
- 1 height $1/5$ up to $2/5$ of width
- 2 height $2/5$ up to $3/5$ of width
- 3 height $3/5$ up to $4/5$ of width
- 4 height $4/5$ up to $5/5$ of width

In the second class subdivision is based on the ratio of maximum width to height, and the groups are marked thus:

- 5 width more than $4/5$ up to and including $5/5$ of height
- 6 width more than $3/5$ up to and including $4/5$ of height
- 7 width more than $2/5$ up to and including $3/5$ of height
- 8 width more than $1/5$ up to and including $2/5$ of height
- 9 width equal to or less than $1/5$ of height

The greater the arithmetical value of the digit the greater the height of a vessel in proportion to its maximum width. The third digit in our abbreviated system of classification is thus used to indicate the relation between height and maximum width of a vessel.¹⁶

The above definitions are illustrated by the ten hypothetical vessels shown in Figure 2. They are all of shape .07 and identical in width, but they vary in height so as to fall into different proportion groups and are marked accordingly from .070 to .079.¹⁷ Theoretically any other

¹⁶ Except for forms .88, .89, and .9. In the case of multiple vessels (.88) the third digit indicates the number of parts.

¹⁷ It may be noted, by the way, that .078 and .079 are very close to forms .248 and .249.

general shape could replace .07 in this figure; thus, instead of any one definite shape we may simply examine a series of rectangles of the same width and varying heights (Fig. 3). The shaded areas in Figure 3 indicate the range of variation in height for each proportion group. In the first five rectangles these areas are equal, while in the last five the range increases very rapidly; indeed, in the tenth it extends from five times the width to infinity. This rapidly increasing range of heights in the last two groups is no great disadvantage in practice, for the taller the vessels, the less frequently they occur in reality; in fact, nearly all usable vessels are to be found in the first six or seven groups.

The digit denoting the proportion of any given vessel can, of course, be determined arithmetically. However, by using a very simple instrument designed by the writer for this purpose, all calculation can be avoided and the third digit can be read off directly from a graphic repre-

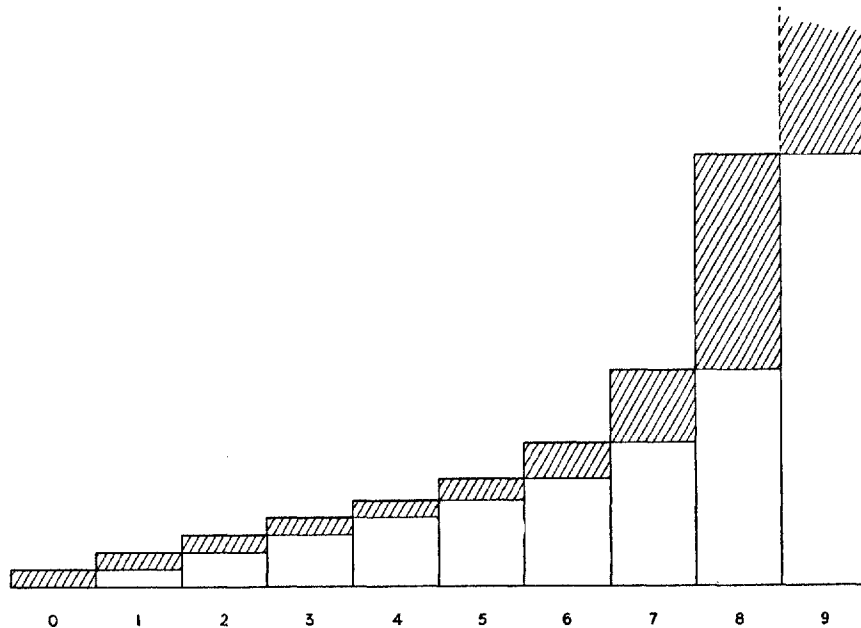

FIG. 3.—CHART SHOWING RANGE OF VARIATION IN HEIGHT FOR THE SAME WIDTH IN EACH OF THE TEN PROPORTIONAL GROUPS.

sentation of the height and width of a vessel marked, at any scale, on rectangular co-ordinates. The instrument (Fig. 4) consists of a transparent triangle on which there is drawn a smaller isosceles right triangle. The base and altitude of the latter are each divided into five equal parts, which are numbered; the division points on each side are connected with the opposite apex. A second set of lines (dotted) and figures (italic) is obtained by dividing the altitude into ten equal parts.

To determine the digit which denotes the proportion of a vessel the first set of lines and figures is employed. After the width and height are measured and marked at any convenient scale as abscissa and ordinate on rectangular co-ordinates, the triangle is placed with the side marked from 5 to 9 on the horizontal axis and the apex of the adjacent acute angle at right at the point marking the width. Now there are two possibilities: either the line connecting the points marking height and width will fall within the triangle, in which case the proper digit is that found beside the altitude of the triangle and applying to the segment within which the ordinate falls, or else this line will be outside the triangle. In the latter case the triangle has to be shifted so that the apex of its other acute angle is placed at the point marking the height of

the vessel and its altitude overlies the vertical axis; the required digit is that found along the base of the triangle and applying to the segment within which the abscissa falls. If one uses a schematic drawing of the vessel (see p. 5) instead of measurements obtained from the vessel itself, the digit representing proportion can be read off directly by inclosing the drawing in a rectangle, one side of which represents the maximum width and the other the height of the vessel (Figs. 5-6). After some practice the process can be further simplified by using only the lower right and the upper left corners of such an imaginary rectangle.¹⁸

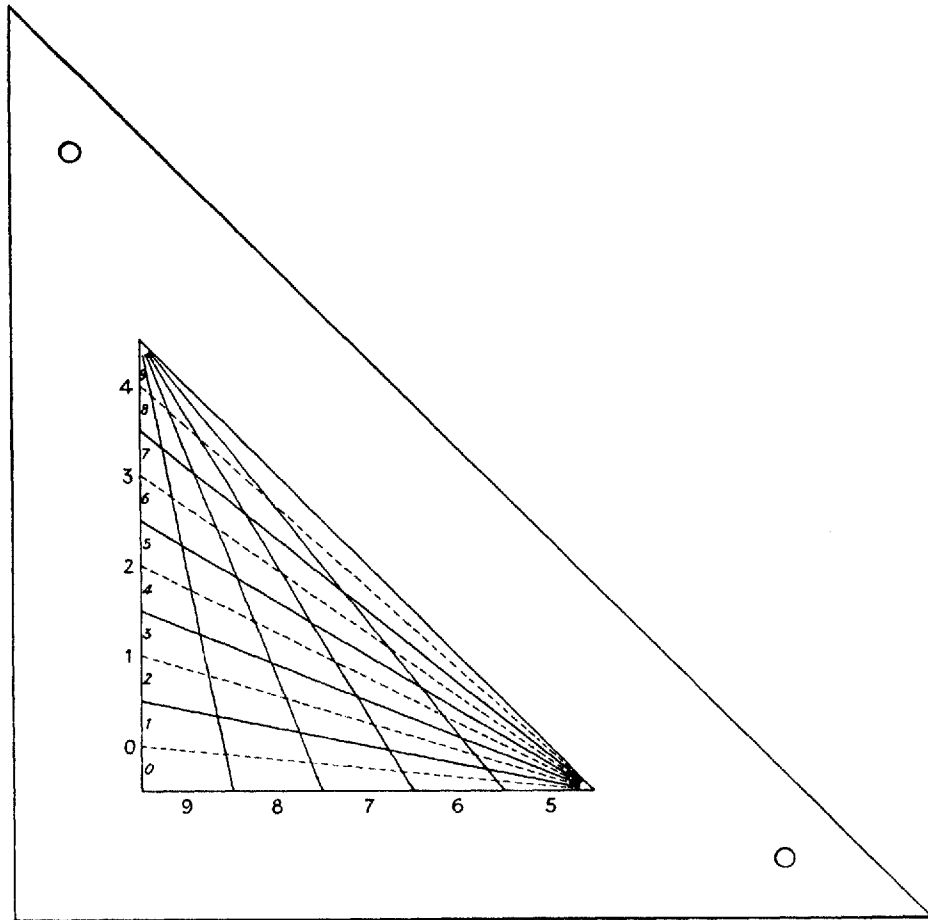

FIG. 4.—A SCALE FOR DETERMINING THE CIPHERS WHICH DENOTE THE VARIOUS PROPORTIONS OF ANY VESSEL

While the ratio of height to width alone is specified in our abbreviated classification it is but one of several significant proportions of a vessel. The position of the maximum width in relation to height, the proportion of the width of the opening to the maximum width, and the ratio between the length of the neck and the total height are other elements which affect the appearance of a vessel. This is illustrated by the two hypothetical vessels (*a* and *b*) shown in Figure 7, which are of the same general form (.57) and of identical height and width, that is, of the same general proportion (7), but nevertheless differ considerably in appearance. This difference is due almost entirely to variation in the secondary

¹⁸ The same instrument can be used for distinguishing between vessels of groups .00 and .01 (see p. 7). For this purpose the triangle has to be placed over a drawing of the vessel so that its upper vertex coincides with the upper left corner of the drawing and its perpendicular is parallel to the axis of the vessel. If the line representing the wall of the vessel falls between the perpendicular and the first line to the right of it (i.e., in section 9) or coincides with the latter, the vessel is of form .01. If the wall of the vessel falls to the right of that line, the vessel is of shape .00.

proportions; that is, the position of the maximum diameter is relatively lower in *a* than in *b*, and the opening is proportionately narrower and the neck shorter in the latter than in *a*.

Each of these secondary proportions also can be expressed by a single digit. For this purpose the larger of the two measurements is considered as a unit and the other as a decimal fraction of it. For instance, if the diameter at the mouth of the vessel is between 5/10 and 6/10 of its maximum diameter, the digit .5 will denote this proportion.

Secondary proportions can be read off by means of our instrument by using the second set of lines and digits (dotted and italic in Fig. 4) and a schematic drawing of the vessel inclosed in a rectangle.

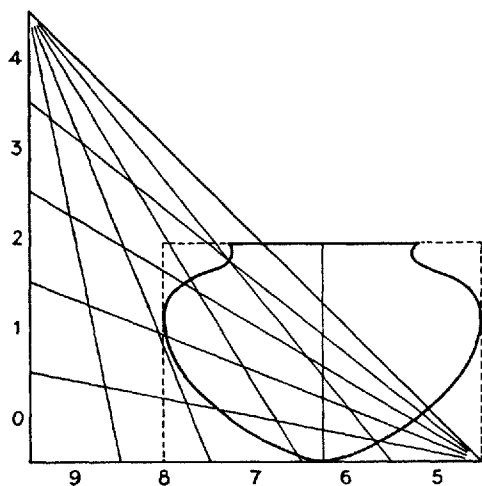

FIG. 5.—DIAGRAM ILLUSTRATING USE OF THE SCALE TO DETERMINE CIPHER DENOTING RATIO BETWEEN MAXIMUM HEIGHT AND MAXIMUM WIDTH.

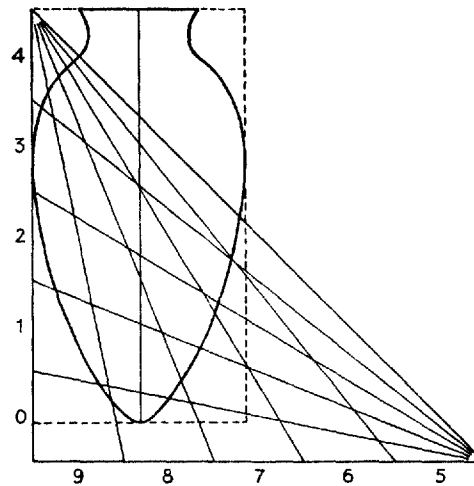

FIG. 6.—DIAGRAM ILLUSTRATING USE OF THE SCALE TO DETERMINE CIPHER DENOTING RATIO BETWEEN MAXIMUM HEIGHT AND MAXIMUM WIDTH.

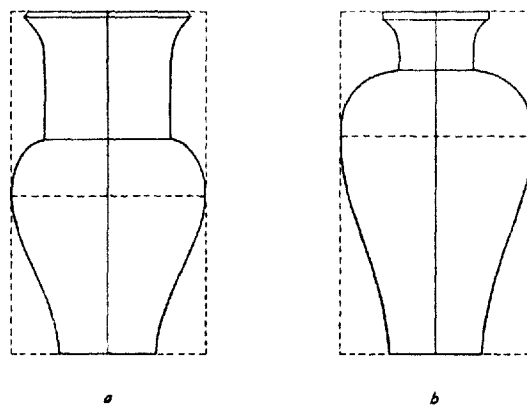

FIG. 7.—TWO HYPOTHETICAL VESSELS OF SHAPE .57 WITH THE SAME RATIO BETWEEN MAXIMUM HEIGHT AND MAXIMUM WIDTH BUT DIFFERING IN OTHER PROPORTIONS.

To determine the ratio between the width of the opening of the vessel and its maximum width we place the base of the triangle (marked from 5 to 9) on the axis of the vessel and slide the triangle up or down until the hypotenuse touches the left upper corner of the rectangle or, in other words, until the maximum radius of the vessel becomes an ordinate from a point on the hypotenuse (Fig. 8). If the width of the opening is less than the maximum width of the vessel, the point marking the opening will be found on this ordinate inside the triangle, and the division into which it falls will give the cipher repre-

senting the required proportion. Of course, if the maximum width of the vessel coincides with the width of its opening, both points will be on the hypotenuse and the digit will be 9.

To determine the digit denoting the position of the maximum diameter in relation to the height we still use the schematic drawing inclosed in a rectangle. At the point of maximum diameter ($m-m'$ in Fig. 9) the lines representing the walls of the vessel touch the sides of the rectangle.¹⁹ To read off the required cipher we place the base of the triangle on the base of the inclosing rectangle and slide the triangle along until the hypotenuse touches the upper left corner of the rectangle (Fig. 9); the cipher marking the division in which the point of maximum diameter falls is the required designation.

The same process will determine the relative length of body or neck if instead of the point of maximum diameter a point corresponding to the division between body and neck is marked on the rectangle ($n-n'$ in Fig. 9).²⁰

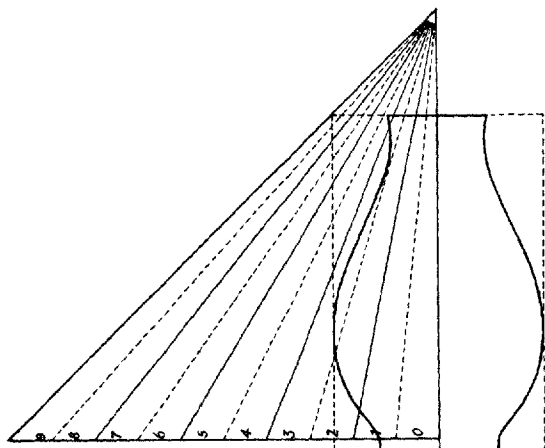

FIG. 8.—DIAGRAM ILLUSTRATING USE OF THE SCALE TO DETERMINE CIPHER DENOTING RATIO BETWEEN WIDTH OF OPENING AND MAXIMUM WIDTH OF A VESSEL.

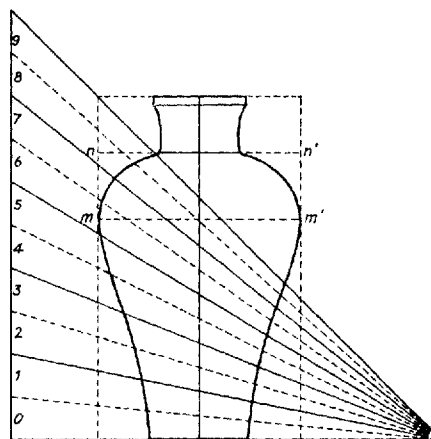

FIG. 9.—DIAGRAM ILLUSTRATING USE OF THE SCALE TO DETERMINE CIPHER DENOTING POSITION OF MAXIMUM DIAMETER IN RELATION TO HEIGHT OF A VESSEL.

For example, various proportions of the two vessels shown in Figure 7, which have the same ratio of width to height, are as follows:

	<i>a</i>	<i>b</i>
Major proportion.....	7	7
Ratio of width of opening to maximum width.....	8	5
Position of maximum diameter in relation to total height.....	4	6
Length of body in proportion to total height.....	6	8
Length of neck in proportion to total height.....	3	1

Secondary proportions may be usefully indicated in a more detailed classification (see p. 22), either explicitly, by introducing additional digits, or implicitly, by using the proportions as a basis for group definitions (as in the distinction between groups .64, .65, and .66, for instance).

ACCESSORIES

The appearance of a vessel is determined not only by the general form of the body and its proportions but also by the form of the base, by the character of the opening, and by such accessories as handles, spouts, etc. In our abbreviated system the fourth digit denotes the gen-

¹⁹ Vessels with multiple maximum or minimum diameters are disregarded for the present.

²⁰ The same process may be employed in determining relative position of the minimum instead of the maximum diameter (e.g. in vessels of form .35).

eral form of the base.²¹ The fifth and sixth digits indicate the presence or absence of certain accessories (see Table II).

BASE

- 0 open bottom
- 1 concave base
- 2 flat or discoid base
- 3 low ring
- 4 high ring
- 5 convex base
- 6 pointed base
- 7 knob, stump, or small foot
- 8 tall foot or pedestal
- 9 legs

In the detailed classification an additional digit can be used to denote more specifically the kind of base, thus making it possible to specify ten distinct varieties of each major type.

RIM,²² NECK, AND SHOULDER

The fifth digit indicates the character of the upper part of the vessel:²³

- 0 no rim, neck, or shoulder
- 1 rim only
- 2 neck only
- 3 shoulder only
- 4 rim and neck
- 5 rim and shoulder
- 6 neck and shoulder
- 7 rim, neck, and shoulder
- 8 unusual combinations of two features
- 9 unusual combinations of three features

In the fuller classification an additional digit can be reserved to mark ten variations of each of the above.

OTHER ACCESSORIES

The sixth digit indicates the kinds of accessories added to the body of the vessel:²³

- 0 none
- 1 handle(s)
- 2 tubular spout(s)
- 3 lug(s)
- 4 pouring beak(s) or lip(s)

Since the number of possible combinations of such features exceeds the remaining five ciphers, only the more commonly found combinations are indicated in the abbreviated system of classification:

- 5 handle(s) and spout(s)
- 6 handle(s) and beak(s)
- 7 spout(s) and lug(s)
- 8 lug(s) and beak(s)
- 9 any other combinations

²¹ Except for forms .88, .89, and .9.

²² A rim is defined here as an opening accentuated either by variation in thickness or by change of curvature.

²³ Except for forms .88, .89, and .9.

To facilitate the assignment of the correct ciphers in the marking of any shape we summarize the meanings of the successive digits in Table II.

TABLE II
DEFINITIONS OF THE DIGITS USED IN THE ABBREVIATED POTTERY CLASSIFICATION

	DIGIT					
	1ST	2D	3D	4TH	5TH	6TH
	Major Group	Subdi- vision	Relation of Height (H) and Maximum Diameter (D)	Base	Rim, Neck, Shoulder	Handle(s), Spout(s), Lug(s), Beak(s)
0	Conical	See Table I (p. 11)	$H < \frac{1}{2} D$	Open	None	None
1	Combinations of .0		$\frac{1}{2} D \approx H < \frac{1}{2} D$	Concave or "cup"	R	H
2	Cylindrical		$\frac{2}{3} D \approx H < \frac{2}{3} D$	Flat or disk	N	S
3	Reversed conical		$\frac{2}{3} D \approx H < \frac{1}{2} D$	Low ring	S	L
4	Combinations of .0 and .3		$\frac{1}{2} D \approx H < D$	High ring	R N	B
5	Ovoid, tapering down		$H \approx D > \frac{1}{2} H$	Convex	R S	H S
6	Symmetrical in ver- tical section		$\frac{1}{2} H \approx D > \frac{2}{3} H$	Pointed	N S	H B
7	Ovoid, tapering up		$\frac{2}{3} H \approx D > \frac{2}{3} H$	Knob, stump, or small foot	R N S	S L
8*	Noncircular in hori- zontal section		$\frac{2}{3} H \approx D > \frac{1}{2} H$	Tall foot or pedes- tal	Unusual combina- tions of two fea- tures	L B
9*	Models and organic forms		$\frac{1}{2} H \approx D$	Legs	Unusual combina- tions of three fea- tures	Any other combina- tions

* Only the first two digits as defined here apply to group .9 and to the last two subgroups of group .8 (.88 and usually .89).

SIZE

So far, in our analysis of the various elements which combine to produce the geometric character of a vessel, we have been concerned only with general form, relative proportions, and accessories and have disregarded absolute dimensions. It is clear, however, that size also is an important geometric feature of a vessel. It may happen, for instance, that a small cup is of exactly the same shape and general proportions as a vat of much greater volume. For purposes of comparative study it is obviously important to distinguish between them. In addition to classifying a given collection of pottery vessels according to the above-mentioned characteristics it is necessary, then, to divide them according to size. "Size," however, may be defined in various ways; and problems arise as to whether vessels should be classified according to height, width, or volume and also as to how precise a division is necessary and what number of groups one should adopt. Though such a division will be purely arbitrary, it is clear that for practical purposes the number of size-groups must not be too great. Moreover, since the objects with which we are dealing are not machine-made, the divisions should retain some elasticity so as to allow vessels which vary in size within a certain range but are similar in all other respects to come under the same group. On the basis of these considerations we have divided all pottery vessels into five groups, designated by the letters A to E, and defined them in general terms rather than by actual dimensions (but see p. 23).

A. The first group is reserved for miniature vessels, namely vessels which are too small to

have been used for ordinary household purposes. It may include toys, models, cosmetic containers, etc.

B. The second group is reserved for "table crockery," that is, for vessels which could have been used for serving food and drink, in other words, such vessels as cups, small dishes, saucers, etc., which can be conveniently held in one hand.

C. To the third group we ascribe all ordinary household utensils which are too big to be held easily in one hand but can be carried without effort in both hands, even if filled with such substances as water or grain.

D. The fourth group contains vessels too large to be conveniently handled by one person if even partly filled with water or grain.

E. The fifth group contains vessels which can be considered as immovable, either because of size or function. It includes vats, coffins, drains and other architectural fixtures.

In practice, doubtful cases will occur especially on the border lines. Some rules to follow in such cases are given on page 23.

The letter denoting size precedes the six digits previously defined. Points separate the groups of symbols denoting respectively general form and accessories. Thus in the abbreviated system a complete designation for a form is written, for instance, C.546.362. It should be noted that the order which we have chosen for grouping the various elements in these designations is fixed for practical reasons but is not imperative. Without changing the order it is still possible to classify vessels in a given group of pottery according to any one of these elements. For instance, by arranging vessels according to the first two digits we obtain a classification based on general form regardless of size. Similarly, if a collection is grouped according to the fourth digit we obtain a classification according to the type of base only. Should it be desirable to group together all spouted vessels, all that is required is to select those whose designations end in 2, 5, or 7.

Pottery records can be kept simultaneously in both the abbreviated and the fuller forms if the additional digits are written below the six digits of the abbreviated system, for example $\frac{C.587.862}{157.221}$. This permits also the omission of any of the additional digits without causing ambiguity. For example, one may use the denotation $\frac{C.587.862}{-5-.21}$, in which the lower figures further specify the proportions and the character of the neck and spout.

CLASSIFICATION AND DESIGNATION OF OTHER CHARACTERISTICS

Though the form of a vessel, analyzed in the previous pages, is its most fundamental feature, it is not always the most important one archeologically. It should be emphasized, therefore, that a *pottery form* as defined and designated above must not be confused with a *pottery type*. A *pottery type* is a group of specimens which come under one category, or a distinct single specimen, possessing, within certain limits, certain significant features. Form is only one of such features. As we have seen (p. 3), surface finish and decoration or even technical qualities of pottery may be very significant archeologically and consequently must often be considered in definitions of pottery types. This being so, it may be useful to outline a method by which such qualities can be classified and designated on principles similar to those employed for classification of forms.

SURFACE FINISH AND DECORATION

Again we may divide arbitrarily all possible surface finishes into ten groups, each of these into ten subgroups, etc.

The simplest and in some cases the most common group is plain uncoated pottery. When the surface of a vessel has been coated, either before or after baking, with a material whose chemical or physical

qualities differ from those of the main fabric, distinctions are possible according to materials used and according to whether the coating was uniform, whether it was intended to produce simply a decorative effect, or whether it was applied in definite designs. The division into ten major groups on the basis of surface coating may be done as follows:

- .0 plain, uncoated surface
- .1 all-over clay slip
- .2 all-over wash or paint
- .3 all-over glaze
- .4 partial slip, wash, or glaze
- .5 slip, wash, or glaze applied (or reserved) so as to produce a pattern
- .6 monochrome definite design on .0 or .1
- .7 monochrome design on or combined with .2, .3, or .4
- .8 polychrome design on .0 or .1
- .9 polychrome design with any other combination

Regardless of the coating, the surface of a vessel in any of the above-defined ten groups may have been finished or decorated by various means. Ten of the most commonly employed surface treatments and their symbols are listed below. The cipher by which each is marked would be the second digit in the denotation of the surface finish:

- .-0 no special finish
- .-1 hand-smoothed
- .-2 burnished or polished
- .-3 incised or excised
- .-4 relief or plastic decoration
- .-5 relief by mold or stamp
- .-6 polished and incised
- .-7 polished and decorated in relief
- .-8 incised and decorated in relief
- .-9 any other method or combination of methods

Combinations of the first two digits, indicating the type of surface coating and the finish, provide various possibilities, some of which are very common and others extremely rare.

Further subdivision can be carried on independently in each group; for instance, in group .03, which denotes uncoated and incised pottery, ten distinct manners of incision can be designated by an additional digit. Since monochrome- and polychrome-painted wares (groups .6 to .9) are of greatest interest to us, we reserve the third digit to denote color or combination of colors. One digit is, of course, insufficient to provide markings for a complete gamut of colors, and we must restrict ourselves to marking only ten commonly employed colors for the monochrome wares (groups .6 and .7) and ten common combinations used in polychrome wares (groups .8 and .9). For our pottery these could be as follows:

*Single Color*²⁴

- .-0 white
- .-1 ivory or cream
- .-2 yellow-buff
- .-3 dark yellow-orange
- .-4 scarlet-red
- .-5 purple-red
- .-6 brown-red
- .-7 brown
- .-8 gray
- .-9 black

²⁴ The same marks can be used to indicate the surface color of an undecorated vessel.

Combinations of Colors

- .--0 white to buff with yellow to brown
- .--1 white to buff with red
- .--2 white to buff with black
- .--3 yellow or brown with red
- .--4 red and black
- .--5 white to buff with red and brown
- .--6 white to buff with red and black
- .--7 white to buff with brown and black
- .--8 red, black, and brown
- .--9 other combinations

A further subdivision of painted wares can be made either according to the subject or motif of the design or according to style. The first, being somewhat less subjective, is perhaps preferable. Since similar motifs may produce quite different effects when executed in different styles, it is obvious that designs marked by similar designations may be quite distinct. Nevertheless, the similarity of motif may offer good ground for comparison, so that the difference in style, if any, will stand out more clearly.

To avoid confusion the ciphers marking surface finish and decoration should be distinguished from those denoting geometric shape. This distinction can be easily obtained by inclosing in brackets the mark indicating surface finish, thus introducing what may be termed a "composite marking."

PROVENIENCE AND DATE

The composite marking can be further extended to include other information. For instance, the provenience and date can be indicated by the marks employed in the Brussels system of library classification.²⁵ To distinguish them from the numbers marking the form or the surface finish of a vessel, they may be inclosed in parentheses and braces respectively.

PROVENIENCE

For geographical marking, some of the divisions and notations employed by Dewey²⁶ may be adopted.

Continents:

- (950) Asia
- (960) Africa

Countries in the Near East:

- (953) Arabia
- (954) India
- (955) Iran
- (956) Possessions of the former Ottoman Empire

The last in turn may be subdivided as follows:

- (956.3) Asia Minor
- (956.6) Armenia and Kurdistan
- (956.7) Mesopotamia
- (956.8) Syria
- (956.9) Lebanon, Jordan, and Israel

Again, Mesopotamia may be subdivided into smaller geographical regions:

- (956.71) Northern Mesopotamia
- (956.72) Assyria
- (956.73) The Kirkuk region
- (956.74) The central region east of the Tigris
- (956.75) Central Mesopotamia between the Tigris and the Euphrates
- (956.76) The Diyala region, east of the Tigris and up to the Persian foothills

²⁵ Institut internationale de bibliographie, *Classification décimale universelle* (Bruxelles, 1927-28) p. 7.

²⁶ Melvil Dewey, *Decimal Classification and Relativ Index* (14th ed.; 1942).

- (956.77) Babylonia proper
- (956.78) Southern Mesopotamia
- (956.79) The delta and sea coast

Further subdivision into still smaller regions may, of course, be carried out when necessary.

In Africa (960) the country of interest to us is Egypt (962), which may be divided as follows:

- (962.1) Lower Egypt
- (962.2) Middle Egypt
- (962.3) Upper Egypt

More specifically, one may mark, for instance, the following:

- (962.16) Heliopolis
- (962.23) Al-Fayyum
- (962.33) Luxor
- (962.36) Aswan.

DATE

For all practical purposes the date mark need not exceed four digits (since this allows us to mark any year, decade, century, or millennium from 9999 B.C. to A.D. 9999, a minus sign indicating B.C.). Either a precise or an approximate date can be given. If all four spaces are filled, the precise year is denoted. For instance, {1785} means A.D. 1785; {-1246} means 1246 B.C.; {-0700}, the year 700 B.C.; {1600}, the year 1600 after Christ; {-0016}, the year 16 B.C.; etc. Approximate dating in decades, centuries, or millennia can be marked by use of only three digits, two digits, or one digit. Thus, for example, {-007} means the 8th decade B.C.; {-05}, the 6th century B.C.; {16}, the 17th century of the Christian era; {-3}, the 4th millennium B.C.

By grouping the material thus designated according to the increasing algebraic value of the marks we can arrange it chronologically.

COMPLETE COMPOSITE MARKING

The complete composite marking of the vessel shown in Plate 1, for instance, would be written $\frac{C.516.270}{074.560}$ [825] (956.76) {-3}. The letter and six digits above the line correspond to our abbreviated system, which is used in our catalogue of pottery forms. The figures below the line are to be interpreted as follows: "0" in the first decimal place indicates that no further subdivision of shape .51 is employed; "7" in the second place defines the position of the maximum width (see p. 16); "4" in the third place indicates the relative width of the opening; "5" in the fourth place further defines the type of base; "6" in the fifth place indicates the type of rim; and "0" at the end means that no further specification of the accessories is given (since there are none). The three-figure mark in brackets (see pp. 19-21) specifies that the surface bears a polychrome design [8], that it is burnished or polished [.-2], and that the colors employed are white to buff (slip) with red and brown (design) [.-5]. The symbol in parentheses designates the provenience as the Diyala region in Mesopotamia (see p. 21). The "-3" in braces dates the vessel to the 4th millennium B.C.

In addition to identifying immediately the characteristics denoted by the various symbols, the composite marking enables us to subdivide independently under each feature and offers the possibility of classifying material according to any group of characteristics. For example, we can group together all similarly shaped vessels regardless of their surface finish, decoration, provenience, and date; or we can select similarly decorated vessels, disregarding their shape and other features; or we can select groups of vessels according to provenience or date. Within each group thus selected further classification can, of course, be undertaken on the basis of other features.

APPLICATION OF THE SYSTEM

Any classification of a given group of objects is to some extent arbitrary since it is based on the diversity of such qualities of these objects as one chooses to consider significant, and there are usually alternatives to such a choice. If, moreover, as is often the case in man-made

objects (e.g. pottery forms in contrast to natural forms of plants or crystals), these qualities are not determined by "natural laws," the classification is also largely artificial. It is almost inevitable then that difficulties should arise in a practical application of any detailed classification. In using our method one may expect, therefore, to come upon some pottery specimens which do not seem to fall under any one of the limited groups as defined and others which apparently can be assigned equally well to more than one group. It may be apposite, therefore, to mention some of the rules which we adopted in dealing with such doubtful cases.

SIZE

Since our grouping of vessels according to size is not based on precise measurements (see p. 18), it would be difficult to place some borderline specimens without additional, more specific definitions. Accordingly we set arbitrary lower limits for vessels assigned to groups B, C, and D as follows: vessels whose maximum dimension (either width or height) is 6 cm. or less are generally excluded from group B; those of 12 cm. or less are excluded from group C; and those of 30 cm. or less are excluded from group D. No such limit is set for group E because, as we have seen, it contains not only very large vessels but also architectural fixtures, and the latter might occasionally be small enough to fall into one of the other groups if they were treated as ordinary vessels. It should be noted that by fixing only lower, but not upper, limits we still avoid introducing sharp demarcation lines between the various groups. Thus, for instance, though vessels with maximum dimension of less than 30 cm. are excluded from group D, nothing prevents us from including some larger vessels in group C. In other words, the possibility still remains of assigning vessels of similar dimensions to different groups and occasionally even of attributing the larger of two vessels to a lower group than the smaller one. This results from our definitions of the size groups, which are based not only on actual measurements but also to some extent on use and implicitly on shape. For example, by definition group B contains small vessels of the table-service type which can conveniently be held in one hand (see p. 19), while the lower limit for group C is set at 12 cm.; whether any vessel larger than 12 cm. should be assigned to group B or C clearly depends on its shape and probable use. Thus a narrow conical goblet of shape .027.700 which is 20 cm. high obviously falls under the above definition and belongs to group B, whereas a globular cooking-pot only 18 cm. in diameter is assigned to group C. In other words, since the volume was implicitly taken into account in our definition of a vessel's size, it is clear that its proportions as well as its shape have to be considered in determining the group in which it belongs. On the whole the capacity of a vessel increases when its height and width approach each other, so that, of vessels having the same maximum dimensions, those whose third digit is an extreme figure (0 or 9) are more likely to be assigned to a lower group than those whose third digit is a middle figure (4 or 5). For the best assignment of a doubtful vessel it is often necessary to consider the group to which other vessels of the same type belong. This consideration is, indeed, often the decisive one: if it conflicts with the rule of arbitrary lower limits of the size groups given above, the latter may be disregarded. For instance, if a number of vessels of a certain type measuring between 30 and 35 cm. are classed in group D, a single vessel of the same type measuring only 29 cm. is assigned to the same group, though according to the above rule it would be excluded from this group. If, on the other hand, such a vessel is considerably smaller than the rest (e.g. 20 cm.) and no specimens of intermediate sizes such as would provide a continuous link between it and the larger vessels of the same type are known, it should be assigned to group C.

GENERAL SHAPE

The identification of actual pottery shapes with the theoretically defined forms may also present some difficulties. These may be due either to emphasis on different elements of form

in various definitions or to basing our arbitrary distinctions between forms on elements which vary only gradually.

The first type of difficulty is found in connection with vessels which can be ascribed to one group or another according to whether their general contours or the details of their contours are being considered. Figure 10 illustrates such cases; it shows two pairs of hypothetical vessels in which the exterior contours of the members of each pair are identical. However, the sections reveal significant differences. In the first pair *a* is of shape .58 with a flat base, while *b* consists of a container of shape .55 and a high ring base. In the second pair *c* is of shape .37 with a concave base, while *d* may be considered as a bowl of shape .05 joined to a pedestal of shape .31. The problem is whether *b* and *d* should be assigned to the same groups as *a* and *c* respectively. In practice we found it preferable to determine the general shape of such vessels as *b*, in which the container is the major part of the vessel, by the container alone, disregarding the effect of the accessories (the base in this case) on the whole shape. On the other hand, such vessels as *d*, in which the pedestal forms a major and characteristic part of the whole, are identified

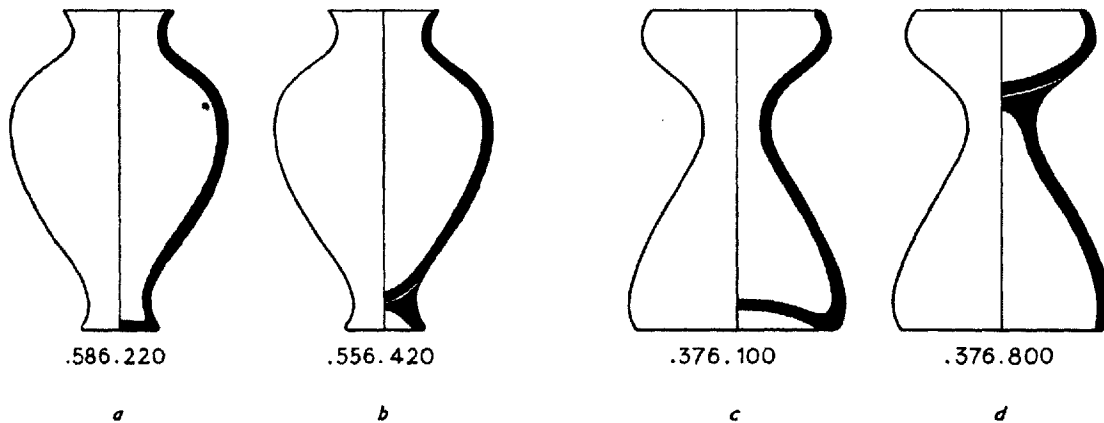

FIG. 10.—FOUR HYPOTHETICAL VESSELS, EACH PAIR CONSISTING OF TWO WHOSE EXTERIOR CONTOURS ARE IDENTICAL BUT WHOSE DESIGNATIONS DIFFER ON THE BASIS OF CONSTRUCTIONAL DETAILS.

according to their general contour. Consequently the designations of the two vessels in the first pair will be .586.220 for *a* and .556.420 for *b*, while both vessels of the second pair are assigned to group .37, *c* being .376.100 and *d* .376.800.

Difficulties of the second category were encountered in the first subdivision of the major groups, when we distinguished between groups .00 and .01 by setting an arbitrary limit to the angle of inclination (see p. 7, n. 14) and separated groups .64, .65, and .66 on the basis of the width of the opening (see p. 9, n. 15). Similarly the distinctions between .20 on the one side and .22 and .23 on the other can be defined arbitrarily on the basis of certain proportions; for instance, we may consider as convex or concave only vessels in which the variations in the diameter are more than $1/20$ of the total height and as cylindrical vessels in which this ratio is less.

It may also be noted that occasionally our distinctions between groups depend on more than one gradually varying element. For example, some forms in group .17 can approach very closely those of groups .53 and .54, with necks. The distinction in such doubtful cases is usually based on the general principle of classifying vessels "from the most open . . . to the most closed . . ." (see p. 5). However, it is obvious that whether a vessel is to be considered more open or closed depends not only on the relation of width of opening to maximum diameter but also on its general proportions and on the position of maximum diameter in relation to height. One may therefore differentiate between these groups by fixing arbitrary limits to these ele-

ments in their various combinations. We classify under .17 doubtful vessels whose proportions, in terms of the digits which represent them, are of any one of the following three combinations:

General proportion (3d digit)	Ratio between width of opening and maximum diameter	Position of maximum diameter in relation to height
0-3	8-9	7-9
4-5	8-9	8-9
6-9	9	9

It is, of course, impossible to list here all cases in which this kind of uncertainty may arise. We may remark only that whenever it is possible to reduce the problem to limiting arbitrarily certain measurable characteristics or proportions, the limitations should be chosen to answer the needs of each particular case. On the other hand, when it is impossible to simplify the problem in this manner, the considerations regarding the definitions which best suit other vessels of the same type (see p. 23) may be of great help. In other words, whether vessels which differ but slightly in general form should be attributed to the same group or to different groups depends also on their other characteristics.

PROPORTIONS AND ACCESSORIES

The proportions, dealing mainly with measurable qualities, are unlikely to present any serious ambiguity. Of the accessories, descriptive definitions were given only to the bases; and in designating these some uncertainties of the same character as those described in regard to general shapes may occasionally arise. For instance, it is clear that such a term as "flat base" is not absolute but must allow for slight irregularities. Such irregularities may gradually increase until the base has to be designated as concave or convex. Likewise there is none but arbitrary distinction at the borderline between low and high ring bases or between convex and pointed bases.

It would be impractical to discuss all such possibilities in detail. The general considerations outlined above and the knowledge of one's material must guide the decision in each particular case. Naturally, this may lead to slight individual variations in applying the system. However, any ambiguity which may result seems preferable to an undue increase of arbitrary secondary rules, since the more detailed these become the more cumbersome and the less likely to suit different collections of material they will be.

Finally, if the limited number of symbols provided by our abbreviated system of classification proves inadequate for the designation of a vessel with unusual combinations of features which are not mutually exclusive, additional digits defined in a more detailed form of the system (see pp. 14-16 and 19-21) may be used.²⁷ In other cases it may be preferable to catalogue such a vessel under two groups, with cross-references from one to the other, as we have done with most of our multiple vessels. It will be seen, however, that in our material such cases are exceptional.

POTTERY RECORDS

In conclusion a few words may be added concerning the practical aspects of keeping pottery records, for the principles of classification as outlined in this chapter are designed to be applied to the records rather than to the vessels themselves.

An adequate record of a vessel generally consists not only of written data, such as a description and information concerning the location and circumstances of the find, but also of graphic representations, namely photographs, schematic drawings (as described on p. 5), and paint-

²⁷ In practice instead of additional digits we have used letters (*a*, *b*, *c*, etc.) after the shape number (see p. 152).

ings. No standard methods of compiling such records are generally accepted; whether one or another method is adopted is, indeed, as much a matter of personal preference as of objective conditions and circumstances. In our experience, it is preferable to keep the records for each pot separately on sheets or cards so that the order of their arrangement can be varied at will. Cards of different colors may be used for the description and the drawing. To simplify filing, these cards may be of the same size as the photographic plates employed. In the choice of size, the scale of the schematic drawings is, of course, the most important consideration. Though uniformity of scale is desirable for purposes of comparison, it is clearly impractical to employ the same scale in drawing very large and very small vessels. In the present publication we have avoided reproducing on the same plate schematic drawings at different scales and, on the whole, have tried to maintain one scale for each size group. The scales employed, with minor exceptions, are: 4:5 for group A, 2:5 for group B, 1:5 for groups C and D, 1:10 for group E. For drawings at these scales 13 × 18 cm. cards (the same size as our field photographs) are convenient. If we allow 12 × 16 cm. of the card space for drawing, vessels up to 15 × 20 cm. can be drawn to the scale of 4:5, vessels up to 30 × 40 cm. to the scale of 2:5, vessels as large as 60 × 80 cm. to the scale of 1:5, and larger vessels up to 120 × 160 cm. to the scale of 1:10. On the whole, then, cards of these dimensions will allow vessels of each size group (see p. 23) to be drawn at a suitable scale.

It goes without saying that such details are not imperative for the employment of our system of classification and that other more or less elaborate methods of recording may be used equally well without affecting the results. Since descriptions of such methods can be found in certain archeological reports or in special monographs dealing with the technique of excavation and since, moreover, from our point of view they are of no great importance, it is unnecessary to discuss them here in further detail.

II DESCRIPTION OF THE POTTERY

INTRODUCTORY REMARKS

REGION AND SITES

THE four ancient sites from which our pottery derived are Khafajah, Tell Asmar, Tell Agrab, and Ishchali. They are situated within a comparatively small area in central Mesopotamia, east of the Diyala River and near its confluence with the Tigris (Pl. 204). We refer to this region as the "Diyala region," though actually only one of the sites, Khafajah, lies directly on that river's bank. The distance of the other sites from the river varies from a few hundred yards for Ishchali, which is within the narrow cultivated strip of land along the river, to about 18 miles for Tell Agrab, which is situated in a perfectly level and arid part of the plain, approximately one-third of the way between the river and the foothills of the Zagros Mountains. Tell Asmar (ancient Eshnunna), to the northwest of Tell Agrab, is approximately 8 miles from the Diyala as the crow flies. That the population of the two sites farthest from the river depended largely upon it for their livelihood is indicated by a network of irrigation canals that can be followed from either site toward the river to the north and northwest. In another volume of this series¹ the significance of the irrigation systems in this region, at various periods, will be discussed extensively; there, too, each of the excavated sites will be described in detail. The contour maps of the four sites given in the present volume (Pls. 200-203) should suffice for the purpose of general orientation and will help in ascertaining the area, building, or groups of buildings to which any locus referred to belongs and thus will serve to indicate in which of the architectural volumes of this series fuller information can be obtained.

RANGE AND DISTRIBUTION

The earliest pottery yet recovered in its proper stratigraphical context at any site in the Diyala region is to be dated to the Protoliterate period.² Remains of this period were found in the lowest excavations at Khafajah, Tell Asmar, and Tell Agrab (see Table III). Though these earliest remains all belong to the same cultural period, we have grounds to consider them not strictly contemporaneous.

Virgin soil was reached in our excavations at Tell Asmar and Tell Agrab only. At Tell Asmar (see Pl. 201) it was reached in two soundings in the northwest part of the site.³ One, in D 15:3, was called the "Bird-Vase Pit"; the second, in H 18:14, is known as the "Pit under the Akkadian Houses."⁴ In both, virgin soil was found at practically the same geometric level, about 21.00 m.,⁵ that is, about 14 meters below the present surface of the mound in D 15:3 and about 16 meters below the surface in H 18:14. Since in their lower parts both soundings passed

¹ *Four Ancient Towns in the Diyala Region*.

² This term, first introduced in *Pre-Sargonic Temples* (see esp. p. 8, n. 10), and its implications for the cultural history of early Mesopotamia, are the subject of a forthcoming study by the writer.

³ See *OIC* No. 20, Fig. 1 B-C.

⁴ See *ibid.* p. 59.

⁵ The geometric levels given in our publications are reckoned from arbitrary datum points chosen independently for each of the excavated sites. The same number may, therefore, express different heights above sea-level on the different sites, and care should be taken not to confuse them.

through accumulated rubbish and very poor dwellings whose floor levels could not be ascertained, the pottery found in them could not be assigned to definite building periods; instead, the sherds from each successive meter of deposit were recorded in separate groups (see Pls. 63–64), upon which the stratigraphy of the soundings is based.⁶

The deposit of the Protoliterate period in each sounding was about 5 meters thick. In D 15:3 it included a layer of sterile sand some 3 meters thick. However, the character of the pottery found immediately above this layer of sand is not markedly different from that found below it. In H 18:14 the pottery was fairly uniform throughout the Protoliterate deposit. In both soundings, as might be expected, pottery of the Protoliterate period occasionally occurred in the higher levels mixed with the later (Early Dynastic I) debris. The character of certain sherds and the presence of a semipictographic tablet representing a fairly advanced stage of writing in the lowest meter of each sounding (Pls. 63:73 and 64:68) seem to indicate that the Protoliterate deposits in both soundings belong to the latest phase, *d* (see below), of that period. To the same phase can be attributed the Earliest Shrine of the Abu Temple.⁷

A sounding made on Hill B at Tell Agrab, some 100 meters from the main mound (Pl. 202), reached what seemed to be an anciently cultivated field with an irrigation canal below 7 meters of debris and building remains of the Protoliterate and Early Dynastic I periods. Sherds characteristic of the Protoliterate period came mainly from a depth of between 3.5 and 5 meters below the surface. Few of these are significant enough to deserve illustration (Pl. 133 *h-i*). Their value lies mainly in the fact that they confirm the view, arrived at on the basis of certain objects found in the Shara Temple, that an important settlement existed at Tell Agrab in Protoliterate times.⁸ The early settlements on this and another hill (C) were perhaps “suburbs” that grew to accommodate an overflow of population from the main mound.

At Khafajah (Pl. 200) virgin soil has not yet been reached, for there the earliest occupation levels extend below the present water table, and by the time they were reached material circumstances made it impossible to undertake operations below water level on any useful scale. The comparatively high water level at Khafajah, due probably to the proximity of the Diyala, fluctuates around the level of 30.5 m. (see p. 27, n. 5), which is approximately 11.5 m. below the summit of Mound A. The lowest levels in our excavations at Khafajah were reached on that mound in squares O 43–44, P 42–43, and Q 42 during excavation of the Sin Temple⁹ and an area of private houses between the latter and the Temple Oval.¹⁰ Here building remains and graves were found fairly close to ground water. Thus, nearly all the pottery from Khafajah can be attributed to definite occupation levels.¹¹

The thickness of the Protoliterate deposit above water level at Khafajah is only about 4.50 m., yet it undoubtedly represents a longer time of occupation than the somewhat thicker deposits in the deep soundings at Tell Asmar. This is due to the above mentioned difference in character between the deposits on the two sites—rubbish and very poor dwellings at Tell Asmar, distinct building remains and graves at Khafajah. Indeed, the architectural remains of the Sin Temple at Khafajah allowed us to distinguish two phases within the deposit representing the Protoliterate period. We named these phases Protoliterate *c* and *d*.¹² Phase *c* is repre-

⁶ See *OIC* No. 20, pp. 59 f. In higher strata at Tell Asmar, where better preserved building remains were encountered, we were able to attribute most of the pottery to definite building periods or floor levels.

⁷ See *Pre-Sargonid Temples*, pp. 158 f.

⁸ See *ibid.* pp. 219 and 260.

⁹ See *ibid.* pp. 6 f. and Pls. 14 and 18.

¹⁰ See *Temple Oval*, pp. 73 f. and Pl. 12.

¹¹ Outside the Sin Temple, where architectural remains between water level and the foundations of Houses 12 (see n. 13) were fragmentary, the stratigraphy of finds is expressed by the corresponding building periods of the Sin Temple. These finds are distinguished from those which came from inside the temple precinct by use of parentheses in the “Building or Level” column of the catalogues. The same distinction is made in connection with the Nintu Temple at Khafajah and the Kititum Temple at Ishchali.

¹² See *Pre-Sargonid Temples*, p. 8, n. 10.

sented by three successive building periods of the Sin Temple (I-III), by some fragmentary remains of dwellings below and outside that temple, and by a number of graves. Protoliterate *d* is represented by two later building periods of the Sin Temple (IV-V), by Houses 12¹³ and the lowest floor of Houses 11 (see Table III), and by a number of burials considered contemporary on the basis of stratigraphic evidence.

Since the finds just above water level at Khafajah seem earlier than those found at virgin soil at Tell Asmar and since, moreover, the earliest layers at Khafajah have not been reached, it is evident that at the spots which we happened to investigate the earliest settlement at Khafajah antedated that at Tell Asmar. This does not prove, of course, that no earlier settlement existed somewhere in the area now covered by the ruins of the latter site, just as the fact that the first occupation above virgin soil in other regions of central Mesopotamia appears to be of the Protoliterate period does not prove that those respective regions, or even the sites themselves (Tell Asmar, Kish, Jamdat Nasr, and Farah), were previously uninhabited. However, it indicates, I think, that during the Protoliterate period there occurred a considerable increase of the population and that most of the urban settlements became more densely populated. As a result many existing settlements must have grown to cover considerably larger areas, so that their remains are more likely to be found at the bottom of any chance sounding than earlier, more restricted remains. Direct proof that earlier settlements existed at or near the sites in the Diyala region which we have excavated is provided by examples of ^cUbaid and Warka¹⁴ wares. The ^cUbaid pottery included some painted sherds (e.g. Pl. 17 *a-b*), and there are some fragments of typical ^cUbaid clay sickles also (e.g. Pl. 17 *c*). Some of the ^cUbaid sherds were found in the deep soundings at Tell Asmar (Pls. 63:71-72 and 64:66[?], 67, 71-72) and at Khafajah in the vicinity of vertical pottery drains which had been driven down to considerable depths from various occupation levels. Near one of these drains, in P 45, we found a few small fragments of worked obsidian, apparently remnants of a small bowl. While no obsidian vessels were found among the extensive remains of the Protoliterate and Early Dynastic periods elsewhere on our sites, they are known from earlier periods at other sites.¹⁵ Sherds of Warka wares occurred at and below water level at Khafajah, and one (Kh. VII 38) at least was found at a level (32.90 m. in O 43:40) corresponding to Sin II.

The fact that earlier settlements existed in the Diyala region as a whole is proved by a survey made by Dr. Jacobsen at the close of the field work of the Iraq Expedition.¹⁶

The first stage of the Early Dynastic period (ED I)¹⁷ is well represented at Khafajah, Tell Asmar, and Tell Agrab. At Khafajah the material derives from a large area of private houses (Houses 11-7), a fair number of graves, two elaborate rebuildings of the Sin Temple (VI-VII), five levels of the Small Temple in O 43 (I-V), and four levels of the Nintu Temple (I-IV). At Tell Asmar the period is represented by the Archaic Shrine of the Abu Temple and by material from the deep soundings mentioned above. At Tell Agrab most of the pottery of this period, especially the "scarlet ware," was discovered on two small hills, B and C, on the outskirts of the main mound.¹⁸

¹³ It should be noted that the building periods of the private houses are numbered from the surface down, while in the final publications the numbering of the levels of the temples has been reversed and begins with the earliest (see Table III).

¹⁴ The term "Warka wares" is used only to designate red- and gray-slipped, often burnished, wares such as were first discovered at Warka and are characteristic at that site mainly of archaic strata XIV-VI (see *UVB IV* [1932] 37-40).

¹⁵ E.g. at Warka (*UVB III* [1932] Pl. 20 *a* and p. 28), Tepe Gaura (*BASOR* No. 57 [Feb., 1935] p. 17, Fig. 6), and Tell Arpachiyah (*Iraq II* [1935] 76, Fig. 44:15).

¹⁶ The results of this survey will be published in *Four Ancient Towns in the Diyala Region*.

¹⁷ Since the subdivisions of the Early Dynastic period have been established in previous publications (*OIC* No. 20, pp. 35-39; *Pre-Sargonic Temples*, pp. 123-25, 157-59, and table at end) and are now generally accepted, they need not be discussed again here.

¹⁸ See *Pre-Sargonic Temples*, p. 228; fuller account of Hills B and C to appear in *Private Houses and Graves in the Diyala Region*.

The Early Dynastic II (ED II) material derives mainly from a large area of excavation at Khafajah which included, besides three strata of private houses (Houses 6-4), the first Temple Oval,¹⁹ two rebuildings of the Sin Temple (VIII-IX), two rebuildings of the Nintu Temple (V-VI), three rebuildings of the Small Temple in O 43 (VI-VIII), and a considerable number of graves. This material is augmented by that from the various stages of the Square Temple at Tell Asmar and by some pieces from the Shara Temple at Tell Agrab.²⁰

The major part of the pottery of Early Dynastic III (ED III) was found at Khafajah, where this period is represented by the two rebuildings of the Temple Oval (II-III), the latest stages of the Sin (X), Nintu (VII), and Small (IX-X) temples, and considerable areas of private houses (Houses 3-1) and burials at various points on Mound A (see Pl. 200). At Tell Asmar ED III is represented by the first Single-Shrine Temple,²¹ by Houses V c-b, to the southeast of it, and to a lesser extent by houses²² below the Northern Palace at the northwest corner of the site (see Pl. 201). At Tell Agrab the highest ruins of the Shara Temple (see Pl. 202) are dated to this period.

Nearly all the material of the Protoimperial period²³ comes from Tell Asmar, where the main level of the Northern Palace, two levels of the Single-Shrine Temple (II-III), and Stratum V a of the private houses are dated to this period. A few scattered remains at Khafajah are of the same date.

The Agade period is represented at Tell Asmar by Stratum IV of the private houses, the latest stage of the Abu Temple (Single-Shrine IV), and ruins above the Northern Palace (see Pl. 201). At Khafajah it is possible to attribute to this period only a few finds from the surface of Mound A.

The subsequent stage of Mesopotamian history, between the Agade period and the third dynasty of Ur, is represented only by a few finds from Tell Asmar (Houses III). Most of the pottery from the time of the third dynasty of Ur and of the Isin and Larsa dynasties also comes from Tell Asmar, from private houses (Houses II-I) as well as from the Palace of the Rulers and adjoining shrines.²⁴ In addition, pottery of about the same date was discovered in the large citadel of Mound D at Khafajah (see Pl. 200). The Kititum Temple²⁵ and adjoining buildings at Ishchali (Pl. 203) belong to the Larsa period and survive into the Old Babylonian period.²⁶

The latest pottery included in this volume comes from Mounds B and C at Khafajah (see Pl. 200). The major building on Mound B has been identified by an inscription found *in situ* as Dur Samsuiluna, a fort built by Samsuiluna the son of Hammurabi;²⁷ thus the pottery found in it is accurately dated. Very little pottery of still later date was found; it derives mostly from the fill of Dur Samsuiluna and from some later burials dug into the ruined walls of that fort.

The pottery included in the present publication covers, then, nearly two millennia of Mesopotamian history.²⁸ Naturally not all historical or cultural phases within this long period are

¹⁹ See *Temple Oval*, chap. ii.

²⁰ See *Pre-Sargonic Temples*, pp. 55-71, 82-96, 108-11, 172-92, and 260.

²¹ See *ibid.* pp. 192-99.

²² To be discussed in *Private Houses and Graves in the Diyala Region*.

²³ This term, introduced by Jacobsen in *AS* No. 11, is used in our publications to designate the time between the end of ED III (after the accession of Entemena of Lagash) and the first years of the reign of Sargon of Agade.

²⁴ See *Gimilsin Temple*.

²⁵ See *ibid.* pp. 116 f. and *OIC* No. 20, pp. 83 f.; see also n. 11 above.

²⁶ To be discussed in *Old Babylonian Public Buildings in the Diyala Region*.

²⁷ See *ILN*, Dec. 3, 1938, p. 1026, and *Old Babylonian Buildings in the Diyala Region*.

²⁸ This statement is based largely on the writer's estimates of the duration of the Protoliterate and Early Dynastic periods as given in *Pre-Sargonic Temples*, pp. 125-35.

equally represented on each site or in our material as a whole, and doubtless some important aspects of the pottery within this range still remain unknown; but by using the evidence from one site to supplement that from others, we can fill in some of the gaps, and thus at least the general picture of the pottery sequence in our region becomes fairly coherent.

As a rule we attempt to describe the material chronologically; but since different types of pottery lasted for different lengths of time or developed into other types at varying rates of speed, occasionally it seemed preferable to follow the development of a certain type or group through several cultural phases. Only rarely, however, does a discussion extend over more than one major period as defined by the combined architectural and archeological data.

TECHNICAL QUALITIES

There is hardly need to state that even the earliest pottery with which we are concerned is a technically advanced product. It had behind it a long tradition of the potter's craft in Mesopotamia itself and a still older background of successive cultural phases in the highland regions to the east and north. Indeed, not only would it be erroneous to consider our earliest pottery as being in any way primitive, but it will be recognized that in many respects it is technically and artistically more advanced than the pottery of some of the later, historical periods. Under these circumstances, it seems futile to search for direct prototypes for either the forms or the ornamentation of our pottery in basketry and vessels of wood or leather. On the other hand, the fact that even our oldest material is so advanced as to possess many characteristics which survive with but slight variation throughout the whole range of time represented makes it possible to describe at the outset some of the main technical qualities of the material as a whole,²⁹ so that in subsequent sections dealing with specific groups it will be necessary to mention only the most significant deviations from the normal and the rarely occurring technical innovations.

FABRIC

The fabric of the pottery—the result of both the composition of the paste before baking and the process of baking itself—in our region apparently varied less in the course of time than it did among different types within a single period. The limited variation over a long period is probably due to the fact that in our region the sources of clay in the alluvial plain did not vary much in the course of time; whereas in regions of varied geological formation exhaustion of one source of clay might lead to the use of a deposit of considerably different qualities. Perhaps some differences can be detected between vessels made of the old alluvial deposit and those manufactured from the freshly deposited silt of the rivers or irrigation canals, which presumably contained more organic matter.³⁰ The raw paste varies also according to the character of accidental impurities or of ingredients purposely added to serve as temper (*dégraissant*). Even in our earliest pottery both vegetable and mineral tempering materials are to be found. The most common vegetable temper is a mixture of finely broken straw³¹ and chaff; this is found generally in the larger vessels and in the coarser fabrics of all periods. In the finer fabrics sand,

²⁹ It is clear that there is need for a detailed technical study of Mesopotamian pottery somewhat along the lines of the admirable study contributed by James Leon Kelso and J. Palin Thorley of the pottery from Tell Bait Mirsim in Palestine (*AASOR XXI-XXII* 86-142). This example of enlisting the co-operation of ceramic experts in an archeological report set by Professor Albright may profitably be followed by other excavators.

³⁰ These observations are the result of a cursory examination with the naked eye. The recently developed methods of examining thin sections of pottery through a microscope, such for instance as applied by Frederick R. Matson to samples of pottery found by the Oriental Institute's Syrian Expedition in the 'Amuq (see *OIP LXI*), would probably make some significant contribution to our knowledge. Indeed, Mr. Matson is in possession of a considerable collection of pottery from the banks of the Tigris, including some specimens from our Diyala sites, and it is to be hoped that he will be able to study this material and publish the results.

³¹ "Cut straw," sometimes mentioned as a *dégraissant*, was not observed in our pottery, and I question, indeed, whether its presence has been established beyond doubt in other ceramic wares of comparable date.

lime, grit, and occasionally pounded or powdered pottery were more often used. On the whole such grits are coarser and more pronounced in the earlier fabrics. The normal fabric is not too fine, varying in color from brownish drab to light pink or cream.

The quality of the fabric depends, of course, not only on the quality of the clay and other ingredients of the raw paste but also on the firing process. In this too a fairly high technical standard was reached even in our earliest pottery. Most of it was hard fired in an oxidizing atmosphere, apparently in kilns efficiently enough constructed to allow a regulated draft. Pottery over-fired to a degree of vitrification is extremely rare, while under-baked specimens are found chiefly among the thicker and coarser fabrics, the cores of which are often darker than either surface. Slightly different colors on different parts of a vessel are fairly common but were obviously accidental. The oxidizing or reducing qualities of open or muffled fires were not consciously utilized to produce such intentional decorative effects as those of the famous black-topped vessels of Egypt or the variegated wares of Greece. The variation in coloring indicates that a uniform atmosphere was not attained in the different parts of the kiln and perhaps also that the average kiln was comparatively small. The larger jars of the Protoliterate period and especially the very large vats and basins of Early Dynastic times, which were seldom surpassed in size, bear witness to the fact that the technique of firing in those periods was as highly developed as that of any subsequent period in Mesopotamia, though it is possible that some of the largest vats were not fired in kilns.

MANUFACTURE

The use of a potter's wheel is discernible even in specimens from the lowest levels, and, though vessels made by more primitive means are not uncommon, there is no doubt that they are not necessarily older than those made on the wheel. We have ample proof that different methods were used simultaneously throughout various phases of Mesopotamian history, and, indeed, the proportion of handmade vessels is occasionally greater in later than in earlier times. On the whole the larger vessels are wheelmade, while most of the hand-fashioned and hand-turned specimens (see p. 3) are small.

Very often the lower part of a convex-based vessel is less regular than that of a flat-based vessel. This is due to the fact that convex bases were usually finished by hand after the vessels were taken off the wheel, while flat-bottomed vessels could be fashioned entirely on the wheel and removed from it by cutting at the base. However, even these are not always perfectly symmetrical. In some cases deformation occurred while the vessel was drying, in others when spouts, handles, etc. were being added (see e.g. Pl. 19 c, g).

Some of the larger vessels were manufactured in two or more separate parts which were fitted together after they had been allowed to dry to a workable consistency.³² In many cases the fitting of the separate parts was done so skilfully that it is hardly noticeable from the outside; the inside, however, often reveals some traces of the joining. In other cases the fitting resulted in some degree of asymmetry, which occasionally is great enough to give the impression that the vessel was handmade. Often the joints between parts are concealed by ridges or moldings, either plain or decorated in various ways. In many an instance the decoration served a practical purpose also by helping to press the parts together more firmly. Indeed, in our observation this practical reason often accounts for the presence of "rope-patterned" and notched ridges.

Apparently some of the finer vessels, especially those from the Larsa and Old Babylonian periods, were made in two operations. First the vessel was turned with rough and rather thick walls. After the clay had dried to a consistency which would permit thinner walls to hold their shape, the vessel was again placed on the wheel, which now served as a lathe, and the excess

³² Sometimes called "leather dry."

clay was pared off with a sharp instrument to produce the extremely thin walls and graceful form of the final product. Occasionally the paring-down was done by hand without replacing the pot on the wheel.

In nearly all the pottery with which we are concerned such accessories as handles, spouts, base rings, etc. were made by hand and then attached to the body of the vessel, sometimes by means of a fine semiliquid clay cement and sometimes merely by pressure either before the surfaces of the two parts had dried or, more probably, after remoistening of the two parts to be joined. In some cases the handle or spout was "riveted" to the body; that is, one end was inserted in a hole in the body and then flattened and attached to the inside (see e.g. Pl. 87 *e*). Special rabbeting tools or templets of bone, wood, or terracotta seem to have been used in forming the rims and possibly some of the bases (see p. 122).

SURFACE FINISH

Surface finish is often a decorative quality rather than a technical feature and is subject to greater variation in the course of time than any other feature. It will therefore be mentioned in the detailed description of the pottery whenever it is characteristic or significant. One very common process—indeed, the most common next to leaving the surface of a vessel untouched—is the so-called "wet-smoothing," that is, smoothing the surface of a finished vessel by hand or with a wet cloth. As a result the surface appears to be of finer grain than the biscuit, and the effect—a "self slip"—is often indistinguishable from a real, thin slip. In this connection it is noteworthy that some so-called "reserved-slip" wares seem to have had no real slip but that the characteristic decorative effect is due merely to the scraping of the wet-smoothed surface so as to expose at intervals the rougher texture of the biscuit.

THE PROTOLITERATE PERIOD

While the ceramic discoveries in the Diyala region add substantially to our knowledge of the material culture of the Protoliterate period, they suggest at the same time that our knowledge of pottery shapes and decoration of that period is as yet far from complete. Some conclusions which we felt justified in drawing on the basis of this material, with respect either to the stratification of our own sites or to the more general historical aspects in connection with the material provided by other excavations, are presented in chapter iii (see pp. 125-35). Since the Protoliterate period and its subdivision were defined but recently (see p. 27, n. 2), and partly on the basis of pottery published here for the first time, it seemed preferable to describe all the pottery of that period first and to discuss the subdivision of the period along with the other conclusions.

THE EARLIEST POTTERY

The earliest pottery which we found in its proper archeological context derived from our deepest excavations at Khafajah (see p. 28). These included a layer of debris below the foundations of Sin Temple I³³ and remnants of dwellings and graves in adjacent areas. Though potsherds were abundant throughout, only a few vessels well enough preserved to show their complete forms were recovered, nearly all from burials. But even from the sherds alone it is evident that conical bowls with narrow flat bases (cf. Pl. 20 *d*) were already very common. If we judge by the sherds, the bowls from these deep deposits include most of the varieties of this type found in higher levels of the Protoliterate period (e.g. B.003.200*b*, C.003.200, C.084.200*a-b*). The early bowls were usually wet-smoothed but never painted or burnished, and their flat bases nearly always bear a characteristic spiral scoring which resulted from cutting the vessel off the mass of clay on the potter's wheel while it was still in motion. Most of the other early sherds also are from wheel-turned vessels; they are preponderantly undecorated and of fairly fine paste with an occasional admixture of sand as temper (see above n. 30). On the whole they are hard and well baked but very rarely vitrified or misshapen by excessive heat.³⁴ In color they vary from light buff to dark gray and include shades of light red and orange-brown. A large proportion of the red, orange, and gray sherds were burnished and apparently slipped. Sherds covered with dark purple-red burnished paint, though present, are comparatively rare. Some of the pottery from the lowest levels at Khafajah is thus comparable with the "Warka wares" from archaic strata XIV-VI at Warka (see p. 29, n. 14). However, some of the red-painted burnished sherds may well belong to polychrome or red-painted vessels such as are described on pages 35-36. Another link with Warka which indicates the presence at Khafajah of remains dating to the early part of the Protoliterate period is provided by a small tablet of unbaked clay impressed with numerals³⁵ typical of the primitive stages in Mesopotamian writing.

A selection of sherds found somewhat higher in the debris below the level of Sin Temple I is shown in Plate 17 *d-l*. Of these, *d* (Kh. IX 49), with traces of two rectangular holes below the rim, is rather unusual. It is undoubtedly from the upper part of a fenestrated stand or brazier of the so-called "cut ware" well known from ED I (see pp. 55 f.). The existence of such utensils well before the end of the Protoliterate period is indicated not only by this sherd but

³³ See *Pre-Sargonid Temples*, p. 9.

³⁴ At Jamdat Nasr, on the contrary, "much of the pottery is warped through over-firing, and much is indifferently baked" (Mackay, *Jamdat Nasr*, p. 229).

³⁵ OIC No. 20, Fig. 19.

also by a nearly complete but unpainted specimen from Sin Temple III (Pl. 24 *a*). The evidence provided by these specimens is of considerable interest, and we shall have further occasion to refer to it (see p. 134). At present we may notice the unusual decoration of the painted sherd (Pl. 4, Kh. IX 49). Below a black band which covers the lower part of the rim the surface is whitewashed, and on this background there are vertical stripes of red and black. Although these were the two colors most commonly used on painted wares in the Protoliterate period, they usually occur on a buff or cream slip if not directly on an unslipped surface. The chalky white background on this sherd produces a rather exceptional combination of colors which at once reminded us of traces of architectural paintings, known then from Warka and Eridu only.³⁶ More recently discovered frescoes on the walls of a temple at Tell 'Uqair,³⁷ showing close affinities to the more usual types of polychrome pottery of the Protoliterate period, confirm our first impression of possible relationship between painting on pottery and architectural painting.

The other fragments shown in Plate 17 include tapering spouts, curved (*e*) and straight (*f*); a wet-smoothed sherd with a pierced beak-lug, showing particles of straw temper on the surface (*g*); and various decorated sherds (*h-l*). Attention may be drawn to the "feather" design on *h*, the comb incisions on *k* (see also p. 87), and the reserved slip on *l*.

EARLY POLYCHROME³⁸ WARE AND RELATED VESSELS

The vessel shown in Plates 1 and 18 *a* deserves detailed description not only because it is one of the very few complete specimens from the time preceding the building of the Sin Temple, but also because certain of its characteristic features (shape, fabric, and decoration) occur, as we shall see, in various combinations in pottery dating from later levels of the Protoliterate period. Apparently its whole outer surface was first coated with a cream-buff slip, over which dark purple-red paint was applied.³⁹ The red paint covers the entire surface except for four roughly rectangular panels on the shoulder (see Pl. 133 *a*⁴⁰). Two brown-black bands border the shoulder at its junctures with the neck and the body; similar bands outline the four reserved panels and divide each into one broad triangle and two narrow ones. The broad triangles are crosshatched in thinner, red-brown paint. The whole surface of the jar is burnished, the marks of the burnishing-tool being horizontal on the shoulder and vertical on the body. A rather narrow, slightly rounded base and a wide beveled ledge rim are features of this vessel which occur frequently on later specimens. The thickness of the walls in proportion to the size of the vessel somewhat exceeds that of plain vessels from the same stratum. Its distinctive brownish granular biscuit may be the result of firing at a comparatively low temperature.

The other specimens shown in Plate 18 belong to somewhat later levels of the Protoliterate period but have some features in common with *a*. Plate 18 *b* is the upper part of a vessel considerably larger than *a*, though very similar to it in shape, fabric, and type of decoration. Its fragments were found scattered outside the Sin Temple at a level corresponding to Sin II. Instead of crosshatched triangles on the shoulder, it has narrow vertical reserved bands similarly decorated. A rudimentary knob on the upper part of the shoulder is suggestive of the four regularly spaced knobs which are characteristic of certain later polychrome vases (see p. 49). On the whole these two polychrome jars (Pl. 18 *a-b*) are quite distinct from vessels of the bet-

³⁶ See *Pre-Sargonic Temples*, p. 9, n. 15.

³⁷ See Seton Lloyd in *ILN*, June 27, 1942, pp. 752 f., and in *JNES* II (1943) 138-49.

³⁸ The term "polychrome" is applied to pottery whose decoration includes more than one color. As a rule only two colors were used in the actual design. However, since the background for the design is frequently a special slip whose color contributes to the general decorative effect, we prefer the term "polychrome" to "bichrome."

³⁹ This seems, indeed, to have been the procedure usually followed in our polychrome pottery, though it is but rarely discernible.

⁴⁰ In our black-and-white renderings of polychrome pottery red paint is indicated by stippling.

ter known polychrome ware of Protoliterate *d* (see pp. 48-51). A small pot of the same brown friable gritty fabric as *a* and *b* comes from a level corresponding to Sin II (Pl. 18 *c*). The body is painted dark red outside except for triangles on the shoulder, which are outlined in black and crosshatched like those in *a*. It is so similar to the upper parts of *a* and *b* that it looks almost as if the potter had started out to make a vessel of that shape but for some reason had cut it off in the middle, providing it with a rather broad, asymmetrical, slightly concave base. However, a squat form (C.603.270) which occurs among our undecorated pottery of the Protoliterate period and certain shapes found at Jamdat Nasr⁴¹ indicate that the vessel under discussion represents yet another group of polychrome pottery. To this group may be attributed another small pot (Pl. 18 *d*) from a level corresponding to Sin II. It is wheelmade, but the lower part is hand-pared; and the comparatively thin walls are slightly concave near the base. It is of rather hard buff-gray gritty fabric and shows traces on the neck of red paint and on the shoulder of a geometric design which extends a little below the point of maximum width. The lower part of the pot was perhaps originally painted red or black. The design (Pl. 133 *b*) consists of four crosshatched triangles separated by narrow inverted triangles painted solid black and bordered by red bands. Its most interesting feature is the interruption of the black lines in the crosshatched triangles in a manner which suggests that two colors were used in the crosshatching, the black having been painted over the other, which peeled off and carried parts of the black with it. The fact that we have a few examples of crosshatching in black and red paint (see e.g. Pl. 136 *a*) suggests that the paint which has vanished might have been red. However, there is among our pottery a vessel from which some paint has vanished, though red paint is perfectly preserved (see p. 46). One must therefore consider the possibility that a third color was used in the crosshatching of the design in question.

Plate 18 *e*, from the same level as *b*, is similar in shape to *a* and *b* but is smaller and has a less pronounced carination between body and shoulder. The walls taper more sharply, and consequently the base is narrower. Unlike *a* and *b*, it is of gray-buff clay, and it was probably fired at a higher temperature; it is covered with a uniform green-gray slip instead of dark red paint, and no traces of design appear on the shoulder. Plate 18 *f* is a related specimen from Houses 12 at Khafajah, that is, from a later Protoliterate stratum (see Table III). It is of the same general form as *a*, *b*, and *e* but more elongated. Its fabric is similar to that of *a-c*, but, like *e*, it has no traces of design on the shoulder. Dark red paint covers the rim, neck, and shoulder, while the body has a green-buff slip. That this rather unusually elongated type is not confined to the stratum in which this specimen was found is proved by fragments of a very similar pot (C.537.240) from the earliest burial yet found at Khafajah. In it too the rim, neck, and shoulder are painted dark red.

Plate 18 *g* came from a burial which is probably contemporary with Sin Temple II. The upper part and base are the same as those in *a-b* and *e-f*, but the body is shorter and more rounded. It is of the same fabric as *a-c* and *f* and, like the last, shows traces of dark red paint over the rim, neck, and shoulder and of a light buff slip over the body. Traces of the light slip are visible under the red paint. A shape (C.536.540) intermediate between *f* and *g* was found in the H 18:14 sounding at Tell Asmar (see p. 27) in the first meter of debris above virgin soil (Pl. 64:57). In it the body is rounded, but the proportions are similar to those of *f*. This example is of brown-buff clay and is painted plum-red over a yellow-white slip. Another example of about the same proportions (C.546.240) was found in an early grave at Khafajah. It is of brown friable gritty clay and shows traces of a cream-colored burnished slip. A squattier variant of the same general type (C.534.240) came from Houses 12 at Khafajah. A red-painted vertically burnished sherd of brownish gritty clay (Pl. 17 *m*) came from a level corresponding to Sin II.

⁴¹ Mackay, *Jemdet Nasr*, Pl. LXV 17 and 22 f.

At this point it should be noted that in Sin Temple I at Khafajah we found fragments of a carinated four-lugged jar with a polychrome design (Pl. 29 *c*). A few fragments of such jars came from higher levels also. Their polychrome designs and the one on the early jar, however, are quite different from those just discussed and, as far as one can judge from the limited number of fragments, are not particularly characteristic of any one phase of the Protoliterate period. These fragments are therefore described in our discussion of four-lugged vessels (p. 40) rather than under polychrome pottery.

POURING VESSELS

Spouted jars were apparently quite popular in the Protoliterate period and constitute a large and varied group among our finds. The globular spouted jar shown in Plate 18 *h*, made of a brown friable fabric similar to that of Plate 18 *a-c* and *f-g*, has been blackened by fire, so that its surface finish is uncertain; but the least damaged portions give the impression that it may have been coated originally with dark red paint. The long conical spout is similar to some known from other specimens (e.g. Pl. 19 *b*). The neck is missing but obviously was rather narrow. It may have been of the rimless flaring type (cf. Pl. 19 *f*); or it may have had a rim, perhaps similar to any one of those which occur on spouted jars from Jamdat Nasr.⁴²

The combination of fabric and form found in this jar is rather unusual. Ordinarily our spouted vessels are of fairly hard well fired buff, yellow, or reddish fabric. The small and medium-sized examples are usually plain, but some were decorated either with reserved slip or with a single or multiple band of red or brown paint around the shoulder (e.g. Pl. 19 *h*). Some of the large spouted vases were decorated more ambitiously. The painted specimens are discussed under "Monochrome-Painted Pottery" (pp. 46 f.). It is interesting that spouted jars in the Protoliterate period were apparently seldom, if ever, decorated in polychrome.⁴³

Plate 19 shows a number of typical spouted jars from various Protoliterate levels at Khafajah. The earliest of these (*a*), from a burial, is one of the few complete vessels antedating the founding of the Sin Temple. It is made of hard rather fine light buff clay, and its surface is wet-smoothed. The curving conical spout (cf. Pl. 17 *e*) and the sharply tapering body recur in other vessels. From a slightly higher level came two globular spouted jars (Pl. 19 *b-c*) found together beneath the Small Temple in O 43. Their characteristic features are a short neck flaring sharply at the top, a flat base, and a long spout, slightly curved in *c*. Both jars were decorated with reserved slip in oblique patterns (see p. 53).

A spouted jar (Pl. 19 *d*) found in a somewhat later burial of Protoliterate *c* is of exceptional interest since it is of a type depicted in ritual scenes⁴⁴ and known not only from Mesopotamian sites but also from other regions (see p. 134).

The rest of the spouted jars shown in Plate 19 are still later: *e-g* came from graves, *h* from inside Sin Temple III, *i* from Houses 12. Plate 19 *e*, from a grave of Protoliterate *d*, is of buff clay and unslipped. It is similar to *a* in shape but somewhat squattier, and its rimless neck narrows toward the mouth. It has an incised line around the shoulder, a feature often found on Protoliterate vessels, with or without spouts, as shown for example by Plate 19 *f*. This jar is notable for its rather uncommon shape and especially for its flaring neck, of a type which occurs also on taller and more ovoid spouted jars. One such specimen (C.546.222), found in an earlier grave of Protoliterate *c*, had an alabaster cup inverted over its mouth. A jar with a less flaring neck and a longer spout (B.533.262), also with an incised line around the shoulder, was

⁴² *Ibid.* p. 238 and Pl. LXIII 18-23.

⁴³ To our knowledge there is only one spouted jar, from Jamdat Nasr, which may have been thus decorated (*ibid.* Pl. LXIII 21); but since its surface was "blackened in a fire and is also much weathered" (*ibid.* p. 239), the evidence it provides is somewhat equivocal.

⁴⁴ E.g. on an alabaster vase from Warka (*Kleinfunde*, Pls. 2 and 38).

found in the same grave as Plate 19 *d*. Plate 19 *g*, from the same grave as *f*, is a fairly large plain vessel of gray-brown clay. A more rounded variety of the same type (C.544.222) occurred in the same grave as *d*. Plate 19 *h*, the only jar in this group found inside a temple (Sin III), is discussed under monochrome-painted jars (p. 46). Plate 19 *i* is rather squat and has a straight rimless neck and a fairly long spout. It differs from the others in that it has a sharp carination between shoulder and body. A variant of this form survives into ED I (C.515.262). It may be noted that none of the spouted jars shown in Plate 19 have handles and that all have flat bases. The latter is a feature typical of Protoliterate spouted jars.

A spouted jar with a bail handle (C.515.265) was found in a grave of Protoliterate *c* at Khafajah (see p. 42).

Pitchers with pouring-lips and strap handles and possibly cups with handles⁴⁶ were used for liquids. However, such utensils must have been considerably less common than spouted jars. One nearly complete large pitcher of rather gritty greenish-drab fabric was found at a level corresponding to Sin II (Pl. 20 *a-a'*). Its outstanding features are a pinched lip, a strap-loop handle, of which enough remains to make its presence certain, and an incised band around the shoulder. This band is similar to the incised bands found on certain four-lugged vessels (e.g. Pl. 22 *b-c*). The only other pitcher from the Diyala region is represented by fragments (Pl. 20 *b*). These were found in the vicinity of Tell Agrab on a little mound—Tell Khubair—which, if we judge by surface finds, should be dated to the Protoliterate period. This specimen was of about the same size as that shown in Plate 20 *a-a'* and made of very similar greenish-drab clay which, however, contains pounded pottery as *dégraissant*. Its twisted loop handle is of a type found also in the H 18:14 sounding at Tell Asmar (Pl. 64:79) and known from excavations outside the Diyala region.⁴⁶ It can be seen that this vessel too had an incised band around the shoulder. Ten grooves on its pouring-lip indicate that the pitcher served as a measure of capacity, but unfortunately not enough is preserved to enable us to calculate the unit employed.

A much smaller vessel with a strap handle and incised lines on the shoulder (B.544.521) was made of similar greenish-drab paste containing grits of sand and lime. Indeed, it seems that in the Protoliterate period handles were often combined with such features as squat shapes, round bases, incised bands on the shoulders, and possibly this peculiar fabric. Such combinations are found in pottery from various sites and thus may be useful for relative dating (see p. 126). The rareness of handles among our pottery may be a regional characteristic or may be accidental, since they were fairly common at Jamdat Nasr.⁴⁷

A survey of spouted utensils of the Protoliterate period from our region would not be complete without mention of evidence for the presence of fairly large wide-mouthed spouted bowls. A rim sherd with a short tubular spout, chipped at the top (Pl. 20 *c*), came from a level corresponding to Sin II. Since bowls with almost identical spouts and rims occur in Protoimperial and Agade times (see pp. 106, 111), one would have been inclined to consider this sherd as intrusive were it not for the fact that similar sherds were discovered in debris of the Protoliterate period in the D 15:3 sounding at Tell Asmar (e.g. Pl. 63:49) and that spouted bowls occurred also at Jamdat Nasr⁴⁸ and in archaic stratum VI at Warka.⁴⁹ It seems safe to conclude, therefore, that this sherd actually belonged to a spouted bowl of the Protoliterate period.

In addition to single-spouted utensils there were used in the Protoliterate period vessels with multiple (Pl. 24 *e*) and possibly double spouts. Some of the spouted vessels were decorated with snakes in relief on spout (Pl. 92 *c*) or rim. The possibility exists that such vessels were reserved for ritual rather than domestic use (see also pp. 43 and 92–93).

⁴⁶ See Mackay, *Jemdet Nasr*, Pl. LXIV 21–27.

⁴⁷ See e.g. UVB IV, Pl. 18 C *p*, and Mackay, *Jemdet Nasr*, Pl. LXXVI 3.

⁴⁸ Mackay, *Jemdet Nasr*, p. 242 and Pl. LXIV 21–32. Cf. also Genouillac, *Telloh I*, Pl. VI 4304.

⁴⁹ *AJA XXXIX* (1935) Pl. XXXIII 1.

⁴⁹ UVB IV, Pl. 19 A *g'*.

CRUDE BOWLS, DISKS, AND OVAL DISHES

Beginning in the layer of debris below the Sin Temple at Khafajah and continuing through the strata contemporary with the first three building periods of that temple there occurred numerous sherds of crude handmade bowls with beveled rims. Although their walls are rather thick for their size, these bowls are quite fragile owing to the exceptional porosity of the fabric, which contains a large proportion of chaff and was on the whole poorly fired. As a result very few of them were found whole. In Plate 21, which shows a few of the best preserved specimens, one can see the distinctively beveled rims and the irregularity of shape due to hand-fashioning (note finger marks at bottom of *b*). The character and possible use of these vessels is discussed on pages 127-28.

Plate 20 *e* shows a nearly complete example of a type of clay object rare in our excavations but well known from Jamdat Nasr and Kish, where such objects were found in large numbers and in somewhat more elaborate forms. They were considered to be jar-stands by the excavators of those sites.⁵⁰ Our example is a solid disk with a roll-rim and a slightly concave upper surface. It is about 7 cm. high with rim diameter of about 20 cm. Another specimen from Khafajah, smaller (4.2×12 cm.) and with a slightly more elaborate rim, was found in an ED I grave (C.200.210). These two and several smaller fragments of similar objects are of coarse gritty easily crumbled fabric and have gray or black cores as a result of rather poor firing. We would suggest the possibility that they might have been lids for large storage jars rather than jar-stands. Fragments of similarly shaped objects made of gritty gypsum concrete instead of clay were noticed in Protoliterate levels at Khafajah.

Of much the same crude, imperfectly fired clay are two fairly large shallow oval dishes of shape C.802.200 found in Sin Temple V and VI, which date from the end of the Protoliterate and the beginning of the Early Dynastic periods respectively. Crude oval dishes of the same type were found at Jamdat Nasr.

UNPAINTED AND POLYCHROME FOUR-LUGGED VESSELS

Four-lugged vessels constitute a large and varied group of the Protoliterate pottery, nearly as important as that of the spouted jars. It should be remembered, however, that four-lugged vessels occur much earlier⁵¹ and survive without much change into later times (see pp. 53, 83, 98). Plate 22 shows a few examples belonging to the period under discussion. Of these, *a-b* come from levels contemporary with Sin I and II respectively, *d-g* from Sin III, and *h* from Houses 12.

Plate 22 *c* was found in the Shara Temple at Tell Agrab in an ED II level but must be considered a Protoliterate survival, since identical forms occur in phases of the Protoliterate period which are even earlier than those represented in our excavations.⁵² The less squat miniature jar shown in Plate 22 *b* has a slightly longer neck than *c* and three rows of oblique scorings bordered by horizontal incised lines. Specimens *b* and *c* represent a type, within the larger group of four-lugged vessels, characterized by a rounded body, a short neck, and a band of incised decoration at the height of the lugs. Vessels of this type vary from such small pots as *b* and *c* to specimens nearly 30 cm. in diameter. The very unusual practice of imitating a ceramic form in stone was observed in connection with this type, fragments of similar utensils made of stone having been found at Khafajah in Sin Temple IV (Kh. VI 454⁵³) and at Tellah.⁵⁴ This

⁵⁰ Mackay, *Jemdet Nasr*, p. 250 and Pl. LXVII, pottery type M; *Kish* IV 4 and Pl. VII 1. Recently such objects have been found at Tell 'Uqair also (*JNES* II, Pl. XVI, top).

⁵¹ *UE* I, Pl. XLIX to 515 (with 3 lugs); *Iraq* II, Pl. V (facing p. 88).

⁵² E.g. in archaic stratum VI at Warka (see *UVB* IV, Pl. 19 D b).

⁵³ See *Pre-Sargonic Temples*, pp. 141 and 154.

⁵⁴ Genouillac, *Telloh* I 54 and Pl. 5:1 *a*; another fragment, TG. 4720 (p. 53).

fact would indicate that such vessels were of rather exceptional importance, either because they were connected with some ritual or because they were customarily employed to hold valuable substances such as spice or incense. The latter assumption seems to be indirectly sustained by the fact that vessels of this type have the further distinction of being among the very few typically Mesopotamian forms found in Egypt (see p. 134). Moreover, such vessels are well suited for storing or transporting valuable substances, since their short necks and perforated lugs would enable one to seal them securely.

The two jars shown in Plate 22 *d-e* represent another type, which is characterized by nearly horizontal shoulders and fairly straight walls. Other shapes of the same group are B.413.253, C.413.253*b-c*, and C.414.253. Such vessels, either plain or covered with a cream-colored slip or dark red paint (occasionally both), were sometimes burnished. A squat jar of similar shape but with unusual painted decoration (Pls. 2, Kh. IX 194, and 32 *d*) is discussed on pages 45-46.

Another variety of four-lugged vessel is distinguished by double carination of the body (Pl. 22 *a, f-g*). Vessels of this variety are often decorated with monochrome designs (see p. 44). Plate 22 *a*, a miniature specimen, is of light brown clay and shows traces of purplish paint. Its walls are nearer the vertical than those of most of the larger specimens, and its lugs are relatively large. The roughness at the bottom could have resulted from either the breaking-off of a ring base or the adherence of some clay to the vessel before baking (cf. p. 43). Plate 22 *g* is one member of a joined pair, as indicated by a connecting piece which still adheres to its side. The peculiar practice of forming twin or triple utensils by joining two or three vessels with clay bridges seems to have been confined largely to four-lugged jars. A member of another such pair (C.634.453 = C.882) has a rather tall ring base and a monochrome design on the upper part of the body (see p. 45). A triple vessel (C.634.373 = C.883) has polychrome decoration. The fact that multiple vessels are composed of typically Mesopotamian forms suggests that they were indigenous and thus, perhaps, that some of those known from other regions⁵⁵ should be attributed to Mesopotamian influence.

The decoration of these multiple vessels, either monochrome or polychrome, is not much different from that of single vessels of similar form. The earliest four-lugged vessel with polychrome decoration is represented by sherds from Sin Temple I (Pl. 29 *c*). It has traces of a black and red design on a buff surface. The paints employed are peculiar in that, unlike those used on the early polychrome ware (e.g. Pl. 18 *a-b*), they are easily rubbed off, a fact which probably indicates that such vessels were painted after baking. This technique is typical of the "scarlet ware" of ED I (see p. 60). On that ware, however, the red is usually of a bright scarlet hue quite different from the dark purple-red on the fragments under discussion. A small sherd (Kh. VII 13) of another polychrome four-lugged pot was found at a level corresponding to Sin II. This fragment has two vertical black-bordered red bands, one on each side of a perforated beak-lug, with a vertical row of superimposed black lozenges between them. The whole pattern is probably one of four which separated four metopes on the shoulder. Unfortunately nothing of the designs which may have been within such metopes is preserved. A larger fragment of a polychrome four-lugged vessel (C.603.253*b*) came from Sin Temple III at Khafajah. Most of the design is in black, while purple-red paint is confined to broad vertical bands bordering simple geometric patterns. Red paint from one of the bands accidentally ran below the lower border of the design.

The latest of the four-lugged vessels shown in Plate 22 is *h*, a rather large pot from Houses 12 at Khafajah. It is less well shaped than the earlier specimens and is of the brown friable fabric described in connection with the early polychrome ware (see pp. 35 *f.*). Like many vessels of this peculiar fabric it was coated with dark red paint and shows horizontal burnish

⁵⁵ See *Mém.* XIII (1912) Pl. XXXII 9; Sir Aurel Stein, *An Archaeological Tour in Gedrosia* (Archaeological Survey of India, "Memoirs," No. 43 [Calcutta, 1931]) Pl. XIII Sh.T.vi.3.

marks. From the same level derives a somewhat taller form (C.604.353) of the same general type but possibly with a ring base. It too was painted solid dark red.

A few sherds with perforated beak-lugs were found in the lowest meter of debris in the H 18:14 and D 15:3 soundings at Tell Asmar (Pls. 64:61-63 and 63:75).

Because of the popularity of four-lugged vessels it is of interest to consider briefly the purpose their lugs may have served. In the smaller specimens they could undoubtedly have been used for suspension. However, the weight of the larger specimens, especially when filled, would generally preclude such use. This fact suggests that unless the lugs were ornaments they must have had some function other than that of suspension. The most likely, we think, was to help in securing a suitable lid over the mouth of the vessel. Since nearly all the four-lugged jars have very short necks or no neck at all, they could easily be covered by shallow bowls or plates such as those shown in Plate 23 *i-j* (see p. 42). One four-lugged jar (C.533.313) was actually found with its lid, a small bowl with a perforation in the base (B.042.500*a*), still in position (see Pl. 40 *a*).⁵⁶ By means of a cord passed through the perforated lugs one could indeed fasten such a lid so securely that it would be impossible to remove it without breaking either the pottery or the cord, especially if the ends of the latter were sealed by means of clay bullae, such as are actually known from this period.⁵⁷

MISCELLANEOUS UTENSILS

A globular jar from a burial at Khafajah which was most probably contemporary with Sin I (Pl. 23 *a*) has a short neck, a roll-rim, a flat and rather narrow base, and, on the upper part of the body, two rounded ridges with traces of red paint between them. Another interesting feature is the porosity of its biscuit, which contains a large proportion of straw temper. The vessel was covered with a fairly thick buff slip which did not adhere well to the walls but flaked off in parts, revealing the rougher surface beneath. A second globular jar (C.654.520), with a single ridge, was found in the same burial. Globular pots without ridges also were found at various levels. Fragments of one with traces of red paint (C.655.540) and of another, unpainted (C.654.540), were found in graves of Protoliterate *d*. Other globular jars (B.643.520 and B.654.520) came from the D 15:3 sounding at Tell Asmar (Pl. 63:77) and a grave of phase *d* at Khafajah respectively.

Plate 23 *b* shows a miniature pot from Khafajah found at a level lower than Sin I. Unlike most vessels of its size, even in later periods, it is wheelmade and shows marks of hand-paring on its lower part only. It is made of rather gritty light buff clay and shows no traces of paint or slip. A little hole in the body apparently was made accidentally and not as an opening for a spout. Another miniature pot, handmade and of more common form, is shown in Plate 23 *g*.

The vessels shown in Plate 23 *c-f* are from levels dated to Protoliterate *c* and undoubtedly represent a better class of common pottery of the period. They are of finer and harder fabrics than most of the contemporaneous vessels shown in Plate 18. In color they vary from cream to buff or light red. The walls are comparatively thin, and the surface is either wet-smoothed (*d-e*) or burnished (*c, f*). Plate 23 *c* shows a serviceable utensil of a not very distinctive shape. It is of fine cream-colored fabric with reddish patches. Unburnished pots of similar forms (C.544.520 and C.554.520) were found in somewhat later burials. Plate 23 *d* is a form which is unusual among our pottery but has roughly contemporaneous parallels in northern Mesopotamia (see p. 134). A similar but slightly taller specimen (C.753.510) from a burial dated to Houses 12 shows that this type, though comparatively rare in our region, occurred as late as the end of the Protoliterate period. A similar though more rounded form (C.655.510) was found

⁵⁶ At Tell 'Uqair such bowls or plates were found serving as lids over the mouths of jars (*JNES* II, Pls. XXVI 4 and XXVII 1).

⁵⁷ See e.g. *UVB* II (1931) pp. 28 f. and Figs. 13-14.

in another grave of the same date. Plate 23 *e*, with its carinated body and low center of gravity, also is rather unusual, though its rim and neck closely resemble those of *a*. A similar form (Pl. 23 *h*) comes from a level corresponding to Sin III. Plate 23 *f*, of fine cream-colored fabric, is characterized by a well defined angle between shoulder and body and a wide short neck crowned by a narrow flanged rim. Though the vessel is wheelmade, its flat base is somewhat asymmetrical, since it was hand-finished after the pot had been removed from the wheel. It has simple painted decoration in the form of a black band around the neck.

Shallow vessels, from 8 to about 20 cm. in diameter, with nearly vertical walls and convex bases (Pl. 23 *i-j*) are typical of the period. They occurred in buff, tan, and brown fabrics, the last being very similar to that of the vessels shown in Plate 18 *a-b*. Some are plain; others are slipped or painted red outside and sometimes inside too. Occasionally they are burnished. Though most of them were undoubtedly used as plates, they could very conveniently have served as lids, especially for short-necked and neckless four-lugged jars (see p. 41).

A thin-walled jar (Pl. 23 *k*) from the lower floor of Houses 11, that is, from the very end of the Protoliterate period, is of well baked light buff fabric similar in consistency to that of some earlier utensils (e.g. Pl. 23 *e*). A small rather flat-shouldered jar from Sin Temple IV (Pl. 23 *l*) has a small protuberance on the shoulder which is no doubt the stump of a "wing"-lug. This type of lug becomes very common in ED I (see p. 57). A small pot with a vertical lug attached to the neck (B.546.223) came from the Earliest Shrine of the Abu Temple at Tell Asmar.

Plate 24 shows some rather unusual utensils from Khafajah. Plate 24 *a*, with rectangular and triangular apertures in the walls, is presumably the main part of a stand or brazier whose base is broken off. As we have seen (p. 34), the sherd shown in Plate 17 *d* probably represents a still earlier example of a similar utensil. While rare in the Protoliterate period, such fenestrate utensils, of so-called "cut ware," become very common in later periods in Mesopotamia. The fact that the specimen under consideration was found inside a temple (Sin III) would suggest ritual rather than domestic use. This is supported by the fact that of the considerable number of such utensils known from the Early Dynastic period the great majority were found in temples (see pp. 55 f.).

Plate 24 *b*, from Houses 12, is of fine gray paste. It has a small bail made of two joined strips of clay and at the top a small pierced knob (cf. Pl. 24 *c*), perhaps a vestigial spout. While this vessel is unique among our pottery, a fairly close parallel was found at Jamdat Nasr. That specimen, unlike ours, was covered with a cream-colored slip, and apparently its bail consisted of a solid strap of clay.⁵⁸ Another of our vessels with a bail is a rather small spouted jar (C.515.265) from a grave of Protoliterate *c* at Khafajah.⁵⁹ This jar too has a close parallel from Jamdat Nasr, but in this case our pot is of the common coarse drab paste while the Jamdat Nasr example is of fine gray paste.⁶⁰ A detached handle made of two joined strands of light greenish clay was found at 21-22 m. in the D 15:3 sounding at Tell Asmar (Pl. 63:78). Handles made in this peculiar manner are rather rare, however; they may perhaps be related to an elaborate double handle of ED I (Pl. 51 *b*). Yet another variety of handle found in the Protoliterate period is a ledge-lug attached at the mouth. One of these was found in the lowest meter of debris in the D 15:3 sounding (Pl. 63:70). Others occurred at higher levels in that and the H 18:14 sounding (Pls. 63:52, 13 and 64:43, 24). This type of handle is known also from archaic stratum III or II at Warka.⁶¹

Plate 24 *c* shows a conical cup or bowl from a level corresponding to Sin II. It is of finer paste and much better workmanship than the common larger conical bowls represented by Plate

⁵⁸ Mackay, *Jemdet Nasr*, Pl. LXIV and pp. 242 f.

⁵⁹ The only other bail in our material is on a miniature bucket (A.014.101) from an ED III(?) level (see p. 98).

⁶⁰ Mackay, *Jemdet Nasr*, Pl. LXIII 30 and p. 240.

⁶¹ UVB IV, Pl. 20 C c.

20 *d*. It differs from them also by the presence of a small pierced lug near the top (cf. Pl. 24 *b*)—perhaps for suspension. The perforation, however, extends through the wall and thus suggests a miniature spout. Since the specimen is broken, we could not ascertain whether such a lug existed on the opposite side too.

Plate 24 *d*, from Houses 12, is an undecorated bottle whose unusual shape results from a curious double shoulder and a tall rimless neck. The rough surface at the bottom suggests a broken-off ring base; but it could have resulted from the adherence of some clay to the vessel before it was baked (cf. p. 40).

A seven-spouted pot from Sin Temple IV (Pl. 24 *e*) is another vessel which suggests ritual use. An almost identical pot was found at Telloh.⁶² Usually spouted jars found in temples are interpreted as having been used for libation. In the case of seven-spouted pots, however, one is tempted by the idea that they may represent the earliest versions of the seven-wicked lamp well known in the Near East in later times.⁶³

A jar with a roughly cylindrical body, an oval horizontal section, and a wedgelike base with three round holes (C.806.610) is unique in our finds. It was found at 23–24 m. in the H 18:14 sounding at Tell Asmar. However, similar utensils are known from Jamdat Nasr. We can offer no convincing explanation as to their use.

THERIOMORPHIC RITUAL VASES

All the theriomorphic vases described below were actually found in temples. The earliest (Pl. 25 *a*) is a bird-vase from a small room adjoining the sanctuary of Sin Temple III. It is about 30 cm. long and 30 cm. tall and thus could hold a fair amount of liquid. It is of light reddish clay, and the surface is wet-smoothed. The body apparently was begun on a wheel as an open cylinder and then modeled by hand into the form of a bird. A clay ridge with straight scorings was added to form the tail, but wings are not indicated. The funnel on the back, through which the vessel could be filled, was wheel-turned separately. The neck and head, which form a spout, and the legs were fashioned by hand and attached to the body by means of wet clay, which was used for the final touches also. Two small pellets represent eyes.

The second vessel of this group (Pls. 25 *b* and 26) is in the form of a bull and was found in Sin Temple IV. It is made of rather fine red-buff clay and is well baked. Again the body was apparently wheel-turned and the accessories, except for the funnel on the back, were fashioned by hand and then joined to the body. The horns as shown in the photographs are partially restored. Part of the tail broke off in antiquity and was mended with bitumen. This material was used also to paint the eyes. As in the bird-vase, the mouth served as a spout.

The peculiar shapes of these vessels and the fact that they were found in a temple would in themselves indicate their ritual character; but, as it happens, such vessels are actually depicted in ritual scenes on cylinder seals and on an alabaster vase from Warka. The theriomorphic vessels represented on the latter are in the forms of a lion and an antelope(?).⁶⁴ A cylinder seal from Warka pictures two tall vases similar to the Warka vase itself and a bird-vase extraordinarily like our specimen.⁶⁵ A cylinder seal of unknown provenience now in Dresden shows a ritual scene with two theriomorphic vessels, one of which is actually carried by a worshiper.⁶⁶ Now, it is interesting to note that the above mentioned objects on which theriomorphic vessels are depicted are of the so-called "Uruk" style, while the actual vases described were both

⁶² Genouillac, *Telloh I*, Pl. III 5481.

⁶³ In the 𒄠𒀭𒀭𒀭 = *hubullu* list there is mention of a "pot with seven breasts" (*RA VI* [1907] 130, AO 2162 obv. i 4).

⁶⁴ See *Kleinfunde*, Pl. 38.

⁶⁵ *UVB VII* (1936) 25 f. and Pl. 25 *e*. A representation of a bird-vase seems to have been used as a pictographic sign also; see Eric Burrows, *Archaic Texts* (Joint Expedition of the British Museum and of the University Museum, University of Pennsylvania, Philadelphia, to Mesopotamia, "Ur Excavations: Texts" II [London, 1935]) Pl. 34:419.

⁶⁶ H. Frankfort, *Cylinder Seals* (London, 1939) Pl. V c and p. 18.

found in proper context in temples of the "Jamdat Nasr" period. Thus these ritual vessels provide one of the many close links between two phases of early Mesopotamian culture (end of the "Uruk" and the entire "Jamdat Nasr" period) the aggregate of which led the writer to consider them as phases of a single cultural period which he terms "Protoliterate" (see p. 27, n. 2).

That theriomorphic ritual vases were not always plain is shown by fragments of such a vase decorated in polychrome (Pl. 133 *c*) from Sin Temple V. The find-spot, the fabric, the paint, and the motif of the design combine to prove that this vase is an example of the late polychrome ware of the Protoliterate period (see pp. 48-51). The short strokes of black paint between the black-bordered red stripes are unique among our polychrome specimens. However, they recall a presumably much earlier theriomorphic vase from Arpachiyah whose entire surface is covered with similar strokes of red paint, which Mallowan interpreted as representing the bristles of a hedgehog.⁶⁷

Another painted theriomorphic vessel is a bird-vase (Pls. 7 and 27) from Small Temple VI at Khafajah.⁶⁸ Although it was found in a building dated to ED II, the painting suggests that it is a survival from the Protoliterate period. A stone vase⁶⁹ found at a still higher level in the same temple and clearly of a style belonging to the Protoliterate period supports this view. The form of the bird is similar to that of Plate 25 *a*, but instead of legs it has a conical pedestal, and the wings are indicated by reserved spaces containing small incised projections and painted designs.⁷⁰ Like the previously discussed theriomorphic vessels, this bird-vase was made in several parts, of which the base and the body apparently were wheel-turned. The decoration consists of a reddish paint or wash with reserved oval spaces on the body to indicate wings and reserved vertical panels on the base. All the reserved spaces contain simple linear patterns in deeper red.

MONOCHROME-PAINTED POTTERY

In the Protoliterate period the pottery decorated with monochrome designs presents considerable variety. In addition to such very simple decoration as a single or double band around the shoulder or neck (e.g. Pls. 19 *h* and 23 *f*) there occur fairly elaborate designs employing both geometric and representational motifs. Again there seems to have been a marked tendency to combine certain pot forms with certain types of decoration, but the more usual combinations are by no means exclusive. The colors most often used were coal-black, purplish or brownish black, and various hues of brown and red. Usually the paint was applied directly to the wet-smoothed surface of the pot, rarely on a thin light-colored slip (e.g. Pls. 63:81 and 64:14-16, 26, 33, 53), and occasionally over a reserved slip (e.g. Pls. 31 *b*, *d* and 64:17).

FOUR-LUGGED JARS

A very common combination of decoration and shape, which occurs as early as Protoliterate *c*, is a monochrome design applied to the upper part of the body of a short-necked or neckless carinated jar with four lugs (forms .49, .60, and .63). Two such specimens from Sin Temple I (Pl. 28 *a-b*) are similar in shape to the plain jar shown in Plate 22 *f* but are considerably larger. On all vessels of this type the design is confined to the part of the body above the maximum width and is bordered above and below by a horizontal band. The upper border, which con-

⁶⁷ *Iraq* II 88. A vase in the form of a pig and closer in date to ours was found at Jamdat Nasr (Mackay, *Jemdet Nasr*, Pl. LXXVI 2 and pp. 231, 252, and 294). It is of rather inferior workmanship and, unlike our vase, has only one narrow aperture, through the snout.

⁶⁸ See *Pre-Sargonic Temples*, p. 106.

⁶⁹ *Ibid.* Fig. 98.

⁷⁰ A bird-vase from Gezer, Palestine (Hugues Vincent, *Canaan* [Paris, 1907] pp. 315 f. and Fig. 202) is the closest parallel for our example. Another parallel is a polychrome bird-vase from Susa with a lower pedestal (*Mém.* XIII, Pl. XXX 9 and p. 154).

nects the lugs, is sometimes a solid band but often consists of two horizontal lines with the space between them filled with vertical or oblique strokes, zigzags, or solid triangles. Sometimes it is a combination of both types of bands (e.g. Pl. 28 *c*). The design itself is divided into four parts by a motif below each lug, and the resulting metopes contain various patterns. The design in Plate 28 *a* is divided by herringbone strips. Each of the metopes is divided by single or double vertical lines into three panels, the middle one containing diagonal checkers and those on the sides superimposed "hourglass" motifs (right) and two "butterfly" motifs with an "hourglass" between them (left). On the second jar from Sin I (Pl. 28 *b*) the upper border consists of two horizontal lines with short vertical strokes between them. The most interesting feature of the design is the tree motif under each lug, rendered in a manner apparently characteristic of monochrome decoration of the period, for it recurs on vessels of other shapes. The metopes between the trees contain an hourglass motif, two butterfly motifs, and a rectangle, all crosshatched.

A considerably smaller jar (Pls. 28 *c* and 134 *a*), from Sin Temple III, is of the same type as *a* and *b*. It is made of gray-buff fabric and decorated with simple geometric motifs. It is one of the examples on which the border joining the lugs is not uniform throughout (see above).

Fragments of another four-lugged vase from Sin Temple III (Pl. 29 *a*) represent a fairly large specimen which differs from the others in that it has a slightly more pronounced neck. The design is painted in purple and shows a tree which is even more "naturalistic" than those in Plate 28 *b* and a bird which, on the other hand, is very much conventionalized. Similar representations of trees and birds occur on four-lugged vessels from other sites.⁷¹ Fragments of a considerably larger jar of the same type from Sin Temple III (Pl. 29 *b*) are painted in sepia brown over a whitish slip. The geometric motifs are clear and require no comment. The representation of a tree, part of which is discernible on the extreme right, seems to be rather more sketchy than usual.

Yet another fragmentary four-lugged monochrome-painted jar from Sin Temple III (Pl. 134 *b*) is of well baked light tan fabric, reddish on the inside and light buff on the outside. It has a groove connecting the lugs and a second groove slightly above them. The design is executed in mat plum-red paint. The metopes contain crosshatching bordered by multiple vertical lines, but below each lug is a rather unusual pattern: a finlike motif on each side of an oblique ladder, which suggests that the painter may have fancied the perforated lug as the head of some creature, possibly a fish.

A fragment found in Sin Temple V (Pl. 134 *c*) apparently belonged to a jar with a slight neck and a rather rounded profile similar to that of Plate 29 *a*. It had two incised lines above the painted band joining the lugs. Apparently the design was divided into metopes by multiple vertical lines, which, however, did not coincide with the lugs. What remains of one metope shows part of an animal, probably a bird, with crosshatched body. Such crosshatching of the body is found also on pottery from Jamdat Nasr and Tell 'Uqair.⁷²

A previously mentioned (p. 40) four-lugged jar, which was an element of a multiple vessel (C.634.453 = C.882), has herringbone strips below the lugs and crosshatching bordered by multiple vertical bands in the metopes.

A monochrome-painted sherd with a perforated beak-lug (Pl. 64:62) was found in the lowest meter of debris in the H 18:14 sounding at Tell Asmar. It bears a linear design in black.

The four-lugged pot shown in Plate 32 *d* (= Pl. 2, Kh. IX 194) is probably from Protoliterate *d* but may be earlier. It has certain previously described features, namely, a shallow rim, a flat shoulder, and four perforated beak-lugs (cf. Pl. 22 *d-e*). A new element is a notched ridge which emphasizes the carination between body and shoulder. An extraordinary feature, however, is

⁷¹ E.g. Jamdat Nasr (*AJA* XXXIX, Pls. XXXIII 4 and XXXV 4) and Tell 'Uqair (*JNES* II, Pls. XXIII-XXIV).

⁷² Mackay, *Jemdet Nasr*, Pl. LXXX 2; *JNES* II, Pl. XXVII 3.

to be found in the decoration, which at first glance appears to be a simple monochrome design consisting of single and multiple red bands. But upon closer examination one can discern between and below the lowest two horizontal bands a faint reserved design resulting from the complete fading or peeling-off of the substance in which this design was originally executed. Since the red paint employed for the rest of the decoration is very well preserved and since black paint does not usually vanish completely, it must be assumed that the reserved design was painted with a substance other than the usual varieties of black and red paint. We have seen, though less clearly, an indication that paint has vanished on a small pot from an earlier level (Pl. 18 *d* and p. 36). In neither case do we have means of determining the color of the lost paint, but the fact that nonstable paint was used is in itself interesting. With the knowledge gained from these specimens, it may prove possible to detect faint traces of such paint either on other pottery or on wall paintings of the Protoliterate period.

Although the prevalent decoration of four-lugged jars was monochrome, polychrome designs were used occasionally (see p. 40).

SPOUTED JARS

Monochrome designs are often found on spouted jars also. Frequently such decoration consists simply of a single or multiple band, as in the case of the jar shown in Plate 19 *h*, which has two horizontal red bands at the height of the spout. This vessel, found in Sin Temple III, is comparatively tall and has a narrow neck, a crudely fashioned beveled rim, and a thick conical spout rather clumsily joined to the body. Fragments of a much larger spouted jar (D.665.542) decorated with three red bands were found at a slightly lower level. They show that the jar had a rather narrow neck with a roll-rim. No fragments of the base were found and it is uncertain whether it was convex or flat. A similarly decorated large spouted jar, but with a wider neck and a ledge rim, with two red bands around the shoulder and a ring around the spout, was found with a more elaborately painted vase (Pl. 30) of the same shape (C.545.342) in the Earliest Shrine of the Abu Temple at Tell Asmar.

The decoration on the latter is a fine example of monochrome design in what may be called "naturalistic" style. The design is executed in purple-red paint on a greenish-cream surface (Pl. 3, As. 34:246). It is bordered above and below by a broad solid band and is divided into vertical panels. Four narrower panels (one at the spout and the others fairly symmetrically spaced), each consisting of two vertical bands with a row of superimposed lozenges between them, alternate with four wider panels, each containing a rather spirited representation of a tree with a touch of liveliness added by loose "wind-blown" leaves among the branches.

Representational motifs on spouted vases are not limited to plants. Fragments of a spouted jar from a level corresponding to Sin III (Pls. 4, Kh. IX 198, and 31 *a*) show remains of a ring around the spout and triple red lines bordering the design at the top and dividing it into panels. The two partly preserved panels contain representations of animals, which are executed very differently from those occurring on somewhat later (ED I) polychrome pottery (see p. 65). Animal motifs are, however, rather rare. In the majority of cases the decoration on spouted jars consists of simple plant and linear designs. Fragments of a large jar with short flaring neck and short conical spout (Pl. 31 *d*), though found in an ED I grave, apparently belong to the last phase of the Protoliterate period. They probably turned up in the debris while the grave was being dug, for they were found heaped together at the knees of the skeleton while the other grave equipment was grouped near the head. The surface shows the type of "reserved slip" which probably resulted from scraping after the pot had been wet-smoothed (see p. 33). The red-painted decoration consisted of groups of quadruple lines which divided the surface into vertical panels (possibly six). One of these, narrower than the others and containing the spout, has a framed plant design in addition to a ring around the spout. Each of the other panels

apparently contained a swastika-like motif formed by four leaf-shaped elements. A monochrome-painted sherd from the D 15:3 sounding at Tell Asmar (Pl. 63:54) has red linear decoration and remains of a ring around the spout. Such a ring is a feature common to many monochrome-painted spouted jars, even if otherwise their designs vary considerably.

Six- or eight-pointed stars occur on other specimens. Plate 31 *c-c'* show a brown-painted fragment having a ring around the spout with a six-pointed star on either side. A shoulder fragment of a jar similar to that in Plate 31 *d*, very probably spouted, is divided by multiple red lines into panels, each of which contains an eight-pointed star formed by four crossed lines (Pl. 134 *d*). Two spouted sherds from the H 18:14 sounding at Tell Asmar are decorated with multiple red lines and may have had stars in the panels (Pl. 64:14, 29). One of these (14), however, is of ED I date, and the other may be that late. Six- or eight-pointed stars occasionally were painted in bitumen on jars of the Early Dynastic period, where, however, they do not form elements of a design but seem to be isolated potter's marks (see p. 103).

Pentalphas were not found on any of our pottery, but they are known to be part of the repertoire of motifs used in the painting of Protoliterate pottery.⁷³ One is engraved on an amulet from Tell Agrab (Ag. 36:419).

Fragments of a spouted jar with reserved slip (Pl. 31 *b*) show remnants of what apparently was an over-all design of plant motifs painted in light brown. A motif common to several sherds most probably from spouted jars consists of multiple loops suspended from a horizontal band (e.g. Pl. 134 *e*).

Fragments of the shoulder of a very large and possibly spouted jar from a level corresponding to Sin III at Khafajah show remnants of comparatively narrow vertical panels. The one best preserved contains a rather unusually elaborate geometric design (Pl. 134 *f*).

A monochrome-painted sherd from the D 15:3 sounding at Tell Asmar (Pl. 63:40) with vertical red lines belonged probably to a spouted jar. It may be of ED I date.

Four small sherds from ED I levels at Tell Asmar (Pl. 134 *g-j*) are closely related to the type of monochrome-decorated pottery under discussion.

MISCELLANEOUS VESSELS

Monochrome designs are not confined to four-lugged and spouted jars but occur, though less frequently, on other vessels. Three such vessels from Houses 12 at Khafajah are shown in Plate 32 *a-c*. One is a bowl (Pls. 32 *a* and 3, Kh. IX 163) of a shape uncommon in the Protoliterate period but more like that of certain bowls of the 'Ubaid period. Nevertheless, it need not be considered a survival, for its decoration at least could be related to that on some of the four-lugged and spouted jars. The red paint is considerably darker than that used on most monochrome-painted specimens (cf. e.g. Pl. 4, Kh. IX 198). But in monochrome-painted pottery this difference cannot serve as a criterion for distinction of date (cf. p. 127). Plate 32 *b* is a carinated jar of brown clay with a wide, slightly flaring, rimless neck. The decoration is confined to the surface between the neck and the carination. The design is bordered above and below by a horizontal band and consists of vertical panels, each formed by two vertical bands with crosshatching between them. The paint is purple-black and is applied directly to the wet-smoothed surface. The walls of this jar are unusually thin for its size. Plate 32 *c* is a thicker-walled jar whose general shape is more common among polychrome vessels from the same level (cf. e.g. Pl. 36 *c-d*). The outside of the vessel is covered uniformly with red paint except for a horizontal band on the shoulder which in its turn is decorated with a series of line-bordered crosshatched triangles of the same color.

A shoulder fragment (Kh. VII 110 *a-c*) from a vessel with a strap handle and probably of

⁷³ E.g. at Jamdat Nasr they occur both in linear form and with the points painted solid (Mackay, *Jemdet Nasr*, Pl. LXVIII 8 and 11; *AJA* XXXIX, Pl. XXXIII 3).

rounded squat form was found at a level corresponding to Sin III at Khafajah. It is of reddish fabric with the design painted in dark red.

A sherd of green-buff clay with a black-painted linear design (Pl. 63:61) was found in the D 15:3 sounding at Tell Asmar.

LATE POLYCHROME (JAMDAT NASR) WARE

On pages 35–36 we described a few specimens of polychrome ware antedating and contemporary with the first three phases of the Sin Temple at Khafajah, that is, from Protoliterate *c*. The main bulk of the Protoliterate polychrome pottery from our excavations derived, however, from somewhat higher levels (mostly Houses 12 and Sin V) which belong to the last phase (*d*) of the period. Only to this later polychrome pottery do we apply the term “Jamdat Nasr ware,” for it is of the variety best represented at Jamdat Nasr itself and at other Mesopotamian sites where polychrome pottery was found. There are several characteristics by which the later pottery can be distinguished from the earlier. Some of these pertain to the shapes of the vessels, others to the decoration and technical qualities. But it is usually the combination of characteristics rather than any one by itself that is significant for our purpose. The distinction between the early and late polychrome pottery of the Protoliterate period should become clear after the following description of representative examples of the later ware.

The best specimens, both technically and artistically, are to be found chiefly among a group of fairly large vases, sometimes more than 60 cm. in diameter.⁷⁴ The height of such vessels is about the same as the diameter, sometimes slightly less and sometimes more. They usually have a rounded body with a pronounced shoulder and a well defined neck with a wide beveled ledge rim. Unlike the vessels of the early polychrome ware, they have ring bases. Another distinctive feature of such vases is a plastic ridge near the top of the shoulder with four equally spaced ornamental studs.

A vase which in many respects is typical of the later ware is shown in Plates 5 and 33.⁷⁵ It has an all-over cream-colored slip covered with dark red paint which leaves in reserve trapezoidal panels on the shoulder. Attractive and fairly intricate patterns painted in these reserved panels are set off by the strips of solid red between them. Although the spacing of the panels seems rather haphazard when the vase is viewed from above, the decoration of each panel is fairly symmetrical; moreover, if the vase is viewed from the side, there are numerous angles which present a well balanced and attractive design. It would seem, then, that this was the aspect which it presented to the artist who painted it.

However, asymmetrical designs on the shoulder are rather unusual; symmetrical designs are more common, the guiding principle, as in early polychrome specimens (e.g. Pl. 133 *a-b*), being the division of the circle into four or multiples of four. A fine example of symmetrical design is to be seen on the large jar shown in Plate 34. This jar of gray-buff paste was covered with red burnished paint except for eight panels on the shoulder. The design consists of sixteen panels painted alternately in solid red and in red and black geometric motifs. As seen from above (Pl. 133 *d*) it is composed of two crosslike patterns, one made up of four panels containing double vertical bands of extended lozenges and hourglass motifs and the other of four panels containing combinations of extended lozenges and solid and crosshatched triangles.

The shoulder of an even larger vase (nearly 60 cm. in diameter) apparently of similar form has a somewhat more elaborate design (Pls. 6 and 35 *a*) composed of two crosslike patterns with triangular reserved spaces between the panels. A wavy red line and two straight dark

⁷⁴ Apparently even larger vessels, reaching almost a meter in diameter, were recently found by Lloyd at Tell Uqair (*ILN*, June 27, 1942, p. 753).

⁷⁵ Although this vase was found in a room of Temple Oval I (ED II; see *Temple Oval*, pp. 25–27), it is obviously a survival from Protoliterate *d* and is in fact one of the best specimens of the type of polychrome pottery characteristic of that phase.

brown lines in each reserved triangle may be taken as the borders of one set of panels. Both dark brown and red were used in the actual design also, and the background is a light buff slip. Unfortunately very little of the body was found, but it was apparently painted red and perhaps burnished.

Representational designs also occur on large vases, though more rarely. One such vase, of which unfortunately only a small part of the painted shoulder is preserved, is shown in Plate 35 *b*. As usual, the body is covered with solid red paint which extends over the shoulder in vertical bands. Two of the panels left in reserve between these bands show traces of representational motifs: a plant on the right and perhaps a scorpion or a bird on the left.⁷⁶ Because the upper part of the shoulder is missing it is impossible to say whether it had a ridge with ornamental studs, as in the three previously described examples, or merely four rounded knobs spaced along an incised line, as in some of the specimens which we shall presently describe.

In addition to exceptionally large vases which manifest highly developed technical and artistic ability, there are smaller vases which are usually less ambitiously decorated. Among these, several distinct shapes can be distinguished. The kind of vessel which perhaps more than any other is associated with Jamdat Nasr ware is represented in Plate 36 *b-d*. The first (*b*) is similar in form to the large vases described above, though it differs from them in several respects. It is only of medium size and relatively squat (cf. e.g. Pl. 33). It has a wider base, a shorter neck, and a less well shaped rim. Instead of a ridge with ornamental studs it has an incised line with four rounded knobs. Such rounded knobs sometimes occur with a double incised line (see n. 78). The decoration (Pl. 8, Kh. IX 101) is the same in principle as that on the more elaborate specimens, for red paint covers the entire surface except for vertical panels on the shoulder. Each of these narrow panels contains a very simple geometric motif painted in brownish black. From the H 18:14 sounding at Tell Asmar (23–24 m.) came the upper part of a fairly large polychrome jar (Pl. 64:42) apparently of the same kind. A sherd (Pl. 64:41) from the next meter of debris (24–25 m.) in the same sounding is probably part of a similar jar. Such vessels sometimes occur with strap handles.⁷⁷

The two specimens shown in Plate 36 *c-d* are proportionally taller than *b* and have a more pronounced carination between the upper and lower parts of the body as well as a second carination just below the neck. The upper carination seems to correspond to the plastic ridge of the large vases and the incised line of the smaller vessels discussed above. Our specimens have no knobs on the shoulder, but at Tell 'Uqair were found examples of this type with both single and double incised lines at the upper carination and with rounded knobs exactly like those of Plate 36 *b*.⁷⁸ One of the 'Uqair vessels is entirely covered with red burnished paint and has no design on the shoulder.⁷⁹ The decoration of our vessels follows the usual pattern. Red paint covers the surface except for vertical panels filled with simple geometric motifs. One motif, to the left on Plate 36 *c*, can be identified as similar to the one in the right-hand panel of Kh. IX 101 on Plate 8 (= Pl. 36 *b*). On *d* there are traces of a panel containing a double vertical row of hourglass elements or lozenges similar to those which occur on Kh. IX 149 (Pl. 6). The red paint employed on *c-d* is of a lighter shade than that used on *b* and is more like that of Kh. IX 153 (Pls. 8 and 36 *e*). The last mentioned specimen, though found at the same level as *c-d* (Houses 12), is of a form which is somewhat less characteristic of our late polychrome ware of the Protoliterate period but which occurs both painted and unpainted in the Early Dynastic age. It has a carination well above the middle and a well defined shoulder not unlike those of earlier vessels (Pl. 18 *a-b*). It is, however, considerably shorter, consists of quite different

⁷⁶ A similar representation is known from Jamdat Nasr (Mackay, *Jemdet Nasr*, Pl. LXXX 1).

⁷⁷ E.g. one from Jamdat Nasr (*AJA* XXXIX, Pl. XXXIII 3) and another from Tell 'Uqair (*JNES* II, Pl. XXVI 6).

⁷⁸ *JNES* II, Pl. XXVI 4–5.

⁷⁹ *Ibid.* Pl. XXVI 5.

fabric, and has a wide ring base instead of a narrow slightly rounded flat base. Its decoration is not greatly different from that on such specimens as Plate 36 *b-c*. Solid red paint again covers the surface except for vertical panels on the shoulder. A black band on the shoulder corresponds to the ridge, the incised line, or the second carination on other specimens. Other black bands are painted along the carination between body and shoulder, at the junction of neck and shoulder, and about halfway up the neck. The design consists of four fairly broad reserved panels each containing a different pattern. Viewed from above this design appears as a cross (cf. e.g. Pls. 6 and 133 *d*). The features of this vessel which differentiate it from the rest of the late polychrome pottery of the Protoliterate period are more characteristic of ED I scarlet ware and therefore suggest a transitional stage between the two wares. Certain vessels from ED I levels possess features which suggest that they too are transitional (see pp. 60-63). The gradual change in color from the earlier to the later polychrome pottery is illustrated by Plate 8, where the two upper vessels belong to the Protoliterate period while those below come from ED I.

To return to the late polychrome ware of the Protoliterate period, in addition to the more common forms described above there are also some unusual shapes. One complete example (Pl. 36 *a*) differs from those just described in that its maximum width is well below the middle and in that it has a rather wide short neck. In other details, such as the broad ledge rim, the ring base, and the incised line below the neck, it is similar to the other forms. It has an all-over yellowish slip covered with red paint except for narrow panels. Each panel contains the familiar motif of superimposed extended lozenges (cf. Pls. 5 and 8, Kh. IX 101). A vessel of similar shape (C.745.270) but with a somewhat different design was found in the Earliest Shrine of the Abu Temple at Tell Asmar. Vessels with low center of gravity occur among the ED I polychrome pottery also (e.g. Pl. 54 *e*).

On Plate 133 we show drawings of fragments of late polychrome ware from various find-spots. Of these, *c* is the theriomorphic vase from Sin Temple V discussed above (p. 44). A knob-like fragment (*e*) found beside it, though broken at both ends, is suggestive of a *sikkatu* or other wall ornament. On the other hand, its find-spot suggests that it may have belonged to a ritual vessel. A fragment of a neckless jar from Sin Temple V (*f*) has a horizontally pierced tubular lug with a vertical ridge in the middle, quite unlike the familiar beak-lugs of the Protoliterate period but resembling certain ED I lugs (see Pls. 41-42). This is, indeed, not astonishing, for Sin Temple V, though built during the last phase of the Protoliterate period, survived into ED I.⁸⁰ The decorative motif on this fragment is also common to both periods (see Pls. 5 and 136 *f*). A sherd from Houses 12 at Khafajah (Pl. 133 *g*) is noteworthy for its broad black bands and red-filled black-bordered superimposed hourglass motifs. Two sherds found between 3.5 and 5 meters below the surface in the sounding on Hill B at Tell Agrab are undoubtedly of the Protoliterate period (see p. 28). The larger (Pl. 133 *h*) is from a vase of the type shown in Plate 36 *b* but with a ridge around the shoulder. It is of light tan clay and painted purple-red except for vertical panels on the shoulder in which geometric motifs are executed in solid black. The glittering of the surface of this sherd in certain lights is probably due to the presence of minute mica flakes exposed by burnishing (see p. 31, n. 30). The smaller sherd from Tell Agrab (Pl. 133 *i*) is interesting because of the motif of superimposed birds, for which there are close parallels from other sites and periods.⁸¹ Four sherds (Pl. 133 *j-m*) are from the Earliest Shrine of the Abu Temple at Tell Asmar.

To complete the record of polychrome pottery, some fragments from the Protoliterate de-

⁸⁰ See *Pre-Sargonid Temples*, pp. 123 f.

⁸¹ Jamdat Nasr (*AJA* XXXIX, Pl. XXXIV 3 and 5), Susa (*Mém.* XIII, Fig. 168 and Pl. III 4), Tepe Hissar (Erich F. Schmidt, *Excavations at Tepe Hissar, Damghan* [Philadelphia, 1937] Pl. VI DH 44, 10, 3), Tepe Siyalk (Ghirshman, *Sialk* I, Pl. LXXVIII B 8).

posits of the deep soundings at Tell Asmar should be mentioned. In D 15:3 in the first meter of debris above virgin soil occurred one painted sherd (Pl. 63:79) which may be of late polychrome ware. A semipictographic tablet representing a comparatively advanced stage of Protoliterate writing (Pl. 63:73) dates this level to Protoliterate *d*. Above this level was a layer of sterile sand about 3 meters thick, but the finds immediately above the sand (25–26 m.) were not greatly different from those beneath it. Here the late polychrome ware was clearly represented by several sherds (Pl. 63:55–57 and 60).

In the H 18:14 sounding several sherds (Pl. 64:64 and 69–70) from the first meter of debris above virgin soil are painted in colors and patterns which seem to indicate that they represent the late polychrome ware of the Protoliterate period. Here too the earliest debris is dated to Protoliterate *d* by an inscribed clay tablet (Pl. 64:68), which confirms the impression given by the pottery. Two sherds from higher levels are mentioned on page 49.

EARLY DYNASTIC I

While painted wares constitute a large part of the total pottery from the Protoliterate period, the great bulk of Early Dynastic I pottery is unpainted. The study of forms thus becomes even more important for comparative dating, and consequently we shall deal first with various groups of unpainted pottery according to form and distinguish at least one group of pottery by fabric.

UNPAINTED POTTERY

SPOUTED JARS

Still common among unpainted vessels, and found both in dwellings and in graves, are spouted jars. Although at various levels of ED I (see Table III) different types of spouted jars were frequently found together, one can distinguish a definite change in the prevalent types between the beginning and the end of the period.

The three spouted jars shown in Plate 37 *a-c* derive from graves dug from Houses 11 at Khafajah and represent a type which occurs but rarely in higher levels. While such vessels vary in size and proportion, they have certain features in common, the combination of which determines the type. These features are a slightly rounded body separated from a well defined rather steep shoulder by a notched ridge and a rimless neck tapering slightly toward the mouth. Such jars have nearly always a ring base and often a band of oblique notches just below the neck. This type is similar in shape to that represented by Plate 19 *i*, which appeared in the Protoliterate period. Thus although all our specimens of this type derive from ED I levels, there is a possibility that it was introduced at the end of the Protoliterate period. In any case its range in time is rather limited, and it can well serve for dating unstratified remains in which it occurs (see pp. 137-38).

Plate 37 *d* shows a fairly large spouted jar from a grave of Houses 11. Its flat base, tapering ovoid body, and rimless neck relate it to certain spouted jars of the Protoliterate period (e.g. Pl. 19 *a, e*). The chief difference is that the spout instead of curving down curves up slightly. This, however, may be a purely accidental feature, for it is not at all typical of ED I. Another vessel which is similar to earlier examples is a globular pot (Pl. 37 *e*) from a grave of Houses 10. Except for the rimless neck, which is more like those of Plate 37 *a-c*, it resembles the globular jars illustrated in Plate 19 *b-c*. Plate 37 *f*, one of two such specimens from a grave of Houses 10, has a slightly flaring neck and a more rounded body than those of Plate 37 *a-c*. Its ring base, thumb-impressed ridge around the shoulder, and short conical spout are, however, features in common with *a-c*. A notched ridge occurs on a vessel from a grave of Houses 8 (Pl. 37 *g*). Its neck is similar to that of *f*, and the spout is somewhat longer; the body, though of the same general shape as that of *c*, is slightly less rounded with a proportionally wider base. From a grave of Houses 8 come several examples of a rather poorly shaped ovoid jar without carination between body and shoulder (e.g. Pl. 37 *h*).

A large well shaped jar with a ring base and a slightly flaring neck (Pl. 37 *i*) may be considered as a perfected form of the type represented by *h* and in its turn is similar to some of the large spouted jars of ED II (see p. 80). Two smaller jars from Houses 8 at Khafajah (Pl. 37 *j*) and Hill B at Tell Agrab (Pls. 37 *k* and 65:7) represent yet another variant, which appears at the beginning of ED I and continues throughout the period.

A type of jar which seems to be limited to ED I is represented by Plate 38 *a-b*. Its characteristics are an ovoid body, a short neck with a vertical band-rim, a short slightly curved spout, and a flat base. Specimens of this type were found in a grave dug in from Houses 8 at

Khafajah and in Hill B at Tell Agrab (see Pl. 65:2-5). Another type of spouted jar found both in ED I graves at Khafajah and in Hill B at Tell Agrab (see Pl. 65:6, 8, 10) has carination between shoulder and body, a rimless neck, and a ring base (Pl. 38 *c-e*). One specimen of this type (*e*) is notable for the reserved slip on the shoulder. Except for its ring base this type is very similar to those shown in Plate 37 *j-k*. It continues throughout ED I into ED II and III, when it becomes the predominant type of spouted jar.

A small squat spouted jar from Hill B at Tell Agrab (Pls. 38 *f* and 65:12) has no parallel at Khafajah. Another small spouted jar from Hill B, likewise the only one of its kind, has an unusually narrow neck (Pl. 65:11). A second jar with an exceptionally narrow neck (Pl. 38 *g*), from Houses 8 at Khafajah, is more angular and is so different from the normal run of contemporary pottery vessels that it might perhaps be considered as an imitation of a metal type. Such a view is indirectly supported by the fact that the imitation of stone vessels in pottery is well attested for this period (see p. 58).

The outstanding characteristic of a large spouted jar from a grave of Houses 8 (Pl. 39 *a*) is its reserved slip, a type of decoration which was used as early as the Protoliterate period (see e.g. Pl. 19 *b-c*) and continued into ED II (see p. 81). It occurs usually in either a horizontal or an oblique pattern. In ED I it is found not only on spouted jars (see also Pl. 38 *e*) but also on other kinds of vessels. One of the latter (Pl. 39 *b*), from Archaic Shrine III of the Abu Temple at Tell Asmar, has the typical oblique pattern, which occurred already on a sherd from below the Sin Temple at Khafajah (Pl. 17 *j*). Two fragments representing the two most common reserved-slip patterns are shown in Plate 43 *e-f*. Large spouted jars, either plain or decorated with reserved slip, occur in ED I with vertical band-rims, short flaring necks, and slightly rounded bases (D.535.542, D.545.542). A large spouted jar of similar shape but with a shallow ring base (D.545.322) and simple monochrome decoration is mentioned on page 72.

In ED I, as in other periods (see pp. 92-93), double spouts were known and spouted vessels were sometimes decorated with applied snakes (see Pls. 63:4 and 92 *a, d, f*).

FOUR-LUGGED JARS

In ED I, as in the Protoliterate period, four-lugged jars occur in several forms, plain or with various types of decoration, but with a greater variety of lugs. The ED I examples are on the whole quite distinct from the earlier jars but like them are usually neckless (see Pls. 40-42). Generally there is a notched ridge forming a gutter below the rim, and the lugs are attached to, or just below, the ridge. We have already discussed the possible use of such pierced lugs (see p. 41) and concluded that because some four-lugged jars seem too large for suspension the lugs more likely served for securing a cover over the mouth; this conclusion is practically unavoidable with regard to some of the ED I specimens, which are on the whole considerably larger than those of the Protoliterate period. Plate 40 *a* shows a jar which is probably of ED I date, though it may be earlier, with its lid still in position. One would think that normally the lids would be somewhat wider so as to fit into the gutter around the rim.

Two plain four-lugged neckless vessels are shown in Plate 40; *a* is from Sin Temple V at Khafajah, *b* from Archaic Shrine II of the Abu Temple at Tell Asmar. Both have fairly wide openings. The outward-sloping rim and transversely pierced beak-lugs of *b* are common. The rim of *a*, on the other hand, slopes inward, and its lugs too are exceptional, being set laterally and pierced from front to back. Another vessel of the same shape as *a*, with the same kind of lugs and with its lid in position, came from the same locus.

A polychrome vase with transversely pierced beak-lugs connected by a plain ridge (Pl. 59) is discussed in detail on pages 68-69.

Plate 41 shows four-lugged vessels with incised decoration, *a* and *c* from Archaic Shrine III at Tell Asmar and *b* from Hill B(?) at Tell Agrab. They are neckless, like the plain specimens

shown in Plate 40, but their openings are comparatively narrower and the notched ridges are somewhat thicker. The horizontally pierced lugs are quite different from the beak-lugs prevalent in the Protoliterate period. They are all rectangular, but those on *a* are larger than the others and slightly depressed in the middle. The shoulder of each vessel is covered with simple incised decoration in horizontal bands. On *a* there are four bands filled alternately with lines slanting to left and to right; *b* has four bands of multiple zigzags. On *c* (=Pl. 42 *d*) there is a crosshatched band between a band with a multiple zigzag and another with a crosshatched zigzag. The vessels differ in the treatment of the shoulder; in *a* and *c* it is separated from the body by a notched ridge; in *b* it merges with the body.

Plate 42 illustrates fragments of four-lugged incised vessels from Tell Asmar and Tell Agrab. Plate 42 *a* is from a jar probably of the same shape as Plate 41 *a*, but its decoration resembles that of Plate 41 *b*. Similar patterns occur in Plate 42 *b*, *e* (=Pl. 65:36), and *h*, but in *h* the lugs are decorated with two horizontal rows of scorings. Plate 42 *c* shows shoulder fragments of a jar of somewhat different shape (see Pl. 44 *d*) entirely covered with shallow notched ridges parallel to the ridge connecting the lugs; the spaces between the ridges are filled alternately with incised lines slanting to left and to right. The fragmentary jar shown in Plate 42 *d* (=Pl. 41 *c*) is described above. In it, as well as in *f-g*, each of the incised bands contains a different pattern, and *f-g* are exceptional in other respects also. Plate 42 *g* has beak-lugs instead of rectangular ones, and in the second band from the top it has tiny circles impressed in some of the panels. Plate 42 *f* (=Pl. 65:35) has a very short neck instead of a broad rim, and its lugs are joined to the neck, while the usual ridge is missing. Incised sherds probably from four-lugged neckless jars were found in the D 15:3 sounding at Tell Asmar (e.g. Pl. 63:18, 19, 26, 31, and 39).

The four-lugged incised vessels represented in Plates 41-42 are quite characteristic of ED I, and they seem typical of the first rather than the second half of that period. They are thus useful not only for the comparative dating of finds from our own sites but also for tying into our scheme of stratification certain materials from other sites.⁸²

The sherds illustrated in Plate 43 are from Houses 9 or 8 at Khafajah. Two of them (*c-d*) clearly belong to large four-lugged neckless jars of the type just described. Two others (*a-b*) apparently also belong to such vessels but are decorated respectively with deeper incisions and impressions; *a* has a beak-lug and multiple notched ridges with series of deeply incised chevrons between them; *b* has a broad lug but no pronounced gutter below the rim and is covered with so-called "fingernail"-impressed decoration instead of incisions. Similar sherds were found in the H 18:14 sounding at Tell Asmar (Pl. 64:2-3), and a sherd with impressed decoration occurred in the D 15:3 sounding also (Pl. 63:34). Fragments *e-f* illustrate the two most common reserved-slip patterns (see also Pl. 39), which are often combined with a single or a multiple row of impressions at the top of the shoulder. It is doubtful, however, whether these two sherds belonged to four-lugged jars. Plate 43 *g-i* are apparently from vessels with over-all decoration. Sherds *h-i* have bands of deep incisions between notched ridges. Sherd *g* is decorated with rows of excised triangles between such ridges. Excised decoration consists of gashes in the pottery, sometimes shallow and sometimes actually piercing the walls. Usually such gashes are triangular, and they may occur in combination with incisions, impressions, or punctures. Plate 44 *a* shows the upper part of a four-lugged jar from Archaic Shrine II at Tell Asmar which is similar in general shape to those described above in spite of its exceptionally steep and slightly concave shoulder, its narrow rim, and an exceptionally low notched ridge connecting the beak-lugs. Its decoration consists of three rows of deeply excised triangles, many of which penetrate the whole thickness of the wall. These rows are separated by vestigial notched

⁸² A few sherds from Kish published by D. B. Harden (*Iraq* I [1934] Pl. VI a 1-6 and 9) thus at once date some graves at that site to ED I.

ridges and bordered below by a double row of rather irregularly spaced round punctures. Peculiar features of the decoration are rectangular panels of crisscross incised lines inserted in the second row of excised triangles (one can be seen at left in photograph).⁸³ The upper part of another jar from the same temple (As. 34:199) is similar in shape (D.504.353*a*) but has rectangular lugs.⁸⁴ Its shoulder is decorated with a row of excised triangles between two rows of incised multiple zigzags. Instead of a double row of round impressions this jar has a corded ridge as the lower border of the design.

A four-lugged vessel of somewhat different shape and entirely covered with excised decoration and notched ridges is shown in Plate 44 *b*. A similarly shaped jar with incised instead of excised decoration filling the spaces between the notched ridges is shown in Plates 42 *c* and 44 *d* (see p. 54). That this type of all-over decoration was not confined to four-lugged vessels is indicated by the upper part of a jar from Archaic Shrine III which has a well defined shoulder, a beveled overhanging rim, and no lugs (Pl. 44 *c*).

"FLOWERPOTS"

Yet another type of vessel often decorated with excised triangles is represented by two complete specimens (Pl. 45 *a-b*) from Hill B at Tell Agrab (Pl. 65:43) and Houses 8 at Khafajah respectively. These so-called "flowerpots" occur with (*a*) or without (*b*) rims. Since practically identical vessels are known from other sites, they serve as a useful criterion in relative dating (see p. 137, n. 62).

STANDS AND BRAZIERS

A distinctive group of utensils often covered with excised and incised decoration consists of stands and braziers of various sizes and forms. The lower part of a large stand (Pl. 45 *c*) from Sin Temple VI at Khafajah is decorated with excised triangles very much like those of Plates 44 *a* and 45 *a-b*. Horizontal rows of triangles are separated by two rows of oblique "fingernail" impressions slanting in opposite directions. The panels between the triangles are decorated with X-like patterns of lightly incised multiple lines. At the bottom there are four pairs of round holes which apparently served as holds for moving the stand. Such holes occur frequently in the so-called "fruit stands" of ED III (see p. 90). Two examples of a smaller and somewhat differently shaped type of stand, of the so-called "cut ware" or "fenestrate ware," were found on Hill B at Tell Agrab (Pls. 45 *d* and 65:39-40). These have reinforced rims at the base and widely flaring tops well suited for holding round-bottomed vessels. They are decorated with three rows of narrow rectangular holes, each row bordered above and below by double incised lines. The metopes between the holes have single-line X-like incisions.

Plate 45 *e-i* show fragmentary stands from Archaic Shrine IV at Tell Asmar. Plate 45 *e*, with rows of excised triangles separated by corded ridges, is similar to but smaller than *c*. Plate 45 *f-g* are more elaborate and exceptional in that each has two lugs and a sort of shoulder, which in *g* at least is crowned with a regular neck and rim. The upper part of *f* is broken but most likely was somewhat similar to that of *g*. The decoration of *f* consists of a combination of crisscross incisions, corded ridges, and excised triangles separated by single or double bands of oblique "fingernail" impressions. Plate 45 *g* has a row of rectangular openings cut in its walls below an incised band. It has no excised triangles but has crisscross incisions over the lower part, bordered above by an incised band, and a notched ridge connecting the lugs. A somewhat wider utensil (Pl. 45 *h*) had rows of oblong holes similar to those of *d*, separated by double rows of oblique impressions. Each of the preserved metopes between the openings is filled with a double-line X-like pattern with two short vertical lines in each resulting triangle. This utensil is different from the others in that it has four projections inside, obviously intended to sup-

⁸³ See also *OIC* No. 20, Pl. IV 2.

⁸⁴ *Ibid.* Pl. IV 1.

port a vessel. At an ED II level we found a nearly complete utensil with such projections together with the plate which had rested upon them (see Pl. 69). There can be no doubt that the latter utensil was a brazier rather than a stand, and this is probably true with regard to *h* also.

A fragment of a brazier with incised decoration and oblong holes in the walls and a narrow base, from Hill B at Tell Agrab, is shown in Plate 65:41. It is uncertain whether a cylindrical fragment with triangular holes between notched ridges (Pl. 65:42), also from Hill B, belonged to a stand or a brazier.

A sherd apparently from a cylindrical stand (Pl. 45 *i*) has two holes at the bottom similar to those of *c*. Two incised marks are probably symbols of temple gateposts such as occur on various kinds of objects in the Early Dynastic and later periods.

It is interesting to note that most of the stands and braziers just described derive from temples. This holds true also for a similar utensil of the Protoliterate period (see Pl. 24 *a* and p. 42) and for some of ED II date (see p. 81). There can be little doubt, therefore, that on the whole such utensils were intended for ritual rather than domestic use. Indeed, they are often depicted in ritual scenes on cylinder seals and plaques. In our opinion such utensils served various purposes; some were definitely stands, others (e.g. Pl. 45 *h*) were braziers which occasionally could have served as censers.⁸⁵ The significance of this class of utensils for foreign connections is mentioned below (p. 134).

SOLID-FOOT GOBLETS

Among the plain vessels characteristic of the early part of ED I are solid-foot goblets (B.007.700, B.076.700, B.077.700, B.086.700, B.087.700). Such vessels are usually found in great numbers and are, indeed, so prominent that a "period" was named after them by the excavators of Ur.⁸⁶ They are roughly conical, sometimes slightly flaring at the top, and have a short flat solid foot widened at the base. Their walls are comparatively thin and sometimes show traces of reserved slip (e.g. Pl. 46 *g-h*) over a buff or reddish biscuit. Although these goblets were wheelmade, they were often distorted and "discards" are fairly common (e.g. Pl. 46 *i*); this would indicate that they were made in great numbers and without particular care. There is some reason to think that they served mainly for ritual purposes, for literally hundreds of them were found in a small room (D 17:26) of Archaic Shrine III of the Abu Temple at Tell Asmar.⁸⁷ They occurred at Khafajah also, though in smaller numbers, in the courtyards of Sin Temples V⁸⁸ and VI and in the filling between them. It has been suggested that these goblets might have been "deliberately broken in the course of some ritual."⁸⁹ But it should be noted that their thin fragile upper parts could hardly have withstood even normal use for any length of time without breaking. We actually found several unbroken examples and fragments of others in a state which clearly indicated that breakage was caused by the pressure of debris rather than by deliberate action. At Khafajah such goblets occurred also in burials, nearly all of Houses 11-9. At Tell Asmar several specimens were found in the D 15:3 and H 18:14 soundings, beginning in both at 26-27 m. (Pls. 63:44, 5 and 64:11, 9). At Tell Agrab several specimens were found on Hill B (Pl. 65:46-50).

From their find-spots and distribution it is apparent that the popularity of these goblets reached its peak before the end of ED I. But, although comparatively short-lived, this type was widespread and occurred at nearly all sites where remains of ED I are extant. It seems inconceivable that it should have appeared independently at the same time at all these sites. Consequently it must have spread from a single center, and a certain length of time must be al-

⁸⁵ Langdon, who considered all such utensils to be censers, would identify them as the *niknaku* mentioned in texts (*Kish* IV 15, n. 1).

⁸⁶ *AJ X* (1930) 331 and 339.

⁸⁸ *Ibid.* p. 34.

⁸⁷ See *Pre-Sargonic Temples*, Fig. 125.

⁸⁹ *Ibid.* p. 166.

lowed for such a process. According to our observations at Khafajah it would appear that the earlier specimens are less often distorted, are slightly shorter, and have a somewhat wider foot than the later ones. It is possible, however, that this distinction is merely of local occurrence; so far it has not been substantiated by observations elsewhere.

Goblets not greatly different from ours in shape were recently found in 'Ubaid context at Tell 'Uqair.⁹⁰ However, it seems improbable that the ED I goblets were directly descended from this earlier type, for none were found in levels of intermediate date.

SINGLE-LUGGED JARS

Single-lugged vessels, at least one specimen of which was found in a Protoliterate level (see p. 42 and Pl. 23 *l*), become very prominent during ED I, when they occur in a considerable variety of sizes and shapes (Pl. 47 *a-e, g-k*). Generally they are fairly tall and have well defined shoulders and ring bases; the straight or slightly flaring necks are of medium height and width; the rims are usually of the beveled-ledge type. A single or double row of oblique incisions often decorates the base of the neck. Their outstanding feature is a single unpierced triangular or wing-shaped lug. It is attached sometimes at about the middle of the shoulder and sometimes at the junction of shoulder and body.

The earliest example among the jars shown in Plate 47 (*a*) is from a grave of Houses 11 at Khafajah. It is rather small compared with the others and has an unusually small lug. In shape it resembles very closely a vase found in Houses 11 (Pl. 2, Kh. IX 196) on a floor which may date either from the very end of the Protoliterate period or the beginning of ED I. The latter is unique among the single-lugged jars in that it has a fine reddish slip and is well burnished. Although no other complete specimens of this kind were found, it is possible that some roughly contemporary burnished sherds belonged to such vessels.

Plate 47 *b-d*, from graves of Houses 8 at Khafajah, show somewhat differently shaped lugs. A jar from a grave of Houses 7(?) with an unusual scraped surface (*e*) has lost its lug. A vessel with a lug very similar to that of *d* was found in an ED III grave (*f*). It is impossible to ascertain whether it represents a survival of this type into ED III or whether it was an earlier specimen accidentally found by the gravediggers and added to the equipment of the tomb. The fact that its rim is somewhat different from that of the others seems to favor the first alternative. A single-lugged jar probably of the same shape (C.526.373*b*) from another ED III grave presents the same problem. No other examples were found in ED III context.

The jars shown in Plate 47 *g-k* are from Tell Agrab. Two (*g, i*) are exceptionally large and of better than average make. Plate 47 *i* (= Pl. 65:25) has reserved-slip decoration in an oblique pattern. Plate 47 *h* is rather short and has a comparatively large lug somewhat like that of *c*. In addition to the usual band of incisions below the neck this jar has a double zigzag line running part way around the shoulder on each side of the lug. Plate 47 *j* (= Pl. 65:17), with comparatively wide neck and narrow beveled rim, has a very small lug resembling that of *a*. The walls of *k* (= Pl. 65:18) are less curved and its general contour is more angular than usual.

An interesting fragment of a single-lugged jar with what seems to be a potter's mark (see n. 93) was found at 26-27 m. in the H 18:14 sounding at Tell Asmar (Pl. 64:12).

Single-lugged jars seem not to have been confined to domestic use, for they occur in temples also. Two examples from the Shara Temple at Tell Agrab (Pl. 47 *g-h*) are mentioned above. One (*g*) was found buried beneath the upper floor of the earlier building of the temple and contained a large assortment of beads, amulets, and other small objects.⁹¹ Fragments of two large specimens (C.525.373) were found in Archaic Shrine II of the Abu Temple at Tell Asmar. One (As. 34:201) is unusual in that the shoulder, neck, and rim were painted black. The other

⁹⁰ *JNES* II, Pl. XVII 10.

⁹¹ See *Pre-Sargonid Temples*, pp. 253 f.

(As. 34:146) has a notched ridge at the carination between body and shoulder in addition to one just below the neck. A much smaller jar (B.526.273) was found in Archaic Shrine III.

Single-lugged vessels are of particular interest not only because they are very characteristic of ED I and thus help to identify remains of that period, but also because they are the most popular among ED I painted pottery. In fact the so-called "scarlet ware" is confined very largely to this type (see pp. 65-68).

GRAY POTTERY

It appeared from our excavations in the Diyala region that certain gray vessels, both burnished and unburnished, which resemble in fabric the Warka wares and have been mistaken for the latter, should actually be dated to ED I. The simplest shape is an open conical bowl with a flat or slightly rounded bottom (B.022.200). Our examples are of fine gray-black paste, usually burnished both inside and out in either horizontal or vertical strokes (e.g. Pl. 48 *a-b*). Since an identical form occurs contemporaneously in stone, one is inclined to consider such bowls as imitations of stone vessels. This view is supported by the occurrence at Khafajah (Pl. 48 *c*) and Tell Agrab (Pl. 65:45) of gray jars with convex bases and flat rims which so closely resemble certain stone jars of the same period (e.g. Pl. 48 *d*) that at first glance it is very difficult to distinguish between them. The resemblance in the case of the Khafajah jar is heightened by the fact that it is unburnished, and its mat gray surface is thus hardly distinguishable from certain varieties of sandstone. A gray cup from Hill B at Tell Agrab is of a form (B.043.200*a*) which is very suggestive of stone cups. It shows slight traces of horizontal burnishing. A bottle with a pointed base and a narrow neck (Pls. 48 *e* and 65:44) is of fine gray fabric but seems to represent a purely ceramic type. Fragments of very dark gray, almost black, burnished bowls similar to Plate 48 *a-b* were found in Sin Temple VII at Khafajah (Pl. 48 *f-g*). A gray potsherd with a spout (Pl. 63:43), showing traces of burnish, was found at 26-27 m. in the D 15:3 sounding at Tell Asmar.

That gray pottery was not confined to the Diyala region during ED I is shown by a few specimens from Kish.⁹² One of these is identical in shape with our conical bowls. A second is somewhat taller and has concave walls. The third, of special interest, is a goblet which is presumably related to the ordinary solid-foot goblets described above.

Even the comparatively few examples so far found at Kish and in our own excavations seem to indicate that in ED I gray pottery was made in a considerable variety of shapes.

Two fragments of highly burnished orange pottery (Pl. 48 *h-i*) were found in an ED III level at Khafajah. They are unlike any other pottery from that period, and because of their fine fabric, thin walls, and high burnish there is a possibility that they are related to ED I gray pottery. The very prominent burnish marks exclude the possibility of their being stone imitations. Both fragments seem to belong to cups with suspension lugs (cf. B.306.503). A fragment found at 25-26 m. in the D 15:3 sounding at Tell Asmar (Pl. 63:53), though made of coarse yellow clay, has a similar vertical tubular lug.

MISCELLANEOUS POTTERY

By far the most common among ordinary household utensils are somewhat irregular medium-sized conical bowls with string-cut bases (e.g. Pl. 49 *a-b*). Bowls of this type were already prevalent in the accumulation of debris which preceded the building of the Sin Temple at Khafajah (see p. 34) and continued in general use throughout the Early Dynastic period (see pp. 82, 94). The only change observable in them in the course of time is that in later phases they tended to become somewhat smaller and shallower. Variants occurring in ED I

⁹² Kish IV, Pl. XVI 1-3.

are B.002.200*a*, B.083.200, B.085.200, C.002.200, C.003.200, and C.086.200. A rather small variety of this general type (Pl. 49 *c*) with comparatively thicker walls occurs less frequently.

Conical bowls with inner rims (B.003.210*a-b*) were found in ED I context in the D 15:3 sounding at Tell Asmar (Pl. 63:1) and in Hill B at Tell Agrab (Pl. 65:58-65). Such bowls occur in ED II also (see p. 83) and are very common in ED III (see p. 95). Perhaps related to them is a vessel from Archaic Shrine III of the Abu Temple at Tell Asmar (B.183.210). This has a sinuous body and a rim with a shallow gutter. The neck and guttered rim of a large jar was found in ED I context in the D 15:3 sounding at Tell Asmar (Pl. 63:23). In addition to the various kinds of conical bowls we found a few bowls with flat bases and rounded sides, one of which is decorated with incised scallops around the top (Pl. 49 *d*). Others have plain or beveled rims, and some are fairly large (e.g. Pl. 65:69-70). A shallow plate with a thickened flat rim (B.111.210) is another kind of household utensil. A similar rim occurs on a considerably larger vessel from Tell Agrab (C.044.310).

Medium-sized bottles also seem to have been quite common. Most of them are of ordinary buff or reddish clay and have flat or slightly rounded bottoms and comparatively short necks. Plate 49 *e-f* show two from Khafajah, unfortunately incomplete. A few complete specimens (e.g. B.666.620, C.666.520) and numerous fragments indicate that similar bottles occurred both with and without rims. A larger, globular bottle (Pl. 49 *g*) with a slight carination below a short neck was found in a grave of Houses 8 at Khafajah and has parallels from other sites. A rather large gray bottle with a pointed bottom (Pl. 48 *e*) is mentioned above (p. 58).

A considerable number of small jars of various shapes (e.g. Pl. 49 *h* and forms B.515.220, B.516.270, B.525.270, B.545.220*c*, B.545.240*b*) occurred in houses as well as in graves at Khafajah.

Besides the large spouted and single-lugged jars already discussed there existed in ED I a variety of other large utensils. Plate 49 *i* shows a fragment from a large jar with a very short neck and a rounded body which might have had either a round bottom or a ring base. A complete jar of approximately the same size from Hill B at Tell Agrab (Pl. 65:13) has a short neck and a beveled rim and possibly a spout (see p. 78). A still larger vessel from Hill B (Pl. 65:77), with a wide mouth and a roll-rim, has a hole in the bottom and a band of incised decoration below the neck. A pottery drainpipe from Hill B (Pl. 65:78) is presumably of ED I date but may be somewhat later.

Other household vessels include medium-sized jars with carinated shoulders and beveled ledge-rims (C.516.370 and Pl. 65:31, 34), which occur more often in painted ware (see pp. 60 ff.).

A funnel-shaped object from Houses 11 at Khafajah (Pl. 50 *a*) is wheelmade and has rather thick walls. Its flaring neck and a hole in the bottom seem to indicate that it was actually used as a funnel. An incised mark near the bottom cannot be identified, Dr. Thorkild Jacobsen informs me, with any of the known written signs of the period and may thus be simply a potter's mark,⁹³ of which only a very few are known. Curiously enough, a utensil of almost identical shape (Pl. 50 *b*) was found in Houses 5, that is, at about the middle of ED II. We cannot say whether it survived from ED I or was actually manufactured later. Another vessel of unusual form is a small rectangular container with two knobs on opposite walls (Pl. 50 *d*). It came from Houses 9 at Khafajah.

Plate 50 *c*, from Houses 9 at Khafajah, shows one of the very few wheelmade miniature vessels. It is well turned and in shape does not differ greatly from some of the much larger contemporary painted jars. The other miniature vessels from ED I are of shapes A.513.260,

⁹³ This mark is similar to a prehistoric form of the symbol of the Egyptian god Min (see P. E. Newberry in *AAA* III [1910] 50 and Pl. XIX 2). A similar incised mark appears on the shoulder of a single-lugged jar from the H 18:14 sounding at Tell Asmar (Pl. 64:12).

A.516.270, and A.704.220. A somewhat larger jar from Archaic Shrine III at Tell Asmar has two short clay rolls rather clumsily attached to form a double loop handle (Pl. 50 *e*). Another small jar with such a handle (Pl. 50 *f*) is from Houses 7 at Khafajah. Its neck and body may have been turned. A very similar little jar was found on Hill B at Tell Agrab (B.524.271). The double handles on these small pots are perhaps related to more elaborate ones on large vases, of which at least two specimens were found (Pl. 51 *a-b*). Another type of handle found in ED I is a ledge-lug attached at the mouth. In the deep soundings at Tell Asmar specimens were found in both ED I (Pl. 63:13 and perhaps Pl. 64:24) and Protoliterate (Pls. 63:52, 70 and 64:43) context (see p. 42).

Fragments of three large vases (Pl. 51 *a-c*) were found in the lower level of the earlier building of the Shara Temple at Tell Agrab, which is now attributed to the end of ED I.⁹⁴ Plate 51 *a* (=Pl. 65:37) is the upper part of a large jar with a notched ridge between body and shoulder and a double handle formed by two wide straps connected at the bottom by a shallow notched ridge. Plate 51 *b* (=Pl. 65:38) shows fragments of a large jar with a double handle, each part consisting of two pairs of entwined strands connected at top and bottom by a notched ridge. Below the lower ridge is a well cut small round hole the purpose of which is uncertain. This jar had a band of incised decoration around the neck; its surface was decorated with reserved slip somewhat more elaborate than usual, for in addition to the common horizontal and oblique parallel lines it shows concentric-loop patterns just below the handle. As suggested above, the double handles on large vases may be related to the simple double loop handles on certain small vessels (see Pl. 50 *e-f*). The double handle of Plate 51 *b* is more elaborate than the twisted loop handles of the Protoliterate period (see p. 38).

The fragment shown in Plate 51 *c* (=Pl. 65:80) is part of the shoulder of a large jar. It shows oblique parallel lines of reserved slip and plastic decoration in the form of a crescent-shaped corded ridge with two round clay pellets below it. This combination apparently had some symbolic significance. It recurred in an ED III stratum at Khafajah (Pl. 51 *d*) and on certain specimens from Susa (usually with three pellets).⁹⁵

A peculiar type of pot cover, with a hollow squat ellipsoid body and a solid knob-handle, occurs sporadically toward the end of ED I (Pl. 70 *h-i* and perhaps *g*) but is more typical of ED II (see p. 81).⁹⁶ A solid disk with a roll-rim and slightly concave upper surface (C.200.210) was probably used as a lid for a storage jar (see p. 39). A fairly large oval dish (C.802.200) found in Sin Temple VI may have been made at the end of Protoliterate *d*.

PAINTED POTTERY

SCARLET WARE⁹⁷

In describing the late polychrome ware of the Protoliterate period we mentioned certain features which were to become much more prominent in ED I. These are a distinct carination between body and shoulder and the employment of a "fugitive" light red paint which, unlike the fast dark red paint typical of Jamdat Nasr ware, can easily be rubbed off. These features are present on the jar shown in Plate 36 *e* (=Pl. 8, Kh. IX 153). Among the scarlet ware, on the other hand, there are a number of specimens which retain certain features of the late polychrome ware of the Protoliterate period.

⁹⁴ See *Pre-Sargonid Temples*, pp. 255 f. and cf. note by H. F. on p. 260.

⁹⁵ *Mém.* XII (1911) Figs. 247-50 and 331.

⁹⁶ A similar specimen is shown among the pottery from archaic strata III-II at Warka (*UVB IV*, Pl. 20 B b'), which the excavators attribute to the Jamdat Nasr period and which in our terms fall at the end of the Protoliterate period.

⁹⁷ This term was introduced in the field to distinguish a distinctive, newly discovered class of polychrome pottery from the previously known Jamdat Nasr ware and is retained here, though actually the red used is not exclusively scarlet. It should be noted that the terms "vermilion ware" and "Diyala ware" have been used occasionally by other writers to describe the same ware.

Plate 52 shows two nearly complete specimens of this transitional group from Hill B at Tell Agrab. One is of medium size and has a ring base, a well defined shoulder, and a beveled ledge rim (Pl. 52 *a*). It closely resembles the Protoliterate transitional vessel mentioned above even to the extent of having two black bands on the red-painted neck. However, the design on the shoulder (Pl. 135 *a*) is different and seems to reflect more closely the tradition of Protoliterate art in which the principle of composition is the division of the circle into four or multiples of four (see p. 48). Here we have four equidistant crosshatched triangles spaced so that the four panels which separate them form the limbs of a cross. But, in contrast to earlier specimens, each panel contains a different design. The elements of these designs, borrowed from a familiar repertoire, require no discussion.

Plate 52 *b*, a considerably larger, well made vase of fine reddish fabric, is of the same general shape as *a* but, unlike the latter, has a plastic ridge around the top of the shoulder. While the ridge itself is obviously a feature which survived from the Protoliterate period, it differs from the earlier ones (see Pl. 34) in that ornamental studs are absent (see p. 48). It should be noted, however, that this change, though characteristic of ED I, is by no means universal. Indeed, ridges with ornamental lugs occur occasionally on vessels from even later levels of ED I (e.g. Pl. 52 *c* and Pl. 16). The decoration of Plate 52 *b* consists of solid red paint over body, neck, and rim; black bands painted around the base of the neck, at the join of neck and shoulder, and just above the ridge; and a black and red design on the shoulder (Pl. 135 *b*). Once more the design is composed of alternating triangles and metopes. However, the symmetry of the crosslike composition is lacking, the number of triangles and of metopes having been increased to six. All the triangles are bordered by bands consisting of alternating black and red lines instead of the more common solid red bands. Four of the triangles are crosshatched in the usual manner, while each of the other two contains a vertical row of red-filled superimposed lozenges formed by pairs of crossing black lines, each pair starting from that above it and reaching the base of the triangle. Red lines are interposed between the black ones. The six triangles are of roughly the same size but not equidistant; consequently the metopes vary in width. The narrowest of the six metopes is blank. The widest, on the opposite side, is divided into three horizontal zones, the middle one crosshatched and the top and bottom ones consisting of alternating black and red horizontal lines, somewhat more closely spaced in the top zone. Each of the four other metopes, of about equal width, is divided into three vertical panels. In one metope all three panels contain superimposed red-filled lozenges. In another the panels consist of the same motif, crosshatching, and superimposed reserved lozenges between black triangles. The two last mentioned motifs appear in yet another metope, whose third panel is filled with a pinnate motif and separated from the crosshatched panel by a red line. The last metope on this jar has two panels of superimposed red-filled extended lozenges, while the third contains larger crosshatched lozenges.

From Hill C at Tell Agrab come shoulder fragments (Pl. 53 *a*) of a vase very similar in shape and size to Plate 52 *b*. They show a knobless ridge and the same type of design (Pl. 135 *d*; restoration of missing parts is conjectural). The surface was apparently again divided by six not quite equidistant triangles, in this case bordered on each side by a broad red band with a black line in the middle. Two of the preserved triangles are crosshatched by thin closely spaced black lines; in the third, two series of black lines parallel to the sides intersect only partially. Of the four preserved metopes, one is divided by a narrow pinnate motif into two vertical panels, each containing a butterfly motif painted solid black and bordered by multiple black lines. A second metope (upper left) is divided into four vertical panels, each filled with closely spaced black lines, slanting to right and to left in alternating panels and thus producing an over-all herringbone pattern. The next metope (lower left) is divided into five vertical panels, each filled with parallel lines in groups slanting alternately to right and to left within

each panel, the resulting pattern suggesting a woven fabric (e.g. wickerwork, basketry, or matting). The fourth metope is divided horizontally by a band of alternating red and black lines. Above this band is a horizontal intersected zigzag; below it the apices of two red-and-black-bordered crosshatched triangles can be discerned.

A shoulder fragment from Hill B at Tell Agrab (Pl. 135 *e*) is from a jar with a design very similar to Plate 135 *b* and *d*. Unfortunately not enough remained to allow a complete restoration. The spacing of the three preserved red-bordered triangles suggests that originally there were six with the same number of intervening metopes. One of the triangles had a vertical row of superimposed red-filled lozenges of the type which occurs in two of the triangles in Plate 135 *b*. The two others contain two series of black lines parallel to the sides and intersecting only at a few points to form groups of two or three small lozenges, which were painted red. One of the metopes (lower right) shows a herringbone pattern like that in Plate 135 *d*. Another contained hourglass motifs in addition to a herringbone pattern. A third is divided into seven narrow vertical panels, each containing a row of superimposed red-filled extended lozenges. The last of the preserved metopes is divided horizontally by a band of herringbone pattern, with two red-bordered crosshatched triangles above it and three below it.

The upper part of a jar from the lowest level of the Small Temple at Khafajah (see Table III) apparently belongs to the same general type. In the recorded part of the design (Pl. 136 *a*) only two of the red bands meet at the top to form a triangle, while the two others form a trapezoid. The top of this trapezoid is filled with a series of horizontal black lines (cf. Pl. 54 *d*), while the lower part seems to have contained a series of black lines parallel to each side, the innermost two lines crossing at the top. The triangle apparently contained two superimposed conjoint lozenges, each filled with parallel horizontal black lines. One of the metopes contained vertical rows of red-filled conjoint extended lozenges, with red lines between the rows. A second metope, somewhat narrower at the base than at the top, has its upper corners filled with series of parallel black lines sloping in opposite directions. Between the two series of oblique lines is a large lozenge noteworthy for its unusual crosshatching in black and red.

Plate 53 *b* shows the shoulder of a jar more like Plate 52 *a* than *b* in shape and size. However, the red paint employed in its decoration is considerably darker than that in either *a* or *b* and is comparatively well preserved. The composition is again based on the division of the field by means of red-bordered triangles and intervening metopes, but now there are five of each (Pl. 135 *c*). One of the metopes was left blank (cf. Pl. 135 *b*), while each of the four others contains a different design. The most interesting of these is a black-painted horned animal of a type which often occurs on vessels of scarlet ware proper. An amusing detail is the addition of short black strokes on the inside of the border facing the animal, as if the artist intended to supply "vegetation" on which it could "feed" (cf. Pl. 14). In another metope are what seem to be entwined snakes. A third metope apparently was divided into two horizontal zones, the upper reserved and the lower painted red. The upper zone has an intersected zigzag (cf. Pl. 135 *d*) and a curious comblike pattern which may have some representational meaning since it occurs in a representational scene also (see Pl. 59 *a* and p. 68). In the lower zone are remains of what seems to be an X-like motif with short strokes in the resulting triangles (cf. Pl. 45 *h*). On each of the red bands bordering this metope is a single snake.⁹⁸ The last metope contains a crosshatched vertical panel.

A fragment from Archaic Shrine I of the Abu Temple at Tell Asmar shows traces of two narrow triangles or trapezoids between broad red bands (Pl. 136 *b*). One of the triangles contains the familiar motif of superimposed lozenges formed by partial intersection of two series of slanting lines (cf. Pl. 135 *b*, *e*). The execution, however, is rather careless, and the lozenges

⁹⁸ A fragment with a single painted snake was found at 26-27 m. in the D 15:3 sounding at Tell Asmar (Pl. 63:41).

are filled merely with irregular daubs of red paint. The fast red paint employed is of a shade very close to that of Plate 53 *b*.

Two polychrome sherds from Tell Agrab (Pl. 53 *c-d* = Pl. 4, Ag. 36:520 and 526) probably belonged to vessels of the same type as Plate 53 *a-b*. The dark red paint used in their decoration is not greatly different from that of Plate 53 *b* and resembles that of Jamdat Nasr polychrome ware (e.g. Pl. 6). The horned animal painted in black on one sherd (Ag. 36:526) is comparable with that in Plate 53 *b*; the curious style in which the human figure is rendered on the other sherd (Ag. 36:520) is of exceptional interest.

Before discussing the scarlet ware proper it may be well to summarize our observations concerning the transitional specimens. They are fairly large and have ring bases, beveled ledge rims, and well defined shoulders with or without a plastic ridge near the base of the neck. The red paint is on the whole of somewhat lighter shades than that common on Jamdat Nasr ware but in some cases is still nearer to it than to the bright fugitive reds of the scarlet ware proper. The polychrome decoration is confined to the shoulder, while the rest of the vessel is painted solid red. The guiding principle in the composition of the designs is the division of the surface of the shoulder by means of alternating triangles and rectangular or trapezoidal metopes. The number and the spacing of these geometric elements vary, resulting in various degrees of symmetry. The patterns within them consist of various combinations of geometric motifs borrowed from the same general repertoire as those in the Protoliterate period (cf. e.g. the various motifs in Pl. 135 with those in Pls. 5-6), with occasional representational figures. A characteristic feature of the decoration seems to be the division of just one of the metopes in a design into horizontal instead of vertical panels (see Pl. 135 *b-e*). Although the general effect of the decoration is quite pleasing, the designs are overburdened with detail and lack both the clarity of the more symmetrical designs typical of the late polychrome Protoliterate pottery and the liveliness of the coherent representational designs of the scarlet ware proper.

It should be made clear that the transitional painted pottery cannot at present be isolated stratigraphically, since examples were found both among the pottery from the end of the Protoliterate period and in context with ED I scarlet ware proper. Consequently, it would be unwarranted at present to consider this pottery as representing an actual span of time between the Protoliterate and ED I periods. It is not impossible, however, that further excavations may establish such a correspondence.

A large vase from Archaic Shrine III at Tell Asmar (Pl. 52 *c*) is of the same general shape as the transitional vessels shown in Plate 52 *a-b*, but somewhat squatter, and has a plastic ridge with four ornamental studs such as are common on Protoliterate specimens (see p. 48). The composition of the design, however, is very similar to that of several jars of proper scarlet ware. It is confined to the shoulder, below the ridge, and is limited above by a double border consisting of a reserved band of small crosshatched black triangles and a solid red band decorated with a triple zigzag in black. The main part of the design is formed by ten red-bordered triangles which alternate with the same number of trapezoidal panels. Nine of the triangles are crosshatched in black, while the tenth contains only two crossed lines within a smaller triangle. Nine of the panels contain a well drawn plant motif, one of which is flanked on either side by a black band. The tenth panel contains merely two pairs of crossing lines. The triangle and the panel with exceptional motifs are contiguous.

A somewhat smaller, but more elongated, jar from the same level of the Archaic Shrine has no ridge, and the design on the shoulder (Pl. 136 *c*) extends nearly to the base of the neck. Its chief elements are six red-bordered crosshatched triangles not quite uniform in size, shape, and spacing. Of the six intervening panels, four contain two single or double black lines which are parallel to the red bands bordering the triangles and may be considered as belonging to the borders. The widest panel has a butterfly motif between the two double lines. The fifth

and narrowest panel contains merely a single line. In the sixth are two broad superimposed hourglass motifs.

Plate 54 shows scarlet-ware vessels from Hill B at Tell Agrab (*a, e*) and Houses 11 at Khafajah (*b-d*). Plate 54 *a* (=Pl. 65:28) is of the same general shape as Plate 52 *a-b* but is considerably smaller and has a proportionally wider neck. It is made of light buff clay and seems to have a thin cream-colored slip inside as well as outside. The red employed on it is of a bright shade somewhat similar to that on Kh. IX 100 (see Pl. 9). The decoration on the shoulder consists of seven crosshatched triangles bordered by rather broad red bands and so closely spaced that the intervals between them are reduced to narrow triangles or trapezoids. Each of the latter contains two black lines which actually belong to the borders of the crosshatched triangles (cf. Pl. 136 *c*).

Plate 54 *b* (=Pl. 8, Kh. IX 102), of the same shape as *a* but larger, is painted in an even brighter shade of red. The design on the shoulder is very similar to that of *a*, consisting of closely spaced red-bordered crosshatched triangles. The spaces between them are narrow blank triangles, except for one oblong panel containing a butterfly motif (cf. Pl. 136 *c*).

Plate 54 *c* (=Pl. 8, Kh. IX 157) is of the same general type, though somewhat larger and with a less pronounced carination between body and shoulder. The red color employed has a slight orange cast. The design on the shoulder consists of closely spaced crosshatched triangles below a double border. The triangles are bordered on each side by a broad black-bordered red band divided by a black line. The double border consists of a black-bordered red band and a band of red-filled extended lozenges.

The design on Plate 54 *d* is very similar to that of *c* in all respects except that the crosshatching in the triangles does not reach the apices and the tops are filled with horizontal lines instead (cf. Pl. 136 *a*).

A number of fragments from Archaic Shrines II and III at Tell Asmar belonged to jars with designs very similar to those of Plate 54 *c-d*. One such fragment (Pl. 136 *d*) has crosshatched triangles with borders similar to those in Plate 54 *c*. Another (Pl. 136 *e*) has a row of crosshatched triangles alternating with plain reserved triangles below a border like that of Plate 54 *c* except that the extended lozenges are solid black instead of red-filled. In addition, each of the plain triangles contains a double scallop. A more elaborate border above a row of triangles (Pl. 136 *f*) consists of two solid red bands with a reserved band between them. The latter is divided into vertical panels by double black-bordered red lines, and each panel contains two double opposed scallops joined by a series of red lines. Another double border (Pl. 136 *g*) consists of a band with a series of small crosshatched triangles similar to those in Plate 52 *c* but with the apices down and another band with two horizontal red lines. The crosshatched red-bordered triangles below the double border are far apart and alternate with broad panels each containing an hourglass motif composed of crosshatched triangles with fringed borders.

Plate 54 *e* (=Pl. 65:30) shows a jar of unusual shape. It is reminiscent of certain contemporary gray vessels (see Pl. 48 *c*), but it has a narrower rim and is joined to a tall ring base. Both the base and the plastic ridge below the neck are pierced by four suspension holes. The base and the lower part of the body are decorated with four bands alternately coal-black and red. Above these is a reserved band crosshatched in black. The surface from inside the rim to the reserved band is solid red of the bright, nonfast variety (cf. Pl. 8, Kh. IX 102).

Another polychrome vessel of rather unusual form is a small jar with a flat base and a rimless neck (C.554.220) probably from Archaic Shrine III at Tell Asmar. The design is confined to the shoulder, but the body is unpainted. In composition the design (Pl. 136 *h*) is similar to those previously discussed. It consists of three somewhat irregularly spaced red-bordered crosshatched triangles and three exceptionally broad panels. Each panel contains two or three groups of vertical black lines. The upper and lower borders of the design each contain a hori-

zontal wavy line. This last feature, which is rather rare, and the shape of the jar are reminiscent of a unique monochrome-decorated jar from the Protoimperial period (Pls. 112 *f* and 139 *b*).

A jar fragment from Houses 7 at Khafajah (Pl. 136 *i*) represents a variety of scarlet-ware design in which the field is divided by trapezoids instead of by crosshatched triangles. In this case the trapezoids are painted red with black lines over the red. The reserved panels between the red trapezoids contain pinnate motifs. In the recorded part of the design the pinnate motifs are arranged horizontally in one panel and vertically in the other. A sherd from Archaic Shrine III at Tell Asmar (Pl. 136 *j*) seems to represent the same variety of design without black lines in the red trapezoids.

A design on a shoulder fragment from Archaic Shrine IV is divided by black-bordered red bands (Pl. 136 *k*). Each of the resulting broad panels contains two crosshatched triangles without borders. This fragment from the end of ED I is the only one of the whole group which has a plastic ridge at the junction of body and shoulder—a feature which becomes common on ED II vessels (see e.g. Pls. 76–79). Two other scarlet-ware sherds from Archaic Shrine IV are shown on Plate 136 *l-m*. One has a strange plant or flower motif combined with what looks like a quadruped; the other has the common extended-lozenge pattern. Three polychrome sherds from earlier levels of the Archaic Shrine (Pl. 136 *n-p*) and three from the Square Temple at Tell Asmar which are obviously survivals from ED I (Pl. 136 *q-s*) bear unusual designs.

The ED I polychrome vessels discussed so far have no handles, lugs, or spouts. In form and decoration most of them retain features typical of the previous period, though sometimes these are characteristically modified. Another group of contemporary polychrome pottery is less closely related to the Protoliterate wares and more distinctive of ED I. This group consists chiefly of single-lugged jars of a type already described (pp. 57–58). In fact scarlet ware as a whole is confined very largely to this type. The most important difference between the decoration of these vessels and of those discussed above is that the design is not confined to the shoulder. Indeed, though the shoulder is decorated, often in essentially the same manner as that described above, the artist's interest seems to have been concentrated on the larger surface of the body, and in decorating it his predilection seems to have been toward representational designs rather than purely geometric motifs. The most popular subjects for representation are horned animals, birds, and fishes. The birds and fishes are usually painted solid black. The quadrupeds, though occasionally treated in the same manner, are as a rule painted in two colors: the outline and extremities in black, the body in red.

Plate 55 shows three single-lugged jars from Khafajah (*a-c*) and two from Hill B at Tell Agrab (*d-e*). In the complete specimens the rim, neck, and lug are painted red. One (*d*) has two black bands painted over the red on the neck.

The shoulder of *a* (=Pl. 9, Kh. VI 69) is decorated with the familiar motif of red-bordered crosshatched triangles and trapezoids, but the intervening spaces are blank. The reserved surface of the body, between two red bands—one just below the shoulder and the other at the base—is left undivided. On it are painted three horned animals, one with straight and two with crooked horns. Straight lines rising from the back of each animal may represent reeds. Two vertical wavy lines which extend the whole length of the design may be purely decorative, marking the beginning and the end of the scene, or they may represent snakes.

Plate 55 *b* (=Pl. 9, Kh. IX 100) has a more elaborately decorated shoulder, on which red-bordered crosshatched triangles and trapezoids alternate with panels containing pinnate motifs (cf. Pl. 52 *c*). The surface of the body is undivided, and the animals are more summarily sketched than those in *a*.

The decoration on the shoulder of *c* (=Pl. 9, Kh. IX 164) now appears as a row of red-bordered triangles. However, the fact that traces of black paint remain on either side of the lug

suggests that originally the triangles may have been crosshatched in the usual way. Broad red stripes divide the surface of the body into four panels, two containing plant motifs, one apparently a bird, and one a horned animal. A multiple loop attached to the border above the animal may have had some representational significance; such loops are to be found on a few other examples (see e.g. Pls. 11, 13-14).

The unusually narrow pot shown in *d* (= Pl. 65:21) is so carelessly shaped and insipidly decorated that one is inclined to consider it a waster or the work of an incompetent apprentice. Indeed, it is one of the least perfect specimens of painted pottery among our finds. The design on the body (Pl. 137 *a*) consists of four reserved panels separated by red bands. A plant motif is painted in black over the red in one of the bands. Each of the panels contains a rather poorly drawn animal painted solid black and pushed up against the top, leaving the lower part blank. A fissure and the rough surface near the base of the pot suggest that it was broken when taken from the wheel and then clumsily repaired.

Plate 55 *e* shows fragments of a larger vessel of average quality with remains of a horned animal between two vertical bands and, behind the animal, what seems to be a fish. Unfortunately it is impossible to restore the design of even this panel, but one would guess the presence of an aquatic bird above the animal, presumably holding the fish in its beak.

A large vase from Khafajah decorated with figures of birds and animals (Pls. 10 and 56 *a*) is the only example in which red paint is confined to the bands dividing the surface and the actual design is executed in solid purplish black. Although the vase was recovered in numerous fragments and much of the paint was rubbed off, enough was preserved to allow restoration of the designs without any doubt. The decoration on the shoulder consisted of triangles alternating with rather wide panels, the lug taking the place of one triangle. Instead of the usual cross-hatching the triangles contain inverted pinnate motifs. Of the six panels, three contain herring-bone patterns and three the same motif beside a quadruped or a bird. The surface of the body is divided into eight narrow panels, one of which contains a bird very similar to the one on the shoulder; the others contain quadrupeds apparently of two species, one with long wavy horns and the other with straight twigged horns drawn in exactly the same manner as the birds' wings. The juxtaposition of an animal and a geometric motif within one panel, noted on the shoulder, occurs also in two panels on the body. An unusual detail in the representations of the animals is the indication of the hoofs by single or double lines, a feature reminiscent of some representations on Iranian pottery.⁹⁹ Notwithstanding this exceptional feature and the unusual rendering of all the animals in solid black, we cannot consider this jar an importation, for in shape, fabric, and paint it is indistinguishable from other Diyala specimens.

A painted vase from the earlier building of the Shara Temple at Tell Agrab (Pls. 11 and 56 *b*) has a single wing-lug. Its shoulder is decorated with red-bordered crosshatched triangles and panels. Some of the latter contain familiar geometric motifs, others representations of animals and birds. The surface of the body is not divided into panels, but a single vertical red band was apparently intended to mark the beginning and the end of the design, which evidently was conceived as one coherent scene. It represents three grown horned animals and a suckling, apparently in a reed-growing marsh. The nature of the surroundings is indicated by plants in front of and behind each animal, by a row of fishes at the top, and by three aquatic birds, each holding a fish in its beak. On this vase two methods of painting animals are combined; while the three large ones on the body of the jar are painted in two colors as usual, the animals and birds on the shoulder and the suckling kid, birds, and fishes on the body are in solid black. A multiple loop on the back of one of the animals is enigmatic (cf. Pls. 9, Kh. IX 164, and 13-14); it may have had no representational significance, or it may have been intended to represent some feature of the landscape.

⁹⁹ See e.g. SAOC No. 23, Fig. 11:136; Ghirshman, *Sialk* I, Pls. LXX S.119, LXXXI C 1 and D 13.

Another vase from Tell Agrab is especially interesting for it is one of the few specimens on which human beings are represented. Unfortunately many fragments are missing, and thus some details of the vase itself as restored in the Iraq Museum (Pl. 57) are uncertain. The painting reproduced in Plate 12 was made from the sherds before the vase was restored, and hence the spacing is not quite exact. From the fragments found it would appear that the decoration on the shoulder consisted merely of red-bordered densely crosshatched triangles. The surface of the body was divided by vertical red bands into two wide and two narrow panels. One of the latter contained three tall parallel plant motifs; the other was subdivided by a vertical red band into two narrower panels, each apparently containing a winding plant of which very little is preserved. One of the two broad panels contained three female figures, each holding a round object in the left hand and in the right what seems to be a stick. The round objects may represent tambourines, but this is uncertain for long-handled copper mirrors which presumably could be depicted in the same way were found in contemporary graves. The featureless birdlike faces of the female figures and the two or three black lines which represent the hair are noteworthy. The main feature in the second broad panel is a bull tied to a ring by a rope passed through the nostrils (cf. Pl. 15 and p. 69). The ground line for the animal is a red band above a narrow reserved panel which may have originally contained some design. It is interesting that in contrast to other examples the bull's legs are painted red. Above the bull are two birds with spread wings, each holding a plant in its beak. An animal behind the birds was only partially preserved and its restoration is not certain; however, it seems to have been a quadruped. Five semicircles, with radiating black strokes, projecting from the upper border complete the design of this panel. The decoration on this vase may be considered as narrative rather than merely representational, in the sense that each scene depicts objects related to one another functionally as well as decoratively; and probably some relationship between the two scenes is implied. Although there may be considerable divergence of opinion as to the exact interpretation of the design as a whole, there seems to be no doubt that it had some symbolic or religious meaning (cf. p. 69).¹⁰⁰

In addition to the complete or nearly complete single-lugged vases described above, some fragments apparently from such vessels deserve to be mentioned. The shoulder and body fragments shown in Plate 58 *a-b* (= Pl. 137 *b-c*) are from Hill C at Tell Agrab and belong to a large jar over 40 cm. in diameter and probably about 50 cm. high. It was of well fired reddish paste, with a cream-colored slip outside. The colors used in the decoration are coal-black and a shade of red close to that in Plate 15. The design on the shoulder consists of red-bordered cross-hatched triangles alternating with trapezoidal panels each containing a pinnate motif (cf. Pls. 9, Kh. IX 100, and 52 *c*). Probably there were six such triangles and six panels. The fragments of the body show remnants of three panels separated by broad black-bordered red bands with a black line in the middle. The widest panel contains the head and part of the body of a horned animal feeding off a plant. It was painted in the usual manner in two colors. The rendering of the branchlike horns is of particular interest. The design above the animal's back is unintelligible. However, the solid black ellipsoid with an oblique "ladder" above it suggests a bird with its wing.¹⁰¹ To the left of the "ladder" there seem to be remnants of two superimposed hourglass motifs. This point, however, cannot be considered the end of the panel for if it were there would hardly be room for the rest of the animal's body. The second panel contains superimposed hourglass motifs separated by horizontal pinnate motifs. The third had multiple loops (cf. Pls. 9, Kh. IX 164, and 13-14) placed festoon-like against the top and sides. The width of this panel is indicated by the position of the remnants of a multiple loop on the right.

¹⁰⁰ Some parallels for various features of the bull in this design occur elsewhere (see *Mém.* XIII, Fig. 168; Stein, *An Archaeological Tour in Gedrosia*, Pl. XXX), but their interpretation is no less difficult.

¹⁰¹ Cf. rendering of a wing at Jamdat Nasr (Mackay, *Jemdet Nasr*, Pl. LXXX 2).

A few more fragments came from Hill C at Tell Agrab. One (Pl. 58 *c* = Pl. 137 *f*) is a shoulder piece of a comparatively thin-walled jar whose body may have been painted solid red. It shows part of a red-bordered triangle containing three small birds. Part of another reserved space, probably a trapezoid, shows the beginning of a multiple loop in red and black and a series of slanting red lines. Another fragment (Pl. 58 *d* = Pl. 137 *d*), probably also a shoulder piece, shows a large animal painted in solid black with a suckling beneath it. Two black lines above the animal's back are probably legs of another animal. A third, a body fragment from just below the shoulder (Pl. 58 *e* = Pl. 137 *e*), has a broad reserved band filled with groups of thin black lines sloping in various directions and bordered above and below by two narrower red bands. Below it seems to be a row of rather small horned animals painted solid black. It is impossible to determine from this sherd whether the whole surface of the body was divided into panels, but the band near the shoulder and the small size of the animals suggest a continuous frieze.

Plate 137 *g-j* show fragments of scarlet ware from various levels at Khafajah. The geometric motif in *g* and the birds in *g-i* are clear. Less clear are the other representations in *h*. Fragment *j* shows parts of two animals, which seem to represent male covering female. It was found in Houses 4, that is, at the end of ED II, but is clearly of scarlet ware and probably from a single-lugged jar.

A unique and very interesting vase from Khafajah (Pl. 59) was pieced together from several hundred fragments. The few missing pieces were replaced by patches of plaster of Paris, on which the lost parts of the design were restored. It is a four-lugged neckless jar of the type described on page 53 and is the only such vessel among the scarlet ware. It has a plastic ridge connecting the four pierced beak-lugs and forming a gutter below the rim. The paint is exceptional, the red having a pronounced orange tint and brown replacing the usual black (Pls. 13-14). In the shoulder design the four lugs were used as dividing points between four broad panels. Below each of three of the lugs is a narrow panel bordered by red bands and containing two superimposed hourglass motifs.¹⁰² The space beneath the fourth lug is solid red. In two of the broad panels a horned animal feeding off a plant is juxtaposed with a herringbone pattern (cf. Pl. 10). Enigmatic loops (cf. Pls. 9, Kh. IX 164, 11, and 137 *b-c*) are attached not only to the backs of the animals but also to an upper corner of one panel, to the ground line of the other, and to the herringbone motif in each. Each of the two other panels was subdivided horizontally by a red band. Of the four horizontal panels thus formed, three contain horizontal pinnate motifs and the fourth contains a crosshatched band above an intersected zigzag. It will be remembered that similar horizontal elements occur on the transitional polychrome vases (e.g. Pl. 135 *b-e*).

Of exceptional interest is the design on the body of this vase. It is composed of panels of unequal width separated by broad red bands. Four wider panels alternate with four narrow ones, each of the latter containing a simple geometric motif—pinnate motifs in two, a series of loops against each side of the third (cf. Pl. 58 *b*), and a row of superimposed hourglass motifs in the fourth. The spacing of the panels on the body does not correspond to that on the shoulder. Thus the narrow panel with hourglass motifs on the body is not a continuation of any similar panel on the shoulder. One of the four broader panels on the body contains a geometric design consisting of crosshatched "checkers" above a vertical herringbone pattern. The next and widest panel contains an antithetical design of horned animals grouped about a tree, two males on the right and two females on the left. A suckling kid enhances the charm of this scene. The next panel shows two human figures each rendered in a different color, perhaps to indicate male and female. One arm of the darker figure is missing (see Pl. 59 *a*). In the right-hand top corner near the head of the lighter figure is an inexplicable comblike element (cf. Pl. 135 *c*).

¹⁰² On Pl. 14 one of these narrow panels is repeated.

A pinnate motif to the right of the lighter figure and three double loops complete the design in this panel. The fourth panel contains three superimposed horned animals, with loops on the back of the uppermost animal and against the top and the right side of the panel. There seems little doubt that, as in the Tell Agrab vase with human figures (Pl. 12), the three representational scenes on this vase are somehow interrelated and that the whole is meant to express some ritual or symbolic idea, perhaps that of fertility. We feel that any more elaborate analysis of this painting, involving interpretation of the symbolism intended by each element, would be of little value at this stage of our knowledge, though such interpretations, more or less fantastic, have, indeed, been suggested.

While all of the scarlet-ware vases hitherto described were found in their proper context in ED I levels, the stratigraphy of two important vases is uncertain. One of these (Pls. 15 and 60-61) was found in numerous fragments against the inside of the town wall at Khafajah in square K 51 in debris of ED II or III. However, the area had been much disturbed by building activities, and very likely the fragments had been dug up in antiquity from a somewhat lower level. Indeed, were it not for two unusual features of this vase we would not hesitate to attribute it to ED I. Since these features—a flat square upright handle and a plastic ridge at the junction of body and shoulder—both become very common in ED II (see pp. 83-85) we are inclined to date this vase to that period.¹⁰³ Although the neck of the pot was painted red, as in all other examples of scarlet ware, the rim was unpainted and the usual red band at the base was also omitted. The handle was painted red except for a black-bordered panel containing two small birds painted in black. A second black-bordered reserved panel, at the base of the handle, was decorated with short parallel black lines. The surface of the shoulder, of which the greater part unfortunately is missing, seems to have been treated as a continuous band and decorated with a series of reversing triangles, containing alternately crosshatching and a simple plant motif (cf. Pls. 9, Kh. IX 100, and 52 c). The ridge at the junction of body and shoulder was painted red.

What is left of the design on the body (see Pls. 60-61) seems to indicate that the surface was divided into four panels by broad red bands. The narrowest panel extended the whole length of the body and was filled with a representation of a winding plant. The three broader panels were subdivided by horizontal bands near the top. The lower and larger parts each contained a horned animal with birds above it.¹⁰⁴ The best preserved is that below the handle (see Pls. 15 and 60). The others are damaged, but there are indications that each of the animals had a double wavy line running down from its head. These lines recall the representation of a bull tied to a ring by a rope passed through its nostrils (see p. 67 and Pl. 12), but here the double lines extend to the base of the vessel and no rings are indicated. The upper parts of the three broad panels show respectively aquatic birds, crosshatched lozenges (reminiscent of rows of fishes in other specimens; see e.g. Pl. 11), and what seems to be a triple wavy line.

The other vase of uncertain stratigraphy (Pls. 62 and 138) did not come from our excavations but was purchased by the British Museum from a dealer in Baghdad. Reputedly it was found by illicit diggers at Khafajah before our own excavations began. In an attempt to establish the provenience of this vase I made repeated inquiries among the local workmen who professed to have witnessed the illicit diggings (none of them of course would admit having dug there himself). From these inquiries it appeared that the numerous sherds of this large vase (ca. 40 cm. high) were found in square P 43 southwest of the Sin Temple (see Pl. 200). A careful examination of the robbers' holes in this square¹⁰⁵ led me to believe that these sherds

¹⁰³ Unfortunately it has been published as of "Jamdat Nasr" date (see E. A. Speiser in *BASOR* No. 70 [April, 1938] Fig. 6 and p. 10).

¹⁰⁴ Cf. a painted sherd from Tepe Khazinah (*Mém.* VIII [1905] Fig. 250).

¹⁰⁵ Some of the larger holes are indicated on the plan published in H. Frankfort, *Iraq Excavations of the Oriental Institute, 1932/33* (*OIC* No. 17 [1934]) Fig. 60.

could hardly have been found any lower than the level of Houses 6, the earliest stratum of ED II. Although inconclusive in itself, this indirect stratification is corroborated by certain characteristics of the vase. A photograph of the vase as exhibited in the British Museum (Pl. 62 *a*) shows the general shape and some of the design. Though the upper part is broken and no handle or lug is visible, a ridge at the junction of body and shoulder indicates a closer similarity to the last specimen discussed than to any other scarlet-ware vessel. The decoration, though more complex than that on the specimens which were found in our excavations, is no less intelligible, for in this case we can be aided by comparisons with representations on cylinder seals and plaques. Plate 62 *b* shows in drawing the preserved parts of the painting as published by Prof. Sidney Smith.¹⁰⁶ It should be noted that in some parts the traces of paint are so faint as to allow some doubt as to the rendering of details. In Plate 138 I have attempted to restore the entire developed design. The restoration of some of the missing parts is well nigh certain, while that of others is based on comparisons with other painted vases and on parallels from glyptic, sculpture, and inlaid designs of the Early Dynastic period. The general composition of the design is somewhat similar to that of the four-lugged scarlet-ware vase (Pls. 13–14 and 59). Both designs consist of a number of representational scenes, each painted in a separate panel but apparently intended as part of a single connected "picture," most likely with symbolic or religious meaning. On both vases the space between the beginning and the end of the "narrative" scenes is filled with purely decorative motifs. To facilitate comparison these closing panels were placed on the left in the drawings of the developed designs (Pls. 14 and 138). Interestingly enough, each contains two motifs and, apparently by sheer coincidence, in both the upper one is a checker pattern. Only small fragments of the lower motif on the British Museum vase were preserved, but they suggest a winding plant (cf. Pls. 15 and 61*b*). While the two motifs in the closing panel are contiguous on the four-lugged vase, they are separated by a red band on the British Museum vase. Indeed, on the latter red bands subdivide horizontally the following two panels, another feature which occurs on the upright-handled polychrome vase assigned to ED II (Pls. 15 and 60–61).

On the British Museum vase the lowest part in each of the two panels subdivided by red bands contains an animal with a bird on its back. One is apparently an equine, the other a horned animal. One of the middle sections contains two bands of familiar geometric motifs, the other a row of three crosshatched hourglasses with plant motifs at the waist, suggesting sheaves of grain. The uppermost sections depict scenes in which human beings participate, but being more elaborate and unfortunately more damaged they are more difficult to reconstruct. To some extent their reconstruction is based on the probability that they are connected with the better preserved representational scenes painted in the panels which follow. In the latter we recognize at once two familiar scenes, one showing two seated figures facing each other and drinking through tubes from a large jar and the other showing a person (king?) with his attendant in a chariot drawn by four equines. On other objects, such as stone plaques, cylinder seals, and inlaid objects, where such familiar representations occur they are sometimes associated with music scenes;¹⁰⁷ indeed, in his publication of this vase Prof. Smith identified part of a music scene.¹⁰⁸ Accepting this general thesis we may attempt to reconstruct the missing parts of the painting. A bull's head such as is preserved in the top section of the third panel (see Pl. 62 *b*) often occurs, with or without a triangle below it, in representations of harps and lyres;¹⁰⁹ moreover, bull heads decorate the actual instruments found at Ur.¹¹⁰ I

¹⁰⁶ *British Museum Quarterly* VIII (1933/34) 39.

¹⁰⁷ See e.g. *Sculpture*, Nos. 187–88; *More Sculpture*, No. 318; Frankfort, *Cylinder Seals*, Pl. XV *a*; *UE* II, Pl. 91.

¹⁰⁸ *British Museum Quarterly* VIII 40.

¹⁰⁹ E.g. Frankfort, *Cylinder Seals*, Pl. XV *a*; *UE* II, Pl. 105.

¹¹⁰ *UE* II, Pls. 109, 111, 114.

have therefore restored a lyre, endeavoring to supply what seem to be the most salient characteristics of the ancient representations. To the right of the instrument is a standing figure of which the upper part had to be restored. To the left enough of the painting remains to indicate a seated figure, probably a musician. A second seated figure, behind the musician, required little restoration. The palm leaf or branch held by this person is a detail which also occurs on other monuments, especially reliefs.

The design in the uppermost section of the second panel is fairly well preserved except for the upper left-hand corner, but even there the legs and part of a skirt make certain the restoration of a standing figure. The latter is faced by another standing figure, on the opposite side of an unidentified object, the preserved part of which is rounded and crosshatched (see Pl. 62 *b*). The space available and the crosshatching eliminate, I think, the possibility of restoring a human or an animal figure. I therefore adopted the simplest restoration, namely completion of the circle. The circular object thus restored suggests a large drum, which is well in keeping with the restoration of a lyre in the third panel.¹¹¹ If my interpretation is correct, then the strange harpoon-like object in the hand of the seated figure in the same group may be explained as a percussion instrument, perhaps a sistrum.¹¹² The presence of a wild boar with two birds and a fish on its back and of a scorpion(?) under the drum is difficult to explain. Such animals may have been associated with other musical instruments in the way that bulls' heads were associated with harps and lyres.

We may now return to the two remaining panels. The drinking scene required only the completion of one of the seated figures. The section below this scene, separated from it by a band crosshatched in black instead of the usual solid red band, is fairly complete and contains a human figure with an animal on each side. It is interesting to note that, although scenes showing a human figure between two animals are extremely popular in Mesopotamian art, such groups usually portray a conflict between the hero and one or both of the animals.¹¹³ The benevolent attitude depicted here is less common but known.¹¹⁴ It seems also noteworthy that in this group the position of the human figure in relation to the animals corresponds in composition and presumably also symbolically to that of the tree on the four-lugged vase (see Pl. 14). The similarity between the two scenes includes even such a detail as the suckling kid. The surface below the antithetical group on the British Museum vase is so badly worn that it is impossible to determine whether originally it was left undecorated or, as seems more probable, contained an animal or a plant design.

The last and broadest panel, containing the chariot scene, is separated from the preceding one by a band crosshatched in black instead of the usual solid red one. This obviously was done to avoid confusion with the red-painted body of the chariot itself. In restoring the missing parts of the chariot I considered in detail representations of chariots on plaques,¹¹⁵ on the "standard" from Ur,¹¹⁶ and on a painted vase from Susa.¹¹⁷ These representations, as well as a model chariot found in our excavations at Tell Agrab,¹¹⁸ indicate that most likely all four equines in front of the chariot were harnessed to it. The animal below the chariot I am inclined to consider a colt rather than a "reserve."¹¹⁹

¹¹¹ Large drums are represented on later stelae from Telloh (Cros, *Tello*, Pl. IX 4) and Ur (C. L. Woolley, *The Development of Sumerian Art* [New York, 1935] Pl. 63).

¹¹² Cf. *UE* II, Pl. 105, third panel from top.

¹¹³ E.g. the innumerable scenes in which a hero defends a herd against lions (see e.g. Frankfort, *Cylinder Seals*, Pls. X *i*, XI *c*, XII *c*, XIII *a*).

¹¹⁴ E.g. *ibid.* Pl. III *a*.

¹¹⁵ On a plaque fragment found at Ur (*AJ* VIII [1928] Pl. V 1) the wickerwork by which the pole is fastened to the vehicle is especially clear.

¹¹⁶ *UE* II, Pl. 92.

¹¹⁸ *More Sculpture*, Pls. 58-60.

¹¹⁷ *RA* XXXIV (1937) Figs. 1:1 and 2 (pp. 150 f.).

¹¹⁹ Cf. *British Museum Quarterly* VIII 41.

The strange creature on the pole probably represents a bird rather than a monkey. Another bird, above the reins, probably held a fish in its beak.

Summarizing our impressions of this very interesting vase, the most elaborate among the scarlet-ware specimens thus far known, we see that both the form and the decoration suggest that it is of a later date than the great majority of the scarlet-ware vases described above. The specimen most like it is the upright-handled jar (Pls. 15 and 60-61), which has two features typical of ED II (see p. 69) rather than of ED I. The British Museum vase, whose decoration has parallels in glyptic and relief, seems of a still later date and is perhaps from the end of ED II.¹²⁰

ALL-OVER PAINTED VESSELS AND MONOCHROME-PAINTED POTTERY

Related to the scarlet ware by the type of paint employed is a group of vases painted red all over, presumably after firing.¹²¹ They may have a notched ridge at the junction of shoulder and body, four plastic loops on the shoulder, and a ridge near the base of the neck, either plain (D.525.370), notched (Pls. 64:8, 66 *a-b*), or with four decorative studs (Pl. 16). The paint varies from brownish red to bright orange (see e.g. Pl. 16). The plastic loops on the shoulder are undoubtedly imitations of rope handles by means of which large jars of this type could actually be carried.¹²² This type of painted vase survived into ED II (see p. 80).

A number of sherds with monochrome designs were found in ED I context (Pls. 64:14-17, 19 and 134 *g-j*); others are either of the same date or slightly earlier (Pls. 63:40 and 64:26, 33). These fragments are all described on page 47 or pages 74-76. The shoulder of a large spouted jar (D.545.322) is decorated with multiple red lines. This simple kind of monochrome decoration obviously survived from the Protoliterate period (cf. Pl. 19 *h* and p. 46).

¹²⁰ Apparently the fact that this vase is painted in black and red led some scholars to attribute it erroneously to the "Jamdat Nasr" period; see e.g. E. Douglas Van Buren, *The Fauna of Ancient Mesopotamia as Represented in Art* ("Anatolia orientalia" XVIII [Roma, 1939]) p. 28.

¹²¹ Some ceramic experts would therefore term the surface finish "wash" (see *AASOR XXI-XXII* 106 ff.).

¹²² The carrying of large pots by means of ropes and poles is depicted on certain monuments (e.g. plaques from Khafajah [*Sculpture*, Pls. 105, 107]). This mode of carrying is, by the way, compatible with the preponderance in early Mesopotamia of vessels in which the maximum width is well above the middle (forms .4 and .5 in our classification; p. 6) over those with a low center of gravity (form .7), for the former type offers a better grip for any such device.

GROUPS OF PROTOLITERATE AND EARLY DYNASTIC I POTTERY

Before proceeding to the discussion of ED II pottery we need to describe three groups of earlier material. Two of these comprise stratified remains, mostly pottery, from the two deep soundings (in D 15:3 and H 18:14) at Tell Asmar; the third is a group of ED I pottery from Tell Agrab.

Plate 63 shows most of the material, pottery and a few other objects, from the D 15:3 sounding (see p. 28 for discussion of dating). Following is a description of this material in each consecutive meter of deposit, from the top down:

- Level 30-29 m. 1. Rough conical bowl with inner rim (B.003.210a; see p. 59).
2. Spout and shoulder fragment; buff paste, yellowish reserved slip in horizontal pattern.
3. Sharp shoulder piece; orange paste, covered with thin red paint.
4. Spout flanked by two serpents in relief with incised mouth and eyes and impressions on body to mark scales; yellow paste, wheelmade (see pp. 53, 92).
- Level 29-28 m. 5. Large fragment of solid-foot goblet (B.077.700; see pp. 56-57).
6. Sharp shoulder piece; orange paste, painted red.
7. Fragment with corded ridge; reddish surface, gray core.
8. Piece of cylindrical vessel (pot-stand?) with vertical marks inside at right angles to wheel marks, incised decoration.
9. Gray stone bowl.
10. Miniature cup or lid (A.062.200); coarse reddish fabric, wheelmade.
11-12. Shoulder pieces with corded ridges (No. 11 upside down); reddish paste, reserved slip in horizontal pattern.
13. Rim sherd of neckless vessel with ledge-lug at mouth (cf. Nos. 52, 70 and Pl. 64: 24, 43); reddish paste, yellowish slip (see pp. 42, 60).
14. Short spout; coarse yellow-buff fabric.
15. Polychrome sherd (drawn sideways); yellowish-white slip, red and black design. (Nos. 5-7 and 11 represent types which were common in this level.)
- Level 28-27 m. 16. Lower part of pot with ring base; orange paste, covered with thin red paint.
17. Lower part of scarlet-ware pot with flat base; orange paste, bright red nonfast paint.
18. Shoulder piece, probably from four-lugged neckless jar, with incised decoration and corded ridges; yellowish-white paste (see p. 54).
19. Shoulder piece, probably from four-lugged neckless jar, with incised cross-hatching and "fingernail" impressions; yellowish-white paste (see p. 54).
20. Shoulder piece (As. 34:233) with herringbone impressions around base of neck and notched ridge along shoulder edge; reserved slip in oblique pattern.
21. Neck and rim of small jar or bottle; yellow paste.
(Fragments similar to No. 16 were common, and many fragments of stone cups were found at this level.)
- Level 27-26 m. 22. Neck and beveled ledge rim of large jar; painted red.
23. Neck and guttered rim of large jar; coarse buff fabric (see p. 59).
24. Neck and vertical band-rim; coarse yellow fabric.
25. Rim piece with notched ridge.
26. Piece of four-lugged neckless jar with corded ridge, tubular lug, and incised decoration; buff-cream biscuit, slip of same color (see p. 54).

- 27-29. Rim pieces with corded ridges; coarse buff fabric. No. 29 has unpierced knob under rim.
30. Rim sherd of small cylindrical cup with incised line parallel to rim and pierced lug; very thin walls, buff paste, cream-colored slip.
31. Sherd, probably from four-lugged neckless jar, with incised decoration and notched ridge; buff paste, lighter slip (see p. 54).
32. Shoulder piece of four-lugged neckless jar with beak-lug and corded ridge; buff paste, lighter slip.
33. Sherd with corded ridge; buff paste, lighter slip.
34. Sherd, probably from four-lugged neckless jar, with impressed decoration; buff paste, lighter slip (see p. 54).
35. Sherd with corded ridge; buff paste, lighter slip.
36. Sherd with incised decoration; buff paste, lighter slip.
37. Small cup (A.753.200); thin walls, buff paste, whitish slip.
38. Shoulder piece; buff paste, yellow-cream reserved slip in oblique pattern.
39. Shoulder fragment, probably from four-lugged neckless jar, with incised decoration and notched ridges (see p. 54).
40. Monochrome-painted fragment, probably from spouted jar; vertical multiple red lines at right angles to wheel marks (see pp. 47, 72).
41. Polychrome sherd; reddish paste, yellow slip, black-bordered red bands (probably bordering crosshatched trapezoids) and between them a reserved panel containing a black-painted snake (see p. 62, n. 98).
42. Polychrome sherd; black herringbone pattern on whitish slip on shoulder, solid red below.
43. Fragment with spout; gray paste, traces of burnish outside (see p. 58).
44. Large fragment of solid-foot goblet (B.077.700; see pp. 56-57).
45. Poorly preserved seal impression with string impressions through it, probably from narrow cylinder; design shows birds and goats with folded legs and large horns and ears.
46. Half of miniature limestone vase resting on bull.
47. Small oval strainer-spoon (A.802.500) with three holes in bottom; two holes near top are probably for attachment of handle.
48. Flint core flaked off for blades.
- Level 26-25 m.
49. Spout and rim sherd, probably from bowl; coarse yellow fabric, buff slip (see p. 38).
50. Rim piece; coarse reddish fabric.
51. Rim piece; orange paste, painted red.
52. Rim piece of neckless vessel with ledge-lug at mouth (cf. Nos. 13, 70 and Pl. 64: 24, 43); coarse reddish fabric (see pp. 42, 60).
53. Sherd with vertical tubular lug; coarse yellow fabric (see p. 58).
54. Monochrome-painted shoulder piece with part of spout and incised decoration at base of neck; coarse yellowish fabric; red linear design including part of ring around spout (see p. 47).
55. Shoulder fragment of late polychrome ware with plastic ridge; orange paste, fine cream-colored slip, painted red except for panels containing black linear designs (see p. 51).
56. Similar to No. 55 but of light yellow paste with darker red paint (see p. 51).
57. Similar to No. 55; no trace of ridge (see p. 51).
58. Fragment with corded ridge; greenish-buff paste, reserved slip in horizontal pattern.
59. Shoulder piece with deep parallel grooves; greenish-buff paste, no slip.
60. Similar to No. 55 (see p. 51).

61. Monochrome-painted sherd; greenish-buff paste, black bands parallel to wheel marks (see p. 48).
62. Lower part of greenish basalt cup.
- Levels 25–22 m. Sterile sand.
- Level 22–21 m. 63. Rough cup (B.064.200) with deep finger grooves inside; reddish paste.
 64. Upper part of large jar; coarse reddish fabric, yellow-cream slip.
 65. Upper part of jar with three grooves on shoulder; greenish paste.
 66. Neck of jar with slightly thickened rim; buff paste.
 67. Upper part of neckless jar with outturned rim and incised line on shoulder.
 68. Neck and beveled rim of bottle or jar; buff paste.
 69. Narrow neck and wide ledge rim of small bottle; greenish paste, fine yellow-cream slip.
 70. Sherd from rimless vessel with ledge-lug at mouth (cf. Nos. 13, 52 and Pl. 64:24, 43); greenish-buff paste (see pp. 42, 60).
- 71–72. Fragments (As. 34:237 a, c) of Ubaid ware; coarse greenish fabric, designs in thin fast coal-black paint (see p. 29).
73. Small semipictographic tablet (As. 34:64; see pp. 28, 51).
74. Small celt of light green stone.
75. Fragment with lower part of beak-lug; orange paste, covered with thick purple-red paint (see p. 41).
76. Large spout; thin walls, buff paste, no slip.
77. Small globular pot (B.643.520); buff paste, yellow-white slip (see p. 41).
78. Double-strand handle; greenish-white paste (see p. 42).
79. Fragment; buff paste, yellow-white slip, covered with red-purple paint (see p. 51).
80. Small copper cylinder seal or bead; heavily corroded.
81. Monochrome-painted sherd; reddish fabric, buff slip, linear design in thin plum-red paint (see p. 44).

Plate 64 shows most of the material, pottery and a few other objects, from the H 18:14 sounding (see p. 28 for discussion of dating).

- Levels 29–27 m. 1. Cup (B.084.200) with pronounced finger grooves inside (cf. Nos. 10, 31, 78); coarse yellowish fabric, wheelmade.
 2. Fragment of four-lugged neckless jar with notched ridges and impressed decoration; reddish-buff paste, no slip (see p. 54).
 3. Fragment of four-lugged neckless jar with corded ridges and incised decoration; reddish paste, thin cream-colored slip (see p. 54).
 4. Scarlet-ware fragment; buff paste, black-bordered red band and two pinnate motifs in black.
 5. Lower part and ring base probably from scarlet-ware jar; coarse buff fabric, painted red.
 6. Chert sickle element showing polish on toothed edge.
 7. Small copper cylinder seal or bead with incised decoration.
 8. Sherd with imitation loop and plastic ridge; orange paste, yellow slip, painted red (see p. 72).
 9. Large fragment of solid-foot goblet (B.077.700; see pp. 56–57).
- Level 27–26 m. 10. Cup (B.084.200) with string-cut base and deep finger grooves inside (cf. Nos. 1, 31, 78).
 11. Large fragment of solid-foot goblet (B.077.700; see pp. 56–57).
 12. Upper part of pot with wing-lug, single row of impressions around shoulder, and incised potter's(?) mark (see pp. 57 and 59, n. 93); coarse reddish fabric, thin whitish slip.

13. Spout and part of shoulder; reddish paste, yellow-white reserved slip in oblique pattern.
 14. Monochrome-painted shoulder fragment (As. 34:242) with spout and notched ridge; coarse buff fabric, yellow-white slip, surface apparently divided by multiple red lines into panels one of which contains top of star or plant, red ring around spout (cf. No. 29 and see pp. 44, 47, 72).
 15. Monochrome-painted shoulder piece with notched ridge; coarse buff fabric, cream-colored slip, one red line parallel to ridge (see pp. 44, 72).
 16. Shoulder piece (As. 34:240); fine buff fabric, thin yellow-white slip, design in dark brown¹²³ glossy paint: triangular panel with goat looking to right; left of triangle, crosshatched strip and probably yet another panel with crosshatched lozenges; right of triangle, two vertical and two horizontal concave spool-like motifs (see pp. 44, 72, 141).¹²⁴
 17. Monochrome-painted shoulder piece (As. 34:241); coarse buff fabric, white-yellow reserved slip in oblique pattern, two groups of red lines running from neck to shoulder (see pp. 44, 72).
 18. Shoulder piece of small neckless jar with flat rim and double-pierced ledge-lug; fine buff fabric.
 19. Monochrome-painted shoulder piece; multiple red lines (see p. 72).
 20. Bowl of green stone.
 21. Base of large pot; reddish paste, whitish reserved-slip bands parallel to wheel marks.
- Level 26-25 m.
22. Fragment of large spouted vessel with straight neck and beveled ledge rim; reddish paste, buff slip.
 23. Fragment of neckless jar with flat rim and pierced beak-lug; orange paste, no slip.
 24. Fragment of large rimless jar with short straight neck and ledge-lug at mouth (cf. No. 43 and Pl. 63:13, 52, 70); coarse buff fabric (see pp. 42, 60).
 25. Fragment of neck and rim; buff paste, yellow-white slip, painted plum-red.
 26. Monochrome-painted shoulder piece with applied loop impressed with three rows of circles; fine buff fabric, yellowish-white slip, three red lines not parallel to wheel marks (see pp. 44, 72).
 27. Polychrome shoulder piece; buff clay, yellowish slip, badly damaged red paint, three reserved panels each containing a different design in red and black.
 28. Shoulder piece with band of oblique scorings; reddish paste, yellowish-white slip.
 29. Shoulder piece and spout of large monochrome-painted jar (As. 34:238a); buff paste, buff slip, red lines forming panels and ring around spout, traces of star(?) in right-hand panel (cf. No. 14 and see p. 47).
 30. Shoulder piece; coarse yellow fabric, reserved slip in irregular pattern.
 31. Cup (B.084.200) with deep finger grooves inside (cf. Nos. 1, 10, 78); reddish paste.
 32. Sherd with reserved slip in horizontal pattern parallel to wheel marks.
 33. Monochrome-painted sherd (As. 34:238b); buff paste, cream-white slip, pinnate motifs and double band (see pp. 44, 72).
 34. Lower part and ring base of vessel; orange paste, painted red.
- Level 25-24 m.
35. Upper part of jar with wide beveled ledge rim; reddish clay, buff slip.
 36. Shoulder piece of neckless jar with outturned rim; coarse buff fabric.
 37. Spout with flattened lip; coarse reddish fabric, buff slip.
 38. Shoulder piece, probably from four-lugged neckless jar, with pierced beak-lug and wheel-incised line; buff slip.

¹²³ Erroneously called "mauve" in *OIC* No. 19, p. 21.

¹²⁴ At the time of its finding this sherd was identified as belonging to the "Ninevite 5" ware of northern Mesopotamia; see *ibid.*

39. Shoulder piece, probably from four-lugged neckless jar, with pierced beak-lug and corded ridge; yellow paste.
40. Worn cylinder seal of green limestone with row of goats.
41. Sherd of late polychrome ware; reddish paste, cream-colored slip, dark plum-red paint, black and red design (see p. 49).
- Level 24-23 m. 42. Top of vase (C.603.340) of late polychrome ware with wide ledge rim and four rounded knobs around sharply edged shoulder; coarse brown fabric, cream-colored slip, fast red paint, black designs in narrow reserved panels (see p. 49).
43. Shoulder piece of neckless jar with ledge-lug at mouth (cf. No. 24 and Pl. 63:13, 52, 70); fine buff fabric, yellow slip (see pp. 42, 60).
44. Upper part of jar with beveled ledge rim and three wheel-incised lines on shoulder; coarse reddish fabric, fine yellowish-white slip.
45. Top of rimless jar; fine green fabric.
46. Shoulder piece, probably from four-lugged neckless jar, with pierced beak-lug and one wheel-incised line; buff paste, greenish-white slip.
47. Upper part of jar with outturned rim; fine reddish-buff fabric, yellowish-white slip.
48. Rim piece of neckless wide-mouth jar; fine yellow-buff fabric.
49. Shoulder piece and spout; red paste, buff slip.
50. Shoulder piece with four wheel-incised lines; fine greenish-white fabric.
51. Spout; greenish-white paste, no slip.
52. Fragment of white glazed steatite seal.
(Two cups [B.063.200a, C.084.200a] and a cylindrical pot [C.806.610] with holes in the base [see p. 43] come from this level but are not shown in Plate 64.)
- Level 23-22 m. 53. Monochrome-painted sherd; coarse buff fabric, white slip, black design (see p. 44).
54. Shoulder piece with five wheel-incised lines; greenish paste.
55. Upper part of large jar with band-rim and short neck; reddish paste, self slip(?).
56. Rough sherd; reserved slip in horizontal pattern.
- Level 22-21 m. 57. Complete jar (C.536.540); brown-buff paste, cream-colored slip, plum-red paint (see p. 36).
58. Upper part of pot with lines made by smoothing-tool on rim; reddish paste, yellowish-white slip.
59. Lipped spout; reddish paste, yellowish-white slip.
60. Spout with two applied crossed snakes with incised markings (see pp. 38, 92); reddish paste, yellowish-white slip, burnishing marks (Pl. 92 c).
61. Shoulder piece with pierced beak-lug; red paste, white slip, painted plum-red (see p. 41).
62. Monochrome-painted shoulder piece with pierced beak-lug; greenish-white paste, black linear design (see pp. 41, 45).
63. Polychrome shoulder piece with pierced beak-lug; fine buff fabric, whitish slip, black and red linear design (see p. 41).
64. Polychrome sherd with stud on shoulder; fine buff fabric, plum-red paint, red and black design (see p. 51).
65. Shoulder piece with plastic decoration (snakes?); coarse buff fabric, yellowish-white slip.
66. Sherd of 'Ubaid(?) ware; coarse buff fabric, fine cream-colored slip, chocolate-brown design (see p. 29).
67. Shoulder piece of 'Ubaid-ware bowl(?); greenish-white fabric, cream-colored slip, chocolate-brown design (see p. 29).
68. Small semipictographic tablet (see pp. 28, 51).

69. Polychrome sherd; buff paste, whitish slip, coal-black and bright red geometric design (see p. 51).
70. Polychrome sherd; buff paste, reddish slip, bright red and black geometric design (see p. 51).
71. Fragment of ^cUbaid-ware cup; thin walls, fine reddish fabric, cream-white slip, chocolate-brown design (see p. 29).
72. ^cUbaid-ware sherd; fine greenish-white paste, light slip, "tassel" design in dark sepia paint (see p. 29).
73. Sherd with incised decoration; yellowish-white slip.
74. Sherd with two pairs of wheel-incised lines; fine buff fabric, yellowish-white slip.
75. Sherd with wheel-scored grooves; reddish paste, yellowish-white slip.
76. Sherd; coarse reddish fabric, yellowish-white reserved slip in horizontal pattern.
77. Sherd of very hard (almost vitrified) black pottery.
78. Conical cup (C.084.200a) with deep finger grooves inside.
79. Twisted loop handle; greenish paste (see p. 38).
80. Spout; greenish-white slip.
81. Curved spout; buff paste, greenish-white slip.

Plate 65 shows a group of pots found at Tell Agrab, mostly in Hill B, many of which have been discussed separately on preceding pages. However, the group as such is interesting because it includes a fairly representative collection of ED I pottery types. A description of each specimen follows.

1. Large monochrome-painted spouted jar with ring base (D.545.322); red multiple lines.
2. Spouted jar with short neck and vertical band-rim (C.556.242).
3. Spouted jar with short neck and vertical band-rim (C.545.242; Pl. 38 b).
- 4-5. Spouted jars with short necks and vertical band-rims (C.556.242).
6. Spouted jar with carination between body and shoulder, rimless neck, and ring base (C.525.362a); reserved slip on shoulder (Pl. 38 e).
7. Spouted jar with carination between body and shoulder and rimless neck (C.526.262b; Pl. 37 k).
8. Spouted jar with carination between body and shoulder, rimless neck, and ring base (C.525.362a).
9. Spouted jar with carination between body and shoulder and rimless neck (not registered).
10. Spouted jar with carination between body and shoulder, rimless neck, and ring base (C.525.362a; Pl. 38 d).
11. Small spouted jar with carination between body and shoulder and exceptionally narrow rimless neck (C.526.262a).
12. Small squat spouted jar (B.533.252; Pl. 38 f).
13. Large pot with beveled rim (not registered); perhaps spouted (cf. No. 3 and see p. 59).
14. Pot with carination between body and shoulder and rimless neck (not registered); perhaps spouted (cf. Nos. 6-10).
15. Small pot with plastic ridge at join of body and shoulder (not registered); perhaps spouted (cf. Pl. 37 f).
- 16-17. Single-lugged jars (C.526.373); No. 17 shown in Plate 47 j.
18. Single-lugged jar (C.516.373) with narrow incised band on shoulder near neck (Pl. 47 k).
19. Single-lugged jar (D.515.373) with narrow incised band on shoulder near neck.
20. Single-lugged jar (C.516.373) with narrow incised band on shoulder near neck.
21. Single-lugged jar (C.517.273) of scarlet ware (Pl. 55 d).
22. Single-lugged jar (C.516.373).

23. Single-lugged jar (not registered).
24. Top of single-lugged jar (C.516.373) with narrow incised band on shoulder near neck.
25. Top of single-lugged jar (D.526.373) with two narrow incised bands on shoulder near neck; reserved slip in oblique pattern (Pl. 47 *i*).
26. Top of large scarlet-ware jar (D.515.370) with plastic ridge at base of neck.
27. Large painted jar with base lost (not registered).
- 28–29. Scarlet-ware jars (C.514.370*b*); No. 28 shown in Plate 54 *a*.
30. Scarlet-ware jar with suspension holes (C.754.440; Pl. 54 *e*).
31. Jar with carination between body and shoulder (not registered; see p. 59).
32. Small jar with carination between body and shoulder (B.524.270).
33. Small jar with wide neck, flat shoulder, and carination between body and shoulder (not registered).
34. Jar with rounded shoulder and carination between body and shoulder (not registered; see p. 59).
35. Fragments of four-lugged jar (D.516.363) with incised decoration on shoulder (Pl. 42 *f*).
36. Fragments of four-lugged jar with incised decoration on shoulder (Pl. 42 *e*).
37. Fragments of large jar with double handle (D.525.371; Pl. 51 *a*).
38. Fragments of large jar with double handle (Pl. 51 *b*).
- 39–40. Stands or braziers (C.236.010) with perforated walls and incised decoration; No. 39 shown in Plate 45 *d*.
41. Fragments of brazier (C.206.400) with rectangular holes and incised decoration.
42. Fragments of stand or brazier (not registered) with perforated walls and notched ridges (see p. 56).
43. "Flowerpot" (C.014.310) with excised decoration (Pl. 45 *a*).
44. Bottle with pointed base (C.557.620); fine gray fabric (Pl. 48 *e*).
45. Jar with convex base and flat rim (B.754.540); gray paste, burnished, probably imitation of stone type.
46. Solid-foot goblet (B.086.700).
47. Solid-foot goblet (B.087.700).
- 48–50. Solid-foot goblets (B.086.700).
51. Bottle with convex base (not registered; see p. 82).
- 52–53. Bottles (C.666.520).
- 54–55. Bottles with convex bases (not registered; see p. 82).
56. Conical bowl (not registered).
57. Conical bowl (B.083.200).
- 58–65. Conical bowls with inner rims (B.003.210*b*).
66. Conical bowl with roll-rim (not registered).
67. Conical bowl with roll-rim (B.072.210*a*).
68. Conical bowl with flat rim (not registered).
- 69–70. Bowls with flat bases and rounded sides (not registered; see p. 59 and cf. Pl. 49 *d*).
71. Jar with double loop handle (B.524.271).
72. Miniature jar (A.513.260).
73. Small jar (B.526.360).
- 74–75. Small jars (not registered).
76. Large pot with wide mouth and flat rim (C.044.310).
77. Large wide-mouthed vessel (D.544.540) with hole in bottom and band of incised decoration below neck.
78. Drainpipe (E.588.000); perhaps somewhat later than ED I.
79. Shallow ring base of large vessel (not registered).
80. Shoulder fragments of large jar with reserved slip and plastic decoration (Pl. 51 *c*).

EARLY DYNASTIC II

PAINTED POTTERY

In examining the scarlet ware we have seen that at least two vases of this family (Pls. 60–62; see pp. 69–72), both of uncertain stratigraphy, possess certain features on the basis of which they must be considered later than the bulk of the scarlet ware, and that most probably they should be assigned to ED II. Thus we have reason to believe that the art of pottery-painting was not as yet extinct in that period. On the other hand, the few specimens of painted pottery actually found in ED II context (Pls. 5, 7, 136 *q-s*, 137 *j*) may all be considered survivals from earlier periods.

A group of vessels which may be considered intermediate between painted and unpainted pottery consists of medium-sized and large jars of a characteristic general shape (C.514.370*a*, C.515.270) with the entire surface coated with red paint similar to that on the scarlet ware (see p. 72). Some of them have plastic ridges on the shoulder near the base of the neck and at the junction of body and shoulder, and imitation rope handles on the shoulder. Two complete specimens with such plastic ornamentation occurred in ED I (Pls. 16 and 66 *a*), but that such vessels continued into ED II is indicated by sherds. We also found in ED II levels red-painted jars without any plastic ornamentation (Pl. 73 *f-g*) and many sherds of such jars. This group of pottery may indeed be regarded as representing the last phase of painted pottery in our region, for painted specimens from succeeding levels are extremely rare and some of them may have been imported.

UNPAINTED POTTERY

LARGE JARS WITH PLASTIC RIDGES

Several unpainted vessels of the same general shape as the red-painted jars just discussed came from ED II graves at Khafajah (e.g. Pl. 66 *c-e*). The unpainted specimens, however, do not have imitation rope handles and their ridges are plain. Interestingly enough, these deviations make them almost identical in contour with certain polychrome vessels of the Protoliterate and ED I periods (cf. e.g. Pls. 34 and 52 *b*), the only difference being the presence on the ED II jars of a plastic ridge at the junction of body and shoulder.

SPOUTED VESSELS

In ED II, as in preceding periods, spouted jars were common. Some ED II specimens differ very little from earlier ones, while others represent new, characteristic types. Two specimens from graves of Houses 4 at Khafajah (Pl. 67 *a-b*) are decorated with reserved slip like an ED I spouted jar (Pl. 33 *a*). On the other hand, in general contour they are similar to the large ED II jars just discussed (Pl. 66 *c-e*) and in common with them have well shaped ring bases and plastic ridges at the join of body and shoulder. The spouted jars, however, have no ridge at the top of the shoulder and their necks are rimless. Indeed, the latter feature is distinctive, as a rule, of spouted jars of nearly all periods (see e.g. Pls. 19, 37, and 90). To return to the type of jar under discussion, the plastic ridge at the join of body and shoulder is usually plain (e.g. Pl. 67 *a*); occasionally there is a second ridge just below it (e.g. Pl. 67 *b*). The spout is comparatively small and is placed near the neck.

Several other forms of spouted jars occur in ED II levels. Some apparently were developed from earlier forms, others are direct survivals (cf. e.g. Pl. 67 *c-e* and C.546.362 with Pl. 37 *i-k*). Indeed, one of the latter (C.526.362*b*) continues into ED III. A fragment from the Square

Temple at Tell Asmar (Pl. 67 *f*) deserves attention because of the unusual reserved-slip checker pattern on its shoulder. Another fragment from the same temple (Pl. 67 *h*) has reserved slip on the body. A somewhat squattier jar from a grave of Houses 6 at Khafajah (Pl. 67 *g*) represents a less common type. A taller, rounded shape (C.557.422) came from the H 18:14 sounding at Tell Asmar. Two spouted-jar forms which seem limited to ED II (C.546.262, C.556.362) were found in a grave of Houses 6 at Khafajah.

The wide-mouthed spouted pot shown in Plate 74 *h* is one of two found partially imbedded in the floor beside the altar in Small Temple VIII at Khafajah.¹²⁵ Another unusual spouted vessel is a bowl from a grave of Houses 6 at Khafajah (Pl. 74 *g*). From the same level comes a sherd with a double spout (Pl. 91 *b*). A spout decorated with a snake in relief (Pl. 92 *b*) was found in the Square Temple at Tell Asmar (see pp. 92-93).

STANDS AND BRAZIERS

A kind of utensil which survived from ED I, although undergoing distinctive changes in detail, is the tall tubular stand. A representative selection of such stands from the Shara Temple at Tell Agrab and the Square Temple at Tell Asmar is shown in Plate 68 *a-e*. All these specimens apparently served as temple furniture. Although generally the shapes are nearly the same as those in ED I, we now have plain smooth surfaces instead of elaborate incised and excised decoration (cf. Pl. 45). On the other hand, pairs of round holes near the bottom of the stand, which were presumably intended for practical use, and rectangular holes cut in the walls still occur. Simpler and shorter stands, approaching a type which becomes very common in later periods,¹²⁶ now begin to appear (Pl. 68 *f-g*).

Similar to the tall stands with holes cut in the walls, though considerably shorter, is a utensil found in the court of Small Temple VI at Khafajah (Pl. 69). It is the only one among our finds about which there is no doubt as to its use as a brazier. Three rows of oblong holes and the incised decoration recall certain ED I specimens (e.g. Pl. 45 *d, h*). However, four projections on the inside (see Pl. 69 *a*) suggested that this was no ordinary stand. Fortunately, moreover, we found near by a thick roughly made plate (Pl. 69 *b*) which fits exactly into the stand and rests on the projections, so that we now have the first complete set of this type (Pl. 69 *d*). As to how it functioned, one may imagine that a few live coals were put into the plate, which was then placed in position and more charcoal was piled on top of it, the holes below and around it providing the necessary draft.

In addition to the stands shown in Plate 68, which all derive from temples, simpler stands of various sizes were found in private houses (B.356.000, B.357.000, C.356.000, C.357.000). Some of these, from ED II and III graves at Khafajah, are shown in Plate 70 *a-d*. One may assume that the tall ones (*a, d*) served as "tables," while the smaller ones (*b-c*) apparently were used to hold vessels containing hot food or drink. Several such stands were found in position still supporting clay, stone, or metal cups. Some of the tall stands have twisted stems (C.357.000*a-b*). Although such simple household stands occur occasionally in ED III (see p. 91), they are rather typical of ED II.

JAR COVERS AND UNUSUAL UTENSILS

A peculiar type of jar cover consisted of a small squat body with a solid knob-handle instead of a neck (Pl. 70 *e-f*). Sometimes there is a small hole near the handle (as in *e*) presumably to prevent cracking. On the whole such covers are characteristic of ED II, as indicated by numerous sherds, though a few specimens were found in ED I context (see p. 60).

Four ED II vessels are unique. A small handmade double vase (Pl. 71 *c*) from Sin Temple

¹²⁵ See *Pre-Sargonid Temples*, p. 111 and Fig. 102.

¹²⁶ E.g. Starr, *Nuzi II*, Pls. 93 C-E, 94 A-D and G-I.

VIII at Khafajah has two compartments, presumably for cosmetics, and may have been an imitation of a stone container. The lower part of a tall goblet from the Square Temple at Tell Asmar (Pl. 70 *j*) resembles somewhat the solid-foot goblets of ED I (see Pl. 46) but is more regular in shape and of better workmanship. A jar from the Shara Temple at Tell Agrab (Pl. 70 *k*) has two fairly large transversely placed loop handles and three short legs which form a sort of tripod. Such tripods are very rare in our pottery and are confined almost exclusively to the "studded" ware of ED III and later periods (see p. 102).¹²⁷ Finally, a fragment of a box made of gray paste is shown in Plate 71 *b*. At the base there is a break indicating the presence originally of a short knob or foot. The comparatively thick walls were decorated with three rows of excised (or impressed) triangles with apices alternately up and down (cf. Pl. 106 *f*), originally filled with white paste. The view at the left shows the sherd as found, with the white preserved only in part of the upper register; in the other photograph the rest of the triangles have been filled to give a better impression of the original appearance. In the restoration of the whole box the missing part is drawn in a lighter shade.

A funnel-shaped object from Houses 5 at Khafajah (Pl. 50 *b*) is almost identical in shape with a utensil from Houses 11 (Pl. 50 *a*) which very likely was actually used as a funnel (see p. 59).

Two containers shaped like plano-convex bricks (C.861) were found in a room of the Temple Oval at Khafajah (see Pl. 107 *d* and p. 103).

Large neckless jars, so characteristic of ED I (see Pls. 40–42), were apparently less common in ED II, for only scattered sherds of such vessels were found and some of them may have survived from the earlier period. However, a fragmentary specimen from Houses 5 at Khafajah (Pl. 71 *a*) may be indicative of the changes that the type had undergone by this time. Though it still has a flat rim, both the ridge which formed a gutter below the rim and the four pierced lugs have disappeared. Incised decoration is still used, but in addition to simple crosshatching there are two double panels in which fish are depicted. Perhaps this innovation of using incising for representational designs was brought about by the gradual cessation of the manufacture of scarlet ware, on which such motifs are very common. Not only fish but other, more elaborate, representations were incised on pottery after the earlier painted wares had died out (see p. 88 and Pls. 80 *c* and 85 *b*).

ORDINARY HOUSEHOLD POTTERY

A great part of the ordinary household pottery of ED II consisted of small, generally poorly made, jars. Plate 72 shows a variety of such jars, all except one (*j*) from the earliest stratum of this period at Khafajah (Houses 6). Most of them have flat, sometimes string-cut, bases; a few have convex bases (*k-l* and form B.546.520) and are rather similar to ED I bottles represented among Tell Agrab finds (Pl. 65:51–55). A somewhat larger and better made specimen (*m*) has a ring base. The necks are usually rimless and somewhat flaring (*a-g*, *k-l*), but vertical band-rims occur (*i-j*) and *m* has a beveled ledge-rim. Such jars occur also in later ED II strata at Khafajah (Pl. 73 *a-d*, *h-k*), but some of these are more regular in shape.

A vessel from a grave of Houses 4 at Khafajah (Pl. 73 *e*) is better made and has thinner walls than the average household utensil, and its outturned rim is also an uncommon feature. A medium-sized jar of a type which becomes more common in ED III is shown in Plate 99 *f*. Other medium-sized jars are represented by a form with a wide mouth and a convex base (C.545.640) which occurs also in ED III (see p. 99).

Other types of ED II household pottery are shown in Plate 74. A conical bowl with a string-cut base (*a*) is both smaller and shallower than the very common shape B.002.200*a*. Taller

¹²⁷ Comparable with our specimen is a small jar, from layer G of the Ishtar Temple at Assur, decorated plastically with human features and snakes (WVDOG XXXIX 52, Fig. 32).

bowls occur occasionally with flat ledge-rims (*c*). Conical bowls with inner rims (*b*, *d-e*) appeared in ED I (see p. 59) and survived throughout ED III (see p. 95). Two specimens shown in Plate 97 (*a*, *e*) may belong to ED II. A large cup (Pl. 74 *f*) of a shape which occurs more often in stone may perhaps represent a continuation of the pottery technique developed in ED I (see p. 58) which produced almost perfect imitations of stone vessels. A small shallow bowl with sharply inturned shoulder (Pl. 74 *k*) is of a shape which occurs in ED III also (see p. 95). Plate 74 *l-m* show globular bottles with fairly narrow necks and wide beveled ledge-rims—a type which survives in ED III (see p. 99). The two spouted vessels shown in Plate 74 (*g-h*) are discussed on page 81. Plate 74 *i-j* are miniature vessels, the latter similar to earlier four-lugged jars (e.g. Pl. 22 *b, f*), though its lugs are unpierced. This jar, though very small, was made on the wheel. We have no reason to doubt its context, but it is not a typical ED II form and thus is not a safe guide for chronological comparisons.¹²⁸ A fragmentary vessel of apparently the same shape but with perforated lugs was found in ED III (see p. 98).

FLASKS

The peculiarly shaped vessels shown in Plate 75 *a-e* are similar to the so-called "pilgrim flasks" or canteens of much later times. Like the canteens they are lentoid and were assembled from various wheel-turned parts. They all have fairly narrow necks and beveled ledge rims; most of them have two vertical side ridges projecting slightly above the shoulder and below the base. Most of these flasks are of common buff or reddish clay, but some occur in fine gray paste resembling that of the gray ware of ED I (see p. 58). Plate 75 *f* represents a different type of lentoid flask; it is nearly flat on one side (see drawing for section) and originally had a suspension loop on each side of the neck. The stratification of this specimen is uncertain, but, since it resembles the type found in ED III, it may belong to that period (see p. 100).

JARS WITH UPRIGHT HANDLES

The earliest well stratified specimens of jars with upright handles derive from the latest phase of the Archaic Shrine of the Abu Temple at Tell Asmar.¹²⁹ One is shown in Plate 80 *a*, and the upper part of another in Plate 76 *a*. The latter is of fragile grayish clay. While it is from a jar considerably larger than later specimens, it has features which are typical of them—a beveled ledge-rim, a notched ridge, and incised decoration. The flat upright handle is, however, unusually broad and rather elaborately decorated with vertical plastic ridges on the sides and in the middle and with simple incised linear designs. The ridges and the incised decoration extend onto the shoulder, which is also decorated with reserved slip.¹³⁰ The jars shown in Plate 76 *b-e* are from graves of various strata at Khafajah. The earliest (*b*) is from a grave of Houses 6, that is, from the beginning of ED II. The shape of this jar and such features as the beveled ledge-rim, the notched ridge at the base of the shoulder, and the incised decoration on the shoulder are almost identical with those of *a*. Moreover, though the handle is undecorated, the top edge is drawn out at the corners and in the middle in a manner which would result simply from flattening the ridges of such a handle as that of *a*. Thus the two specimens are closely related. Two jars (*c-d*) are from graves of the succeeding stratum, Houses 5. Their shapes, rims, and incised decoration are very much the same as those of *b*. The handle of *c* is also broad and slightly drawn out at the sides, but not in the middle. Its incised design, especially the three vertical double lines, is suggestive of the combined plastic and incised decoration on the handle of *a*. The handle of *d* is considerably smaller and bears a different

¹²⁸ A small four-lugged jar from Tepe Giyan which has been compared with the one shown in Pl. 74 *j* (SAOC No. 23, p. 48, n. 89) has pierced lugs and is in this respect more like some of the small four-lugged jars of the Protoliterate period.

¹²⁹ Two specimens of form C.526.371 were found in ED I graves of uncertain stratification.

¹³⁰ A drawing of this jar is reproduced in OIC No. 20, Pl. II 8.

type of incised design, which recurs often in later examples. Plate 76 *e*, from a grave of Houses 4, that is, from the last stratum of ED II, is of the same general shape but is somewhat more slender and its beveled ledge-rim is steeper, approaching a band-rim. It has incisions on the shoulder and a notched ridge around it, but the handle, which is even smaller than that of *d*, bears no decoration whatever. The exact stratification of the jar shown in *f* is uncertain, but it probably dates from the end of ED II. Except for a more regular shape it has all the characteristics of the other specimens, and the design on the handle is very similar to that of *c*.

Thus we have a group of vessels extending from the end of ED I to the end of ED II which resemble one another so closely that they must be considered as variants of a single type.

Specimens of a slightly different variety of upright-handled jar (Pl. 77) have either one or both of two features—a vertical band-rim (sometimes called “crown rim”), which often reinforces a somewhat flaring neck, and a “spout-handle,” that is, a handle made by flattening the end of a spout. A jar from a grave of Houses 4 at Khafajah has both features, which show clearly in Plate 77 *a*. Its form, however, is exceptional chiefly because of the rather steep shoulder, which is decorated with an undulating scraped band (see pp. 87–88) and a notched ridge. The somewhat large handle is plain. The vertical band-rim is considerably wider than the neck. Two jars from graves of Houses 6 and 4 respectively (*b-c*) have spout-handles but are of the same shape as the jar shown in Plate 76 *e*. A comparatively tall specimen with a rather wide neck, a band-rim, and a tall ring base (Pl. 77 *d*) is from a grave of Houses 3 and thus from the beginning of ED III. Two other jars, from graves of Houses 3 and Houses 4 or 3 respectively (*e-f*), are comparable in general shape with the jars shown in Plate 76 but have vertical band-rims and spout-handles. A smaller, comparatively slender jar from Houses 3 (Pl. 77 *g*) has a proportionately large handle with two little clay knobs. This handle may be regarded as a forerunner of the so-called “goddess-handles” (see p. 89).

The jars shown in Plates 76–77 seem to demonstrate a preference for combining beveled ledge- or overhanging rims with flat solid handles and vertical or flaring band-rims with spout-handles. This preference is further illustrated by two jars of each type shown in Plates 78–79. The two with solid handles and beveled overhanging rims (Pl. 78) are from graves of Houses 6 at Khafajah. They are practically identical in every respect except for the incised designs on the shoulders. Both have incised bands around the base of the neck, and their handles are similarly decorated. However, while the design on the shoulder of *a* consists of two incised chevrons on either side of the handle, that on *b* consists of similarly placed crosshatched triangles with the apices down, the outer one on each side ending in a palm-branch motif.

The two jars with spout-handles and flaring band-rims (Pl. 79) are from graves of Houses 3 at Khafajah. The decoration of each consists of a single row of incisions around the base of the neck and on the shoulder a series of incised crosshatched triangles (see also Pl. 85 *a*) reminiscent of those painted on pottery of earlier periods. The design on each handle consists of multiple zigzags forming a crude herringbone pattern. An unusually large vase combining a spout-handle and a flaring band-rim (Pls. 80 *b*, 85 *b*, and 139 *a*) was likewise found in a grave of Houses 3 (see also p. 88). This type of jar is more popular at the beginning of ED III than in ED II (see p. 87).

The apparent tendency to combine beveled ledge- or overhanging rims with solid handles and band-rims with spout-handles seems to reflect a much earlier tradition according to which ledge- or overhanging rims were very rarely combined with spouts (see Pls. 19, 37–38). This leads us to believe that the jars with solid handles were used chiefly for storing dry substances, while those with spout-handles, though without real spouts, were intended for liquids. It must be stated, however, that while these combinations seem to reflect a prevailing general tendency, numerous exceptions do occur. Thus, for instance, the jar shown in Plate 77 *b* combines a beveled ledge-rim with a spout-handle, while a large vase from Archaic Shrine IV at Tell Asmar (Pl. 80 *a*) combines a vertical band-rim with a flat solid handle. The latter is one of the

very few upright-handled jars with a plain rather than a notched ridge at the base of the shoulder.

The jars from the beginning of ED III which are mentioned above were included in this section for purposes of comparison. They show that there is only a gradual development of upright-handled jars from ED II to ED III. Indeed this development continues within ED III (see pp. 87-90).

"FRUIT STANDS"

Another kind of utensil which developed uninterruptedly from ED II to ED III is the so-called "fruit stand." In general, such a utensil consists of a shallow dish joined to a stand or stem. Although utensils answering this description are very common in widespread regions and periods,¹³¹ those belonging to a definite time and place can usually be distinguished by characteristic shapes and fabrics. Such utensils from southern Mesopotamia first became known to us through the excavation of the "A" cemetery at Kish.¹³² Until recently they were regarded, together with goddess-handled jars (see p. 89), as typical of the Early Dynastic period as a whole. Our excavations in the Diyala region have enabled us, however, to establish the fact that most of the "fruit stands" from the "A" cemetery actually represent only the last stage in the development of these utensils in Mesopotamia.

The earliest "fruit stands" among our pottery derive from ED II levels. We have seen (p. 81) that ordinary household stands were actually found supporting clay, copper, or stone cups. It would not have been surprising, therefore, to find that the "fruit stands" originated in such simple stands having been permanently joined to ordinary dishes. However, in our early "fruit stands" both stems and dishes are more elaborate than either stands or bowls found in contemporary houses and graves. Thus our earliest "fruit stand," from a grave of Houses 6 (Pl. 81 *a*), has a large well shaped flaring stem decorated with plastic ridges, in contrast to such stands as those shown in Plate 70 *a-d*, while its dish is of a type which does not occur as a separate utensil in the same level. This observation is apparently applicable to all variants of "fruit stands" in Mesopotamia. The stem of a taller, more graceful "fruit stand" (Pl. 81 *b*), from a grave of Houses 4, is decorated with five notched ridges with incisions between them. Below the ridges there is a broad band of incised crosshatching bordered above and below by a narrower band containing a single zigzag. Near the base are four parallel incised lines. The dish is decorated with a double undulating incised line on the rim. Plate 81 *c* shows the stem of a similar "fruit stand" from a grave of the same level. Although somewhat shorter, it is of the same trumpet-like shape and is similarly decorated. Fragments of similar stands, varying somewhat in size and decoration, occurred in several ED II graves. Toward the end of the period and while the large, well shaped stands were still in use, smaller stands of squat-ter shapes (C.364.810*a-b*, C.365.810*a*) began to appear. Such stands become predominant in ED III and are best illustrated by well preserved specimens of that period (see Pl. 88).

RITUAL UTENSILS

Two utensils among our ED II pottery were obviously made for ritual rather than household use. The first is a "cult wagon," discovered in one of the rooms of Sin Temple VIII at Kha-

¹³¹ E.g. Persia (*Mém.* XIII, Pl. XII 1; Schmidt, *Excavations at Tepe Hissar, Damghan*, Pl. X H 4641 and Fig. 124; *Tépé-Giyan*, Pl. XX), Anatolia (Hans Henning von der Osten, *The Alishar Hüyük, Seasons of 1930-32* [1937] Part I [OIP XXVIII] Fig. 75 and Pl. VII), Palestine (R. A. Stewart Macalister, *The Excavation of Gezer, 1902-1905 and 1907-1909* [London, 1912] III, Pl. LXXXIV 7; P. L. O. Guy and Robert M. Engberg, *Megiddo Tombs* [OIP XXXIII (1938)] Pls. 8:14, 31:7, etc.; Robert S. Lamon and Geoffrey M. Shipton, *Megiddo. I. Seasons of 1925-34. Strata I-V* [OIP XLII (1939)] Pl. 33:18-20; The Megiddo Expedition, Gordon Loud, Field Director, *Megiddo. II. Seasons of 1935-39* [OIP LXII (1948)] Pls. 145:10, 148:1), Egypt (Guy Brunton, *Qau and Badari III* [London, 1930] Pl. XVII 85 D, P; Petrie, *Corpus of Prehistoric Pottery and Palettes*, Pl. LI 86, 86 B), Indus Valley (Mackay, *Chanhu-Daro Excavations, 1935-36* [American Oriental Society, "American Oriental Series" XX (New Haven, 1943)] Pl. XXV 29).

¹³² Mackay, *Kish "A,"* Pls. XI, XII, XLIX, L.

fajah.¹³³ Two upright-handled jars and a "fruit stand" were among the component parts of this rather intricate object. It seems probable that these vessels had already been baked when they were used along with hand-modeled parts in constructing the object, which was then fired as a whole. Because of this and the various thicknesses of the different parts, the "wagon" was not uniformly baked. As a result much of it had disintegrated into very thin brittle flakes which had to be fitted together to ascertain first the general shape of each component part. Only then could we attempt to fit these parts together, often on the basis of very small joins. After that, the entirely missing parts were restored in plaster of Paris (Pl. 82). Somewhat schematized drawings and a plan at about the height of the human figurines' heads are reproduced in Plate 83. The object consisted of a chariot chassis made of an oblong shallow box with projections at the ends, which were perforated to receive wooden or metal axles to hold clay wheels. The wheels shown in Plate 82 were not found with the "wagon" but were taken from a large number found in the excavations and presumably belonging to model chariots. To one side of the chassis were joined the two upright-handled jars, with band-rims wider than the necks (cf. Pl. 79). On the chassis in front of each jar was a human figurine riding on the back of an animal. The three other sides formed one long wall and two short walls of a model house. A narrow opening in one of the short walls presumably represents a window; two larger openings, one rectangular and one trapezoidal, in the long wall apparently are doorways. Beside one "doorway" was almost certainly a reclining lamb which was found with the other fragments; near the second "doorway," a ladder in relief. The flat roof had a slight parapet, and below the eaves birds were perched on the projecting ends of beams. From the top of the roof there sprang the stem of a "fruit stand." However, its bowl was not found, and the one on the restored "wagon" was taken from a broken "fruit stand" of ED III date. This accounts for the bowl's somewhat asymmetrical fitting to the stem. The incised designs on the shoulders of the vases and on one of the short walls of the model house are from the repertoire well known on upright-handled jars.

Various suggestions have been made concerning the use of this unique object. It might have been used, for instance, in the ceremony of consecrating water, grain, and oil, or, as Frankfort has suggested, for omen-reading which involved the shape of drops of oil floating on water.¹³⁴ In the latter case presumably the two jars would contain the ingredients and the actual omen-reading would be done from the bowl. Whatever its use, the ritual character of this contrivance seems beyond doubt. It belongs to the same general class of objects as altars in the shape of houses known from Assur¹³⁵ and from Baisan in Palestine.¹³⁶ An even closer parallel was found at Nuzi.¹³⁷ The objects from the two last mentioned sites are of course considerably later than ours.

That the use of theriomorphic vases was not discontinued in ED II is indicated by a fragment of such a vase from Khafajah (Pl. 94 e). Unfortunately only part of the body and the two front legs were preserved, and as the head is broken off the animal cannot be identified. By analogy with similarly shaped vessels from ED III (see pp. 93 f.) it would seem that it probably represented a ram. However, in ED III such vessels were usually put on wheels in a manner which recalls the "cult wagon." A bull's-head spout was found in an ED II level of the Shara Temple at Tell Agrab (Ag. 35:499). A small bird-vase from Tell Asmar (Pl. 94 a) may have come from an ED II level (see p. 93).

¹³³ See *Pre-Sargonid Temples*, pp. 58 f. and Figs. 48-49.

¹³⁴ See *OIC* No. 19, pp. 46-50.

¹³⁵ *WVDOG* XXXIX 36 f., Figs. 5-7, and Pls. 14-17.

¹³⁶ Alan Rowe, *The Four Canaanite Temples of Beth-shan* (Pennsylvania. University. University Museum, "Publications of the Palestine Section" II) Part I. *The Temples and Cult Objects* (Philadelphia, 1940) pp. 54-56 and Pls. XVIII 1-2, LVIA 1-3.

¹³⁷ Starr, *Nuzi* II, Pl. 113 A.

EARLY DYNASTIC III

Our collection of ED III pottery is considerably larger and more varied than that of ED II. It includes types which survived from earlier periods as well as new ones, some of which continue into subsequent periods. On the whole it is possible to distinguish between an earlier and a later phase within ED III itself, but since many of the pottery forms are common to both phases and the changes in others are the result of gradual development, it seems best to discuss the pottery of the period as a whole, indicating the developments within it whenever these seem archeologically significant.

JARS WITH UPRIGHT HANDLES

We begin the discussion of ED III pottery with upright-handled jars since this class of pottery survived from ED II and was still among the most characteristic ones of ED III. The variety with flat solid handle and broad beveled ledge- or overhanging rim, which occurred throughout ED II (e.g. Pl. 76 *b-e*), was found also in ED III (C.526.371*a*). Jars with spout-handles were rare at the beginning of ED II but became more numerous toward the end and were preponderant at the beginning of ED III. Several early ED III jars with spout-handles (Pls. 77 *d-e* and *g*, 79, 80 *b*) were mentioned in the ED II discussion for purposes of comparison (see p. 84).

Later specimens of ED III upright-handled jars (C.516.471, C.526.371[?], C.526.471*a-c* and *f*, C.526.471*d*[?], C.527.471[?]) are on the whole of rather indifferent workmanship (Pl. 84). The features which distinguish them from earlier specimens (see Pls. 76-80 *b*) are a taller ring base, which sometimes approaches a pedestal (e.g. Pl. 84 *e*; see p. 105), a taller neck with a correspondingly longer handle, and usually a horizontal ledge-rim. On the whole the handle is placed higher up on the shoulder, and it often touches the rim, though the two are never solidly joined. The walls of the specimen drawn to represent form C.526.471*c* are considerably thicker than average. Its neck and shoulder are decorated with undulating scraped bands. This type of decoration is rather unusual on upright-handled vases but occurs on other pottery types (see below). Two upright-handled jars from graves of Houses 2 and 3 respectively (C.526.471*f*) are larger than average but not quite as large as D.526.371.

Much smaller vessels with upright handles, which are obviously imitations of the jars under discussion, were also found in ED III levels. Two well preserved specimens (Pl. 100 *a-b*), though they have hand-fashioned ring bases, are similar to the large jars in general shape and in the type of incised decoration on the shoulders and the handles. Two similar small jars were found in robbers' holes at Khafajah (B.516.371*b-c*). Another probably of the same shape (Pl. 100 *d*) has an incised shoulder and a notched ridge but only a vestigial handle. It is from Temple Oval III at Khafajah and thus may be later than ED III. A handmade jar with a flat base (Pl. 100 *c*), although of a shape not encountered among the large jars, has an upright handle (broken) and thus belongs to the same group. A jar with a flat base and remains of a possible upright handle (Pl. 107 *b*) was used as a "jewel box" or "safe" (see p. 103). A miniature jar (Pl. 101 *f*) very similar in shape to Plate 100 *d* has traces of a handle or lug on the shoulder.

The decoration on our upright-handled jars of all periods consists almost entirely of incised designs made in earlier phases by a sharp, single-pointed tool and in later phases by a comblike implement. Indeed, though comb-incisions occur on one of our earliest sherds (Pl. 17 *k*), comb-incised decoration does not become common until the end of ED III. The scraped bands which

decorate two upright-handled jars (Pl. 77 *a* and the drawn specimen of C.526.471*c*) are exceptional. However, similar decoration does occur on "fruit stands" (e.g. C.365.810*c*) and on the shoulders of certain wide-mouthed pots (e.g. C.504.370). Although this type of decoration is not confined to ED III, since it occurs in ED II (see Pl. 77 *a*) as well as in later periods, its association with the types just mentioned is quite characteristic of the second phase of ED III. It was also used on the shoulder of a double-spouted jar found below Single-Shrine I at Tell Asmar (Pl. 91 *a*).

The more common, incised designs on upright-handled jars are usually confined to the shoulder and the handle, extending very rarely onto the neck but never onto the body. On all the specimens which we found there is a plastic ridge, usually notched but sometimes plain (see Pl. 84 *e*), at the junction of body and shoulder. As to the designs themselves, they generally consist of simple geometric motifs. One of the most popular, especially in ED II and at the beginning of ED III, is the crosshatched triangle (see Pls. 77 *c* and *f*, 79, 80 *a*, 84 *b* and *e-f*, 85 *a*). There seems no doubt that this motif survived from painted pottery. Another common motif is the zigzag, usually made with a comblike instrument (see Pl. 84 *a*, *c*). Comb-incised decoration sometimes occurs in two or more registers and occasionally extends onto the neck (see Pl. 87 *e*). Less common than simple geometric designs are plant motifs, which usually are combined with geometric elements (see e.g. the specimens drawn to represent forms C.526.471*e* and D.526.371). The design on the latter jar is reminiscent of that on the shoulder of a painted vase (Pl. 52 *c*).

Two specimens from Khafajah have fairly elaborate incised representational designs. One is a large vase from a grave of Houses 3 (Pls. 80 *b*, 85 *b*, and 139 *a*). Besides a plant motif consisting of three "palm branches," one on the handle and one at either side of it on the shoulder, there are two lions, one attacking a horned animal and the other partly covered with crosshatched triangles. Whether these triangles are merely geometric motifs borrowed from the usual repertoire or whether they are meant to represent a net in which the animal is caught, we cannot say. Finally, on the side opposite the handle there is a representation of a building of some sort, probably a shrine. The second specimen, from Houses 2, bore a marshland hunting scene. Unfortunately only parts of the shoulder are preserved (Pl. 80 *c*), but the fragments show traces of fishes, a long-legged aquatic bird, and parts of a boat carrying two people, one of whom is spearing a wild boar. The traditional crosshatched-triangle motif appears at the left of the handle. As we have seen (p. 82), sherds of a large neckless jar from ED II bear incised figures of fish (Pl. 71 *a*). Thus the incised representational scenes under discussion are hardly an innovation of ED III. That they have a considerably older background is also indicated by the plant motif on one and the crosshatched triangles on both, which are probably descendants of the same motifs often painted on Protoliterate and ED I polychrome pottery. Indeed, the elements of the marshland scene are reminiscent of numerous representations of aquatic birds and fishes on scarlet ware. However, the incised marshland scene is more articulate than the usual painted scenes, for while the latter often consist of juxtaposed geometric and representational elements we have here a coherent depiction of action. In this respect the incised scene is more akin to those depicted on cylinder seals and plaques.

Yet to be considered is the decoration on the upright handles. Plates 86-87 show a number of detached handles, some from stratified building remains and others from the surface of the various sites. These handles are grouped according to shape and the types of ornamentation which they bear, but this arrangement corresponds roughly to their chronological development, for earlier jars usually have simply decorated short broad handles (see Pl. 76) while the later ones on the whole have considerably taller handles (see Pl. 84) often more elaborately decorated. The undecorated handle shown in Plate 86 (*a*) was found in a dump and is not accurately dated. Though it is placed first, it need not be considered among the earliest, for

the undecorated handles of ED II (e.g. Pl. 76 *b*, *e*) are usually relatively shorter and tall undecorated handles reaching the rim are found on comparatively late specimens (Pl. 84 *e*). Plate 86 *b-f* are short broad handles. In some (*b-d*) the top edge is drawn out at the corners and in the middle (see p. 83); the others (*e-f*) are flattened spouts (see p. 87). The decoration in each case consists of either single or double crossed diagonals within a rectangle—a design common also on still attached handles of ED II–III (see Pls. 76–78). A tall handle from the surface at Khafajah (Pl. 86 *g*) has double crossed diagonals without a frame. A wider handle (*h*) is drawn out at the corners but not in the middle (cf. Pl. 76 *b*); its simple yet unusual decoration may be comb-incised. The less regular patterns on *i-j* also seem to be comb-incised. A squat spout-handle from Houses 2 at Khafajah (*k*) has herringbone decoration. This motif was fairly common at the beginning of ED III (see e.g. Pls. 79 *a*, 85 *a*). A somewhat taller and less regular spout-handle (*l*) has the same motif, which occurs also on tall solid handles (*m-n*), sometimes inclosed in a rectangular border (*n*). A handle dating from the end of ED I (*o*) has drawn-out corners; a panel of incised crosshatching in the center perhaps corresponds to the central ridge on the handle of Plate 76 *a*. A somewhat larger handle (*p*), from ED II or the beginning of ED III, has an incised crosshatched pattern divided by a vertical groove in the center. Plate 86 *q-r*, respectively a pinched spout and a solid handle, each bear a design which may be considered a crude attempt at a pinnate motif, better examples of which are shown in Plate 87.

A short broad spout-handle (Pl. 87 *a*) is decorated with a pinnate motif which is unusual in that it has two vertical lines in the middle instead of one. The oblique lines on the left were drawn over one of the vertical lines. The pinnate motifs on *b-c* are exceptional in that they are inverted. Like *a*, *c* has two vertical lines in the center. Plate 87 *d* is a tall solid handle on which a pinnate motif is well executed; *e* shows a similar handle still joined to the shoulder of a jar of form C.526.471*a*. In this fragment the tall neck with comb-incised decoration and the wide ledge-rim are also preserved. Plate 87 *f* is a comparatively broad flat handle with a triple pinnate motif. For other handles decorated with pinnate motifs see the drawings of forms C.526.471*f* and C.527.471, Plates 77 *e* and 139 *a*.

All the handles discussed so far have only incised decoration. There are others, however, the so-called "goddess-handles," which have plastic ornament representing human features. Plate 84 *b* shows a comparatively small jar with such features on the handle. This jar, from a trench in square M 51 at Khafajah, is probably contemporary with Houses 2. There are two sets of features on the handle, and both the shoulder of the jar and the handle bear the ordinary type of incised decoration also. A goddess-handle from the surface of Mound A at Khafajah (Pl. 87 *g*) has a single pellet of clay in addition to a crudely incised design. Plate 87 *h* has two pellets and no incisions. In *i-j* three pellets were added above incised decoration. In *i* the pellets apparently represent the eyes and nose; in *j*, the nose and breasts. Even in specimens on which the plastic features are more carefully shaped, incised decoration is often present (e.g. Pl. 87 *o*). On one spout-handle (*k*) the eyes are represented by pellets which are flatter than those indicating the nose and breasts. In addition there are prickings around the "face" and incised crossed diagonals. On a flat solid handle (*l*) the breasts are not indicated, but the eyebrows and nose are modeled and an incised crescent appears between the "face" and an incised inverted pinnate motif. Plate 87 *m* is very similar to *l*, but the pupils are indicated by impressed circles and the crescent below the "face" is more elaborate. A crescent in relief appears on *n*. On a tall flat handle (*o*) the eyes and breasts have impressed circles and the applied eyebrows and crescent are notched. An unusual way of indicating the eyes by a spiral of clay (*p*) suggests an owl rather than a human face. That animal heads were sometimes represented on upright handles is shown by *q*, with a ram's head. However, on this handle too breasts are indicated. None of our examples shows incised triangles such as often occur on up-

right handles from Kish,¹³⁸ though in other respects some of the Kish specimens show very close affinity to those from our sites.¹³⁹

Our stratigraphic evidence shows clearly that the vases with comparatively broad flat handles, often decorated with simple incised linear motifs, are the earliest. Moreover, incised decoration, which comes to include pinnate motifs, is still predominant on specimens from early ED III levels. Goddess-handles begin to appear toward the end of ED III. Indeed, the best specimens of such handles were found near the surface of Mound A at Khafajah, and most of these are of the tall variety associated with jars from the second phase of ED III and perhaps even from the beginning of the Protoimperial period. Our stratigraphic evidence thus establishes the fact that, contrary to some accepted theories, simple representations of the "mother goddess" are not degenerate forms of earlier, more complete "naturalistic" representations but are themselves earlier than the more elaborate, if not artistically perfect, examples which first became known in large numbers from the "A" cemetery at Kish. This evidence has rather important bearing not only on the theoretical question whether schematic representations of natural features must necessarily be considered as degenerations but also on the problem of relative dating of certain important archeological remains in southern Mesopotamia (see p. 144).

"FRUIT STANDS"

In the discussion of ED II "fruit stands" (p. 85) we have seen that the earliest examples were rather tall and well shaped, while toward the end of that period smaller and less graceful specimens began to appear. It is this latter type which continued into ED III.

A few of the better preserved examples from ED III are shown in Plates 81 *d-e* and 88. Three stands dated to the beginning of ED III (Pl. 88 *a-c*) consist of simple conical stems joined to bowls with carinated rims. The stems of *a-b* clearly show wheel marks, while that of *c* was pared to smooth the joint between stem and bowl. Somewhat more elaborate stems have rims at the bottom; Plate 88 *d* has a roll-rim, while *e-f* have sharply defined beveled rims. Notching of the ridges on the rim of the bowl such as is seen in *f* is very common and occurs on the somewhat larger specimens shown in Plate 81 *d-e*. The stems of these two specimens are decorated, in contrast to the plain stem of Plate 88 *f*. The stem of Plate 81 *e* has a plain ridge at its junction with the bowl and a notched ridge just above the sharply defined rim. The stem of *d* has a well defined rim and a notched ridge at a somewhat higher level with incised decoration in two different motifs above and below it. This stem has two round holes below its junction with the bowl and two more in its base. The rim of the bowl has an undulating incised line in addition to the two notched ridges. Of the "fruit stands" which are shown in drawings only, Kh. I 45 (C.363.810*a*) has a rather wide flaring undecorated stem; Kh. III 734 (C.365.810*c*) is similar to Plate 81 *d*, but the stem has an additional notched ridge and is rather unusually decorated with a series of undulating scraped bands (see pp. 87-88). This stand has two pairs of round holes near the bottom and in this respect is reminiscent of the hollow stands of earlier periods (see Pls. 45 *c*, 68 *a-c*). It was chiefly on account of such holes that the excavators at Kish considered the type of utensil under discussion as braziers, since they presumed that the holes were "evidently ventilation holes."¹⁴⁰ It seems to me, however, that this interpretation is somewhat forced and that more likely such holes were used to secure rope or wicker handles.

Some of the numerous fragments of "fruit stands" which we found are shown in Plate 89. A rather large fragment from Tell Asmar (*i*) is decorated with multiple crossing lines and

¹³⁸ Mackay, *Kish "A,"* p. 22 and Pls. II 7-8, XLV 6.

¹³⁹ Cf. our Pl. 86 *b* with *ibid.* Pl. XLV 9 and the treatment of eyes and breasts in our Pl. 87 *o* with *ibid.* Pl. XLV 8.

¹⁴⁰ *Ibid.* pp. 25 f. and 146.

crosshatched triangles on the base and with palm-branch motifs on the stem.¹⁴¹ The rest of the sherds shown in Plate 89 are fragments of stems (*g-h*, *j-k*) and bases or bowls (*a-f*) from Mound A at Khafajah. The incised decoration on these fragments was made in some cases with a sharp single-pointed tool and in others (*a*, *b*, *e*, *h*, *j*) with a pronged or comblike implement. On the whole the incised designs on "fruit stands" are no different from those on upright-handled vases.

HOLLOW STANDS

Simple hollow stands such as occurred in ED II (see p. 81) continue in ED III almost without change. Small and larger specimens of the same shape (B.356.000 and C.356.000) were found in graves of Houses 3 (e.g. Pl. 70 *b*). A still taller stand with a twisted stem (C.357.000*a*) is practically identical to one from an ED II grave (C.357.000*b*).

Shorter and wider stands with one or both of the ends flaring occur in a number of shapes. A rather large stand with one end flaring is C.352.000.¹⁴² The stands classified as C.352.010 are considerably smaller but are included in the C size group because they would hold pots of that group. They flare at the top and have rims at the bottom exactly like those of some of the "fruit-stand" stems (e.g. Pl. 88 *e*). A proportionately taller stand from a grave above the level of Houses 2 has a rim on each end (C.353.010*a*). A specimen from below Single-Shrine I at Tell Asmar (C.354.010), with a notched ridge around the middle and a rim at the bottom, is very much like one from the Square Temple (cf. Pl. 68 *g*).

Although not very numerous in our finds of the Early Dynastic period, stands were undoubtedly fairly common in household use, and some were actually found with round-bottomed pots resting on them. They continue without much change in form into considerably later periods in Mesopotamia.

SPOUTED VESSELS

Other household utensils the use of which continued from earlier periods are spouted jars. However, their number decreases considerably in succeeding strata of ED III, and at the end of the period they become quite rare. Plate 90, in which we illustrate several specimens from graves of Houses 3 at Khafajah, shows that on the whole the ED III forms do not differ greatly from those of ED II (cf. Pl. 67). Forms C.404.362, C.526.362*b*, and D.525.362 have already been encountered in ED II. Besides such survivals there were found a few new, less common shapes. A small pot with a pointed base (B.454.642) has traces of a very narrow spout (see also p. 99). A small jar with a concave base and a wide splayed neck (B.546.122) is of a type which often occurs with a pinched pouring lip. Another form is represented by a very large jar (D.545.542) with a convex base and no carination between body and shoulder. Its band-rim, which is wider than the neck, is a feature which occurs in other types also (e.g. C.525.352, D.526.371). A large jar of rather unusual form, with corrugated shoulder and ridges on the body, when found in a room of Temple Oval II (Pl. 91 *e*), contained lumps of a white substance, probably burnt lime, but, as the spout indicates, it was originally intended for holding liquid. Two spouts belonging to large bowls are shown in Plate 110 *a*, *j*. One has a roll-rim like that of a form (C.053.312) found in the Protoimperial period (see p. 106) and in the Agade period (see Pl. 114 *c*), when such large spouted bowls become very common (see p. 111). Shape C.052.202, a medium-sized bowl with a spout near the mouth, is probably rep-

¹⁴¹ Specimens with elaborate incised representational designs are known from Telloh and Kish (Genouillac, *Telloh* I, Pls. 63:1, 3 and 65; Mackay, *Kish* "A," p. 147 and Pl. XLV 10).

At Ur, where many utensils of this type were found, somewhat elaborate incised decoration seems to have been "actually the rule" (*UE* II 388 and Pls. 180 *b* and 218 U.13709). Woolley's suggestion that some of these "may have been drums of the 'tom-tom' type" (*ibid.* p. 260) seems rather far-fetched.

¹⁴² This is very similar to vessels of type 244 from Ur, which Woolley considered as tom-toms (*UE* II 391).

resented in ED III by a rim sherd with a spout (As. 32:1160). Several spouts which seem to belong to such bowls were found.

Small jars of the same general form as those described on page 95 occasionally have a short spout springing from the shoulder. However, such spouts usually have very small openings, which were often clogged and sometimes compressed, so that they were completely stopped up (Pl. 98 *p*). Obviously such false spouts served only as handles. This peculiar type of jar with clogged spout survives into the Protoimperial period (see p. 106). Wide-mouthed jars of the same general shape occur occasionally with real spouts. One of these (Pl. 98 *r*), probably from ED III, is somewhat larger than average and differs from the other jars in that it has a tall ring base. The spout is rather wide as compared with most of the false spouts. Of the same general shape are two small bottles in which the neck was pinched together to form two "spouts," while the solid part between them was perforated to make a "handle" (Pl. 98 *q*). Although such double-mouthed bottles are comparatively rare, they seem to be confined to about the end of ED III and are known also from other excavations.

The comparative scarcity of ordinary spouted vessels at the end of ED III adds some interest to a double-spouted jar whose upper part (Pl. 91 *a*) was found below Single-Shrine I at Tell Asmar. Double-spouted vessels are represented among our finds of earlier periods. Thus, for instance, Plate 91 *b* shows a double spout from Houses 6 at Khafajah (ED II), and Plate 92 *d* shows one from Archaic Shrine IV at Tell Asmar (ED I). Double-spouted vessels are known also from earlier periods at other sites.¹⁴³ The type of undulating decoration on the shoulder of Plate 91 *a* is found on certain types of utensils from the second phase of ED III (see pp. 87-88) and confirms the dating of this vessel. It is thus apparent that double-spouted vessels, though comparatively rare, were in vogue for a long time. In connection with one such jar found at Kish, Langdon suggested that they may have been ritual utensils.¹⁴⁴ The find-spot of our fragment within a temple area seems to support this view.

Perhaps pertinent in this connection is the fact that spouted vessels, with either double or single spouts, were quite frequently decorated with applied snakes. Thus in Plate 91 *c-d*, showing sherds of double-spouted vessels from the ED III and Agade(?) periods respectively, a snake can be discerned on the outer side of each spout. In Plate 92 we have assembled spouts and other fragments (probably from spouted vessels) with such decoration. A double-spouted fragment (*d*) from Archaic Shrine IV at Tell Asmar (ED I) has two snakes between the spouts. Three single-spouted fragments from Tell Asmar (*a-c*) are each decorated with two snakes; *a* is from the same find-spot as *d*, while *b-c* are from the Square Temple and the H 18:14 sounding (Pl. 64:60), that is, from ED II and Protoliterate *d* respectively. Spouts with single snakes (*e, i-k*) were found in Larsa levels, as was a rim fragment with an applied snake and possible traces of incised decoration (Pl. 126 *f*). The forms of the vessels to which fragments *f-g*, from ED I and III respectively, belonged are uncertain, but they could well be parts of large spouted bowls of a shape (C.053.312) found in the Protoimperial period and very common in the Agade period. A fragmentary specimen of such a bowl from the Agade period is decorated with a snake in relief (*h*). A sherd from the shrine (D 17:10) of Archaic Shrine III (As. 34:252¹⁴⁵) may belong to such a bowl. A painted sherd found in Archaic Shrine II (Pl. 134 *g*) is decorated with an applied snake. A snake-decorated spout was found in the D 15:3 sounding at Tell Asmar (Fig. 63:4). In addition to the fragments illustrated numerous sherds decorated with snakes in relief were found, most of which seem to be spout sherds or fragments of spouted vessels. Only two conventions for indicating the scales of the snakes seem to have been used, either impressed circles (as in Pl. 92 *a-b*) or, more often, fair-sized prickings (as in

¹⁴³ They seem to have been quite common in graves at Ur attributed to the Jamdat Nasr period (*AJ XIII* [1933] 383).

¹⁴⁴ See Mackay, *Jemdet Nasr*, p. 223.

¹⁴⁵ *OIC* No. 20, Pl. III 1.

c-g). Numerous examples of pottery decorated with snakes in relief are known from other sites in Mesopotamia and from other regions.¹⁴⁶ The two above mentioned conventions for rendering the scales seem to have been used without change over a very wide area and in periods far apart. These representations of snakes can hardly be considered purely decorative, and we are inclined to think that in most cases they had religious or magical significance. Their common occurrence in association with spouts might be due to the fact that spouted jars were used in various rituals. A discussion of such rituals or of the religious or magical significance of the snake is, of course, outside the scope of the present publication.¹⁴⁷ Two large vats elaborately decorated in relief with snakes and other figures were found in a shrine of the Larsa period at Tell Asmar (see pp. 121–22). These vessels are undoubtedly of ritual character and led us to name the building in which they were found the “Snake Shrine.”

An unusual spouted vessel from a grave of Houses 2 at Khafajah (Pl. 93 *a*) has several features—general shape, notched ridge between shoulder and body, incised crosshatched triangles on shoulder, and band-rim—which recall the jars with upright spout-handles (cf. e.g. Pl. 79). However, its neck is extremely short and instead of an upright handle it has a short splayed spout flanked by two well modeled rams represented as drinking from it. The bodies of the animals are decorated with a rough herringbone pattern similar to that which occurs on several upright handles (see e.g. Pls. 79 *a*, 85 *a*). It is possible, however, that here the incisions were meant to represent the wool.

Another unusual spouted vessel (Pl. 93 *b*) was found just outside the sanctuary of Nintu Temple VII at Khafajah. It is roughly globular and has two large tubular lugs diametrically spaced along a notched ridge at the base of the shoulder and a short tubular spout between them. The very narrow short neck is somewhat off the center of the dome-shaped shoulder, which is occupied by a solid animal head (ram?). Around and against the animal's neck are applied snakes with their scales indicated by impressed circles. This vessel could easily have been suspended by a cord passing through the two lugs and below the spout and notched ridge. The liquid it contained could then have been poured out in the desired quantity by tilting the vessel, using the animal's head as a grip. These two unusual jars with plastic representations of animals were perhaps intended for ceremonial rather than ordinary household use.

RITUAL VESSELS

Theriomorphic ritual vessels of ED III continue a tradition which began at least as early as the Protoliterate period (see pp. 43 f.). A small bird-vase from Tell Asmar (Pl. 94 *a*) is possibly of ED II rather than ED III date. It has a funnel on the back, like the earlier bird-vases (Pls. 25 *a*, 27), but its beak is solid and could not be used as a spout. The vase certainly could not stand on its two vestigial legs and probably was kept on a small cylindrical stand.

Vases representing rams seem to have been rather common in ED III. They usually consist of a cylindrical or barrel-shaped “body” made on the wheel and a hand-modeled ram's head. Below the body there are generally two perforated projections through which passed axles, each holding a pair of clay wheels. At the front of the body there usually was a perforated lug to which a string could be tied for the purpose of pulling the vessel. A specimen complete except for wheels was found in “House D” adjoining the Temple Oval at Khafajah.

¹⁴⁶ E.g. Telloh (Genouillac, *Telloh* II, Pl. 109:3), Assur (*WVDOG* XXXIX, Pl. 21 b); Susa (*Mém.* XII, Figs. 414–16), Tepe Gaura (Speiser, *Excavations at Tepe Gaura. I. Levels I–VIII* [Philadelphia, 1935] Pls. LXXV 208 and LXXVI 7, 12, 13; *BASOR* No. 51 [Sept. 1933] Fig. 7), Palestine (Alexis Mallon, Robert Koeppl, and René Neuville, *Teleitāt-Ghassūl* I [Institut biblique pontifical, “Compte rendu des fouilles, 1929–32” (Rome, 1934)] Fig. 61:11, 12, 14, 16, and Pl. 52:1, 2, 5). Dr. Braidwood informs me that at Tell Judaidah in Syria one sherd similar to our Pl. 92 *c* occurs in phase G, while another, with impressed circles, belongs to phase F.

¹⁴⁷ One may mention in this connection a lengthy though not entirely relevant discussion of the serpent by P. Toscanne in *Mém.* XII 153–208.

As in the case of the "cult wagon" from Sin Temple VIII (see p. 86), wheels selected from a large number found in the excavations and presumably belonging to model chariots were added (Pl. 94 *b*). This vase also has an opening on the back and a solid head. However, some detached rams' heads from similar vases (e.g. Pl. 94 *c-d*) are hollow and obviously served as spouts. A nearly complete example from an Agade building at Tell Asmar (Pl. 94 *f*) has such a spout head. Detached heads, both solid and hollow, are not rare, and on some of them (e.g. Pl. 94 *c*) the perforated lug is still preserved. One head (Pl. 94 *h*) may belong to a figurine. Plate 94 *i* is a miniature ram vessel.

The distribution of ram-vases on our sites can be ascertained from the catalogue (A.96, C.96). Very similar vases and fragments of such have been found at other sites.¹⁴⁸ As to their use, the first examples found were generally regarded as toys.¹⁴⁹ But their occasional occurrence in temples and the fact that such vases from different sites and periods are nearly identical suggest that they may have been cult objects. This view is supported to some extent by the fact that theriomorphic vases were put on wheels and consequently have this trait in common with the "cult wagon" (see pp. 85-86), which was actually found inside a temple and can hardly be considered a toy.

Possibly yet another type of ritual vessel is represented by two large fragments from Khafajah (Pl. 95 *a-b*). They derived from a pile of discarded pottery found in an open space south of Nintu Temple VII. However, it is likely that this dump continued to be used in the last phase of ED III, after the Nintu Temple was abandoned. These fragments are apparently from the upper part of a large cylindrical object¹⁵⁰ whose walls were cut by rectangular apertures and decorated with incised palm-branch motifs within oval frames and with several registers of comb-incised zigzags. Above these was a comb-incised zigzag bordered above and below by a notched ridge. A row of animals in high relief decorated the surface above the upper notched ridge. Most of the animals are too mutilated to be unequivocally identified, but apparently some represented lions and others ruminants (rams?). The apertures cut in the walls and the decoration in high relief are features reminiscent of the "cult wagon" (Pls. 82-83). Except for their size, these fragments could have belonged to the upper part of the stem of a "fruit stand" similar to one found at Ur,¹⁵¹ but such a "fruit stand" would have been nearly three times as large as the largest yet found.

Smaller fragments of thick-walled pottery showing traces of incised and relief decoration occurred sporadically in ED III levels. Two of these are shown in Plate 95 *c-d* but are too small to allow any surmise regarding the shape of the utensils to which they belonged or to deserve any detailed description.

BOWLS

In ED III the most common type of ordinary household utensil was still (see p. 58) the medium-sized rimless conical bowl with a flat base (e.g. Pl. 96 *a-e*). Such bowls are most frequently of shapes B.002.200*a-b*, but other varieties include shapes B.003.200*a*, B.032.200*a*, B.063.200*b* (with a thicker base), B.072.200, B.082.200, B.083.200, C.053.200, and C.083.200. In nearly all cases the base was string-cut, and in some it was flattened by stamping the vessel on an even surface before it was completely dry. This resulted in a projection of clay around

¹⁴⁸ E.g. Kish (Mackay, *Kish "A,"* p. 210 and Pl. XLVI 3), Ur (*AJ X*, Pl. XLI *a*; *UE II* 389 and Pl. 188 *a*), Susa (*Encyclopédie photographique de l'art* 19 [Jan., 1936] p. 282). A similar vase from Babylon, of much later date (Oscar Reuther, *Die Innenstadt von Babylon* [WVDOG XLVII (1926)] Fig. 39), has a knob instead of a perforated lug in front. See Gordon Loud and Charles B. Altman, *Khorsabad. II. The Citadel and the Town* (*OIP XL* [1938]) Pl. 63:245, for a wheeled animal-vase with two funnels on the back.

¹⁴⁹ Mackay, *Kish "A,"* pp. 209 f.; *UE II* 389.

¹⁵⁰ Actually it is uncertain whether both fragments belonged to a single object.

¹⁵¹ *UE II*, Pl. 180 *b*.

the base, as in B.003.200*a*. Undoubtedly rimless conical bowls were the most common drinking vessels, though a somewhat taller, more nearly cylindrical cup (B.016.200) was also used.

Much less common, but typical of ED III, are conical bowls with a short solid foot (Pl. 96 *f-g*). Sometimes the upper part of the foot is hollow (B.033.700*c*), and sometimes it is decorated with a plastic ridge. A form which is found also in ED II (B.003.700) has a narrower, plain, solid foot. The size of these little vessels and the irregular shape of the foot suggest that they were used as lids rather than as bowls or cups.

Larger household bowls usually have shallow ring bases and slightly projecting beveled rims (Pl. 96 *h-i*). A large rimless bowl with a comparatively wide ring base (C.022.300) may belong to ED III. Large bowls with ring bases and pinched pouring lips are represented by C.032.304 and C.042.204. A taller pot with a pouring lip (C.075.404) has an exceptionally high ring base.

Another very common type of utensil known from earlier periods (see pp. 59, 83) is the small conical bowl with an inner rim (Pl. 97 *a-k*). Such bowls vary in shape and height from very shallow examples (*b*) to comparatively tall ones (*j-k*). The rim usually slopes down but is sometimes flat (*e*) and occasionally slopes up (*a*). In some specimens (*i, k*) it also projects slightly on the outside; these have counterparts in bowls such as B.043.210*c* with only a slight outer rim. Other forms of the same general type, some of which are more common in the Proto-imperial period (see p. 106), are B.024.210, B.084.210*b*, B.084.710*a*, B.085.210, B.086.210, and B.087.210. Although we do not know what such bowls were used for, their peculiar rims make it unlikely that they were drinking cups. Moreover, some of them have a hole in the bottom (see B.083.210*a*, B.085.210). Perhaps they were used merely as jar stoppers.

Open bowls with convex bases were comparatively rare in ED III. One such bowl, of smoothed gray clay (Pl. 97 *l*), is reminiscent of the ED I imitation-stone vessels (see p. 58). Another, of ordinary clay, was pierced with numerous round holes to form a "colander" or "strainer" (B.032.500). A second example of the same shape belongs to either ED II or III.

A few shallow bowls also were found. Some are squat ellipsoids (Pl. 97 *m-n*), and others have the shoulder folded inward sharply (B.601.530). The latter variety occurs in ED II also (see p. 83). One bowl is of the same general shape but has a flat base (B.601.230). Rather unusual is a shallow bowl with a beveled rim (B.172.210).

JARS WITH FLAT AND RING BASES

Also typical of the ordinary household pottery of ED III are small rather carelessly shaped jars with flat string-cut bases (Pl. 98 *a-l*), which continue essentially without change from ED II (cf. Pls. 72-73). They are wheelmade, and the distortions in their shapes are due merely to careless handling before they had dried. They usually have rimless necks, which vary considerably in form and proportion. Two of the specimens illustrated (*i-j*) have rudimentary band-rims. Another (*h*) is noteworthy for a stud at the base of the neck. Other variants of the same class include shapes A.573.200 (similar to *a* but without a neck), B.174.220*c*, B.175.220*a-b*, and B.184.220*b* (all similar to *k*), B.574.220*a-b*, B.575.220, and B.575.240, the last being of somewhat better make and having a slight ledge-rim.

A small jar of the same general form has an upright handle on the shoulder (Pl. 100 *c*). Another has pierced vertical lugs (Pl. 100 *j*).

Occasionally the neck of little jars of the same type was pinched to form a pouring lip (B.175.224, B.176.224*a-b*, B.185.224, B.575.224, B.645.224). Such jars continue practically without change in subsequent periods (see pp. 106, 110, 113).

Two little jars with well formed rims (Pl. 98 *m-n*) are better made, and the definite carination of the bodies puts them in a different class from the small jars shown in Plate 98 *a-l*. A miniature jar (A.604.270) is somewhat similar to *n*, though it is still smaller and has a hole in the base. A medium-sized jar with a beveled rim and pronounced carination between body

and shoulder (Pl. 99 *a*) resembles Plate 98 *m*. These two vessels are similar to earlier forms such as C.525.370*a-b*. Two specimens of a wide-mouthed form with a tall ring base and a ribbed shoulder (B.466.470) were found in Houses V *b* at Tell Asmar. A rather unusual well made jar (Pl. 98 *o*) with a narrow splayed neck, a ring base, and two large loop handles (one broken) was found near the surface of Mound A at Khafajah and thus should be dated to about the end of ED III.

Common among the household pottery of ED III are medium-sized jars reminiscent in shape of the small pots shown in Plate 98 *a-l* but with ring bases. Their average size is more than twice that of the small jars. Roughly, they may be divided into two groups—those with a single or multiple plastic ridge at or above the maximum width (Pl. 99 *b-e*) and those with plain surface (Pl. 99 *g-j*). On the whole, vessels of the second group are somewhat larger than those of the first. Both groups contain ovoid jars with short necks and sometimes with beveled rims or roll-rims. In *b* the ridge is applied to the surface, in *c* it merges with the lower part of the vessel, and in both the surface above the ridge is undecorated. There are, however, other specimens of similar shape but with more elaborate rims (C.505.370*b*, C.506.470*b-c*) in which the surface above the ridge is decorated with closely spaced incised lines which at first give the impression of comb-incising. But apparently in most cases they were made with a single point while the vessel was still on the wheel, and thus the decoration is in reality a spiral. Other pots with such decoration on the shoulder are represented by C.525.470*a* and C.526.460.

At this point it may be well to mention another group of medium-sized vessels decorated with closely spaced incised lines (C.545.340*a-b*, C.565.340). They are characterized by thin walls and exceptionally narrow and shallow ring bases, which occasionally fail to project below the rounded bottom and thus make it impossible for the vessel to stand on a flat surface without rocking. Another thin-walled jar with a narrow ring base (C.406.370) has a longer neck and a plain surface. A considerably larger jar with comparatively thin walls (C.506.470*d*) has a rather high ring base and a steep plain shoulder bordered by a plastic ridge.

Plate 99 *d* has two closely spaced notched ridges and a slight beveled rim. A jar of similar shape (C.505.360) has two plain ridges and a rimless neck. A larger, ellipsoid vessel (C.655.370*a*) is decorated with three notched ridges and undulating incised lines on the shoulder above them. The combination of notched ridges and undulating incised lines or scraped bands is found also on certain wide-mouthed pots (C.504.370) from near the end of ED III and on one (C.404.350) from a grave which is almost certainly Protoimperial. As we have seen (pp. 87-88), undulating scraped bands occur also on upright-handled jars, "fruit stands," and a double-spouted jar. The ridges on the jar shown in Plate 99 *e* are not applied to the surface of the vessel but are the result of corrugation, which is discernible even on the inside. Examples of jars with this type of corrugation but with somewhat different bases and rims are C.505.370*c* and C.655.370*b-c*.

The earliest specimen of the jars with plain surface shown in Plate 99 is *f*, from a grave dated to the end of ED II. It is somewhat squattier and less regular than the similarly shaped plain jars from ED III levels (*g-j*). The latter are all ovoid and have rather wide short rimless necks and well shaped ring bases. A slightly larger well made jar (C.545.310) resembles *h* but has an outturned rim and no neck. Its ring base is too shallow to cover the rounded bottom. The two latest plain examples shown in Plate 99 (*k-l*) are from a grave situated near the surface of Mound A at Khafajah, which may belong to the end of ED III but more probably should be dated to the Protoimperial period (see p. 106).

Other medium-sized jars with ring bases and wide mouths include C.505.470 and C.655.340*a*. A jar with an unusually long neck (C.557.470) is decorated with closely spaced incised lines. Other unusual vessels are C.516.240, with an exceptionally thick slightly rounded base, and C.536.520, with walls so thick that they reduce disproportionately the capacity of the vessel.

It is likely that the latter jar was made for some special use. Another unusual jar (C.405.363) has a series of "buttresses" or unpierced lugs around the neck. Similar though more elaborate decoration around the neck is to be found in later periods (see p. 121). One such sherd (Pl. 127 *a*) is of ED III date.

Two medium-sized jars (Pl. 100 *e, h*) are similar in general shape to certain vessels which were adapted for suspension (see below). Each represents a type found also in the "A" cemetery at Kish. The fact that jars resembling *h* were quite numerous in the "A" cemetery¹⁵² and comparatively rare among our pottery would indicate that this type was more characteristic of an ED III phase later than that represented at Khafajah.

Two single-lugged jars (C.526.373*b*) found in ED III graves may be ED I survivals, since such jars were very common in that period and no others were found in ED III context (see p. 57).

STORAGE JARS

Considerably larger than the jars shown in Plate 99 are so-called "storage" jars. Although less numerous than the medium-sized vessels, they also occur in a considerable variety of forms. Most of them have ring bases, but rounded bases also occur. We have already mentioned large jars with upright handles (D.526.371) and with spouts (D.514.362, D.525.362, D.545.542). One large jar (D.494.470) has multiple ridges on the shoulder and one ridge near the base. A more elongated jar, with a ribbed shoulder, is represented by D.465.360. A rounded form which is probably of ED III date has multiple ridges both on the upper part of the body and near the base (D.555.340), while a somewhat smaller jar (D.526.370*a*) has ridges at the shoulder but none at the base. Similar to the latter in shape but with a plain surface is D.565.310, one specimen of which was found in an ED III level and the other in a room of Temple Oval I (ED II) under circumstances which suggest that it may have been used for grain storage.¹⁵³

Although the number of large jars with convex bases actually found in our excavations of ED III levels is comparatively small, it seems that such jars were not rare at the time. Indeed, two contemporary plaques from Khafajah show large jars, each being carried by two people by means of a rope and a pole.¹⁵⁴ The ring held by one of the carriers in each scene, and obviously intended as a stand for the jar, would indicate that the latter had a round or pointed base. The same representation occurs on seals.¹⁵⁵ D.556.540*b* is one of the large jars with a convex base. It has an angular join of the convex base to the body, which becomes more characteristic in later times (see p. 112). A very large jar with pierced base (D.556.540*a*) was used in connection with a horizontal drain (see Pl. 108) and thus may be assigned to the class of architectural fixtures (see p. 104).

VESSELS ADAPTED FOR SUSPENSION

Plate 100 *f* and *i* show two jars which were adapted for suspension; *e* and *h* are vessels of similar forms without suspension devices (see above). One form has a carinated shoulder, and the other is an ellipsoid without carination. Each has a rather wide neck and a high ring base. The surface of *f* is plain; *i* is decorated with a comb-incised zigzag above the maximum diameter. The latter could be suspended by means of two horizontal lugs attached at the maximum diameter, each with a double perforation. The former has two pairs of vertical tubular lugs attached at the shoulder and holes in the ring base aligned with them. A cord passing through the lugs and the corresponding holes would form an efficient device for sus-

¹⁵² See Mackay, *Kish "A,"* pp. 30 and 149 ("cup-based pottery, type E").

¹⁵³ See *Temple Oval*, p. 30 and Fig. 26.

¹⁵⁴ *Sculpture*, Pls. 105, 107.

¹⁵⁵ E.g. Frankfort, *Cylinder Seals*, Pls. XI *f*, XV *f*.

pending or carrying the vessel. Indeed, in a banqueting scene on a contemporary plaque from Khafajah there is a representation of a similarly shaped jar apparently carried in this manner by a female attendant.¹⁵⁶ A vessel (Kh. III 1381; C.515.870) which is very similar to *f* in form has perforations in the base but no lugs. Plate 100 *g*, made of gray paste and with vertically pierced lugs, is also related to *f* in general shape, though it is squattier and has a comparatively wider neck. The pricked design on its neck and shoulder, which presumably was originally white-filled, represents a type of decoration rather unusual among our finds, though apparently it is characteristic of the Early Dynastic period since it occurs among the Early Dynastic pottery from Farah and Kish.¹⁵⁷ A jar made of dark gray clay and decorated with white-filled incised patterns and impressed circles (C.555.423), though it is more ovoid, is comparable with *i*, which is made of red-buff clay and has comb-incised decoration on its shoulder. Impressed concentric circles occur on gray-paste sherds from Khafajah (see pp. 102-3).¹⁵⁸ White-filled incised, pricked, and impressed decoration is almost invariably found on gray pottery (see also pp. 119-20).

Pierced vertical lugs are found occasionally on small pots with flat bases (Pl. 100 *j*) which resemble the very common forms shown in Plate 98 *a-l*.

Very small and miniature vessels are quite often adapted for suspension. A group of such vessels is shown in Plate 101. Except for *b*, which is somewhat larger than the rest, they are all handmade. Plate 101 *a* has a single small horizontally perforated lug and thus can be classed with two somewhat larger jars (B.416.373, B.515.373). Plate 101 *b-c* each have two pairs of vertical perforations through the edge of the shoulder. Like the larger jar shown in Plate 100 *f*, Plate 101 *d*, which is similar to *a* in shape, has two pairs of vertically pierced lugs at the shoulder and corresponding holes in the base. The rough pricked design on the shoulder is clearly in imitation of a type of decoration sometimes found on larger jars adapted for suspension (e.g. Pl. 100 *g*). A small globular pot with a convex base (Pl. 101 *e*) has two pairs of vertically perforated lugs at the maximum width. Except for its narrower neck and rim it is reminiscent of bowls with two wide double-perforated lugs (B.041.503, B.043.503). It is possible, however, that the bowls actually served as lids. They could be fastened to such jars as Plate 100 *f* or *i* by passing through their lugs the same cord which served to suspend or carry the jars. A small disk with two double-perforated lugs (A.070.203) could, indeed, hardly serve any other purpose. A somewhat taller bowl with a flat base and two suspension lugs at the mouth (B.203.203) is probably of ED III date but may belong to the Protoimperial period. A miniature bowl (Pl. 101 *g*) resembles the larger bowl B.041.503 but has only one lug with a single perforation. It too could have served as a lid, but the single lug suggests that it may have been fastened to a wooden or bone handle to form a ladle or spoon. A troughlike object with a perforated lug at one end (A.831.203), of the Agade period, may have served a similar purpose.

Plate 101 *h*, made of gray clay, is unique. It has two vertically perforated well worn lugs and incised crisscross decoration. Its narrow base seems to have been pared with a knife. Of roughly the same size is a miniature bucket with a bail (A.014.101; see p. 42). A somewhat larger near-cylindrical cup with concave sides and double-perforated lugs (A.235.203) belongs to the same general group. Plate 101 *i* shows a fragment of a miniature jar, originally with four horizontally pierced beak-lugs around the shoulder, reminiscent of certain earlier four-lugged utensils. Its close resemblance to Protoliterate specimens (cf. Pl. 22 *a-f*) would suggest that the fragment is out of context in an ED III stratum were it not for the variety of small vessels with suspension lugs described above. A jar of the same shape with four unperforated lugs (Pl. 74 *j*) was found in ED II.

¹⁵⁶ *Sculpture*, Pl. 107 (top left).

¹⁵⁷ See Heinrich, *Fara*, Pl. 18 *a*; Mackay, *Kish "A,"* Pls. I 3, XLV 5 = LII 9.

¹⁵⁸ A sherd from Farah is decorated with impressed circles (see Heinrich, *op. cit.* Pl. 18 *b*). Impressed concentric circles are combined with pricked decoration at Kish (see Mackay, *loc. cit.*).

A small pot with a steep, somewhat concave shoulder (B.445.350) has two holes just below the rim which could possibly be used for suspension. Such holes occur in other small vessels of various periods (see e.g. Pl. 102 *b* and forms A.654.920, A.656.720, B.054.700). ED III flasks were also adapted for suspension. They are discussed below.

VESSELS WITH CONVEX OR POINTED BASES

Household utensils with convex or pointed bases occur in considerable variety. Large jars with convex bases are discussed on page 97. A small jar with a wide mouth, slight beveled rim, and convex base is shown in Plate 102 *a*. Other forms, not greatly different, are B.555.520, with a short wide neck; B.645.540*b*, in which the demarcation between neck and body is more clearly marked; C.556.540 and C.656.540 (Pl. 112 *b*; possibly Protoimperial; see p. 107), with narrower necks. Related to the two last mentioned forms are somewhat smaller bottles with still narrower necks (B.666.640, B.666.540*b*). The latter is made of gray clay, and its upper part is decorated with horizontal incised lines. Of the small jars with pointed bases, one without a neck but with a slight roll-rim (Pl. 102 *b*) is made of fine gray clay and its shoulder is decorated with wheel-incised lines actually forming a continuous spiral. It shows traces of burnish and burning. Two holes near the rim could serve either for suspension or for fastening a lid. In this respect it is related to B.445.350 (see above). Of somewhat similar general shape but with short necks and without perforations are B.546.640*a,c* and C.556.640. A squattier bottle with a roll-rim (B.545.640*b*) approaches in shape some of the bottles discussed below.

Vessels of various sizes with convex bases sometimes have a perforation near the base (e.g. B.555.520, D.555.510*b*). One utensil with multiple perforations in the base forms a "colander" (Pl. 102 *c*). Similar in shape but without perforations is C.545.640, which occurred in ED II also (see p. 82).

Wide-mouthed squat vessels are represented by C.653.620, with a slightly pointed base; C.754.521, with two loop handles (one missing) at the mouth; and C.654.503, an almost globular pot with a hole-mouth and two lugs. Though the last mentioned specimen resembles some vessels from other regions, it is the only one of its kind among our finds.

Short bottles with convex bases such as occurred in ED II (see Pl. 74 *l-m*) survive into ED III. Some of the ED III bottles (Pl. 102 *d, f-g*) are practically identical in shape with ED II examples. However, on the whole in ED III there seem to be tendencies toward sharper carination between body and shoulder (Pl. 102 *e*) and occasionally double carination on the body (B.633.570*a-b*, B.634.570*a-c*). Varieties which are found only in ED III are B.514.570 and B.544.570. B.664.540*a* is a shape which occurs not only in ED III but also in both earlier and later periods, and B.634.570*b* occurs in later periods also. Two specimens of a somewhat taller form with double carination of the body and slightly pointed base (B.635.670*a-b*), found at two points near the surface of Mound A at Khafajah, belong to ED III or the Protoimperial period.

A wide-necked jar with a pointed base and traces of a narrow spout (B.454.642), from a grave of Houses 3, should be mentioned again at this point (see also p. 91). It is reminiscent of a spouted bottle with convex base (B.514.572), from the uppermost ED II stratum, which in turn is similar in form to some of the bottles just discussed.

Yet another kind of vessel with convex base is the flask. Plate 102 shows three complete examples from Tell Asmar (*h-i, k*) and two fragments from Khafajah (*j, l*). One of the complete specimens (*i*) belongs to the Protoimperial period, but another flask of the same form was found in ED III. The chief characteristics of these flasks are the lentoid form, the short narrow neck, and the rather crude suspension loops. The actual containers were as a rule well made. It is easy to discern that they were made in two parts, each separately thrown on the wheel, and then joined together. (Note the wheel marks in *h*.) Usually the two parts are not

of equal depth, and thus the flasks are often more convex on one side than on the other (see top view of *k* and cross sections on Pl. 167). A nearly complete specimen of this type from Khafajah (Pl. 75 *f*) is of uncertain stratification and may belong to either the end of ED II or the beginning of ED III (see p. 83). However, on the whole, flasks of the type shown in Plate 75 *a-e* are characteristic of ED II while the type shown in Plate 102 *h-l* is characteristic of ED III. The later type is more similar in form to the "pilgrim flasks" common over the Near East in much later times¹⁵⁹ and perhaps may be considered their prototype.

MISCELLANEOUS SMALL POTS

A well shaped wheel-turned miniature pot (Pl. 103 *a*) is made of rather gritty reddish paste, and there are indications that it may have had a lighter fine slip. A vessel of similar size and material but somewhat more slender has a narrower neck and a pointed base (A.556.640).

Three wheel-turned globular jars from Khafajah with peculiar horizontal striations (Pl. 103 *b-d*) are made of an unusual black paste which contains perhaps an admixture of bitumen. Plate 103 *e* is a miniature globular pot rather crudely fashioned by hand. Somewhat similar jars are A.494.520, A.654.520, and A.655.520*b*, the last with a wider and longer neck. Miniature pots with wide short necks and ring bases are represented by A.556.320 and A.557.320. A jar with a tall ring base (A.505.450) has incised lines on the shoulder; another (A.446.830), with a tall pedestal base and a sharp ridge at the shoulder, is decorated with irregular incisions. A handmade miniature jar with a concave base (A.475.120), found on the surface of Mound A at Khafajah, probably belongs to ED III. Globular containers with concave stump bases are represented by A.645.720 and A.654.720. A more elongated pot with such a base (A.656.720) has two perforations in the neck, which could have been used for suspension (see p. 99). A.545.620 and A.546.630 are containers with pointed bases. Crude miniature cups (e.g. A.035.600) which are still smaller may have served as stoppers rather than containers. Another miniature "cup" has a tall ring base (A.186.400). A slightly squared miniature cup (Pl. 103 *f*) has knobs for legs. Another of the same type (A.243.900*b*) flares slightly at the opening. The bowl shown upside down in Plate 103 *g* illustrates well the uneven, sometimes cracked, surface which is characteristic of most of the handmade miniature pots.

BRAZIERS AND "CRUCIBLES"

Prominent among the specialized utensils introduced at the end of ED III and surviving into subsequent periods are open braziers. In its simplest form such a brazier consists of a fairly large, thick-walled, roughly made, shallow bowl with vertical or near-vertical sides from which project three thickened inwardly bent protuberances called "lugs" for purposes of classification (Pl. 104 *a* and shapes C.012.203, C.201.203). This simple type was used in the Proto-imperial period also (see p. 108). A more elaborate variety consists of the same type of bowl with three or four long strips of clay bent inward and joined to the base in the middle to form a series of "handles"; occasionally the inner receptacle thus formed is connected with the bowl proper by holes at the base (see also p. 112). Unfortunately this type is represented in ED III levels by fragments only (e.g. Pl. 104 *d, f*), which, however, provide enough evidence for unequivocal restoration of C.011.201*a-b* as drawn. A much larger utensil of this type with four "handles" (D.201.201*b*) was found. Such large utensils with either three (D.201.201*a*) or four "handles" were found in fair numbers in levels of later periods, whence indeed the best preserved specimens derive (see Pls. 116 *a*, 117 *a-b*, 118 *b*). As regards the function of such utensils, our terminology implies that they were used in connection with fire. Indeed, several

¹⁵⁹ See e.g. Robert Koldewey, *Das wieder erstehende Babylon* (4. Aufl.; Leipzig, 1925) p. 246 and Fig. 169. It may be noted, however, that lentoid vessels are known in Egypt in prehistoric times (see Petrie, *Corpus of Prehistoric Pottery and Palettes*, Pl. XVI).

showed traces of burning and many consisted of a coarse crumbly fabric which may have resulted from repeated extreme changes in temperature such as a brazier would normally undergo. Their shape would make them suitable for cooking. The bowl itself would serve as a receptacle for lighted charcoal, and such holes as can be seen in Plate 104 *b* would serve as air feeds for the fire. The "lugs" or "handles" would hold a cooking pot placed over the fire. Structurally the "handle" type was an improvement over the "lug" type since it could support a considerably heavier weight. This may explain why it is the type which was preferred in later periods. Both types are known from other sites. Another possible use for the considerably larger specimens of the "handle" type is suggested by a miniature model of a similar object found at Bismayah (Pl. 116 *b*) and discussed on page 112.

Round or oval thick-walled open dishes with an outlet or a short spout at the bottom could have served as crucibles. Only fragments of such utensils were found in ED III levels, but a few complete specimens are known from later periods (Pl. 118 *a* and forms C.201.205, D.301.112). Both the braziers and the "crucibles" are elaborated and specialized forms of shallow containers such as C.201.200.

Two vessels which represent yet other types of braziers (Pl. 105 *a-b*) were purchased before our excavations in the Diyala region began. Their archeological context is thus uncertain, but reputedly they came from Khafajah. Plate 105 *a* somewhat resembles a utensil found in Sin Temple III at Khafajah (Pl. 24 *a*), which also has two rows of holes, though they are rectangular and triangular instead of round. Nevertheless, it is unlikely that the purchased specimen dates from the same period, since it is considerably larger, is made of light buff friable fabric instead of compact reddish clay, and is decorated with finger-impressed plastic rolls, while the stratified example is plain. The purchased specimen would not be out of place at the end of ED III, when a considerable variety of specialized utensils of similar fabric was used. However, its date must remain uncertain until closer parallels are found in well dated contexts.

Plate 105 *b* is a tall open pot with a ledge-rim and a ring base. It has a row of triangular holes cut in the walls and is decorated with a group of crescent-shaped impressions, apparently made by a split reed, and two groups of notched ridges. Among our stratified finds it has a fairly close parallel from the Protoimperial period (C.206.410; see p. 108); three utensils of the same shape (C.246.310) and with similar decoration but without holes in the walls come from the Larsa period (see p. 118). However, both in shape and in decoration Plate 105 *b* is similar to yet another group of vessels, the so-called "ribbed" ware (see below), which appeared at the end of ED III and continued into Agade times, though most of the specimens were found in the Protoimperial period. On the basis of these resemblances one could date this utensil anywhere from the end of ED III to the Larsa period, but perhaps the end of ED III or the Protoimperial period would be the best guess.

While ribbed ware first appears in the ED III period, the complete specimens shown on Plate 105 *c-f* derive from Protoimperial levels. The main characteristic of this ware is the ribbing of the outside surface of the walls by closely spaced horizontal ridges which are sometimes plain and sometimes notched or pricked. On the whole, such ribbing is confined to medium-sized cylindrical pots with flat bases and usually more or less pronounced rims. Sometimes such pots are slightly wider at the base (*d*), and occasionally they are oval in horizontal section (C.802.200, C.803.200, C.805.200, C.805.210). A comparatively short form (C.013.210) with slightly corrugated walls may be considered as related to the ribbed ware. On the whole pots of this type have rather thick walls and were made of coarse, often poorly baked, fabric. Their indifferent workmanship and the fact that many were found in private houses seem to indicate that they were common household utensils. It seems likely, too, that they were used somehow in connection with fire, perhaps as braziers. Whatever their use, they are known from several Mesopotamian sites and thus serve as a fairly good criterion for dating.

STUDDED WARE

Less frequently encountered than the ribbed ware and characteristic of roughly the same span of time is the so-called "studded" ware (Pl. 105 *g-i*), which appeared in ED III and continued into the Early Agade period (see p. 110). Vessels of this ware are characterized by fairly large hemispherical or slightly pointed studs applied to the surface. From the material so far available it would seem that this peculiar decoration was confined to rather small globular jars with narrow necks and, usually, suspension devices in the form of either loops (C.665.341, C.665.541) somewhat similar to those on flasks (see Pl. 102 *h-l*) or horizontal lugs with single (C.665.323, C.665.543*a-b* and *d*) or double (C.665.543*c*) perforations. Some have ring bases (C.665.323, C.665.341), and one has an ordinary convex base (C.665.543*b*). However, in most cases three of the applied studs at the base were drawn out slightly to form a sort of tripod (C.665.541, C.665.543*a* and *c-d*). Although our excavations have yielded more specimens of this ware than has any other Mesopotamian site, the material is as yet insufficient to enable us to distinguish between earlier and later types. One may point out, nevertheless, that of the two specimens with ring bases the only stratified one was found in ED III context, while the other types of bases occur only in later periods. The significance of this ware for relative dating is discussed in chapter iii (p. 144).

VARIA

Studded ware represents only one of several types of appliqué decoration found on ED III pottery. Quite common at Khafajah were sherds of small shallow bowls,¹⁶⁰ usually with round bases and sometimes with perforations at the rims, which were decorated with thin clay pellets and flattened rolls of clay applied to form simple designs. One nearly complete specimen of this type, probably of ED III date, is shown in Plate 106 *a*. Apart from a circle on the base, applied rolls form four branchlike motifs. Round pellets fill the surface between them in more or less regular patterns. On other fragments herringbone patterns, radial lines, and occasionally representational motifs of trees, snakes, horned animals, and possibly birds are encountered. As a rule the surface between such figures is covered with round flattened pellets arranged in more or less regular groups. At Tell Asmar a complete bowl with such appliqué decoration (B.001.310) was found in the Protoimperial period and another (B.041.710) perhaps in the Agade period; numerous sherds were found in levels of both periods.¹⁶¹ The same type of decoration is known even later, on a fragment from Mound D at Khafajah (Pl. 106 *e*) which probably belongs to the Larsa period. This fragment, however, is apparently not from a bowl but probably is part of the "shield" of a model chariot. A tripod dish (B.041.900) of the Old Babylonian period (see p. 123) has appliqué decoration which possibly continued the tradition. One may recall that a great number of bowls of the type illustrated in Plate 106 *a*, some of them with more intricate decoration, were found at Susa by the French excavators, who have discussed various elements of their designs in considerable detail.¹⁶²

A sherd found in an ED III level at Khafajah (Pl. 51 *d*) has a plastic crescent with two round pellets below it (see p. 60). Decoration in relief was sometimes obtained by molding (Pl. 106 *b-c*), and a few examples give the impression of having been carved (e.g. Pl. 106 *d*).

A fragment from an ED III level at Khafajah (Pl. 106 *f*) has impressed triangles similar to those on the gray box of ED II date (Pl. 71 *b*) but no traces of white fill. A sherd from Tell Asmar (Larsa?) has an impressed scalelike design which can be seen clearly where the salt incrustation has been removed (Pl. 106 *g*). Plate 106 *h* shows a gray sherd decorated with impressed concentric circles which apparently had been white-filled. A sherd from Sin X at

¹⁶⁰ E.g. in loci O 42:2, O 43:2, O 45:2, P 45:1, P 45:3, Q 44:7.

¹⁶¹ E.g. in loci E 16:7, E 16:10, E 16:19 (Protoimperial); and J 19:14, J 19:36 (Agade).

¹⁶² See *Mém.* I (1900) Figs. 334 and 336; *Mém.* XII, e.g. Figs. 247-48, 327, 335, 338-39, and 341.

Khafajah (Kh. IV 137), made of similar fabric, is covered with prickings between the concentric circles. These are among the earliest examples of impressed concentric circles, a motif which becomes very popular on incised gray ware in Larsa times (see pp. 119-20), and recall some complete vessels from other sites (see also p. 98).¹⁶³ Plate 106 *i* represents yet another type of impressed decoration. However, it is likely that this fragment belongs not to a vessel but to either a model bed or a model chariot. A small sherd with impressed circles, incised lines, and a pinnate motif is shown in Plate 106 *m*.

Two square spouts with similar incised marks (Pl. 106 *j-k*) are rather unusual. The marks apparently cannot be identified with any known writing signs and probably are potter's marks. In *k* the spout is joined to what seems to be a slightly concave ring with two perforations. The surface of this ring is unbroken both above and below, and thus it cannot be taken as part of the rim of such a bowl as C.052.202. Several other sherds of exactly similar type were found at Khafajah and Tell Asmar. The only explanation I can offer for their use is that they may have served as solid rims for water skins or bags. In connection with the incised marks one should mention that there are a few fragments apparently from large storage jars which have markings painted in bitumen. They include several of the marks painted on certain pots from stratum G at Assur.¹⁶⁴

Plate 106 *l* shows a small conical funnel joined to a portion of a hollow ring in a manner reminiscent of Greek kernoi. This fragment apparently belonged to an elaborate clay object such as the "fountain-head" from Tepe Gaura,¹⁶⁵ which is not very far in time from our fragment. It is of interest to note that a fragment practically identical with ours was found at Harappa.¹⁶⁶ Similar contrivances are known of course from much later times.¹⁶⁷

Occasionally ordinary jars were used as "jewel boxes" or "safes." Usually they were coated with bitumen to prevent damage by moisture, plugged with clay or bitumen stoppers, and sealed with hot bitumen. Plate 107 *a* shows a medium-sized jar still sealed. Comparatively little whole jewelry was found in such vessels, the hoards consisting mostly of shapeless bits of precious metal (silver as a rule, but occasionally electrum). Seals, beads, and occasionally copper ornaments were also included.¹⁶⁸ A small pot with remnants of what may have been an upright handle on the shoulder (Pl. 107 *b*; see also p. 87) contained beads and copper ring-pendants (shape discernible in upper view). Plate 107 *c* shows a small jar from the Larsa period with the stopper in position but with the bitumen sealing removed. At least on one occasion we found peculiarly shaped pottery containers which were probably intended to safeguard their contents by means of an amusing ruse. In one of the rooms behind the platform of Temple Oval I at Khafajah we found two containers (C.861) shaped exactly like plano-convex bricks.¹⁶⁹ Apparently these were meant to be sealed and built into a wall among solid bricks, a procedure which would have made their detection extremely difficult indeed. The fact is, however, that even the complete specimen (Pl. 107 *d*) was found entirely empty, so that the suggested use has not been proved.

¹⁶³ See Mackay, *Kish "A,"* Pls. I 3, XLV 5; Edgar J. Banks, *Bismya; or the Lost City of Adab* (New York and London, 1912) p. 347.

¹⁶⁴ *WVDOG XXXIX*, Pl. 23 *a-l, r*.

¹⁶⁵ See Speiser, *Excavations at Tepe Gaura* I 55 and Pl. LXX 138.

¹⁶⁶ Madho Sarup Vats, *Excavations at Harappā* (Calcutta, 1940) II, Pl. LXXI 76.

¹⁶⁷ E.g. from Megiddo VI in Palestine (see Herbert Gordon May, *Material Remains of the Megiddo Cult* [OIP XXVI (1935)] p. 18 and Pl. XVI) and from the Parthian period in Mesopotamia (see Neilson C. Debevoise, *Parthian Pottery from Seleucia on the Tigris* ["University of Michigan Studies. Humanistic Series" XXXII (Ann Arbor, 1934)] p. 21 and Pl. B 3).

¹⁶⁸ One such hoard, of the Agade period, is shown in *OIC* no. 16, Fig. 30. The objects are undisturbed but part of the cracked vessel has been removed.

¹⁶⁹ See *Temple Oval*, pp. 31-33.

Among the objects which are not actually vessels should be mentioned rough jar covers made of irregular lumps of clay pinched at the top to provide a fingerhold (see Pl. 130 *a-b* and p. 122). Two specimens (Kh. III 1258 and 1302), both unbaked, were found at Khafajah in J 43:1 (Houses 4 or above).

ARCHITECTURAL FIXTURES

The description of ED III pottery would not be complete without mention of certain utensils which because of either their size or use must really be considered architectural fixtures. Among these are very large vats (Pl. 108 and forms E.225.310, E.235.310), sometimes well over a meter in height and diameter, used in connection with drains in the excavated buildings of the period. Since they could have been moved only with difficulty, they were installed more or less permanently. Thus they lend definite character to the rooms in which they were found and are as a rule shown on the plans and mentioned in the architectural volumes of this series. These large vats were usually thick-walled and made of coarse fabric, but were on the whole fairly well fired. Apparently they were built up of successive rings about 20 to 30 cm. high which were joined after preliminary drying, the joins often being reinforced by plastic ridges. The latter, as in the case of smaller vessels, were sometimes plain but more often notched in various patterns, finger-impressed, or pinched to produce a ropelike appearance.

Even more clearly of architectural character are vertical drains of a type known as early as the Protoliterate period.¹⁷⁰ These drains consisted of a number of superimposed tubular sections placed in a narrow round pit with the space around them packed with broken pottery (Pl. 109). The individual sections measure more in width than in height. They vary from 60 to 80 cm. in diameter and proportionately in height. Each section of one drain has several round holes in it (E.235.010). Some sections have strengthening ridges on the outside (E.303.010). However, such ridges are much less common here than on the vats. Presumably they were superfluous because of the protective packing around the drains. Such drains persisted through much later periods of Mesopotamian history, when they became more varied and elaborate. We shall thus have further occasion to discuss them (see pp. 112, 114, 119).

Other utensils of architectural character include tubular and troughlike drains,¹⁷¹ rainspouts, window grilles, door pivots, etc., which were found in fair numbers. Usually they were made of rough fabric but were fairly well baked. However, since they are not vessels, their descriptions will be found either in the architectural volumes or in *Miscellaneous Objects from the Diyala Region*.

¹⁷⁰ See *Pre-Sargonid Temples*, p. 23 and Figs. 17, 19.

¹⁷¹ E.g. *Temple Oval*, Fig. 57.

HISTORICAL PERIODS

With the appearance of historical inscriptions at the end of the Early Dynastic period the importance of pottery as a chronological guide becomes, in principle, secondary. However, due to the fact that in the early historical periods written material is comparatively scarce and that in neighboring regions illiteracy prevailed considerably later than in Babylonia, we depend largely upon pottery evidence for comparative dating even in historical periods.

THE PROTOIMPERIAL PERIOD

The term "Protoimperial" has been introduced by Jacobsen¹⁷² to designate the time from the beginning of the reign of Entemena to the first years of the reign of Sargon of Agade. As it happened, the stratified remains in our excavations which can be attributed to this period are comparatively few, being confined to two levels of the Single-Shrine Temple (II-III), a stratum of private houses (*V a*), and the main level of the Northern Palace, all at Tell Asmar. Consequently, archeological material, including pottery, which can be dated with certainty to this period is comparatively meager.

In describing the ED III pottery we mentioned several types of vessels which survive into the Protoimperial period. Among these one should distinguish between those whose *floruit* is largely in ED III, those which seem equally popular in both periods, and those which though they first appeared in ED III became more popular in the period under discussion. To the first category belong upright-handled vases. Only two forms (B.526.471 and C.516.371*a*) belonging to this class were found in Protoimperial context. However, other specimens (Pl. 84 *e* and forms C.526.471*a,d*) were found near the surface of Mound A at Khafajah in graves which are later than any of the stratified remains of that mound and should most probably be dated to the Protoimperial period. Detached handles from such vases also were found in Protoimperial levels (see Pls. 86 *m*, 87 *m-o*). "Fruit stands" also may belong to the first category mentioned above, though none were found in unequivocally Protoimperial context. A few occurred in the above mentioned late graves near the surface of Mound A at Khafajah (see C.363.810*b*, C.365.810*b*, C.365.810).

Two groups of pottery which made their appearance at the end of ED III and are quite characteristic of the Protoimperial period are the ribbed and studded wares. These have already been described (pp. 101-2; see also p. 110), so that we need mention here only the shapes which were actually found in Protoimperial strata. Ribbed-ware forms include C.213.200, C.215.210 (Pl. 105 *c*), C.216.210 (e.g. Pl. 105 *f*), C.303.200 (Pl. 105 *d*), probably C.802.200, and C.805.210 (e.g. Pl. 105 *e*). A wide-mouthed pot with ribbed shoulder (Pl. 110 *i*) is perhaps related to these, though its walls near the mouth are considerably thinner. Forms of studded ware are C.665.541 and C.665.543*b-d*. A fragment perhaps of this period is shown in Plate 105 *h*. None of these have a ring base (see p. 101), but they all have convex bottoms sometimes with three of the applied studs drawn out to form a sort of tripod.

Ordinary conical bowls such as were introduced in much earlier times and which were the most common type of pottery throughout the Early Dynastic period still continued in considerable numbers in the Protoimperial period. However, while B.002.200*a-b* still persisted, there seems to have been a tendency toward somewhat shallower forms (B.001.200*a*, B.032.200*b*, C.001.200*a*, C.042.200). A form with rather thick walls and a flaring rim (C.072.200) and one with two pairs of vertically pierced suspension lugs (Pl. 101 *j*) are exceptional. The latter may not belong to the Protoimperial period. A form with a ring base and a carinated rim

¹⁷² *AS* No. 11, Table II.

(C.142.310) which becomes quite common in later times seems to have made its appearance in this period. Another new type which survives in later periods is a tall narrow cup (B.256.200, C.257.210). Vessels of this type are flat-based, cylindrical, and flare at the top. They are usually thick-walled and of rather indifferent workmanship, though better made specimens of finer fabric are occasionally found. This type is known from other sites and thus provides a fairly reliable criterion for comparative dating. Small open bowls decorated with applied pellets and rolls of clay (B.001.310, B.031.510, B.041.710) continue a tradition begun in ED III (see p. 102). Rather unusual are a squat bowl with inturned sides and a ring base (B.741.300) and a chalice-like vessel with a solid pedestal base (B.054.700) and two pairs of holes at the mouth (see p. 99).

Bowls with inner rims are familiar from earlier times (see p. 95) and were also found in buildings of this period (B.024.210, B.072.210*b*, B.084.710*b*, B.085.210). They survive, though in fewer numbers, into the Agade period (see p. 109). Small cups of the same general shape have outer rims (B.064.210). Similar small pots with outer rims have a hole in the base (B.174.210*a-b*).

Small irregular jars with flat bases such as were very common in ED III (see Pl. 98 *a-l*) continue in the Protoimperial period (Pl. 110 *g* and shapes B.174.220*c*, B.184.220*a*, B.185.220, B.573.240). As in earlier times (see p. 95) some were provided with a pinched pouring lip (e.g. Pl. 110 *f* and shape B.575.224). A somewhat larger jar with a similar pouring lip is shown in Plate 110 *e*. As in ED III (see p. 92) such jars occasionally have small spouts which were often clogged or compressed to form solid handles (Pl. 110 *d* and shapes B.175.221, B.576.221). A small jar with an upright handle (B.526.471) is reminiscent of those of ED III (see Pl. 100 *a-b*). It has simple incised decoration on the shoulder, like the earlier specimens, but its somewhat higher ring base approaches a pedestal base. Another small jar (B.516.473) has incised decoration and a high ring base, but its "handle" is merely a lug attached to the neck along its entire length. A small jar with a real spout (B.676.422) has a high ring base, but it differs from the two last mentioned jars in that it has no rim and no carination between body and shoulder. Its comparatively long spout has a very narrow aperture. B.546.322, with a shallow ring base and a wide short rimless neck, has a rather large slightly curved spout attached close to the mouth. The upper part of a somewhat larger wide-mouthed jar (C.486.222) was apparently very similar, but it has a flat base and uneven walls. An ellipsoid vessel with a wide mouth and a fairly high ring base (C.646.422) is rather poorly shaped.

The large well made spouted jars such as were characteristic of ED I-II (see pp. 52, 80) now seem to have died out almost entirely. The only form reminiscent of the earlier jars is C.556.322. Large spouted bowls such as were apparently in use much earlier (see p. 38) and in ED III (see p. 91) occur also in the Protoimperial period (C.053.312, C.544.312) and become even more popular in Agade times (see p. 111).

An entirely new type of spouted vessel (Pl. 110 *h*) consists of a relatively small container with a disproportionately large neck (part of neck and spout broken off) and a trumpet-end pedestal base. It resembles certain representations of libation vessels on plaques¹⁷³ and gives the impression of being an imitation of a metal type.

The two medium-sized household utensils shown in Plate 99 *k-l* are most probably of Protoimperial date (see p. 96). They are comparatively taller than ED III specimens of the same type (see Pl. 99 *a-e, g-j*) and have beveled rims and somewhat higher ring bases. The junction between body and shoulder is somewhat more angular, and the walls are less convex. Of comparable Protoimperial forms the most typical are jars with ring bases, wide mouths, and very

¹⁷³ E.g. on two plaques from Nippur (shown in H. V. Hilprecht, *Old Babylonian Inscriptions Chiefly from Nippur* [Pennsylvania. University. Babylonian Expedition, "Series A: Cuneiform Texts" I] Part II [Philadelphia, 1896] Pl. XVI and reproduced in Christian Zervos, *L'Art de la Mésopotamie de la fin du quatrième millénaire au XV^e siècle avant notre ère* [Paris, 1935] pp. 92 f.) and on an engraved shell plaque from Ur (*ibid.* p. 95).

short necks. These jars have either a rounded shoulder and a plastic ridge at the join of body and shoulder (C.466.370, C.466.470) or a ribbed shoulder (C.466.450). A new feature of the type with a rounded shoulder and a plastic ridge is the manner in which the shoulder is sometimes joined to the body. Usually the ridge is rounded and covers the joint, but in some cases the shoulder is slightly narrower than the upper part of the body, into which it was fitted, so that the rounded ridge is really part of the body. Ribbed shoulders are found on much larger jars (D.465.360, D.466.360) and possibly occurred on some tall jars with convex bases, though the only specimen of such a vessel (C.466.570) may originally have had a ring base which subsequently broke off. Such indeed was the case with a Late Agade specimen of D.466.360, on which the impression left by the ring base can still be discerned (see Pl. 115 *b*). Other medium-sized jars, with either plain shoulders and undulating walls (C.596.440*a-b*) or corrugated shoulders and undulating walls (C.476.350, C.477.350), are from near-surface graves at Khafajah which may belong to ED III but should probably be dated to the Protoimperial period (see p. 104). Undulating walls occur also on a large pear-shaped storage jar (D.596.540) which may be dated to the period under discussion. Another type of medium-sized wide-mouthed jar (C.404.350) was found in two of the near-surface graves mentioned above. One example has undulating incised lines on the shoulder (see also p. 96).

Squat bottles with convex bases, already familiar from ED II–III (see Pls. 74 *l-m*, 102 *d-g*), seem to gain popularity in the Protoimperial period and survive into Larsa times (see p. 117). The type with double carination on the body, which first appears in ED III (see p. 99), continues in the Protoimperial period (Pl. 111 *a* and shape B.633.570*a*) and survives also into Agade and Late Gutium–Ur III times (see pp. 110, 113). A somewhat taller form (Pl. 111 *c*) has no close parallels in other periods. Another bottle form (B.663.520) found in the Protoimperial period occurs later with a ridge below the neck (Pl. 111 *h*; see p. 113). A form with low center of gravity (Pl. 111 *f*) is paralleled by somewhat smaller vessels (B.703.560). Taller bottles (B.635.670*a-b*) may be represented in the Protoimperial period (see p. 99).

A bottle with a pointed base and two suspension loops attached to the neck (C.665.621) is rather exceptional. Its nearest parallels are to be found among studded-ware vessels (see p. 102) and flasks (B.816.521*a-c*), but it differs from the former in its plain surface and from the latter in that it is ellipsoid instead of lentoid. As in earlier periods, other varieties of bottles, somewhat taller and with comparatively wider necks, were also used. Plate 112 *a-b* show two such bottles of somewhat different proportions, though *b* may be of ED III date (see p. 99). They both have short flaring necks and a peculiar type of surface finish which occurs on other vessels of the Protoimperial period. It consists of very slight parallel ridges of fine clay, noticeable especially near the maximum width, and is apparently the result of wet-smoothing while the vessel was still on the wheel. These two bottles and another form (B.665.520) which is fairly close to *a* in shape may be considered as intermediate between the bottles illustrated in Plate 111 and jars with convex bases and wide necks such as that shown in Plate 112 *c*. The surface of the latter is decorated with bands of incised lines, each of which really consists of a continuous spiral made while the pot was on the wheel. It has a small hole somewhat off-center in its base. Another form with a convex base (B.555.540*b*) has a more elaborate rim. It is found in the Agade period with a hole near the bottom.

Vessels similar in shape to those just described but usually with more pronounced necks and pointed bases (B.546.640*b*, B.566.670, C.546.640) survive into the Agade period (see p. 111). C.546.640 resembles a specimen (Pl. 112 *e*) which, as indicated by remnants of a clay bridge still adhering to its side, was one of a joined pair. Of the same general shape but with a convex base is form C.565.540. A convex-bottomed jar with straight walls and a well defined rimmed neck (B.225.540) may be included in this group. The jar shown in Plate 112 *d* would come under the category of cooking-pots. It has irregular lines and parallel ridges very similar to

those of Plate 111 *a-b*. Other cooking or storage vessels with convex bases are C.525.550, with a ridge around the shoulder, and C.654.520. A large ovoid storage jar with a convex base (D.465.550) has a ribbed shoulder and three plastic ridges below the join of shoulder and body. Other ovoid storage jars with convex bases are D.546.540*b* and D.555.510*b*. The drawn specimen (ED III) of the latter form has a hole in the base in a position very similar to those in the small jars mentioned above. A large ellipsoid storage jar (D.656.540) has rather thick walls. This form may have survived into Agade times. A very large globular pot (D.654.310) has a narrow ring base and a series of ridges on the body. Plate 115 *a* shows a large storage jar, with a ring base and a ribbed shoulder, which may belong to the Protoimperial period. An unusual form of large vat (D.333.250) with a wide flat base has corrugated walls (see also p. 112).

Braziers in the form of shallow bowls with vertical or near-vertical walls and inwardly projecting "lugs," already described in connection with the ED III pottery (p. 100), continue into the Protoimperial period (Pl. 104 *b-c*). Large braziers with four wide strap "handles" joined in the center (D.201.201*b*) also continue in this period (see p. 100). Undoubtedly related are large shallow utensils of oval shape (D.801.201) with three pairs of strap "handles" joined to a vertical partition. These could have served as "kitchen ranges." One specimen (Pl. 104 *e*) probably should be dated to the Protoimperial period, and the other (Pl. 117 *c*) belongs to the Agade period. An open vessel with concave walls and a concave base (C.233.100) is interesting because of a series of small brackets reinforcing the join between the walls and the base.

Another utensil which we consider a brazier (C.206.410) is roughly cylindrical and has a wide ledge-rim and a ring base. Its walls are perforated by two series of rectangular holes, one below the rim and the other just above the base. The rim is decorated with horizontal rows of impressed circles, and the surface between the holes with single or double vertical rows of impressed circles separated by multiple incised lines. The space between the two rows of holes is decorated with five shallow notched ridges. What seems to be a similar brazier with triangular instead of rectangular holes (C.204.210) is represented by a fragment. We have already seen (p. 101) that a vessel acquired from a dealer but reputedly found at Khafajah (Pl. 105 *b*) somewhat resembles these braziers of the Protoimperial period and may be contemporary.

Miniature vessels complete the list of characteristic utensils of the Protoimperial period. The most common among them are jars with carination between body and shoulder and either flat bases (A.515.270, A.524.260) or ring bases (A.515.370). A somewhat taller jar with no carination between body and shoulder is A.555.320. Miniature jars with convex bases are either ellipsoid (A.604.560, A.655.520*a*) or ovoid with low center of gravity (A.756.520, A.785.520). An ovoid container with a very narrow opening and a pointed base (A.565.610) was perhaps used as a jar stopper. A conical jar (A.303.503) has suspension lugs near the base and the mouth. A globular bottle (A.654.920) with two small holes in the neck (cf. p. 99) has short knob legs somewhat similar to those on miniature cups from ED III (see p. 100). A small disk with two double-perforated lugs (A.010.203) undoubtedly served as a lid (see p. 98).

Fragments of a unique painted vessel (Pls. 112 *f* and 139 *b*) were found at Tell Asmar in one of the houses dated to the period under discussion. They belonged to a medium-sized globular vessel with fairly thin walls and made of buff clay containing white (lime?) grits. The surface was covered with a yellow-ocher wash or slip over which a design was painted in brownish black. This design consisted of bands of oblique and of horizontal wavy lines bordered by horizontal stripes and what seem to be representations of a horned animal, a bird, and a ladder. While some elements recall earlier painted pottery (see pp. 64-65), I know of no contemporary parallel for this design in Mesopotamia. Dr. Braidwood has suggested that it may be connected with designs on North Syrian painted pottery found in phase J at Tell Judaidah.¹⁷⁴ Two pots

¹⁷⁴ See *OIP* LXI.

from Qatna presumably of the same ware show very distinctly the motif of a wavy line between two stripes, and one also has representations of birds.¹⁷⁵ A parallel can also be found in the pottery from Hamah.¹⁷⁶ However, until more examples of similar pottery are found in Mesopotamia, the significance of these parallels is doubtful.

Part of a theriomorphic vessel (Pl. 94 *c*; see also p. 94) was found in Protoimperial context and probably indicates that such vessels continued to be used in this period.

A sherd decorated with "columns" at the rim (Pl. 127 *c*) was found in the Northern Palace at Tell Asmar and indicates that, though such decoration was more common in subsequent periods (see p. 121), it was used in Protoimperial times.

THE AGADE PERIOD

It should be made clear at the outset that the subdivision of the Agade period into "Early" and "Late" phases as adopted in the present volume is based only on stratigraphic considerations. Stratum IV *a* of private houses at the northern part of Tell Asmar is called "Late Agade," and Stratum IV *b* is called "Early Agade." It is likely that in time these strata correspond fairly closely to periods which Jacobsen, on historical grounds, has termed "Interimperial" and "First Imperial" respectively.¹⁷⁷ The evidence for this correspondence is outside the scope of the present work and will be discussed in another volume of this series.¹⁷⁸

The collection of pottery from the strata under consideration is relatively small. It contains types which survived from earlier periods together with a number of new ones, some of which are especially significant as forerunners of types which survive through subsequent phases of Mesopotamian history.

Perhaps the most significant change to be observed in the ordinary household pottery is the absence of the open conical bowls (B.002.200*a-b*) which were the most common type of vessel in Early Dynastic times. However, similar though somewhat shallower forms (B.032.200, C.001.200*a*, C.042.200) are still found (cf. p. 105). Apparently replacing the simple conical bowls, and one of the most significant of the new types which appear in the Agade period, is a conical bowl with a slight inner ledge supporting an upright band-rim (Pl. 113 *b*). Varieties of this type survive through nearly all subsequent periods of Mesopotamian history.

Small bowls with inner rims, which were very common during the Early Dynastic period (see p. 95), were found occasionally in the Agade levels. Sometimes the rim projects outside as well as inside (Pl. 113 *a*). Form B.024.210 is known in the ED III and Protoimperial periods, whereas form B.084.210*a*, sometimes with distinct grooves on the inside, is new.

A bowl with near-vertical slightly concave walls (Pl. 113 *c*) belongs to either this or the succeeding period (see p. 113). A fairly deep open bowl (B.043.210*b*) has sharp ridges outside. A new type of utensil, which may have appeared for the first time in the Agade period, is a small bowl with a broad ledge-rim (B.061.210). It is possible that such bowls served as lids. Another type of lid is shown in Plate 114 *a*. Various conical bowls with either flat bases (B.001.200*b*, B.041.200) or convex bases (B.042.500*a*) were perforated with holes of various sizes and probably were used as colanders or strainers. A rough rounded bowl with a device for attaching a wooden handle (Pl. 114 *b*) was obviously intended to be used as a spoon or a ladle.

Of the small bowls decorated with applied clay pellets and rolls described among the ED

¹⁷⁵ Comte du Mesnil du Buisson, *Le site archéologique de Mishrifé-Qatna* (Paris, 1935) Pl. XXV 2 and Fig. 43.

¹⁷⁶ Harald Ingholt, *Rapport préliminaire sur sept campagnes de fouilles à Hama en Syrie (1932-1938)* (K. danske Videnskabernes Selskab, "Archaeologiske-kunsthistoriske Meddelelser" III 1 [København, 1940]) Pl. X 2.

¹⁷⁷ AS No. 11, Table II.

¹⁷⁸ *Private Houses and Graves in the Diyala Region*.

III pottery (p. 102) one specimen of form B.041.710 may be of Agade date. It has a small rounded disk on the base and a rather more distinctive rim than the earlier examples (cf. Pl. 106 *a*). Numerous sherds of such bowls were found in the Agade levels (see p. 102, n. 161). Another type of plastically decorated pottery which survived from earlier times is the studded ware (see pp. 102, 105). Only one complete specimen of this ware was found (see C.665.543*d*), but numerous fragments leave no doubt that it continued in use. Since these fragments were the first authentically stratified examples of this peculiar ware found in our region and since they occurred together with other types of objects paralleled by finds in the Indus Valley, they served as evidence of cultural relations between the two regions in the Agade period.¹⁷⁹ Older specimens of the same ware found subsequently would indicate, however, that cultural intercourse between the two regions existed also somewhat earlier.

A straight-sided bowl (C.211.200) with slightly ribbed surface is reminiscent of the ribbed ware found in ED III and the Protoimperial period (see pp. 101, 105). This ware is actually represented in the Agade period by specimens of form C.216.210, with notched ridges, and possibly form C.213.200. An open cylindrical vessel with slightly concave sides and a ring base (C.245.300) is decorated with two incised zigzags separated by two notched ridges; a single notched ridge forms the lower border of the decoration at the point where the vessel begins to taper toward the base.

Crude cups with flaring tops are found in the Agade period in the tall form (B.256.200) first encountered in the Protoimperial period (see p. 106) together with a somewhat squattier variety (B.255.200). While no larger cups of the same general type were found in Agade levels, the fact that they occur both earlier and later (C.257.210) suggests that their absence among our finds is accidental.

Small wide-mouthed flat-based jars clearly continue an Early Dynastic tradition (see Pl. 98 *a-l*). They are represented by forms B.174.220*c*, B.176.220*b*, B.184.220*a*, B.185.220, B.535.220, B.545.220*b*, B.644.220, and B.526.260. The last has a narrower, somewhat taller neck and nearly straight walls. A form which may be considered of the same general group (B.574.240), though it is more carefully shaped than the average, possibly survives into the next period (see Pl. 113 *j*). Occasionally, as in earlier periods (see p. 95), such small pots have pinched pouring lips (e.g. shapes B.575.224, B.645.224 and perhaps Pl. 113 *i*). Others have short tubular spouts. One of these (B.173.222) is somewhat squattier than the average and in shape approaches the large spouted bowls which are typical of the period under discussion (see p. 111). A vessel which is probably of Agade date (B.185.260) may be considered as related to the small wide-mouthed jars, though it has two ridges on its shoulder reminiscent of the ribbing on a small jar from the Protoimperial period (Pl. 110 *i*) and on much larger jars of the Protoimperial and Agade periods (see pp. 107, 111-12). A small jar with a high ring base and a well defined ribbed shoulder (B.466.470) may be considered as intermediate between form B.185.260 and the larger jars with ribbed shoulders.

Another type of vessel which survived into the Agade period from Early Dynastic and Protoimperial times is the squat bottle with convex base. Forms with double carination of the body (Pl. 111 *b* and shape B.634.570*b*) and with rounded body (Pl. 111 *d*) are represented. A somewhat larger specimen with a slightly pointed base (Pl. 111 *e*) is obviously related to the latter. The unusual combination of a squat bottle and a vertically perforated lug on the shoulder is represented by B.493.663, which may be later. While this form is related to the squat bottles just described, a vessel with a much wider neck and a vertically perforated lug at the mouth (B.654.523) is nearer in shape to forms (B.543.520, B.544.540) belonging to a group of small wide-mouthed jars with convex bases (see below). To return to the bottles, a taller ellipsoid form, known from ED I (see Pl. 49 *f*) and similar to Protoimperial forms (see Pl.

¹⁷⁹ See *OIC* No. 16, pp. 48-52.

112 *a-b*), is also encountered (Pl. 113 *e*). An even taller form (C.757.540), which is found in the Protoimperial period also, has a well modeled neck and rim, but its maximum diameter is near the base. The specimen shown in Plate 113 *h* was roughly burnished with vertical strokes. A small wide-mouthed jar with convex base (Pl. 113 *f*) has a similarly burnished surface. Other small wide-mouthed jars with convex bases include forms B.543.520 and B.544.540 (see above), B.644.520, and B.555.540*b*. The last, which survived from the Protoimperial period, has a fairly elaborate rim and a hole at the base. A group of slightly taller forms usually with pointed bases and longer necks (e.g. B.546.640*b*, C.546.640, C.565.540) survives from the Protoimperial period (see p. 107). A similar form (Pl. 113 *g*) has a somewhat more elaborate rim with a ridge below it. Such elaborations, typical of the Agade and following periods (see e.g. B.645.540*a* of Ur III date) and found on similar specimens from other sites, are quite useful for comparative dating.

Large spouted bowls are typical of the Agade period. A complete example of a common shape (C.053.312) is shown in Plate 114 *c*. The roll-rim of the short cylindrical spout and the well shaped beveled ledge-rim with a rounded groove underneath are worth noting. The second group of features is quite characteristic in later times of ordinary bowls without spouts. A similar form of spouted bowl (C.544.312) has its maximum width somewhat lower. Both variants occurred in Protoimperial strata, but since the majority of the examples derived from the Agade levels they may be considered as characteristic of the Agade period. A fragmentary spouted bowl decorated with a snake in relief (Pl. 92 *h*) was probably of the same shape as Plate 114 *c* (see p. 92). Other types of spouted vessels were comparatively rare in this period. A jug apparently with a slightly rounded base and a long rimless neck has a very short spout (Pl. 114 *d*). It is of rather poor make with relatively thick walls. Others occurred with either flat bases (Pl. 114 *e* and form C.646.222) or ring bases (C.557.372). The main features of these jugs seem to be their tall necks and narrow-channeled spouts. Thus they are quite distinct from the short-necked comparatively wide-mouthed spouted jars (e.g. C.556.322) which survived from ED III and Protoimperial times.

Jars with upright handles were absent in the Agade levels with the possible exception of a medium-sized jar (C.515.561). Its general shape, the remnant of what was apparently an upright handle, and the incised decoration on the shoulder indicate that it should be considered as a "descendant" of the Early Dynastic and Protoimperial upright-handled vases. It is different from them, however, in that it has a convex instead of a ring base and three incised lines below the join of body and shoulder.

A new type of medium-sized jar is shown in Plate 114 *f*. Its outstanding feature is the low center of gravity. Its ring base and rimmed neck with a plastic ridge are features which occur on other vessels. This type is in some respects a forerunner of a considerable variety of forms which become very popular in later periods of Mesopotamian history. The same can be said of a tall cup form with fairly thin walls, a ring base, and a wide well defined neck (B.527.340).

Besides the new types just described there are medium-sized household jars which continue earlier traditions, for example forms C.466.370 and C.466.470. A somewhat taller form (C.477.270) has a flat instead of a ring base but is otherwise very similar to the above mentioned jars. One specimen is perforated in the base and in the side (see drawing). A considerably larger jar (C.566.350) has a nearly horizontal shoulder. It is decorated with two finger-impressed ridges just below the join of body and shoulder.

We have mentioned (p. 110) two small jars, B.185.260 and B.466.470, with ribbed shoulders. Similar ribbing occurs quite frequently on certain medium-sized and large jars. The medium-sized jars are of shapes similar to those just described and also often have a plastic ridge at the join of body and shoulder, as for instance on the comparatively squat form C.475.360. Ribbed shoulders, however, are more characteristic of taller jars with ring bases

(e.g. C.466.450, C.467.350). A considerably larger type of storage jar (D.466.360), examples of which occurred in Protoimperial levels, has a similarly ribbed shoulder (Pl. 115 *b*). Occasionally the same type of shoulder is found on large storage jars with convex bases such as form D.465.550, an example of which was also found in a Protoimperial level. Usually, however, storage jars with convex bases are plain (D.546.540*a-b*, D.555.510*a-b*, D.555.540, D.596.540). The last mentioned form has undulating walls such as are characteristic of earlier medium-sized jars (see pp. 106-7). One specimen of this form (Pl. 115 *c*) has five different "potter's marks" painted in bitumen on the shoulder. Another significant detail of such forms is the angular join of the base to the body (Pl. 115 *d* and especially form D.555.540). This feature occurs on a jar from the end of ED III (D.556.540*b*; see p. 97). A rather unusual large ovoid jar (D.755.543) has two large pierced lugs at the shoulder and a hole in the convex base.

Large braziers with four "handles," first encountered in ED III (see p. 100), still survive, as indicated by several sherds. Plate 116 *a* shows two views of a large fragment, probably from Houses IV *a* at Tell Asmar, which illustrates fairly clearly the details of construction, especially the ridge along the middle of each "handle," the central cuplike compartment formed by the joining of the "handles," and the four holes connecting this compartment with the circular space around it. A miniature model of what seems to be such a utensil was found at Bismayah (Pl. 116 *b*). Two rams with their forelegs in the outer compartments are feeding or drinking from the central cup, and there are traces of a third animal in the third compartment; such utensils, then, were apparently used as feeding troughs. The practice of handing over animals to brewers for fattening is well attested from texts, and possibly special feeding utensils were used for such comparatively expensive fodder as brewers' mash.

Another type of brazier is decorated with closely spaced notched ridges and is thus reminiscent of some specimens of ribbed ware, which appeared at the end of ED III (see p. 101). It is an open vessel with a squared "ring" base perforated in the center (Pl. 121 *d*). It was found near the surface at Tell Asmar and may belong to a later period.

A large oval utensil with six wide strap "handles" joined to a vertical partition (Pl. 117 *c*), as already suggested (p. 108), might have served as a "kitchen range." Another large utensil which must have served some domestic purpose is of a shallow troughlike oval form (D.800.200) divided in the middle by a double partition and made of the coarse fabric usually associated with very large utensils in nearly all periods (see also pp. 100 *f*., 114, 118). A deeper open "tub" with concave sides and a ring base (D.022.410) may be considered in the same class with somewhat earlier vessels of similar forms (C.022.300, C.233.100). An unusual form of large vat (D.333.250) with a wide flat base and corrugated walls is already known from the Protoimperial period (see p. 108). A vertical drain with bell-shaped uppermost section (E.313.040) occurred in the Agade period (see also p. 119).

Among the miniature vessels from the Agade levels are ellipsoid or globular jars and bottles with round or pointed bases (e.g. A.515.660, A.544.520, A.653.540) which have parallels among miniature pots of other periods. Occasionally miniature jars have two double-perforated lugs (A.303.423, A.624.563). A jar with a tall foot or pedestal base (A.506.860) probably belongs to the Agade period. Another vessel which is probably of Agade date combines both features (A.237.823). Actually it consists of a miniature globular jar, with two perforated lugs, joined to a tall pedestal base. Unlike the great majority of miniature vessels, which are rather crudely made and undecorated, this example is fairly well shaped and is decorated with crosshatched incisions. A troughlike object with a pierced lug at one end (A.831.203) probably served as a ladle when tied to a stick. Unfortunately there is no pictorial record of it.

A nearly complete theriomorphic vase representing a ram (Pl. 94 *f*) indicates that the type of ram-vessel which was rather common in ED III (see pp. 93-94) continued in use in the Agade period. The body of the vase is wheelmade, while its spout-head was hand-fashioned. Remains

of a perforated "lug" at the front are still distinguishable. The wheels shown in Plate 94 *f* were not found with the vase.

END OF GUTIUM AND UR III

The time between the end of the Agade dynasty and the rise of the Isin and Larsa dynasties, that is, the last years of the Gutian domination and the whole of the third dynasty of Ur, is rather poorly represented in our finds. This is due to the fact that remains of this time were dug only at Tell Asmar, where in some areas they were near the surface (Houses III-II) and in others they lay below massive ruins of later times at a depth which made excavation of large sections well-nigh impossible. Moreover, the poor state of preservation of some of the ruins near the surface made it difficult to record the exact stratification of some of the finds, so that possibly some of the material assigned to Houses III-II may belong to either Late Agade or Early Larsa respectively. In view of this possibility and because of the scantiness of the material it seemed preferable to discuss it as a single group. However, it is very likely that if larger areas occupied during this space of time were excavated and even if material from other excavated sites yet unpublished could be taken into consideration, one would be able to draw a clear distinction between pottery made during the last years of the Gutian domination and that made during the third dynasty of Ur.

Open conical bowls of the form dominant among Early Dynastic pottery are represented by only one specimen (B.002.200*b*) in the levels under discussion, while thick-walled bowls of shape B.032.200*b*, of which numerous specimens are known from the Protoimperial period, seem to have been popular. A shallower form (B.031.200) was also found. Other open bowls include shapes C.042.200 (Pl. 110 *b*), B.043.200*a-b*, and perhaps B.123.210 (Pl. 113 *c*; see also p. 109). However, the most popular form is B.151.210, which first appeared in the Agade period (Pl. 113 *b*; see p. 109). This popularity is reflected even in the miniature vessels (A.151.210). A somewhat larger bowl with a different type of rim and a ring base (C.111.310*a*) occurs; the same form except for a flat base (C.111.210) was found on the surface and may be contemporary. Small bowls with broad ledge-rims (B.061.210), which we presume were used as lids, continue and, indeed, persist into later times. Tall crude cups with flaring tops (Pls. 113 *k*, 114 *g*) survive from earlier times.

Small, rather crude, wide-mouthed, flat-based jars continue from earlier periods (Pl. 113 *d* and perhaps *j*; shapes B.184.220*a*, B.573.240). Again this type occurs occasionally with pinched pouring lip. One such form (B.536.224), which may have occurred in the Agade period also (see Pl. 113 *i*), has a rather tall flaring neck. Other forms have small spouts (Pl. 113 *l* and form B.545.222*b*). Small flat-based jars occur occasionally with a narrow mouth (e.g. B.536.240*b*).

Besides the small rather crudely made spouted jars mentioned above, there are a few spouted vessels of more careful make which may fall within the range of time under discussion (B.546.222, with a tall flaring neck, and C.657.242). Large spouted bowls of shape C.544.312 are represented by a single example.

Squat bottles with convex bases are still represented. Two are shown in Plate 111 *g-h*. The first is of the type with double carination on the body, already known from the ED III, Protoimperial, and Agade periods (see p. 107). The second, whose rim is unfortunately broken, has a new feature, namely a plastic ridge below the neck. Another specimen of the same form but of Protoimperial date was found some distance from the one illustrated. A taller wide-necked jar (B.645.540*a*) may be considered of the same general type as Plate 113 *g*, though it has a shorter neck and a somewhat more elaborate rim (see p. 111). This type has very close parallels from other sites and is thus useful for comparative dating.

Few medium-sized household vessels were found. Form C.466.470 is a survival from earlier times. A pot which may belong to the Agade period (C.555.440) is one of the few utensils

found with its lid (a broken base) still in position. The oblong, rather crudely fashioned pot shown in Plate 114 *h* may represent a group of pottery of which no other specimens happen to have been found. Medium-sized storage jars with round bases are represented by form C.555.510, and large storage jars by form D.556.640, with a slightly pointed base and a corded ridge at the shoulder. The latter form survives into the Larsa period (see p. 118).

Large shallow braziers with three or four strap "handles" joined in the center (D.201.201*a-b*), described above (pp. 100 *f.*), still survive. Two broken specimens are shown *in situ* (one of them upside down) in Plates 117 *b* and 118 *b*.

Parts of various kinds of drains used in the Gimilsin Temple at Tell Asmar include an element of a vertical drain (E.202.010), tubular pipes of a horizontal drain (E.208.010), and a bell-shaped element (E.313.020). A funnel-like cylindrical drain found in Houses III at Tell Asmar (E.257.010) is to be illustrated in *Private Houses and Graves in the Diyala Region*.

A large shallow oval "tub" with an outlet at the bottom (Pl. 118 *a*), made of the coarse fabric usually associated with large utensils, could have been used as a crucible (see p. 101). In general it resembles form D.800.200, which occurs in the Late Agade and Early Larsa periods.

Two significant new types of vessels which were used throughout many later centuries are thin-walled cups (B.706.360; see pp. 115–16) and lamps (B.813.522). Though it is possible that oil lamps were used much earlier (see p. 43), and shell and shell-shaped metal lamps are known from the Early Dynastic period,¹⁸⁰ the lamp under discussion is practically identical in form with oil lamps used in the Near East from ancient until very recent times (see also p. 122).

Miniature vessels include a cup (A.026.200) and jars (A.055.100, A.545.360). The latter jar has a narrow ring base and incised decoration on the shoulder somewhat like that of a later miniature jar (cf. Pl. 119 *b*). Miniature bottles are of a shape (A.653.540) found in the Agade period.

THE ISIN-LARSA PERIOD¹⁸¹

The period of the Isin and Larsa dynasties is well represented in our excavations at Tell Asmar and to a lesser extent in the excavations at Khafajah and Ishchali (see p. 30). The great majority of our finds belonging to this period derive from stratified building remains, most of which can be assigned to definite reigns on the basis of stamped bricks or tablets bearing date formulas. However, in the date column of the catalogue of forms only two phases of the period are distinguished—"Early Larsa," from the beginning of the period through the reign of Ibalpiel I,¹⁸² and "Late Larsa," from the reign of Ibalpiel I to the end of the Larsa dynasty, which extended according to Jacobsen¹⁸³ into the latter part of Hammurabi's reign and thus coincided with about 130 years of the first dynasty of Babylon.

The pottery of the Larsa period is generally wheelmade, fairly thin-walled, and well fired, but the quality of the workmanship varies considerably. The pottery is usually undecorated, but simple incised and impressed decoration and plastic ornamentation do occur. In a class by itself is a gray ware decorated with white-filled incised and impressed designs (see pp. 119–20). One jar with painted decoration (Pl. 119 *a*) may be of Larsa date. Its design, however, is not related to any known from earlier painted wares; it is painted in a thin coat of bitumen, a substance used occasionally for "potter's marks" in earlier periods (see pp. 103, 112).

While decorated pottery is rare in the Larsa period, there is a considerable variety of forms. Some are related to earlier types, others are new. Open conical forms range from miniature bowls such as A.002.600 (stratification uncertain) to a large vatlike utensil (D.044.510). One miniature conical bowl (A.002.203) has a small perforated lug by means of which it could have

¹⁸⁰ See *Miscellaneous Objects from the Diyala Region*.

¹⁸¹ Otherwise referred to as the "Larsa period."

¹⁸² See *Gimilsin Temple*, p. 198.

¹⁸³ *AS* No. 11, pp. 197 *f.* and Table II.

been attached to a handle to serve as a spoon. Other miniature open conical forms include A.111.210 and perhaps A.043.210. The former resembles in general form larger bowls such as C.111.310*b* and B.151.210. The latter form, with an upright band-rim (Pl. 120 *a*), which first appeared in the Agade period (see Pl. 113 *b*), is indeed the most common among household bowls of the Larsa period. Somewhat larger bowls with more elaborate rims and ring bases are C.111.310*b* and C.142.310.

An unusual shallow dish with a flat base and a pronounced rim is B.140.210. Other shallow bowl forms are B.031.200 and C.001.200*a-b*. A few specimens of a deeper, rimless, thick-walled type of bowl (B.032.200*b*) known first in the Protoimperial period should likely, but not certainly, be dated to the Larsa period. Still deeper bowls are represented by B.043.200*b* and B.043.210*a*, both of uncertain but possibly Larsa date. The latter has a rim and a corrugated surface resembling those of B.043.210*b* of Agade date. A similar medium-sized bowl with a ring base (C.043.310) is decorated with two shallow grooves, as are bowls of forms C.044.210 and C.044.310, which are of either Late Larsa or Old Babylonian date. These open vessels in turn are not greatly different in shape from certain large vats (see p. 119).

Bowls with slightly inturned rims are represented by B.052.200*a,c*, and possibly *b* (Pl. 120 *c*). A similar form (C.053.212) has a spout near the slightly beveled rim and is decorated with multiple incised lines at the height of the spout. A smaller bowl of similar form (B.052.202), with a spoutlike reinforced perforation at the rim, may be of Larsa date.

Quite typical of the Larsa period, though perhaps introduced somewhat earlier (see p. 109), are small bowls with broad ledge-rims (B.061.210, B.062.210*a*) which possibly served as lids. The specimen illustrated in Plate 120 *b* shows the characteristic spiral groove on the flat string-cut base. A different type of lid (see Pl. 130 *a-c*) is described below.

Occasionally bowls are perforated with numerous holes to form "colanders." These occur with convex (Pl. 120 *d*) and flat (B.001.200*b*) bases. A specimen with a ring base (Pl. 120 *f*) may be of Larsa date. Plate 120 *f* reveals an interesting detail of construction, namely that the bowl was perforated before the ring base was added, for the center holes are blocked by the base. A convex-bottomed bowl with a single perforation in the base (Pl. 120 *e*) may be related to the "colanders." A somewhat deeper bowl with a perforated knob base (B.174.740) is of the same type, but it may have been used as a funnel. It may belong to the Old Babylonian rather than to the Larsa period. It resembles in principle much larger utensils with perforated bases (D.044.510). A bowl with a convex base and a ledge-rim (B.644.540) resembles Plate 120 *e* but has a narrower neck and no perforation in the base. An elongated cylindrical form of the same general type (C.206.510) has a more elaborate rim.

Perhaps the most outstanding feature of the household pottery of the Larsa period is the abundance of cylindrical and near-cylindrical vessels, the majority of which may be considered as drinking cups. Such cups appear now in great numbers and in a considerable variety of shapes. The crude thick-walled type with flaring top (B.255.200, B.256.200) survives from earlier times. Most of the new types, however, are thin-walled and were made of fine paste, though their baking was not always perfect. Their color varies from pale yellow to brownish red. One group consists of shapes with slightly concave walls and varying somewhat in size and proportion. They are usually rimless, but their bases vary. Some have plain wide bases, either flat or slightly rounded (Pl. 120 *g* and perhaps form B.236.200*b*); other bases are considerably narrower than the bodies, which are carinated near the bottom. The narrower bases in turn are flat (Pl. 120 *h* and forms B.237.200, B.247.200), slightly concave (Pl. 120 *i*), or ring-shaped (B.236.300).

A second group of cylindrical cups is characterized by a slight flaring at the mouth and a narrow base with no carination above it. Occasionally such cups were decorated with a series of horizontal grooves and a black band at the rim (B.246.200*a*). A more elongated form has a

narrow knob base (B.247.700). Another cup of this group is unusual in its sinuous contours and convex base (B.246.500). A cup of rather uncommon shape (Pl. 120 *j*) has concave walls with the maximum width near the bottom and a narrow knob base.

Cups of a third group, from Ishchali, have narrow bases and wide "necks" accentuated by simple incised lines (B.226.720*b-c*) or by slight molded ridges (B.226.720*a*). Two smaller and thicker-walled cups (B.646.710, B.756.220) may be considered as related to this group.

Cups of yet another group, with more or less ovoid bodies and narrow knob or stump bases, are characterized by well defined necks. Forms of this group are B.175.720, with a fairly tall, wide, flaring neck, and B.175.760, with a shorter neck and a more elaborate shoulder. The latter may belong to the old Babylonian period. Related to it is a cup (C.175.720) decorated with horizontal ribbing. A proportionately narrower form (B.176.220*a*) has a short flaring neck. Form B.644.720 belongs to this group on account of its well defined neck, though it is shorter than the others and its maximum width is comparatively lower. In a way it may be considered as intermediate between forms B.175.720 and B.706.360, a form which appeared slightly earlier (see p. 114). The latter occurs now occasionally with a black band at the rim. All three forms may be regarded as prototypes of cup forms which prevailed in considerably later times in Mesopotamia.¹⁸⁴

The above described relationship in which a so-called "intermediate form" shares certain features with two distinct types is fairly common in the Larsa pottery. Indeed, it is often possible to arrange a series of forms each differing but slightly from the next so that they bridge almost imperceptibly the gap between two quite different types. Thus, for instance, the form represented by Plate 121 *a* may be considered as a somewhat elongated version of B.175.720, though it has a less flaring neck and a wide ring instead of a narrow stump base. In arranging a series with this form as the starting point, our results will vary according to the features chosen for comparison and their variations. The larger vessel represented by Plate 121 *f* is clearly similar, but it is somewhat more elongated and has a narrow stump base. A taller form (C.548.720) is similar to the latter but has no clear demarcation between neck and body. It may be noted that numerous examples of both shapes were found together. In its turn C.558.320 is very similar to C.548.720 except that it has a narrow ring instead of a stump base and slightly corrugated walls. The tall jar shown in Plate 121 *e* is very similar to C.558.320, differing only in its somewhat wider base, more distinct rim, and a groove between neck and body. On the other hand, like the latter, it has a slightly irregular outside surface and deep finger marks on the inside (clearly visible in upper view). C.228.340*b*, perhaps of Larsa date, though somewhat larger, is practically identical in form but is decorated with multiple grooves and its rim is somewhat more elaborate. The form represented by Plate 121 *g* is similar to C.228.340*b* but has a slightly narrower neck, a tall ring base, and a different type of rim. Finally, C.557.170 and C.757.340, though of different general contours, are also comparatively tall and have certain features in common with some of the vessels just described. The base of C.557.170, which may be of Old Babylonian date, is one of the extremely rare examples of a real "cup" base among our pottery.

Smaller cylindrical vessels such as B.207.310*a-b* may be considered as related to the tall vessels just described. Although in certain respects they resemble some of the drinking cups, the fact that they have rims suggests that they were not drinking vessels. Wide-mouthed barrel-shaped jars (B.646.340, C.635.360) are remotely similar to the cylindrical vessels. Form C.635.360 may be of Old Babylonian date.

A great variety of small ovoid jars was used in the Larsa period. Some of them, with wide mouths and flat bases (B.174.220*b*, B.535.220), resemble much earlier vessels (cf. e.g. Pl. 98 *a-l*). A wide-mouthed jar with a ribbed shoulder (B.536.270) resembles a vessel from the Proto-

¹⁸⁴ See e.g. cups from Nuzi (Starr, *Nuzi II*, Pls. 77-78).

imperial period (see Pl. 110 *i*). More characteristic, however, are jars with narrower openings such as B.526.260, with a well defined shoulder and a short rimless neck, B.475.250*a*, with corrugated walls, and B.475.250*b*, with a ribbed shoulder. A characteristic group of small jars with well defined neck and rim and grooved decoration as demarcation between shoulder and body is represented by B.505.270*a-b*, B.506.270*a-c*, and B.506.370, the last being the only one with a ring base. Form B.546.260 belongs to the same group, though it has a less clearly defined shoulder and no rim. Other small jars have slightly narrower necks, flat bases, and usually no pronounced demarcation between body and shoulder and between neck and shoulder (B.536.240*a*, B.545.220*c*, B.546.240). A form with a rimless flaring neck and a marked angle between neck and body (B.546.220) occurred much earlier, in burials of ED I and II (see Pl. 72 *d, g*). A narrow-necked jar with a horizontal ledge-rim and a narrow ring base (B.546.370) is decorated with three incised lines below the neck. A taller form (B.527.360) has close parallels in somewhat larger jars (C.447.360, C.547.320). A small jar with a clay stopper (Pl. 107 *c*) apparently was used as a "jewel box" or "safe" (see p. 103).

Bottles with ring bases occur in a variety of shapes. An ellipsoidal form with a flaring rimless neck is shown in Plate 121 *c*. Forms with the maximum width at a comparatively lower point are B.787.320*a-b* and C.787.340, the last with a slight rim. Another variety with a low center of gravity, found at Ishchali, appeared at the end of the Larsa period (B.766.320*a*), and perhaps survived into Old Babylonian times (B.766.320*b*). An undated vessel from the surface at Tell Asmar (B.706.370) resembles the specimens from Ishchali but has two carinations on the body and a slight rim. The painted vessel shown on Plate 119 *a*, which may be from the Larsa period, is in turn very close in shape to B.706.370, though slightly wider. Bottles with convex bases are discussed below.

We have seen (p. 115) that the most common household bowl of the Larsa period (B.151.210) has a counterpart in miniature; similarly, other types have miniature counterparts. In fact, miniature vessels were quite numerous in the Larsa period and on the whole were well enough made to be quite serviceable. Form A.545.320 is a jar with a short flaring neck and a narrow ring base; A.655.120 is a squattier form with a concave base, while A.656.700 has a stump base. Of special interest are vessels (A.556.423) whose necks are decorated with "buttresses" similar to those on a larger jar (C.405.363) of ED III date (see p. 97). Sherds from similarly decorated pots are described on page 121. A well shaped wheel-turned vessel (A.444.250) with well preserved traces of bluish glaze on the surface is probably of Larsa date and may indicate that this type of surface finish was occasionally used as early as the Larsa period. Miniature vessels with convex bases include forms A.604.520, handmade, A.653.540, a form surviving from the Agade period, A.663.520, and perhaps A.655.520*b*, a globular bottle with a comparatively wide and long neck. A tall bottle with a convex base and an elaborate neck (A.758.540) also may belong to the Larsa period. It has very close Larsa parallels in much larger bottles (C.758.510). Squat bottles with convex bases, which were very common in earlier periods (see p. 107), appear now in only one form (B.664.540*c*).

Three miniature spouted vessels, each with a fairly tall ring base, are shown in Plate 119 *b-d*. The spout of *b* is broken off; its shoulder has incised decoration somewhat like that of an earlier miniature jar (see p. 114). Plate 119 *d* is the miniature counterpart of a slightly larger vessel (B. 527.462) with a row of small impressed circles on the shoulder. Of the other spouted vessels, we have already mentioned a bowl (p. 115). A small flat-bottomed jar with a concave shoulder (B.446.262) has a comparatively long spout. Another spouted jar (Pl. 119 *e*) was found among debris which could not be precisely dated, but it is very likely of the Larsa period. It resembles some of the earlier spouted jars (cf. e.g. Pl. 110 *d*), though it is more carefully fashioned. Its spout, however, is very crudely made and rather clumsily joined to the body. A fragmentary jar with traces of what seems to have been a clogged spout (B.556.471) was ap-

parently somewhat different in form from earlier jars with clogged-spout handles (see pp. 92, 106), and it has incised decoration on the shoulder while the others are plain. A detached strainer-spout (Pl. 130 *g*) shows that this practical device was used in the Larsa period. Unfortunately, however, there were no indications regarding the type of vessel to which it belonged.

Among medium-sized vessels, in addition to the tall forms mentioned on page 116 there are a considerable number of squattier jars with comparatively narrow necks and flat or ring bases. A jar with corrugated walls and a rimless neck (C.485.220) is fairly similar to some of the small ovoid jars described above (e.g. B.505.270*a*, B.536.240*a*, B.545.220*c*). The Larsa specimens of form C.546.320 have exceptionally narrow flaring necks, unfortunately broken at the top. However, such necks, most frequently found on bottles, are usually rimless (e.g. Pl. 121 *c*). Well made thin-walled jars (C.545.340*c-d*) sometimes have a well modeled ridge at the base of the neck (Pl. 121 *b*). Medium-sized jars of similar proportions are C.545.440, somewhat larger and with thicker walls, C.555.320, and C.556.320. A rather thick-walled jar (C.655.240) has a short flaring neck and an unusual disk base. Form C.656.340 has a well modeled rim and multiple shallow ridges at the base of the neck.

Medium-sized jars occur also with convex and pointed bases. One form has a near-cylindrical body and a wide flaring neck (Pl. 119 *f*). Another has a narrow neck and a plastic ridge at the junction of body and shoulder (C.507.570). A considerably larger jar with a shorter neck (C.467.560) has three plastic ridges just below the shoulder. Unfortunately its base is broken, but it seems likely that it was either convex or pointed. Forms with pointed bases are C.547.640*a-b*. Very similar jars are known from other sites.

Several forms of storage jars also have pointed bases. Some such jars are plain (D.545.640); others are decorated with single or double corded ridges (D.556.640, D.525.670). Another type of storage jar has a ridged surface. The only specimen complete enough to be included in the catalogue (D.495.520) has corded ridges. However, numerous sherds indicate that such jars sometimes had notched or plain ridges. These jars approach large vats (see p. 119) in size and like them were presumably too expensive to be thrown away when damaged. Therefore they were occasionally used as parts of vertical drains after the bottoms and sometimes the tops had been broken off.

Thick-walled cylindrical pots with flaring tops (C.246.310) are decorated with closely spaced notched ridges and are thus reminiscent of ribbed ware, which appeared at the end of ED III (see p. 101). Their shape too is fairly similar to some of the ribbed-ware forms (cf. Pl. 105 *e-f*), but unlike most of the latter they have well formed ring bases. A fragment of a similar utensil with a hole in its base (Pl. 127 *i*; cf. Pl. 121 *d*) was found in the court of the Gimilsin Temple at Tell Asmar and may be of Larsa date. While its surface is decorated with notched ridges, it has near the base additional plastic decoration which is described on page 121.

Of the large shallow braziers with four strap "handles" (D.201.201*b*), at least two examples derived from a stratum which is probably of Larsa date. Plate 117 *a* shows one of these *in situ* near a section of a vertical pottery drain. Another utensil (C.201.205) is reminiscent of the braziers with inwardly projecting "lugs" (see p. 100), but a short outlet at the bottom suggests that it may have been used as a crucible (see pp. 101, 114). D.301.112, with a spout at the slightly concave base, may have served the same purpose. Surviving from an earlier period is a type of large shallow troughlike oval utensil divided in the middle by a double partition (D.800.200). Most of the utensils just described are of the coarse fabric used for large utensils in nearly all periods (see p. 112). Of the same kind of fabric is a large cuplike vessel (D.044.510) with a round hole in the bottom, a well modeled rim, and incised decoration below the rim. Utensils of this type presumably could have been used as funnels or filters. However, it may

be noted that some very similar utensils found at other sites were used as burial urns for children.¹⁸⁵

In shape and size the "urns" approach large vats, which, however, usually have ring bases (E.225.310). Vats of the same and similar forms are known in earlier periods (see p. 104). They too were apparently too expensive to have been thrown away when damaged and were sometimes used as sections of vertical drains. Forms E.223.010 and E.314.010 are obviously such vats with the bases broken off. The latter is drawn upside down as found in a drain. The large vats were usually decorated with fairly closely spaced plastic ridges—plain, notched, or corded. Two vats (E.244.310, E.544.310) with plastic decoration of exceptional interest were found, one inverted on top of the other, in a small shrine of the Larsa period and are described on pages 121-22.

Although broken vats were occasionally used as parts of drains, most of the vertical drains sunk from houses of the Larsa period consisted of elements made especially for the purpose. They were usually cylindrical, varying in height and diameter, and often with one or both of the edges strengthened for fitting one element on top of another (cf. Pl. 117 *a*). Various types of such strengthening "rims" occur on forms E.202.010, E.232.010, and E.313.010. The last is somewhat wider at the bottom and is reinforced by a series of plastic ridges. It is doubtful whether such elements as E.223.000 (with corded ridges) and E.655.000, both without traces of rims, are broken vats (like E.223.010 and E.314.010) or were originally made as elements for the drains in which they were found. Uppermost sections for vertical drains, especially made with a narrow neck around which baked-brick pavement could be laid, are represented by E.313.040. Such uppermost elements have also been found at other sites. In addition to the vertical drains, horizontal drains composed of long tubular elements were abundant in the Larsa levels.¹⁸⁶ One of the most typical of such elements is of shape E.229.010 and is reinforced at both ends. In connection with the drains one may mention a shallow unusually shaped utensil (Pl. 118 *c*) which may have served as a wash basin.

Characteristic of the Larsa period are small peculiarly shaped jars with lugs (B.206.423) and nearly always with impressed or incised decoration. They are of fairly coarse buff or reddish clay, and their designs consist of simple incisions (Pl. 122 *a-b*) and of impressed crescents and circles (Pl. 122 *c-d*). Although outwardly they appear to be roughly cylindrical, it can be seen in the drawings and in Plate 122 *d*, which shows a specimen with the base broken off, that they are really ellipsoid containers with high ring bases formed by continuation of the walls. Below the neck they have either four equally spaced single-perforated lugs (B.206.423*a-b,d*, and one specimen of *c*) or two single- or double-perforated lugs (B.206.423*c* and *e* respectively). Sometimes there are perforations above the ring base corresponding to the lugs (Pl. 122 *a-b*). A miniature form of Agade date (A.303.423), though proportionally shorter and undecorated, has some of the features just enumerated.

These small jars are of special interest because they introduce us to a very characteristic fine gray, sometimes burnished, ware with incised, pricked, and impressed decoration. For the most part the vessels of this ware are of the same general form as the small jars described above, but they are usually larger and of better workmanship. Unfortunately we found no complete specimens, but some of the larger fragments (Pls. 124 *a-a'* and 125 *b-b'*) show the characteristic inner convex base after the high ring base had broken off. Other fragments (Pls. 122 *e*, 123 *i*, and 125 *a-a'*) show the typical lugs. Two fragments (Pl. 123 *a-b*) show that this ware included other forms such as open bowls. Traces of a white substance preserved in some of the designs (Pl. 123 *b, f, i*) indicate that they were originally white-filled. We filled

¹⁸⁵ See e.g. Genouillac, *Telloh* II 28 and Pl. XXXIII 803.

¹⁸⁶ See e.g. *Gimilsin Temple*, Figs. 17-18, 23, 50, 64.

the incisions in some of the sherds (Pls. 123 *h* and *k*, 124 *c-d* and *e'*, 125) with white powder in order to bring out the designs. Traces of red paint preserved on some fragments in the narrow otherwise undecorated panels indicate that at least in some cases a polychrome effect (gray, red, and white) was sought. Impressed concentric circles were very popular and occur either in rows as part of a pattern (Pl. 123 *a-c*, *g*, *k*) or individually as fill (Pls. 123 *d*, *f* and 124 *a-a'*, *b*). In some cases they seem to be suspended from vertical lines (Pl. 123 *h*, *j*) or supported by them (Pls. 123 *e* and 124 *e*). Semicircles supported by vertical lines occasionally occur in representations of boats, and this may have been the case in Plate 125 *d*. It would seem that they are in the nature of a purely decorative motif, as are the concentric circles supported by lines, rather than "standards."¹⁸⁷ Another very common motif is a horizontal or vertical band filled with regularly spaced pricks. Occasionally such filling was employed in triangles (Pl. 125 *b'*). Other nonrepresentational motifs are loops (Pls. 123 *i* and 125 *b'*) and rosettes set in a geometric figure (Pl. 125 *b'*) and in the field of a representational design (Pl. 125 *b*). The bird figure is the most common in the representational repertoire (Pls. 124 and 125 *b-c*). The design on Plate 124 *b* may be an unusual representation of a bird in flight. Quadrupeds are to be seen in Plates 124 *a* and 125 *d*. In addition the latter fragment shows part of a boat (see above). Plate 126 *a* shows one of the rare fragments of this ware with a representation of a human figure, a bearded man wearing a short skirt and a girdle. In his right hand he holds a battle-ax and in his left what seems to be a shield. Similar figures occur on terracotta plaques and cylinder seals.

This ware is well known from other sites, especially Telloh and Susa, where some of the designs found on our specimens are practically duplicated.¹⁸⁸ Except for one doubtful sherd (Pl. 123 *c*), which may be somewhat earlier, all the fragments of this ware from our excavations were found in Larsa levels and thus it seems to be later than generally thought hitherto.¹⁸⁹ The fact that most known examples of this ware belong to the same type of vessel and that practically identical designs are found at different sites suggest that this ware may have been a specialized product of one site or region whence it was exported to other localities. Obviously the place of manufacture is not necessarily any one of the sites at which the ware has thus far been found.

Incised decoration occurred occasionally on vessels of various forms made of the ordinary light-colored clay. Plate 126 *b* shows a shoulder fragment decorated with a series of shallow notched ridges with wavy comb-incised lines between. The exact provenience of this fragment is unknown, but the notched ridges suggest that it may be of Larsa date (cf. Pl. 127 *d-f*). A fragment of Agade or later date (Pl. 126 *c*) also has comb-incised wavy lines and a notched ridge. Another shoulder fragment (Pl. 126 *d*), of reddish-buff clay,¹⁹⁰ is decorated with narrow bands notched in a herringbone pattern and triangles filled with the scale pattern which is well known to be a conventionalized representation of mountains.¹⁹¹ A sherd found in a dump near the Larsa town wall at Tell Asmar and probably of Larsa date (Pl. 126 *e*) combines incised, impressed, and appliqué decoration. Horizontal grooves divide the surface into bands, two of which are filled with impressed circles; in the third are remains of an incised motif (possibly a tree). Hemispherical knobs and a crudely modeled quadruped applied in relief com-

¹⁸⁷ See Léon Heuzey in Cros, *Tello*, p. 38; but see also Frankfort, *Studies* I 138.

¹⁸⁸ See Cros, *Tello*, pp. 36, 236, 244, 255 f.; Genouillac, *Telloh* II, Pls. D and 110; *Mém.* XXV (1934) 210 f. and Pl. XI.

¹⁸⁹ See e.g. Frankfort, *Studies* I 138.

¹⁹⁰ In *Gimilsin Temple*, pp. 214 and 238, this sherd (As.31:79) was erroneously included with the incised gray ware.

¹⁹¹ Exactly the same pattern often appears on cylinder seals showing Shamash rising from the mountains (see e.g. Frankfort, *Cylinder Seals*, Pl. XIX *a*) and also on other monuments (see e.g. Eckhard Unger, *Sumerische und akkadische Kunst* [Breslau, 1926] Fig. 43; Andrae, *Kultrelief aus dem Brunnen des Asurtempels zu Assur* [WVDOG LIII (1931)]; Frankfort, "The Burney relief," *Archiv für Orientforschung* XII [Berlin, 1937-39] 128-35).

plete the decoration. A rim fragment with an applied snake (Pl. 126 *f*) shows possible traces of incised decoration. A fragment decorated with applied clay pellets and flattened rolls (Pl. 106 *e*) is probably of Larsa date. It seems to be part of the "shield" of a model chariot rather than a potsherd (see p. 103). A somewhat different type of applied ornament was obviously inspired by metalwork. Two fragments from Tell Asmar (Pl. 126 *g-h*) have applied "tongues"; on these and on the rims are little applied knobs, which are apparently imitations of metal studs or rivets. A fragment from the Old Babylonian period at Khafajah (Pl. 126 *i*) has an even clearer imitation of a metal ring fastened to a handle. A sherd from Tell Asmar with impressed scalelike design (Pl. 106 *g*) may be of Larsa date.

Plate 127 shows a number of fragments from various periods with a peculiar kind of plastic decoration. All of them except *i* are rim fragments. One (*a*) is from Khafajah Mound A and of ED III date. It has a single fairly large "buttress" or "column"¹⁹² against the rim. The others are from Tell Asmar and except *i* have similar decoration at the rim. One fragment (*b*) has two of a series of "columns," but with holes in them, spaced at some distance from each other.¹⁹³ In *c*, which is from the Protoimperial period, the "columns" are somewhat simplified and are placed closer to one another, while in *d-e* and *g* they actually touch. The "columns" of *f-g* do not have the modeled heads characteristic of the others. Finally, in *h* the decoration is simply a series of deep gashes around the rim. This type of rim decoration occurs also on miniature vessels from Ishchali (A.556.423) and on an ED III pot from Tell Asmar (C.405.363; see pp. 97 and 117). It occurs on vessels of various shapes from other sites.¹⁹⁴ Some of our fragments (Pl. 127 *b, d-f*) indicate that this type of rim decoration was combined with closely spaced notched ridges. A fragment apparently from a brazier (see p. 118) also is decorated with such ridges (Pl. 127 *i*), but in addition it has near the base a series of stepped "semi-columns" which were apparently shaped by the inside of a split reed, whose impressions are clearly preserved.

Two large vats with exceptionally interesting plastic decoration were found, one inverted over the other, in the corner of a room in a small building at Tell Asmar (Pl. 128 *a*). The lower of the two (Pl. 128 *b* and Front. *a-c*) is somewhat smaller than the upper and is broken at the bottom. It is decorated with a series of double corded ridges and in the space between the uppermost ridges and the rim, as well as on the rim itself, with applied snakes, scorpions, turtles, birds, and a quadruped. Four pairs of snakes are approximately equally spaced with their heads over the rim. On the rim itself (Front. *b*) there are five scorpions, two facing each other between two of the pairs of snakes and one in each of the three remaining spaces, each close to a snake's head.¹⁹⁵ It is possible that some of the original applied decoration on the register below the rim has peeled off. The surface of the upper vessel (Pl. 129 and Front. *d-g*) is divided into two registers by a single thick corded ridge, and plastic decoration was applied in both registers. In the upper one (Front. *f*) it consists of four human masks suspended from a double corded ridge below the rim and snakes, scorpions, and a small quadruped (wild ass?) applied over the corded ridge itself. It is interesting to note that at least in one spot there is a rough incised outline of a mask, apparently as a guide for the modeler (Pl. 129 *d*, lower right). The lower register (Front. *g*) contains three human figures faced by a lion. Two of them are naked except for girdles. Each of the two holds a weapon in his right hand and is being attacked by a snake (Pl. 129 *a*). The third person (Pl. 129 *d*) wears a short skirt and is portrayed in a pray-

¹⁹² For purposes of notation such "buttresses" or "columns" are classified as lugs (see forms A.556.423 and C.405.363).

¹⁹³ It is of interest to note that similar "columns" occur on Egyptian pottery vessels which seem to date from the First Intermediate period or the early Middle Kingdom; see e.g. Petrie, *Diospolis Parva* (London, 1901) Pl. XXXIV 36, and J. E. Quibell, *El Kab* (London, 1898) Pls. XIV 1-2, 4 and XVI 53, 70.

¹⁹⁴ See Genouillac, *Telloh I*, Pl. 60:5 = Pl. XIII 4024; Genouillac, *Fouilles françaises d'el-Akhymér . . . II* (Paris, 1935) Pl. 57:6; *Kish IV* 16 (jars with "creased collars") and Pl. II AN; *Mém. XIII*, Pl. XXV 3, 8; Starr, *Nuzi II*, Pl. 57 C.

¹⁹⁵ See Starr, *Nuzi II*, Pl. 60, for representations of snakes and scorpions on sherds found at Nuzi.

ing attitude. The fact that the figures were upside down when the vat was inverted as a cover indicates perhaps that it was not originally intended for this use.

It must be assumed that this plastic decoration had some ritual significance, especially since the building in which the vats were found is a shrine. Moreover, the hole in the base of the vat which was used as a cover and some bird (?) bones found in the lower vat tempt one to assume that live snakes were kept in this contrivance. These circumstances led us to name the shrine in which it was found the "Snake Shrine."¹⁹⁶ It should be remembered that snakes in relief were very common in pottery decoration and that spouts so decorated occurred in nearly all periods represented in our excavations (see pp. 92 f.).

In connection with these ritual vessels it may be mentioned that theriomorphic jars in the form of rams (C.96), such as were rather common in ED III (see pp. 93-94), were apparently still in use, for at least one ram's-head spout (As.31:376 *a*) was found. Two ram's-head spouts (Pl. 94 *d, g*), one of which is different from the others in that it is decorated with impressed circles (cf. Pl. 126 *e*), were found on the surface at Tell Asmar and Tell Agrab respectively and may belong to the Larsa period.

Crude lids consisting of rough disks pinched at the top to provide a fingerhold (Pl. 130 *a-b*) were sometimes partially baked and sometimes unbaked. As we have seen (p. 104), exactly similar lids occurred earlier. Plate 130 *c-c'* show a rectangular bricklike object with a pinched fingerhold (*c*) like that of the lids just described. Another such object (As. 31:379 *b*) was found at Tell Asmar in O 30:10. Their use was uncertain until we noticed on the lower surface (*c'*) of each a round patch where the clay had been vitrified by intense heat. This detail indicates that they served to cover the unused flues in ovens or kilns.¹⁹⁷ Characteristic objects (B.852) formed of two rounded bowl-like parts and reinforced at the join with spikelike projections were usually decorated with simple incised lines and perforated at top and bottom (Pl. 130 *d-f*). Nearly all of them contain loose bits of hard clay or small pebbles which rattle when the object is shaken. Consequently these objects are usually interpreted as toy rattles. However, the possibility that they served occasionally some practical purpose cannot be excluded. For instance, they could have served as lids.

The Larsa remains produced a few complete (e.g. Pl. 130 *h*) and many fragmentary lamps of a type which first appeared in Late Gutian or Ur III times (see p. 114). A purchased specimen (Pl. 130 *i*) probably from Khafajah may have come from somewhat later remains. As we have mentioned, such lamps continue in use throughout many subsequent centuries of Mesopotamian history without very noticeable change.

In conclusion we may mention some clay tools from Tell Asmar which were likely used in pottery-making. Top and profile views of some complete specimens are shown in Plate 131. A roughly modeled crescent-shaped object (*a*), flat on one surface and rounded on the other, is somewhat different from the rest, which are variations of a single type. The object consists of a slightly curved oblong bar rounded at both ends, one of which is sharpened to a chisel-like edge. Two specimens (*b, d*) have holes drilled through them, apparently for suspension. These would be extremely handy tools for smoothing the surface of a vessel or for the finer modeling required by such features as rims and ridges (as e.g. in Pl. 121 *b*). It is impossible to say without microscopic examination whether all these tools were especially made or whether some of them are simply potsherds ground down to the desired shape.

THE OLD BABYLONIAN PERIOD

By this name we refer to the period after about the thirtieth year of Hammurabi's reign, when Babylon was gaining supremacy in southern Mesopotamia. Thus, as previously men-

¹⁹⁶ See *ILN*, Sept. 5, 1936, pp. 389-91. To be discussed in *Old Babylonian Public Buildings in the Diyala Region*.

¹⁹⁷ A kiln with round flues, some of them covered with irregular lumps of clay, was found in the Ilushulia level in the Palace of the Rulers at Tell Asmar (see *Gimilsin Temple*, p. 9 and Fig. 2).

tioned (p. 114), the earlier part of the first dynasty of Babylon coincides with what we have termed "Late Larsa."

Ruins of the period under consideration were found in our excavations only in the uppermost strata at Ishchali and in Mounds B and C at Khafajah. At Khafajah a large building, the plan of which was traced during our last season of excavation, under the auspices of the University Museum, Philadelphia, and the American Schools of Oriental Research, is identified by an inscribed clay cylinder as Dur Samsuiluna, a fort built by Samsuiluna the son of Hammurabi.¹⁹⁸ Unfortunately, at both Ishchali and Khafajah excavations were interrupted shortly after work on these comparatively late remains had begun. As a result we are able to record only a very small number of complete pottery vessels of this period. However, numerous sherds, though inadequate for restoration of complete shapes, clearly indicate that the whole specimens which we were able to record and reproduce represent but a fraction of the pottery assemblage of the period.

Bowl-shape B.031.200 may have survived from earlier times. Although no complete bowls were recovered, the sherds indicate that such types as B.151.210 and possibly C.111.310 continued in use. A small tripod dish with plastic decoration inside (B.041.900) is unusual but may reflect the tradition of earlier bowls such as that shown in Plate 106 *a*. Form B.546.240 possibly survives, while a taller form (B.647.240) is new but may be of Late Larsa date. A bottle with low center of gravity (B.766.320*b*) is possibly also of Old Babylonian date.

The vessels most characteristic of this period are thin-walled cups. They usually have a small foot and a well defined, flaring, rimless neck, while the shape of the body itself varies somewhat. In spite of their extreme fragility we were fortunate enough to find several unbroken specimens, four of which are shown in Plate 132 *a* and *c-e*. Other forms include B.556.720, comparable with *c* but with a shorter and less flaring neck, and B.547.320, taller than both and with a ring base. The latter, though its walls are much thinner, may be compared with B.527.340, which occurred in Agade and Early Larsa times. Form B.757.320 has a wide ring base and its maximum diameter is well below the middle. Several base fragments suggest that near-cylindrical cups with slightly concave walls such as were characteristic of the Larsa period (e.g. B.236.200*a-c*, B.236.300) continue in use. Two complete cups (B.236.200*a-b*) may belong to the Old Babylonian period.

Of the larger utensils, a wide-mouthed jar with a stump base (C.176.720) is from either the Late Larsa or the Old Babylonian period and may be compared with C.175.720 of the Late Larsa period. A wide-mouthed squat pot with a carinated body and a ring base (C.493.360) possibly belongs to the Old Babylonian period, though its provenience is uncertain. A tall form with a stump base and a well defined neck (C.547.720) which appeared in the Larsa period survives. A complete medium-sized jar is shown in Plate 132 *b*. It is of the same general shape as some of the cups (cf. Pl. 132 *a, c*), though it has a proportionally wider base and a shorter neck. Other jars of medium size include forms C.606.320, with a ring base and simple decoration of incised lines below the neck, and C.665.740, nearly globular in shape and with a narrow stump base.

A tall cylindrical jar (C.228.340*b*) of either Late Larsa or Old Babylonian date is obviously related to certain tall jars of the Larsa period (e.g. C.228.340*a*). A thin-walled urn with a wide plastic band above the maximum width (C.225.310*b*) seems to represent a popular form, if we judge by the numerous sherds of such vessels. The fragments indicate, moreover, that there were also larger urns with somewhat thicker walls. Not greatly different in general shape from the larger urns were big vats or cisterns occasionally decorated with plain or corded ridges. Most of them seem to have had ring bases. Unfortunately they too are represented

¹⁹⁸ See *ILN*, Dec. 3, 1938, p. 1026. To be discussed in *Old Babylonian Public Buildings in the Diyala Region*.

only by fragments. A rim fragment with an imitation of a metal ring attached to a handle is shown in Plate 126 *i* (see p. 121).

The outstanding characteristic of the pottery of this period, observable in spite of the small quantity, is the comparative thinness of the walls of the vessels. The shapes are on the whole more graceful, and the vessels are usually well fired. There seems little doubt that this is one of the periods in Mesopotamian history in which the potter's craft regained a high degree of perfection. The comparatively scanty material at our disposal from other Babylonian sites gives the impression that after this period a decline in this craft set in. However, some of the shapes introduced in the Old Babylonian period influenced the character of Mesopotamian pottery for many centuries to come. But since no later material derived from our own excavations, we must exclude any discussion of these later developments from this book.

III

COMPARISONS AND CONCLUSIONS

OWING to the considerable bulk of our pottery and the fact that it represents a long range of time, it seemed best to separate the comparative and interpretative part of this volume from the documentary. The diversity of our material precludes a uniform character of interpretation. In some cases "interpretation" means merely an attempt to formulate our observations in a more generalized manner by utilizing not only the verbal and graphic records which appear in the documentary part but also the accumulation of impressions gained in the field while we were discovering the material in its complex archeological contexts. In other cases we are concerned chiefly with comparisons with material from other sites or regions. Often the conclusions to be drawn from such generalizations or comparisons are of rather limited interest, but in some cases they bear directly on more general problems such as definition of and distinction between cultural periods, cultural intercourse between various regions, and relative dating of archeological remains.

It goes without saying that from the point of view of the more significant conclusions, various groups of pottery are not of equal value. Thus, while certain types, or even single specimens, have to be discussed in detail, others may require no mention. The latter is true especially of the pottery of the historical periods, when written documents provide direct chronological and cultural evidence of a precision far beyond that which can be obtained from the study of any single group of material remains.

The interpretations which we offer in any category are by no means exhaustive. Some seemed so obvious that they needed no specific statement; others would involve an examination of evidence extraneous to the subject of this volume; and finally, there is all likelihood that some have been simply overlooked.

In the comments on our pottery it seemed best to follow as closely as possible the general chronological order in which it is presented in chapter ii.

THE PROTOLITERATE PERIOD

DIYALA POTTERY

The earliest pottery found in proper archeological context in the Diyala region is of the Protoliterate period. However, a few sherds of Ubaid painted ware and a certain amount of red- and gray-slipped, sometimes burnished, pottery (Warka wares) indicate that earlier settlements existed at or in the vicinity of our sites (see p. 29).

As a rule, the smaller vessels of the Protoliterate period are made of fine buff or cream paste. Gray fabrics occur but are comparatively rare. The larger vessels are usually of less well levigated paste, sometimes gritty and sometimes showing traces of vegetable *dégraissant*. The most porous and friable fabrics are to be found among the large vessels or in specialized utensils such as rough handmade bowls with beveled rims (see p. 39).

The majority of the Protoliterate pottery is undecorated, but simple incised or scored decoration is quite common. Reserved-slip decoration was occasionally employed (see Pls. 17 *l* and 19 *b-c*). However, the outstanding characteristic of the pottery of the Protoliterate period is the presence in fair proportions of monochrome- and polychrome-painted wares. These are in-

deed the most significant from the point of view of general conclusions regarding the subdivision of the period into phases and cultural intercourse between different sites and regions. However, before discussing the painted wares, it may be well to summarize some of our observations regarding the forms of the Protoliterate pottery. First one may notice the popularity of four-lugged vessels and spouted jars. On the whole the spouts are conical (e.g. Pl. 17 *f*) and none are very long. But some show a marked curvature (Pl. 17 *e*). It would seem that the earliest specimens represent a phase in which very long spouts on the one hand and curved ones on the other begin to go out of fashion.¹ Four-lugged as well as spouted vessels are marked by the absence of ring bases throughout the levels dated to Protoliterate *c*. While the four-lugged vessels of this phase usually have carinated bodies, the spouted jars are, as a rule, rounded. However, toward the end of the period carinated spouted vessels occur occasionally (see Pl. 19 *i*). At this time the carinations are very rarely accentuated by ridges such as become common in ED I (e.g. Pl. 41 *a, c*).

It is interesting to observe that there seems to be a tendency to combine certain types of fabric, form, and decoration. Thus, for instance, round-bottomed handled pitchers (Pl. 20 *a-b*) and cups, which are fairly well represented at other sites,² seem often to be made of a gritty greenish fabric and decorated with roughly incised lines or crosshatched bands around the shoulder. On the other hand, elongated slipped or polychrome-painted and sometimes burnished vessels (e.g. Pl. 18 *a-b, f*) are frequently made of brown gritty paste. Another outstanding combination is the characteristic shape of the rough beveled-rim bowls and a peculiar porous fabric (see pp. 127-28).

The stratigraphic evidence of our excavations indicates that at least two phases should be distinguished in the polychrome pottery of the Protoliterate period. In the earlier, polychrome decoration is associated chiefly with relatively small elongated vessels with narrow flat or rounded bases (e.g. Pl. 1). The red paint employed is usually of a dark purplish hue, and the surface of the vessels is often burnished. In the second phase, a greater proportion of the polychrome vessels are fairly large, and rounded or ovoid forms gain predominance. The red paint is as a rule of somewhat brighter hues, and the surface of the vessels is rarely burnished (e.g. Pls. 5-7 and 8, Kh. IX 101). Another characteristic feature of the second phase is the presence of four unpierced knobs or studs on the shoulder. They usually project from a raised ridge but sometimes are connected by an incised groove. In the second phase too ring bases become common on both painted and unpainted wares.

The distinction between earlier and later polychrome wares is of considerable value for the subdivision of the second half of the Protoliterate period (which roughly corresponds to the so-called "Jamdat Nasr" period) into two distinct phases (which we have called *c* and *d*) and offers a basis for a more precise dating of certain finds from other sites.

The exact archeological context of the first appearance of polychrome pottery in Mesopotamia is still somewhat uncertain, for in the Diyala region we have not yet reached the levels in which such pottery first appears, and the material from other stratified excavations is too scanty to allow precise evidence in this respect. On the other hand, we have obtained a clear picture of the development of the late polychrome ware of the Protoliterate period into the so-called "scarlet ware" of ED I (see pp. 60 ff. and 136).

The monochrome-painted pottery as a whole shows less distinctive differences between phases *c* and *d* of the Protoliterate period. However, this may be due to the comparative scarcity of stratified material. But if the combinations of shape and design are taken into consideration certain changes may be perceived. In the earlier monochrome-painted pottery the

¹ Cf. UVB IV, Pl. 18 D.

² E.g. Jamdat Nasr (Mackay, *Jemdet Nasr*, p. 243); al-*c*Ubaid (*UE I*, Pls. XX 1453 and LII xvi); Susa (*Mém.* XXV 197, Fig. 33); Telloh (Genouillac, *Telloh I*, Pl. 23:1).

decoration is usually confined to four-lugged carinated jars (Pl. 28). The paint employed is purplish or brownish black, brown, or plum-red, and the designs include both geometric and representational motifs. Spouted jars are but rarely painted, and their decoration usually consists of simple painted bands (e.g. Pl. 19 *h*). Toward the end of the Protoliterate period monochrome decoration on spouted jars becomes more popular, and the jars themselves reach considerable proportions (e.g. Pls. 30–31). All the previously mentioned colors of paint are used, but red, rather thinly applied, is particularly in favor and its use in monochrome decoration seems to have survived into Early Dynastic times (see p. 72). Monochrome-painted pottery decorated with red bands is indeed typical enough to have served as the basis for a stratigraphic term in the excavations at Ur.³

Some observations which apply to both polychrome- and monochrome-painted wares are worth noting because they are of some value in our discussion of the origin and foreign relations of painted wares of the Protoliterate period. First it may be noted that in nearly all cases the actual design is confined to the shoulder of the vessel or, to be more precise, to the surface above the maximum width.⁴ In the very few cases where the design extends a little below the maximum diameter it is clearly a continuation of the main design (e.g. Pl. 18 *d* = Pl. 133 *b*). This may indicate that the painting was meant to be seen from above. Another observation is that, though many of the painted vessels have a definite carination between body and shoulder, in the Protoliterate period the carination is rarely emphasized by a plastic ridge while in Early Dynastic times such plastic ridges become quite common. These observations hold good, as far as I can see, not only for our own material but also for that from other Mesopotamian sites.

SOME RELATED POTTERY FROM OUTSIDE THE DIYALA REGION IN SOUTHERN MESOPOTAMIA

If there were still any need to demonstrate that simple shapes and technically poor wares are not in themselves indications of lack of archeological significance, the crude bowls with beveled rims described on page 39 could be cited as a good example. For a priori one would be justified in thinking that such simple utensils could be made independently in almost any region and period. Yet, though this type of bowl occurs in a very wide area—from Eridu in the south of Mesopotamia to Nineveh in the north and from Susa in Elam to Hamah near the Mediterranean⁵—its occurrence is limited to a definite and relatively short period of time. This can hardly be mere coincidence. One should note, moreover, that nowhere are these bowls representative of the potter's skill attained at the time, for they occur in strata where wheel-turned, well fired, and often attractively decorated pottery is predominant. In other words, they belong to a time and to regions in which pottery-making reached a high degree of perfection. The generally accepted explanation of this apparent anomaly is that these utensils were "votive" bowls rather than household vessels intended for practical use.⁶ If this view

³ I.e., "the period of pink pottery with red bands"; see *AJ* X 339.

⁴ This definition applies to vessels from Jamdat Nasr (Mackay, *Jemdet Nasr*, Pl. LXXVIII 2) and Tell 'Uqair (*JNES* II, Pl. XXVII 4) which have no proper "shoulder."

⁵ For more specific references to sites where such bowls have been found see form C.002.210 in the catalogue of pottery forms.

⁶ This is the view maintained by Dr. R. Campbell Thompson's three successive assistants at Nineveh, where large numbers of such bowls were found (R. W. Hutchinson in *AAA* XVIII [1931] 104; R. W. Hamilton in *AAA* XIX [1932] 88 f.; M. E. L. Mallowan in *AAA* XX [1933] 168). The argument is founded on the observation that at Nineveh most of these bowls were found upside down in the vicinity of what might have been a temple and on analogy with similarly placed incantation bowls at Nippur. The analogy is not very pertinent, first because of the enormous difference in date and second because of the very exceptional character of inscribed incantation bowls. Moreover, no ritual significance need be ascribed to the fact that the beveled-rim bowls are often found upside down. This is true largely of complete specimens, and the explanation might be that owing to their extreme fragility only those bowls which happened to be overturned, thus forming miniature domes, had a chance to withstand the pressure of the debris above them without being thoroughly crushed. (Cf. photograph of such bowls *in situ* at Telloh [Genouillac, *Telloh* I, Pl. 3:3].)

were correct, one might expect to find such bowls always within or near contemporary sacred buildings, if they were dedicated to deities, or within graves, if they were dedicated to the dead. This is manifestly not the case, since at Khafajah we found none within the Sin Temple, while they were fairly common outside it. There is, then, lack of conclusive evidence that they were votive objects. The fact that they were made by hand from a paste of special composition at a time when the wheel was in common use and ordinary household bowls could be manufactured from a standard paste in great numbers and more efficiently suggests not that they were products of third-rate quality but that they were so made intentionally for a good reason. Their outstanding quality is their porosity, and it was probably to obtain this that they had to be fashioned by hand from a soft semiliquid paste, which could not be worked on the wheel. One may assume that the porosity was desired for a specific practical purpose. In modern Mesopotamia muddy water from rivers and canals is cooled and filtered through large pottery jars of not much different fabric. Although the bowls under discussion are obviously too small for filtering water in any useful quantities, they may have been used in processes of food preparation such, for example, as the separation of whey from curds. Their porosity, shape, and size would have been well suited for this purpose. Some such use would account more satisfactorily for their dissemination over so wide an area at a definite period, for this would be more likely to happen in the case of a specialized utensil well adapted to a definite utilitarian purpose than in the case of cheap products of third-rate quality. That the bowls in question went out of use everywhere at approximately the same time⁷ may indicate that they were replaced by a new type of utensil serving better the purpose for which these bowls were originally manufactured.

The beveled-rim bowls are rather exceptional in that they occur in various pottery assemblages over a widespread area. On the whole the pottery assemblages of the Protoliterate period which coincide best with our own from the Diyala region are to be found at sites nearest to our region in the south, that is, Jamdat Nasr, Kish, and the more recently excavated Tell 'Uqair.

On the basis of a general comparison of shapes⁸ and the distinction between the earlier and the later polychrome decoration which we have established, it appears that the site of Jamdat Nasr itself contained on the whole pottery which we would attribute to the last two phases of the Protoliterate period (*c* and *d*),⁹ and the majority would seem to be of the later phase. On the other hand, some of the polychrome sherds from the archaic strata at Warka¹⁰ probably represent an earlier stage of polychrome pottery than the earliest found in our own excavations.

Of the published material from Kish the little that is available for comparison seems to indicate that at least the two last phases of the Protoliterate period are well represented.

Tell 'Uqair,¹¹ the third site and the one most recently excavated in Iraq, produced a con-

⁷ Nuzi apparently provides an exception, for there a complete crude bowl and many fragments of the same kind of ware were found together with a tablet "identical in form, script and language with those from Pavements V and IV" [Akkadian?] (see Star, *Nuzi* I 20 and II, Pl. 50 B).

⁸ Specific comparisons are given in the catalogue: Protoliterate *c*: A.604.223, A.633.263, B.003.2006, B.041.500, B.513.170, B.533.262, C.002.210, C.041.500, C.200.210, C.413.253a-b, C.414.253, C.515.265, C.535.242, C.536.270, C.603.253a-b, C.603.270, C.702.253, D.545.626; Protoliterate *d*: B.454.270, B.757.605, C.412.253, C.534.240, C.603.253, C.603.340, C.604.370, C.605.340, C.802.200, C.806.610.

⁹ It may be of interest to note that D. B. Harden in "A typological examination of Sumerian pottery from Jamdat Nasr and Kish" (*Iraq* I 30-44) also concluded that the pottery from Jamdat Nasr is not a homogeneous group. However, while in general terms this view is correct, the more specific conclusions at which he arrived on the basis of his typological study of museum specimens have nothing in common with our own conclusions and are not substantiated by stratigraphic evidence. This is yet another example of how certain criteria which may seem relevant in a typological study of museum specimens do not necessarily reflect any real historical sequence.

¹⁰ *UVB* V (1934) 16.

¹¹ See *JNES* II 132-58.

siderable amount of painted pottery of the Protoliterate period. The polychrome pottery is clearly of the late variety. As it happened, this pottery came from a single deposit rather than from stratified buildings, and it can be assumed that all the specimens in it are of the same date. It provides some interesting evidence regarding changes in shape of four-lugged jars within the Protoliterate period. For it contained four-lugged monochrome-painted jars which differ considerably in shape from previously known specimens and show some features of ED I pottery. On the whole the contours are less well defined and in some cases the typical carinations of the body have disappeared.¹² A few jars approach the so-called "bag" shape.¹³ On some specimens a notched ridge appears at the height of the lugs. This forms a gutter into which an especially made lid would fit very conveniently. Indeed, some jars were found with lids in position. Such a gutter is quite typical of plain four-lugged jars of ED I, and we have an additional indication that these 'Uqair vessels and the deposit in which they were found date from the last phase of the Protoliterate period. It is interesting to note that the development of the form of the four-lugged jars from carinated to rounded is in an opposite direction from that of the spouted jars.

Farah produced a certain amount of both plain and painted pottery comparable with some of our pottery of phases *c* and *d*.¹⁴

At Nippur apparently some sherds of polychrome pottery were found¹⁵ but none were preserved or adequately described.

Warka, farther to the south, where excavations have been carried on for a considerable number of years, produced pottery not only contemporary with the earliest in the Diyala region but extending back through the earlier phases of the Protoliterate period to the Warka and 'Ubaid periods. Unfortunately the phases which would be the most interesting for comparison with our own material, namely Protoliterate *c* and *d*, are not as well represented at Warka as the earlier phases, from which magnificent building remains were preserved. Polychrome pottery, though undoubtedly present,¹⁶ was not found in sufficient quantity to allow any useful comparisons, let alone general conclusions.

At Telloh the only stratigraphic presentation of material is unfortunately largely influenced by preconceived ideas and is, moreover, entirely oblivious of any architectural remains with which the finds may have been connected. All one can do, then, is merely to keep in mind that certain shapes and features known from our excavations¹⁷ are present there.

It is worth noting that the comparative scarcity of painted pottery of the Protoliterate period from the excavations of Warka and Telloh may be due to coincidence; it does not prove that painted pottery was little used in southern Babylonia and does not justify any conclusions which could be based on such an assumption. In this connection one may remember that even farther to the south, at Ur, painted pottery was not uncommon, according to preliminary reports.¹⁸ Most of the Protoliterate pottery at that site seems to come from burials earlier than the Royal Cemetery, and apparently no great amount of material of this period has been found in the two sounding pits. Moreover, as we shall see below, part of the so-called "Jamdat Nasr" cemetery at Ur contains material which is demonstrably of Early Dynastic age and thus

¹² See e.g. *ibid.* Pl. XXVII 2.

¹³ See e.g. *ibid.* Pl. XXVII 4.

¹⁴ Protoliterate *c*: B.003.200b, B.513.170, C.413.253b, C.603.270; Protoliterate *d*: D.515.370.

¹⁵ See John Punnett Peters, *Nippur, or Explorations and Adventures on the Euphrates*. II. *Second Campaign* (New York and London, 1897) p. 396.

¹⁶ UVB V 15 f. and Pls. 14 *c* and 15 *e-f*.

¹⁷ Protoliterate *c*: A.604.223, B.041.500, B.703.240, C.002.210, C.041.500, C.534.222, D.545.626; Protoliterate *d*: C.534.222, C.654.222, C.96.

¹⁸ See Frankfort, "Some notes on pottery from Ur," *AJ* IX (1929) 344-48, and Woolley in "Excavations at Ur 1933-4," *AJ* XIV (1934) 371 f.

in the final analysis the scope of the Protoliterate remains at Ur may be somewhat reduced. However, to gain a clear picture of the Protoliterate material from that important site one must await final publication of the volume in the series on Ur excavations which will deal with the "archaic periods."

From al-'Ubaid only one monochrome-painted sherd typical of the Protoliterate period has been published,¹⁹ while the occurrence of a few polychrome sherds is mentioned.²⁰ These sherds were considered either contemporary with the monochrome al-'Ubaid ware or "Sumerian," that is, of the same date as the temple platform. However, numerous clay cones, a cylinder seal, and a small painted brick which we found during a short investigation of the site²¹ indicate that a settlement must have existed there during the Protoliterate period. A comparison of pottery shapes will show that several Diyala shapes found in either Protoliterate or ED I levels²² are present at al-'Ubaid. Indeed, it is the writer's opinion that the 'Ubaid period at al-'Ubaid is represented chiefly by surface finds and two, or possibly three, of the burials, while the other burials and pottery are of Protoliterate and Early Dynastic date.

ORIGIN OF SOME CHARACTERISTIC PROTOLITERATE WARES POLYCHROME POTTERY

When the first large collection of painted pottery was discovered at Jamdat Nasr²³ it seemed natural to the excavators to connect it with the previously well known finds of the French excavators in Iran, especially those from the Musyan region.²⁴ Moreover, since there existed a tendency to lump together the polychrome pottery from Musyan with the bulk of the so-called "Susa II" style of pottery²⁵ and since cylinder seals, archaic scripts, and presumably related numerical systems were used in Mesopotamia and in Elam, some scholars concluded not only that this Mesopotamian polychrome pottery had its origin in Elam but indeed "that Sumerian civilisation entered the Mesopotamian Valley from Elam in this area, and then spread southward to the shore of the Persian Gulf."²⁶ The theory which sees the origin of the Jamdat Nasr painted pottery in Elam was not shared by most archeologists. Indeed, even before the discoveries at Jamdat Nasr were made and while the *lack* of polychrome pottery was still considered one of the characteristic features of Mesopotamian culture,²⁷ a theory was put forward which would derive the then known polychrome pottery in Elam itself from North Syria.²⁸ After the discovery of painted pottery at Jamdat Nasr and other sites this theory was extended to include the polychrome pottery of southern Mesopotamia. The occurrence of polychrome pottery was, in fact, considered a proof of Semitization of this region.²⁹ The view ac-

¹⁹ *UE*, I, Pl. XII 11.

²⁰ *Ibid.* p. 168.

²¹ See *Iraq* V (1938) 6 f.

²² Protoliterate c: B.003.200b, B.603.240, C.041.500, C.535.242, C.536.270, D.545.626; ED I: B.003.200b, B.076.700, B.077.700a, B.514.270, C.514.362, C.525.262b, C.525.370a, C.526.262b, C.526.362b, C.556.242, C.605.240.

Moreover some of the sherds shown among the pottery of the 'Ubaid period (see *UE* I, Pl. XX) have close parallels in our pottery.

²³ The existence of painted pottery in southern Mesopotamia was known from the excavations at Farah in 1902/03 and was noted by Frankfort (*Studies* I 59) even before the final publication of that site appeared in 1931.

²⁴ Mackay, *Jemdet Nasr*, pp. 227 f. and 287.

²⁵ Although already in 1924 Frankfort in his *Studies* distinguished between the "Poteries des Sépultures" in Musyan and the polychrome jars from Susa on the one hand and the monochrome-painted pottery of Susa on the other (*Studies* I 50).

²⁶ See e.g. S. Langdon, *Pictographic Inscriptions from Jemdet Nasr* ("Oxford Editions of Cuneiform Texts" VII [Oxford, 1928] p. VI).

²⁷ See e.g. Frankfort, *Studies* I 69 and 73.

²⁸ *Ibid.* pp. 70 and 75.

²⁹ See Frankfort, "Sumerians, Semites, and the origin of copper-working," *AJ* VIII, especially pp. 227 f.

ording to which polychrome pottery spread into Mesopotamia and Elam from North Syria is largely based on considerably later material from Palestine, Cyprus, Egypt, and Cappadocia which suggested that earlier material may be found in the center of these regions, namely in North Syria.³⁰ Since further research did not produce conclusive evidence to substantiate it, this theory was gradually abandoned by its author.³¹ Nevertheless it is still favored by some prominent scholars even if they have to resort to the hypothesis that "some of the motives might have been borrowed from the Semites—not, indeed, from their ceramic art, but from textiles or basketry"³² (of which no traces are extant), or to surmise that the Jamdat Nasr polychrome ware might be a descendant of the Halaf ware of North Syria³³ without explaining the absence of such a descendant in North Syria itself or in any of the surrounding regions and without accounting for the considerable gap of time between them. If a few years ago, when very little was known about North Syria in the period in question, one could still reasonably expect that evidence supporting this view would be forthcoming, this is no longer the case. Recent excavations, especially those of the Syrian Expedition of the Oriental Institute, which brought to light sufficient material to establish a coherent picture of the development of the material culture of the region from earliest³⁴ to late historic times, did not produce any such evidence. Even the site of Tell Brak, which in certain respects shows extraordinary affinities with the material culture of southern Mesopotamia,³⁵ including common pottery shapes, did not produce any polychrome pottery in the context in which it should have occurred if North Syria were indeed the center from which polychrome pottery reached southern Mesopotamia.

For the sake of completeness one should mention yet another theory, put forward by Sir Leonard Woolley, which would see the origin of the Jamdat Nasr polychrome ware somewhere in northern Elam.³⁶

Of the various regions thus advocated as originators of the polychrome pottery under consideration, only Elam produced a semblance of ceramic connections, for, as we have seen, polychrome pottery was found at Susa as well as at Musyan. However, a critical examination of the published sherds from these sites shows that only two are definitely related to Mesopotamian polychrome pottery³⁷ and they are of the late rather than the early polychrome ware of the Protoliterate period. This indicates, in the writer's opinion, that these sherds are probably importations from Mesopotamia, counterbalancing, as it were, a few clearly Elamite

³⁰ *Ibid.* pp. 224 f.

³¹ See e.g. Frankfort, *Archeology and the Sumerian Problem* (SAOC No. 4 [1932]) p. 50.

³² V. Gordon Childe, *New Light on the Most Ancient East* (London, 1935) p. 166. The same idea is accepted by Seton Lloyd (*Mesopotamia* [London, 1936] p. 71).

³³ Childe, *loc. cit.*

³⁴ See *OIP* LXI.

³⁵ See *ILN*, Jan. 15, 1938; Oct. 15, 1938; Oct. 22, 1938; and May 20, 1939; *British Museum Quarterly* XIII (1939) 99–101.

³⁶ Woolley, *The Development of Sumerian Art*, pp. 52 f. After pointing out the geographical characteristics of "Elam, the modern Persia," due to which "each community must have developed along more or less independent lines," so that "it would be wrong to expect the pottery, for instance, of northern Elam to be identical with that of Susa even though its relation to Susa would be obvious," Woolley brings forth his main argument, namely: "Since neither Sumer's northern neighbour, Anatolia, nor the north-west, Syria, can furnish any parallel to the Jamdat Nasr pottery it is necessary to look for such to the east or north-east, and since Susa, to the east, offers at once resemblances and differences, only the north-east remains, and if northern Elam be taken as the home of the Jamdat Nasr invaders the character of the only art product by which we can identify them is satisfactorily explained." It may be pointed out that excavations of sites north of Susa, especially Tepe Giyan (see *Tépé-Giyan*), did not produce any evidence which even remotely supports this theory.

³⁷ *Mém.* XIII, Fig. 136 and Pl. XXV 4. The first of these two sherds has been compared with one from Tell Ta'annek (Ernst Sellin, *Eine Nachlese auf dem Tell Ta'annek in Palästina* K. Akademie der Wissenschaften in Wien. Philos.-hist. Klasse. "Denkschriften" LII, Abh. III [Wien, 1905] Fig. 23) as an argument in favor of the North Syrian origin of the polychrome pottery of Elam (see Frankfort, *Studies* I 69 f.).

painted vessels which were found at various Mesopotamian sites.³⁸ This implies only that there was cultural intercourse between the two neighboring regions but has little bearing on the history of the development of the typically Mesopotamian pottery or on its origin.

Since in spite of the great increase of archeological material from all the regions concerned within the last few years no polychrome pottery comparable with that under discussion was found to be typical of any region outside Mesopotamia, the simplest conclusion appears to be that Mesopotamian polychrome pottery is a local product which apparently influenced some of the neighboring provinces more than Mesopotamia was influenced by them. This conclusion is entirely in keeping with our new concept of the cultural achievements of the Protoliterate period as a whole. The only objection to it, as far as I can see, is the deep-rooted idea that since the *earliest* painted pottery in South Mesopotamia (i.e., 'Ubaid pottery) is demonstrably not indigenous but a comparatively late offshoot of a widespread prehistoric culture, all other painted wares in the same region had to originate from the outside.

MONOCHROME-PAINTED POTTERY

The monochrome-painted pottery of the Protoliterate period on the whole attracted less attention than its more conspicuous polychrome contemporary. Usually it is considered closely related to, if not a variety of, the latter. Indeed there are many designs, especially of the geometric variety, which are common to both. Some scholars, however, attribute different origins to the polychrome- and monochrome-painted wares. Thus, for instance, Frankfort suggested "that certain vessels found at Jamdat Nasr, which are decorated in black paint on pale buff ground, and have the shape of the small four-lugged pot of the highland, [i.e., 'Ubaid] culture, are indeed late survivals of that culture."³⁹ This theory would apply then to vessels such as those illustrated in our Plate 28, especially *c*. While there is no doubt that certain characteristics of shape and accessories as well as certain elements of design found in Protoliterate pottery can be traced in 'Ubaid pottery (i.e., "highland wares"), there are others which are entirely new. Moreover, some of the new features occur on specimens which by their decoration would be considered as pottery of the "lowland culture."

Another theory, advanced by Sir Leonard Woolley, would derive the red monochrome-painted pottery from North Syria.⁴⁰ In support of this theory he compares two pots, one from Ur and one from Carchemish,⁴¹ both decorated with linear designs in red paint. The vessel from Ur is of a well known shape, similar to that of our Plate 19 *d*, and has a design of concentric loops (or festoons) similar to those of our Plate 134 *e* and multiple lines. On the basis of the shape alone I would be inclined to date this vessel to Protoliterate *c*; but the concentric-loop motif is more common in Protoliterate *d* and continues into ED I on scarlet ware (see e.g. Pl. 137 *c*). The Carchemish vessel, on the other hand, is partially broken and of not too distinct a form. The only similarity in the decoration of the two vessels is that both bear linear designs in red paint. As to the character of the designs, one notes at once on the Carchemish

³⁸ One such vessel was found at Telloh as early as 1909 (Cros, *Tello*, Fig. 20). Two other vessels, of similar type, are published from Ur. One is published by Woolley in *UE* II 387 and Pl. 186, in *AJ* IX 308 and Pl. XXII 1, and in *MJ* XX (1929) 8. It may be noted that while in the *AJ* report, Woolley recognizes this pot as "a painted vessel of Susa II type" which "must be an import from the east," in the *MJ* report he considers it to be "of the later Jemdet Nasr type." And this he believes supports his earlier view "that the Jemdet Nasr ware is northern and Akkadian, not Sumerian, and that in the north its manufacture continued until the native Akkadian culture had been swamped by the Sumerian." It is true that this later idea is given up in *UE* II, but strangely enough the confusion reappears in connection with the second vessel of the same type, which is published in *The Development of Sumerian Art*, Pl. 13 *a*, where it is labeled "a Jamdat Nasr pot with bird design," while on p. 52 it is recognized as being "altogether in the 'Susa II' style." Moreover, it is considered as "evidence enough to solve the question" (namely the origin of the Jamdat Nasr polychrome ware).

³⁹ See Frankfort, "Some notes on pottery from Ur," *AJ* IX 345.

⁴⁰ See *The Development of Sumerian Art*, pp. 50-53.

⁴¹ *Ibid.* Pl. 11 *a-b*.

pot the spiral motif, which is quite alien to Mesopotamia in this period. Moreover, even if the resemblance were real, it would be necessary to prove that the Syrian example is the earlier of the two in order to derive the Mesopotamian ware from that of North Syria, but no such proof is given. On the contrary, if we judge by the finds of the Oriental Institute's Syrian Expedition, the type of pottery represented by the pot from Carchemish does not seem to occur before 'Amuq phases I and J,⁴² that is, many centuries later than the occurrence of the Mesopotamian ware which is supposed to have derived from it.

On the basis of the rather limited stratified material at our disposal we would suggest that while some of the features of the monochrome-painted pottery of the Protoliterate period may have derived from earlier monochrome-painted pottery ('Ubaid) and others could be explained by the influence of roughly contemporary pottery in the highlands to the east, most of them seem to represent an autochthonous development closely parallel to that of the polychrome pottery.

A tentative distinction between earlier and later monochrome-painted pottery of the Protoliterate period is suggested on pages 126-27.

POTTERY WITH RESERVED-SLIP DECORATION

Sir Leonard Woolley would derive from North Syria not only the red monochrome-painted pottery of South Mesopotamia, but also the so-called "reserved-slip ware."⁴³ Again an attempt to substantiate the theory is made by comparing two pots, one from Carchemish and the other from Ur.⁴⁴ Apparently "Ur" in this case is to be understood as the region rather than the site itself, for the provenience of the very same pot is given in another publication as the cemetery at al-'Ubaid.⁴⁵ If so, it does no more than illustrate the technique; it does not fit in any way into the actual stratigraphy of Ur. On the basis of our own finds we would date this spouted jar to ED I (cf. e.g. Pl. 39 a). It does not represent the earliest occurrence of reserved slip in southern Mesopotamia; a sherd found below the foundations of Sin Temple I at Khafajah (Pl. 17 l) would indicate the use of this technique early in Protoliterate c. Even if the evidence provided by this sherd could be discounted on the assumption that a single sherd might have penetrated from a higher level by some accident, we still have two well stratified spouted jars (Pl. 19 b-c) to testify to the use of this type of decoration in Protoliterate c, though at a somewhat higher level. In order to derive the reserved-slip technique from North Syria proof is thus needed that it occurs there earlier than Protoliterate c in southern Mesopotamia. This proof is not supplied with Woolley's comparison. Evidence obtained by the Syrian Expedition in the 'Amuq region shows that there the reserved-slip technique occurs in phases G and H in context with other features which are clearly derived from Mesopotamia.⁴⁶ The available evidence would thus point toward the likelihood that the reserved-slip technique was introduced into Syria from Mesopotamia rather than the contrary.

To sum up, we see that none of the typical wares of the Protoliterate period can satisfactorily be derived from any region outside Mesopotamia, and thus the conclusion which we have reached concerning the polychrome pottery seems to apply to the other wares also.

NORTH MESOPOTAMIAN CONNECTIONS

While in general the pottery assemblages in North and South Mesopotamia are quite different at this time, a fair number of closely related pottery types found in both regions prove cultural intercourse between them and can serve as a basis for comparative dating of the archeological remains of the two regions. We may cite some of the parallels from the deep

⁴² For this information I am indebted to Dr. Robert J. Braidwood.

⁴³ Woolley, *The Development of Sumerian Art*, pp. 50 f.

⁴⁴ *UE I*, Pl. LIV.

⁴⁵ *Ibid.* Pl. 11 c-d.

⁴⁶ See *OIP LXI*.

excavations at Nineveh,⁴⁷ since through this site fairly certain relations can be established with other northern sites. In addition to the rough beveled-rim bowls discussed above (pp. 126-27) one may mention conical bowls (see p. 34), which seem to be common in both regions. Open bowls with low center of gravity and rounded bases (e.g. Pl. 23 *d*) seem to be more common in the North and perhaps were borrowed from there by the southern potters. On the other hand, a certain number of other types are undoubtedly of southern origin. Outstanding among these are carinated four-lugged pots with short necks and usually an incised band at the height of the lugs (see pp. 39-41). Close parallels not only for our own specimens but for some found at other southern Mesopotamian sites are fairly common in the North. Handled pitchers and cups, usually with a roughly incised horizontal band on the shoulder (see p. 38), are not very common in either region, and at present it is difficult to speculate as to their origin. Of exceptional interest for comparative dating are spouted jars like those shown in Plate 19 *b-c*, which not only occur in practically identical form in our own excavations and at Nineveh but in both cases have very characteristic reserved-slip decoration.⁴⁸ It would seem from the evidence now available that this type of jar is limited to a rather short span of time and, since it was found in well stratified clear archeological contexts in both regions, it provides fairly precise evidence for relative dating.

EGYPTIAN CONNECTIONS

The problem of cultural relations between Egypt and western Asia has long occupied historians and archeologists of the Near East. Repeated attempts have been made to utilize the ever increasing evidence provided by the pottery from the various regions to ascertain the character of such relations and to fix them in time. Indeed, a critical study of these attempts would be most revealing with regard to the development of Near Eastern archeology since the end of the last century, for it would reflect the prevailing ideas, methods, and attitudes and would throw much light on personalities. However, such a study is obviously outside the scope of the present publication. Some cultural relation between late prehistoric Egypt and contemporary Mesopotamia is by now a well established fact.⁴⁹ Our material adds very few Mesopotamian types to those previously known to occur in Egypt. Spouted jars (e.g. Pl. 19 *d*), spouted bowls (Pl. 20 *c*), and four-lugged jars (Pl. 22 *c*) are all types previously noted in this respect. An additional pertinent link is provided by the "cut ware" stand or brazier shown in Plate 24 *a* and a painted sherd of probably a similar utensil (Pl. 17 *d*). For previously Egyptian stands and braziers of similar types had to be compared with somewhat later specimens in Mesopotamia, especially those from Assur.⁵⁰ The fact that this type of utensil occurs in the Protoliterate period is in keeping with the rest of the evidence. It seems at present that the clearest points of contact as far as material culture is concerned are concentrated in Mesopotamia in the Protoliterate period and in Egypt, according to Dr. Kantor's analysis, in the Gerzean period. Contacts may have continued in Early Dynastic times, though there seems to be no conclusive evidence to this effect. The problem at present seems to be not whether cultural intercourse between Egypt and Mesopotamia took place (this can hardly be any longer doubted), but rather what were the nature, the extent, and the mechanism of this intercourse.

⁴⁷ See references in catalogue of pottery forms under B.556.720, B.663.213, C.002.210, C.084.200a, C.556.242, C.654.242, C.743.510, and D.545.626.

⁴⁸ See AAA XX 167.

⁴⁹ One may cite the recent articles on this subject by Frankfort in the *American Journal of Semitic Languages and Literatures* LVIII (1941) 329-58 and by Helene J. Kantor in *JNES* I (1942) 174-213.

⁵⁰ See e.g. Frankfort, *Studies* I, Fig. 13.

POTTERY TYPES IN PRIMITIVE MESOPOTAMIAN WRITING

An interesting avenue of study which is opened by better acquaintance with the pottery types of the Protoliterate period on the one hand and by the finds of pictographic tablets on the other is the comparison of the pictographic signs which represent vessels with actual pottery specimens. Since some of these early signs survived into cuneiform script, where their syllabic values are known, such a study might have some philological value. From the archeological point of view it is interesting to note, for example, the large variety of spouted vessels represented in pictographic signs, a circumstance which is well in keeping with the fact that a great variety of such vessels were actually in use during the Protoliterate period while they became much less numerous in Early Dynastic and later times. One may point out that while representations of vessels were apparently used to identify the content (e.g. beer, milk, etc.),⁵¹ certain signs distinctly resemble actual pottery types.⁵² Such studies might indeed prove fruitful even for historical periods, for actual archeological finds might elucidate certain text references (see e.g. p. 112). However, again we must limit ourselves to indicating the interesting possibilities that such studies might offer.

EARLY DYNASTIC I

In discussing the evidence provided by the ED I pottery from our excavations in the Diyala region we shall first endeavor to establish what bearing it has on the problem whether the transition from the Protoliterate to the Early Dynastic period was tantamount to a sharp cultural break.⁵³ Next we shall survey the evidence which helps to establish the relative dating of some previously excavated pottery types whose date is uncertain either because they were found in unstratified remains or because their stratification was erroneously interpreted.

CONTINUITY BETWEEN PROTOLITERATE AND EARLY DYNASTIC I POTTERY

Continuity between the Protoliterate and ED I periods is manifested by the pottery both in elements of form and in decoration. This continuity, however, does not mean lack of change. Indeed, one may observe that the levels belonging to Protoliterate *d* contained comparatively few pottery forms, as defined by our system of classification, identical with those produced by ED I levels (see pp. 156-57). However, if instead of single forms we take into consideration groups of related forms on the one hand and significant elements and their characteristic combinations on the other, continuity between the earlier and the later and development of the later from the earlier become apparent in many instances. We may adduce a few specific examples. As we have seen (pp. 34 and 58 f.) open conical bowls were common in Protoliterate times and continued to be used throughout the Early Dynastic period, when they became the most common among ordinary household utensils. While the general type prevailed, a close examination will reveal that on the whole conical bowls of Protoliterate date are somewhat deeper than the later ones. Large, roughly made oval dishes (C.802.200) occur in both Protoliterate *d* and ED I (see p. 39). A clear example of Early Dynastic pottery shapes developing from those of the Protoliterate age is provided by spouted jars. Thus, in the Protoliterate period such jars were more or less rounded except for a late specimen, which has a carination between shoulder and body (Pl. 19 *i*) and is very close to such ED I vessels as those shown in

⁵¹ A. Falkenstein, *Archaische Texte aus Uruk* (Deutsche Forschungsgemeinschaft, Berlin. "Ausgrabungen . . . in Uruk-Warka" II [Leipzig, 1936]) p. 55.

⁵² Cf. e.g. *ibid.* signs 136 with our B.003.200b, 139 with C.536.270, 153 with C.665.222, and 140 with a spouted pot from Farah (*MJ* XXII, Pl. XXV 3).

⁵³ As implied, for instance, by Viktor Christian (*Alttertumskunde des Zweistromlandes I* [Leipzig, 1940] 171-75) and by E. A. Speiser (*MJ* XXIII [1932/33] 266 and 269).

Plates 37 *a-c* and 38 *d*. Again we may notice that, while the general shape remains practically unchanged, some new features appear in the Early Dynastic period, such as a notched ridge around the shoulder and a shallow ring base (Pl. 37 *a-c*), which on the whole help to distinguish between related forms of the two periods. Other examples of the same sort are provided by large, usually painted, vessels with a well defined shoulder and a plastic ridge, with or without knobs, below the neck. Some of these found in ED I levels (Pls. 16, 52 *b-c*, 66 *a*) are obviously related in shape to such large polychrome vases as those shown in Plates 33 and 35 *a* (= Pls. 5-6). But again, in some of the ED I specimens, changes are perceptible. For instance, one may note the disappearance of the knobs from the ridge below the neck (Pl. 52 *b*), the appearance of a plastic rib around the shoulder (in D.525.370), the notching of this rib and the addition of imitation loops (Pl. 66 *a*). Again, although the types characteristic of the Protoliterate and Early Dynastic periods respectively are quite distinct (the difference in decoration is very marked), the derivation of the later from the earlier ones is quite clear.

Four-lugged jars with a gutter below the rim formed by a ridge connecting the lugs are characteristic of ED I and provide another example of development from an earlier type. Apparently not all stages of this development are represented among our finds, but certain monochrome-painted four-lugged jars from Tell 'Uqair⁵⁴ provide, we think, a missing link in this development (see also p. 144). One may note that while some of the four-lugged jars are plain and have the type of pierced beak-lug familiar from the Protoliterate period (see Pl. 22), others are elaborately decorated with incised or gashed patterns, and the shapes of the lugs are transformed in a very distinctive manner (see pp. 53-55). Indeed, at first glance, the four-lugged jars of the final stage of the development, showing new elements typical of ED I, have little in common with those of the Protoliterate period.

Yet another link between the two periods is provided by the discovery in Protoliterate levels of braziers or stands with pierced walls (represented by the painted fragment shown in Pls. 4 [Kh. IX 49] and 17 *d* and the almost complete specimen shown in Pl. 24 *a*), for stands and braziers with cut walls are very common in the Early Dynastic period (see pp. 55-56).

One could cite many other examples, either of general types or of specific forms, of the Early Dynastic period which derived from Protoliterate prototypes. But even the examples cited above should suffice, we think, to indicate that the pottery evidence corroborates that provided by other classes of material remains⁵⁵ in demonstrating that, though in general there is no difficulty in distinguishing between the comparable material from the two periods, the differences are due either to direct development or to accumulated innovations rather than to a cultural break between the two periods.

TYPICAL EARLY DYNASTIC I POTTERY

While there is no sharp break between Protoliterate and Early Dynastic pottery, there are nevertheless distinct assemblages of pottery not only for each of these cultural periods but also for their different subdivisions or phases. Thus the typical pottery assemblage of ED I includes, in addition to the types just mentioned, a certain number of others which we shall now briefly recall. Among the small utensils slender, solid-foot goblets (see Pl. 46), presumably used for both ritual and household purposes, are perhaps the most typical, for, as we have seen (p. 56), they occurred in great numbers in temples, as well as in houses and graves. Another type of vessel very common in ED I is an oblong jar with a single triangular or wing-shaped lug (see Pl. 47), which occurs in a variety of sizes. We may recall that the great majority of the scarlet ware vases are of this type (see pp. 51 and 65). Characteristic of ED I are also gray or black vessels (often burnished), many of which seem to imitate in form con-

⁵⁴ E.g. *JNES* II, Pl. XXVII 4-5.

⁵⁵ Chiefly architecture (see *Pre-Sargonic Temples*, p. 122), but also cylinder seals and writing.

temporaneous stone jars (see p. 58),⁵⁶ and unpainted vessels with incised and gashed decoration. This type of decoration was applied to four-lugged vessels (see Pls. 41–44) and other forms such as tall stands (see Pl. 45).⁵⁷ Only one class of painted pottery is closely associated with ED I, and this is the scarlet ware, described in detail on pages 60–72.

RELATED POTTERY FROM OUTSIDE THE DIYALA REGION IN SOUTHERN MESOPOTAMIA

Since ED I as a distinct cultural phase was established mainly on the basis of our own excavations, the above summary together with the comparisons offered in the catalogue of pottery forms may be used to establish the presence of ED I pottery at other Mesopotamian sites. We shall briefly summarize the pertinent evidence from the more important excavated sites, beginning with those nearest to the Diyala region.

At Kish the close parallels to our ED I pottery derive chiefly from the "Y" cemetery. It contained the characteristic solid-foot goblets,⁵⁸ four-lugged incised vessels,⁵⁹ single-lugged jars,⁶⁰ and gray burnished bowls similar to specimens which we call stone imitations.⁶¹ Some of our vessels with excised decoration are almost duplicated at Kish.⁶² Some spouted vessels from Kish⁶³ are comparable with those shown in our Plate 38 *a-b*. From the material of the few tomb groups published one gets the impression that the "Y" cemetery extended into ED II. It is to be hoped that the yet unpublished records of these excavations will prove adequate for more detailed studies of the important material which they have yielded and its comparison with other, better stratified finds.

While the bulk of the material from Jamdat Nasr is of the Protoliterate period—mostly phases *c* and *d* (see p. 128)—there are a few pottery types which have close parallels among our ED I material. Of these one may mention a spouted jar with a notched ridge around the shoulder⁶⁴ comparable with our Plate 37 *a-c*. Apparently incised pottery was also present, for at least one fragment of a jar⁶⁵ is comparable with our Plate 44 *a*.⁶⁶ The relative scarcity of characteristic ED I material indicates, we think, that at least the area chosen for excavation was abandoned at the beginning of ED I.

Of the pottery from Tell 'Uqair,⁶⁷ no specimens which can clearly be dated to ED I are ac-

⁵⁶ It may be noted that when fragments of this pottery began to appear in ED I levels they were believed to represent the so-called "Uruk ware." However, the distinctive forms of the complete vessels leave no doubt that at most the gray pottery of ED I may reflect only a technical tradition going back to Protoliterate times. Indeed, it may be noted that plain gray or black pottery, sometimes burnished, occurs in small quantities throughout practically all periods of Mesopotamian history. Such gray pottery usually takes shapes characteristic of the period to which it belongs. Thus, for instance, a pot from Ur (Woolley, *The Development of Sumerian Art*, Pl. 10 *c*), reproduced to illustrate "pottery of the Uruk type," is more likely to be of late Protoliterate date. In fact, it would seem that none of the specimens reproduced on the same plate belong to the Uruk ware. Specimen *b*, like *c*, belongs by both form and decoration to the end of the Protoliterate period; specimens *d* and *e* are practically identical with such of our specimens as that shown in Pl. 48 *c* and are most likely of ED I date; specimen *a* resembles our specimens shown in Pl. 66 and consequently is probably of ED I or possibly even of ED II date.

⁵⁷ It is interesting to note that richly incised pottery of a somewhat different character occurs at about the same time in North Mesopotamia (see AAA XX 172–74 and Pls. LXII–LXIII). However, a close examination fails to provide clear evidence of any connection between our incised pottery and that of the North.

⁵⁸ Cf. *Kish* IV, Pls. I 6 and XVI 4, with our Pl. 46 *g*.

⁵⁹ Cf. *Kish* IV, Pl. I 4–5, and D. B. Harden in *Iraq* I 35 and Pl. VI *a* with our Pls. 41–44.

⁶⁰ Cf. *Kish* IV, Pl. I 9 and 12, with our Pl. 47.

⁶¹ Cf. *Kish* IV, Pl. XVI 2, with our Pl. 48 *a-b*.

⁶² Cf. *Kish* IV, Pl. XVI 5–6, with our Pl. 45 *a-c*.

⁶³ *Kish* IV, Pl. I 2 *b*.

⁶⁴ Mackay, *Jemdet Nasr*, Pl. LXIII 23.

⁶⁵ *Ibid.* Pl. LXVI 42.

⁶⁶ For other comparisons see shapes B.516.270, B.664.540*b*, B.664.570, C.605.240, C.802.200.

⁶⁷ See *JNES* II 131–58.

tually known, but what information we possess about the dating of various parts of the site indicates that such material may be expected.

At Farah⁶⁸ the ED I period is rather poorly represented in the published material.⁶⁹ However, since there is evidence that the site was inhabited in Protoliterate times on the one hand and during ED II and III on the other, one must consider the possibility that the scarcity of ED I material is due to accidentals of digging.

At Warka the period under discussion is hardly represented in the published material. However, it is of interest to note that fragments of solid-foot goblets are shown in layers II/III,⁷⁰ which on the whole undoubtedly contain material of the Protoliterate period. From the same layers there is shown also a pot cover similar to ours of shape B.664.520b,⁷¹ which is typical of ED I-II. Thus one gets the impression that these strata at Warka were not entirely undisturbed by later settlers. A solid-foot goblet and a fragment of what might be a four-lugged incised jar⁷² are shown even among the finds attributed to layer IV.

ED I is very poorly represented in the material published from Telloh. In the deep sounding made by De Genouillac for stratigraphic purposes and in which he discovered abundant material of ^cUbaid and Protoliterate times, the remains of the Early Dynastic period as a whole seem to be very scanty. It is indeed possible that the accumulation of debris between 2 and 3.75 meters represents a time during which this particular area was not occupied.⁷³ The occurrence of solid-foot goblets⁷⁴ and at least one of the less characteristic forms (B.664.570) indicates, however, that ED I pottery is not entirely absent at Telloh.

At Ur, ED I remains are identified by solid-foot goblets in the sounding pit in the town area.⁷⁵ In addition, some graves of the so-called "Jamdat Nasr" cemetery are undoubtedly of ED I date. Evidence to this effect is to be found even in the very concise accounts of these graves published so far.⁷⁶ An excavation photograph clearly shows single-lugged jars and spouted jars very similar to those shown in our Plate 37 *a-c*.⁷⁷ Another indication in support of this view is the presence in some of these graves of gray burnished stone-imitation vessels.⁷⁸ The presence of vessels with reserved-slip and monochrome decoration does not contradict this view, for, as we have seen, these techniques continued from the Protoliterate period into ED I. Whether any vessel thus decorated belongs to one or the other of these periods is to be determined mostly by its shape.

Among the pottery from al-^cUbaid one can distinguish certain types which are represented among our ED I pottery. As examples one may cite a single-lugged jar⁷⁹ which practically duplicates our Plate 47 *d* and *f* and a large spouted jar⁸⁰ of the same type as our Plate 39 *a* but with reserved-slip decoration in an oblique pattern similar to that on our Plate 39 *b*. Typical solid-foot goblets are also present at al-^cUbaid.⁸¹ A more detailed study of the al-^cUbaid tomb groups in which occur types dated to ED I on the basis of our material would undoubtedly

⁶⁸ See Heinrich, *Fara*, and Erich Schmidt in *MJ* XXII 193-217.

⁶⁹ Only a few of our ED I jars (B.664.520b, C.514.362, C.525.262c, and C.556.242) have parallels among the Farah pottery.

⁷⁰ See *UVB* IV, Pl. 20 B *c'*, *y'*.

⁷⁴ *Ibid.* Pl. VIII 4332.

⁷¹ *Ibid.* Pl. 20 B *b*.

⁷⁵ *AJ* X 331 and 339.

⁷² *Ibid.* Pl. 20 A *s* and *t'* respectively.

⁷⁶ In *AJ* X 327 f. and XIV 362-72.

⁷³ See Genouillac, *Telloh* I 23.

⁷⁷ *AJ* X, Pl. XL *b*.

⁷⁸ See *AJ* XIV 365. Two of these, practically identical with our Pl. 48 *c*, are given as examples of "pottery of the Uruk type" in Woolley, *The Development of Sumerian Art*, Pl. X *d-e*.

⁷⁹ *UE* I, Pl. LIII, top right.

⁸⁰ *Ibid.* Pl. LIV, lower left. The same jar is shown in Woolley, *The Development of Sumerian Art*, Pl. II *c*, as an example of "reserved slip" ware from Ur."

⁸¹ *UE* I, Pl. LV vii. For other comparisons of specific shapes see B.003.200b, B.076.700, B.077.700a, B.514.270, C.514.362, C.525.262b, C.525.370a, C.526.262b, C.526.362b, C.556.242, and C.605.240.

add some types of ED I pottery which are absent in our finds. However, such a study is outside the scope of the present publication.

RELATED POTTERY IN ELAM

The connections between our ED I pottery and certain types found in Elam are worthy of special attention, not only because these connections establish more precisely the relative dating of the Elamite material, but also because they provide new criteria by which certain theories of long standing can be reconsidered.

It has long been recognized that "the central fact for the chronology of all the Elamite material is the discovery of an apparently undisturbed burial at Tepeh Aly Abad."⁸² Previously such dating had depended largely on the comparison of certain objects other than pottery with similar objects known from excavations in Mesopotamia which were themselves only roughly dated as "archaic" Sumarian; now, however, with more definite information, the burials at Tepe 'Ali'abad and their contents can be dated more accurately. Even a cursory study of the records of these burials brings to our notice the presence of single-lugged jars so typical of ED I.⁸³ In Elam, as in Mesopotamia, such jars occurred both plain and painted.⁸⁴ The occurrence in tombs at Tepe Musyan and at smaller sites nearby of typical solid-foot goblets⁸⁵ and pot-stands with excised decoration⁸⁶ confirms beyond doubt the presence of ED I pottery in this region. With this fact established, we may reconsider the polychrome pottery of the same region, together with that from Susa itself which is related to it, in order to attempt to classify and date it more precisely.

Among the fairly numerous polychrome sherds published from the Elamite sites we were able to find only two which are indubitably identifiable as late polychrome ware of the Proto-literate period (see p. 131). Somewhat more numerous but still comparatively rare are sherds which are very close to our scarlet ware and rather alien to the mass of Elamite pottery among which they were found.⁸⁷ In addition to these two categories there are vessels and sherds bearing geometric designs which are comparable with those found on our transitional scarlet ware (see pp. 60-63).⁸⁸ However, it is to be noted that there are some shapes which have close parallels among our transitional pottery, but the designs show certain rather dissimilar features. Thus we see that in some such specimens, while the painting extends onto the body below the maximum width as in our scarlet ware proper, the design on the body sometimes repeats the motifs of that on the shoulder⁸⁹ or consists of a series of wavy lines on a reserved light band.⁹⁰ In other specimens whose shapes have parallels in the Diyala region we encounter elements of design, such as the so-called "rising-sun" motif, which seem to have been popular in Elam but are rather rare among our finds.⁹¹ Such specimens might be considered as belonging to the scarlet ware if one allows for regional differences and for a richer repertory of decorative elements in Mesopotamia than has as yet been found. There are, however, other polychrome vessels in Elam which, although undoubtedly related to those just discussed, show

⁸² Frankfort, *Studies* I 64.

⁸³ *Mém.* VIII, Figs. 103, 104 (near the skull), and 105 (No. 2).

⁸⁴ *Ibid.* Figs. 276 (plain) and 285 (painted).

⁸⁵ *Ibid.* p. 136 and Fig. 270.

⁸⁶ *Ibid.* Figs. 278-80.

⁸⁷ See e.g. *Mém.* XIII, Fig. 168, and *Mém.* VIII, Figs. 250-51.

⁸⁸ See e.g. *Mém.* VIII, Fig. 282, as compared with our Pl. 8, Kh. IX 153 and 102; *Mém.* VIII, Fig. 191, right; *Mém.* XIII, Pl. XXVII 2.

⁸⁹ *Mém.* XIII, Pl. XXVI 2.

⁹⁰ *Mém.* VIII, Figs. 282-85.

⁹¹ It may be noted that an element somewhat resembling the "rising-sun" motif occurs on a scarlet-ware pot from Tell Agrab (see our Pl. 12).

additional features, both of shape and of decoration, which are alien to Mesopotamian pottery but can well be interpreted as the result of Iranian-highland ceramic traditions. Thus these vessels could be considered local products in which certain local features, as observed on Iranian monochrome-painted pottery, were combined with others borrowed from Mesopotamia. Among the "local features" one may consider the popularity of the wavy line between two straight bands, employed either horizontally or vertically.⁹² Another feature which may reflect an Iranian tradition is the subdivision of the body of the vessel below the maximum width into horizontal rather than vertical zones, for this feature is quite common on the monochrome-painted pottery. But even more significant is the occurrence of certain representational motifs, such as the bird with spread wings,⁹³ which are clearly associated with the highland pottery outside the Susa region and were remote from Mesopotamian influence.⁹⁴ Some of the vessels with non-Mesopotamian features have also more rounded contours.⁹⁵ The presence on some of the best preserved specimens of a ridge between shoulder and body as well as one below the neck⁹⁶ may be quite significant, for, as we have seen, a plastic ridge between shoulder and body, though it is a typical Mesopotamian feature, does not occur in the scarlet ware except on two vessels of uncertain stratigraphy and does not become common on plain pottery until ED II (see pp. 69-72). Consequently, the Elamite specimens should probably be dated not earlier than the end of ED I or possibly even ED II. This comparatively late date for these specimens would explain the apparent decline in their decoration as compared with the Protoliterate polychrome pottery and the scarlet ware.

To summarize, it seems safest to assume that some of the polychrome pottery of the so-called "Susa II" culture in Elam developed under the impact of Mesopotamian influence. Probably a small number of Mesopotamian polychrome vessels were at first imported into the region (as witnessed by the sherds of late polychrome ware of the Protoliterate period). In the Early Dynastic period apparently the importation of Mesopotamian polychrome pottery, which had by then developed into scarlet ware, increased. It would seem, however, that by this time local potters had begun to imitate the Mesopotamian pottery, at first following closely the imported prototypes but gradually adding decorative motifs from the more familiar highland monochrome-painted pottery. Thus toward the end of ED I and possibly in later phases of the Early Dynastic period this local product became a hybrid in which the various elements were not too happily blended. In its turn, this local product apparently gave rise to a distinct group of pottery—mostly large storage jars—with over-all monochrome decoration.⁹⁷ In their forms too these jars show certain features in common with the polychrome vessels. They usually have a raised ridge between shoulder and body, sometimes in an exaggerated form; the neck is modified, and the rim is different from both the well defined wide ledge- and the vertical band-rim.

If we are correct in our assumption that the "hybrid" polychrome jars belong to the end of ED I and probably ED II, the monochrome-painted derivatives could be still later, that is, ED III or even Protoimperial. These conclusions are supported in a general way by a few objects found within or in association with these jars.⁹⁸ Unfortunately, while objects of ED III date are present, their exact association with the various pottery types is rarely recorded in such a manner as to be of *specific* use.

While close connection during ED I between South Mesopotamia and the region of Iran

⁹² *Mém.* VIII, Pl. VII and Figs. 285-86.

⁹³ Cf. e.g. *Tépé-Giyan*, Pls. 33 and 67, with *Mém.* I, Pl. XXII.

⁹⁴ *Ibid.* Fig. 286.

⁹⁵ E.g. *Mém.* XIII, Pl. XXX 7.

⁹⁶ *Ibid.*

⁹⁷ *Ibid.* Pls. XXIV and XXXI. It is interesting to note that on purely stylistic grounds Frankfort concluded that the monochrome-painted storage jars are later than the polychrome specimens (*Studies* I 50).

⁹⁸ See *SAOC* No. 23, p. 45.

known as Elam is obvious, again, as in the Protoliterate period, according to our interpretation the main influence was that of Mesopotamian culture on that region, not the reverse. However, it would be unreasonable to suppose that the influence was entirely one-sided. Undoubtedly not only ideas but actual objects were brought into Mesopotamia from Elam. Possibly one Iranian idea concerning pottery-painting is the overflow of the decoration from the shoulder, to which it was restricted in the Protoliterate period, to the body, an idea which was so well exploited in the scarlet ware.

NORTH MESOPOTAMIAN CONNECTIONS

Although very few links with North Mesopotamia are thus far established, at least one sherd among our finds (Pl. 64:16)⁹⁹ was recognized as an example of the so-called "Ninevite 5" ware, known from sites on the upper Tigris. On the other hand, on the upper Euphrates were found, at Mari, two vessels which are undoubtedly related to the scarlet ware.¹⁰⁰ However, it is my impression that these vessels may be somewhat later than the bulk of our scarlet ware. As we have seen (p. 80), it seems very probable that in Mesopotamia itself scarlet ware continued at least into ED II, and on the whole I would be inclined to ascribe this date to the "scarlet ware" from Mari and the finds associated with it, for in addition to the fact that these vessels differ in shape from those in the South, one should, a priori, allow some time for the spread of this ware from the center to the periphery. Unfortunately very little of the pottery found at Mari is as yet published.

EARLY DYNASTIC II

DIYALA POTTERY

The pottery of ED II retains very largely the features of ED I, since there is a clear cultural continuity between the two phases of the Early Dynastic period. Under these circumstances the characteristic changes and innovations, even though comparatively slight, are of considerable interest for our purpose, as they provide archeological criteria for distinction between the two phases. Such changes are to be observed in the forms of the pottery, in the methods of decoration, and in the combinations of these two features. Thus, while painting, probably reserved slip, and incised decoration continue to be employed, each undergoes certain significant changes. The notable changes in painted decoration, combined with other new features, indicate an ED II rather than an ED I date for two specimens whose exact archeological context is uncertain (see p. 80). Among the vessels with reserved-slip decoration, now used mostly on spouted jars, there is one example with a checker pattern which may prove significant (Pl. 67 *f*). Incised decoration, done with a single sharp point, is found on the shoulder of a large hole-mouth jar (Pl. 71 *a*); the design is different from the elaborate incised decoration of ED I in that it contains simple representational motifs (fishes). It may thus be considered a forerunner of the incised representational designs of ED III, which are, on the whole, more elaborate.

Among new features affecting the pottery forms one may recall the appearance of single or double plastic ridges between shoulder and body on large spouted jars (e.g. cf. Pl. 67 *a-b* with Pl. 39 *a*). Similar ridges occur also on large jars without spouts (Pl. 66 *c-e*). While tall tubular stands with apertures cut in the walls continue to be used in ED II, they lack such elaborations as rims and lugs and appear, on the whole, to be less elaborately decorated than those of ED I (cf. Pl. 68 with Pl. 45). Small undecorated stands of various sizes were apparently introduced during ED II as a common household utensil (see p. 81).

⁹⁹ See *OIC* No. 19, p. 21 and Fig. 20.

¹⁰⁰ See André Parrot, "Les fouilles de Mari, quatrième campagne (hiver 1936-37)," in *Syria* XIX (1938) 5 and Pl. II 4 (Nos. 1436-37).

Flasks, which appear for the first time, are all of one type (Pl. 75 *a-e*), which can thus be considered very characteristic of ED II. However, the most distinctive new classes of vessels in ED II, which, in fact, have come to be considered among the most characteristic of the Early Dynastic period as a whole, are the so-called "fruit stands" and the jars with single, upright handles—the forerunner of the so-called "goddess-handles." In describing these two classes of vessels (pp. 83–85) we endeavored to notice the characteristics which distinguish the earlier from the later specimens. In short, ED II "fruit stands" consist of either an undecorated conical stand and a fairly simple rimmed bowl (e.g. C.364.810*a-b*, C.365.810*a*) or, more characteristically, of a very tall trumpet-like stand, decorated with incised patterns and plastic ridges, surmounted by a large bowl (Pl. 81 *a-c*). As for the upright-handled jars, we noticed that in the earlier specimens flat solid handles decorated with simple incised designs and wide beveled ledge-rims are common, while in later vessels hollow handles and band-rims become more frequent. But it may be well to recall that these distinctions could be established only on comparatively broad lines, that is, as expressing general trends to which there are numerous exceptions. It is thus sometimes difficult to make use of these distinctions in dating individual specimens.

RELATED POTTERY FROM OUTSIDE THE DIYALA REGION

Comparatively little pottery from other Mesopotamian sites can be attributed to ED II. North of our region we find now some parallels from Assur to our tall stands and "fruit stands."¹⁰¹ Even an exceptional three-legged vessel (Pl. 70 *k*) has a counterpart in Assur, although the latter is somewhat more elaborate and has no handles.

Of the sites south of our region Farah provided a somewhat larger number of parallels.¹⁰² While at Kish comparatively few related forms¹⁰³ are noticed. Comparable forms from other sites¹⁰⁴ are also few.

The small number of close parallels to our ED II pottery from other sites is probably due to a combination of circumstances. In the first place, it would seem that the period was comparatively short¹⁰⁵ and not well represented by building remains at any of the above mentioned sites. In addition, it is probable that at Kish, at least in the part excavated, there was a gap in habitation roughly corresponding to this period. Finally, there is probably also an element of chance, for the cemeteries at Ur and Kish, which supplied the largest collections of Early Dynastic pottery, both happened to be in their major parts of somewhat later date.

EARLY DYNASTIC III

DIYALA POTTERY

A considerable proportion of pottery types found in ED III levels are either unchanged survivals or somewhat modified versions of earlier types. Entirely new types are comparatively few. The most numerous vessels of a type which continued in use are rimless conical bowls with flat bases (Pl. 96 *a-e*). Small conical bowls with inner rims (Pl. 97 *a-k*), which first appeared in ED I (see p. 83), are also found in considerable numbers. Conical bowls with a short solid foot (Pl. 96 *f-g*) are less common (see p. 95). Small jars with flat bases and rimless necks (Pl. 98 *a-l*) occur in a considerable variety of forms. On the other hand, flasks, though apparently related to those of ED II, are of quite a different and distinct shape (see p. 100). This

¹⁰¹ For specific comparisons see shapes C.357.000, C.357.010*a-b*, C.364.810*a*, C.366.810, and C.367.810.

¹⁰² Specific comparisons are given under shapes B.573.220, B.663.540*b*, C.235.370, C.357.010*b*, and C.525.370*a*.

¹⁰³ C.537.010*b*, C.364.810*a-b*, C.525.371*a*, and C.654.510.

¹⁰⁴ Ur: B.545.220*a*, B.663.540*b*, C.364.810*b*, C.525.370*a*, and C.557.422; al-Ubaid: C.525.370*a* and C.557.422; Telloh: B.545.220*a* and B.806.570. A sherd very similar to the one shown in Pl. 71 *b* was found at Susa (*Mém.* VIII, Fig. 108).

¹⁰⁵ See our estimation in *Pre-Sargonic Temples*, pp. 134 f. and Fig. 115.

new shape may be considered the prototype for the so-called "pilgrim flasks" used in the Near East for many centuries—in fact, practically down to modern times.

Perhaps the most significant pottery types which survived from ED II are the "fruit stands" and the upright-handled jars. The latter underwent significant changes within ED III itself and thus helps us to distinguish between earlier and later phases of this period. These changes are discussed on pages 87–90 and need not be repeated here. They are of course important for the comparative dating of other, unstratified sites (see e.g. p. 146).

Another change of more general character, observed in other excavations too, is the comparative scarcity of spouted vessels in ED III—especially toward the end—as compared with earlier times.¹⁰⁶ Of the rather small number of spouted vessels found in ED III levels some are probably survivals from earlier times; others are specialized types apparently intended for specific, most likely ritual, purposes (see pp. 91–93). To the latter category one may attribute the vessels shown in Plate 93 and double-spouted jars (Pl. 91 *a, c*), which were sometimes decorated with snakes in relief. Furthermore, a number of small jars only appear to have spouts, for closer examination reveals that they were pinched together or clogged with irregular lumps of clay so that they were completely stopped up (see p. 92).

Theriomorphic vessels continued into ED III, and among them vases representing rams seem to have been the most popular. It is interesting to note that such vases were often supplied with wheels, a feature which survived into much later times (see pp. 93 *f.*).

Of the new types of utensils introduced during ED III one may mention open braziers consisting of large shallow dishes with inwardly bent lugs (Pl. 104 *a*) or strips of clay (Pl. 104 *d, f*). Also typical of ED III are small vessels with various types of suspension devices (Pl. 101 *a-h*).

The outstanding feature of ED III pottery is the complete absence of painted decoration. Reserved-slip decoration is very rare, and in all probability such sherds as were found in ED III levels belong to vessels of earlier periods.

Incised decoration continued and developed in ED III. Usually such decoration is confined to the shoulders of large vessels, especially jars with upright handles. However, it sometimes occurs on the shoulders of other types of jars (see e.g. Pl. 93 *a*) and on the stems and bases of "fruit stands" (see Pl. 89).¹⁰⁷ Another common type of decoration consists of plastic ridges, usually at the join of body and shoulder; plain and notched or "corded" ridges occur. Plastic decoration in the form of applied snakes (see Pl. 91 *c* and 92 *g*) and animal effigies (e.g. Pls. 93 and 95) are known. Occasionally incised designs are combined with plastic decoration, usually in the form of animals (Pl. 93 *a* and 95 *a-b*).¹⁰⁸

White-filled incised or pricked designs, usually on gray pottery (e.g. Pl. 100 *g*), occur at various sites.¹⁰⁹ It may be noted, by the way, that the gray pottery of ED III includes various forms (e.g. Pl. 101 *h* and 102 *b*) and its fabric is indistinguishable at present from that of the gray pottery which occurs, though in small proportions, in nearly all periods.¹¹⁰ Yet another kind of decoration, which seems to have been confined to small shallow bowls, consists of simple designs formed by applied clay pellets and flattened rolls of clay (see p. 102). The most com-

¹⁰⁶ See e.g. Mackay, *Kish "A,"* p. 29.

¹⁰⁷ More elaborate incised decoration on the stems of utensils, some with representational designs, is known from other sites, e.g. Ur (*UE II*, Pl. 180 *b*), Telloh (Genouillac, *Telloh I*, Pls. 63–65), Bismayah (Banks, *Bismyah*, p. 348).

¹⁰⁸ See also a "fruit stand" from Ur (*UE II*, Pl. 180 *b*) and various fragments from Assur (*WVDOG XXXIX*, Pls. 21–23).

¹⁰⁹ See e.g. Mackay, *Kish "A,"* Pls. I 3 and XLV 5 = LII 9; Heinrich, *Fara*, Pl. 18 *a*; *Mém. VIII*, Fig. 287 (Tepe 'Ali'abad); *AAA XX*, Pl. LXIII (Yarimjah).

¹¹⁰ No microscopic analyses have yet been undertaken, but it would be extremely interesting to see whether such analyses could establish (a) a fundamental difference between the gray and the common buff pottery at any given period and (b) any distinctions among the gray pottery of the different periods.

mon among these is the so-called "palm-branch" motif, but occasionally there were attempts at other representational motifs.¹¹¹

Vessels of the so-called "studded" ware are decorated with fairly large hemispherical or slightly pointed studs applied to the surface (see p. 102). This type of decoration apparently was limited to rather small globular jars with narrow necks and, usually, suspension loops, similar to those on flasks, or perforated lugs. Sherds of such vessels were first found in houses of the Agade period at Tell Asmar and immediately suggested cultural connections between Mesopotamia and the Indus Valley in that period, since similar ware had been found at Mohenjo Daro and Harappa.¹¹² However, we have now established the fact that this ware occurred in Mesopotamia as early as ED III, and thus relations with the Indus Valley at that time are implied. Moreover, it may be of interest to note that what seems to be a very specialized ware is much more common than would be expected, for it occurs over an enormous area and, apparently, covers an extraordinary length of time.¹¹³ Thus, in drawing conclusions regarding cultural connections on the basis of this type of decoration, not only the decoration itself but also the particular forms and fabrics with which it is associated must be taken into consideration.

RELATED POTTERY FROM ELSEWHERE

Our pottery from ED III levels shows more connections with other sites than does the pottery from any previous period. This is probably due to the fact that in the Diyala region, as well as at some of the other important sites, fairly large town areas and numerous graves of this period were excavated.

The site which shows the most parallels to our ED III pottery is Kish. These parallels range from miniature handmade bowls to very large storage jars and include a considerable variety of forms.¹¹⁴ For purposes of comparative dating perhaps the most significant forms are the "fruit stands" and upright-handled vases. The majority of the "fruit stands" from Kish "A" have tall, cylindrical stems decorated with notched plastic ridges and incising.¹¹⁵ The upright-handled vases usually have comparatively tall bases and necks and elaborate goddess-handles.¹¹⁶ These features, as we have seen (pp. 87-90), are comparatively rare among our finds and were found only in context dating to the end of ED III or perhaps even to the Proto-imperial period.¹¹⁷

Our excavations reveal a definite development of these two particular pottery types. One may conclude that the marked diversity between most of our own specimens and those from Kish "A" is due less to local preferences for certain varieties than to the fact that the bulk of the finds from the "A" cemetery at Kish represent a phase of the ED III period later than that represented by most of our own finds from that period.

The pottery from the Royal Cemetery at Ur includes a number of forms which closely

¹¹¹ Such representational motifs occur on very similar bowls which were found in great quantities at Susa (e.g. *Mém.* XII, Figs. 341, 347, 355, 379, 440).

¹¹² See *OIC* No. 16, pp. 49-53.

¹¹³ Some examples are given under shape C.665.543.

¹¹⁴ See references under forms A.035.600, A.186.400, A.475.120, A.546.630, A.652.500, B.003.200a, B.175.220a-b, B.175.224, B.176.224a, B.184.220c, B.185.224, B.544.570, B.575.225, B.575.240, B.666.540b, B.675.220a, C.011.201a, C.012.203, C.022.300, C.201.200, C.201.203, C.213.210, C.363.810a-b, C.364.810a-b, C.365.810a-d, C.404.350, C.504.360, C.504.370, C.505.370b-c, C.506.470b, C.515.370a, C.516.471, C.526.371a, C.526.471a-c, C.527.362, C.545.310, C.545.320, C.545.640, C.555.420, C.556.640, C.565.540, C.654.520, C.686.420, C.754.521, and D.555.510b.

¹¹⁵ See e.g. Mackay, *Kish "A,"* Pls. XI, XII, XLIX, L.

¹¹⁶ See e.g. *ibid.* Pls. IX, X, XLVIII, XLIX.

¹¹⁷ The stratification and comparative dating of the graves in which such specimens were found will be discussed in detail in *Private Houses and Graves in the Diyala Region.*

resemble some of our ED III specimens.¹¹⁸ It may be noted, however, that parallels to our pottery are fewer than at Kish. An interesting fact revealed by a comparison of our ED III pottery with that from the Royal Cemetery at Ur is that "fruit stands" and jars with upright handles are comparatively scarce at Ur. This is all the more remarkable since there is ample evidence that a considerable number of the Ur graves are of ED III date and that other finds show a close uniformity of material culture in both regions.¹¹⁹ In view of the large quantities of pottery available for comparison scarcity of "fruit stands" and upright-handled jars at Ur can hardly be explained by fortuity alone. It would seem rather that even within an area where a great uniformity of material culture is well established one must still allow for a considerable degree of general variation in the types of pottery used.

Two other Mesopotamian sites whose pottery includes parallels to our own from ED III are Farah¹²⁰ and Telloh.¹²¹ The fact that we can cite relatively few parallels from these sites is due in the first place to the relatively small quantities of pottery published from them. Under the circumstances no significant conclusions can be drawn on the basis of our comparisons except that each of these sites was occupied in the period under discussion, which is substantiated by other evidence.

Of the other Mesopotamian sites which have produced parallels to our ED III forms, Assur should be mentioned.¹²² Mari, although some 350 kilometers distant from our region, shows a striking similarity of material culture, most clearly demonstrated by the sculpture.¹²³ A priori one would have expected the pottery also to reflect clearly close cultural connections, but unfortunately very little pottery was found and among its parallels to our pottery are few.¹²⁴

As in earlier periods (i.e., Protoliterate to ED II; see pp. 133-34, 141, 142) the cultural connections between southern and northern Mesopotamia seem to be much closer along the Euphrates than along the Tigris. Indeed, at least as far as evidence provided by the pottery is concerned, one can hardly discern in ED III any connections between the sites on the upper reaches of the Tigris (north of Assur) and the South.

Parallels from Elam to our ED III pottery are rather limited.¹²⁵ One may note, however, that at least two of the most characteristic pottery types for this period, namely the "fruit stands" and the jars with upright handles, were undoubtedly present. As it happens the few published specimens¹²⁶ can be dated on the basis of our evidence to the end of ED III or even to the Protoimperial period.

THE PROTOIMPERIAL PERIOD

Although the quantity of pottery from Protoimperial levels is considerably less than that from any phase of the Early Dynastic period, it is sufficient to indicate closer connections with the pottery which preceded it than with that which followed. For the number of new types

¹¹⁸ See references under shapes B.016.200, B.175.220a, B.575.225, B.645.540b, B.666.540b, C.201.200, C.226.220, C.352.000, C.353.010a, C.364.810b, C.506.470d, C.556.322, C.556.540, C.556.640, C.557.470, C.654.520, C.96, and D.546.540b.

¹¹⁹ The often cited plaque fragment from Ur which serves as a basis for reconstructing the missing part of a plaque from Khafajah (see H. Frankfort, Thorkild Jacobsen, and Conrad Preusser, *Tell Asmar and Khafaje, The First Season's Work in Eshnunna, 1930/31* [OIC No. 13 (1932)] Figs. 44-45 and pp. 96 f.) is one case in point.

¹²⁰ See references under shapes A.516.373, B.575.225, B.663.540b, B.816.521c, C.213.210, C.215.210, C.354.010, C.363.810a-b, C.365.810d, and C.515.370a.

¹²¹ See references under shapes A.546.630, A.652.500, A.655.520a, B.063.200b, B.555.540a, B.645.540b, C.545.310, C.556.640, C.565.540, D.526.370a, and E.303.010.

¹²² See references under shapes C.215.210, C.364.810a, D.546.540b, and D.555.510b.

¹²³ See Frankfort, "Mari et Opis," *RA XXXI* (1934) 173-79, and Parrot, "La civilisation mésopotamienne," *RA XXXI* 180-89.

¹²⁴ See references under shapes C.356.000, C.365.810c, C.526.373b, C.526.471b, and C.654.503.

¹²⁵ See references under shapes C.353.010a, C.365.810d, C.466.470, C.526.371a, and C.526.471b-c.

¹²⁶ *Mém. XXV*, Fig. 55:5-6; *Antiquity V* (1931) Pls. VIII-IX (after p. 336).

which survive into later times is smaller than the number of types which are either survivals of or developments from earlier ones (see p. 159). Common pottery types which survive from earlier periods include conical bowls, small jars with and without pouring lips, and a variety of squat bottles (see p. 107). Of the more specialized types upright-handled vases, braziers, and probably "fruit stands" survived from earlier times. Of characteristically decorated wares which continued from ED III one should mention the studded and ribbed wares. A distinctive new type which continued into subsequent periods is a tall cylindrical cup which flares at the top (B.256.200 and C.257.210). Large spouted bowls (C.544.312) and medium or large storage jars with ribbed shoulders (C.466.450 and D.466.360) are characteristic of this period.

Connections with other Mesopotamian sites are fairly numerous. Again Kish provides the largest number of parallels.¹²⁷ It may be noted that the comparatively few upright-handled jars which were found in Protoimperial remains, or in association with other types of pottery and objects of Protoimperial date, generally show closer resemblance to vases from Kish "A" than to specimens found in clear ED II or ED III context at our sites. This suggests that many of the Kish goddess-handled vases belong to the Protoimperial rather than to the Early Dynastic period.

Significant for relative dating, although less numerous, are the parallels from the Royal Cemetery at Ur.¹²⁸ For example, the tall cylindrical cups represented in our pottery by shapes B.256.200 and C.257.210 (see p. 106) and in the pottery from the Royal Cemetery by Type 16¹²⁹ are considered by Woolley to be "an early type."¹³⁰ If the association of Type 16 as shown in the tabular analysis of the graves¹³¹ were certain beyond any doubt, one could derive some general conclusions transcending in importance the dating of this particular pottery type. According to the evidence from our excavations, all the graves in which it occurs have to be dated not earlier than the Protoimperial period. Thus our new dating would affect a considerable number of finds other than pottery, for example the finds from "royal" tomb No. 580, including the famous golden dagger.¹³² However, in this particular case, where for various reasons the excavation and recording of the tomb were apparently not up to Woolley's usual high standards, one may doubt whether all the objects recorded belonged to the same tomb and thus whether the pottery in question was actually associated with all the rest of the finds.¹³³ Apparently no such doubt exists in the case of the simpler burials in which this type of cup occurs. If they are to be dated not earlier than the Protoimperial period, this new date would affect the dating of the pottery types and other finds in them for which there is no positive evidence of survival from earlier periods and could serve as a starting point for a new approach to the comparative dates of a considerable number of graves in the Ur cemetery.¹³⁴

¹²⁷ See references under shapes B.041.710, B.185.220, B.546.640b, B.665.520, B.703.560, B.704.570, C.201.203, C.213.200, C.233.100, C.404.350, C.526.471a and d, C.527.471, C.565.540, and D.555.510b.

¹²⁸ See references under shapes A.756.520, B.185.220, B.256.200, C.257.210, C.466.450, C.544.312, C.556.322, D.465.550, D.466.360, and D.546.540b.

¹²⁹ See *UE* II, Pl. 251.

¹³⁰ *Ibid.* p. 390.

¹³¹ *Ibid.* pp. 412-81.

¹³² *Ibid.* Pl. 151 and p. 51.

¹³³ See *ibid.* pp. 47 f.

¹³⁴ While we cannot here devote enough space for a thorough examination of the contents of these graves from this point of view, we may note at least some of the pottery associations. In four of them (Nos. 180, 188, 1650, and 1774) Type 16 is the only type of pottery listed in the tabular analysis; in the rest (Nos. 36, 42, 580, 730, 984, and 1630-31) this type is associated with Types 5, 7, 45, 49, 61, 67, 83, 100, 106, 108, 123, 186, and 208. About half of these types (5, 7, 45, 100, 108, and 123) are already recognized as extending into Sargonid times and are thus not affected by the new evidence. The others have been considered to be confined to the "predynastic" cemetery. However, their association with Type 16 might indicate a later date for them and, unless there is other evidence to the contrary, also for the graves in which they occur. By similarly making use of evidence provided by other stratified and well dated examples from our own excavations which have close parallels in the pottery from Ur, it should be possible to check and in some cases to correct the comparative dating of the material from the Royal Cemetery. (An analysis of some of the graves along quite different lines has been attempted by Svend Aage Pallis in *Chronology of the Shub-ad Culture* [København, 1941]. However,

Of the other Mesopotamian sites with parallels to our pottery of the Protoimperial period, Telloh should be mentioned.¹³⁵ It will be noted that the tall cylindrical cups (B.256.200 and C.257.210) just discussed occur also at Telloh, as well as a studded-ware jar of a shape similar to our C.665.543*d*.

A few of our forms which occurred in Protoimperial context have parallels at Farah, Bismayah, and al-ʿUbaid.¹³⁶ The unique painted specimen shown in Plate 112 *f* (= Pl. 139 *b*) suggests connection with North Syria (see pp. 108 *f*.). Pottery from Elam provides a few parallels to our pottery of this period. We have already mentioned that "fruit stands" and upright-handled vases have been found in Elam and that the few published specimens can be attributed to the end of ED III or perhaps even to the Protoimperial period (see p. 144). Other parallels from Elam include embossed bowls, a cylindrical cup, and jars.¹³⁷

Connections with Assur are provided mainly by ribbed ware and by storage jars with a plastic ridge at the join of body and shoulder.¹³⁸ Cups, storage jars, and studded ware similar to our Protoimperial types are to be found also at Nuzi.¹³⁹

THE AGADE PERIOD

In examining the pottery from the Agade period one notices once more that a large part of the assemblage represents a continuation of earlier types (see pp. 159 *f*.). As examples of characteristic types surviving from Early Dynastic and Protoimperial times one may mention ribbed ware (see p. 110), storage jars with ribbed shoulders (see p. 112), and braziers with four broad strap "handles" joined in the center (see p. 112).

Some of the new forms now introduced become more popular as time goes on and are, indeed, to be found among the most characteristic pottery types of later periods in southern Mesopotamia. Perhaps the most characteristic innovation in the stock of common household vessels is the introduction of conical bowls with a slight inner rim supporting an upright band-rim (see p. 109), which replace the earlier type of conical, rimless bowl. We have already drawn attention (see p. 85) to the fact that rimmed bowls such as those which constitute one of the elements of the so-called "fruit stands" do not occur as separate elements among our pottery from earlier periods. They do occur occasionally in much earlier context elsewhere.¹⁴⁰ This absence is yet to be explained. Another noteworthy new type is a medium-sized jar with a ring base and low center of gravity (Pl. 114 *f*). Such jars become more numerous and varied in subsequent periods of Mesopotamian history.

Except for a few examples of burnished or partly burnished vessels and some with plastic ridges the pottery of this period is undecorated. As in all other periods, a sprinkling of gray pottery is present; however, it reveals no special characteristics of shape or of decoration.

Few stratified building remains of the Agade period have thus far been excavated at other Mesopotamian sites, so it is not surprising that we found but few parallels to our pottery. The Royal Cemetery at Ur produced the most and the best parallels.¹⁴¹ The published pottery from Telloh shows a few types closely related to our own and thus undoubtedly representing the

Pallis makes very little use of pottery for comparison and, in fact, is rather inclined to disregard archeological evidence provided by stratified excavations. His conclusions have thus no bearing on our problems.)

¹³⁵ See references under shapes B.072.200, B.225.540, B.256.200, C.257.210, C.565.540, and C.665.543*d*.

¹³⁶ See references under shapes B.184.220*c*, B.185.220, C.213.200, C.257.210, C.363.810*b*, C.556.322, and C.743.570.

¹³⁷ See references under shapes B.041.710, B.256.200, C.466.370, C.466.450, and C.466.470.

¹³⁸ See references under shapes C.215.210, C.216.210, C.466.370, C.466.470, D.546.540*b*, and D.555.510*b*.

¹³⁹ See references under shapes B.184.220*a*, C.406.340, C.466.370, C.466.450, C.665.543*a*, and D.466.360.

¹⁴⁰ E.g. in Warka VI; UVB IV, Pl. 19 B *l*.

¹⁴¹ See references under shapes A.237.823, B.151.210, B.174.220*c*, B.556.540*a*, B.666.540*a*, C.466.450, C.544.312, and D.556.510*a*. It may be noted that in nearly all these forms there is no discrepancy between our evidence and Woolley's dating.

Agade period. Interestingly enough, northern Mesopotamian sites now provide good parallels to our pottery. This is well in keeping with the northward expansion of the Agade empire. Of considerable interest are some clear parallels from Nuzi¹⁴² and Assur.¹⁴³

END OF GUTIUM AND UR III

Elsewhere (p. 113) we have mentioned the circumstances which made it preferable to combine the pottery from these two phases in one group and the fact that they are rather poorly represented among our finds. Indeed, the amount of pottery which can be assigned to these two phases is smaller than that of any of the periods previously discussed. About half of the forms survived from earlier periods (see p. 160). The Tell Asmar houses which possibly date to the last years of the Gutian domination¹⁴⁴ produced but few new forms (see p. 160). On the whole the pottery from these houses is of relatively poor quality, and there occurs a considerable proportion of rather rough and ill-formed specimens (e.g. Pl. 114 *h*). One is inclined to assume that the poor quality reflects to some extent the political vicissitudes of the region during the Gutian rule, especially since a decline seems to be noticeable in other crafts too.¹⁴⁵ However, because of the comparatively small number of well dated pottery specimens, this assumption cannot be considered as proved by the pottery evidence. It is interesting, however, that on the whole the specimens which can be dated definitely to the third dynasty of Ur, although comparatively few, show a certain improvement in technique and form. Several of the shapes which were introduced in Gutium-Ur III times survived into subsequent periods.

Parallels to our pottery are few and scattered among the pottery from various sites.¹⁴⁶ Some are nevertheless of interest as indicators that closer relationships might be established if the material were more abundant.

THE LARSA PERIOD

Since considerable areas of private houses and public buildings of this period were excavated at Tell Asmar, Khafajah, and Ishchali, we possess a fairly representative collection of pottery from it. Moreover, at Tell Asmar (Eshnunna) we are in position to assign certain specimens not only to definite strata or building periods, but to actual reigns of individual rulers.

The reigns of the known rulers of Eshnunna cover approximately 350 years,¹⁴⁷ and one would have expected to be able to follow in detail the developments in pottery shapes within this range of time. However, our material is not sufficient to allow us to perceive significant changes from reign to reign. Consequently, whenever the evidence was adequate we have made a distinction between "Early Larsa" and "Late Larsa," the dividing line between the two having been set at the reign of Ibalpiel I (see p. 114).

Perhaps the most characteristic pottery type of the Larsa period is the cylindrical or slightly concave drinking cup (see pp. 115-16). Such cups occur in various sizes and proportions, with flat, rounded, or ring bases. On the whole they are thin-walled, made of finely levigated clay, and well baked. They vary from pale yellow to brownish red in color. Some of these cups are occasionally decorated with a black painted band at the rim (e.g. B.246.200a, B.706.360). The fine paste usually associated with drinking cups was now occasionally employed in the making of larger vessels of various shapes and uses.

¹⁴² See references under shapes B.042.500a, B.184.220a, and C.466.450.

¹⁴³ See references under shapes C.216.210, C.466.470, and D.546.540b.

¹⁴⁴ See *Private Houses and Graves in the Diyala Region*.

¹⁴⁵ See *Stratified Cylinder Seals from the Diyala Region*.

¹⁴⁶ See references under shapes B.031.200, B.052.200b, B.123.210, B.174.220a, B.256.200, B.536.240b, B.633.570b, B.663.520, B.706.360, C.042.200, C.111.310 a, C.257.210, C.427.570, C.544.312, and C.555.510.

¹⁴⁷ See *Gimilsin Temple*, pp. 196-200.

It is worth mentioning that medium-sized jars with low center of gravity (C.756.340, C.757.340), which were introduced in the Agade period (see p. 111), became relatively more numerous. Another characteristic of the Larsa period is the popularity of comparatively tall medium-sized jars (e.g. Pl. 121 *e-g*).

The improvement in clay noted above sometimes extends even to large vats and drains, which in all periods are usually made of coarse fabrics and are poorly baked. Now some of these drains, including a bell-shaped uppermost element (E.313.040), are often of finer paste and well baked.

In addition to actual vessels, there occurs in this period a considerable variety of terra cotta lids, funnels, strainers, as well as some objects whose use is uncertain.

For the most part the pottery of the Larsa period is undecorated. In addition to the cups with a black band at the rim, one other specimen is decorated with paint (Pl. 119 *a*), but one is reluctant to consider it as a representative of a distinctive class of painted ware, either in our region or elsewhere (see p. 114). The more regular types of decoration consist of incised and impressed designs and plastic ornamentation such as ridges, applied elements, and peculiar "columns" (see pp. 119–22). Two large vats are elaborately decorated with corded ridges and applied figures (pp. 121–22). The most distinctive decorated pottery of this period is a fine gray, sometimes burnished, ware with incised, pricked, and impressed decoration (see pp. 119–20). It may be recalled that vessels of this ware with rare exceptions are of a single type. Many of the designs consist of panels formed by vertical and horizontal bands filled with pricks (see Pls. 123–125). In the panels thus formed there are often incised representational motifs, usually birds, less frequently quadrupeds and boats. All incisions, impressions, and pricks were apparently originally filled with white paste. Traces of red paint were preserved in some of the narrower otherwise undecorated panels. Two fragmentary shallow bowls have impressed concentric circles on their flat rims. It is interesting to note that this ware has been found at such widely separated sites as Telloh and Susa, where some of our designs are practically duplicated,¹⁴⁸ a fact which may lead one to assume that this ware was the product of a single site or region. The material in our possession does not provide any indication as to the location of this presumed manufacturing center.

In examining parallels from other sites, we find that a considerable number of them come from Nuzi.¹⁴⁹ A fair proportion of these are cylindrical cups, of which a great variety has been discovered at that site. One may note that the Nuzi cups include varieties for which there are no close parallels among our finds. Of special interest are some fragments of the gray incised ware just discussed.¹⁵⁰

Of the southern Mesopotamian sites Telloh provides a fair number of analogues.¹⁵¹ Here the comparable forms cover a somewhat greater variety than those at Nuzi and again specimens of the gray incised ware are to be noted. Ur provides a relatively small number of parallels,¹⁵² but this may be because the great collection of Larsa pottery discovered there is as yet unpublished.

Of the other sites where a fair number of parallels are to be found one should mention

¹⁴⁸ It may be recalled that an attempt has been made to use certain details of one of these designs as evidence for cultural relations with Egypt (Frankfort, *Studies I* 138–42); however, the great discrepancy in time between the specimens which are compared weakens the argument.

¹⁴⁹ See references under shapes B.001.200b, B.031.200, B.174.740, B.206.423e, B.236.200a-c, B.236.300, B.237.100, B.237.200, B.246.200a, B.646.340, C.043.310, C.044.310, D.044.510, D.495.520, and D.800.200.

¹⁵⁰ Starr, *Nuzi II*, Pl. 56 I–S.

¹⁵¹ See references under shapes A.556.423, B.061.210, B.062.210a, B.206.423e, B.644.540, C.206.510, C.547.640b, C.756.340, D.044.510, E.202.010, E.313.040, and E.314.010.

¹⁵² See references under shapes B.151.210, B.246.200a, C.206.510, C.547.640b, C.756.340, and C.787.340.

Kish¹⁵³ and Abu Hatab¹⁵⁴ in Mesopotamia and, finally, Susa.¹⁵⁵ Since no exact records of the archeological context of the pottery from these sites is available, the comparisons are of little value except as evidence of remains of the Larsa period.

THE OLD BABYLONIAN PERIOD

The latest pottery in our collection is dated to the Old Babylonian period and derives from the uppermost strata at Ishchali and from Mounds B and C at Khafajah (see p. 123). Even our comparatively small collection shows certain interesting characteristics. Further technical improvements resulted in graceful, well fired vessels with very thin walls. Some of the shapes are clearly related to forms introduced in the Larsa period but are generally more graceful.

Characteristic of the period are drinking cups with oval or pear-shaped body, pronounced flaring neck, and narrow foot or ring base (see p. 123). Some of them¹⁵⁶ have parallels among the great number of cups recovered at Nuzi. The cups have been identified by Professor Speiser as "Hurrian." Together with other finds which have close parallels from Nuzi, they led him to suggest the "presence of Hurrian mercenaries whom Samsuiluna may well have employed."¹⁵⁷ This supports his theory that "the main elements of the material culture of the Hurrians had crystallized long before the people settled in large numbers at Nuzi and at Billa. The finds from Khafajeh indicate the same gradual infiltration of the Hurrians as is evidenced also by the occurrence of their proper names in Babylonia around the turn of the third millennium B.C."¹⁵⁸ This interpretation is obviously founded on two assumptions: (a) that all the pertinent objects from Khafajah should be dated to the time of Samsuiluna, and (b) that the pottery types with which he is concerned are indeed "Hurrian" and do not owe any of their characteristics to earlier southern Mesopotamian pottery. The fact is, however, that some of the relevant objects came from intrusive burials dug into the lower parts of the walls of Dur Samsuiluna when this fort was already in ruins and thus must be considerably later. As to the "Hurrian" cups, we have already seen (p. 148) similarities between Nuzi pottery and that of South Mesopotamia as early as the Agade period, and similarities were especially pronounced in the Larsa period (see p. 149). It would obviously be unwise on the strength of these similarities alone to claim "Hurrian" influence in the South in these earlier times. The crux of the matter, as far as the pottery evidence is concerned, seems to lie in the fact that entirely different types are sometimes lumped together under the name of "Hurrian goblet ware." While the painted goblets found at Nuzi are obviously related to those found at Billa, Shaghir Bazar, and as far west as 'Atshanah in the 'Amuq and are probably of the same cultural origin, some of the unpainted cups are of quite different forms and are clearly related to earlier pottery forms in the south. Thus we seem to have in the so-called "Hurrian" pottery¹⁵⁹ a combination of two distinct groups, one apparently deriving from the north and northwest and the other from the south. It seems important to clarify this point since not only are the historical implications based on our material entirely unwarranted, but they might lead to further erroneous conclusions.¹⁶⁰

¹⁵³ See references under shapes A.556.423, B.226.720c, B.236.200c, B.535.220, B.756.220, B.852, C.001.200b, C.228.340a, C.558.320, and C.655.240.

¹⁵⁴ See references under shapes B.151.210, B.207.310a, B.226.720a and c, C.043.310, C.044.310, and C.757.340.

¹⁵⁵ See references under shapes B.151.210, B.175.720, B.206.423e, B.255.200, B.706.360, B.717.700, B.756.220, B.787.320a, C.226.540, C.547.640a, C.548.720, C.558.320, D.044.510, and E.313.040.

¹⁵⁶ Shapes B.556.720, B.576.720b, and B.656.720.

¹⁵⁷ See *BASOR* No. 67, Oct. 1927, p. 6.

¹⁵⁸ See *BASOR* No. 68, Dec. 1937, pp. 12 f.

¹⁵⁹ The term in itself is no better than would be the term "Semitic pottery," for instance.

¹⁶⁰ Cf. Parrot's comments in *Syria* XIX (1938) 309.

If our material does not justify any such far-reaching theories, it nevertheless contains certain important indications in regard to the continuity of material culture not only from earlier times into the period of the Babylonian kingdom, but also from this period into the politically and culturally troubled time of Kassite rule. A comparison of our shapes with those known to have come from Kassite levels at other sites shows at least the same degree of continuity between the period of the Babylonian kingdom and the Kassite period as between the Larsa and Old Babylonian periods. However, since our own material does not extend beyond the Old Babylonian period, such a comparison and a discussion of its implications is beyond the scope of the present publication.

EXPLANATION OF THE CATALOGUE OF POTTERY FORMS

THE catalogue of pottery forms is a concise summary of information concerning the recorded pottery from the Diyala region. It faces the schematic drawings on Plates 140–99 and is arranged according to our system of classification of pottery shapes outlined in chapter i. If for some reason certain elements of a shape are doubtful the digits representing them are underscored. (For instance, C.466.570 is to be read a “jar of form 466, *probably* with a convex base.”) Elsewhere in the volume such doubt is expressed by italics. A dash replacing a digit indicates that no evidence exists as to the probable character of the element in question.

The first column after the shape numbers indicates the plates in which photographs of some specimens are reproduced. The next column gives the site where each specimen was found. The fourth column gives the locus of each specimen. Since the system of loci and levels is independent for each site,¹ care should be taken not to confuse similarly marked loci from different sites.² The maps of the sites (Pls. 200–203) will allow the reader to locate the areas and squares referred to; the exact loci will be found in the respective architectural volumes of this series. In these volumes the full archeological context of any given pottery specimen can be ascertained, for, according to our plan of publication, each architectural volume³ is to contain a complete list of objects found within each locus⁴ of the buildings concerned, usually by levels. Hence the building or level also is usually necessary for determining archeological associations.

If a form is represented by a drawing, the specimen actually drawn is listed first. The other specimens may or may not have some of the features of the drawn specimen which are not implied by the form designation, such as decoration, specific type of rim, etc. Many of the forms not drawn are, however, represented in photographs. An approximation of forms which are not illustrated can be ascertained by reference to similarly numbered shapes in other size groups (C compared with B or D) and by comparison with adjacent drawn shapes. Some of the specimens for which there is no graphic record have been assigned shape numbers on the basis of comparisons in the field records with drawn or photographed specimens. However, it is possible that in some cases somewhat different shape numbers would have been assigned if the actual specimens could have been examined.

Whenever a form is represented by more than one drawing, it is subdivided by the addition of *a*, *b*, *c*, etc. after the shape number. In such cases examination of the various drawings will show that their distinguishing features can be differentiated only by applying the detailed classification (see pp. 6, 14–16, 19–22). The letters are used instead of the more complete designations and indicate merely that certain differences exist, but they do not specify these differences. In some instances where a form has been subdivided certain specimens appear without any distinguishing letter. Either such specimens do not exactly correspond to

¹ For our system of numeration of loci see *Temple Oval*, p. 5, n. 5.

² Thus a vessel of shape C.208.320 comes from locus 1 in square P 30 at Ishchali while one of shape C.547.720 comes from locus 1 in square P 30 at Tell Asmar.

³ Except *Gimilsin Temple*, which was published before this plan was finally formulated and which lists only part of the pottery found in this complex of buildings.

⁴ E.g. a vessel of form C.702.253 is shown in the catalogue of pottery forms to derive from Khafajah, locus Q 42:26 in Sin Temple III. The Sin Temple having been published in *Pre-Sargonic Temples*, the reader may turn to Sin Temple III, locus Q 42:26 (pp. 137–38), for a complete list of the rest of the pottery and other objects found in association with this particular pot. In its turn this list indicates in which of the other volumes of this series any given object is published.

any of the lettered variants, or our information about them is inadequate for attributing them to any particular variant. Obviously such specimens are never represented by drawings.

An asterisk following the square, locus, or area indicates that there is some doubt as to the exact shape of the specimen concerned. For instance under C.366.810 four specimens, all from graves at Khafajah, are listed. The first, from grave 91 in P 43:23, is the one actually drawn. The locus of each of the others (including another grave in P 43:23) is followed by an asterisk, which means that it contained a stand most probably of shape C.366.810. The element of doubt may be due either to the fact that the specimen was not complete (i.e., Pl. 81 c) or that its record (field sketch or photograph) does not reveal all the elements of shape pertinent to our classification.

All funerary pottery is marked by a grave number. In another volume of this series,⁵ the burials will be described and the exact archeological context of the pottery in them will be discussed.

The date of a find-spot may of course in some instances be quite different from the date of the pottery specimens found in it.⁶ For example, a pot of form C.604.370 which is obviously of Protoliterate date was found in an ED II building.

Whenever a level is followed by a question mark it should be understood that though some doubt exists the possible range usually is not very great. Thus if a find-spot is Houses IV(?), Agade(?), one may assume that it may have been either Houses V or III, and thus the possible range of date is between Protoimperial and Gutium-Ur III times. In some cases the doubt can affect the dating only in one direction. For instance, if a Khafajah find-spot is Houses 7(?), ED I(?), one may assume that it may have been Houses 8 or 6. Only the latter would affect the dating by period (see Table III). Indeed, we can see that even a wider margin of error in one direction (Houses 8, 9, or 10) would not affect the supposed dating.

The information given in the remarks column includes field number, present location (B = Baghdad, Iraq Museum; C = Chicago, Oriental Institute Museum; P = Philadelphia, University Museum), cross-references, and occasionally a detailed description.

The *comparanda* from other Mesopotamian sites and from neighboring regions given in the last two columns are by no means exhaustive. Comparison does not imply similarity in all details and is made occasionally between specimens which differ somewhat in proportions or size and sometimes even to bring out certain differences rather than similarities. Comparison is not made on the basis of form alone if no similarity exists with regard to other features. On the whole, the comparisons refer to the specimens which are drawn rather than to designation numbers. However, if comparison with a specific specimen other than that which is drawn is intended, the reference is aligned with that particular specimen. When more than one parallel is given it may often be of interest to compare the other specimens not only with our own but also among themselves. The references are given as briefly as possible. Where only one publication has been quoted for a particular site, it is usually left unmentioned and reference is made to plate or figure only. The publications utilized are listed below according to sites.

⁵ *Private Houses and Graves in the Diyala Region.*

⁶ The relation between finds and archeological stratification has been discussed elsewhere (*Pre-Sargonid Temples*, pp. 4-5) and need not be repeated here.

Site	PUBLICATION	
	Abbreviation	Full Title
Abu Hatab	<i>Fara</i>	Heinrich, Ernst. <i>Fara. Ergebnisse der Ausgrabungen der Deutschen Orient-Gesellschaft in Fara und Abu Hatab 1902/03</i> (Berlin, 1931).
Arpachiyah, Tell		Mallowan, M. E. L., and Rose, J. C. "Excavations at Tall Arpachiyah, 1933," <i>Iraq</i> II (1935) 1-178; reprinted under title "Prehistoric Assyria" (London, 1935).
Assur		Andrae, Walter. Die archaischen Ishtar-Tempel in Assur (<i>WVDOG</i> XXXIX [1922]).
Babylon	Koldewey	Koldewey, Robert. Das wieder erstehende Babylon (4. Aufl.; Leipzig, 1925).
	<i>WVDOG</i> XLVII	Reuther, Oscar. Die Innenstadt von Babylon (Merkes) (<i>WVDOG</i> XLVII [1926]).
Badari		Brunton, Guy, and Caton-Thompson, Gertrude. The Badarian civilisation (London, 1928).
Billa, Tell	<i>MJ</i> XXIII	Speiser, E. A. "The pottery of Tell Billa," <i>MJ</i> XXIII (1932/33) 249-83.
Bismayah	<i>Bismya</i>	Banks, E. J. Bismya; or, The Lost City of Adab (New York and London, 1912).
	<i>AJSL</i> XXII	Banks, E. J. "Terra-cotta vases from Bismya," <i>AJSL</i> XXII (1905/06) 139-43.
Brak, Tell	<i>ILN</i> , Oct. 15, 1938	Mallowan, M. E. L. "Revelations of brilliant art in north-east corner of Syria over 4000 years ago," <i>ILN</i> , Oct. 15, 1938, pp. 697-701.
Dhahab, Tell	<i>Memnon</i> I	Herzfeld, E. "Untersuchungen über die historische Topographie der Landschaft am Tigris, kleinen Zâb und Gebel Hamrin," <i>Memnon</i> I (1907) 89-143.
Eridu		Thompson, R. Campbell. "The British Museum excavations at Abu Shahrain in Mesopotamia in 1918," <i>Archaeologia</i> LXX (1920) 101-44.
Farah	<i>Fara</i>	Heinrich, Ernst. <i>Fara. Ergebnisse der Ausgrabungen der Deutschen Orient-Gesellschaft in Fara und Abu Hatab 1902/03</i> (Berlin, 1931).
	<i>MJ</i> XXII	Schmidt, Erich F. "Excavations at Fara, 1931," <i>MJ</i> XXII (1931) 192-245.
Gaura, Tepe		Speiser, E. A. Excavations at Tepe Gawra. I. Levels I-VIII (Philadelphia, 1935).
Ghassul		See Tulailat Ghassul.
Grai Resh	<i>Iraq</i> V	Lloyd, Seton. "Some ancient sites in the Sinjar district," <i>Iraq</i> V (1938) 123-42.
Hamah		Ingholt, Harald. Rapport préliminaire sur sept campagnes de fouilles à Hama en Syrie (1932-1938) (K. Danske Videnskabernes Selskab. "Archaeologisk-kunsthistoriske Meddelelser" III 1 [København, 1940]).
Jamdat Nasr	Mackay	Mackay, Ernest. Report on excavations at Jemdet Nasr, Iraq (Field Museum of Natural History. "Anthropology, Memoirs" I 3 [Chicago, 1931]).
	<i>AJA</i> XXXIX	Field, Henry, and Martin, Richard A. "Painted pottery from Jemdet Nasr, Iraq," <i>AJA</i> XXXIX (1935) 310-20.
Khazinah, Tepe	<i>Mém.</i> VIII	Gautier, J.-E., and Lampre, G. Fouilles de Moussian (<i>Mém.</i> VIII [1905] 59-148).
Khorsabad	<i>OIP</i> XL	Loud, Gordon, and Altman, Charles B. Khorsabad. II. The citadel and the town (<i>OIP</i> XL [1938]).
Kish	"A"	Mackay, Ernest. Report on the excavation of the "A" cemetery at Kish, Mesopotamia (Field Museum of Natural History. "Anthropology, Memoirs" I 1-2 [Chicago, 1925-29]).
	<i>Kish</i> IV	Watelin, L. Ch., and Langdon, S. Excavations at Kish IV (Paris, 1934).
	Gen.	Genouillac, Henri de. Fouilles françaises d'el-Akhymer. Premières recherches archéologiques à Kish I-II (Paris, 1924-25).
	<i>JRAS</i> , 1930	Langdon, S. "Excavations at Kish, 1928-9," <i>JRAS</i> , 1930, pp. 601-10.
Makran		Stein, Sir Aurel. An archaeological tour in Gedrosia (Archaeological Survey of India. "Memoirs," No. 43 [Calcutta, 1931]).
Mari	<i>Syria</i> XVI	Parrot, André. "Les fouilles de Mari, première campagne (hiver 1933-34)," <i>Syria</i> XVI (1935) 1-28.
	<i>Syria</i> XIX	Parrot, André. "Les fouilles de Mari, quatrième campagne (hiver 1936-37)," <i>Syria</i> XIX (1938) 1-29.

SITE	PUBLICATION	
	Abbreviation	Full Title
Mohenjo Daro		Mackay, E. J. H. Further excavations at Mohenjo-Daro. II. Plates I-CXLVI (New Delhi, 1937).
Mostagedda		Brunton, Guy. Mostagedda and the Tasian culture (London, 1937).
Musyan, Tepe	<i>Mém.</i> VIII	Gautier, J.-E., and Lampre, G. Fouilles de Moussian (<i>Mém.</i> VIII [1905] 59-148).
Nineveh	AAA XIX	Thompson, R. C., and Hamilton, R. W. "The British Museum excavations on the temple of Ishtar at Nineveh," AAA XIX (1932) 55-116.
	AAA XX	Thompson, R. C., and Mallowan, M. E. L. "The British Museum excavations at Nineveh, 1931-32," AAA XX (1933) 71-186.
Nippur		Hilprecht, H. V. Explorations in Bible lands during the 19th century (Philadelphia, 1903).
al-Nish, Tell	<i>Iraq</i> V	Lloyd, Seton. "Some ancient sites in the Sinjar district," <i>Iraq</i> V (1938) 123-42.
Nuzi		Starr, Richard F. S. Nuzi. Report on the excavations at Yorgan Tepa near Kirkuk, Iraq, conducted by Harvard University in conjunction with the American Schools of Oriental Research and the University Museum of Philadelphia, 1927-31. II. Plates and plans (Cambridge, Mass., 1937).
Palestine	Duncan	Duncan, J. Garrow. Corpus of dated Palestinian pottery (London, 1930).
	<i>OIP</i> XXXIII	Guy, P. L. O., and Engberg, Robert M. Megiddo tombs (<i>OIP</i> XXXIII [1938]).
	Vincent	Vincent, Hugues. Canaan d'après l'exploration récente (Paris, 1907).
Shaghir Bazar, Tell	<i>Iraq</i> III	Mallowan, M. E. L. "The excavations at Tall Chagar Bazar, and an archaeological survey of the Habur region, 1934-5," <i>Iraq</i> III (1936) 1-86.
	<i>Iraq</i> IV	Mallowan, M. E. L. "The excavations at Tall Chagar Bazar, and an archaeological survey of the Habur region. Second campaign, 1936," <i>Iraq</i> IV (1937) 91-177.
Siyalk, Tepe		Ghirshman, R. Fouilles de Sialk, près de Kashan, 1933, 1934, 1937 I (Paris. Musée du Louvre. Département des antiquités orientales. "Série archéologique" IV [Paris, 1938]).
Susa	<i>Mém.</i> I, XIII, XX, XXV, XXIX <i>Antiquity</i> V	France. Délégation en Perse. Mémoires I (Paris, 1900), XIII (1912), XX (1928), XXV (1934), XXIX (1943). Mecquenem, R. de. "Excavations at Susa (Persia), 1930-1931," <i>Antiquity</i> V (1931) 330-43.
Telloh	<i>Encyclopédie</i> S	<i>Encyclopédie photographique de l'art</i> (Paris, 1935—). Sarzec, Ernest de. Découvertes en Chaldée. II. Partie épigraphique et planches (Paris, 1884-1912).
	C	Cros, Gaston. Mission française de Chaldée. Nouvelles fouilles de Tello (Paris, 1910-14).
	G	Genouillac, Henri de. Fouilles de Telloh I-II (Paris, 1934-36).
Tulaiat Ghassul		Mallon, Alexis, Koeppl, Robert, and Neuville, René. Teleilat Ghassul I (Institut biblique pontifical. "Compte rendu des fouilles, 1929-1932" [Rome, 1934]).
al-Ubaid		Hall, H. R., and Woolley, C. L. Al-Ubaid (<i>UE</i> I [1927]).
Uqair, Tell	<i>JNES</i> II	Lloyd, Seton, and Safar, Fuad. "Tell Uqair," <i>JNES</i> II (1943) 131-58.
Ur	<i>RC</i> <i>AJ</i> X	Woolley, C. L. The royal cemetery (<i>UE</i> II [1934]). Woolley, C. L. "Excavations at Ur, 1929-30," <i>AJ</i> X (1930) 315-43.
Warka	<i>UVB</i> IV (1932), VI (1935), IX (1938), X (1939)	Deutsche Forschungsgemeinschaft, Berlin. . . vorläufiger Bericht über die von der Notgemeinschaft der Deutschen Wissenschaft in Uruk-Warka unternommenen Ausgrabungen (Preussische Akademie der Wissenschaften. Philos.-hist. Klasse. "Abhandlungen" [Berlin]).

POTTERY FORMS BY PERIODS

A MINUS sign (–) before a shape number indicates that the shape occurs earlier, a plus sign (+) that it occurs later, and a plus-or-minus sign (±) that it occurs both earlier and later. A shape whose number is not preceded by a sign is thus limited to one period in our finds. Signs printed in boldface type imply doubt as to whether the forms in question appeared earlier or later or both, as the case may be. A question mark after a shape number indicates doubt as to whether the form was present in the period in question but does not refer to the sign which may precede the number. Italics are used here, as in the text, to indicate doubtful elements of the shapes.

PROTOLITERATE *c*

A.514.260	B.513.170	C.305.400	+C.534.262	C.634.253
A.527.760	B.533.262	C.413.253 <i>a</i>	C.534.620	C.634.373
A.604.223	B.544.222	C.413.253 <i>b</i>	+C.535.240	C.634.453
A.633.263	B.544.240	C.413.253 <i>c</i>	C.535.242	C.654.240
	B.544.521	C.414.253	C.536.270	C.654.242
+B.003.200 <i>b</i>	B.546.242	C.49-.53	C.537.240	+C.654.520
B.023.700	B.603.240	C.493.253	C.544.222	C.655.222
B.034.203	B.634.220	C.494.253	C.544.520	C.665.222
+B.041.500	B.653.240	C.494.273	C.544.540	C.702.253
+B.085.200	B.703.240	C.513.270	C.546.222	C.743.510
B.413.253		+C.515.262	C.546.240	+C.95
B.414.270	C.002.210	C.515.265	C.603.253 <i>a</i>	
+B.455.253	+C.041.500	C.516.270	C.603.253 <i>b</i>	D.545.626
B.493.253	+C.200.210	+C.534.222	C.603.270	D.665.542

PROTOLITERATE *d*

+B.023.200	B.643.520	+C.516.273	C.603.253	+C.802.200
+B.042.500 <i>a</i> ?	+B.654.520	+C.516.370	C.603.340	C.806.610
B.063.200 <i>a</i>	B.757.605	C.524.262	C.604.353	+C.96
B.064.200		+C.533.313?	+C.604.370	
+B.084.200?	+C.003.200	-C.534.222	C.605.340	+D.515.370
B.454.270?	-C.041.500?	C.534.240	C.654.222	+D.524.370
-B.455.253	C.045.700	-C.535.240	+C.654.540	D.544.340?
B.466.260	C.084.200 <i>a</i>	C.536.540	C.655.510	
B.514.560	C.084.200 <i>b</i>	C.537.270	C.655.540	E.204.010
B.516.273	C.412.253?	C.545.342	C.744.220	
+B.545.240 <i>b</i>	C.514.262	+C.546.320	C.744.340	
+B.546.220	C.515.370	C.554.520	C.745.270	
B.546.223	+C.515.373?	C.603.200	C.753.510	

PROTOLITERATE *d* OR EARLY DYNASTIC I

B.071.500

EARLY DYNASTIC I

A.513.260	+B.003.210 <i>b</i>	B.077.700 <i>a</i>	B.224.443	B.526.360
+A.515.270	B.007.700	B.077.700 <i>b</i>	B.416.260	B.533.252
A.516.270	B.022.200	B.077.700	B.514.270?	B.535.320
A.704.220	+B.023.210	+B.083.200	+B.515.220	B.544.541
A.753.200	-B.041.500	-B.084.200	B.516.263	+B.545.220 <i>c</i>
	+B.042.200	±B.085.200	+B.516.270	±B.545.240 <i>b</i>
+B.002.200 <i>a</i>	+B.042.500 <i>a</i> ?	B.086.700	B.524.270	B.545.520
B.002.500	+B.043.200 <i>a</i>	B.087.700	B.524.271	±B.546.220
±B.003.200 <i>b</i>	B.072.210 <i>a</i>	B.111.210	B.525.270	+B.556.520
B.003.210 <i>a</i>	B.076.700	B.183.210	B.526.273	B.604.270

EARLY DYNASTIC I

B.625.521	-C.200.210	-C.516.273	-C.534.262	+D.515.362
-B.654.520	C.206.400	+C.516.362	C.534.313	±D.515.370
B.656.220	C.225.310 _a	-C.516.370	+C.535.222	D.515.373
B.663.540 _a	C.236.010	C.516.372	C.544.310	D.516.363
B.664.520 _b	C.3- .0- -	C.516.373	+C.545.220	D.516.371
B.664.540 _b	C.3- .063	C.517.262	C.545.222	+D.525.370
B.664.570	C.35- .0- - _b	C.517.273	C.545.242	D.525.371
+B.665.520	C.357.010	C.524.362	+C.545.320	D.526.370 _b
+B.666.540 _a	C.357.073	C.525.262 _a	C.545.322	D.526.371
B.666.620	C.405.362	C.525.262 _b	C.546.620	D.526.373
B.754.540	C.416.370	C.525.262 _c	C.554.220	D.535.322
B.834.203	C.417.262	C.525.362 _a	C.555.353	D.535.342*
	C.455.353	+C.525.362 _b	C.555.520	+D.535.542
+C.002.200	C.456.353	+C.525.370 _a	C.556.242	D.544.240
-C.003.200	C.486.320	+C.525.370 _b	C.557.620	D.544.353?
C.014.300	C.505.353	C.525.373	C.594.220	D.544.540
C.014.310	C.514.353	C.526.262 _a	C.605.240	D.545.222
C.023.200	C.514.362	C.526.262 _b	C.663.540	D.545.320
C.031.200	+C.514.370 _a	C.526.353	C.666.520	D.545.322
+C.032.200	C.514.370 _b	C.526.362 _a	C.754.440	+D.545.542
C.032.210	C.514.370	+C.526.362 _b	±C.802.200	
C.041.200	C.514.540	C.526.370		E.05- .- - -
+C.044.310	-C.515.262	+C.526.371	D.032.300	E.588.000?
C.063.200	C.515.362	C.526.373 _a	D.504.353 _a	
C.073.200	+C.515.370 _{a-b}	C.526.373	D.504.353 _b	
+C.077.500	-C.515.373	+C.526.460	D.514.370 _a	
C.086.200	C.516.262	-C.533.313?	D.514.370 _b	

EARLY DYNASTIC II

A.014.700	+B.524.570	B.664.520 _c	+C.364.810 _b	C.556.362
+A.493.263	+B.525.220	+B.664.540 _a	+C.365.810 _a	C.557.422
A.525.273	B.525.322	±B.665.520	C.366.810	C.565.360
A.645.510	+B.525.670	B.665.540	C.367.810	C.596.362
+A.645.720	B.526.270	+B.675.220 _b	C.39- .0- -	-C.604.370†
	B.533.230	B.756.720	+C.404.362	C.654.510
+B.001.200 _a	+B.534.520	B.806.570	C.505.320	-C.654.540
±B.002.200 _a	+B.535.220	B.807.570	C.506.371	C.655.340 _b
-B.003.200 _b	B.536.220	+B.816.521 _a ?	C.506.470 _a	+C.664.640
-B.003.210 _b	B.536.520	B.882	-C.514.370 _a	C.861
+B.003.700	+B.544.560		C.515.270	±C.95§
-B.023.200	B.545.220 _a	-C.002.200	+C.515.370 _a	±C.96
B.025.210	+B.545.220 _b	C.012.200	C.515.371	C.99
+B.032.500?	±B.545.220 _c	C.044.200	-C.516.362	
B.033.200	B.545.240 _a	+C.052.202	+C.516.371 _b	-D.515.362
+B.033.210	-B.545.240 _b	-C.077.500	+C.516.470	-D.515.370
B.047.700	+B.545.540	C.082.200	C.524.350	D.516.362
B.075.210	+B.545.640 _a	C.082.210	-C.525.362 _b	-D.524.370
+B.082.210?	±B.546.220	+C.201.200	±C.525.370 _a	+D.525.362
±B.083.200	B.546.520	C.234.000	-C.525.370 _b	-D.525.370
B.123.200	B.546.620	C.235.370	C.525.460	-D.535.542?
B.203.510	B.556.220	C.35- .0- - _a	C.526.262 _c	D.545.342
+B.236.000	±B.556.520	C.353.010 _b	±C.526.362 _b	+D.565.310
+B.356.000	B.566.560	C.354.000	+C.526.371 _a	D.566.370
B.357.000	B.573.220	C.355.010	±C.526.371	D.743.310
B.406.462	+B.575.223?	+C.356.000	C.544.320	
B.416.371	+B.576.220	C.356.010	-C.545.220	E.084.310
B.485.220	+B.601.530	C.357.000 _b	±C.545.320	E.205.310
B.486.220	+B.644.520	C.357.000	+C.545.340 _b ?	+E.225.310
B.494.570	B.652.500	C.357.010 _a	+C.545.640	+E.232.010
B.495.220	B.663.213†	C.357.010 _b	C.546.262	+E.235.010
B.514.572	+B.663.540 _b	C.358.010	C.546.362	E.800.201
-B.516.270	B.664.520 _a	+C.364.810 _a	C.555.921	

* Undoubtedly a Protoliterate survival; see p. 46.

† Though found in ED II context, this vessel must be considered a survival from the Protoliterate period; see p. 39.

‡ Protoliterate survival; see p. 48, n. 75.

§ Possibly Protoliterate survival; see p. 44.

POTTERY FROM THE DIYALA REGION

EARLY DYNASTIC II OR III

A.305.700	B.022.210	C.026.410
A.402.200	B.062.210b	C.545.420
	B.067.700	

EARLY DYNASTIC III

A.001.300	+B.024.210	B.516.371a	B.656.520	C.475.370
A.002.500	B.031.500?	+B.516.371b	-B.663.540b	C.503.470
+A.010.203	+B.032.200a	B.516.371c	±B.664.540a	C.504.360
A.014.101?	±B.032.500	B.516.471a	B.666.540b	C.504.367
A.014.703	-B.033.210	B.516.471b	B.666.640	C.504.370
A.035.600	B.033.700a	-B.524.570	B.675.220a	C.505.360
A.041.503?	B.033.700b	-B.525.220	-B.675.220b	C.505.370a
+A.044.600	B.033.700c	-B.525.670	+B.703.560	C.505.370b
A.053.700	B.041.503	B.534.220	B.743.510	C.505.370c
A.175.122?	-B.042.200	-B.534.520	B.755.520	C.505.470
A.186.400	B.043.210c	B.535.221	B.756.521	C.506.470b
A.202.200	B.043.500	B.535.223	±B.816.521a	C.506.470c
A.224.200	B.043.503	B.535.240	+B.816.521b	C.506.470d
A.235.203?	B.044.210	B.535.610	+B.816.521c	C.514.350
A.243.900a	B.052.503	B.544.520	B.816.521	C.515.361
A.243.900b	B.060.210?	-B.544.560		-C.515.370a
A.415.273	B.063.200b	B.544.570	C.002.500	-C.515.370b
A.424.363	+B.072.200	±B.545.220c	C.011.201a	C.515.463
A.446.830	B.073.210	B.545.5-1	C.011.201b	C.515.870
A.475.120?	B.081.210	-B.545.540	C.012.203	+C.516.240
-A.493.263	B.082.200	-B.545.640a	C.013.210	-C.516.371b?
A.494.520	+B.082.210?	B.545.640b	C.022.300?	-C.516.470?
A.505.450	-B.083.200	B.546.122	-C.032.200	C.516.471
A.514.270	B.083.210a	B.546.640a	C.032.304	C.517.371
A.514.733	B.083.210b	B.546.640c	C.042.204	C.525.352
+A.515.370	B.083.210c	B.555.220	-C.052.202	C.525.370c
A.516.151	B.084.210b	B.555.520	C.053.200	C.525.462
A.516.320	B.084.210c	B.555.540a	C.075.404	C.525.470a
A.516.373	B.084.710a	B.556.420?	C.082.310?	C.525.470b
A.545.522	+B.084.710b	B.556.422?	C.083.200	C.525.471
A.545.540	B.085.210	-B.556.520	C.084.310	-C.526.362b
A.545.620	B.086.210	B.564.371?	+C.111.310b	-C.526.371a
A.546.630?	B.087.210	B.574.220a	+C.142.310	C.526.371b
A.556.320	B.172.210	B.574.220b	-C.201.200	-C.526.371?
A.556.640	+B.174.220c	B.574.220c	+C.201.203	C.526.373b*
A.557.320	B.175.220a	B.575.220	C.202.203	-C.526.460
A.573.200	B.175.220b	-B.575.223	C.213.210	+C.526.471a?
A.576.822	+B.175.221	+B.575.224	+C.215.210	C.526.471b
A.604.270	B.175.224	B.575.225	C.226.220?	C.526.471c
A.625.5--	B.176.224a	B.575.240	C.236.210	C.526.471e
-A.645.720	B.176.224b	-B.576.220	C.352.000	C.526.471f
A.652.500?	B.184.220b	B.596.520	C.352.010	C.527.362
A.654.520	+B.184.220c	B.601.230	C.353.010a	-C.536.222
A.654.523	B.185.224	-B.601.530	C.353.010	C.536.520
A.654.543	-B.236.000	B.603.570	C.354.010	C.545.310
A.654.720	B.306.503	B.613.270?	-C.356.000	-C.545.320
A.655.220	B.311.220	B.625.260?	C.357.000a	C.545.340a
+A.655.520a	-B.356.000	+B.633.570a	C.363.810a	-C.545.340b
+A.655.520b	B.406.460	+B.633.570b	+C.363.810b	+C.545.340d
A.656.720	B.416.373?	B.634.570a	-C.364.810a	C.545.520
A.754.500	B.445.350	+B.634.570b	-C.364.810b	-C.545.640
A.765.500	B.454.642	B.634.570c	-C.365.810a	+C.546.540
A.96	+B.466.470	+B.635.670a?	+C.365.810b	C.555.420
	B.505.571	+B.645.220	C.365.810c	C.555.423
	B.514.570	+B.645.224	C.365.810d	C.555.520
±B.002.200a	-B.515.220	B.645.540b	+C.365.810	C.555.522
+B.002.200b	B.515.363?	B.646.224	+C.404.350	+C.556.320
B.003.200a	B.515.373?	B.652.520?	-C.404.362	+C.556.322
-B.003.700	B.515.470	B.655.520	C.405.363	C.556.420
B.016.200	B.516.271	B.655.540a	C.406.370	C.556.440
-B.023.210?				

* Possibly survival from ED I; see p. 57.

EARLY DYNASTIC III

C.556.540	C.655.370a	C.754.521	D.514.362	D.565.310
C.556.640	C.655.370b?	C.756.520	-D.525.362	D.80-.-.-
C.557.470	C.655.370c	C.803.200	+D.526.370a	
C.565.340	C.655.460	C.805.200	-D.526.371	±E.225.310
+C.565.540?	+C.656.540?	-C.95?	-D.535.542?	-E.235.010
+C.596.440b?	C.665.323?	±C.96	-D.545.542	E.235.310
C.606.620?	C.665.341		+D.546.540b	E.303.010
C.653.620	C.665.543a	+D.201.201b	D.555.340?	
C.654.503	+C.665.543c	D.307.010	+D.555.510b	
±C.654.520	C.686.420	+D.465.360	D.556.540a	
C.655.340a	C.686.443	D.494.470	D.556.540b	

EARLY DYNASTIC III OR PROTOIMPERIAL

B.203.203	B.514.373	B.635.670b
-----------	-----------	------------

PROTOIMPERIAL

-A.010.203	-B.082.210?	±B.634.570b	±C.215.210	C.587.862
A.021.201	-B.084.710b	-B.635.670a?	+C.216.210	C.596.440a?
-A.044.600	-B.085.210	B.636.570	C.233.100	-C.596.440b
A.303.503	B.174.210a	B.644.322?	+C.257.210	C.646.422
A.475.210	B.174.210b	-B.645.220	C.303.200	C.653.520
-A.515.270	±B.174.220c	B.655.212	-C.363.810b?	-C.654.520
-A.515.370	-B.175.221	B.655.540b	-C.365.810b?	-C.656.540?
A.524.260	+B.184.220a	+B.663.520	-C.365.810?	C.665.541
A.555.320	-B.184.220c?	-B.665.520	-C.404.350?	C.665.543b
A.556.500?	+B.185.220	B.676.422	C.406.340?	-C.665.543c
A.556.520	B.225.540	-B.703.560	+C.466.370	+C.665.543d
A.565.610	+B.256.200	B.704.570	+C.466.450?	C.665.621
A.604.560	B.435.262?	B.741.300	+C.466.470	C.743.570
A.654.920	B.505.250	B.754.220	C.466.570	+C.757.540
-A.655.520a	-B.516.371b?	B.755.540	C.476.350?	-C.802.200?
A.756.520	B.516.473	-B.816.521a	C.477.350?	C.805.210
A.785.520	B.526.471	-B.816.521b	C.486.222?	±C.96
	±B.535.220	-B.816.521c	C.516.371a	
±B.001.200a	+B.545.222a?		-C.525.370a?	±D.201.201b
B.001.310	B.546.322	+C.001.200a	C.525.550	+D.333.250
-B.002.200a	+B.546.640b	C.003.203?	-C.526.471a?	-D.465.360
±B.002.200b	B.555.224	+C.042.200	C.526.471d?	D.465.460?
±B.024.210	+B.555.540b	C.042.203	C.527.471?	+D.465.550
B.031.510	B.556.222	+C.053.312	+C.544.312	+D.466.360
+B.032.200b	B.566.670	C.072.200	C.546.340	+D.546.540b
+B.041.710	+B.573.240	±C.142.310	-C.546.540	±D.555.510b
B.054.700	±B.575.224	-C.201.203	+C.546.640	+D.596.540?
B.064.210	B.576.221	C.204.210	±C.556.322	D.654.310
-B.072.200	B.576.224	C.206.410	C.557.640	+D.656.540
+B.072.210b?	±B.633.570a	+C.213.200	±C.565.540	+D.801.201?

AGADE

A.237.823?	±B.032.200b?	B.185.260?	B.574.240	-C.053.312
A.303.423	B.041.200	+B.255.200	±B.575.224	C.064.300?
A.506.860?	-B.041.710?	±B.256.200	-B.633.570a	+C.111.210
A.515.660	-B.042.500a	-B.466.470	-B.634.570b	C.211.200
A.535.220	B.042.500b	B.493.663?	B.644.220	-C.213.200?
A.544.212	B.043.210b	+B.526.260	-B.644.520	-C.216.210
A.544.520	+B.061.210?	+B.527.340	-B.645.224	C.245.300
A.624.520	-B.072.210b	±B.535.220	B.654.523	C.246.210
+A.624.563?	B.084.210a	+B.536.224?	B.655.640	-C.466.370
+A.653.540	-B.085.200?	B.543.520	-B.664.540a	-C.466.450
A.831.203	+B.151.210	+B.544.540?	-B.666.540a	±C.466.470
	B.173.222	-B.545.220b	B.786.520?	C.467.350?
+B.001.200b?	±B.174.220c	+B.546.222?		C.475.360
B.011.200	B.176.220b	-B.546.640b	±C.001.200a	C.477.270
-B.024.210	±B.184.220a	-B.555.540b	C.001.210	C.515.561?
-B.032.200a	-B.185.220	B.556.540	±C.042.200	-C.516.240

POTTERY FROM THE DIYALA REGION

AGADE

± C.544.312	C.646.222	D.022.410	-D.546.540b	+D.800.200
-C.546.640	C.657.522	±D.201.201b?	D.555.510a	-D.801.201
C.547.242	-C.664.640	-D.333.250	-D.555.510b	
-C.556.322	-C.665.543d	-D.465.550	D.555.540	+E.313.040
C.557.372	-C.757.540	-D.466.360	-D.596.540	
-C.565.540	C.777.340	-D.526.370a	-D.656.540	
C.566.350	-C.96	D.546.540a	D.755.543	

AGADE OR LATE GUTIUM-UR III

B.123.210	C.555.440
	C.657.242

LATE GUTIUM-UR III

A.026.200	+B.031.200	B.536.240b	+B.706.360	C.555.510?
A.032.503?	±B.032.200b	-B.544.540?	B.813.522	
A.055.100	-B.043.200a	-B.545.222a		D.201.201a
A.151.210	+B.043.200b	B.545.222b	-C.042.200	±D.201.201b
A.545.360	±B.061.210	+B.545.240c?	-C.111.210?	+D.556.640
-A.624.563?	±B.151.210	-B.546.222?	C.111.310a	D.800.102
A.644.520	B.174.220a	-B.573.240	±C.142.310?	
±A.653.540	-B.174.220c	-B.633.570b	-C.257.210	+E.202.010
	-B.184.220a	B.645.420	C.427.570	E.208.010
+B.001.200b?	±B.256.200	B.645.540a	-C.466.470	E.257.010
-B.002.200b	-B.536.224	-B.663.520	-C.544.312	E.313.020

LATE GUTIUM-UR III OR LARSA

B.052.200b	B.062.200
------------	-----------

LARSA

A.002.203	B.204.200?	-B.527.340	C.031.300?	C.558.320
A.002.600?	B.206.423a	B.527.360	+C.043.310	C.576.242?
A.111.210	B.206.423b	B.527.462	C.043.510	C.655.240
A.444.250?	B.206.423c	-B.535.220	-C.044.310?	C.656.340
A.527.462	B.206.423d	B.536.240a	C.053.212	C.757.340
+A.545.320	B.206.423e	B.536.270	-C.111.310b?	C.758.510
+A.556.423	B.207.310a	-B.545.220c	-C.142.310	C.787.340
A.586.462	B.207.310b	-B.545.240c	C.175.720	-C.96
A.604.520	B.226.720a	-B.546.220	C.201.205?	C.98
-A.653.540	B.226.720b	+B.546.240	C.206.310?	
A.655.120	+B.226.720c	B.546.260	C.206.510	D.044.510
-A.655.520b?	+B.236.200a	B.546.370	+C.208.320	-D.201.201b?
A.656.700	B.236.200c	B.556.471	C.208.440	D.301.112
A.663.520	B.236.300	-B.575.224?	-C.215.210	D.495.520
A.666.422	B.237.100	B.577.420?	C.226.540	D.525.670
A.758.540?	B.237.200	B.644.540	C.228.340a	D.545.640
	B.246.200a	+B.644.720	C.246.310	-D.556.640
-B.001.200b	B.246.200b	B.646.340	C.247.500	-D.800.200
±B.031.200	B.246.500	B.646.710	C.447.360	
-B.032.200b?	B.247.200	B.656.320	C.467.560	E.062.210
-B.032.500	B.247.700	B.664.540c	C.485.220	-E.202.010
-B.043.200b?	-B.255.200	-B.706.360	C.507.570	E.223.000
B.043.210a?	-B.256.200?	B.717.700	C.545.340c?	E.223.010
B.052.200a	B.446.262	B.756.220	-C.545.340d	-E.225.310
B.052.200c	B.475.250a	B.766.320a	C.545.440	E.229.010
B.052.202?	B.475.250b	B.787.320a	-C.546.320	-E.232.010
-B.061.210	B.505.270a	B.787.320b	+C.547.320	E.244.310
B.062.210a	B.505.270b	+B.788.320	C.547.640a	E.313.010
B.140.210	B.506.270a	B.812.542	C.547.640b	-E.313.040
-B.151.210	B.506.270b	B.852	+C.547.720	E.314.010
B.174.220b	B.506.270c		C.548.720	E.544.310
B.175.720	B.506.370	-C.001.200a?	C.555.320	E.655.000
B.176.220a	-B.526.260	C.001.200b	-C.556.320?	

POTTERY FORMS BY PERIODS

161

LARSA OR OLD BABYLONIAN

A.043.210	B.032.210	B.647.240	C.044.210	C.635.360
A.706.520	B.174.740	B.705.370	C.176.720	C.756.340
	B.175.760	B.766.320b	C.228.340b	
B.001.200a	B.236.200b		C.557.170	

OLD BABYLONIAN

-A.545.320?	-B.236.200a?	B.576.720b	-C.043.310?	-C.547.720
-A.556.423?	-B.546.240?	-B.644.720?	-C.044.310?	-C.556.320?
	B.546.720	B.656.720	-C.208.320?	C.585.320
-B.031.200?	B.547.320	B.757.320	C.225.310b	C.606.320
B.041.900	B.556.720	-B.788.320?	C.493.360?	C.665.740
-B.226.720c	B.576.720a		-C.547.320?	

CATALOGUE OF ILLUSTRATED SHERDS
AND OTHER CLAY OBJECTS

Pl.	Field No. or Site	Square, Locus, or Area	Building or Level	Date of Find-Spot	Remarks	Museum*
4	Kh. IX 49	Q 42:39	Below Sin I	Protolit. <i>c</i>	See Pl. 17 <i>d</i> and pp. 34 f.	P
4	Kh. IX 198	P 43:51	(Sin III)	"	See Pl. 31 <i>a</i> and p. 46	P
4	Ag. 36:520	Hill B, room VII	Top layer	ED I	See Pl. 53 <i>c</i> and p. 63	C
4	Ag. 36:526	Hill B, room X	"	"	See Pl. 53 <i>d</i> and p. 63	B
17 <i>a</i>	Ag. 36:437	Unknown	Surf.		Ubaid ware; see p. 29	C
17 <i>b</i>	Kh. IX 235	Q 42	(Below Sin I)	Protolit. <i>c</i>	"	P
17 <i>c</i>	Kh. VII 16	O 43:40	(Sin I or II)	"	Ubaid clay sickle frag.; see p. 29	C
17 <i>d</i>	Kh. IX 49	Q 42:39	Below Sin I	"	See Pl. 4 and pp. 34 f., 42	P
17 <i>e-l</i>	Kh.	P 42:28	(Below Sin I)	"	See pp. 34 f.	
17 <i>m</i>	Kh. VII 67	P 42:50	(Sin II)	"	See p. 36	C
20 <i>b</i>	Ag. 36:511	Tell Khubair	Surf.	Protolit. ?	See p. 38	C
20 <i>c</i>	Kh.	P 42:24	(Sin II)	Protolit. <i>c</i>	See pp. 38, 134	
31 <i>a</i>	Kh. IX 198	P 43:51	(Sin III)	"	See Pl. 4 and pp. 46, 127	P
31 <i>b</i>	Kh. VII 131	Q 42:16	Sin IV	Protolit. <i>d</i>	See pp. 47, 127	B
31 <i>c-c'</i>	Kh. VII 130	"	"	"	"	C
42 <i>b</i>	Ag.	Hill B	Top layer	ED I	See p. 54	
42 <i>e</i>	"	"	"	"	See Pl. 65:36 and p. 54	
42 <i>g-h</i>	"	"	"	"	See p. 54	
43 <i>a-d</i>	Kh.	P 43	Houses 9 or 8	"	See p. 54	
43 <i>e-f</i>	"	"	"	"	See pp. 53, 54	
43 <i>g-i</i>	"	"	"	"	See p. 54	
45 <i>i</i>	As. 33:675	D 17:11	Archaic Shrine IV	"	See p. 56	
48 <i>f</i>	Kh. V 160 <i>b</i>	R 42:9	Sin VII	"	See p. 58	B
48 <i>g</i>	Kh. V 160 <i>a</i>	"	"	"	"	C
48 <i>h</i>	Kh. V 23 <i>b</i>	N 43:2	Houses 3	ED III	ED I survival? See p. 58	C
48 <i>i</i>	Kh. V 23 <i>a</i>	"	"	"	"	C
51 <i>b</i>	Ag. 36:565	M 14:15	30.50 m.	ED I	See Pl. 65:38 and pp. 42, 60	B
51 <i>c</i>	Ag. 36:569	"	"	"	See Pl. 65:80 and p. 60	B
51 <i>d</i>	Kh. I 468 <i>e</i>	K 43:3	Oval II	ED III	See pp. 60, 102	
53 <i>a</i>	Ag. 36:522	Hill C, sherd pavement of room I, II, or IV	Top layer	ED I	See Pl. 135 <i>d</i> and p. 61	C
53 <i>b</i>	Ag. 36:527	"	"	"	See Pl. 135 <i>c</i> and p. 63	C
53 <i>c</i>	Ag. 36:520	Hill B, room VII	"	"	See Pl. 4 and p. 63	C
53 <i>d</i>	Ag. 36:526	Hill B, room X	"	"	"	B
58 <i>a-b</i>	Ag. 36:528	Hill C, room II sherd pave- ment	"	"	See Pl. 137 <i>b-c</i> and p. 67	C
58 <i>c</i>	Ag. 36:523	Hill C, sherd pavement of room I, II, or IV	"	"	See Pl. 137 <i>f</i> and p. 68	C
58 <i>d-e</i> 63-65	Ag. 36:525 <i>a-b</i>	Hill C	"	"	See Pl. 137 <i>d-e</i> and p. 68 See pp. 73-79	C

* B=Baghdad, Iraq Museum; C=Chicago, Oriental Institute Museum; P=Philadelphia, University Museum.

CATALOGUE OF ILLUSTRATED SHERDS AND OTHER CLAY OBJECTS 163

Pl.	Field No. or Site	Square, Locus, or Area	Building or Level	Date of Find-Spot	Remarks	Museum
71 b	Kh. V 45	N 43:15	Houses 4	ED II	See pp. 82, 142 (n. 104)	C
80 c	Kh. III 237	O 44:7	Houses 2	ED III	See p. 88	B
86 a	Kh. III 218	P 45:12, dump			See p. 88	
86 b	Kh. III 662	K 42:8	Houses 4	ED II	See p. 89	
86 c	Kh. I 30	R 45	1.30 m. below surf.	ED III	"	
86 d	Kh. I 447	K 43:3	Oval I	ED II	"	
86 e	Kh. I 505	L 43:3	Oval II	ED III	"	
86 f	Kh.	Mound A		"	"	
86 g	Kh. I 90	R 45	Surf.	"	"	C
86 h	Kh.	Mound A		"	"	
86 i	Kh. III 171	P 45:8	Houses 2	"	"	
86 j	Kh. III 39	O 44:1	"	"	"	
86 k	Kh. III 286	Q 43:2	"	"	"	
86 l	Kh.	Mound A		"	"	
86 m	As. 32:1043	H 20:20	Houses V a	Protoimp.	See pp. 89, 105	
86 n	Kh.	Mound A		ED III	See p. 89	
86 o	"	P 43:33, grave 83	Houses 7?	ED I	See p. 89; belongs to jar of form C.526.371	
86 p	"	P 43:23	Houses 6-3	ED II or III	See p. 89	
86 q-r	"	Mound A		ED III	"	
87 a	Kh. III 172	L 43:1	Oval II	"	See p. 89	
87 b	Kh.	Mound A	Surf.	"	"	
87 c	As. 31:609a	H 18:14	Houses IV a-II	Agade or later	"	C
87 d	Kh.	Mound A	Surf.	ED III	"	
87 f	Kh. I 312	O 44:15	Houses 2	"	"	C
87 g	Kh.	Mound A	Surf.	"	"	
87 h	As. 31:380b	W. of E 16:2	N. Palace	Protoimp. or Agade	"	C
87 i	Kh. I 66	P 45	Surf.	ED III	"	C
87 j	Kh. IX 237	O 50:1, grave 146	Houses 2	"	See p. 89; belongs to jar of form C.516.471	P
87 k	Kh. I 559	L 42	Surf.	"	See p. 89	C
87 l	As. 32:427	H 19:30	Houses IV a	L. Agade	"	
87 m	As. 32:1041	H 20:20	Houses V a	Protoimp.	See pp. 89, 105	
87 n	As. 31:380a	E 15:3	N. Palace	"	"	C
87 o	As. 32:1042	H 20:20	Houses V a	"	"	
87 p	Kh. IX 236	Q 51	Houses 1?	ED III	See p. 89	P
87 q	Kh. IX 238	S 41	Houses 2?	"	"	B
89 a	Kh. I 300	N 45:3	Oval II or III	"	See p. 91	
89 b	Kh. I 294	O 45:8	Oval II	"	"	
89 c	Kh.	Mound A	Surf.	"	"	
89 d	Kh. I 156	P 45	"	"	"	
89 e	Kh. I 205	P 44:16	Houses 2 or 1	"	"	
89 f	Kh. I 378	L 47	Oval II or III	"	"	
89 g	Kh. I 493	L 43:9	Oval II	"	"	
89 h	Kh. I 9e	R 45	Surf.	"	"	
89 k	Kh. I 9f	"	"	"	"	
91 b	Kh.	Mound A	Houses 6	ED II	See pp. 81, 92	
91 c	Kh. III 132	O 44:7	Houses 2	ED III	See p. 92	
91 d	As. 31:732a	N. of E 17:1	Surf.	Agade?	"	C
92 a	As. 33:462	D 17:11	Archaic Shrine IV	ED I	See pp. 53, 92	
92 b	As. 33:518	D 17:13	Square Temple	ED II	See pp. 81, 92	
92 c	As.	H 18:14	22-21 m.	Protolit. d	See Pl. 64:60 and pp. 38, 77, 92	
92 d	As. 33:609	E 16:45	Archaic Shrine IV	ED I	See pp. 53, 92	
92 e	As. 31:P.19b	N 33:7	Ibiqadad II	L. Larsa	See p. 92	C

POTTERY FROM THE DIYALA REGION

Pl.	Field No. or Site	Square, Locus, or Area	Building or Level	Date of Find-Spot	Remarks	Museum
92 <i>f</i>	As. 34:177	E 17:31	Archaic Shrine II	ED I	See pp. 53, 92	C
92 <i>g</i>	Kh. I 222	P 45	Surf.	ED III	See p. 92	
92 <i>i</i>	As. 30:P.19c	S. of F 16:3	"	Larsa	"	C
92 <i>j</i>	As. 31:P.19d	K 43	"	"	"	C
92 <i>k</i>	As. 30:P.19e	W. of Q 33:16	Ibiqadad II or below	L. Larsa	"	C
95 <i>a</i>	Kh. III 1370a	P 45:14	Houses 2?	ED III	See pp. 94, 143	B
95 <i>b</i>	Kh. III 1370b	"	"	"	"	C
95 <i>c</i>	Kh. III 141	Mound A	Surf.	"	See pp. 94, 143	
95 <i>d</i>	Kh. III 970	P 45:14	Houses 2?	"	"	
105 <i>h</i>	As. 31:P.54	E 16:1	Above N. Palace	Protoimp.?	See pp. 102, 105	C
105 <i>i</i>	As. 31:P.55	G 19	Surf.	Agade?	See p. 102	B
106 <i>b</i>	Kh. I 69b	P 45	"	ED III	See p. 102	
106 <i>c</i>	Kh. I 69a	"	"	"	"	
106 <i>d</i>	Kh. I 58	"	"	"	"	
106 <i>e</i>	Kh. I 3	N 75	"	Larsa?	See pp. 102, 121	
106 <i>f</i>	Kh. I 29	R 45	Houses 3 or 2	ED III	See p. 102	
106 <i>g</i>	As. 31:850	Gimilsin Temple	Bilalama	E. Larsa	"	C
106 <i>h</i>	Kh. I 322	P 45	Surf.	ED III	"	
106 <i>i</i>	Kh. I 210	"	Houses 2?	"	See p. 103	
106 <i>j</i>	Kh. III 325	K 42:2	Houses 3	"	See p. 103	
106 <i>k</i>	Kh. I 246	P 45	Surf.	"	"	
106 <i>m</i>	Kh. I 71	Q 45	"	"	"	
110 <i>a</i>	Kh. I 72a	P 45	"	"	See p. 91	
110 <i>j</i>	Kh. I 72b	"	"	"	"	
112 <i>f</i>	As. 33:680	J 19, arch house	Houses V a	Protoimp.	See Pl. 139 b and pp. 65, 108, 147	C
114 <i>a</i>	As. 32:131	J 19:13	Houses IV a	L. Agade	See p. 109	C
122 <i>e</i>	As. 31:610	L 31:5	Bilalama or below	E. Larsa	See pp. 119-20	C
123 <i>a</i>	As. 31:472d	L 30:1	Urninmar pit	"	"	C
123 <i>b</i>	As. 31:472	L 32:2	Above Bilalama	"	"	B
123 <i>c</i>	As. 31:P.160	F 17:1	Houses above N. Pal- ace	Gutium-Ur III?	"	
123 <i>d</i>	As. 31:526	M 33:4	Ibiqadad II or below	L. Larsa	"	B
123 <i>e</i>	As. 31:359b	S. wall of S. Bldg.	Ibiqadad II	"	"	
123 <i>f</i>	As. 31:265	Q 32:7	Below Ibiqadad II	"	"	
123 <i>g</i>	As. 31:363b	P 32:13	Ibiqadad II or below	"	"	
123 <i>h</i>	As. 30:P.5	O 29:2	Near surf.	Larsa	"	C
123 <i>i</i>	As. 31:519	M 33:2	Ibiqadad II	L. Larsa	"	B
123 <i>j</i>	As. 31:359a	S. wall of S. Bldg.	"	"	"	C
123 <i>k</i>	As. 31:363a	P 32:13	Ibiqadad II or below	"	"	C
124 a-a'	As. 31:710	L 30:1	Urninmar pit	E. Larsa	"	B
124 <i>b</i>	As. 31:264	P 32:13	Below Ibiqadad II	L. Larsa	"	C
124 c-d	As. 31:847-48	L 30:1	Urninmar pit	E. Larsa	"	C
124 e-e'	As. 31:849	K 31	Bilalama	"	"	C
125 a-b'	As. 31:P.85	M 26:4, street	"	Larsa	"	C
125 <i>c</i>	As. 30:P.4	O 29:5	"	"	"	C
125 <i>d</i>	As. 30:P.25	O 29?	Surf.	"	"	C
126 <i>a</i>	As. 34:45	L 30:1	Urninmar pit	E. Larsa	See p. 120; printed in reverse in OIP XLIII, Fig. 128	C
126 <i>b</i>	As.	Unknown	"	"	See p. 120	
126 <i>c</i>	As. 32:1127	E 14:1	"	Agade or later	"	
126 <i>d</i>	As. 31:79	F 23:1	"	Larsa	See p. 120	C
126 <i>e</i>	As. 34:181	N 14?	Later town wall	Larsa	"	B
126 <i>f</i>	As. 30:100	P 29:1	Ibiqadad I well	E. Larsa	See pp. 92, 121	C

CATALOGUE OF ILLUSTRATED SHERDS AND OTHER CLAY OBJECTS 165

Pl.	Field No. or Site	Square, Locus, or Area	Building or Level	Date of Find-Spot	Remarks	Museum
126 <i>g</i>	As. 31:520 <i>a</i>	N 30:6	3 m. below surf.	E. Larsa	See p. 121	C
126 <i>h</i>	As. 31:520 <i>b</i>	W. of M 30:3		Larsa	"	C
126 <i>i</i>	Kh. VIII 74	n 74-75, trench		Old Bab.	See pp. 121, 124	B
127 <i>a</i>	Kh.	Mound A		ED III	See pp. 97, 121	
127 <i>b</i>	As. 31:358 <i>f</i>	N 30:3	Isharramashu	E. Larsa	See p. 121	C
127 <i>c</i>	As. 32:716	E 15:1	N. Palace	Protoimp.	See pp. 109, 121	
127 <i>d</i>	As. 31:358 <i>b</i>	N 31:4		E. Larsa	See p. 121; published as As. 31:358 <i>a</i> in <i>OIP</i> XLIII, Fig. 129 <i>a</i>	B
127 <i>e</i>	As. 31:358 <i>c</i>	"		"	See p. 121	C
127 <i>f</i>	As. 31:358 <i>a</i>	O 34, S. of S. Bldg.		L. Larsa	"	C
127 <i>g</i>	As. 31:358 <i>d</i>	Q 33:18	Ibiqadad II or below	"	"	
127 <i>h</i>	As. 31:358 <i>e</i>	Unknown			"	C
130 <i>a</i>	As. 30:98 <i>a</i>	O 30:7	Isharramashu	E. Larsa	See pp. 104, 122	C
130 <i>b</i>	As. 30:98 <i>b</i>	Unknown			"	C
130 <i>c-c'</i>	As. 31:379 <i>a</i>	O 30:16	Bilalama	E. Larsa	See p. 122	C
130 <i>g</i>	Ag. 31:402 <i>b</i>	N 33:12	Ibiqadad II	L. Larsa	See p. 118	C
131 <i>a-a'</i>	As. 31:726	Dump		Larsa	See p. 122	C
131 <i>b-b'</i>	As. 31:410 <i>e</i>	"		"	"	C
131 <i>c-c'</i>	As. 31:410 <i>d</i>	Q 33:6	Ibiqadad II	L. Larsa	"	C
131 <i>d-d'</i>	As. 31:410 <i>a</i>	Q 33:2	"	"	"	C
131 <i>e-e'</i>	As. 31:410 <i>b</i>	Q 33:15	Ibiqadad II or below	"	"	C
131 <i>f-f'</i>	As. 31:410 <i>f</i>	Dump		Larsa	"	C
133 <i>e</i>	Kh.	Q 42:19	Sin V	Protolit. <i>d</i>	See p. 50	
133 <i>f</i>	"	Q 42:15	"	"	"	
133 <i>g</i>	"	Unknown	Houses 12	"	See p. 50	
133 <i>h</i>	Ag. 36:581 <i>a</i>	Hill B, room V	5th layer from top	Protolit.?	See pp. 28, 50	C
133 <i>i</i>	Ag. 36:581 <i>c</i>	"	"	"	"	B
133 <i>j</i>	As. 34:225 <i>a</i>	Below D 17:26	Earliest Shrine	Protolit. <i>d</i>	See p. 50	C
133 <i>k</i>	As. 34:225 <i>c</i>	"	"	"	"	C
133 <i>l-m</i>	As. 34:225 <i>e-f</i>	"	"	"	"	C
134 <i>c</i>	Kh.	Q 42:15	Sin V	"	See p. 45	
134 <i>d</i>	"	"	"	"	See p. 47	
134 <i>e</i>	Kh. VII 185	Q 42:25	Sin III	Protolit. <i>c</i>	"	
134 <i>f</i>	Kh. VII 109	P 42:50	(Sin III)	"	"	C
134 <i>g</i>	As. 34:175	D 17:27	Archaic Shrine II	ED I	See pp. 47, 72, 92	C
134 <i>h</i>	As.	Archaic Shrine	Archaic Shrine III	"	See pp. 47, 72	
134 <i>i</i>	As. 34:137 <i>b</i>	D 17:16	Archaic Shrine II	"	"	B
134 <i>j</i>	As.	Archaic Shrine	Archaic Shrine IV	"	"	
135 <i>c</i>	Ag. 36:527	Hill C, sherd pavement of room I, II, or IV	Top layer	"	See Pl. 53 <i>b</i> and p. 62	C
135 <i>d</i>	Ag. 36:522	"	"	"	See Pl. 53 <i>a</i> and p. 61	C
135 <i>e</i>	Ag. 36:474	Hill B, room VII	"	"	See p. 62	B
136 <i>a</i>	Kh.	O 43:35	Small Temple I	ED I?	See pp. 36, 62	
136 <i>b</i>	As. 34:209	E 17:31	Archaic Shrine I	ED I	See p. 62	C
136 <i>d</i>	As. 34:169	D 17:35	Archaic Shrine II	"	See p. 64	B
136 <i>e</i>	As. 34:129	D 17:10	"	"	"	C
136 <i>f</i>	As. 34:176	E 17:31	"	"	"	C
136 <i>g</i>	As.	Archaic Shrine	Archaic Shrine III	"	"	
136 <i>i</i>	Kh.	N 44:12	Houses 7	"	See p. 65	
136 <i>j</i>	As.	Archaic Shrine	Archaic Shrine III	"	"	
136 <i>k</i>	As. 33:719	E 16:45	Archaic Shrine IV	"	See p. 65	
136 <i>l</i>	As. 33:636	"	"	"	"	B

POTTERY FROM THE DIYALA REGION

Pl.	Field No. or Site	Square, Locus, or Area	Building or Level	Date of Find-Spot	Remarks	Museum
136 <i>m</i>	As.	Archaic Shrine	Archaic Shrine IV	ED I	See p. 65	
136 <i>n</i>	As. 34:153	D 17:15	Archaic Shrine II	"	"	
136 <i>o</i>	As.	Archaic Shrine	Archaic Shrine III	"	"	
136 <i>p</i>	"	"	Archaic Shrine II	"	"	
136 <i>q</i>	As. 34:24	W. of D 17:2	Square Temple	ED II	ED I survival; see pp. 65, 80	B
136 <i>r</i>	As. 33:119	E 17:20	"	"	"	B
136 <i>s</i>	As. 33:531	D 17:8	"	"	"	C
137 <i>b-c</i>	Ag. 36:528	Hill C, room II sherd pave- ment	Top layer	ED I	See Pl. 58 <i>a-b</i> and p. 67	C
137 <i>d-e</i>	Ag. 36:525 <i>a-b</i>	Hill C	"	"	See Pl. 58 <i>d-e</i> and p. 68	C
137 <i>f</i>	Ag. 36:523	Hill C, sherd pavement of room I, II, or IV	"	"	See Pl. 58 <i>c</i> and p. 68	C
137 <i>g</i>	Kh. V 187	O 43:18	Houses 8	"	See p. 68	
137 <i>h</i>	Kh. V 186	N 44:20?	Houses 8?	ED I?	"	C
137 <i>i</i>	Kh. V 354	N 43:22?	Houses 6?	ED II?	"	
137 <i>j</i>	Kh. III 592	P 42:4	Houses 4	ED II	ED I survival? See pp. 68, 80	C
139 <i>b</i>	As. 33:680	J 19, arch house	Houses Va	Protoimp.	See Pl. 112 <i>f</i> and pp. 65, 108	C

INDEX OF FIELD NUMBERS

REFERENCES are to the catalogues through shape numbers or, for sherds and other clay objects, through plate numbers. The catalogues in turn give cross-references to text discussions of individual pieces. A few items described in the text are not illustrated. In such cases page references are given. For pieces which are now in museums that fact is indicated by "B" (= Baghdad, Iraq Museum), "P" (= Philadelphia, University Museum), or the museum numbers (e.g., A18031) of those which are in the Oriental Institute Museum in Chicago.

In this list the doubtful elements of the shape numbers are not indicated in any way (cf. p. 152).

TELL AGRAB

Field No.	Reference	Museum	Field No.	Reference	Museum
Ag. 35: 47	C.515.373	B	Ag. 36:534	C.525.362a	A 21774
104	B.852		535	D.526.373	B
105	C.96		536	C.526.262a	B
499	C.96		537	C.526.262b	A 21775
516	C.555.921	B	538	C.556.242	B
563	C.526.471d	A 18031	539	C.545.242	A 21776
767	B.663.213	A 18105	540	C.516.373	
986	B.525.322		541	C.516.373	A 21777
987	B.203.510		542	D.515.373	A 21778
1012	B.075.210		543	C.516.373	B
1032	C.526.373	B	545	C.236.010	A 21779
1133	C.357.010a	A 18237	546	C.236.010	B
1136	D.526.373		547	C.516.373	B
Ag. 36: 279	B.644.520	B	548	C.526.373	A 21780
304	C.358.010	B	549	B.072.210a	A 21781
437	Pl. 17 a	A 21725	550	B.083.200	B
450	C.206.400	B	551	B.003.210b	B
453	B.043.200a	A 21731	552	B.003.210b	A 21782
454	C.517.273	B	553	B.003.210b	B
455	C.514.370b	B	554	B.003.210b	A 21783
456	C.514.370b	A 21732	555	C.666.520	A 21784
470	D.515.370	A 21741	556	B.086.700	B
471	C.526.373	B	557	B.086.700	A 21785
473	C.574.440	A 21743	558	B.087.700	A 21786
474	Pl. 135 e	B	559	B.086.700	B
475	C.525.370b	A 21744	560	B.526.360	B
511	Pl. 20 b	A 21760	561	B.524.270	A 21787
520	Pl. 53 c	A 21766	562	A.513.260	B
522	Pl. 53 a	A 21767	563	B.533.252	A 21788
523	Pl. 58 c	A 21768	564	B.524.271	B
525a-b	Pl. 58 d-e	A 21769a-b	565	Pl. 51 b	B
526	Pl. 53 d	B	566	D.525.371	A 21789
527	Pl. 53 b	A 21770	567	D.516.363	B
528	Pl. 58 a-b	A 21771	568	B.754.540	A 21790
530	C.556.242	B	569	Pl. 51 c	B
531	C.556.242	A 21772	570	C.557.620	A 21791
532	C.525.362a	A 21773	571	C.014.310	A 21792
533	C.525.362a	B	572	D.515.370	B
			574	E.588.000	B

POTTERY FROM THE DIYALA REGION

Field No.	Reference	Museum	Field No.	Reference	Museum
Ag. 36:575	D.544.540	B	Ag. 36:579	D.545.322	B
576	C.526.373	B	580	C.516.373	B
577	C.044.310		581a	Pl. 133 h	A 21794
578	C.666.520	B	581c	Pl. 133 i	B

TELL ASMAR

As. 30:P.1a	B.151.210		As. 30:P.32	E.223.000	
P.1b	B.151.210	B	P.34	B.546.240	A 8206
P.1c*	B.151.210	A 8225	P.35	D.545.640	A 8177
P.1d*	B.151.210	B	P.35a	D.545.640	
P.1e*	B.151.210	A 8226	P.35b	D.545.640	A 8192
P.1f*	B.151.210	A 8227	P.35c	D.545.640	A 8219
P.1g*	B.151.210	A 8228	P.36a	C.208.440	B
P.1h-i	B.151.210	A 8229-30	P.36b-c	C.208.440	A 8197-98
P.2	B.052.200a		P.40	B.206.423d	
P.3	B.061.210		P.41a	B.206.423a	A 8327
P.3a-d	B.061.210	A 8232-35	P.41b	B.206.423a	
P.4	Pl. 125 c	A 8255	P.41c	B.206.423a	A 8328
P.5	Pl. 123 h	A 8254	P.41d	B.206.423a	B
P.6a-b	B.206.423c	A 8329-30	P.42a	B.545.220c	B
P.7	B.545.220c		P.42b	B.545.220c	A 8299
P.8	B.206.423e	A 8256	P.42c-d	B.545.220c	A 8203-4
P.9a	B.656.320	B	P.43a	C.545.340c	A 8269
P.9b	B.656.320	A 8208	P.43b	C.545.340c	B
P.10	B.536.270	B	P.44a	C.545.340d	A 8265
P.11	B.174.220b		P.44b	C.545.340d	B
P.12	C.547.640a	A 8193	P.45	C.655.240	B
P.13a	B.706.360	A 8200	P.46	C.656.340	A 8213
P.13b	B.706.360	A 8202	P.47	C.228.340a	A 8196
P.13c	B.706.360	A 8209	P.48a	B.787.320b	B
P.13d	B.706.360		P.48b	B.787.320b	A 8199
P.14a	C.547.720		P.49	B.237.100	A 8221
P.14b	C.547.720	A 8214	P.50	B.246.200b	B
P.15	B.236.200a		P.51	A.586.462	A 8201
P.15a-c	B.236.200a	A 8321-23	P.52	B.536.240a	A 8210
P.15d	B.236.200a	B	P.53	C.447.360	A 8224
P.15e	B.236.200a	A 8331	P.54	B.527.340	A 8220
P.16a	C.548.720	A 8223	P.55	C.064.300	A 8169
P.16b	C.548.720	B	P.56	A.545.320	
P.17	A.758.540	A 8242	P.57	C.507.570	
P.18	B.206.423b		P.58	B.526.260	A 11436
P.19c	Pl. 92 i	A 8883	P.59	B.475.250b	
P.19e	Pl. 92 k	A 8885	98a	Pl. 130 a	A 8183
P.20	C.555.320		98b	Pl. 130 b	A 8893
P.21	A.527.462	A 8300	100	Pl. 126 f	A 8867
P.22a-c	B.031.200	A 8236-38	P.120	C.547.640b	A 8217
P.23	C.142.310		As. 31:P.2	B.575.224	
P.24	C.545.440		P.3	B.174.210b	
P.25	Pl. 125 d	A 8253	P.4	C.758.510	B
P.26	E.314.010		P.5a-c	C.556.322	
P.27	E.223.010		P.6	C.557.640	A 8377
P.28	E.313.010		P.7	C.787.340	A 8216
P.29	E.313.040		P.9	C.466.370	B
P.30	E.202.010		P.11	C.546.320	
P.31	E.655.000		P.12	C.546.640	A 8283
			P.14a-b	B.527.462	
			P.16a	C.226.540	
			P.16b	C.226.540	A 8275

* Specimen included in catalogue but field number not listed there.

INDEX OF FIELD NUMBERS

169

Field No.	Reference	Museum	Field No.	Reference	Museum
As. 31: P.16c	C.226.540		As. 31: P.80	B.786.520	A 8297
P.17	A.604.520	A 8205	P.81	B.052.202	A 8239
P.19b	Pl. 92 <i>e</i>	A 8882	P.82a	B.535.220	B
P.19d	Pl. 92 <i>j</i>	A 8884	P.82b	B.535.220	A 8309
P.20	D.555.510a		P.85	Pl. 125 <i>a-b'</i>	A 8251
P.23	B.505.270a	A 8180	P.88a-b	D.044.510	A 8175-76
P.25a-b	B.236.200c	A 8324-25	P.89a	C.216.210	A 8267
26	A.010.203		P.89b-c	C.216.210	
P.27	C.646.222		P.90	B.644.540	A 8211
P.27a	B.812.542	B	P.91	B.475.250a	B
P.27b	B.812.542	A 8287	P.92	B.717.700	A 8298
P.30	B.001.310	A 8758	P.93	B.043.210a	B
P.31	B.527.360		P.94	C.043.510	A 8212
P.32	B.042.500a	A 8250	P.95	C.485.220	
P.33	B.543.520	A 8306	P.96	B.064.210	A 8288
P.34	B.555.540b	A 8279	P.97a	B.032.200b	A 8272
P.38	C.96	A 8911	P.97b	B.032.200b	A 8190
P.38a	B.052.200c	B	P.97c	B.032.200b	A 8273
P.38b-c	B.052.200c	A 8245-46	P.97d	B.032.200b	A 8191
P.39a	B.664.540c	A 8302	P.97e	B.032.200b	A 8274
P.39b	B.664.540c	B	P.98	E.229.010	
P.42a-c	C.001.200a	A 8184-86	P.99	B.041.710	B
P.42d	B.001.200a	A 8187	P.100	B.544.540	A 8277
P.42e	C.001.200a	A 8188	P.102a-b	C.042.200	A 8270-71
P.42f	B.002.200b	A 8189	P.103	C.111.310b	A 8222
P.43	A.653.540	A 8319	P.104	C.246.310	A 8266
P.43b	B.543.520	A 8320	P.105	C.555.510	
P.44	C.467.560		P.106	C.466.470	
P.45a	B.633.570a		P.107a	C.576.242	A 8280
P.45b	B.633.570a	A 8276	P.107b	B.545.222a	A 8281
P.46c-d	B.574.240	A 8311-12	P.108a	C.257.210	B
P.47	C.111.210	A 8231	P.108b	C.257.210	A 8215
P.48a-c	B.042.500b	A 8890-92	P.109	C.031.300	A 8240
P.54	Pl. 105 <i>h</i>	A 8868	P.110	B.645.540a	B
P.55	Pl. 105 <i>i</i>	B	P.111	C.555.440	A 8268
P.58a-b	B.246.200a	A 8317-18	P.112	C.657.242	B
P.58c	B.246.200a	B	P.113	B.446.262	B
P.59	B.787.320a		P.114	B.536.224	A 8295
P.60a	B.024.210	B	P.115	B.123.210	A 8289
P.60b	B.024.210	A 8313	P.116a	B.546.222	
P.61	B.185.260	A 8296	P.116b	C.547.242	A 8285
P.62	B.174.210a		P.118	D.755.543	B
P.63	B.236.300		P.119	B.655.640	A 8316
P.64	B.546.640b	A 8278	P.121	B.185.220	A 8290
P.67a	B.176.220b	A 8282	P.122	C.043.310	B
P.67b	B.176.220b		P.123	C.466.450	A 8286
P.67c	B.176.220b	B	P.124	B.184.220a	A 8304
P.68	D.525.670		P.125	B.644.220	A 8315
P.69	B.174.220c	A 8314	P.126a	D.201.201b	
P.70	A.515.660	A 8308	P.126b	D.201.201b	A 8167
P.71	A.303.503	A 8291	P.127	D.201.201a	
P.72a	B.545.240c	A 8207	P.128	B.666.540a	A 8284
P.72b	B.545.240c	B	P.129a	D.800.200	A 8906
P.74	D.556.640	A 8218	P.129b	D.800.200	A 8171
P.75	C.206.510		P.130	C.201.205	A 8168
P.77	A.666.422	A 8303	P.133	D.495.520	A 8178
79	Pl. 126 <i>d</i>	A 8865	P.134a-c	B.001.200b	A 8247-49

POTTERY FROM THE DIYALA REGION

Field No.	Reference	Museum	Field No.	Reference	Museum
As. 31: P.136	B.256.200	A 8194	As. 31: 816	C.206.310	A 8864
P.137	D.301.112	A 8165	847-49	Pl. 124 <i>c-e'</i>	A 8261-63
P.137x	B.255.200	A 8195	850	Pl. 106 <i>g</i>	A 8264
P.138	A.656.700	A 8241	As. 32: P.1	C.245.300	
P.139b	D.800.102	A 8179	P.2	B.084.210a	
P.139x	A.002.203	A 8243	P.4	C.515.561	
P.140a-b	A.624.563	A 8293-94	P.6	B.043.200b	
P.140c	A.002.600		P.7	B.052.200b	
P.141	A.111.210	A 8244	P.8	A.545.360	
P.144	D.526.370a		P.9	B.813.522	
P.145	A.655.520b	B	P.11	B.816.521b	B
P.146	A.303.423	A 8305	P.12	B.636.570	B
P.147	A.506.860	A 8307	P.13	B.002.200b	
P.148	A.544.520	A 8292	P.14	C.111.310a	B
P.149	B.556.471		P.15	B.545.222b	
P.151	C.053.212		P.16	B.536.240b	
P.160	Pl. 123 <i>c</i>		P.17	B.062.200	
P.170a	B.545.220b	B	P.18	B.043.200a	
P.170b	B.545.220b	A 8901	P.19	B.052.200b	
P.172	C.477.270		P.20	A.055.100	
P.191	B.173.222	A 8310	P.21	C.001.200b	
264	Pl. 124 <i>b</i>	A 8257	P.23	C.206.410	B
265	Pl. 123 <i>f</i>		P.24	B.043.210b	
358a	Pl. 127 <i>f</i>	A 8871	P.25	B.546.322	
358b	Pl. 127 <i>d</i>	B	P.26	C.475.360	
358c	Pl. 127 <i>e</i>	A 8872	P.27	C.427.570	
358d	Pl. 127 <i>g</i>		P.29	C.216.210	
358e	Pl. 127 <i>h</i>	A 8873	P.30	B.041.710	
358f	Pl. 127 <i>b</i>	A 8874	P.32	B.526.471	A 11437
359a	Pl. 123 <i>j</i>	A 8258	P.33	B.466.470	
359b	Pl. 123 <i>e</i>		P.34	B.576.224	
363a	Pl. 123 <i>k</i>	A 8259	P.35	B.576.221	
363b	Pl. 123 <i>g</i>		P.36	B.054.700	
376a	C.96	A 8448	P.37	B.174.220c	
376b	C.96	A 8447	P.38	B.573.240	
379a	Pl. 130 <i>c</i>	A 8896	P.40	A.515.370	
379b	p. 122	A 8897	P.41	A.785.520	
380a	Pl. 87 <i>n</i>	A 8876	P.42	B.545.222a	A 11426
380b	Pl. 87 <i>h</i>	A 8905	P.43	B.633.570b	
402b	Pl. 130 <i>g</i>	A 8894	P.43a	C.646.422	
410a-b	Pl. 131 <i>d-e'</i>	A 8467-68	P.44	B.151.210	
410d	Pl. 131 <i>c-c'</i>	A 8470	P.45	A.555.320	
410e	Pl. 131 <i>b-b'</i>	A 8471	P.46	A.026.200	
410f	Pl. 131 <i>f-f'</i>	A 8472	P.48	B.566.660	
428a-c	B.032.500	A 8738-40	P.49	C.257.210	
446	B.852	B	P.50	B.225.540	
472	Pl. 123 <i>b</i>	B	P.52	B.001.200a	
472d	Pl. 123 <i>a</i>	A 8301	P.53	C.743.570	
519	Pl. 123 <i>i</i>	B	P.54	C.544.312	
520a-b	Pl. 126 <i>g-h</i>	A 8880-81	P.55	B.663.520	
526	Pl. 123 <i>d</i>	B	P.56	B.031.200	
535a-b	B.852	A 8463-64	P.57	B.061.210	
609a	Pl. 87 <i>c</i>	A 8875	P.58	B.654.523	
610	Pl. 122 <i>e</i>	A 8260	P.59	A.151.210	
710	Pl. 124 <i>a-a'</i>	B	P.60	D.596.540	
726	Pl. 131 <i>a-a'</i>	A 8473	P.62	D.656.540	
732a	Pl. 91 <i>d</i>	A 8879	P.63	C.544.312	

INDEX OF FIELD NUMBERS

Field No.	Reference	Museum	Field No.	Reference	Museum
As. 32:P.64	C.053.312	B	As. 32:792	B.041.200	
P.65	D.201.201b		802	C.557.372	
P.66	C.001.200a		804	A.524.260	
P.68	B.645.224		809	B.084.710b	
131	Pl. 114 a	A 11434	810	D.465.360	
134	C.053.312		824	B.556.222	
303	B.031.510		846	A.021.201	
421	A.544.212		851	D.555.510b	
423	C.111.210		852	D.546.540b	
424	C.546.540		856	E.235.010	
427	Pl. 87 l		857	D.333.250	
439	D.466.360		858	D.801.201	
442	A.556.500		859	B.576.220	
444	B.555.224	B	864	C.516.371a	
445	B.706.370		865	B.704.560	
454	B.043.200b		866	B.664.540a	B
460	B.174.220a		927	A.654.523	
461	B.536.224		938	C.201.203	B
468	B.755.540		939	C.072.200	
476	B.256.200	B	940	C.233.100	
477	B.174.220a		942	C.211.200	
478	B.573.240		958	B.634.570b	
480	A.444.250	A 11414	979	B.085.210	
504	D.801.201		980	B.175.220b	
505	C.486.222		981	B.645.220	
506-7	C.216.210		982	B.002.200b	
508	C.653.520	B	983	B.633.570a	
509	C.546.340		984	C.215.210	
512	B.816.521a		1002	B.645.220	
527	C.777.340	B	1013	A.044.600	
540	A.475.210		1014	B.754.220	
545	C.98		1017	C.525.550	
546-47	C.053.312		1018	C.566.350	
548	B.185.220		1019	C.516.371a	
578	C.757.540	A 11431	1020	A.831.203	
579	C.053.312		1021	A.032.503	
588	C.596.440b		1035	A.756.520	
589	C.042.203		1041	Pl. 87 m	
611	B.011.200		1042	Pl. 87 o	
645	B.645.420		1043	Pl. 86 m	
647	D.546.540a		1061	B.575.224	
648	D.596.540	B	1099	C.213.200	
649	C.657.522		1103	B.435.262	
650	B.556.540	B	1127	Pl. 126 c	
701	D.022.410		1128	B.655.540b	
704	B.175.221	B	1129	A.604.560	
716	Pl. 127 c		1130	B.515.460	
734	D.654.310		1132	C.656.540	
735	D.465.550		1133	C.011.210	
751	A.644.520		1142	B.816.521c	A 11435
762	A.535.220		1143	C.587.862	
775	A.565.610		1158	A.576.822	
780	C.95	A 11432	1160	C.052.202	
783	B.505.250	B	1188	D.465.460	
788	C.664.640		1250	B.703.560	
789	B.072.210b		1258	B.634.570a	
791	A.654.920		1260	C.757.540	B

POTTERY FROM THE DIYALA REGION

Field No.	Reference	Museum	Field No.	Reference	Museum
As. 32: 1261	C.805.210	B	As. 33: 336	B.665.520	
1262	C.805.210		362	C.356.010	B
1263	C.536.520		365	C.175.720	
1264	C.516.240		366	C.082.200	
1265	D.555.540		424	C.525.362b	
1267	C.665.543d		425	C.526.262c	
1268	C.546.340		426	B.003.210a	
1269	C.516.240		462	Pl. 92 a	
1270	C.053.312		494	C.35-.0- -a	
1271	C.665.541	B	495	C.39-.0- -	B
1272	C.665.543d	A 11438	502	C.357.073	B
1273	B.665.212		518	Pl. 92 b	
1300	B.516.473		531	Pl. 136 s	A 17204
1305	C.003.203	A 11433	542	B.756.720	
1306	C.475.370		543	C.082.210	
1307-8	B.032.200a		549	A.645.720	
1309	B.644.520		552	B.406.462	
1311	B.072.200		558	C.514.540	
1314	A.655.520a		609	Pl. 92 d	
1319	B.741.300		610	B.664.520b	A 17146
1322	B.676.422		627	C.35-.0- -b	
1334	A.624.520		636	Pl. 137 m	B
1345	C.565.540		639	C.486.320	
1363	B.644.322		671	C.546.540	
1371	C.204.210		674	C.355.010	A 17147
1377	A.556.520		675	Pl. 45 i	
1379	C.802.200		680	Pl. 112 f	A 21870
As. 33: 10	C.665.621		712	B.577.420	
17	A.515.270		713	B.204.200	
18	C.96		714	C.041.200	
21	A.010.203		719	Pl. 136 k	
34	C.365.810d		722	C.554.220	A 17148
69	B.505.571		723	D.526.371	A 17149
90	C.354.010		726-27	D.535.542	
106	C.555.522	B	728	C.526.460	
107	C.084.310		729	B.247.700	
116	C.357.010b		730	B.176.220a	
119	Pl. 136 r	B	731	B.175.720	
122	B.634.570b		As. 34: 24	Pl. 136 q	B
131	C.654.520		45	Pl. 126 a	A 17156
140	C.96		57	C.505.470	
145	C.665.543b		58	A.235.203	
149	C.357.010b	A 17140	59	C.606.620	
150	B.063.200b		60	D.555.340	
153	C.665.543c		64	Pl. 63: 73	
154	C.665.341		68	D.516.371	
179	B.466.470		69	C.3- -.0- -	B
180	B.406.460		70	C.3- -.063	
198	C.665.543a		71	B.224.443	
201	B.466.470		72	B.526.273	
224	C.557.422		80	B.666.620	
235	C.405.363		87	B.083.200	
287a-b	C.365.810b		89	B.634.570c	
288	B.546.640c		90	B.816.521a	A 17163
289	C.805.200		93	B.111.210	
316	A.053.700		95	B.664.520b	
333	C.303.200		97	B.664.540b	

INDEX OF FIELD NUMBERS

173

Field No.	Reference	Museum	Field No.	Reference	Museum
As. 34: 98	B.556.520		As. 34:199-200	D.504.353a	
99	B.625.521	A 17164	201	C.525.373	
106	B.007.700	A 17168	202	D.504.353a	
107	C.663.540		203	B.087.700	
109	B.077.700a	B	204	C.545.222	
110	B.087.700	B	205	D.545.542	
111	B.085.200		206	C.236.210	
112	C.545.220		207	C.526.353	B
115	B.664.570		208	C.086.200	
120	B.183.210		209	Pl. 136 b	A 17189
121	D.307.010	B	225a	Pl. 133 j	A 17191
122	A.704.220		225c	Pl. 133 k	A 17192
126	C.555.520		225e-f	Pl. 133 l-m	A 17193-94
129	Pl. 136 e	A 17173	233	Pl. 63:20	A 17198
137b	Pl. 134 i	B	234	C.806.610	
144	C.516.370		235	C.603.340	A 17197
145	C.555.353		237a	Pl. 63:71	
146	C.525.373		237c	Pl. 63:72	
147	D.514.370a	B	238a	Pl. 64:29	B
148	D.526.370b	A 17178	238b	Pl. 64:33	A 17199
149	D.514.370b	A 17179	240	Pl. 64:16	B
150	D.504.353b	A 17207	241	Pl. 64:17	A 17201
151	D.504.353a		242	Pl. 64:14	A 17202
152	C.456.353	B	243	B.455.253	
153	Pl. 136 n		244	C.084.200b	
155	C.505.353	B	245	B.546.223	
156	D.504.353a	B	246	C.545.342	B
157	D.544.240		247	C.545.342	
159	C.594.220		251	C.745.270	
162	B.493.663		252	p. 92	B
163	C.467.350		As. 35: 22	A.237.823	
168	C.534.313	A 17182	35	B.705.370	B
169	Pl. 136 d	B	63	C.247.500	
175	Pl. 134 g	A 17183	93	B.032.500	
176	Pl. 136 f	A 17184	97	E.544.310	B?
177	Pl. 92 f	A 17185	98	E.244.310	B?
181	Pl. 126 e	B			

ISHCHALI

Ish. P.1	A.556.423	Ish. P.22	B.236.200b
P.2	A.043.210	P.24	C.557.170
P.4	B.546.260	P.25	C.547.720
P.5	B.756.220	P.26	C.176.720
P.6	B.647.240	P.27	C.556.320
P.7	C.635.360	P.28	C.547.320
P.8	B.226.720c	P.29	B.174.740
P.9	A.663.520	P.30	B.031.200
P.10	B.644.720	P.31	B.546.370
P.11	B.646.710	P.32	C.208.320
P.12	B.236.500	P.34	E.655.000
P.13	B.207.310a	P.35	C.756.340
P.14	B.766.320b	P.37	B.001.200a
P.15	B.247.200	P.38a-b	C.001.200b
P.16	B.207.310b	P.40	B.506.370
P.17	B.646.340	P.41-43	B.506.270a-c
P.19	C.558.320	P.44	B.226.720b
P.21	B.546.370		

POTTERY FROM THE DIYALA REGION

Field No.	Reference	Museum	Field No.	Reference	Museum
Ish. P.46	C.044.310		Ish. P.60	B.175.760	
P.47	C.758.510		P.61	A.655.120	
P.49	C.757.340		P.62	A.706.520	
P.51	C.228.340b		P.63	B.062.210a	
P.55	B.032.210		P.65	B.505.270b	
P.56	B.236.200a		P.66	C.044.210	
P.57	B.546.220		P.68	B.788.320	
P.58	B.766.320a		P.75	A.545.320	
P.59	B.226.720a		P.76	C.043.310	

KHAFAJAH

Field No.	Reference	Museum	Field No.	Reference	Museum
Kh. I 3	Pl. 106 e		Kh. I 91	B.044.210	
9e	Pl. 89 h		95b	A.044.600	B
9f	Pl. 89 k		156	Pl. 89 d	
18d	C.526.471a	A 9213	183	C.556.320	
18e	C.556.420	A 9282	192	C.011.201a	
18f	C.504.370	A 9212	193	A.655.520a	
19	C.011.201a		204	C.202.203	
20	B.555.540a		205	Pl. 89 e	
21	B.675.220b		210	Pl. 106 i	
22	B.675.220a		222	Pl. 92 g	
23	B.002.200a		229	A.765.500	
27	C.042.204		230a-b	B.002.200a	
28	B.816.521		246	Pl. 106 k	
29	Pl. 106 f		251	B.516.371c	
30	Pl. 86 c		264	C.365.810d	
31a	C.545.320		269	A.545.540	A 11585
31b	C.555.420		270	B.073.210	
31c	C.504.360		283	B.084.210c	
31e	C.505.360		289	B.083.210c	
31f	C.363.810b	A 9277	294	Pl. 89 b	
31g	B.575.220		300	Pl. 89 a	
31h	C.515.361		312	Pl. 87 f	A 9283
31i	C.505.370a		313	A.655.220	
31k	C.686.420	A 11635	321	B.816.521	
31l	D.546.540b		322	Pl. 106 h	
32	C.96		335	C.365.810d	
43a-b	B.002.200a		341	A.573.200	
45	C.363.810a	B	359	A.516.151	
55a	C.545.320	A 9278	378	Pl. 89 f	
55b	C.545.320		382	B.082.210	
55c	C.053.200	A 9279	393	A.451.273	
55f	C.545.520		402	B.516.371b	
58	Pl. 106 d		409	B.514.570	
61	A.001.300		430	A.424.353	
63	B.002.200a		446	A.224.200	A 9099
64a-b	B.002.200a		447	Pl. 86 d	
65a-b	B.002.200a		454	C.513.370a	B
66	Pl. 87 i	A 9208	454c	B.655.540a	B
69a	Pl. 106 c		454d	A.516.373	B
69b	Pl. 106 b		454e	A.514.733	B
70	B.816.521		455	B.663.540b	
71	Pl. 106 m		456	B.575.223	
72a	Pl. 110 a		458	B.081.210	
72b	Pl. 110 j		462	B.184.220c	
79	C.526.371b	A 9287	468a	B.574.220c	
90	Pl. 86 g	A 9671	468e	Pl. 51 d	

INDEX OF FIELD NUMBERS

175

Field No.	Reference	Museum	Field No.	Reference	Museum
Kh. I 477	B.514.373		Kh. III 286	Pl. 86 <i>k</i>	
493	Pl. 89 <i>g</i>		292	A.604.270	
505	Pl. 86 <i>e</i>		296	B.043.210 <i>c</i>	
523 <i>a</i>	B.062.210 <i>b</i>		323	C.364.810 <i>b</i>	A 11634
523 <i>b</i>	B.022.210		324	B.516.371 <i>b</i>	B
523 <i>c</i>	B.033.210		325	Pl. 106 <i>j</i>	
531	B.516.271	A 9284	345	B.032.500	
532	B.655.520	A 9280	347	A.557.320	
559	Pl. 87 <i>k</i>	A 9207	348	C.96	
603 <i>a</i>	B.601.530	A 9285	349	A.493.263	
603 <i>b</i>	B.601.530	B	363-64	C.803.200	
642	D.514.362		367	A.516.320	
Kh. II P.3	B.816.521 <i>a</i>		372	A.202.200	
P.4	C.96	A 11584	373	A.96	B
P.5	B.514.570		404	C.557.470	
97	C.861	B	418	B.033.700 <i>a</i>	A 11616
250	A.525.273	A 11612	431	A.514.270	B
285	C.861		435-36	B.002.200 <i>a</i>	
Kh. III 5	B.601.530	B	439	B.625.260	
34	B.516.471 <i>a</i>		467	B.664.540 <i>a</i>	
39	Pl. 86 <i>j</i>		478-79	B.002.200 <i>a</i>	
40	B.002.200 <i>a</i>		480	C.555.420	
58	A.656.720		481	C.526.460	B
68	A.545.522		482	C.365.810 <i>d</i>	
75	B.544.570		489	B.002.200 <i>a</i>	
99	B.445.350	B	490	C.505.370 <i>c</i>	
102	A.654.520		511	A.625.5- -	
113-14	B.002.200 <i>a</i>		553	A.754.500	
116	A.243.900 <i>b</i>	B	592	Pl. 137 <i>j</i>	A 21287
122	A.654.543	A 11610	612-13	B.002.200 <i>a</i>	
127	C.545.340 <i>a</i>		614	C.565.340	B
128	B.635.670 <i>a</i>		615	C.504.370	
130	B.203.203		616	C.506.470 <i>b</i>	
132	Pl. 91 <i>c</i>		617	C.505.370 <i>b</i>	
141	Pl. 95 <i>c</i>		620	C.365.810 <i>b</i>	A 11628
168	C.213.210	B	621	B.575.240	
169	B.002.200 <i>a</i>		622	C.353.010 <i>a</i>	B
171	Pl. 86 <i>i</i>		642	A.475.120	
172	Pl. 87 <i>a</i>		647	C.556.640	B
173	B.675.220 <i>b</i>		648	C.545.640	
174	C.352.000		649	C.506.470 <i>c</i>	
203	B.633.570 <i>b</i>		660	B.016.200	
204	B.084.710 <i>a</i>		662	Pl. 86 <i>b</i>	
205	A.243.900 <i>a</i>	A 11582	695	B.601.230	
218	Pl. 86 <i>a</i>		733	B.555.520	B
226	B.003.200 <i>a</i>		734	C.365.810 <i>c</i>	
229	C.655.340 <i>a</i>		757	C.365.810 <i>c</i>	
230	A.041.503	A 11581	770	C.525.470 <i>a</i>	
233	A.654.520		771	C.505.370 <i>b</i>	
237	Pl. 80 <i>c</i>	B	787-88	B.184.220 <i>b-c</i>	
251	B.645.540 <i>b</i>	B	789	B.574.220 <i>a</i>	
252	B.176.224 <i>b</i>		791	C.754.521	
253	C.525.470 <i>b</i>		804	A.175.122	
263	A.305.700		822	B.311.220	
273	B.176.224 <i>b</i>		823	A.035.600	
278	B.002.200 <i>a</i>		824	A.494.520	
280	B.574.220 <i>b</i>		825	C.555.423	

POTTERY FROM THE DIYALA REGION

Field No.	Reference	Museum	Field No.	Reference	Museum
Kh. III 826	B.545.5-1		Kh. III 1125	C.545.320	
832	B.516.471 <i>b</i>	A 11615	1126	C.545.320	B
842 <i>a</i>	B.041.503		1127	C.364.810 <i>a</i>	
842 <i>b</i>	B.043.503		1135	B.033.700 <i>b</i>	
870	C.686.443	A 11633	1141	B.603.570	
871	B.546.640 <i>a</i>	B	1150	C.527.362	B
872	B.176.224 <i>a</i>		1151	C.655.370 <i>c</i>	
873	B.545.640 <i>a</i>	A 11614	1152	B.573.220	
874	B.175.224		1165-66	C.555.420	
875	B.087.210		1171	C.803.200	B
876-77	B.002.200 <i>a</i>		1172	C.213.210	
884	C.506.470 <i>b</i>		1173	B.002.200 <i>a</i>	
886	B.086.210		1176	B.043.500	
899	B.084.210 <i>b</i>		1191	B.546.122	
952	A.186.400		1192	B.666.540 <i>b</i>	B
962	B.575.224		1194-96	C.013.210	
963	B.176.224 <i>b</i>		1197	C.803.200	
970	Pl. 95 <i>d</i>		1203	B.002.200 <i>a</i>	
972	A.505.450		1204	A.654.720	
973	A.645.720		1206	C.506.470 <i>a</i>	
974	B.033.700 <i>c</i>		1236	C.012.203	
975	B.033.700 <i>b</i>		1249	B.002.200 <i>b</i>	
976	A.545.620		1255	C.012.203	
977	A.556.320		1256	C.201.200	
978	B.185.224		1258	p. 104	
979-80	B.083.210 <i>a</i>		1270	B.664.520 <i>a</i>	
981-82	B.083.210 <i>b</i>		1277	C.526.471 <i>f</i>	B
983	B.084.210 <i>b</i>		1278-79	B.002.200 <i>a</i>	
984	C.075.404		1281	C.545.320	
985-86	B.175.224		1282	B.516.371 <i>a</i>	A 11631
987	A.655.520 <i>b</i>		1297	C.545.640	
988	B.544.520		1300	B.082.210	
989	B.516.471 <i>a</i>		1301	B.002.200 <i>a</i>	
992	C.96		1302	p. 104	
994	B.646.224		1303	B.083.210 <i>b</i>	
995	B.645.224		1314	A.014.700	
996	A.655.520 <i>a</i>		1319	A.645.510	
1025	C.352.010		1321	C.654.510	B
1026	C.545.340 <i>b</i>		1322	B.525.670	
1027	C.526.471 <i>c</i>		1323	C.515.370 <i>b</i>	
1028	C.545.320		1324	C.353.010	
1029	C.556.540		1325	C.545.310	
1030	B.574.220 <i>b</i>		1326	B.576.220	
1048-49	B.175.220 <i>a</i>		1327	C.545.320	
1063	C.96		1328	B.666.640	
1076	B.494.570		1330	C.655.370 <i>a</i>	
1077	B.663.540 <i>b</i>		1337	C.96	
1095	B.545.640 <i>b</i>		1343	B.002.200 <i>a</i>	
1096	B.601.530		1347	B.002.200 <i>a</i>	
1097	B.002.200 <i>a</i>		1348	B.525.670	
1098	B.664.540 <i>a</i>		1349-50	B.524.570	
1099	C.354.000		1365	C.011.201 <i>a</i>	
1100	A.446.830	B	1366	B.003.700	
1101	A.556.640	A 11583	1367	C.555.420	
1102	C.655.370 <i>c</i>	B	1368	B.002.200 <i>a</i>	
1103	C.525.370 <i>c</i>		1369	B.172.210	
1108	B.002.200 <i>a</i>		1370 <i>a</i>	Pl. 95 <i>a</i>	B

INDEX OF FIELD NUMBERS

177

Field No.	Reference	Museum	Field No.	Reference	Museum
Kh. III 1370b	Pl. 95 b	A 21302	Kh. V 161	B.664.520c	A 17075
1371	D.526.371	B	168	B.544.541	B
1372	C.526.471f	A 11627	169	B.416.260	
1373	C.525.352	B	171	B.516.263	
1374	C.526.371b	A 11629	172	B.516.270	
1375	C.527.362	A 11630	173	C.95	B
1376	B.535.610	A 11632	186	Pl. 137 h	A 21309
1377	D.565.310		187	Pl. 137 g	
1378	C.503.470		196	C.014.300	B
1379	C.514.350		198	B.071.500	
1380	C.516.371b		200	B.454.642	
1381	C.515.870		202	C.077.500	A 17086
1387	C.365.810d		203	B.516.270	
1397	B.003.700		204	B.665.520	
1398	B.033.700c		205	C.524.350	B
1399-1400	B.083.210a		206	B.664.520c	B
1401	B.174.220c		207	B.807.570	A 17087
1402	B.743.510		208	B.806.570	B
1403-4	C.352.010		243	C.044.200	A 17101
1405	B.535.221		245a	C.234.000	B
1406	B.535.223		245b	C.201.200	B
1407	C.365.810b		246	C.526.362b	B
1408-10	C.545.320		247	C.526.371a	B
1411	B.545.220c		248	A.493.263	B
1412	B.236.000		251	B.544.560	
1413-14	C.527.362		252	C.077.500	B
Kh. IV 137	p. 102		254	C.526.362a	B
177	A.402.200		270	C.526.362b	A 17112
368	B.756.521	B	282	B.356.000	B
391	B.882		285	B.754.540	A 17118
401	B.514.570		286	C.515.371	A 17119
403	B.067.700		287	C.357.000	B
411	B.596.520		288	B.022.200	B
412	B.556.520		289	B.022.200	A 17099
413	B.574.220b		290	C.367.810	B
414	B.656.520		292	B.356.000	A 17120
415	B.052.503		293	C.367.810	A 17121
473	C.604.370		294	C.357.000	A 17206
476	C.99	B	298	A.515.270	A 17124
486	A.014.703	A 21305	299	B.834.203	B
504	C.026.410		301	C.506.371	A 17126
Kh. V 9	A.002.500		354	Pl. 137 i	
23a	Pl. 48 i	A 21306 B	Kh. VI 39	C.404.350	
23b	Pl. 48 h	A 21306 A	42	B.031.500	B
28	C.96		69	C.526.373	B
45	Pl. 71 b	A 17039	328	C.455.353	B
50	B.755.520		329	C.654.222	A 17817
69	B.545.540		330	B.546.242	B
81	C.111.310b		331	B.493.253	B
82	D.525.362		333	C.95	A 17818
112	D.525.362	A 17058	334	B.455.253	A 17819
113	C.516.371b		335	C.603.253a	A 17820
114	D.525.370	B	336	C.744.340	A 17821
115	C.525.370a		337	B.516.273	
116	C.514.370a	A 17059	339	B.466.260	B
160a	Pl. 48 g	A 21308	371	D.535.342	B
160b	Pl. 48 f	B	411	C.96	B

POTTERY FROM THE DIYALA REGION

Field No.	Reference	Museum	Field No.	Reference	Museum
Kh. VII 12	A.604.223	A 21330	Kh. VII 284	C.357.010	A 21455
13	p. 40	B	285	B.413.253	B
14	C.533.313		286	C.49-.-53	A 21456
15	C.533.313	A 21331	Kh. VIII 28	B.613.270	
	+B.042.500a		40	B.416.371	
16	Pl. 17 c	A 21332	42-43	B.001.200a	
25	B.634.220		74	Pl. 126 i	B
26	B.603.240	A 21337	75	B.576.720a	P
27	A.514.260	A 21338	91	B.556.420	P
28	B.513.170	A 21339	92	B.564.371	B
30	B.034.203	B	93	B.556.422	B
31	B.003.200b	A 21341	94	A.652.500	B
32	C.534.620		95	A.652.500	P
33	C.743.510	B	96	C.526.471a	B
34	C.536.270	A 21342	99	C.585.320	B
35	C.544.540	A 21343	100	B.576.720b	B
38	p. 29	A 21345	104	B.306.503	
40	C.544.222	B	105	B.033.700b	
41	B.703.240	B	107	B.546.720	B
44	B.533.262	B	108	B.656.720	P
67	Pl. 17 m	A 21358	109	B.656.720	B
73	C.515.265		118	C.653.620	
77	A.527.760	A 21362	181	B.237.200	B
78	C.002.210	B	187-88	C.406.340	
79	C.002.210	A 21363	189	C.365.810b	
109	Pl. 134 f	A 21375	190	C.655.460	
110a-c	p. 47	B	192	C.527.471	P
111	D.665.542	B	195	C.506.470d	
112	B.653.240	A 21376	216	B.041.900	
113	C.535.242	A 21377	217	B.547.320	B
114	C.655.222	A 21378	218	B.556.720	B
115	C.654.242	B	219	A.633.263	P
116	D.545.626	A 21379	220	C.413.253c	B
130	Pl. 31 c	A 21389	231	B.140.210	B
131	Pl. 31 b	B	232	B.757.320	B
145	B.041.500	A 21393	246	C.665.740	B
146	C.702.253	B	283	D.515.370	P
148	B.085.200	B	Kh. IX 45	A.014.101	P
149	C.634.253	A 21394	46	A.546.630	P
150	C.603.270	B	49	Pl. 17 d	P
151	C.634.373	B	50	B.514.560	P
152	C.494.273	B	60	C.514.353	B
172	C.413.253a	A 21402	61	C.515.373	B
173	C.634.453	B	74	C.504.367	B
174	C.414.253		87	C.545.340d	
175	C.041.500	B	90	B.515.363	B
177	C.414.253	A 21403	100	C.515.373	P
178	C.603.253b	B	101	C.603.340	B
180-81	C.49-.-53	A 21404-5	102	C.514.370b	B
185	Pl. 134 e		103	C.514.370	P
211	B.041.500	B	104	D.514.370b	B
230	C.200.210	B	116	B.757.605	B
251	C.305.400	A 21440	127	B.604.270	P
253	C.634.373	B	129	B.544.222	B
280	C.493.253	A 21452	130	C.364.810b	B
281	C.494.253	B	131	C.605.240	
283	C.041.500	A 21453	148	C.516.270	B

INDEX OF FIELD NUMBERS

179

Field No.	Reference	Museum	Field No.	Reference	Museum
Kh. IX 149	D.524.370	B	Kh. IX 220	C.513.270	B
150	C.515.371	P	221	C.756.520	B
151	C.605.340	B	221 _a	B.414.270	B
152	C.604.370	P	222	C.537.270	B
153	C.515.370	B	223	C.535.240	P
154	C.535.240	B	224	B.544.521	B
155	B.544.240	P	225	B.545.240 _b	P
156	C.744.220	P	226	B.042.200	B
157	C.514.370 _a	B	227	C.546.240	P
158	C.514.370 _b	P	228	C.535.240	B
159	C.516.270	P	229	B.076.700	P
163	C.603.200	B	230	B.087.700	B
164	C.516.373	P	231	B.516.270	P
188	B.575.225	P	232	C.516.371 _b	P
189	B.575.225	B	233	C.603.253	B
190	C.654.240	B	234	C.604.353	P
194	C.412.253	P	235	Pl. 17 <i>b</i>	P
196	C.515.373	P	236	Pl. 87 <i>p</i>	P
197	C.041.500	B	237	Pl. 87 <i>j</i>	P
198	Pl. 31 <i>a</i>	P	238	Pl. 87 <i>q</i>	B
217	D.544.340	B	240	C.634.810 _a	P
219	C.534.240	P	241	C.605.340	B

GENERAL INDEX

- Abu Hatab, 150, 154
 Abu Temple at Tell Asmar, 28-30
 Agade period, division of, 109
 Agrab, Tell, location of, 27
 Albright, William Foxwell, xxi, 31
 ʿAlīʿabad, Tepe, 139, 143
 Altman, Charles B., 93, 154
 American Schools of Oriental Research, ix-x, 123
 ʿAmuq, 31, 133, 150
 Anatolia, 85, 131
 Andrae, Walter, xxii, 120, 154
 appliqué decoration, 102, 106, 109-10, 120-21, 143-44, 149; *see also* snake decoration
 Archaic Shrine of the Abu Temple, 29
 Arpachiyah, Tell, 29, 44, 154
 Asmar, Tell, location of, 27
 Assur, 82, 86, 93, 103, 134, 142-43, 145, 148, 154
 ʿAtshanah, 150

 Babylon, 94, 154; first dynasty of —, 114, 123
 Badari, 154
 bail handles, 42, 98
 Baisan, 86
 Bait Mirsim, Tell, 31
 Banks, Edgar J., 103, 143, 154
 Bergman, Abraham, x
 Billa, Tell, 150, 154
 Bird-Vase Pit at Tell Asmar (sounding in D 15:3), 27-28
 bird-vases, 43-44, 86, 93
 Bismayah, 101, 112, 143, 147, 154
 Braidwood, Linda S., xxii
 Braidwood, Robert J., xxii, 93, 108, 133
 Brak, Tell, 131, 154
 braziers, 34-35, 42, 55-56, 81, 90, 100-101, 108, 112, 114, 118, 134, 136, 143, 146-47
 British Museum, 69-70
 Brookens, Ruth S., xi
 Brunton, Guy, 85, 154-55
 Buisson, Comte du Mesnil du, 109
 bull-vases, 43, 86
 burial urns, 119
 Burrows, Eric, 43
 "buttress" decoration, 97, 117, 121; *see also* "column" decoration

 Cappadocia, 131
 Carchemish, 132-33
 Caton-Thompson, Gertrude, 154
 censers, 56
 Childe, V. Gordon, 131
 Christian, Viktor, 135
 colanders, 95, 99, 109, 115; *see also* strainers
 "column" decoration, 109, 121, 149; *see also* "buttress" decoration
 Contenau, Georges, xxii
 corrugated pottery, 91, 96, 101, 107-8, 116-18
 cosmetic container, 82
 covers, *see* lids

 Cros, Gaston, xxi, 71, 120, 132, 155
 crucibles, 101, 114, 118
 cup bases, 97, 116
 cut ware, 34, 42, 55-56, 81, 101, 108, 134, 136, 141; *see also* excised decoration
 Cyprus, 131

 Darby, Hamilton D., xi
 Davico, Alberto, x
 Debevoise, Neilson C., x, 103
dégraissant, 31
 Delougaz, Pinhas, vii, xxii
 Dewey, Melvil, 4, 21
 Dhahab, Tell, 154
 Dinella, Carl, xi
 Diyala River, 27
 Diyala ware, 60
 double vessels, *see* multiple vessels
 drains, 59, 97, 104, 112, 114, 118-19, 149
 Duncan, J. Garrow, 155
 Dur Samsuiluna, *see* Samsuiluna

 Earliest Shrine of the Abu Temple, 28
 Egypt, 32, 40, 59, 85, 100, 121, 131, 134, 149
 Elam, 130-31, 139-41, 145, 147
 Eltz, Alexander zu, x
 Engberg, Robert M., 85, 155
 Entemena of Lagash, 30, 105
 Eridu, 35, 154
 Erwin, Hilde, xi
 Eshnunna (Tell Asmar), 27, 148
 excised decoration, 54-55, 139; *see also* cut ware

 Falkenstein, Adam, 135
 Farah, 29, 98, 129-30, 135, 138, 142, 145, 147, 154
 feeding troughs, 112
 fenestrate ware, *see* cut ware
 Field, Henry, 154
 filters, 118, 128; *see also* funnels
 First Imperial period, 109
 Frankfort, Henri, vii, xxi-xxii, 1-3, 43, 69-71, 86, 97, 120, 129-32, 134, 139-40, 145, 149
 "fruit stands," *see* stands
 "fugitive" paint, 60
 funnels, 59, 82, 115, 118, 149

 gashed decoration, 136-37; *see also* excised decoration
 gateposts, representations of, 56
 Gaura, Tepe, 29, 93, 103, 154
 Gautier, J. E., 154-55
 Genouillac, Henri de, xxi, 38-39, 43, 91, 93, 119-21, 126-27, 138, 143, 154-55
 geometric levels, 27
 Gerzean period, 134
 Gezer, 44
 Ghassul, Tulailat, 155
 Ghirshman, Roman, xxi-xxii, 50, 66, 155
 Giyan, Tepe, 83, 131
 goddess-handles, 84-85, 89-90, 142, 144, 146

- Grai Resh, 154
 Grant, Leslie, x
 Greece, 32, 103
 Guy, P. L. O., 85, 155
- Halaf ware, 131
 Hall, H. R., xxii, 155
 Hamah, 109, 154
 Hamilton, R. W., 127, 155
 Hammurabi, 114, 122
 hand-fashioned pottery, definition of, 3
 hand-turned pottery, definition of, 3
 handles, 38, 42, 47, 60, 72, 80, 82-85, 87-90, 92, 96, 98-99, 105-6, 111, 126, 134, 142-47
 Harappa, 103, 144
 Harden, D. B., 54
 Hauser, Elizabeth B., xi
 hedgehog(?) vase, 44
 Heinrich, Ernst, xxi, 98, 138, 154
 Herzfeld, Ernst, 154
 Heuzey, Léon, 120
 Hilprecht, H. V., 106, 155
 Hissar, Tepe, 50
 holes at bases of vessels, 107-8, 111-12, 115, 118, 122
 Hough, Luin W., xi
 human beings, representations of, 67-68, 70-71, 82, 86, 89, 120-21
 Hurrians, 150
 Hutchinson, R. W., 127
- Ibalpiel I, 114, 118
 impressed decoration, 54-55, 98, 101-3, 114, 119-20, 149
 incised decoration, 35, 37-39, 54-55, 57, 59, 81-83, 85, 87-91, 96, 98, 106, 114, 116, 119-20, 125-26, 134, 136-37, 141-43, 149; *see also* scored decoration
 Indus Valley, 85, 103, 110, 144
 Ingholt, Harald, 109, 154
 Interimperial period, 109
 Iran, 44, 50, 60, 66, 69, 71, 83, 85, 93-94, 102, 120, 126, 130-31, 139-45, 147, 149-50
 Iraq Museum, Baghdad, 67, 162, 167
 Ishchali, location of, 27
 Isin-Larsa period, *see* Larsa period
- Jacobsen, Rigmor, x
 Jacobsen, Thorkild, xxi, 29-30, 59, 105, 109, 114, 145
 Jamdat Nasr, 29, 34, 36-39, 42-45, 47, 49-50, 67, 126-28, 130, 132, 137, 154; — period, 44, 126, 129, 138; — ware, definition of, 48-49; — ware, origin of, 130-32
 jewel boxes, 87, 103, 117
 Judaidah, Tell al-, 93, 108
- Kantor, Helene J., 134
 Kassite period, 151
 Kelso, James Leon, 31
 kernos ring, 103
 Khafajah, location of, 27
 Khazinah, Tepe, 69, 154
 Khorsabad, 154
 Khubair, Tell, 38
 Kish, 29, 39, 54, 58, 85, 90-92, 94, 97-98, 128, 137, 142, 144, 146, 150, 154
 kitchen ranges, 108, 112
 Kititum Temple at Ishchali, 30
 Koepfel, Robert, 93, 155
 Koldewey, Robert, 100, 154
- ladles, 98, 109, 112; *see also* spoons
 Lamont, Robert S., 85
 Lampre, G., 154-55
 lamps, 43, 114, 122
 Langdon, Stephen, xxi, 56, 92, 131, 154
 Larsa period, division of, 114, 148
 levels, geometric, 27
 Levy, G. Rachel, x-xi
 lids, 39, 41-42, 53, 60, 81, 95, 98, 104, 108-9, 113-15, 122, 129, 149
 Lloyd, Seton, ix, xxi-xxii, 35, 48, 131, 154-55
 Loftus, W. K., 1, 3
 Loud, Gordon, 85, 94, 154
 lugs, purpose of, 41, 53
- Macalister, R. A. Stewart, 85
 Mackay, Ernest, xxi, 34, 36-39, 42, 44-45, 47, 49, 67, 85, 90-92, 94, 97-98, 103, 126-27, 130, 137, 143-44, 154-55
 Makran, 154
 Mallon, Alexis, 93, 155
 Mallowan, M. E. L., 44, 127, 154-55
 Mari, 141, 145, 154
 Martin, Richard A., 154
 Matson, Frederick R., 31
 May, Herbert Gordon, 103
 McCown, Donald E., xxii
 McEwan, Calvin W., x
 measuring pitcher, 38
 Mécquenem, Roland de, 155
 Megiddo, 103
 metalwork, imitation of, 53, 106, 121, 124
 mica flakes in Protoliterate pottery, 50
 Min, symbol of, 59
 Mohenjo Daro, 144, 155
 Mostagedda, 155
 Müller, Bartow, x
 multiple vessels, 40, 45, 81-82, 107
 music scenes, 70-71
 Musyan, Tepe, 130-31, 139, 155
 Myres, John L., 1
- narrative scenes, 67-70, 88; *see also* representational designs
 Neuville, René, 93, 155
 Newberry, P. E., 59
niknakku, 56
 Nineveh, 127, 134, 155
 Ninevite 5 ware, 76, 141
 Nintu Temple at Khafajah, 29-30
 Nippur, 106, 127, 129, 155
 Nish, Tell al-, 155
 nonfast paint, *see* "fugitive" paint
 North Syria, *see* Syria
 Northern Palace at Tell Asmar, 30
 Nuzi, 86, 121, 148-50, 155
- obsidian fragments, 29
 orange pottery, 58
 Oriental Institute Museum, Chicago, 162, 167
 Osten, Hans Henning von der, 85
- Palace of the Rulers at Tell Asmar, 30
 Palestine, 31, 44, 85-86, 93, 103, 131, 155
 Pallis, Svend Aage, 146-47
 Parrot, André, 141, 150, 154
 Peters, John Punnett, 129
 :

- Petrie, W. M. Flinders, vii, x, 5, 121
 pig-shaped vessel, 44
 Pit under the Akkadian Houses at Tell Asmar (sounding in H 18:14), 27-28
 plano-convex containers, 82, 103
 plastic decoration, 38, 53, 60, 72, 77, 81-82, 89, 92-94, 97, 101-2, 106, 109-11, 114, 117, 120-23, 143-44, 149; *see also* ribbed pottery, ridges, *and* studded ware
 polychrome, definition of, 35
 potters' marks, 47, 57, 59, 103, 112
 potter's wheel, 32
 pottery type, definition of, 19
 Preusser, Conrad, x, 145
 pricked decoration, 98, 103, 119-20, 143, 149
 private houses, 29-30
 Protoimperial period, definition of, 30, 105
 Protoliterate period, definition and division of, 27-29, 44, 126
 punctate decoration, 54-55
 Purill, Nancy, xi
- Qatna, 109
 Quibell, J. E., 121
- ram-vases, 86, 93-94, 112, 122, 143
 ranges, kitchen, 108, 112
 rattles, 122
 reed decoration, 101, 121
 relief decoration, *see* plastic decoration
 representational designs, 44-46, 49, 62, 65-72, 82, 88, 91, 102, 120, 140-41, 143-44, 149
 reserved-slip decoration, 33, 35, 37, 44, 53-54, 56-57, 60, 73-74, 76-78, 80-81, 83, 125, 133-34, 138, 141, 143
 Reuther, Oscar, 93, 154
 ribbed pottery, 96-97, 101, 105, 107-8, 110-12, 116-18, 146-47
 ridges on pottery, 41, 45, 47, 52-53, 55, 58, 60, 63, 72, 80, 83, 85, 90-91, 96-97, 101, 104, 107-8, 111, 113, 116, 119-20, 126-27, 136-37, 140-43, 147, 149; *see also* ribbed pottery
 ritual utensils, 37-38, 42-44, 50, 56-57, 81, 85-86, 92-94, 109, 112, 122, 136, 143
 Rose, J. C., 154
 Rowe, Alan, 86
- Safar, Fuad, 155
 safes, 87, 103, 117
 Samsuiluna son of Hammurabi, 30, 123, 150
 Sargon of Agade, 30, 105
 Sarzec, Ernest de, 155
 scarlet ware, definition of, 60
 Schmidt, Erich F., 50, 85, 138, 154
 scored decoration, 39, 76, 125; *see also* incised decoration
 scorpions in relief, 121
 scraped decoration, 84, 87-88, 90, 96
 Sellin, Ernst, 131
 seven-spouted pot, 43
 Shaghir Bazar, Tell, 150, 155
 Shara Temple at Tell Agrab, 28, 30
 Shipton, Geoffrey M., 85
sikkatu, 50
 Sin Temple at Khafajah, 28-30
 Single-Shrine Temple at Tell Asmar, 30
 Siyalk, Tepe, 50, 155
 Small Temple at Khafajah, 29-30
 Smith, Sidney, 70
- snake decoration, applied, 38, 53, 77, 81-82, 92-93, 102, 111, 121-22, 143
 Snake Shrine at Tell Asmar, 93, 122
 Speiser, E. A., 69, 93, 103, 135, 150, 154
 spoons, 98, 109, 115; *see also* ladles
 Square Temple at Tell Asmar, 30
 stands, 34-35, 39, 42, 55-56, 73, 81, 85, 90-91, 105, 134, 136, 139, 141-47
 Starr, Richard F. S., xxii, 81, 86, 121, 149, 155
 Stefanski, Elizabeth, xi
 Stein, Aurel, 40, 67, 154
 stone imitations of ceramic forms, 39
 stone vessels, imitations of, 53, 58, 82-83, 95, 136-38
 stoppers, 95, 100, 103, 108, 117
 strainers, 74, 95, 109, 118, 139; *see also* colanders
 studded ware, 85, 102, 105, 110, 144, 146-47
 Susa, 44, 50, 60, 71, 93-94, 102, 120, 126, 130-31, 139, 142, 144, 149-50, 155; — II type pottery, 130, 132, 140
 Swanson, J., xi
 Syria, 31, 93, 108-9, 130-33, 147, 150
- Ta'annek, Tell, 131
 tablets, inscribed clay, 28, 34, 51
 Telloh, 39, 43, 71, 91, 93, 120, 126-27, 129, 132, 138, 142-43, 145-46, 149, 155
 tempering materials, 31-32, 34-45, 41
 Temple Oval at Khafajah, 30
 theriomorphic vessels, 43-44, 86, 93-94, 109, 112, 122, 143
 Thompson, R. Campbell, 127, 154-55
 Thorley, J. Pallin, 31
 Tigris River, 27
 Tobler, John, x
 tools used in pottery-making, 33, 122
 Toscanne, Paul, 93
 toys, 94, 122
 tripod bases, 82, 102, 105, 123, 142
 Tulailat Ghassul, 155
 type, definition of, 19
- U'bad, al-, 126, 130, 133, 138, 142, 147; — clay sickles, 29; — painted pottery, 29, 47, 57, 125, 132-33; — period, 130
 Unger, Eckhard, 120
 University Museum, Philadelphia, ix-x, 123, 162, 167
 U'qair, Tell, 35, 39, 41, 45, 48-49, 57, 127-29, 136-38, 155
 Ur, 56, 70-71, 91-92, 94, 106, 127, 129-30, 132-33, 137-38, 142-47, 149, 155
 Uruk period, 43-44; *see also* Warka wares
- Van Buren, E. Douglas, 72
 Vats, Madho Sarup, 103
 Vincent, Hugues, 44, 155
 votive bowls, 39, 127-28
- wagons, 85-86, 93-94, 112, 143
 wall painting, 35, 46
 Warka, 29, 34-35, 37-39, 43, 60, 128-29, 138, 147, 155; — wares, 29, 58, 125, 137-38
 wash basin, 119
 Watelin, Louis Charles, xxi, 154
 wet-smoothing, definition of, 33
 wheel-turned pottery, definition of, 3
 white-filled decoration, 82, 98, 102, 114, 119-20, 143, 149
 Woolley, C. Leonard, xxii, 71, 91, 129, 131-33, 137-38, 146-47, 155
 Works Projects Administration, xi
- Zagros Mountains, 27
 Zervos, Christian, 106

PLATES



Kh. IX 159

Actual Size

PAINTED AND BURNISHED VASE, ONE OF THE EARLIEST SPECIMENS FROM KHAFAJAH



Kh. IX 196



Kh. IX 194

Scale, 1:2

TWO VESSELS FROM KHAFAJAH. ABOVE, A RARE VASE WITH FINE SLIP AND BURNISH FROM A LATE PROTO-LITERATE OR EARLY DYNASTIC I LEVEL. BELOW, A PAINTED POT OF THE PROTO-LITERATE PERIOD WHICH INDICATES THAT IN ADDITION TO RED AND BLACK PAINT SOME OTHER PIGMENT WAS USED FOR POTTERY DECORATION



As. 34:246

Scale, 1:3



Kh. IX 163

Scale, 2:3

TWO VESSELS WITH MONOCHROME DECORATION. ABOVE, A VASE OF THE PROTO-LITERATE PERIOD WITH REALISTIC DESIGN, FROM THE EARLIEST SHRINE OF THE ABU TEMPLE AT TELL ASMAR. BELOW, A BOWL FOUND IN A PROTO-LITERATE LEVEL AT KHAFAJAH



Kh. IX 49



Kh. IX 198



Ag. 36:520



Ag. 36:526

Scale, 2:3

FOUR PAINTED POTSDHERDS: KH. IX 49, A UNIQUE SPECIMEN FROM THE LOWEST LEVEL AT KHAFAJAH; KH. IX 198, A SHERD WITH MONOCHROME ANIMAL DESIGN OF THE PROTO-LITERATE PERIOD FROM KHAFAJAH; AG. 36:520 AND 526, SHERDS WITH POLYCHROME DESIGNS FOUND IN HOUSES OF EARLY DYNASTIC I AT TELL AGRAB

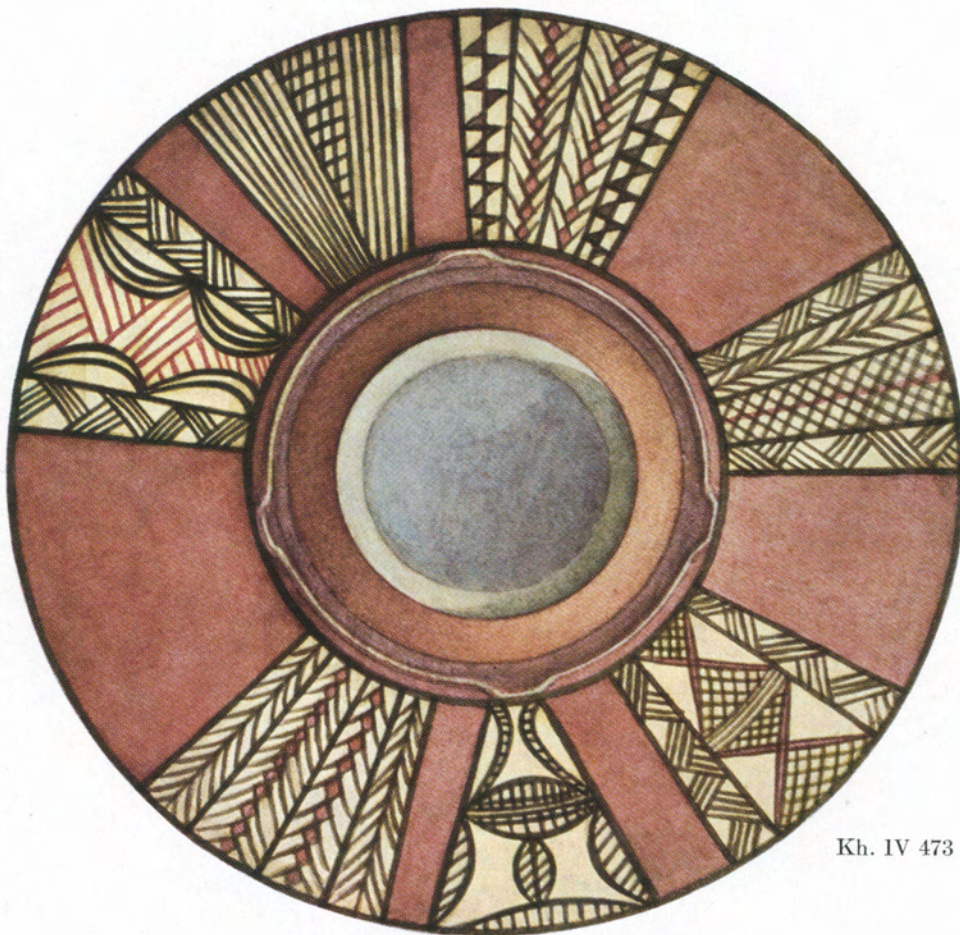

Kh. IV 473

Scale, 1:3



Kh. IX 149

Scale, 3:10

SHOULDER OF A LARGE VASE OF THE PROTO-LITERATE PERIOD FROM KHAFAJAH



Kh. V 173



Scale, 1:2

BIRD-VASE FOUND IN AN EARLY DYNASTIC II LEVEL OF THE SMALL TEMPLE AT KHAFAJAH



Kh. IX 101
Scale, 1:3



Kh. IX 153
Scale, 1:3



Kh. IX 102
Scale, 2:5



Kh. IX 157
Scale, 1:3

FOUR PAINTED VASES FROM KHAFAJAH ILLUSTRATING THE TRANSITION FROM JAMDAT NASH POLYCHROME
(KH. IX 101) TO SCARLET WARE



Kh. VI 69
Scale, 2:5

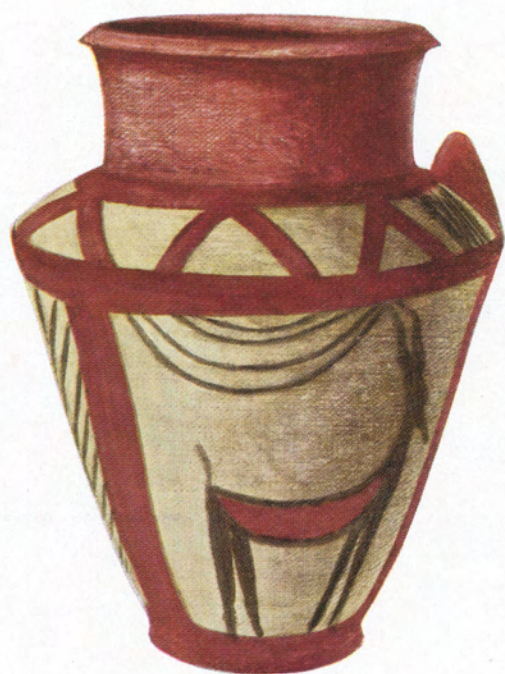

Kh. IX 164



Kh. IX 100

Scale, 1:2

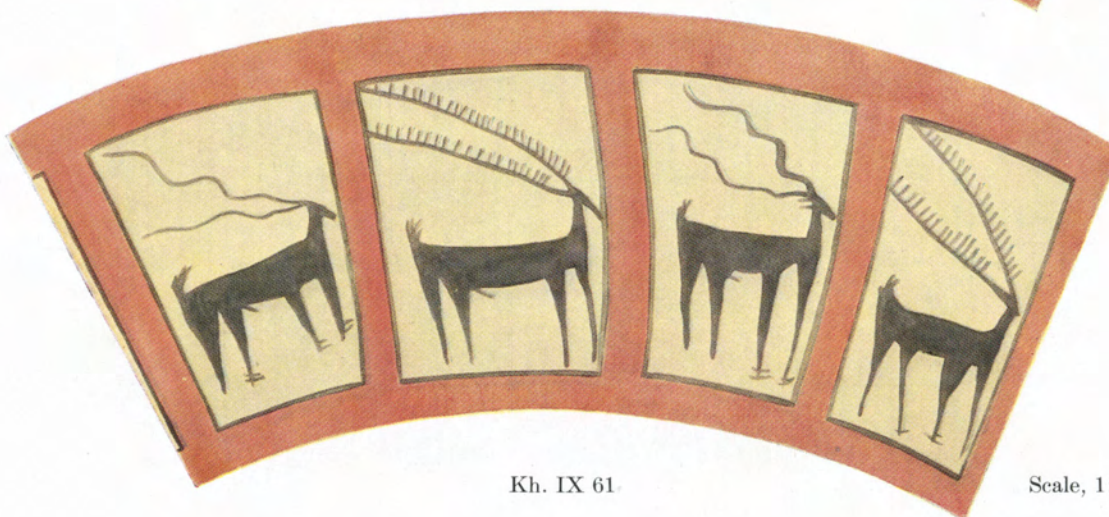
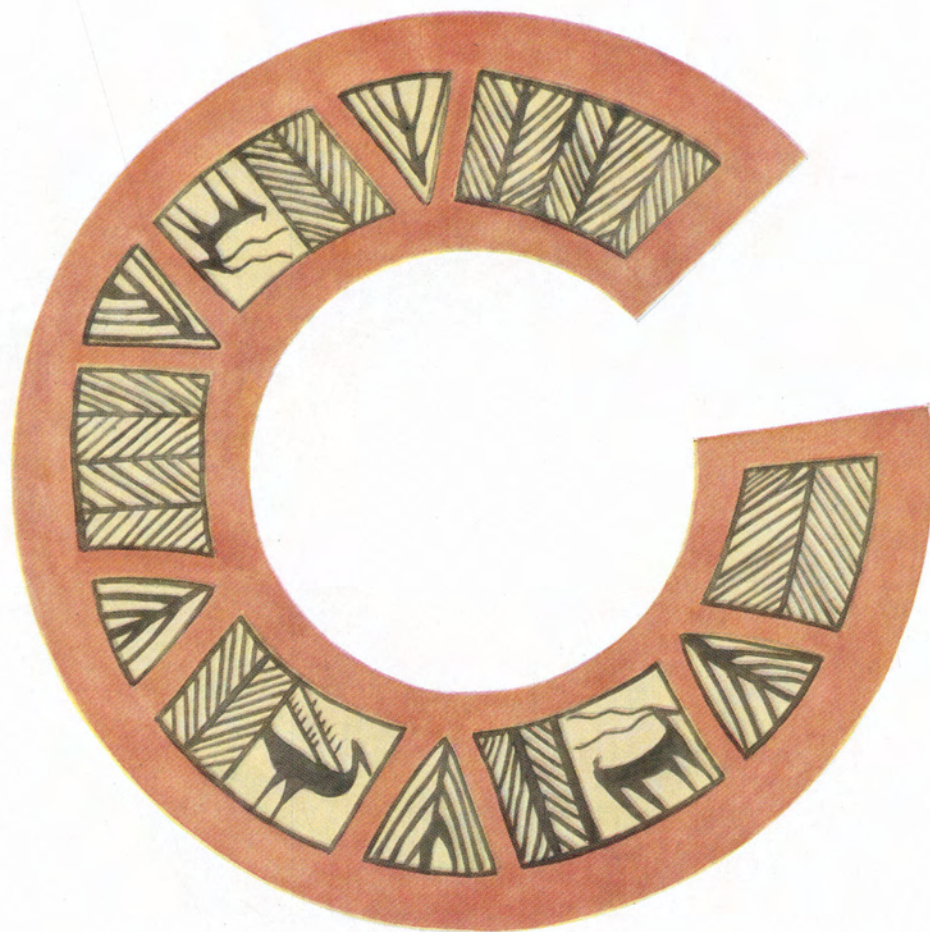

Kh. IX 61

Scale, 1:3



Scale, 1:6



Scale, 1:3

Ag. 35:1032



Scale, 1:4



Scale, 1:2

Ag. 36:580



Kh. IX 60

Scale, 1:2

ONE OF THE EARLIEST SPECIMENS OF SCARLET WARE FROM KHAFAJAH

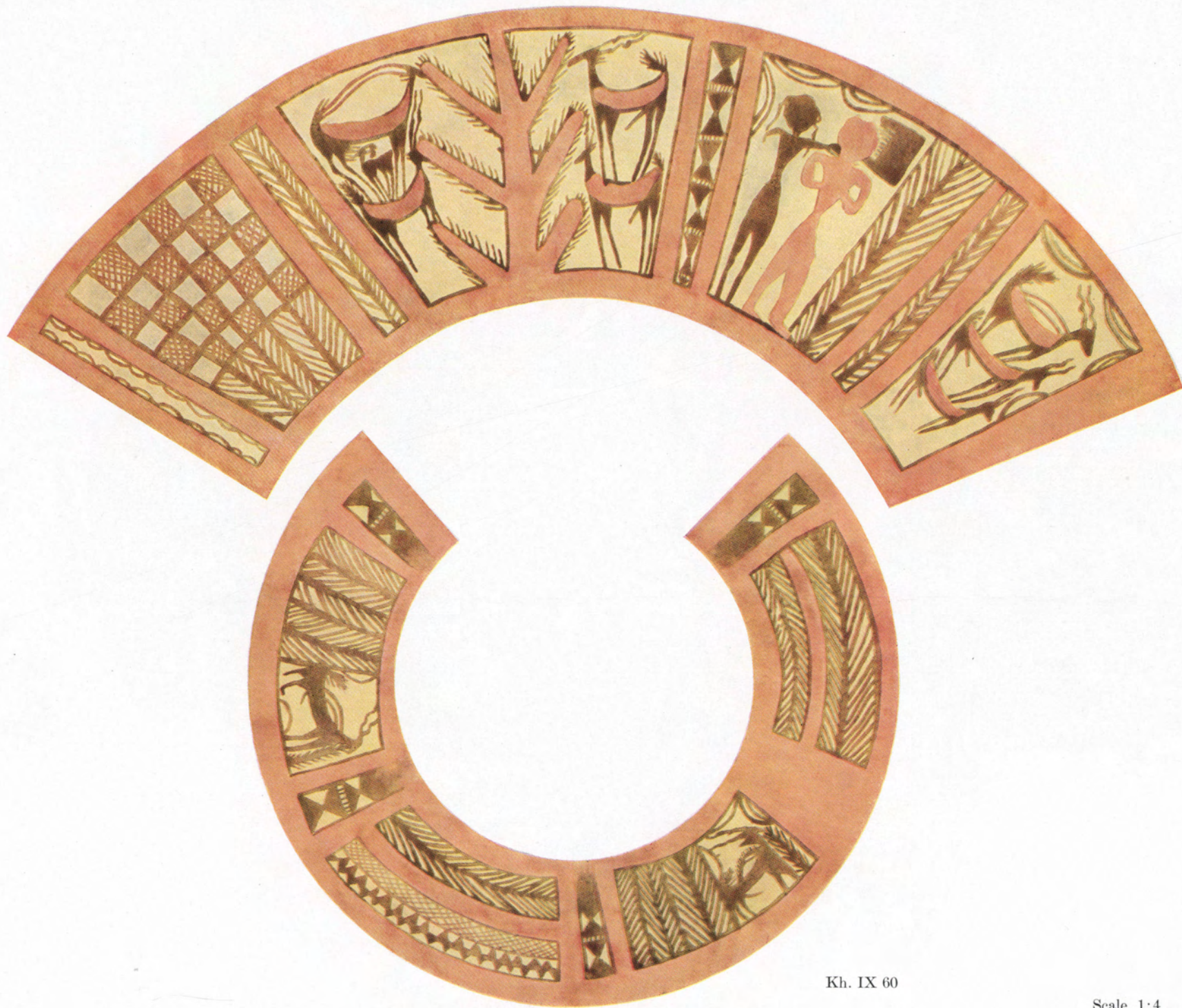

Kh. IX 60

Scale, 1:4

DEVELOPMENT OF DESIGNS ON VASE SHOWN IN PLATE 13

PLATE 14



Kh. IX 150

Scale, 3:5

ONE OF THE LATEST SPECIMENS OF SCARLET WARE FROM KHAFAJAH



Kh. IX 104

Scale, 2:5

RED-PAINTED VASE OF THE END OF EARLY DYNASTIC I FROM KHAFAJAH

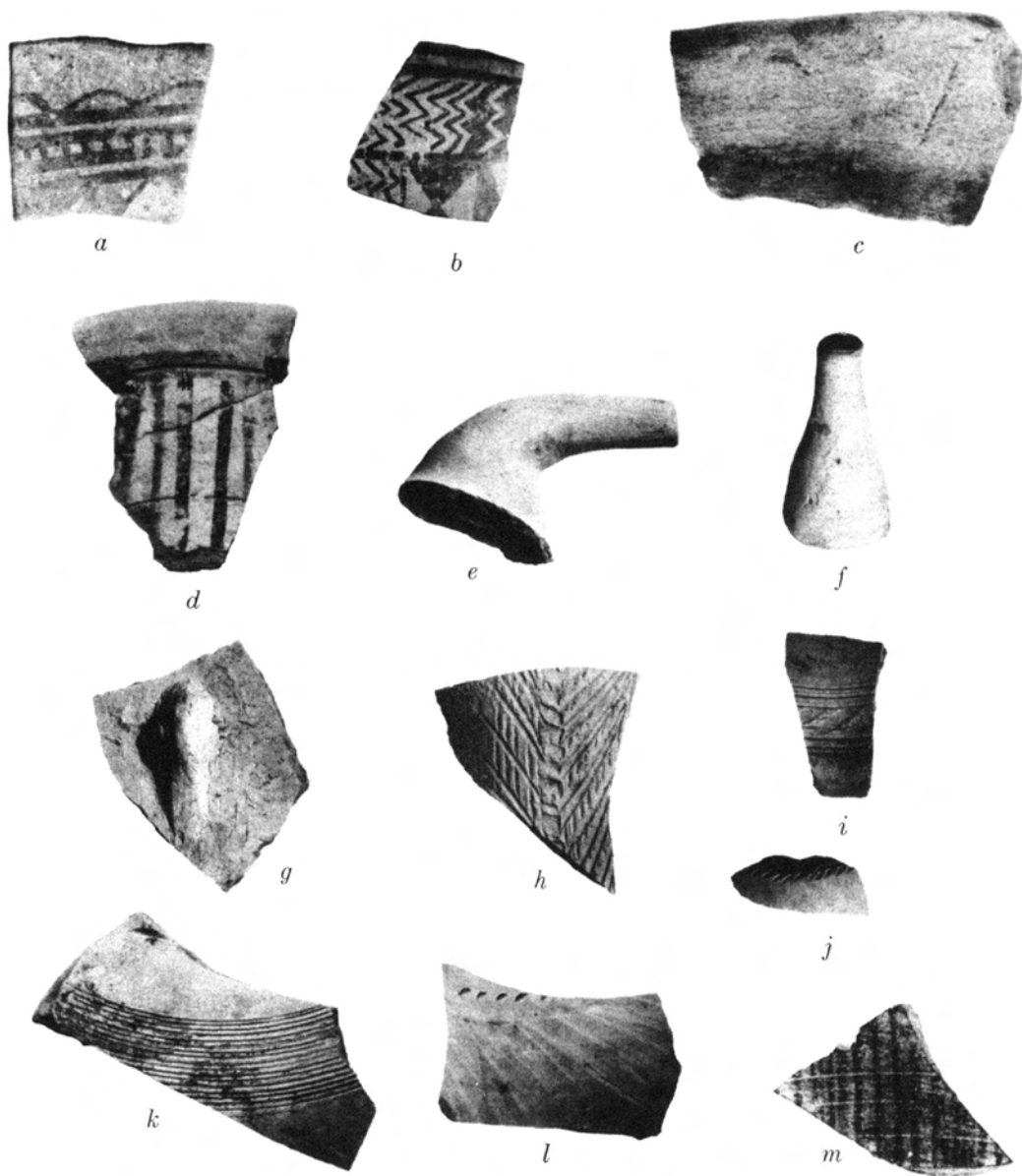

UBAID REMAINS (a-c) FROM TELL AGRAB AND KHAFAJAH, PROTOLITERATE
 SHERDS (d-m) FROM KHAFAJAH. SCALE, 2:5

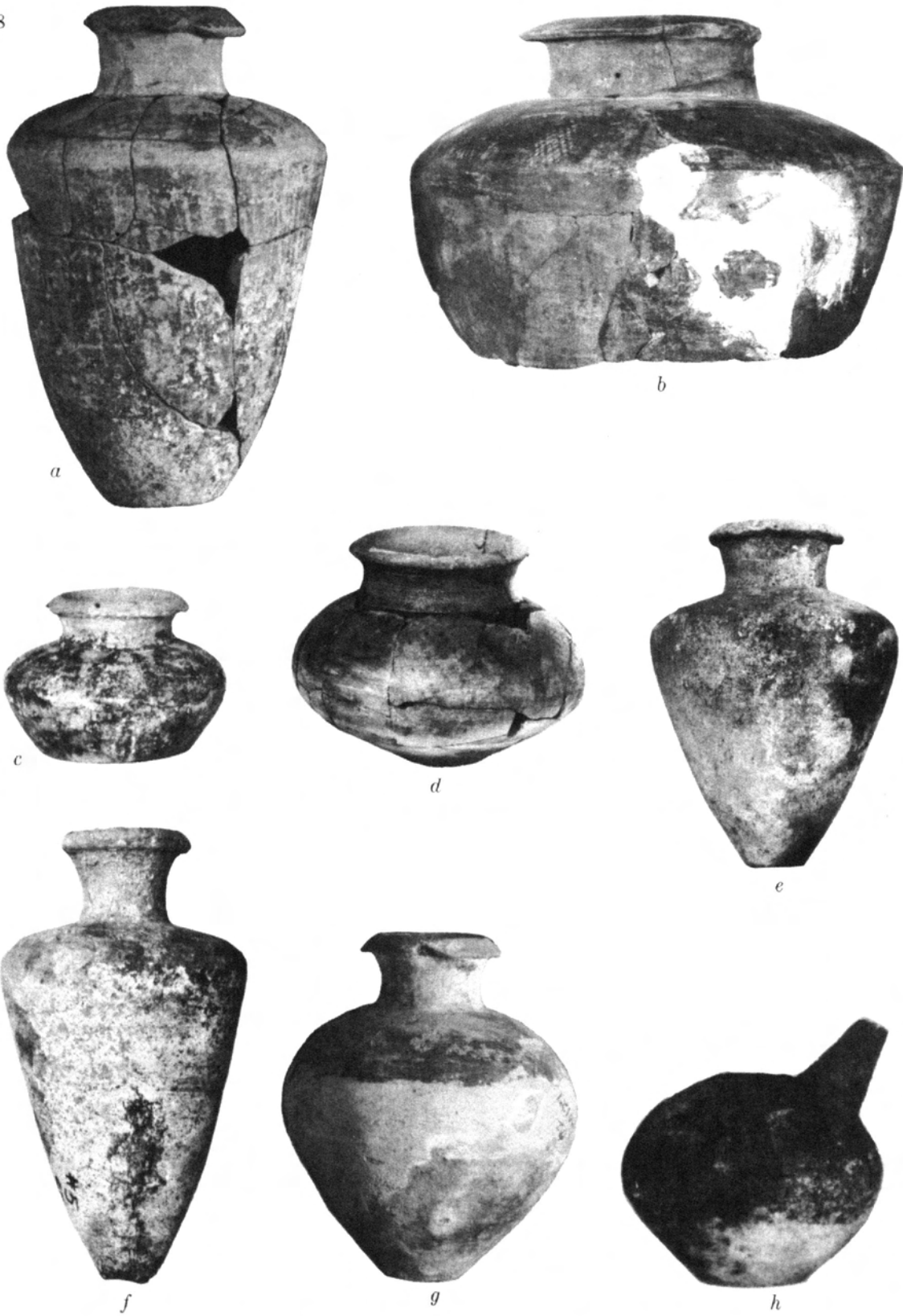

PROTOLITERATE POTTERY FROM KHAFAJAH. SCALE, 2:5

a C.516.270	c B.513.170	e C.536.270	g C.535.240
b C.516.270	d B.653.240 (= Pl. 133 b)	f C.537.270	h B.544.222

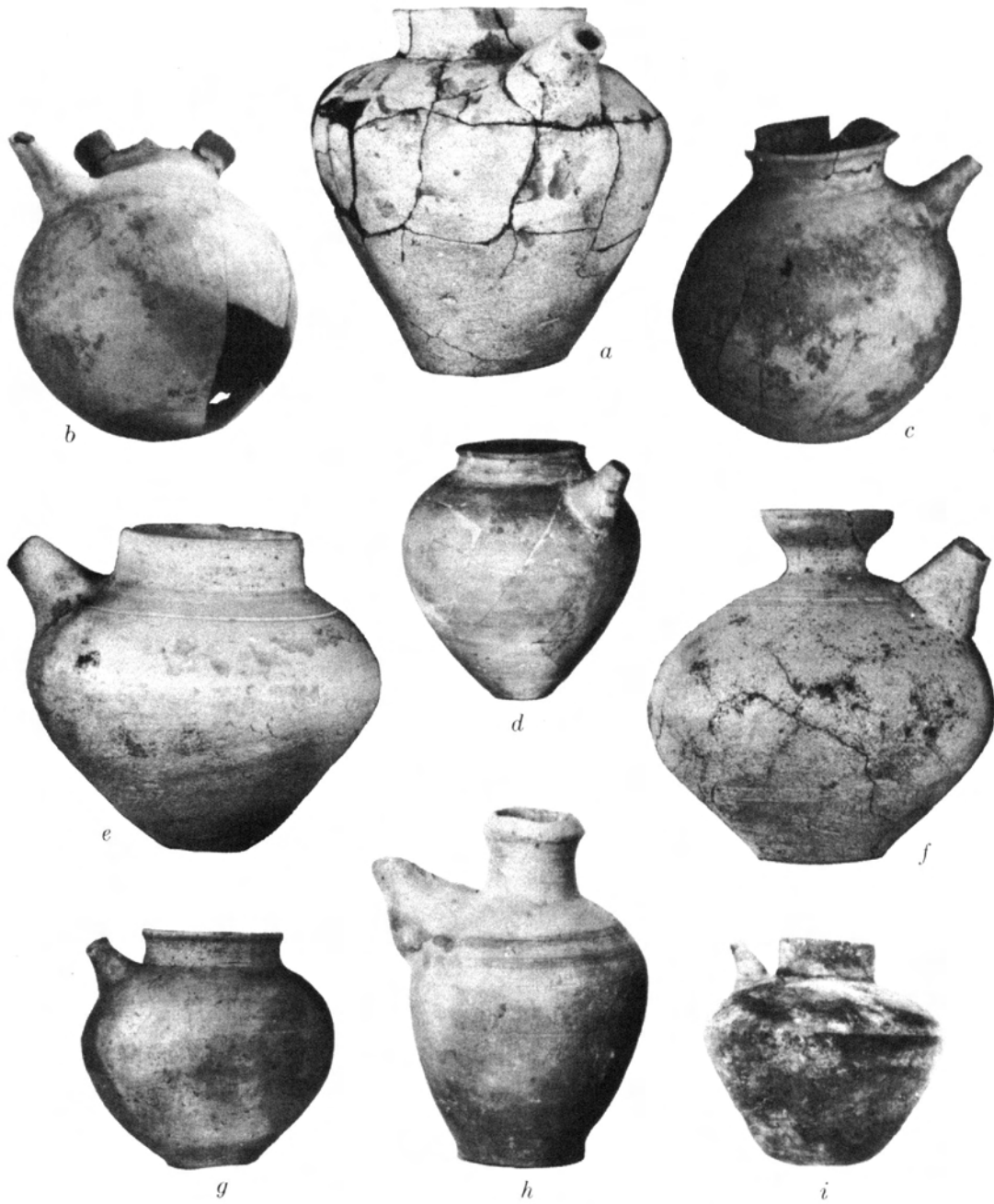

SPOUTED JARS OF THE PROTOLITERATE PERIOD FROM KHAFAJAH
 SCALE, 2:5 (a, e, f, h) AND 1:5 (b-d, g, i)

- | | | |
|-------------|-------------|-------------|
| a C.534.262 | d C.535.242 | g C.534.222 |
| b C.655.222 | e C.534.222 | h B.546.242 |
| c C.654.242 | f C.665.222 | i C.524.262 |

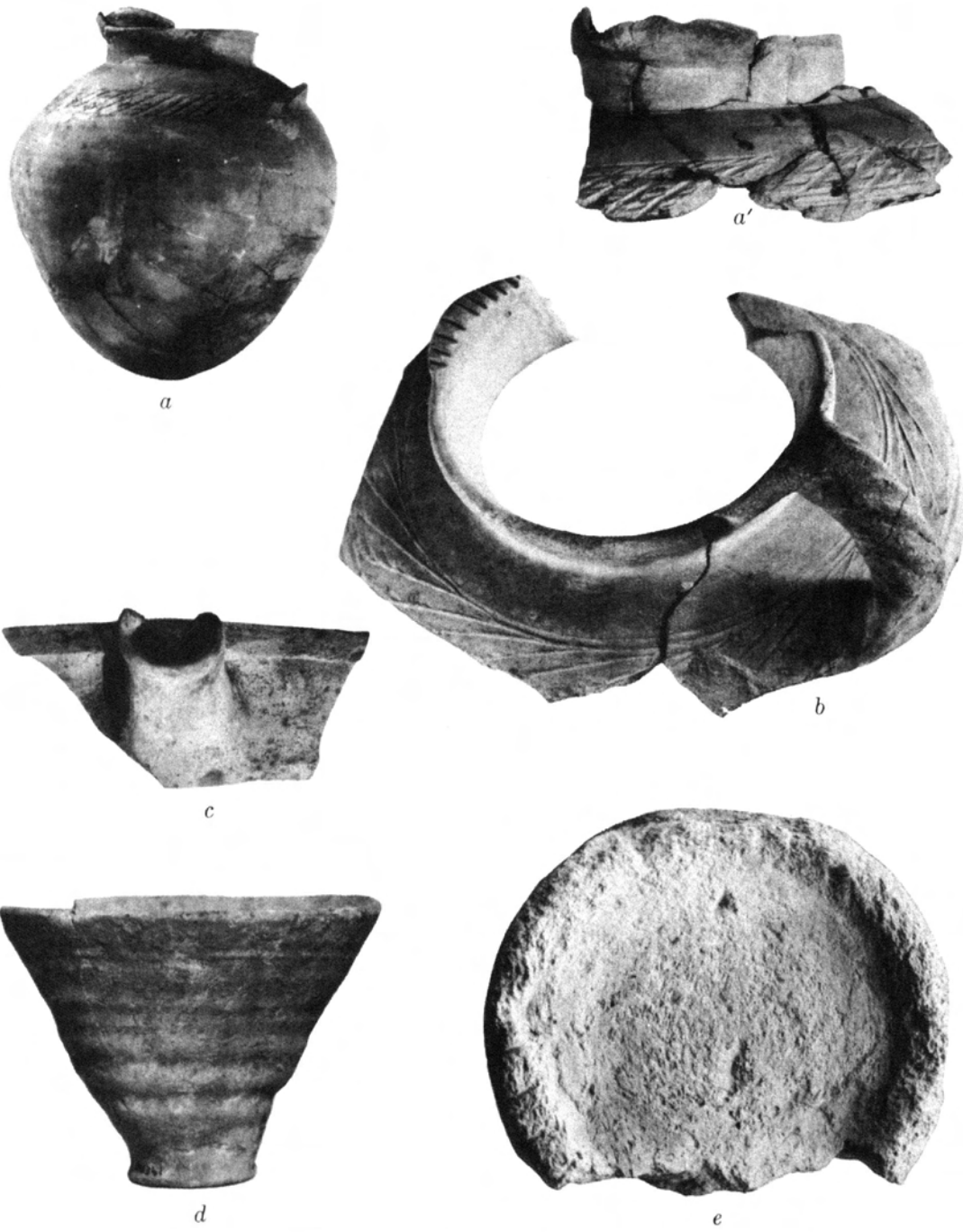

PROTOLITERATE POTTERY FROM KHAFAJAH AND A FRAGMENTARY VESSEL (b)
FROM TELL KHUBAIR. SCALE, 1:5 (a) AND 2:5 (a'-e)
a-a' D.545.626 d B.003.200b e C.200.210

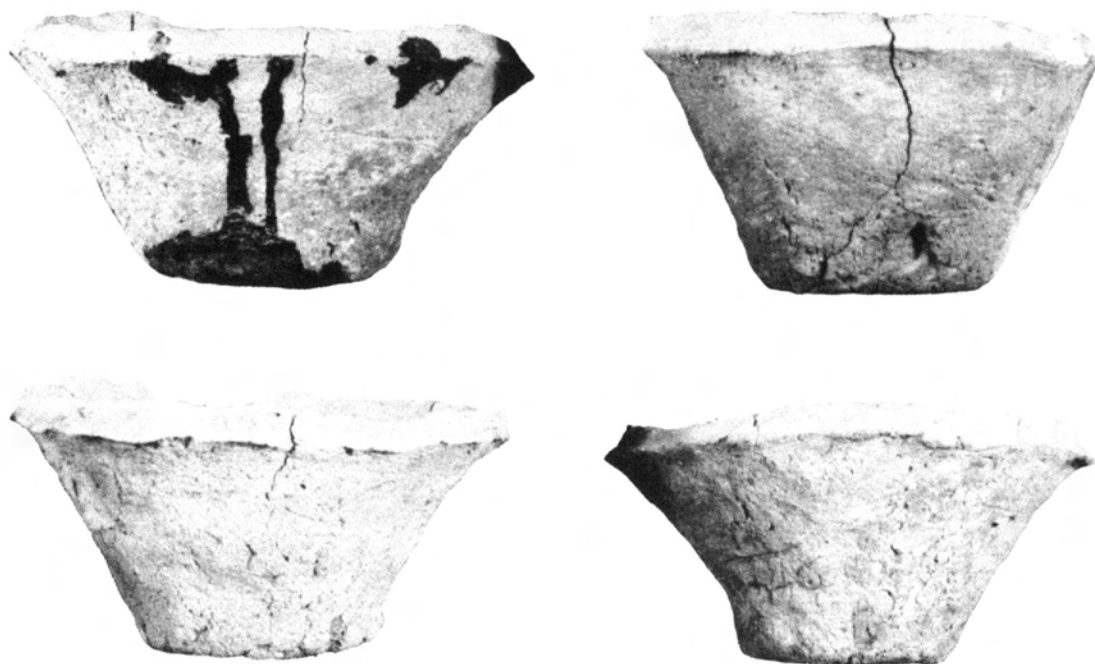

a

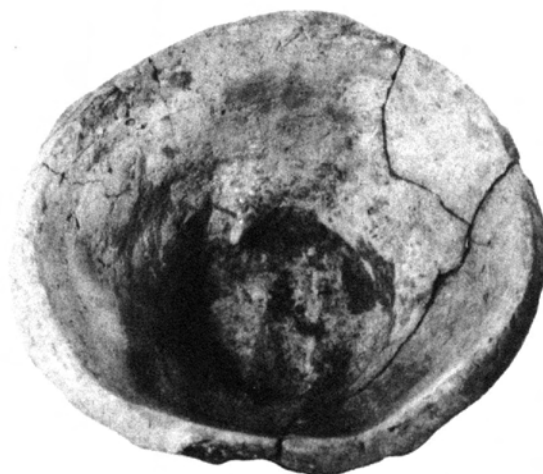

b

CRUDE BOWLS (C.002.210) OF PROTOLITERATE *c* FROM KHAFAJAH. SCALE, 2:5



FOUR-LUGGED JARS OF THE PROTOLITERATE PERIOD FROM TELL AGRAB (c)
AND KHAFAJAH. SCALE, 4:5 (a-c) AND 2:5 (d-h)

a A.633.263	c B.663.213	e B.455.253	g C.634.253
b A.604.223	d C.413.253a	f B.493.253	h C.603.253



PROTOLITERATE POTTERY FROM KHAFAJAH. SCALE, 2:5

- | | | | |
|--------------------|--------------------|--------------------|--------------------|
| <i>a</i> C.654.240 | <i>d</i> C.743.510 | <i>g</i> A.514.260 | <i>j</i> B.041.500 |
| <i>b</i> A.527.760 | <i>e</i> B.703.240 | <i>h</i> B.603.240 | <i>k</i> C.535.240 |
| <i>c</i> C.544.540 | <i>f</i> B.414.270 | <i>i</i> C.041.500 | <i>l</i> B.516.273 |

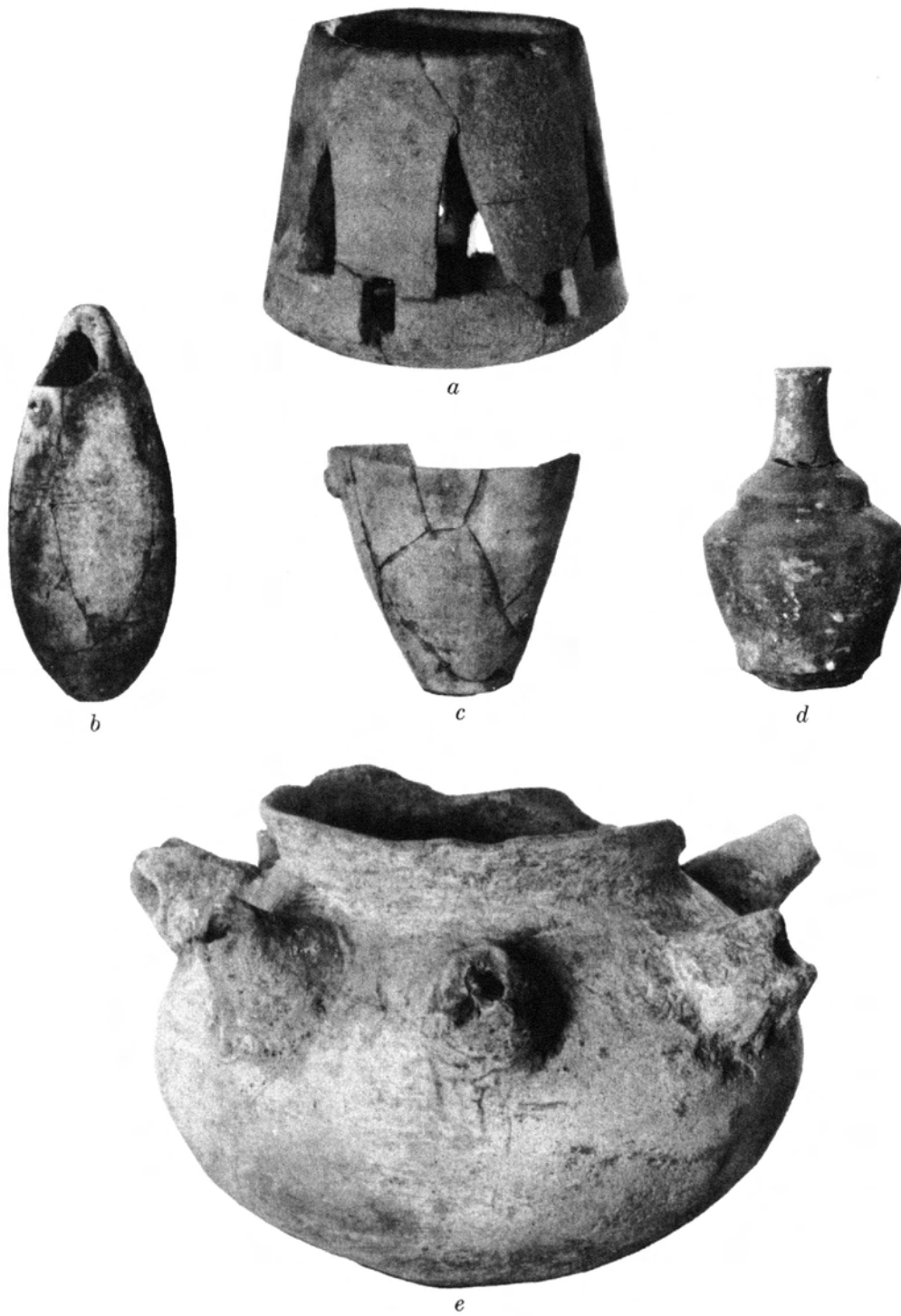

UNUSUAL VESSELS OF THE PROTOLITERATE PERIOD FROM KHAFAJAH

SCALE, 2:5 (a-d) AND 4:5 (e)

a C.305.400 c B.034.203 e C.654.222
b B.757.605 d B.466.260



a



b

A BIRD-VASE (C.95) AND A BULL-VASE (C.96) FROM SIN TEMPLE III AND IV
RESPECTIVELY AT KHAFAJAH. SCALE, *ca.* 2:5 (*a*) AND *ca.* 1:5 (*b*)



TWO MORE VIEWS OF BULL-VASE SHOWN IN PLATE 25 *b*. SCALE, *ca.* 1:5



PAINTED BIRD-VASE (C.95) FROM SMALL TEMPLE VI AT KHAFAJAH, PROBABLY
A SURVIVAL FROM THE PROTOLITERATE PERIOD. SCALE, *ca.* 2:5



a



b



c



d

MONOCHROME-PAINTED FOUR-LUGGED JARS FROM SIN TEMPLE
I (*a-b*) AND III (*c*) AT KHAFAJAH. SCALE, 2:5
a C.494.253 *b* C.493.253 *c* C.603.253*a*

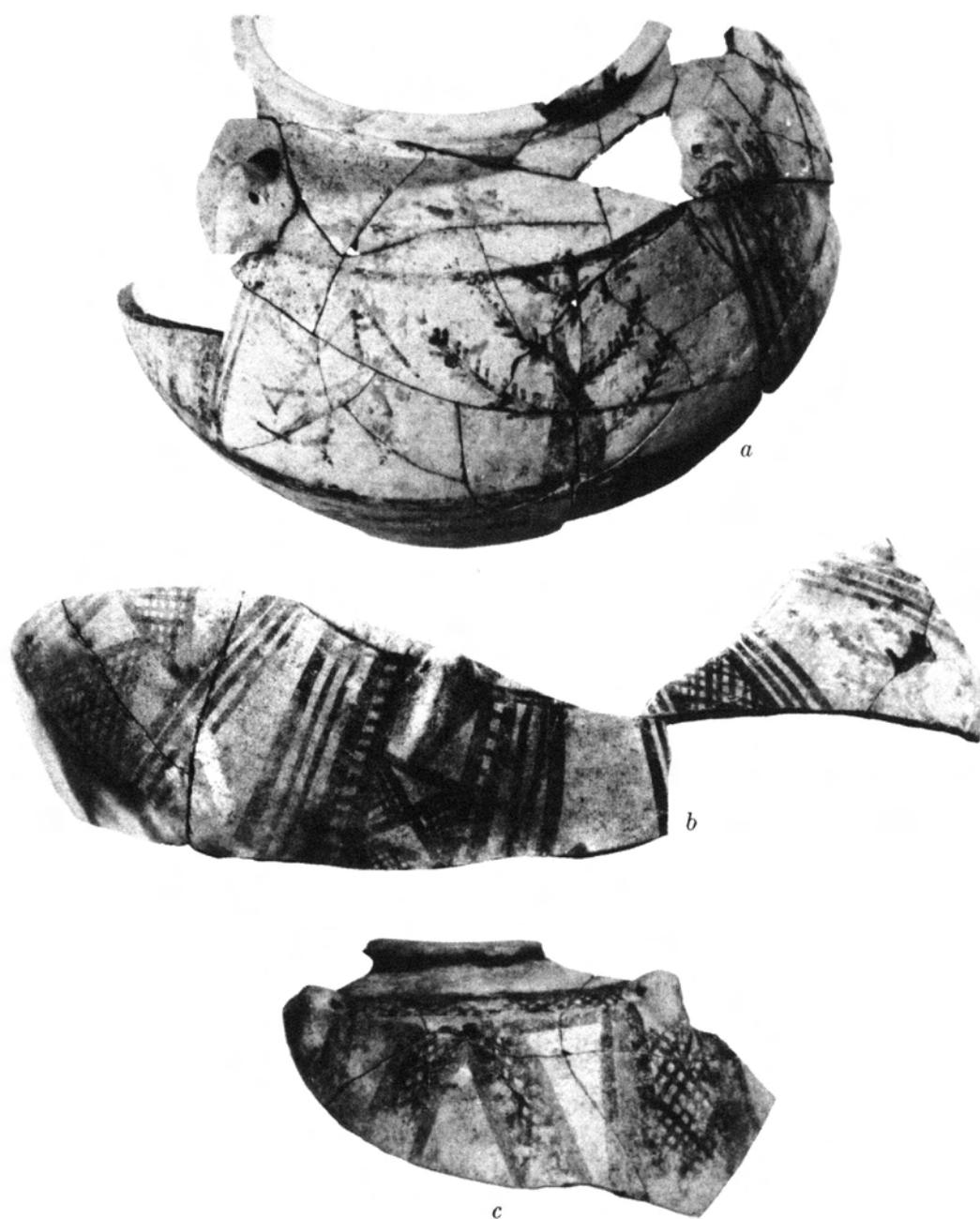

FRAGMENTS OF MONOCHROME-PAINTED (*a-b*) AND POLYCHROME (*c*) FOUR-LUGGED JARS
FROM SIN TEMPLE I (*c*) AND III (*a-b*) AT KHAFAJAH. SCALE, 2:5
a C.494.273 *b* C.49-.53 *c* C.49-.53



MONOCHROME-PAINTED SPOUTED VASE (C.545.342) FROM THE EARLIEST SHRINE
OF THE ABU TEMPLE AT TELL ASMAR. SCALE, 2:5



a



b



c

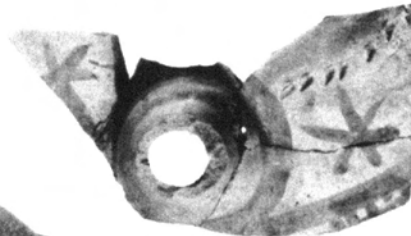

c'



d

FRAGMENTS OF MONOCHROME-PAINTED SPOUTED JARS OF THE PROTOLITERATE PERIOD
FROM KHAFAJAH. SCALE, 4:5 (*a*) AND 2:5 (*b-d*)
d D.535.342



MONOCHROME-PAINTED VESSELS OF THE PROTOLITERATE PERIOD FROM KHAFAJAH. SCALE, 2:5

a C.603.200

c C.605.340

b C.744.220

d C.412.253

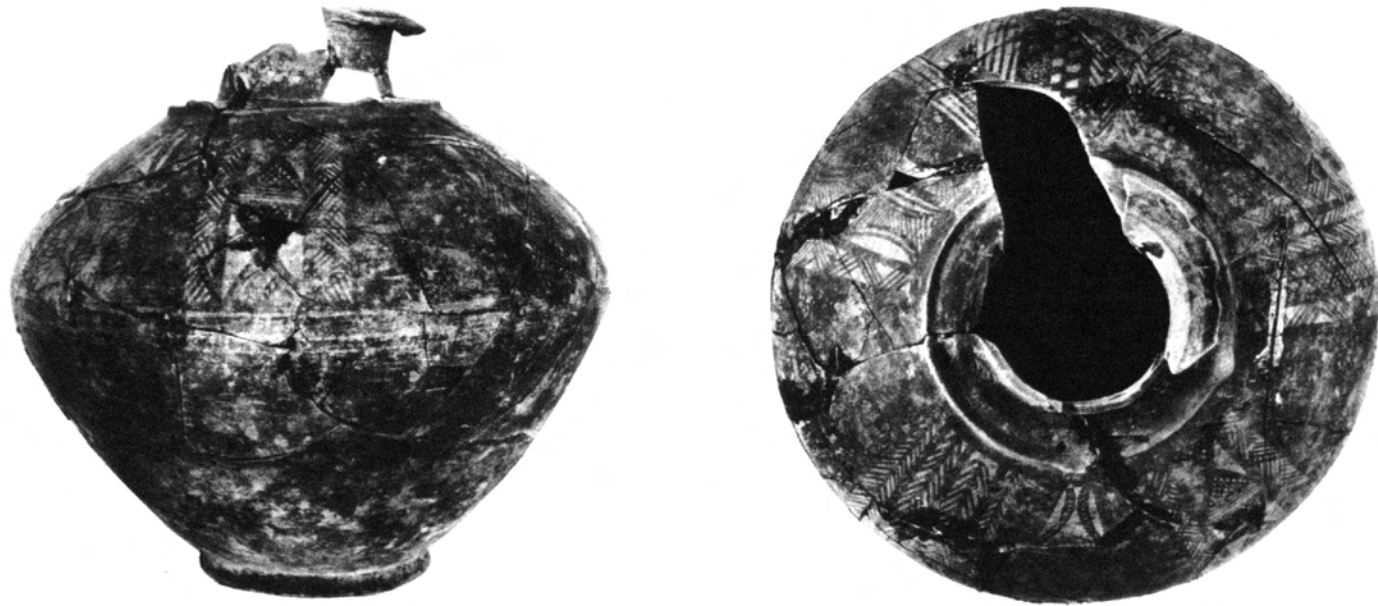

VASE (C.604.370) OF PROTOLITERATE LATE POLYCHROME WARE FOUND IN
TEMPLE OVAL I AT KHAFAJAH. SCALE, 1:4



VASE (D.515.370) OF PROTOLITERATE LATE POLYCHROME WARE FROM KHAFAJAH. SCALE, 2:5

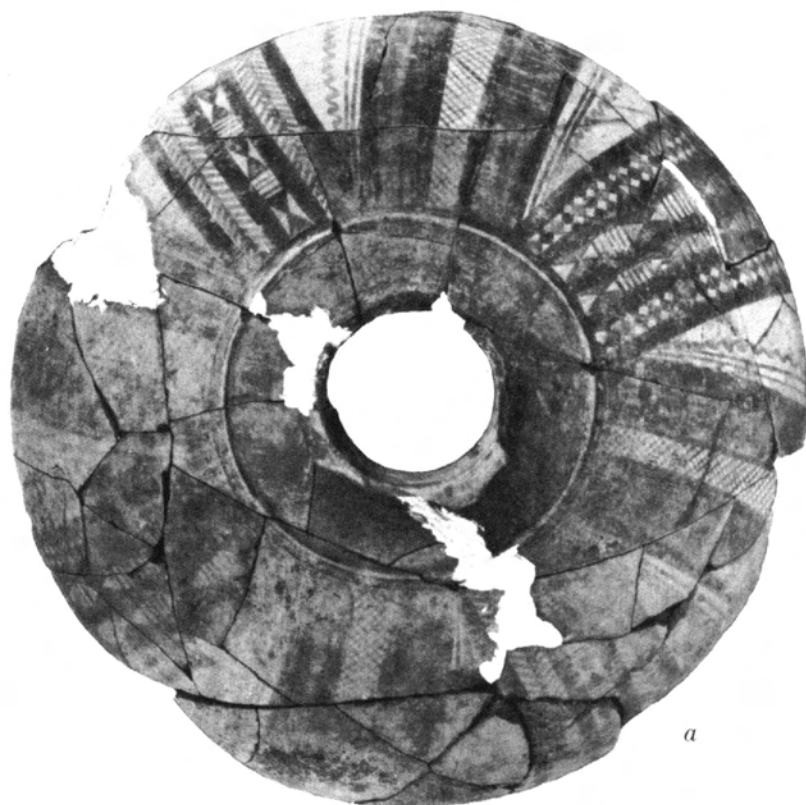

VASES OF PROTOLITERATE LATE POLYCHROME WARE FROM KHAFAJAH. SCALE, 1:5 (a) AND 2:5 (b)
a D.524.370 *b* D.544.340

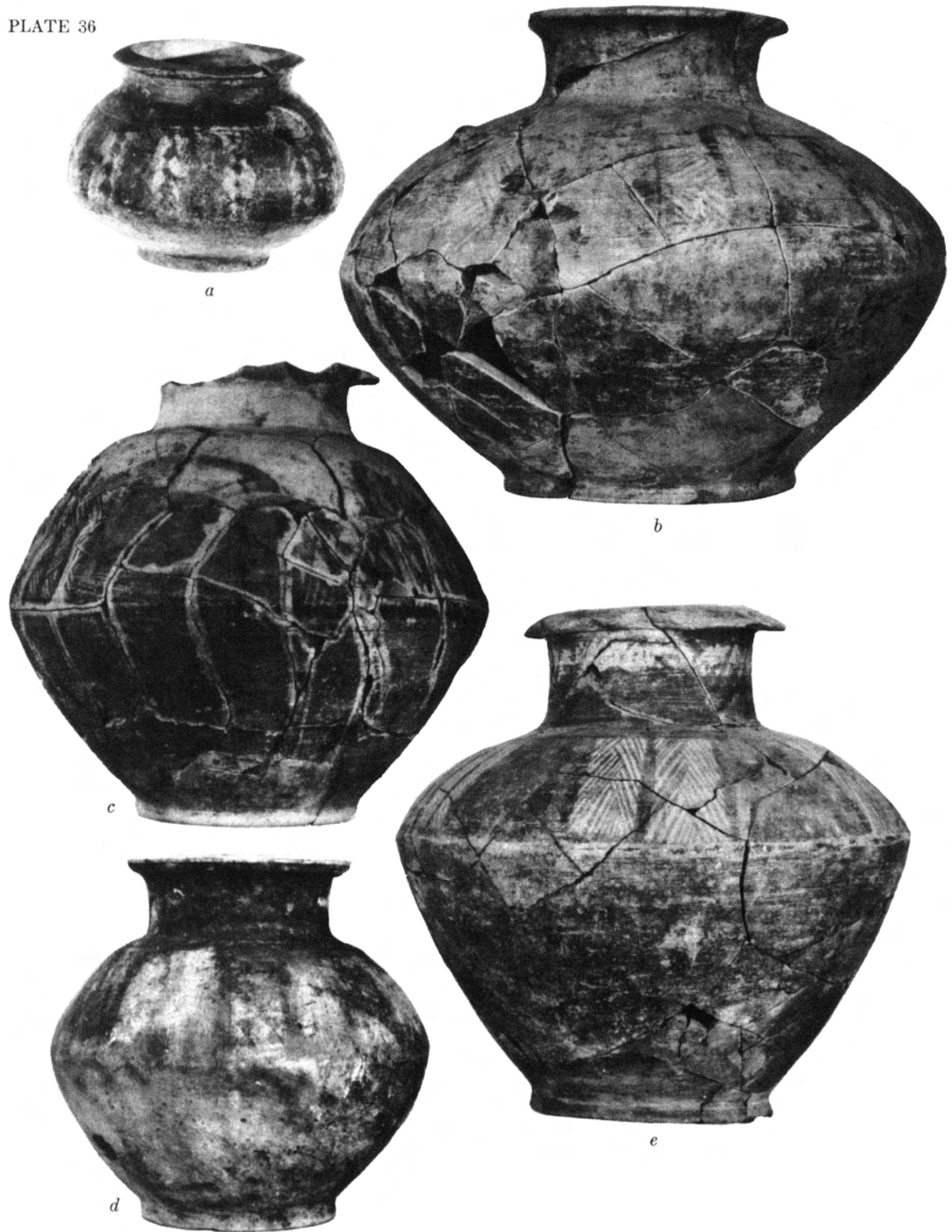

LATE POLYCHROME WARE OF THE PROTOLITERATE PERIOD FROM KHAFAJAH. SCALE, 2:5

a C.744.340

c C.605.340

e C.515.370

b C.603.340

d C.604.370

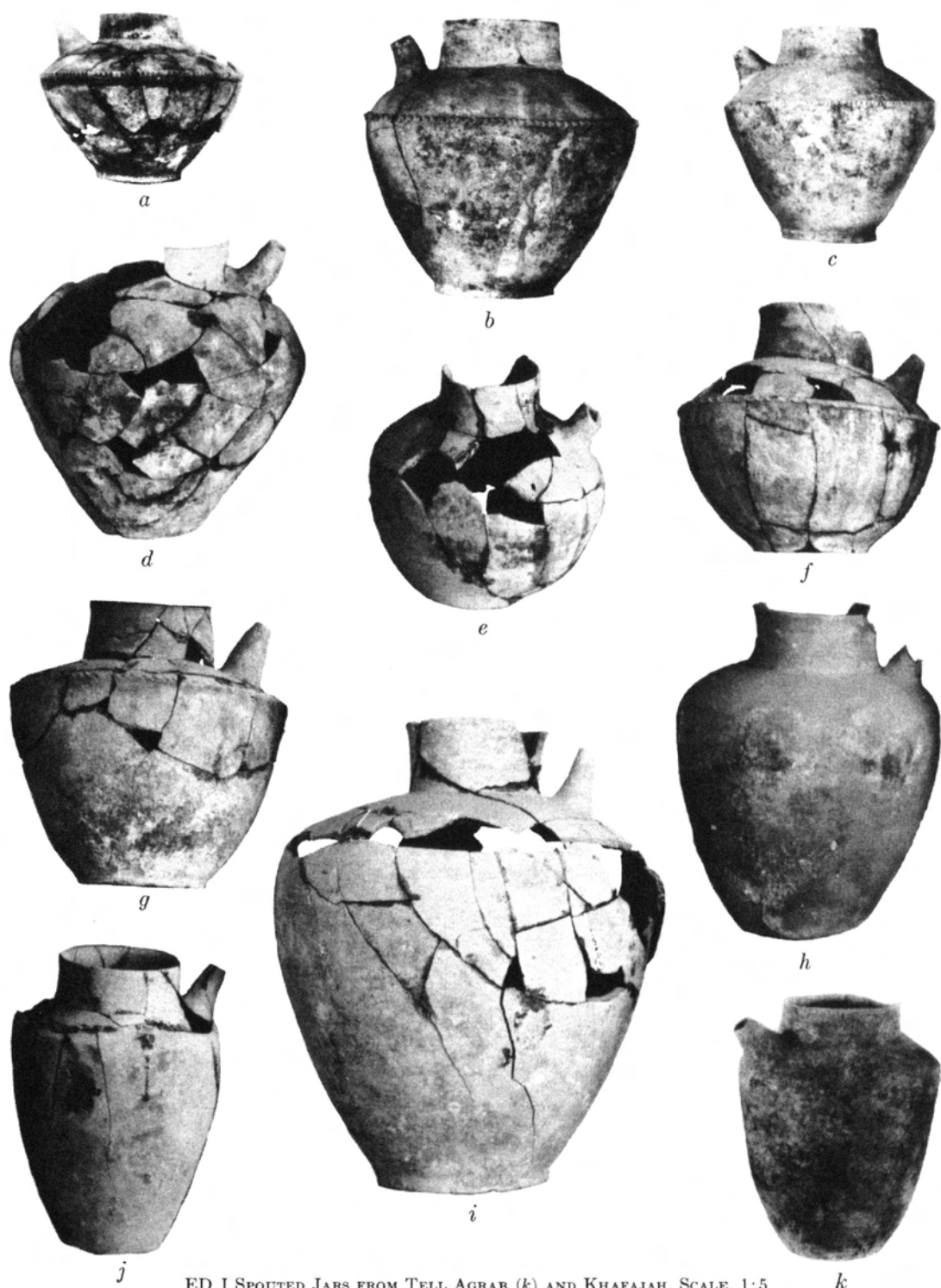

ED I SPOUTED JARS FROM TELL AGRAB (*k*) AND KHAFAJAH. SCALE, 1:5

- | | | |
|----------------------|--------------------|-----------------------|
| <i>a</i> C.514.362 | <i>e</i> C.545.222 | <i>h</i> C.525.262c |
| <i>b-c</i> C.515.362 | <i>f</i> C.524.362 | <i>i</i> D.535.322 |
| <i>d</i> C.535.222 | <i>g</i> C.515.362 | <i>j-k</i> C.526.262b |



ED I SPOUTED JARS FROM KHAFAJAH AND TELL AGRAB. SCALE, 1:5 (a-e, g) AND 2:5 (f)

a C.556.242	c C.526.362b	f B.533.252
b C.545.242	d-e C.525.362a	g C.526.362a



a



b

ED I VESSELS WITH RESERVED-SLIP DECORATION, FROM KHAFAJAH (*a*)
AND TELL ASMAR (*b*). SCALE, 1:5

a D.545.222

b D.544.240

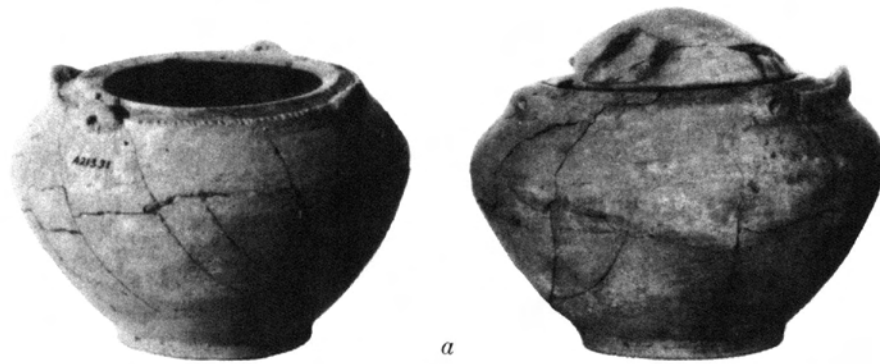

a



b

PLAIN FOUR-LUGGED NECKLESS JARS FROM SIN TEMPLE V AT KHAFAJAH (*a*)
AND ARCHAIC SHRINE II AT TELL ASMAR (*b*). SCALE, 2:5
a C.533.313 *b* C.534.313

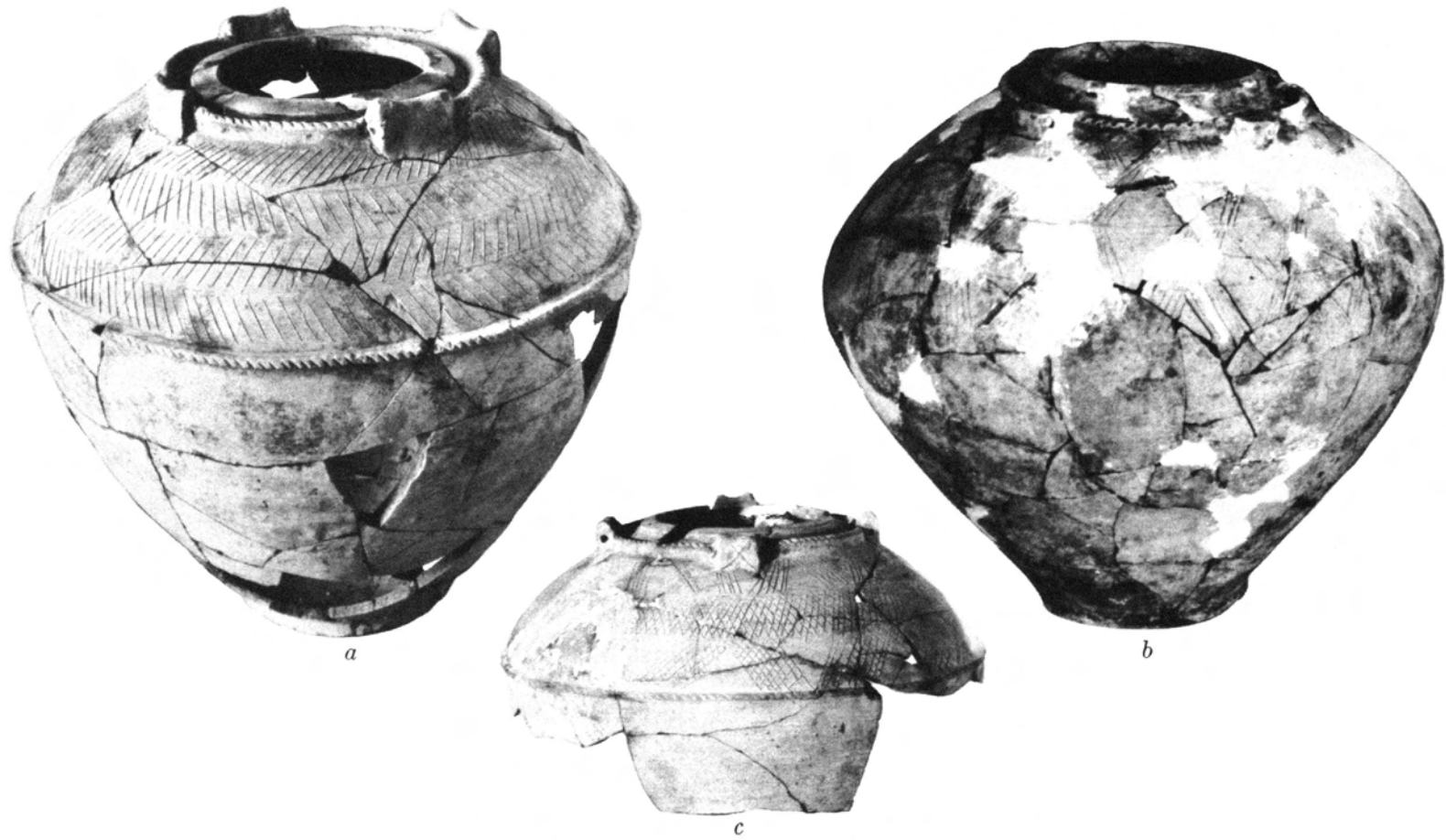

FOUR-LUGGED NECKLESS JARS WITH INCISED DECORATION, FROM ARCHAIC SHRINE III AT
TELL ASMAR (*a*, *c*) AND HILL B(?) AT TELL AGRAB (*b*). SCALE, 1:5
a D.504.353a *b* D.544.353 *c* D.504.353b (= Pl. 42 *d*)

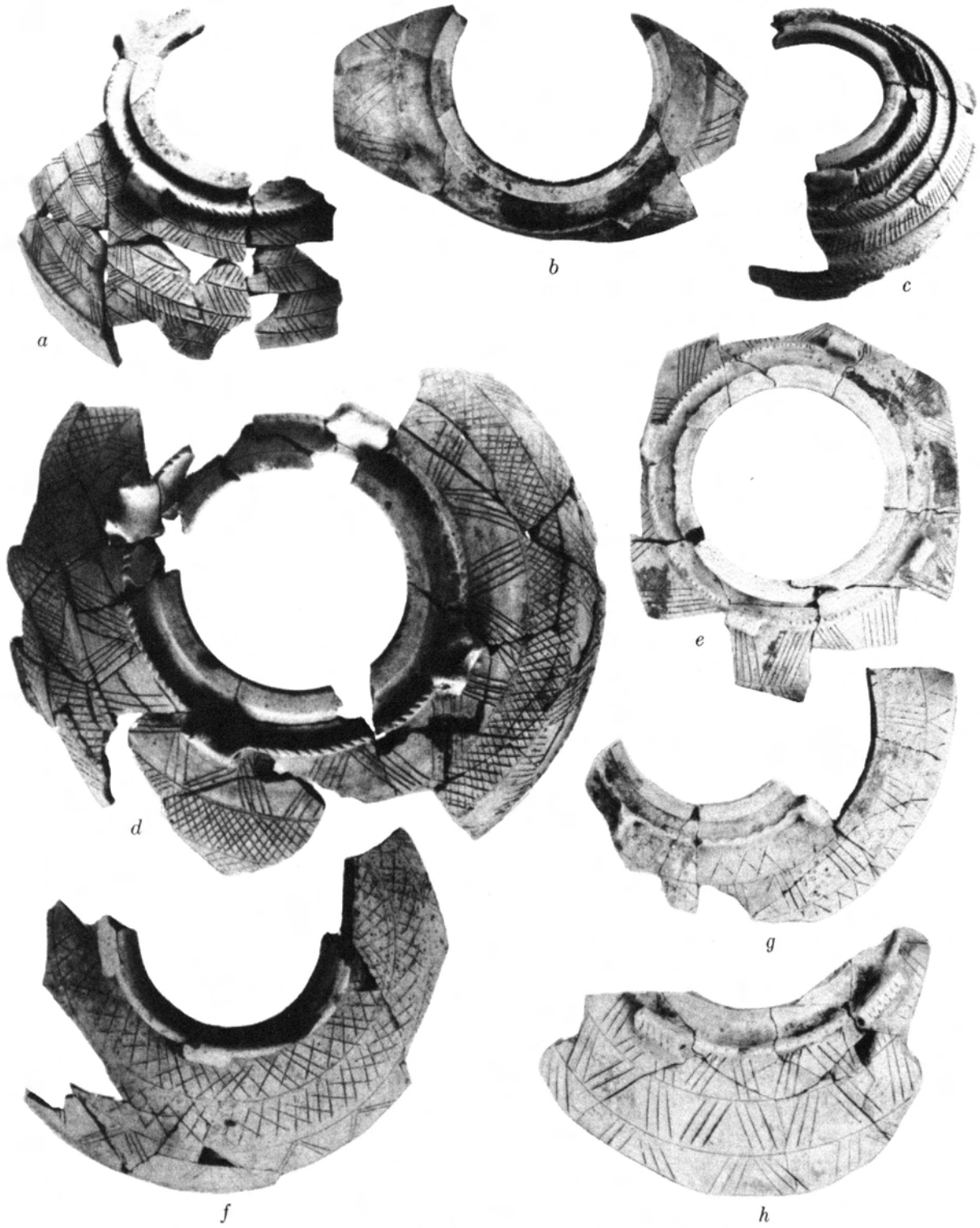

FRAGMENTS OF ED I FOUR-LUGGED NECKLESS JARS WITH INCISED DECORATION,
FROM TELL ASMAR AND TELL AGRAB. SCALE, 1:5

a D.504.353a

d D.504.353b (= Pl. 41 c)

c C.456.353 (= Pl. 44 d)

f D.516.363

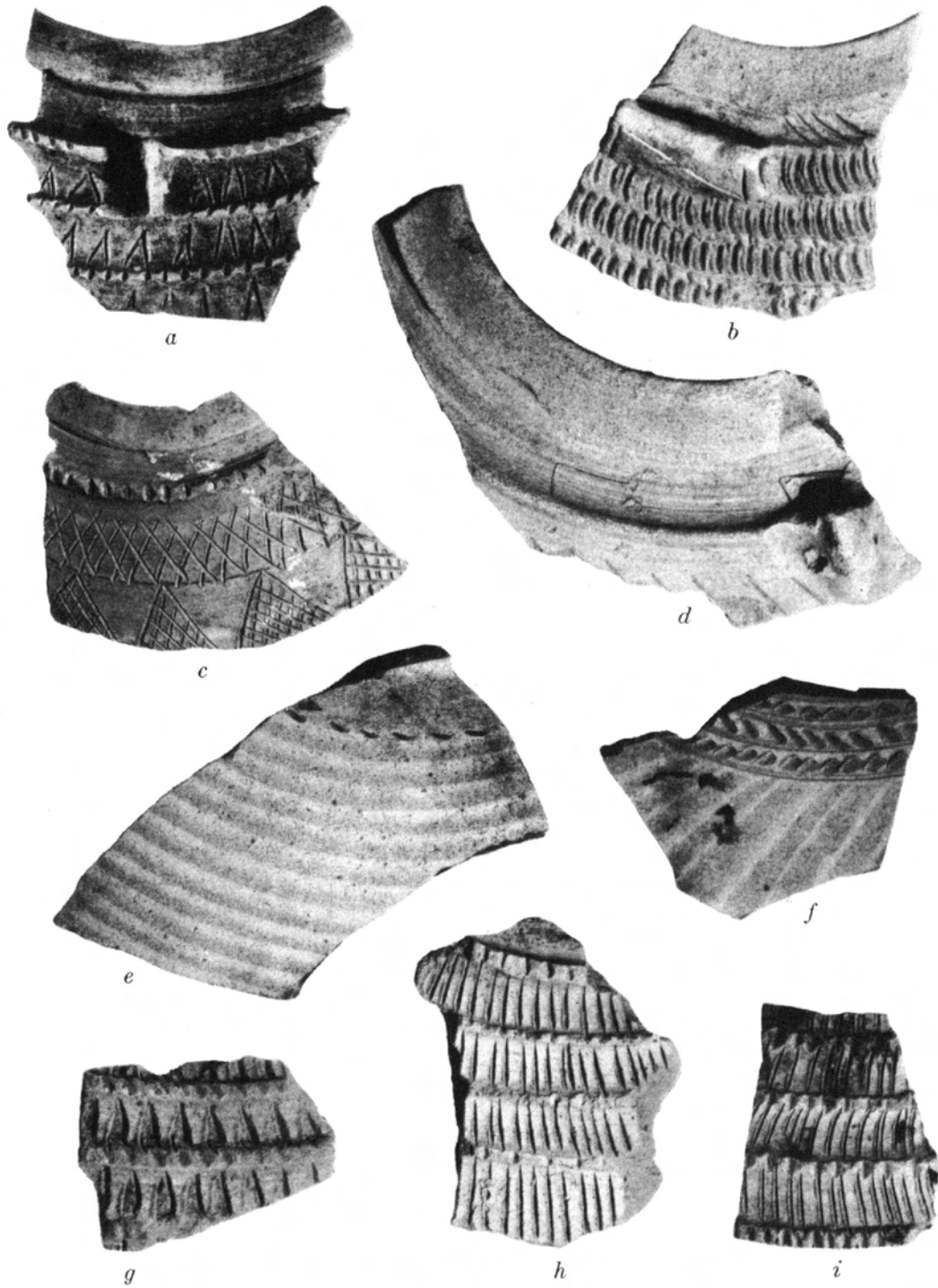

SHERDS FROM HOUSES 9 OR 8 AT KHAFAJAH. SCALE, 2:5

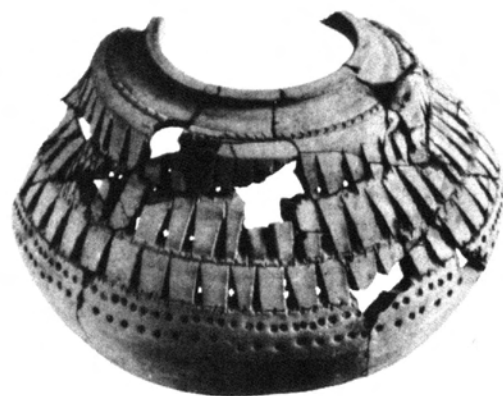

a



b



c



d

ED I VASES FROM KHAFAJAH (*b*) AND TELL ASMAR. SCALE, 1:5

a C.505.353

b C.455.353

c D.526.370b

d C.456.353 (= Pl. 42 *c*)



ED I "FLOWERPOTS" (a-b) AND STANDS (c-i) FROM KHAFAJAH, TELL ASMAR,
AND TELL AGRAB. SCALE, 2:5 (a-b) AND 1:5 (c-i)

a C.014.310	c C.357.010	e C.3--.0--	g C.357.073
b C.014.300	d C.236.010	f C.3--.063	h C.35--.0--b

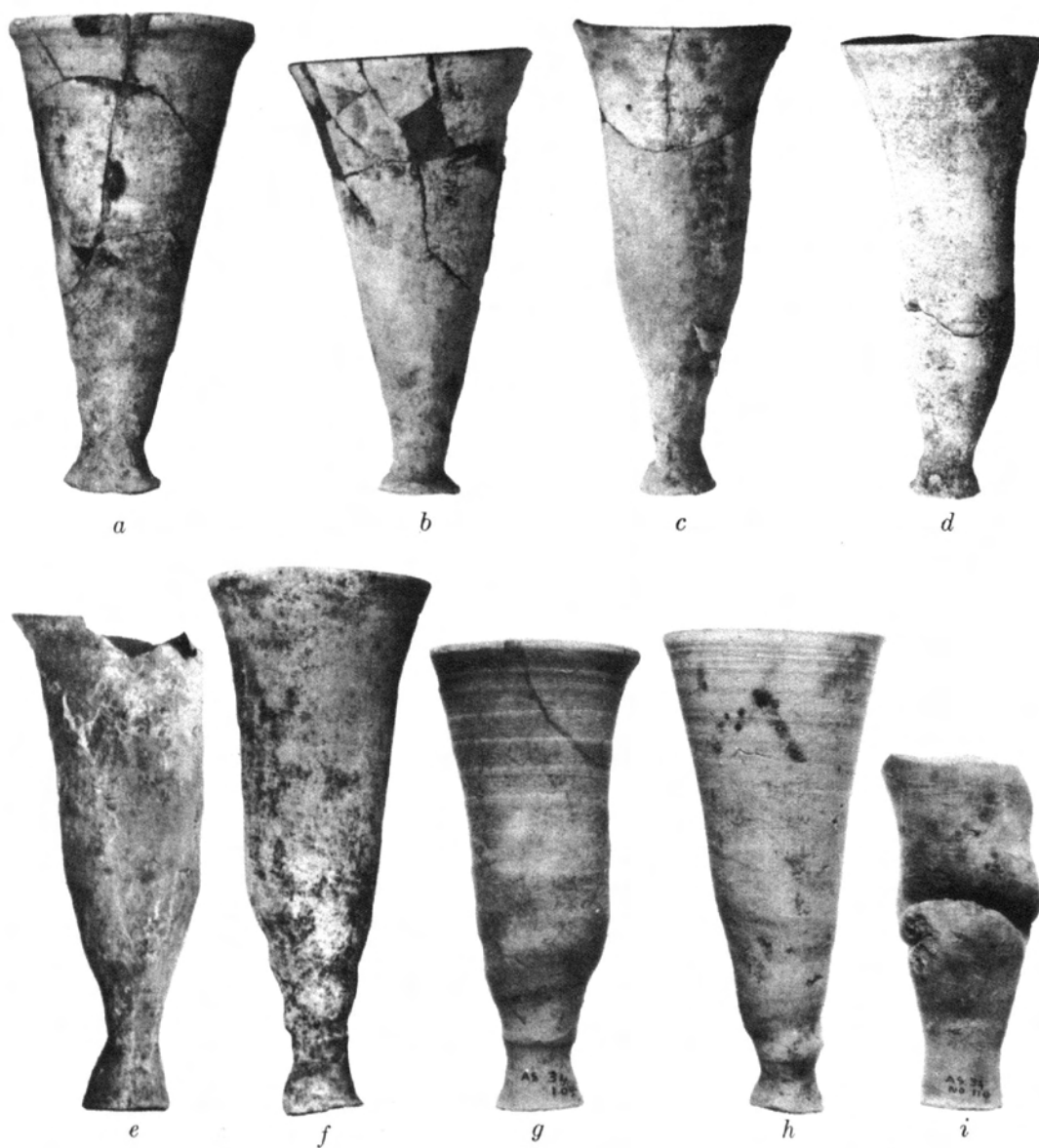

ED I SOLID-FOOT GOBLETS FROM KHAFAJAH AND TELL ASMAR. SCALE, 2:5

- | | | |
|--------------------|-------------------------------|--------------------|
| <i>a</i> B.076.700 | <i>c-e</i> B.077.700 <i>b</i> | <i>h</i> B.007.700 |
| <i>b</i> B.077.700 | <i>f</i> B.087.700 | <i>i</i> B.087.700 |
| | <i>g</i> B.077.700 <i>a</i> | |

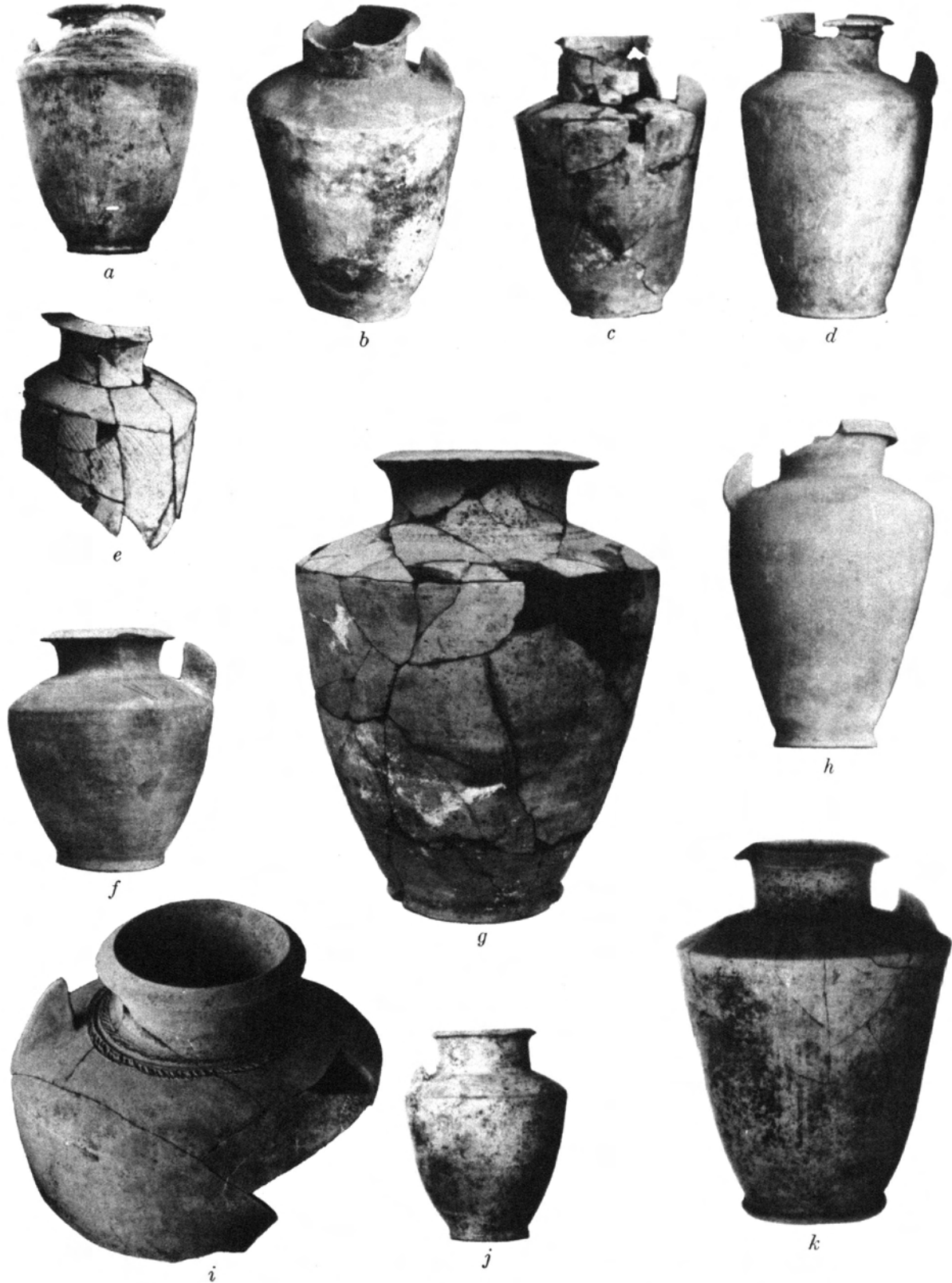

SINGLE-LUGGED JARS FROM KHAFAJAH AND TELL AGRAB, PROBABLY ALL OF ED I DATE. SCALE, 1:5

- | | | | |
|--------------------|---------------------|--------------------|--------------------|
| <i>a</i> C.516.373 | <i>d</i> C.526.373a | <i>g</i> D.526.373 | <i>j</i> C.526.373 |
| <i>b</i> C.516.273 | <i>e</i> C.526.373 | <i>h</i> C.515.373 | <i>k</i> C.516.373 |
| <i>c</i> C.516.373 | <i>f</i> C.526.373b | <i>i</i> D.526.373 | |



GRAY POTTERY AND A STONE VESSEL OF ED I, ORANGE BURNISHED SHERDS FROM AN ED III LEVEL. SCALE, 2:5 (a-d) AND 4:5 (f-i)

a-b B.022.200 c B.754.540 d stone (Kh. V 237) e C.557.620



ED I UTENSILS FROM KHAFAJAH. SCALE, 2:5

<i>a</i> - <i>b</i> B.083.200	<i>d</i> B.042.200	<i>f</i> B.666.540a	<i>h</i> B.416.260
<i>c</i> B.003.200b	<i>e</i> B.656.220	<i>g</i> C.605.240	<i>i</i> D.545.320



MISCELLANEOUS UTENSILS OF ED I AND II (b) FROM TELL ASMAR (e)
AND KHAFAJAH. SCALE, 2:5 (a, b, d) AND 4:5 (c, e, f)
a-b C.077.500 c A.515.270 d B.834.203 e B.625.521 f B.544.541

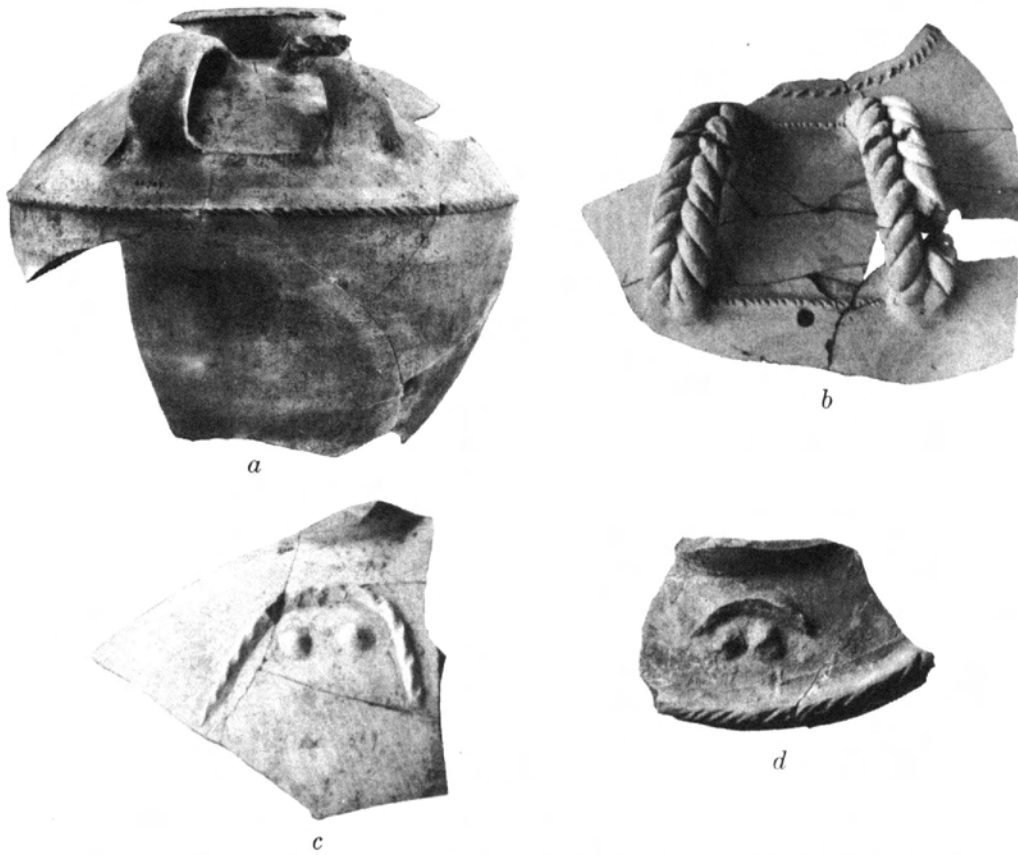

FRAGMENTS FROM THE SHARA TEMPLE AT TELL AGRAB (*a-c*) AND TEMPLE OVAL II
AT KHAFAJAH (*d*). SCALE, 1:5 (*a-c*) AND 2:5 (*d*)
a D.525.371



a



b

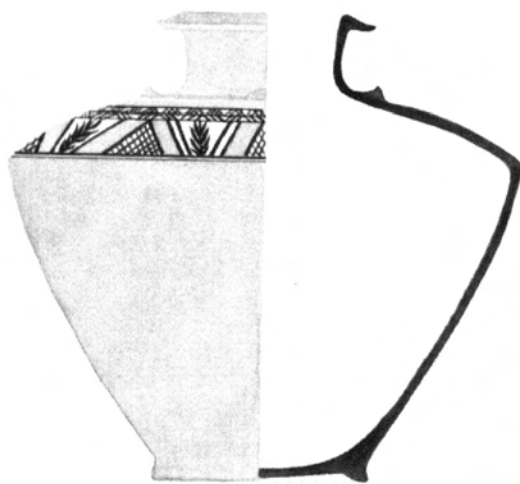

c

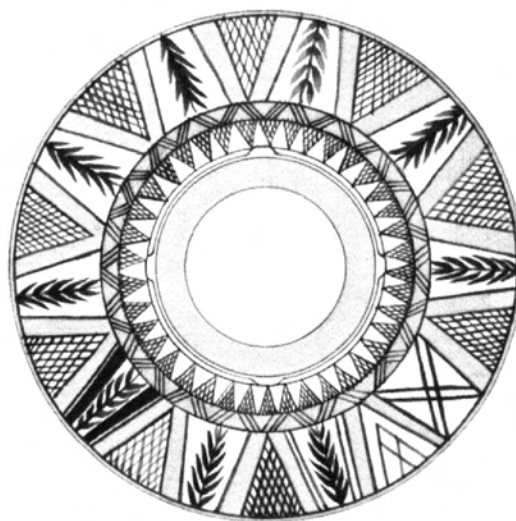

TRANSITIONAL SCARLET-WARE JARS (*a-b*) FROM TELL AGRAB AND A VASE OF
SCARLET WARE PROPER (*c*) FROM TELL ASMAR. SCALE, 1:5
a C.525.370*b* *b* D.515.370 *c* D.514.370*a*

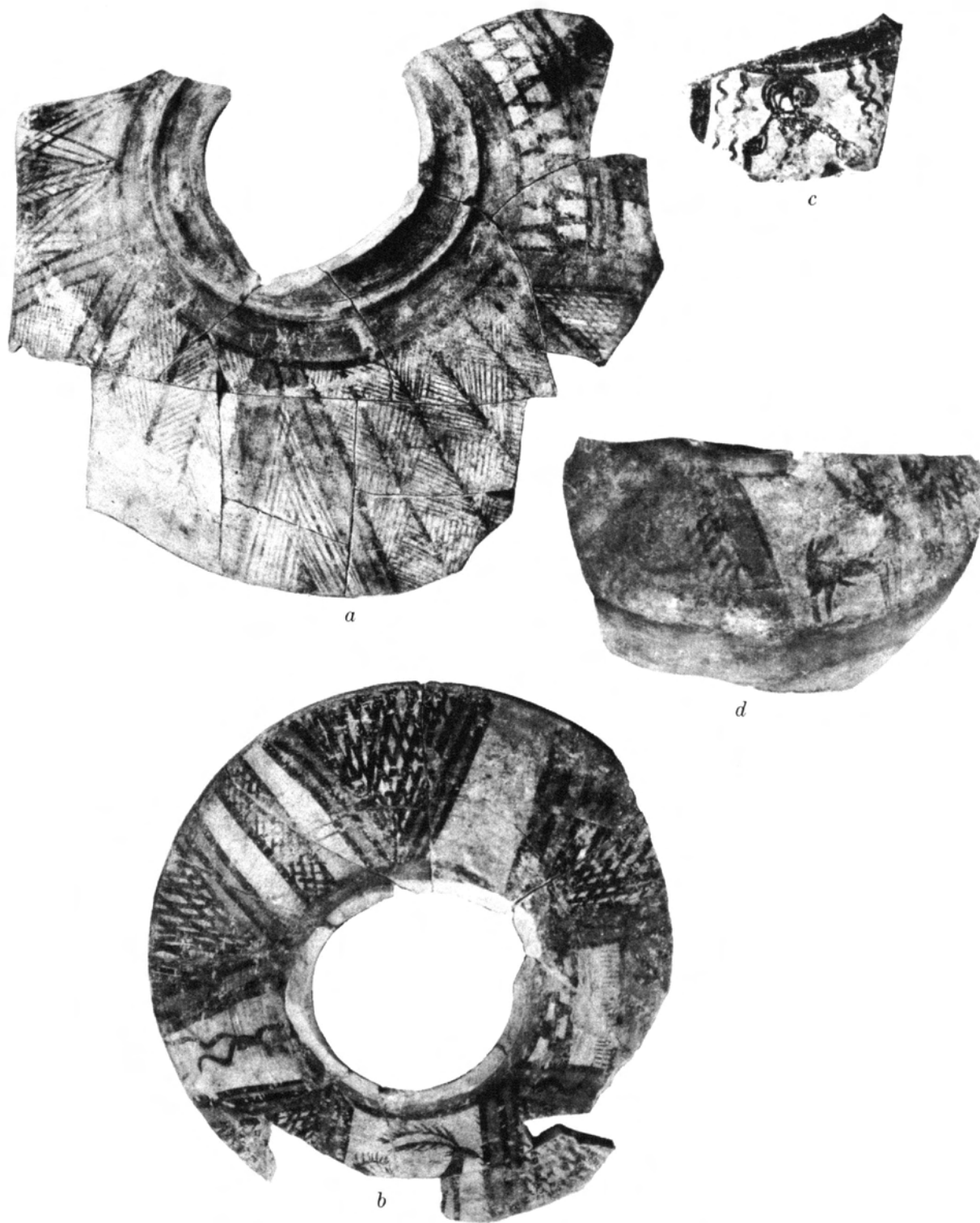

TRANSITIONAL SCARLET-WARE SHERDS FROM TELL AGRAB. SCALE, 2:5

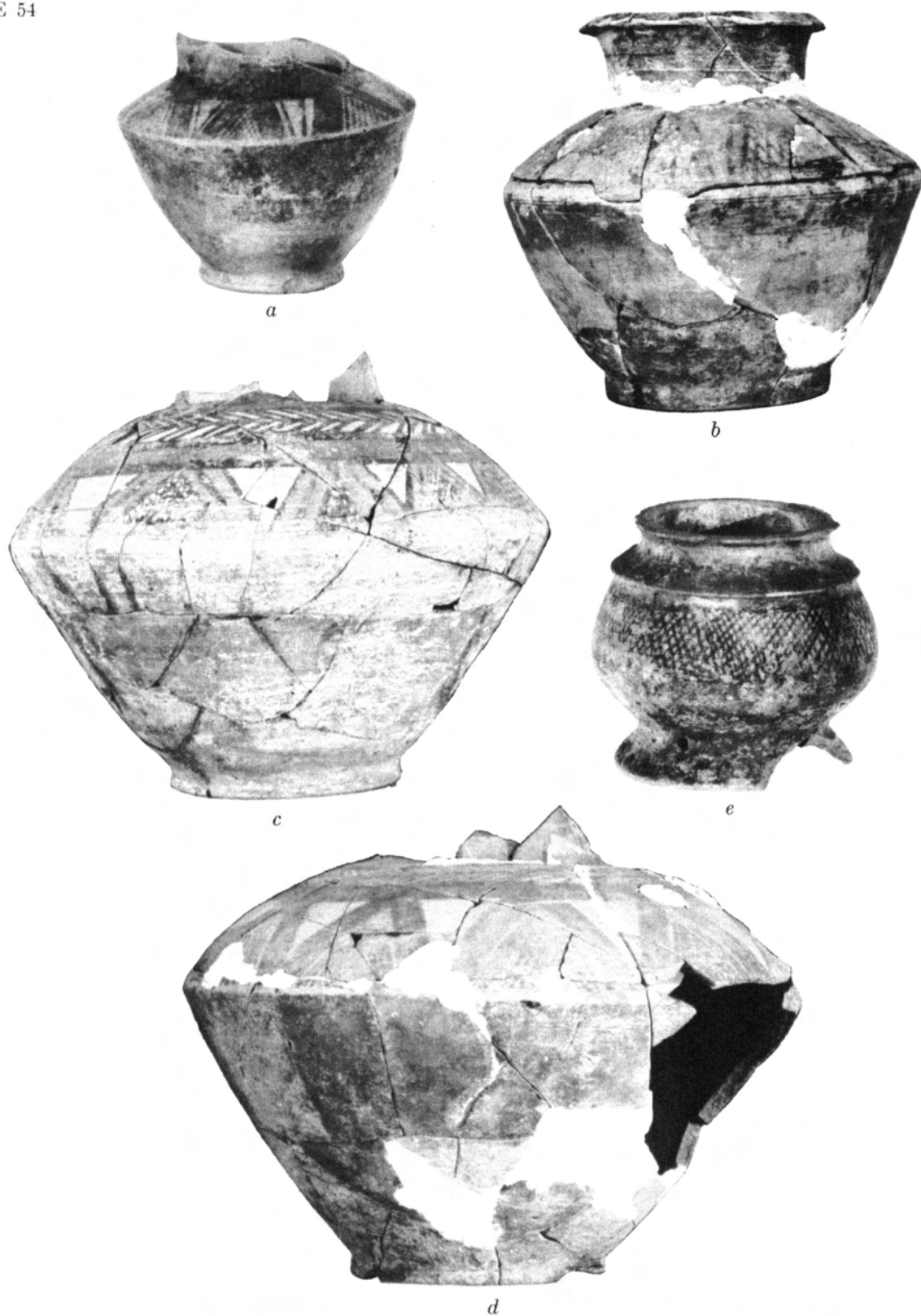

SCARLET-WARE VASES FROM HOUSES 11 AT KHAFAJAH AND FROM TELL AGRAB. SCALE, 2:5

a C.514.370b *c* C.514.370a *e* C.754.440
b C.514.370b *d* C.514.370b



SCARLET-WARE JARS FROM KHAFAJAH AND TELL AGRAB. SCALE, 2:5

a C.526.373

c C.516.373

e C.526.373

b C.515.373

d C.517.273



a



b

SCARLET-WARE VASES FROM KHAFAJAH (*a*) AND TELL AGRAB (*b*). SCALE, 2:5 (*a*) AND 1:5 (*b*)
a C.515.373 *b* C.526.373



SCARLET-WARE VASE (C.516.373) FROM TELL AGRAB AS RESTORED IN
THE IRAQ MUSEUM. SCALE, 1:5



SCARLET-WARE FRAGMENTS FROM TELL AGRAB. SCALE, 2:5

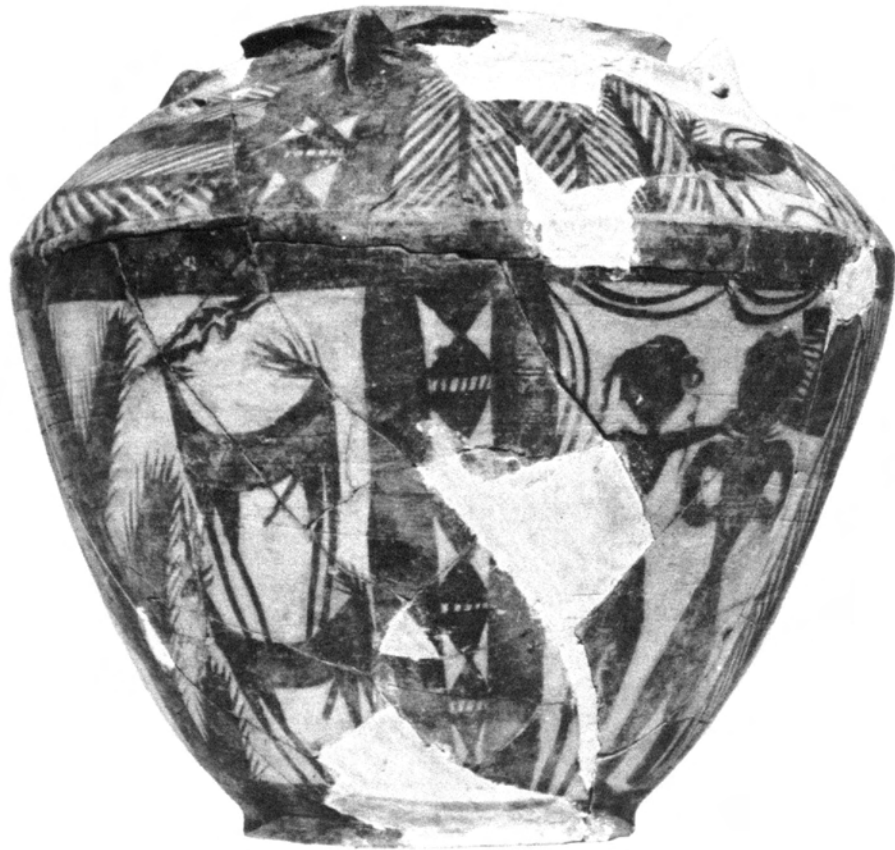

a



b

RESTORED SCARLET-WARE VASE (C.514.353) FROM KHAFAJAH BEFORE AND
AFTER RESTORATION OF DESIGN. SCALE, 2:5



RESTORED SCARLET-WARE VASE (C.515.371) FROM KHAFAJAH. SCALE, 1:3



TWO MORE VIEWS OF VASE SHOWN IN PLATE 60. SCALE, 1:3

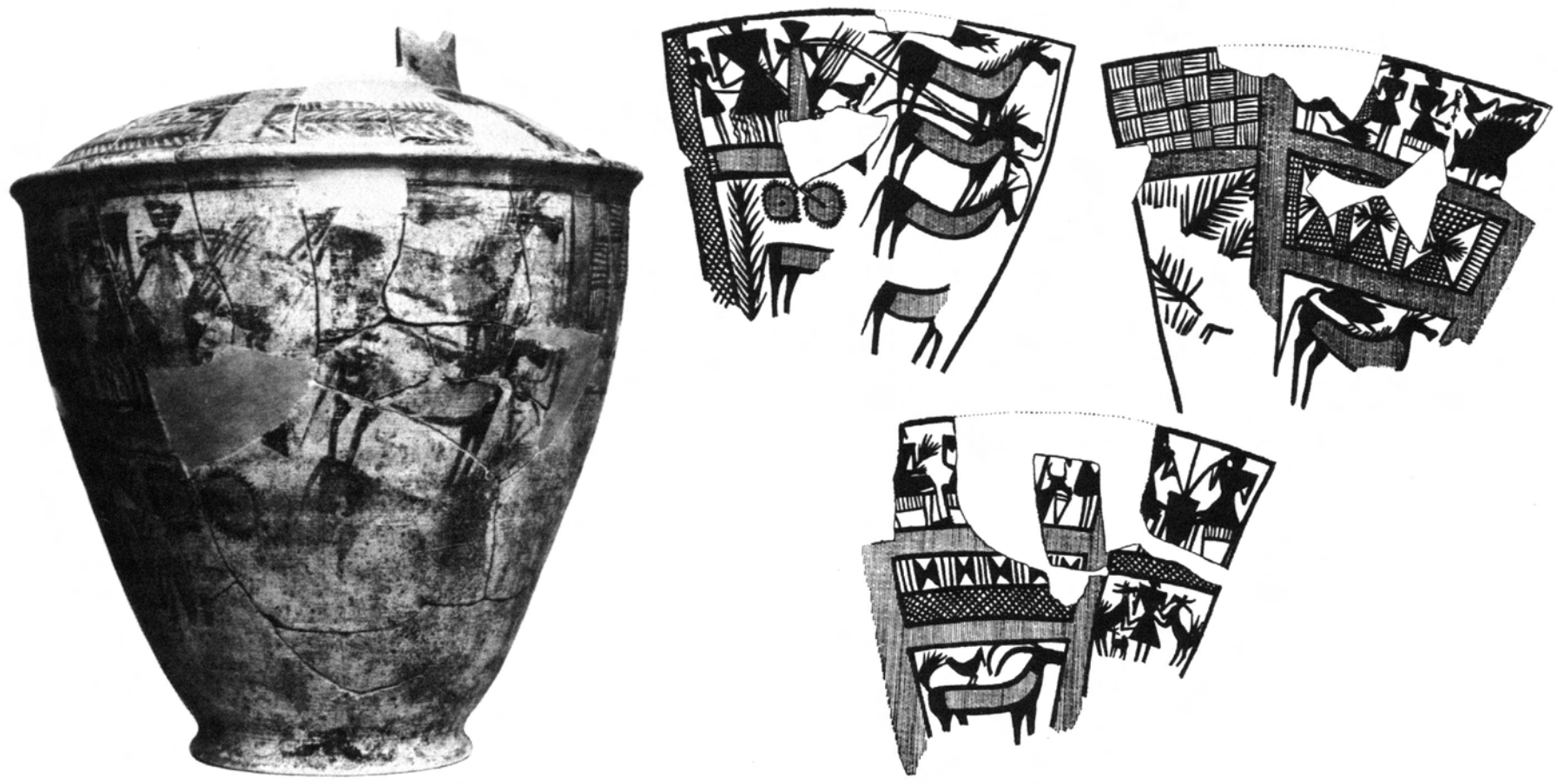

SCARLET-WARE VASE FROM KHAFAJAH AS RESTORED IN THE BRITISH MUSEUM
AND DRAWING OF PRESERVED PARTS OF THE DESIGN
*Reproduced with the kind permission of the Trustees of the British Museum
from the British Museum Quarterly, VIII (1933/34) Pl. VIII and p. 39*

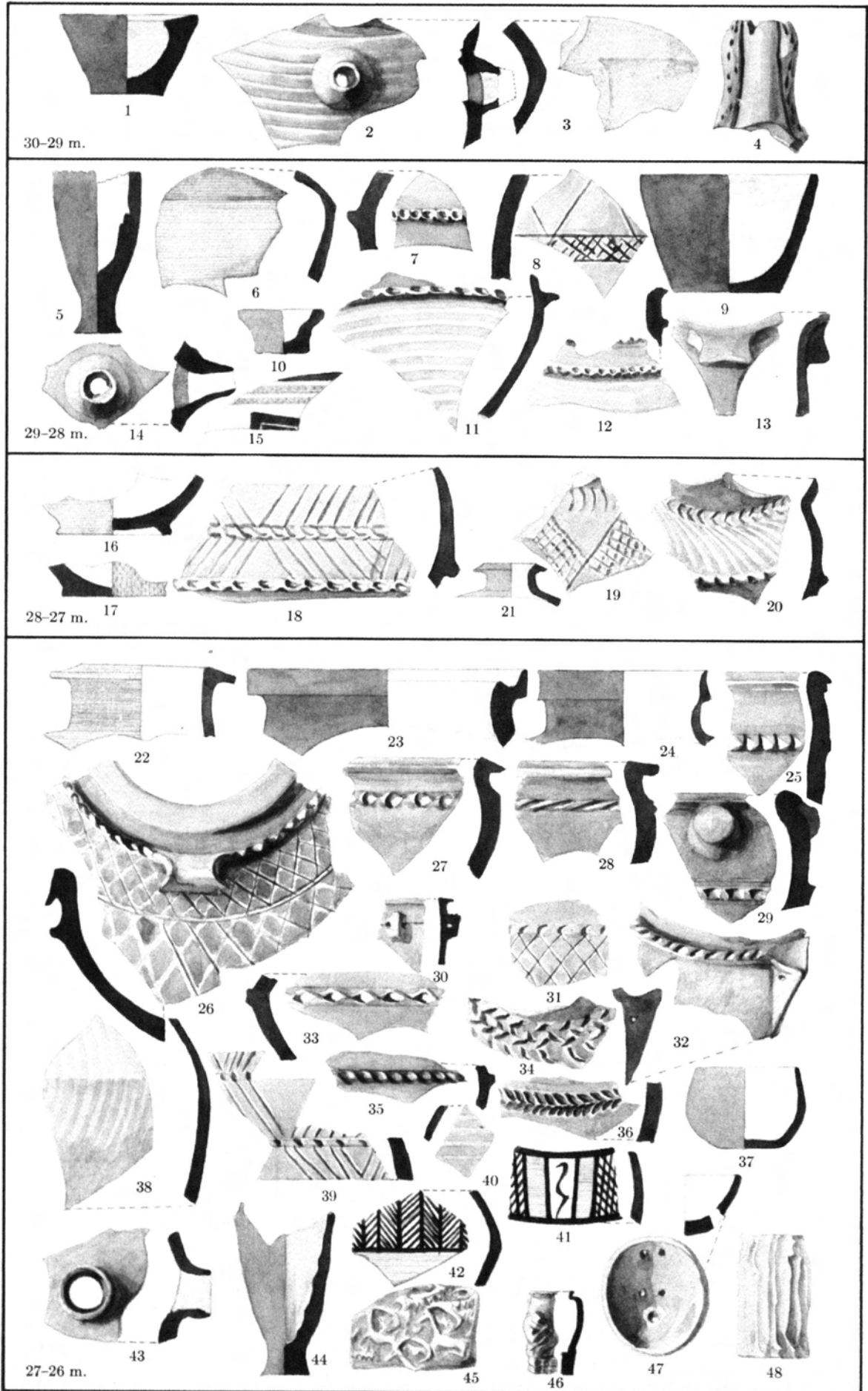

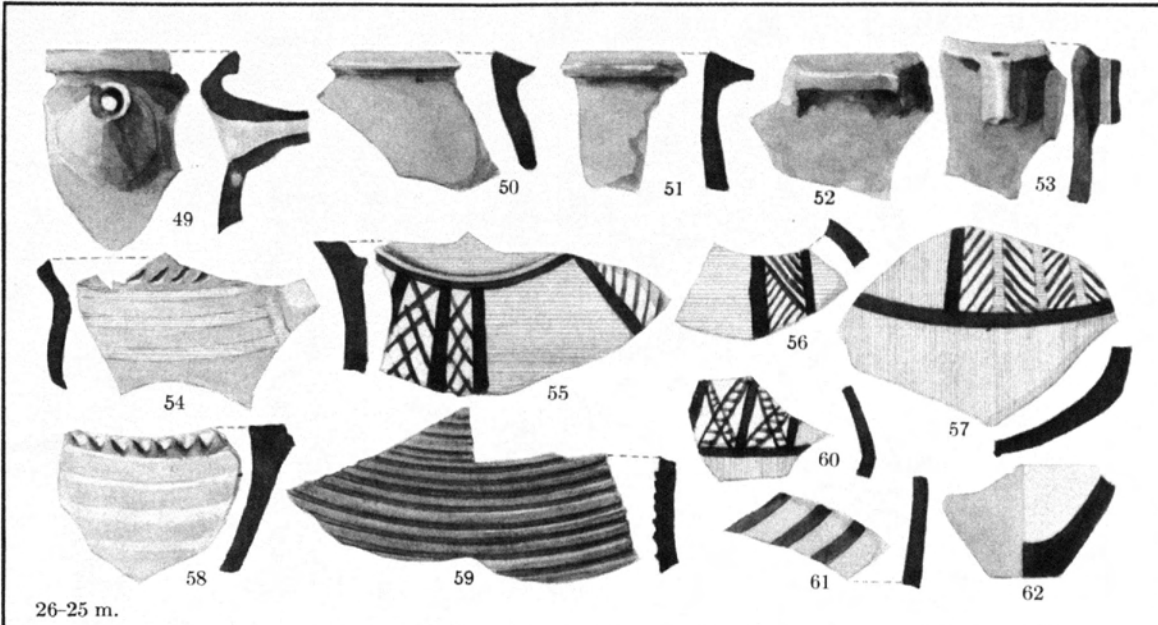

26-25 m.

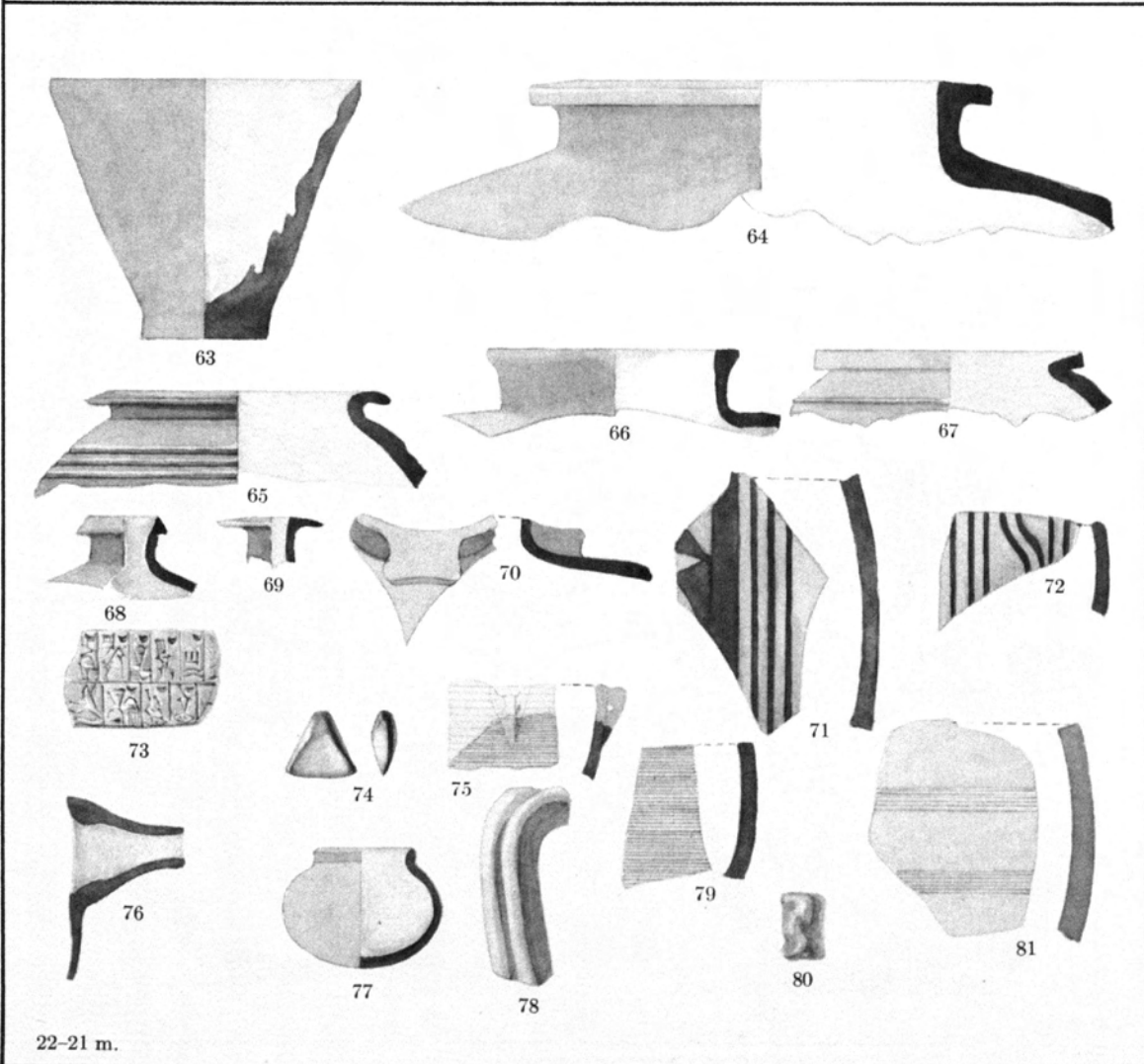
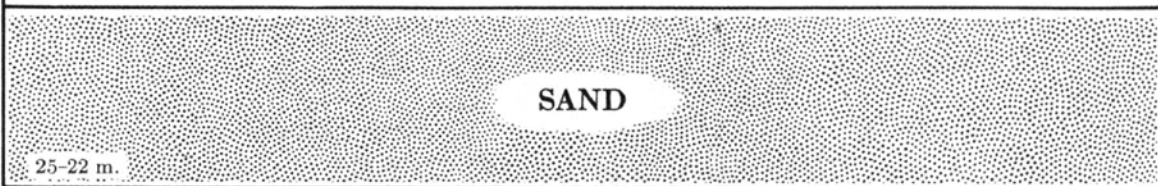

22-21 m.

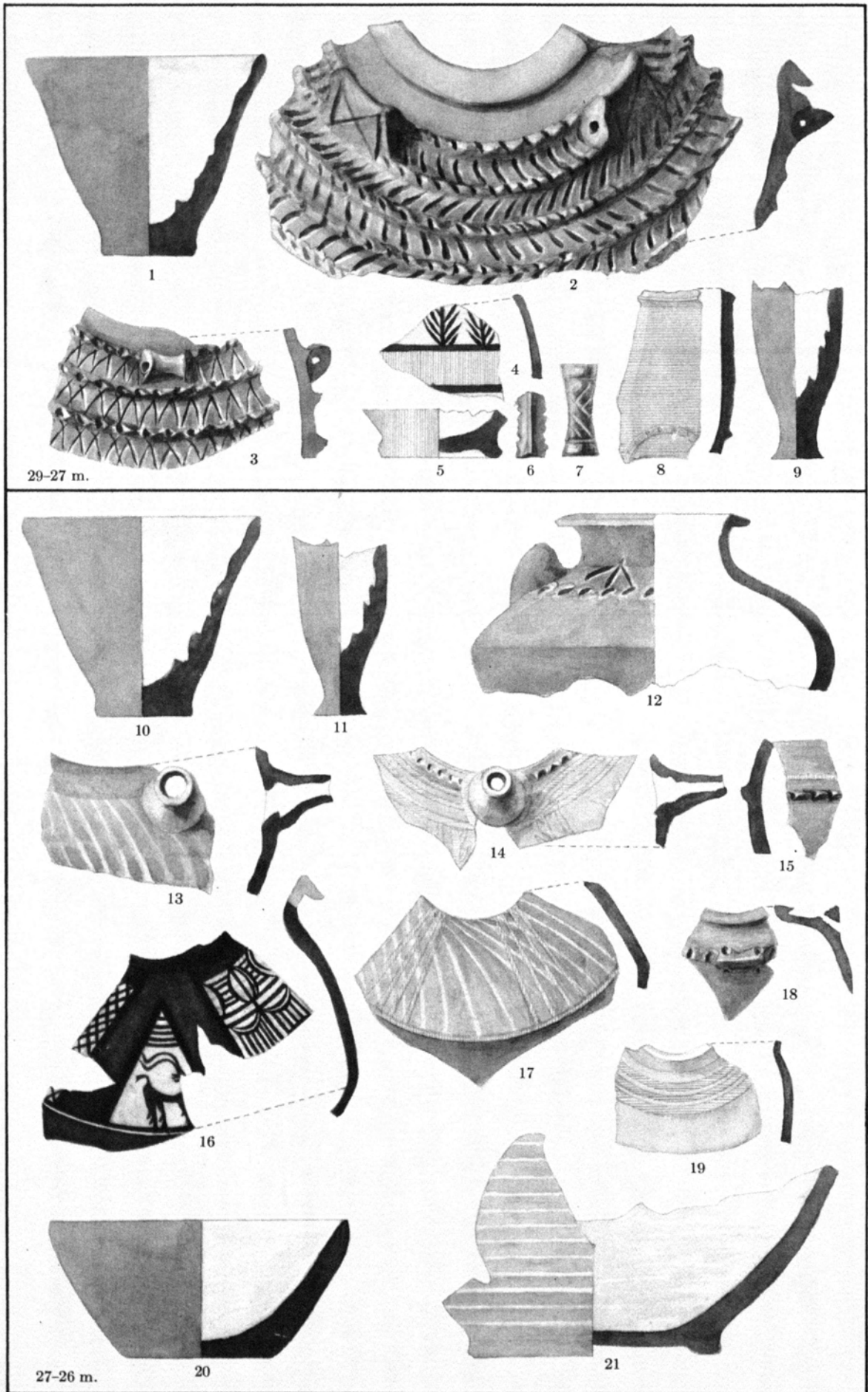

PROTOLITERATE AND ED I MATERIAL FROM THE H 18:14 SOUNDING AT TELL ASMAR

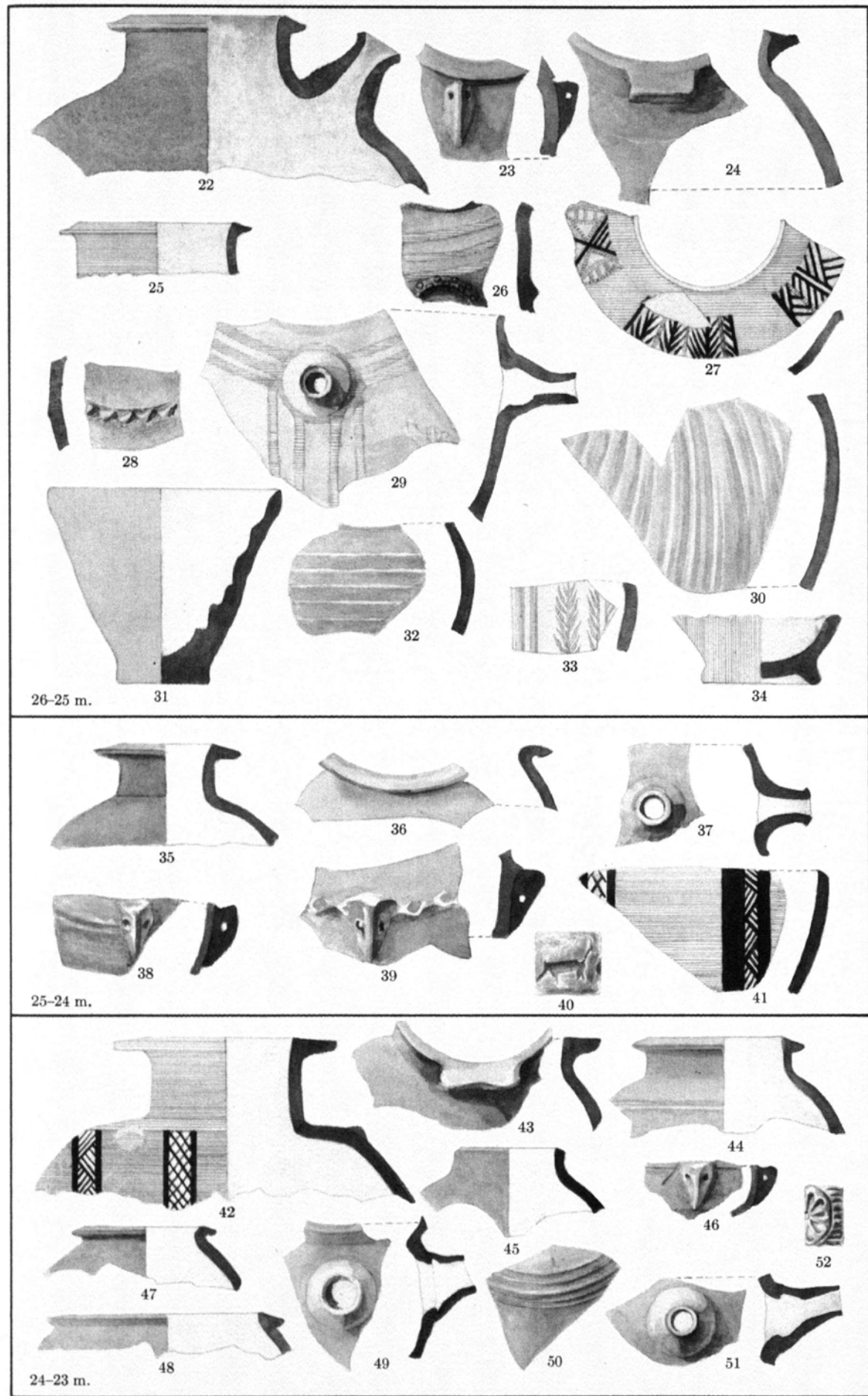

PLATE 64
(Continued)

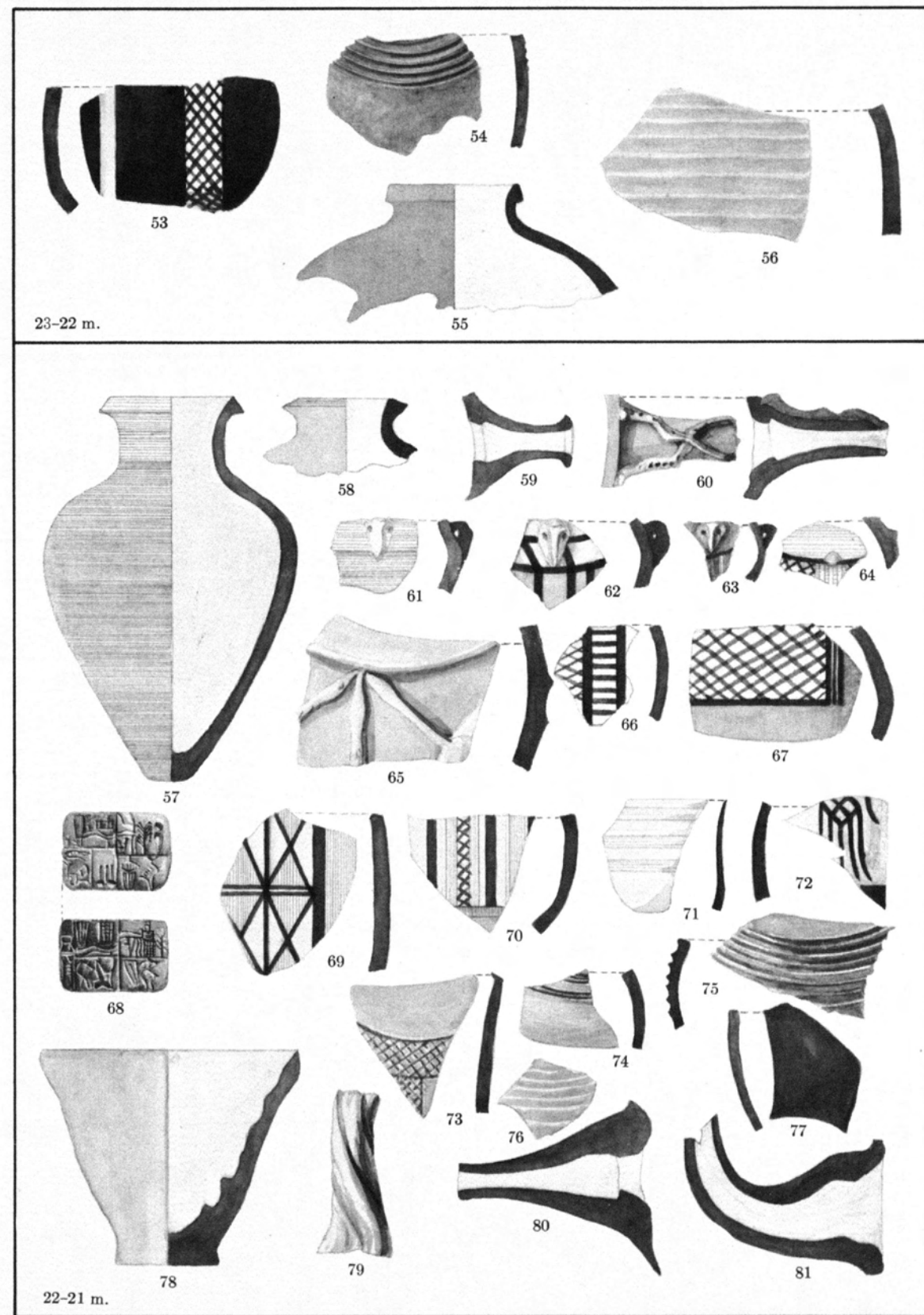
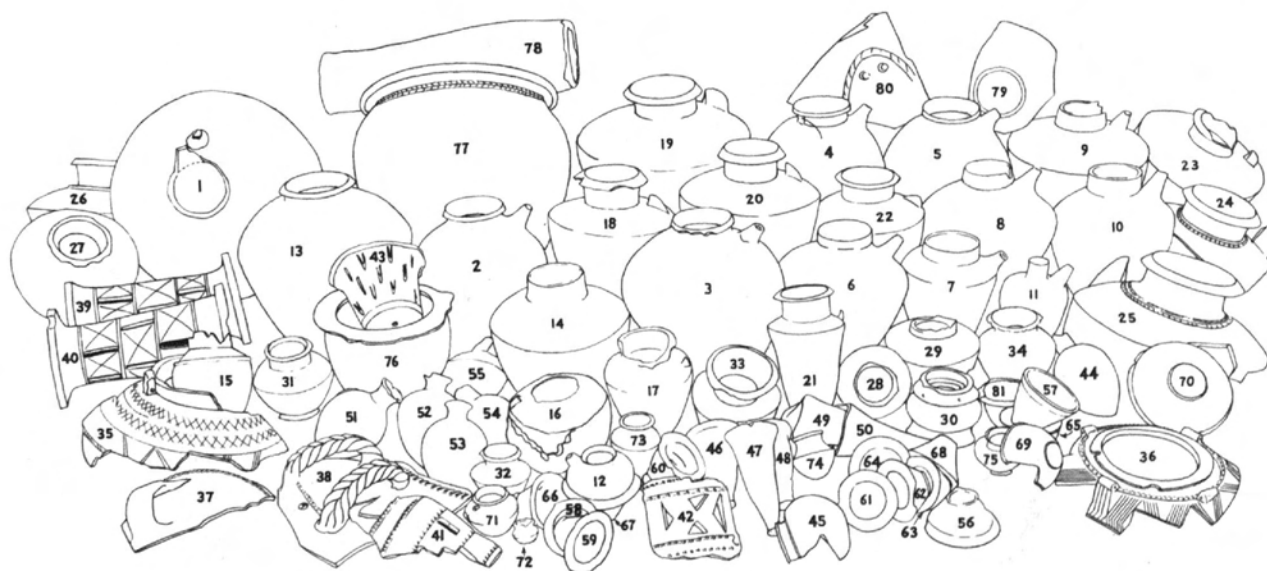

PLATE 64
(Continued)



ED I POTTERY FROM TELL AGRAB



LARGE ED I (*a*, PROBABLY *b*) AND II (*c-e*) JARS FROM TELL ASMAR (*a*) AND KHAFAJAH. SCALE, 1:5

a D.514.370b *c* D.525.370 *e* D.524.370
b D.514.370b *d* D.515.370



ED II SPOUTED JARS FROM KHAFAJAH AND TELL ASMAR. SCALE, 1:5
a D.525.362 *c* C.525.362*b* *e* C.526.362*b* *g* C.596.362
b D.515.362 *d* C.516.362 *f* C.525.362*b* *h* C.526.262*c*

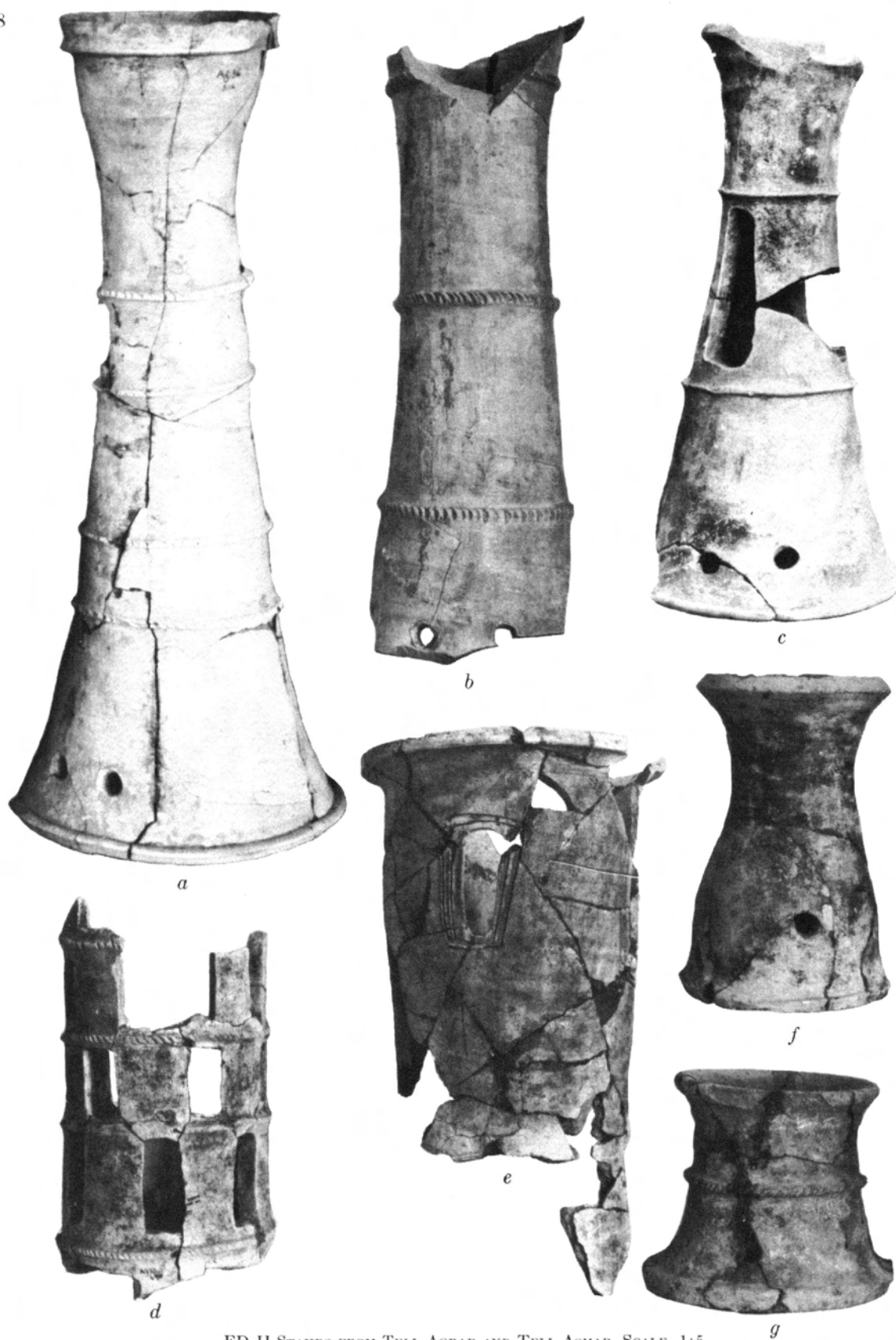

ED II STANDS FROM TELL AGRAB AND TELL ASMAR. SCALE, 1:5
a C.358.010 c C.357.010a e C.39-0-- g C.355.010
b C.357.010b d C.35-0--a f C.356.010

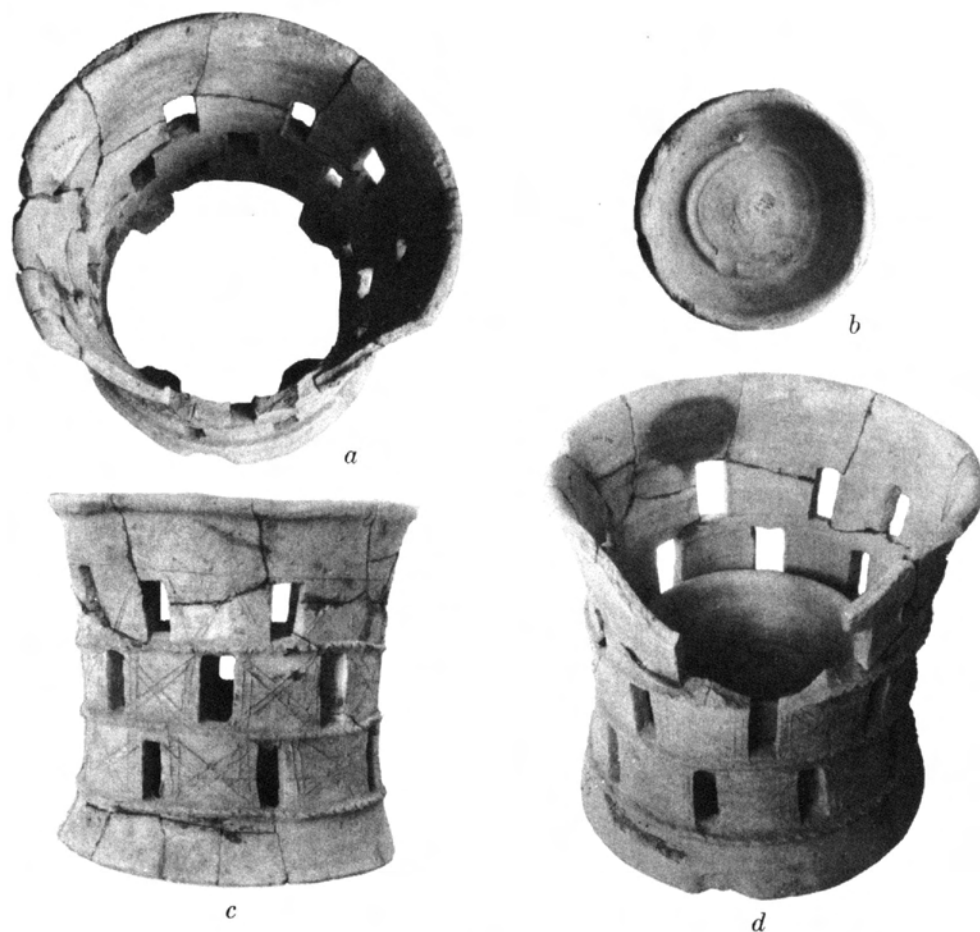

LARGE BRAZIER (C.234.000) WITH BOWL (C.201.200), FROM SMALL TEMPLE VI
AT KHAFAJAH. SCALE, 1:5

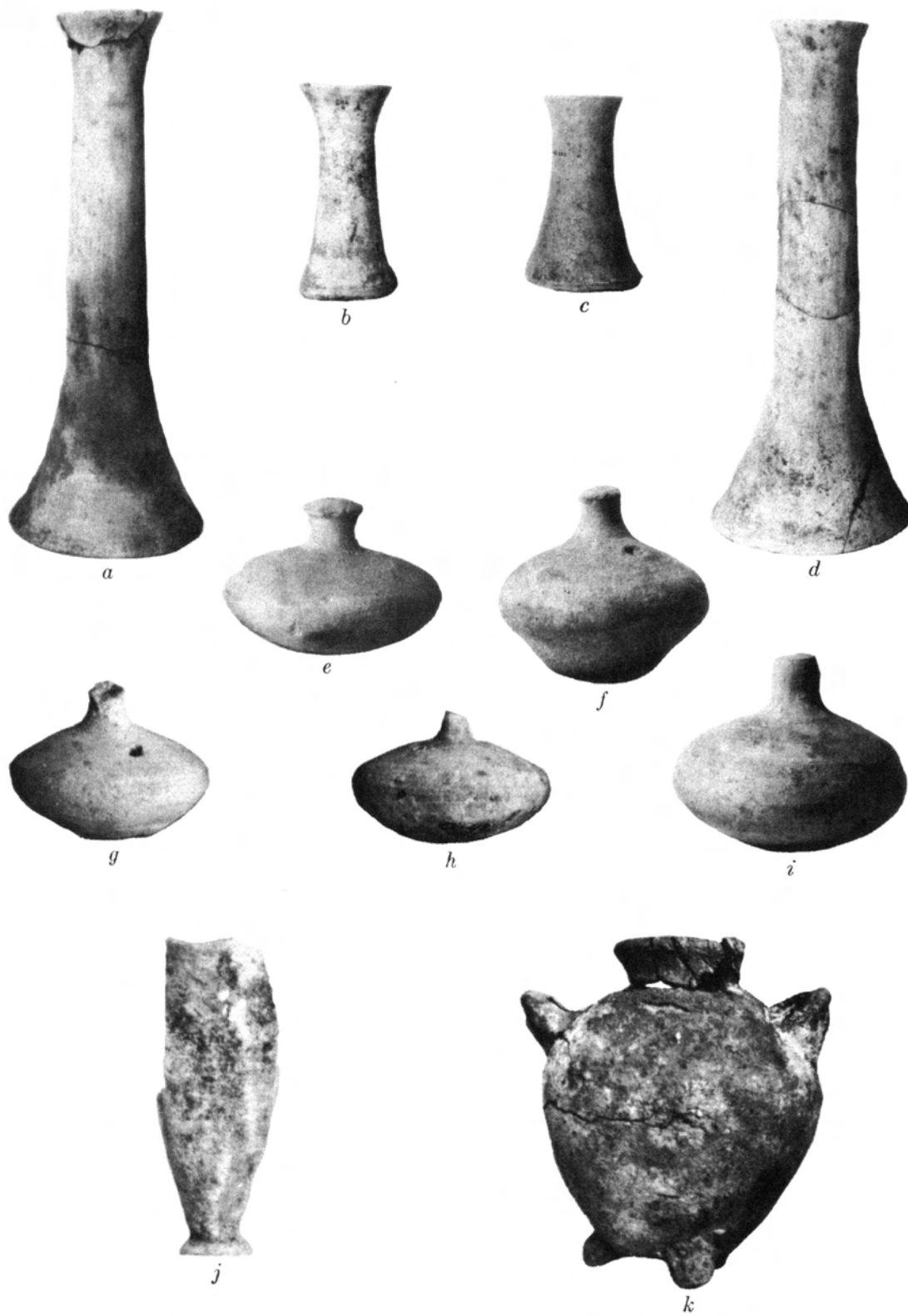

UTENSILS OF THE EARLY DYNASTIC PERIOD FROM TELL AGRAB (*k*), KHAFAJAH, AND TELL ASMAR. SCALE, 1:5 (*a-d*) AND 2:5 (*e-k*)

a C.357.000 *d* C.357.000 *g-i* B.664.520*b* *k* C.555.921
b-c B.356.000 *e-f* B.664.520*c* *j* B.047.700

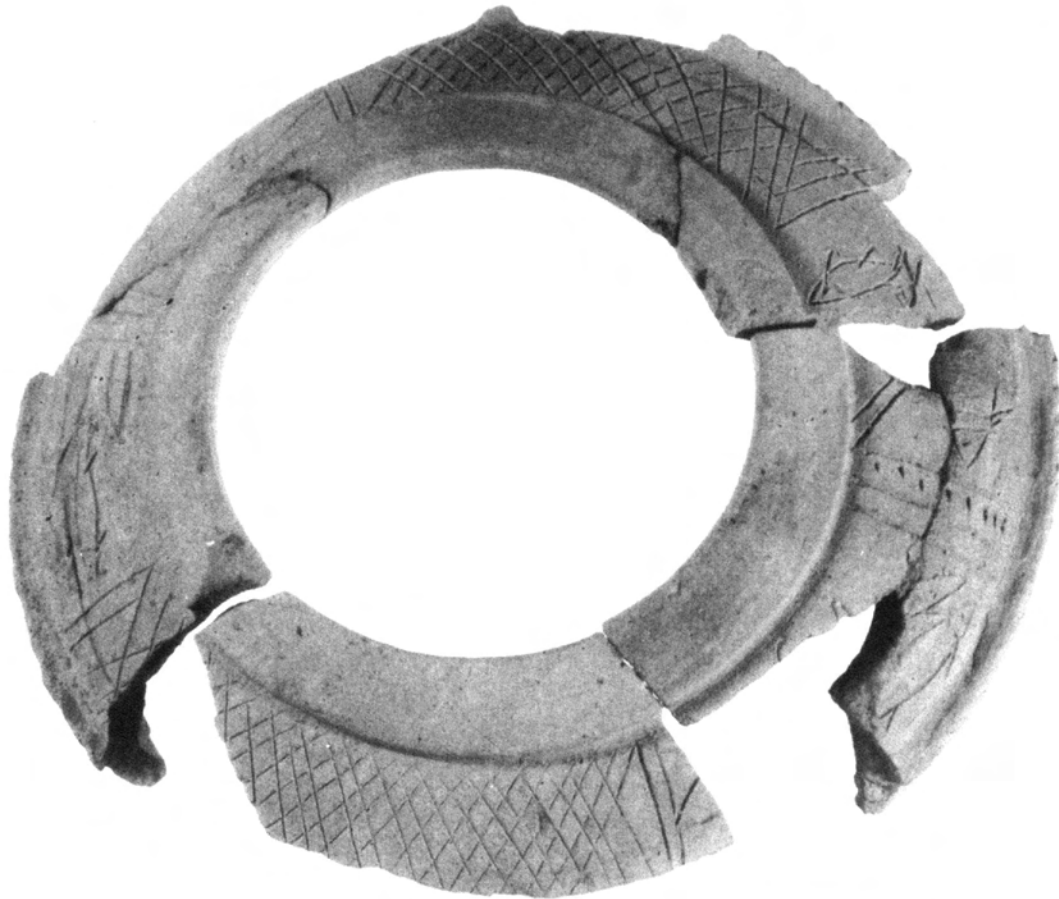

a

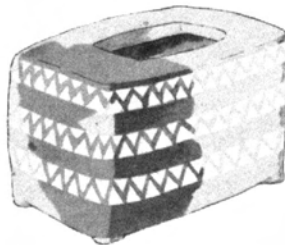

b



c

ED II VESSELS FROM KHAFAJAH. SCALE, 4:5 (RECONSTRUCTION, 2:5)

a C.524.350

c B.882

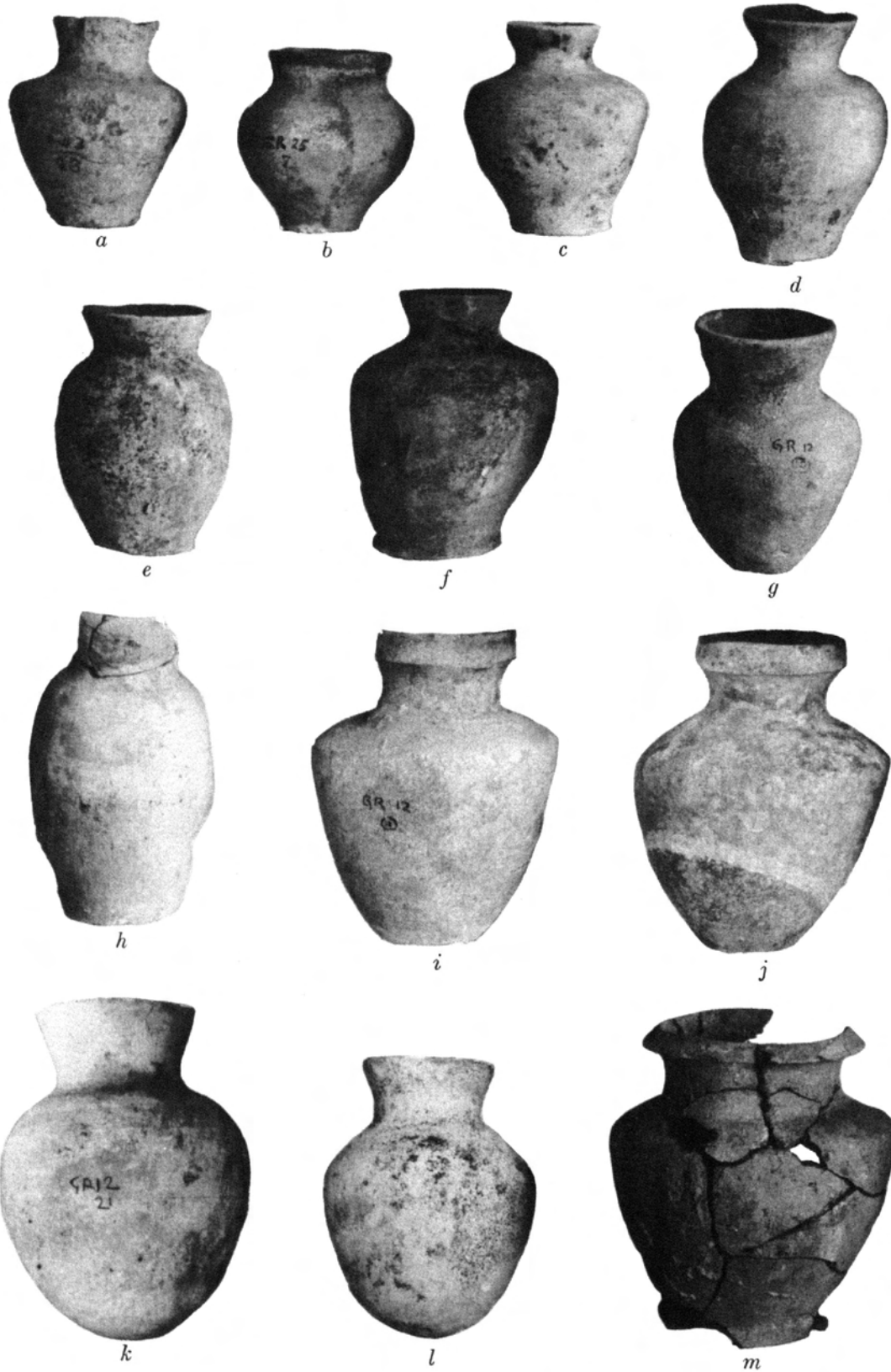

COMMON HOUSEHOLD JARS FROM HOUSES 6 AND 5 (j) AT KHAFAJAH. SCALE, 2:5

- | | | |
|-------------|-------------|--------------|
| a B.535.220 | e B.556.220 | j B.545.240a |
| b B.576.220 | f B.525.220 | k B.566.560 |
| c B.485.220 | g B.546.220 | l B.556.520 |
| d B.546.220 | h B.486.220 | m C.515.370a |
| | i B.526.270 | |

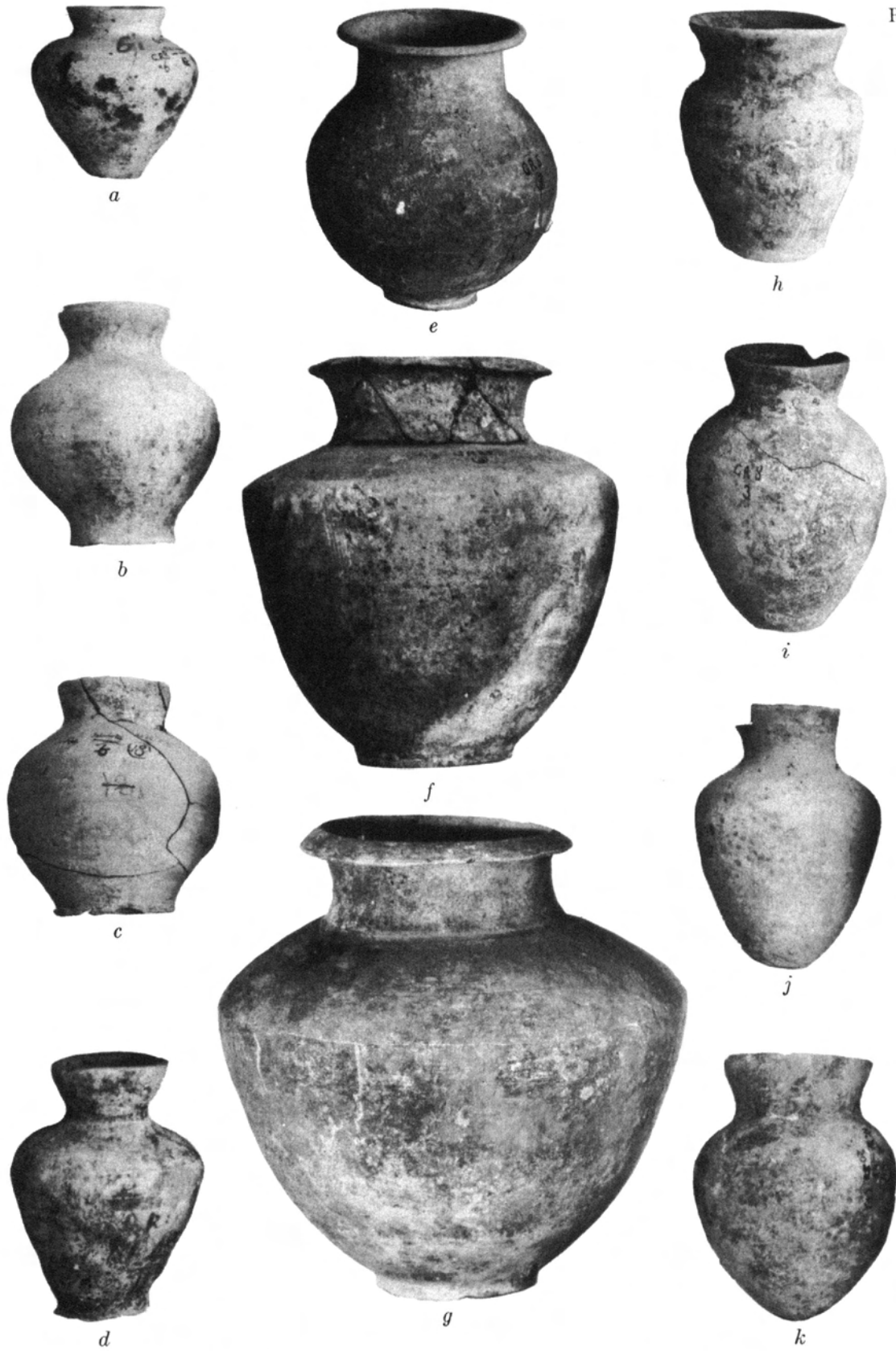

COMMON HOUSEHOLD JARS FROM HOUSES 5 AND 4 AND TWO RED-PAINTED JARS

(*f-g*) FROM HOUSES 6 AT KHAFAJAH. SCALE, 2:5

- | | | |
|-----------------------------|-----------------------------|--------------------|
| <i>a</i> B.535.220 | <i>e</i> C.655.340 <i>b</i> | <i>i</i> B.556.220 |
| <i>b</i> B.545.220 <i>a</i> | <i>f</i> C.515.270 | <i>j</i> B.546.520 |
| <i>c</i> B.675.220 <i>b</i> | <i>g</i> C.514.370 <i>a</i> | <i>k</i> B.546.620 |
| <i>d</i> B.536.220 | <i>h</i> B.495.220 | |

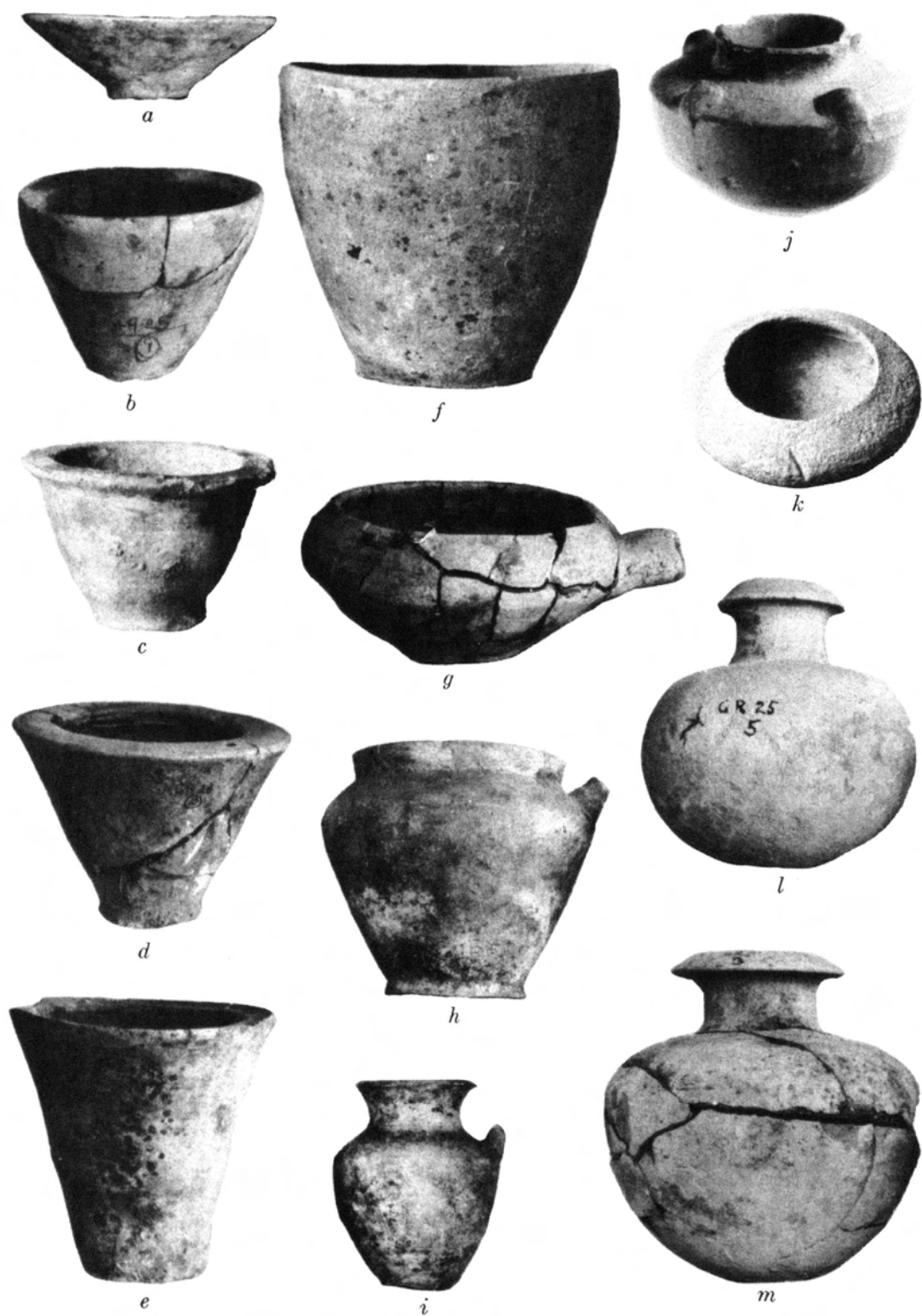

ED II VESSELS FROM KHAFAJAH. SCALE, 1:5 (h), 2:5 (a-g, i, k-m), AND 4:5 (j)

- | | | |
|--------------|-------------|-------------|
| a B.001.200a | e B.025.210 | j A.493.263 |
| b B.033.200 | f C.044.200 | k B.601.530 |
| c B.033.210 | g C.052.202 | l B.665.540 |
| d B.003.210b | h C.404.362 | m B.545.540 |
| | i A.525.273 | |



FLASKS FROM KHAFAJAH, PROBABLY ALL OF ED II DATE. SCALE 2:5
a B.806.570 b B.807.570 c-e B.806.570 f B.816.521a



UPRIGHT-HANDLED JARS OF ED I (a) AND II FROM TELL ASMAR (a) AND KHAFAJAH. SCALE, 1:5

<i>a</i> D.526.371	<i>c</i> C.515.371	<i>e</i> C.516.371b
<i>b</i> C.526.371	<i>d</i> C.526.371a	<i>f</i> C.515.371



UPRIGHT-HANDLED JARS FROM ED II AND III GRAVES AT KHAFAJAH. SCALE, 2:5 (a) AND 1:5 (b-g)

<i>a</i> C.506.371	<i>d</i> C.526.471e	<i>f</i> C.516.371b
<i>b-c</i> C.516.371b	<i>e</i> C.526.371b	<i>g</i> C.517.371



a



b

ED II UPRIGHT-HANDLED VASES FROM KHAFAJAH. SCALE, 2:5
a C.526.371*a* *b* C.515.371



a



b

UPRIGHT-HANDLED JARS (C.526.371*b*) FROM GRAVES OF HOUSES 3 AT KHAFAJAH
SCALE, 2:5 (SEE PL. 85 *a* FOR LARGER-SCALE VIEW OF *b*)

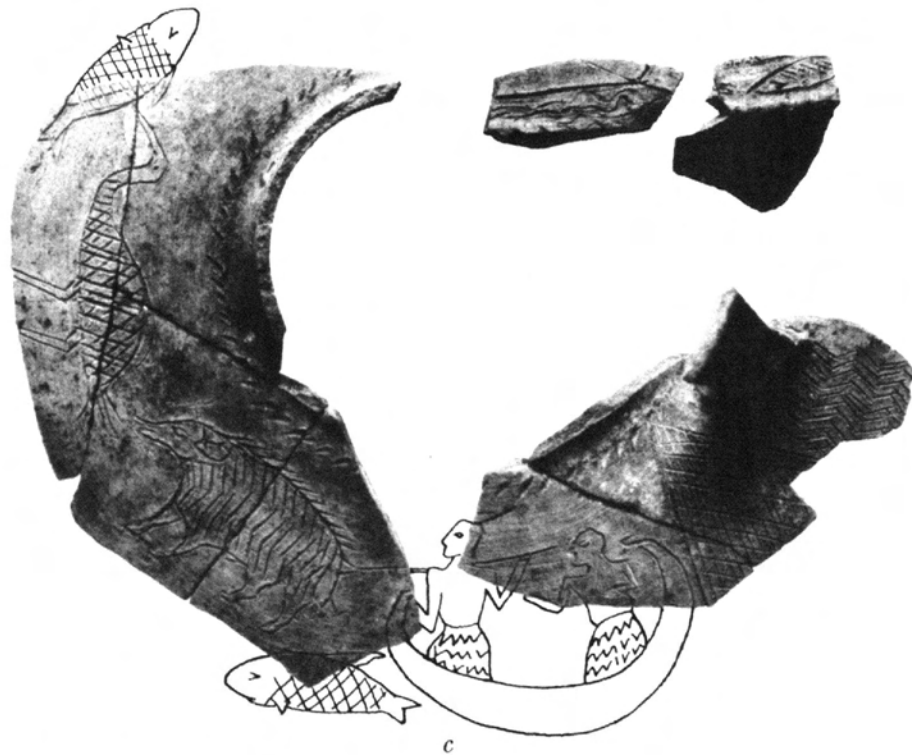

UPRIGHT-HANDLED JARS FROM ARCHAIC SHRINE IV AT TELL ASMAR (*a*) AND HOUSES 3 AND 2 AT KHAFAJAH (*b-c*). SCALE, 1:5 (*a-b*) AND (1:2 *c*)
a D.516.371 *b* D.526.371 (= Pl. 85 *b*)



"FRUIT STANDS" FROM ED II AND III GRAVES AT KHAFAJAH. SCALE, 1:5

- | | | |
|--------------------|-----------------------------|-----------------------------|
| <i>a</i> C.366.810 | <i>c</i> C.366.810 | <i>e</i> C.365.810 <i>b</i> |
| <i>b</i> C.367.810 | <i>d</i> C.365.810 <i>d</i> | |

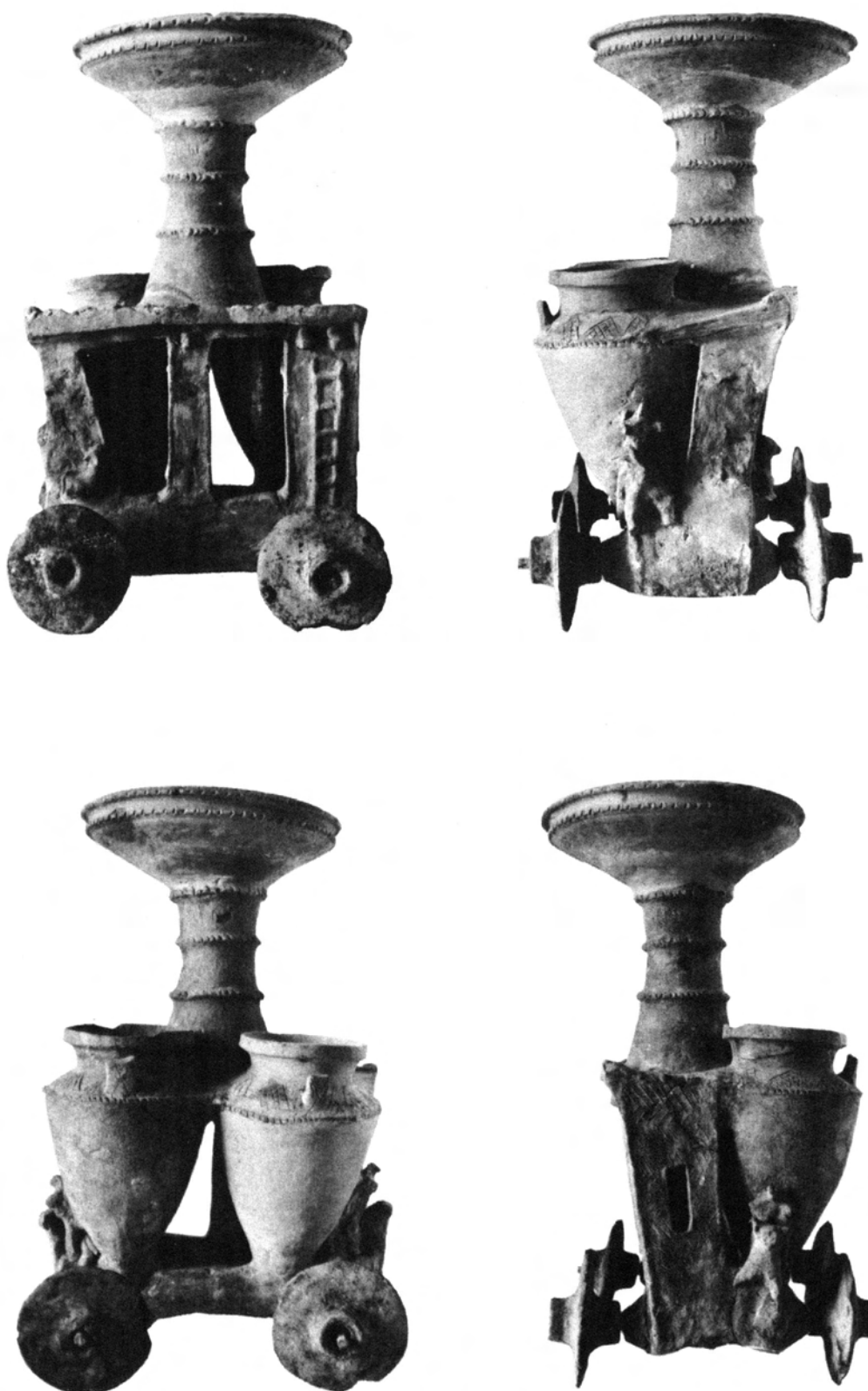

"CULT WAGON" (C.99) FROM SIN TEMPLE VIII AT KHAFAJAH. SCALE, 1:5

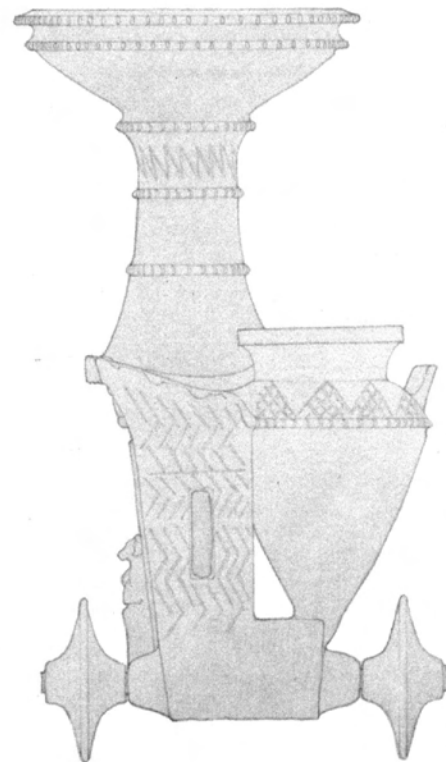
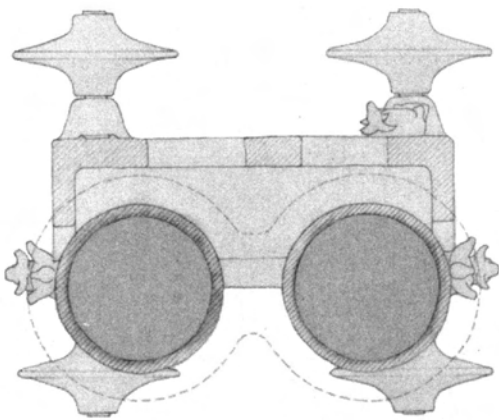
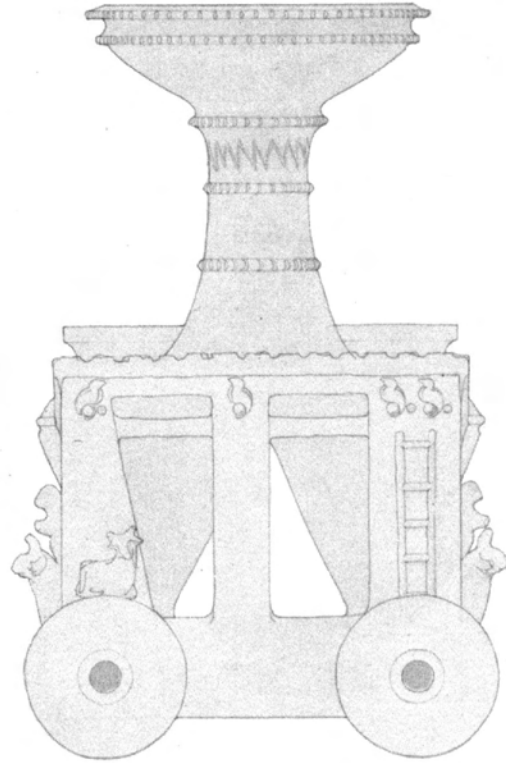
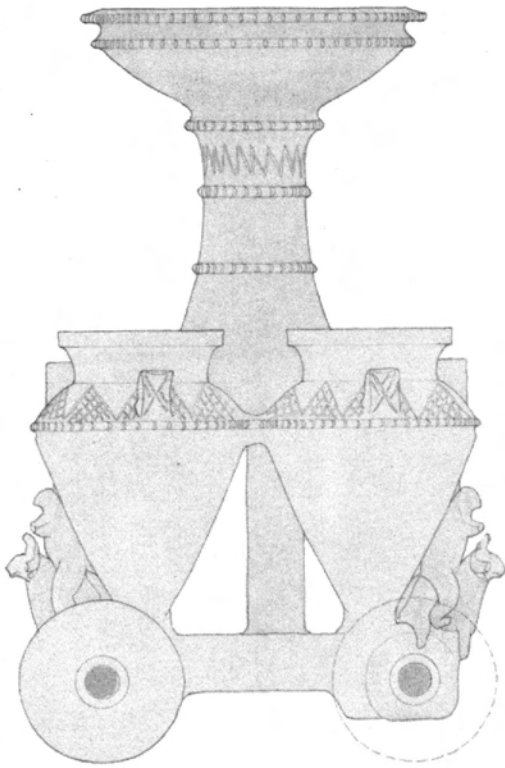

DRAWINGS OF "CULT WAGON." SCALE, 1:5



UPRIGHT-HANDLED JARS FROM TELL AGRAB (*f*) AND KHAFAJAH. SCALE, 1:5

a C.525.471

c C.526.471a

e C.527.471

b C.526.371

d C.516.471

f C.526.471d



a

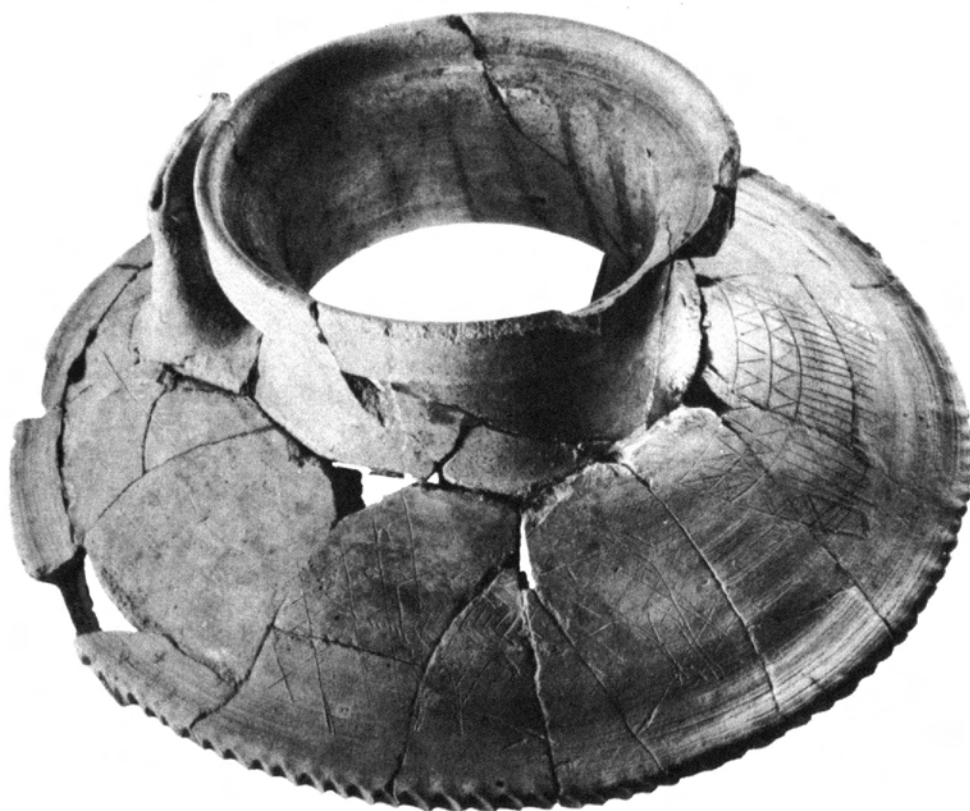

b

LARGER-SCALE VIEWS OF SHOULDERS OF JARS SHOWN IN PLATES 79 *b* AND 80 *b*
a C.526.371*b* *b* D.526.371

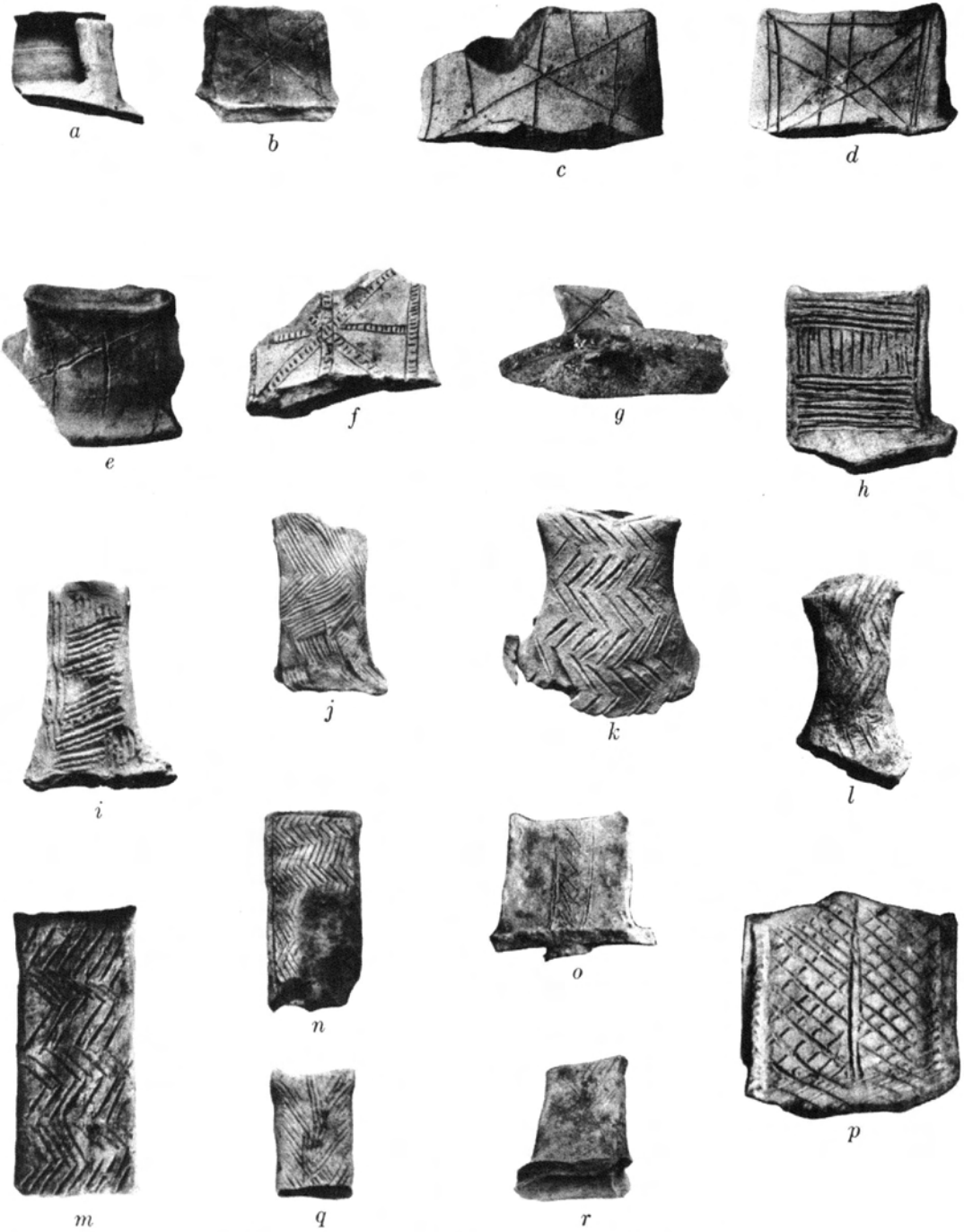

UPRIGHT HANDLES WITH INCISED DECORATION. SCALE, 2:5



UPRIGHT HANDLES WITH INCISED AND PLASTIC DECORATION. SCALE, 2:5
e C.526.471a



ED III "FRUIT STANDS" FROM KHAFAJAH. SCALE, 2:5
a-c C.365.810a d C.364.810b e C.363.810b f C.364.810a



FRAGMENTS OF ED III "FRUIT STANDS" WITH INCISED DECORATION,
FROM TELL ASMAR (i) AND KHAFAJAH. SCALE, 2:5
i-j C.365.810d



SPOUTED JARS FROM GRAVES OF HOUSES 3 AT KHAFAJAH. SCALE, 1:5

a C.526.362b *c* C.556.322 *e* C.527.362
b C.525.462 *d* C.526.362b *f* C.526.362b

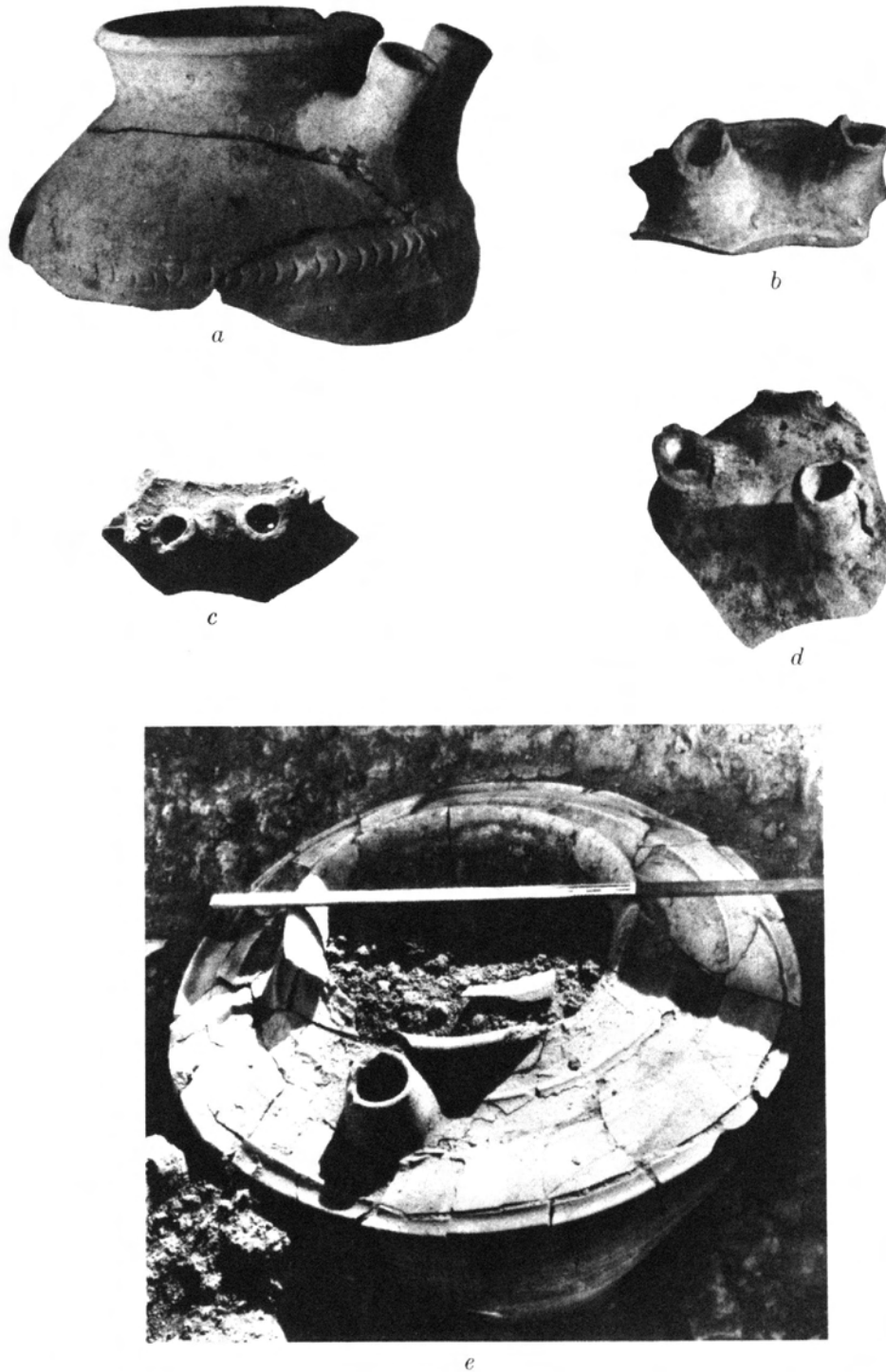

FRAGMENTS OF DOUBLE-SPOUTED VESSELS FROM TELL ASMAR AND KHAFAJAH, A SINGLE-SPOUTED
VESSEL AS FOUND IN TEMPLE OVAL II AT KHAFAJAH. SCALE, 2:5 (*a-d*) AND *ca.* 1:5 (*e*)
a C.555.522 *e* D.514.362

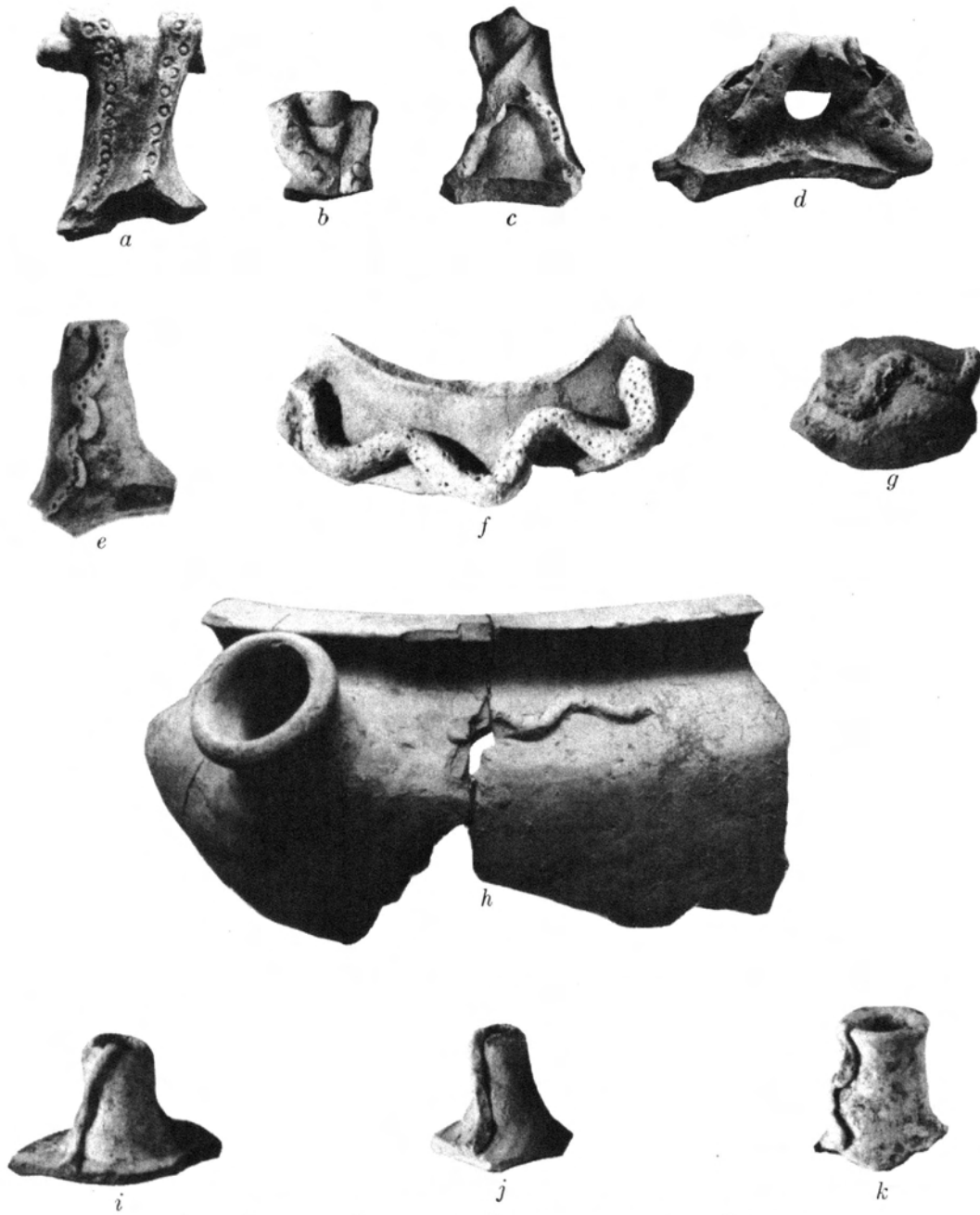

Snake-Decorated Fragments of Protoliterate to Larsa Date from
Khafajah (g) and Tell Asmar. Scale, 2:5
h C.053.312



a



b

UNUSUAL SPOUTED JARS OF ED III FROM KHAFAJAH. SCALE, 2:5

a C.525.352

b C.504.367



ED II TO LARSA(?) THERIOMORPHIC VESSELS AND FRAGMENTS FROM TELL AGRAB (*g*),
TELL ASMAR, AND KHAFAJAH. SCALE, 2:5 (*a-h*) AND 4:5 (*i*)
a C.95 *b-h* C.96 *i* A.96



ED III FRAGMENTS WITH INCISED AND PLASTIC DECORATION,
FROM KHAFAJAH. SCALE, 2:5

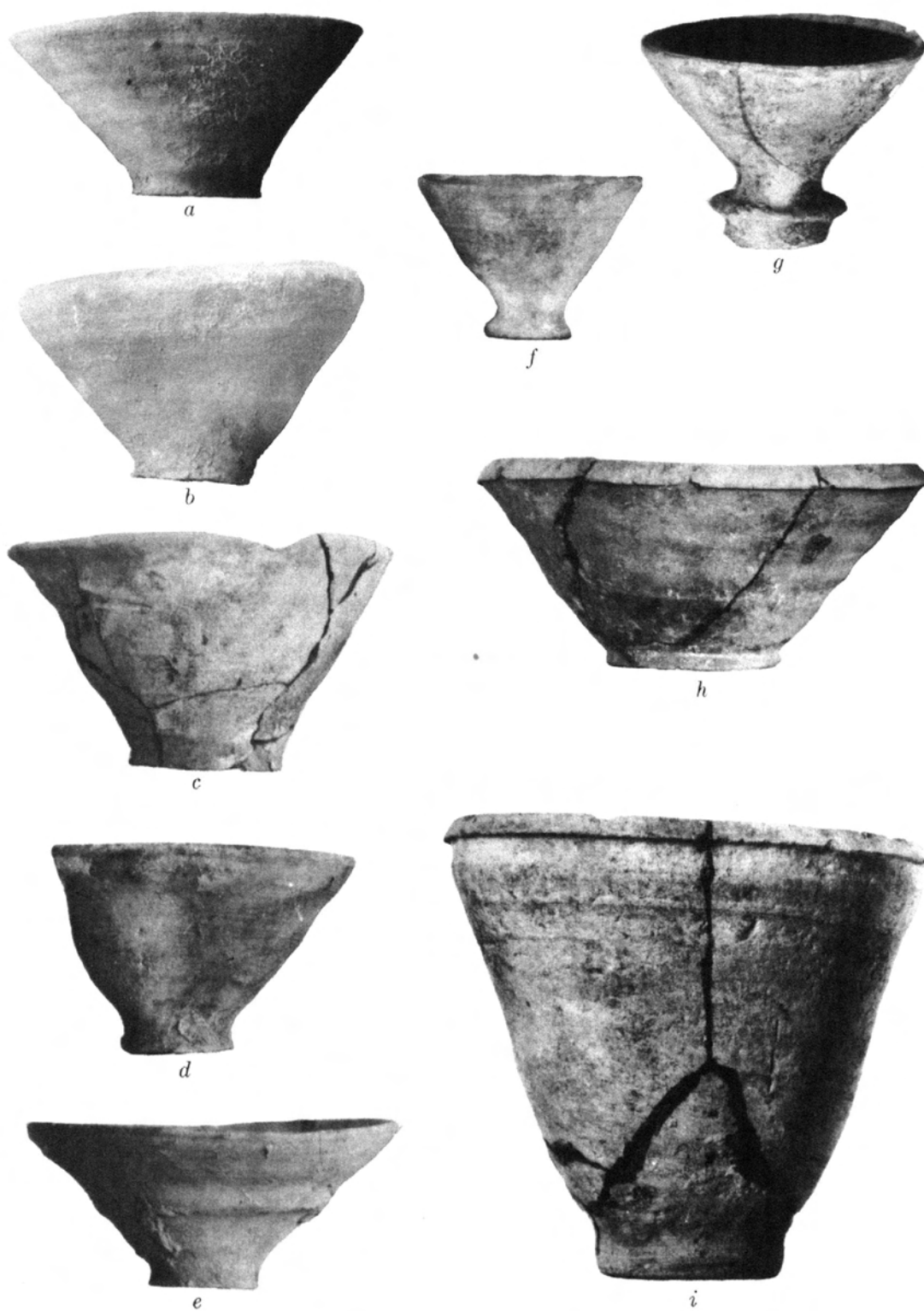

ED III BOWLS FROM TELL ASMAR (*i*) AND KHAFAJAH. SCALE, 2:5 (*a-g, i*) AND 1:5 (*h*)

<i>a</i> B.002.200a	<i>d</i> B.083.200	<i>g</i> B.033.700a
<i>b</i> C.053.200	<i>e</i> B.082.200	<i>h</i> C.082.310
<i>c</i> C.083.200	<i>f</i> B.033.700b	<i>i</i> C.084.310



CONICAL BOWLS WITH INNER RIMS AND BOWLS WITH CONVEX BASES, FROM TELL ASMAR (j)
AND KHAFAJAH, PROBABLY ALL OF ED III DATE. SCALE, 2:5

a B.022.210	d B.023.210	h B.084.210c	l C.002.500
b B.060.210	e B.062.210b	i B.083.210c	m B.652.520
c B.081.210	f B.083.210b	j B.084.710b	n A.652.500
	g B.082.210	k B.073.210	

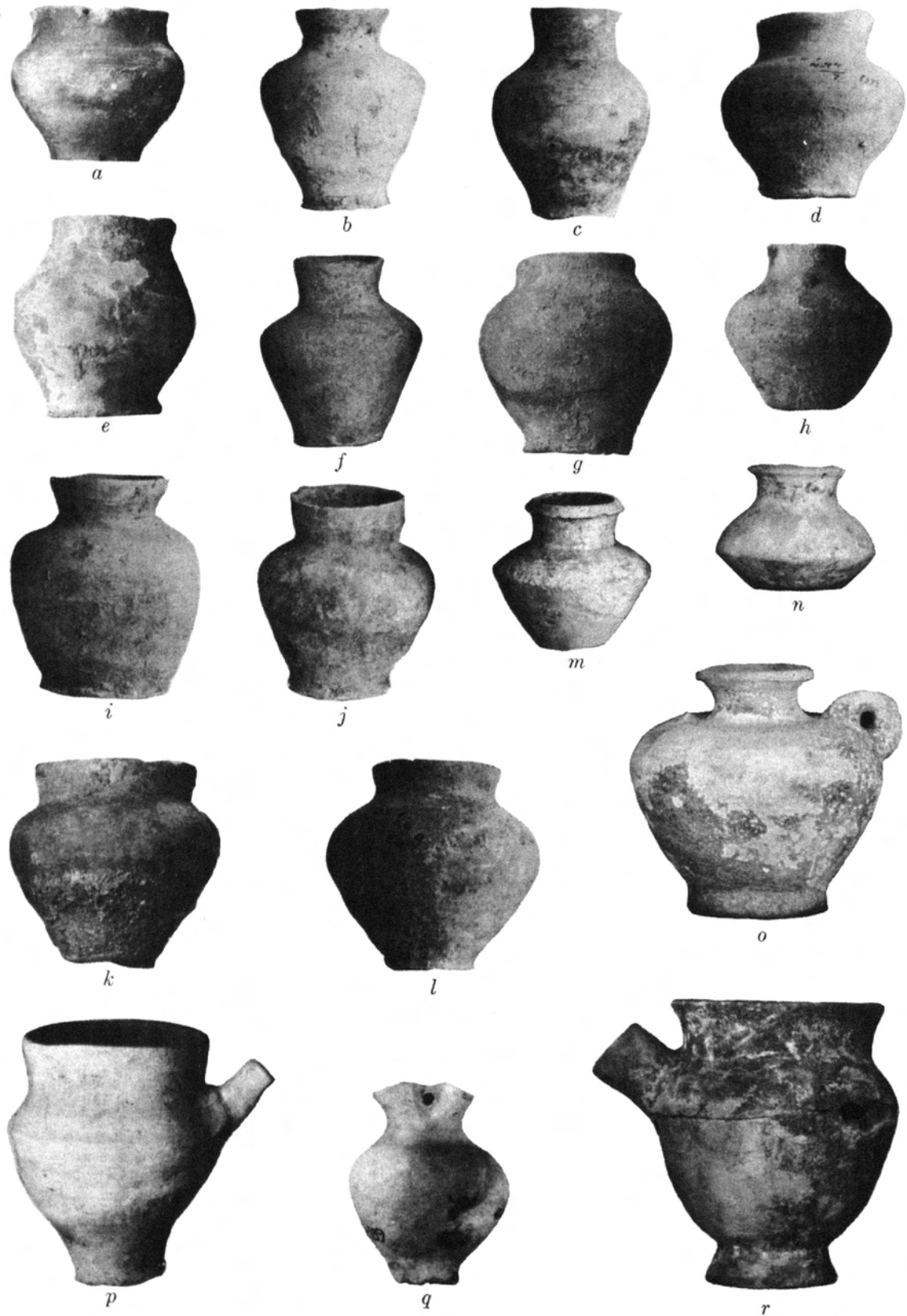

SMALL HOUSEHOLD JARS FROM TELL ASMAR (p) AND KHAFAJAH,
PROBABLY ALL OF ED III DATE. SCALE, 2:5

- | | | | |
|--------------|--------------|--------------|-------------|
| a B.574.220c | e B.675.220a | i B.555.220 | m A.514.270 |
| b B.545.220c | f B.675.220b | j B.535.240 | n B.613.270 |
| c B.576.220 | g B.515.220 | k B.184.220c | o B.564.371 |
| d B.545.220c | h B.575.223 | l B.534.220 | p B.175.221 |
| q B.575.225 | | r B.556.422 | |

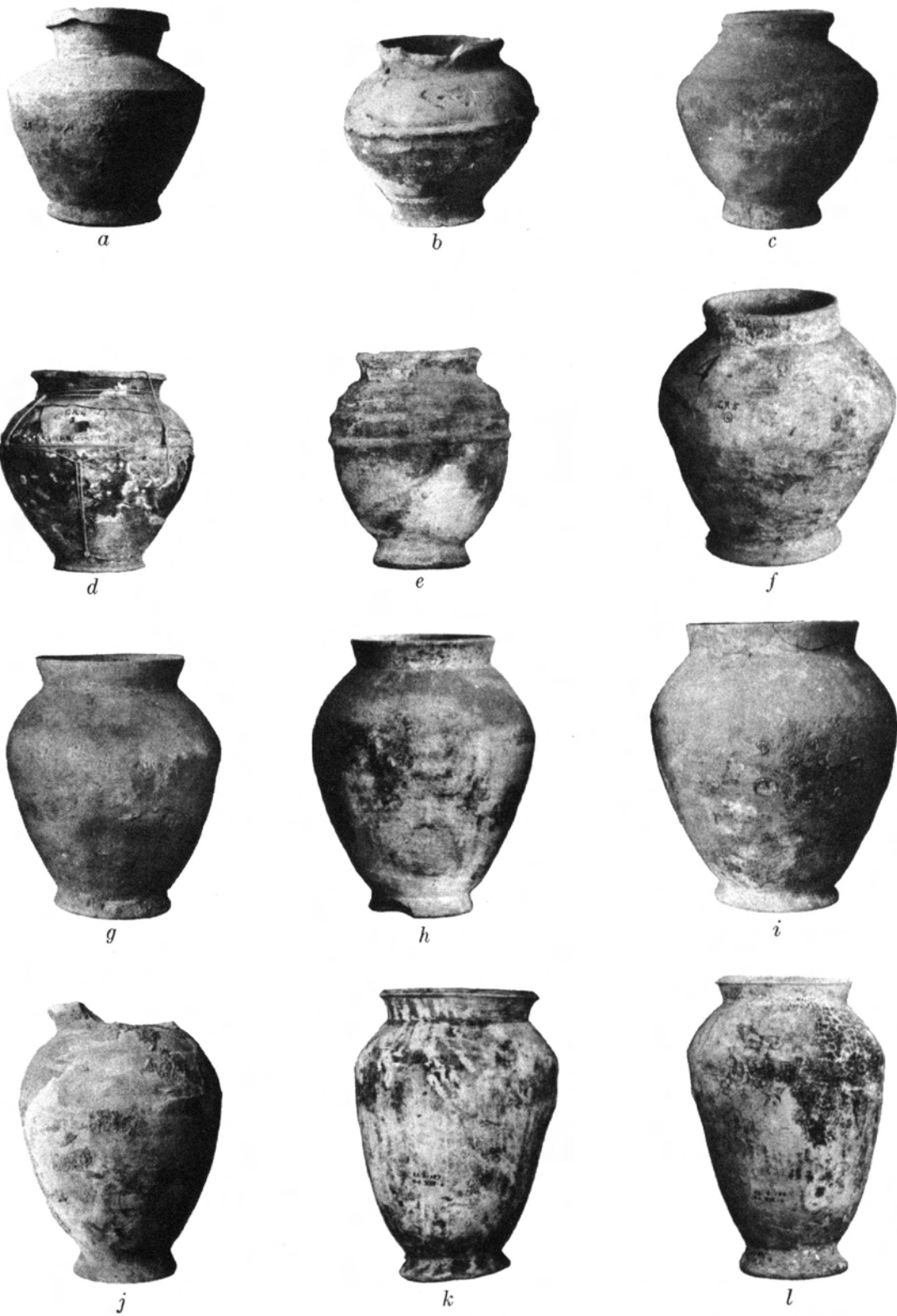

MEDIUM-SIZED HOUSEHOLD JARS FROM KHAFAJAH, ALL OF ED III DATE
EXCEPT *f* (ED II) AND *k-l* (PROTOIMP.?). SCALE, 1:5

- | | | |
|---------------------|--------------------|----------------------|
| <i>a</i> C.515.370a | <i>d</i> C.545.320 | <i>h-i</i> C.545.320 |
| <i>b</i> C.504.360 | <i>e</i> C.655.460 | <i>j</i> C.556.420 |
| <i>c</i> C.505.370a | <i>f</i> C.505.320 | <i>k-l</i> C.406.340 |
| | <i>g</i> C.555.420 | |

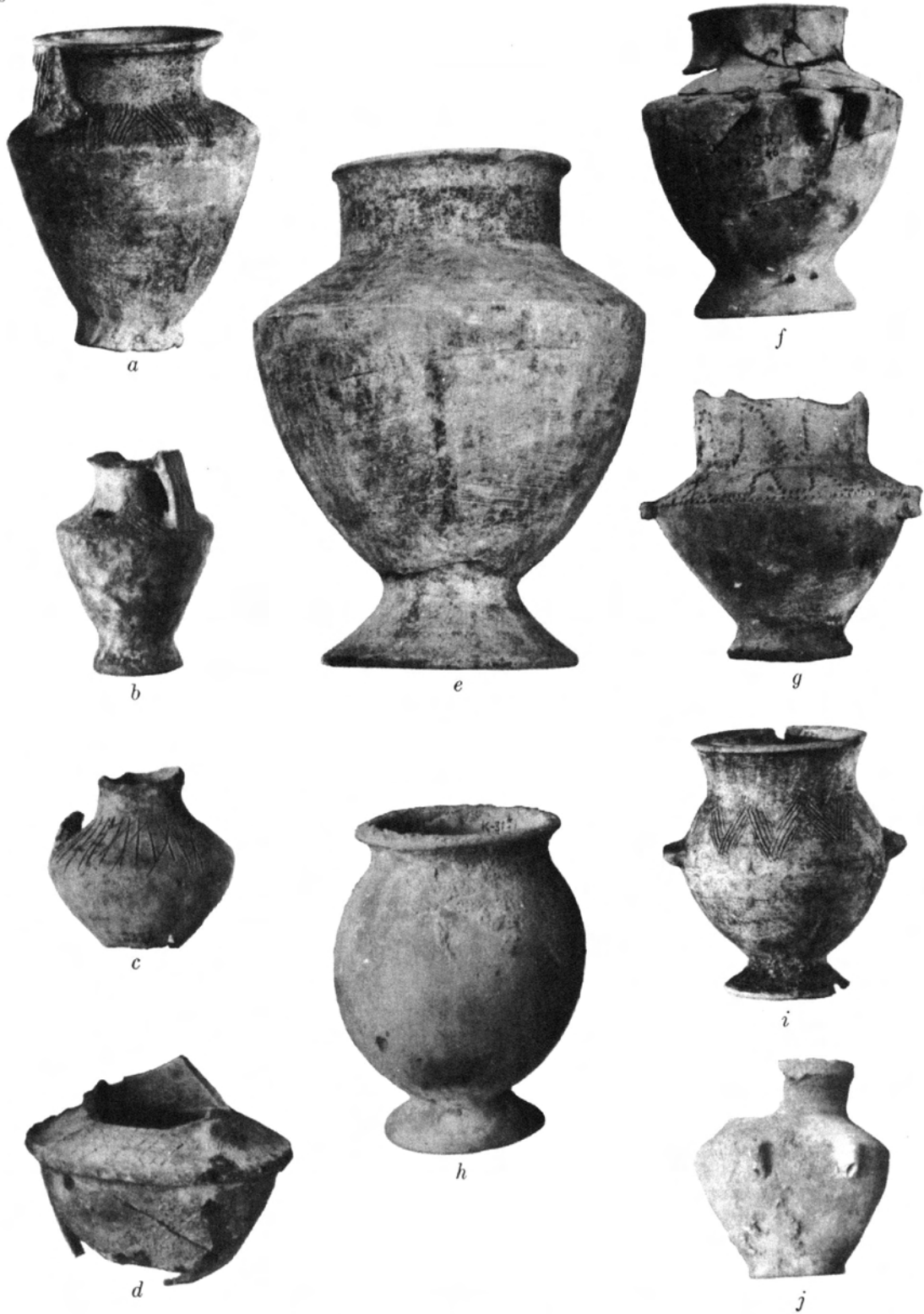

JARS FROM TELL ASMAR (c) AND KHAFAJAH, PROBABLY ALL OF ED III DATE. SCALE, 2:5

- | | | |
|--------------|--------------|-------------|
| a B.516.371a | d B.516.371b | h C.686.420 |
| b B.516.471b | e C.515.870 | i C.686.443 |
| c B.505.571 | f C.515.463 | j B.514.373 |
| | g B.515.363 | |



VESSELS WITH SUSPENSION DEVICES, FROM TELL ASMAR (*j*) AND KHAFAJAH, ALL OF ED III DATE EXCEPT *j* (PROTOIMP.?) AND POSSIBLY *i*. SCALE, 4:5 (*a-h*) AND 2:5 (*j*)

- | | | |
|--------------------|--------------------|--------------------|
| <i>a</i> A.514.733 | <i>d</i> A.516.373 | <i>h</i> A.014.703 |
| <i>b</i> A.415.273 | <i>e</i> A.654.543 | <i>i</i> A.493.263 |
| <i>c</i> A.424.353 | <i>f</i> A.516.151 | <i>j</i> C.003.203 |
| | <i>g</i> A.041.503 | |



SMALL VESSELS FROM KHAFAJAH AND TELL ASMAR, ALL OF ED III DATE
EXCEPT *i* (PROTOIMP.). SCALE, 2:5

- | | | |
|---------------------|---------------------|---------------------|
| <i>a</i> B.555.540a | <i>e</i> B.514.570 | <i>i</i> B.816.521b |
| <i>b</i> B.535.610 | <i>f</i> B.545.540 | <i>j</i> B.816.521 |
| <i>c</i> B.545.640a | <i>g</i> B.663.540b | <i>k</i> B.816.521a |
| <i>d</i> B.544.560 | <i>h</i> B.816.521c | <i>l</i> B.816.521 |



SMALL ED III VESSELS FROM KHAFAJAH. SCALE, 4:5

- | | | |
|---------------------|---------------------|---------------------|
| <i>a</i> A.545.540 | <i>c</i> B.655.520 | <i>f</i> A.243.900a |
| <i>b</i> B.655.540a | <i>d</i> B.755.520 | <i>g</i> A.001.300 |
| | <i>e</i> A.655.520a | |



FRAGMENTS OF ED III AND PROTOIMPERIAL BRAZIERS FROM KHAFAJAH AND TELL ASMAR, A PROTOIMPERIAL(?)
"KITCHEN RANGE" FROM TELL ASMAR. SCALE, 2:5 (a, d, f) AND 1:5 (b, c, e)
a C.202.203 c C.201.203 e D.801.201
b C.042.203 d C.011.201a f C.011.201a



TWO BRAZIERS (*a-b*) PROBABLY FROM KHAFAJAH, VESSELS OF RIBBED AND STUDED WARES
 FROM TELL ASMAR. SCALE, 2:5 (*a, g-i*) AND 1:5 (*b-f*)
a C.305.800 *c* C.215.210 *f* C.216.210
b C.246.310 *d* C.303.200 *g* C.665.543d
 e C.805.210



AN ED III(?) BOWL FROM KHAFAJAH (*a*) AND UNUSUAL FRAGMENTS OF ED III (*b-d, f, h, j, k, m*), AGADE? (*i*), AND LARSA (*e, g, l*) DATE FROM KHAFAJAH AND TELL ASMAR. SCALE, 2:5

a B.031.500

l C.98

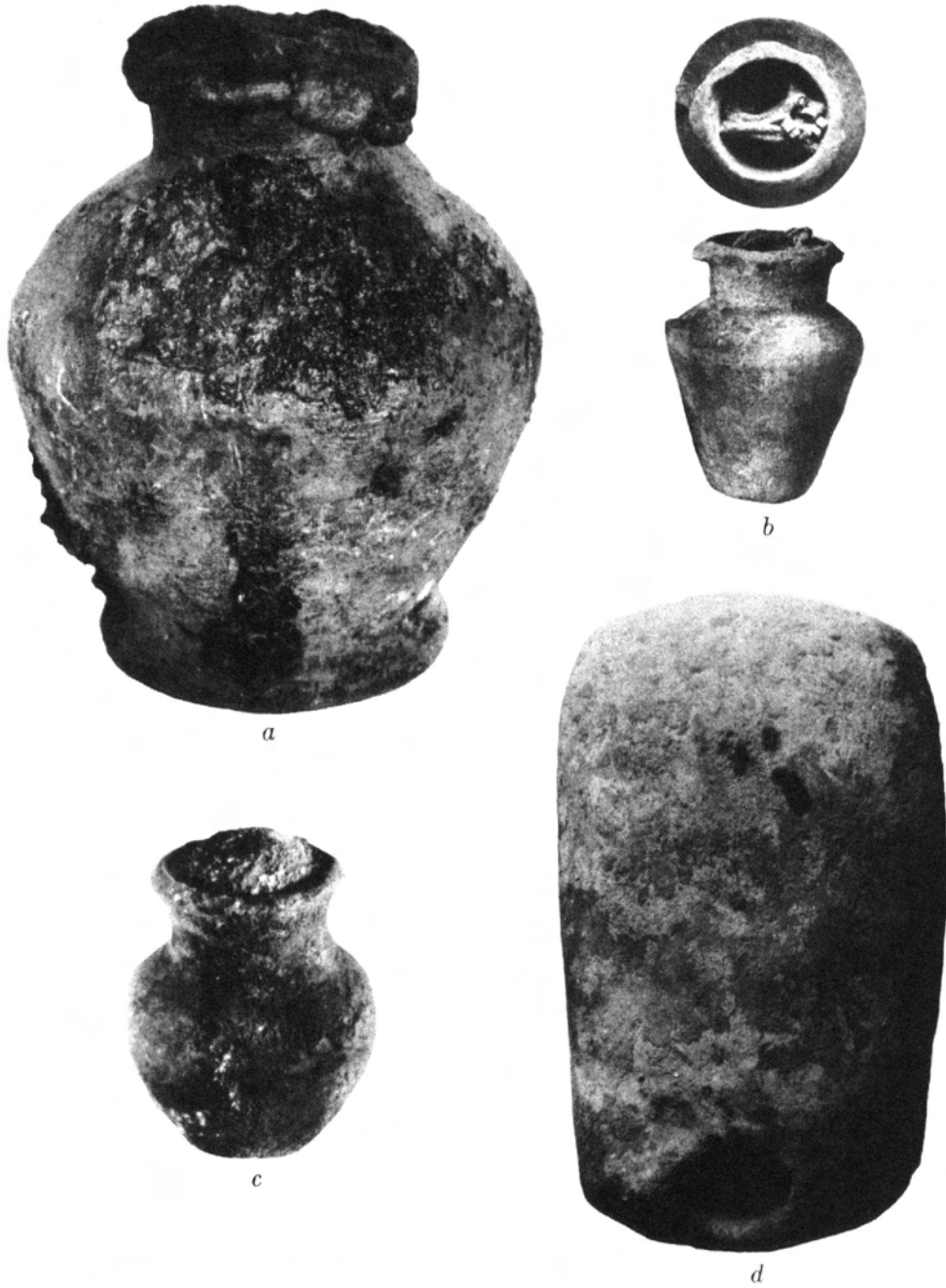

VESSELS USED AS "JEWEL BOXES" OR "SAFES" FROM TELL ASMAR (c) AND KHAFAJAH, OF
ED II (d), ED III (a-b), AND LARSA (c) DATE. SCALE, 2:5
a C.545.340d b B.516.271 c B.545.240c d C.861

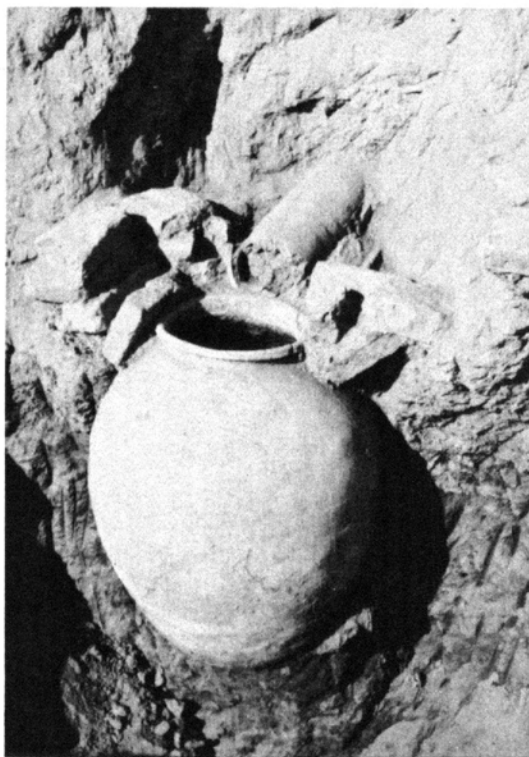

LARGE JAR (D.556.540a) WITH PERFORATION IN BASE,
USED IN CONNECTION WITH HORIZONTAL DRAIN
IN HOUSES 3 AT KHAFAJAH

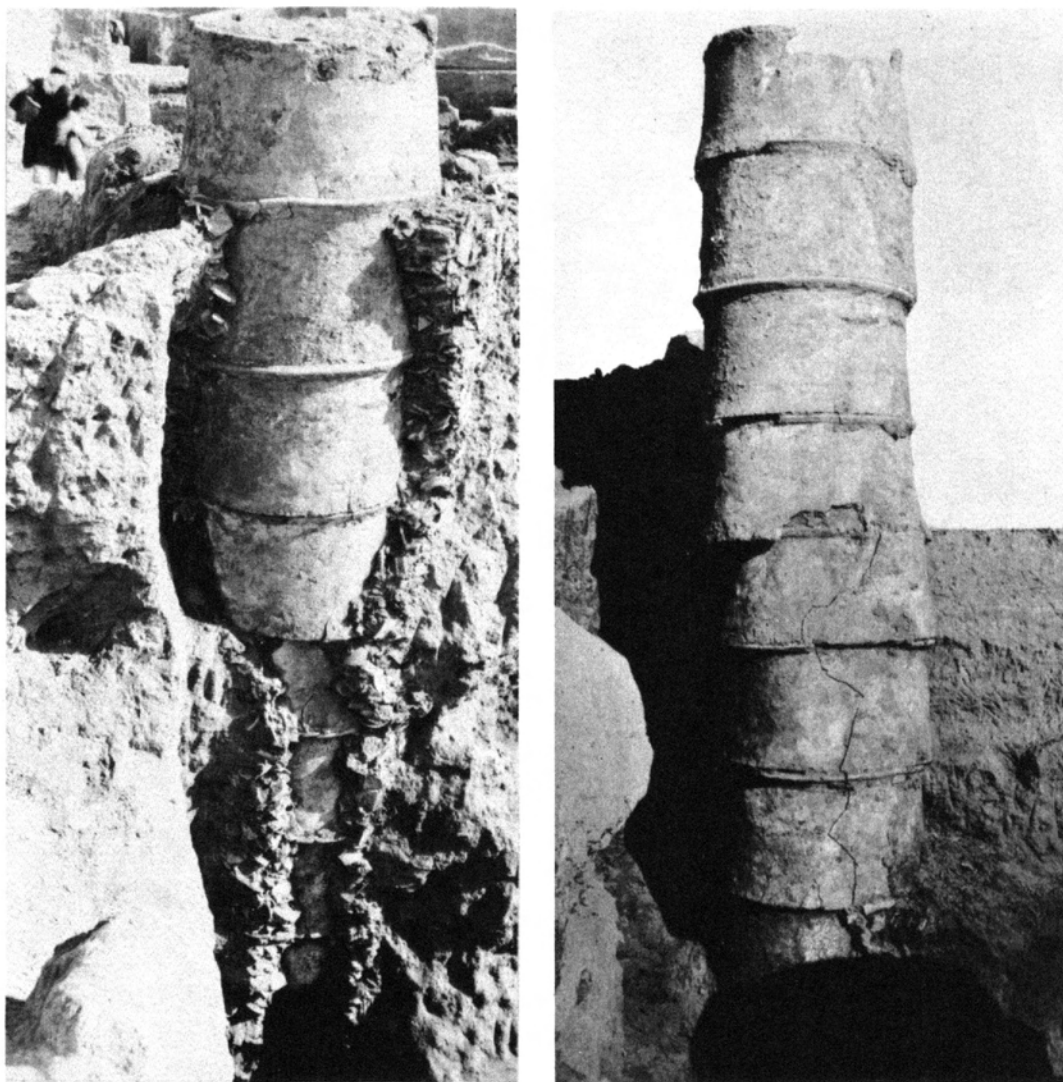

VERTICAL DRAIN (E.232.010) IN HOUSES 4 AT KHAFAJAH BEFORE (LEFT)
AND AFTER REMOVAL OF SHERD PACKING



TWO ED III SPOUTS (*a, j*) FROM KHAFAJAH, TWO CONICAL BOWLS (*b-c*) AND PROTOIMPERIAL VESSELS (*d-i*) FROM TELL ASMAR. SCALE, 2:5

<i>b</i> C.042.200	<i>d</i> B.556.222	<i>f</i> B.555.224	<i>h</i> C.587.862
<i>c</i> B.001.200a	<i>e</i> B.576.224	<i>g</i> B.645.220	<i>i</i> B.505.250



ROUND-BOTTOMED BOTTLES OF PROTOIMPERIAL TO GUTIUM-UR III
TIMES FROM TELL ASMAR. SCALE, 2:5

<i>a</i> B.634.570 <i>b</i>	<i>c</i> B.636.570	<i>e</i> C.664.640	<i>g</i> B.633.570 <i>b</i>
<i>b</i> B.633.570 <i>a</i>	<i>d</i> B.664.540 <i>a</i>	<i>f</i> C.743.570	<i>h</i> B.663.520

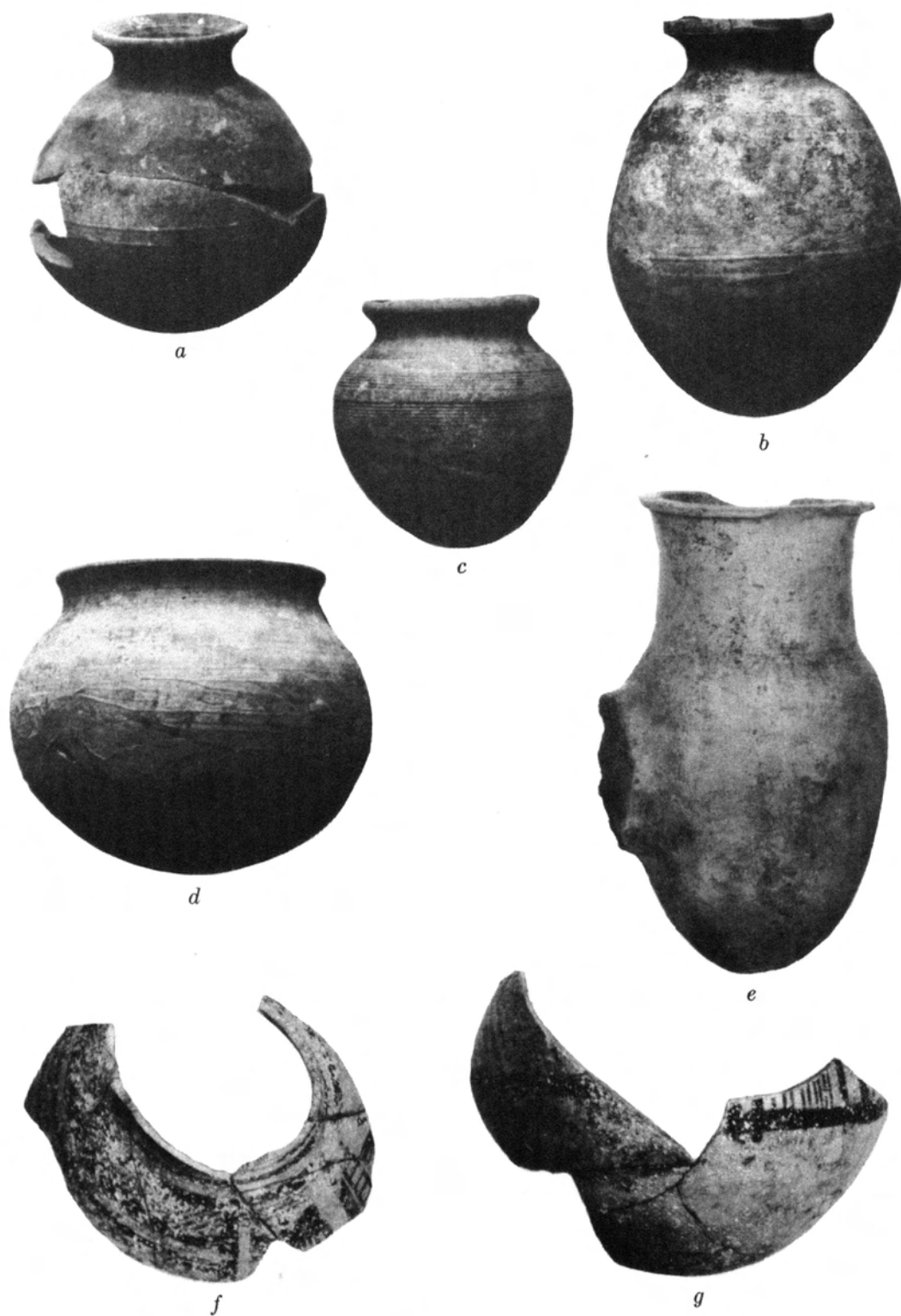

BOTTLES AND OTHER POTTERY FROM TELL ASMAR, PROBABLY ALL
OF PROTOIMPERIAL DATE. SCALE, 2:5

a B.755.540
b C.656.540

c B.655.540*b*

d C.653.520
e C.557.640

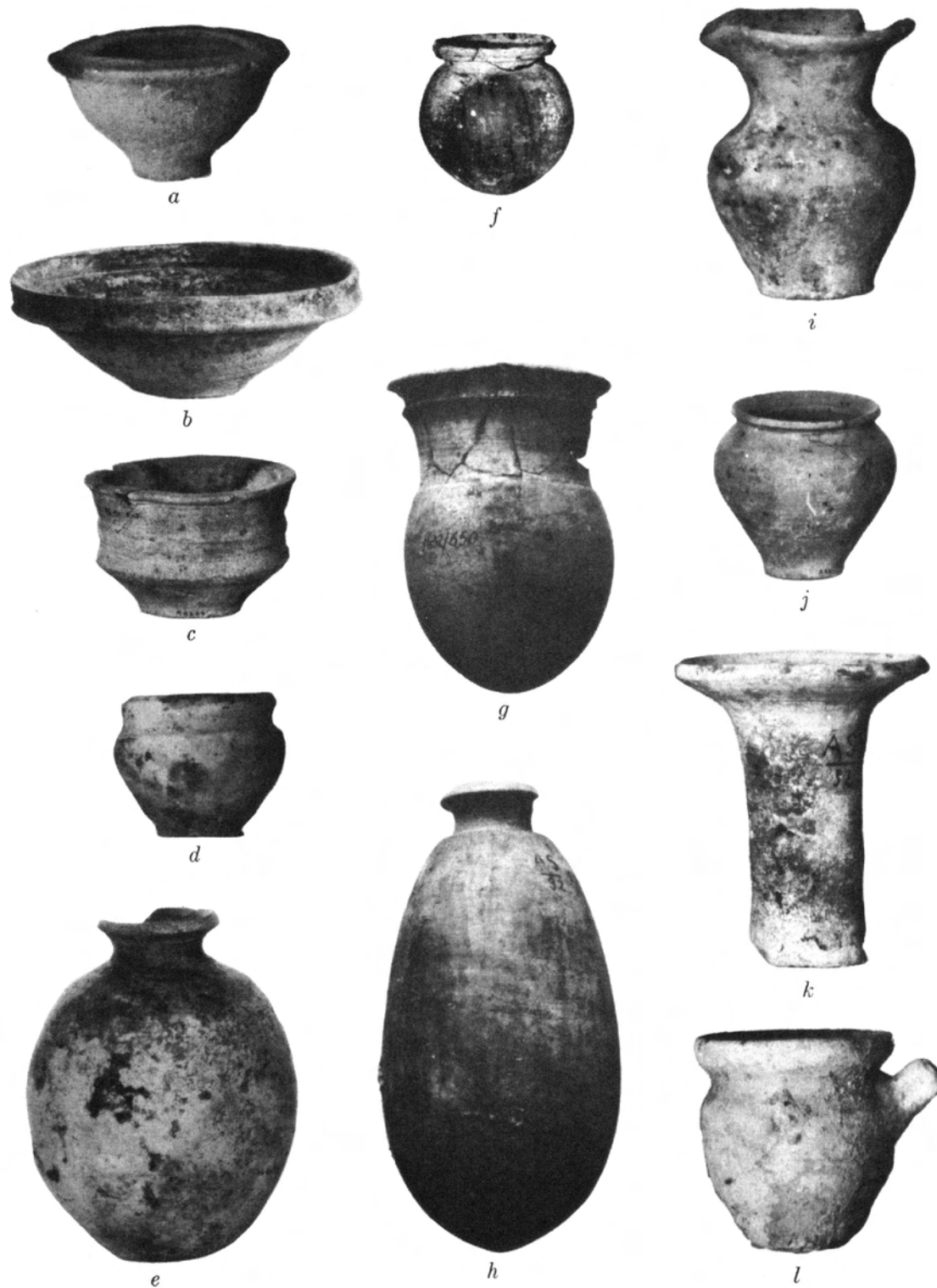

MISCELLANEOUS POTTERY OF AGADE AND GUTIUM-UR III TIMES FROM TELL ASMAR. SCALE, 2:5

- | | | | |
|---------------------|---------------------|--------------------|---------------------|
| <i>a</i> B.072.210b | <i>d</i> B.174.220a | <i>g</i> B.556.540 | <i>j</i> B.574.240 |
| <i>b</i> B.151.210 | <i>e</i> B.666.540a | <i>h</i> C.757.540 | <i>k</i> B.256.200 |
| <i>c</i> B.123.210 | <i>f</i> B.655.640 | <i>i</i> B.536.224 | <i>l</i> B.545.222a |



AGADE (*a-f*) AND GUTIUM-UR III (*g-h*) UTENSILS FROM TELL ASMAR.

SCALE, 2:5 (*a-b*) AND 1:5 (*c-h*)

b B.042.500*b* *d* C.657.522 *g* C.257.210
c C.053.312 *e* C.547.242 *h* C.427.570
f C.777.340



a

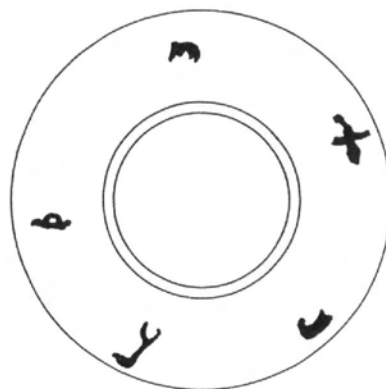

c



b



d

STORAGE JARS FROM TELL ASMAR, OF PROTOIMPERIAL? (*a*) AND
AGADE (*b-d*) DATE. SCALE, 1:5
a D.465.460 *b* D.466.360 *c* D.596.540 *d* D.546.540*a*



a



b

BRAZIER (D.201.201*b*) FOUND AT TELL ASMAR PROBABLY IN HOUSES IV *a* (*a*) AND CLAY MINIATURE MODEL (CHICAGO A 4636) FROM BISMAYAH (*b*). SCALE, 1:5 (*a*) AND 4:5 (*b*)



a



b



c

BRAZIER OF GUTIUM-UR III (*b*) AND LARSA? (*a*) TIMES AND AN EARLY AGADE
"KITCHEN RANGE" (*c*), ALL *in situ* AT TELL ASMAR
a-b D.201.201b *c* D.801.201

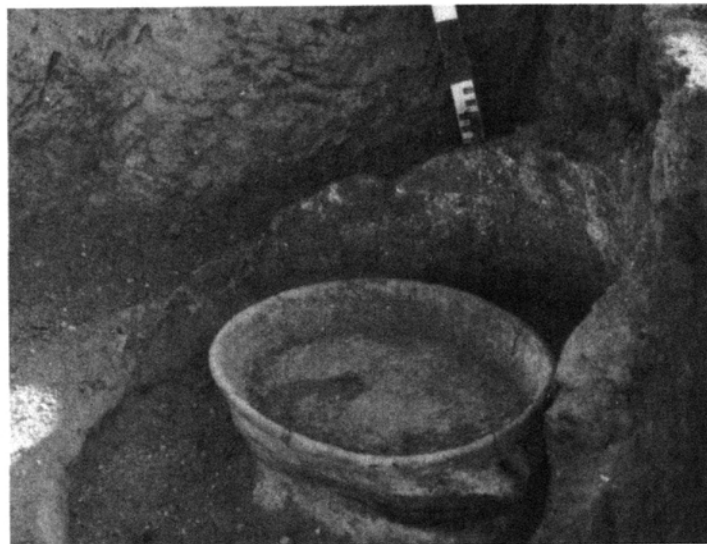

a



b

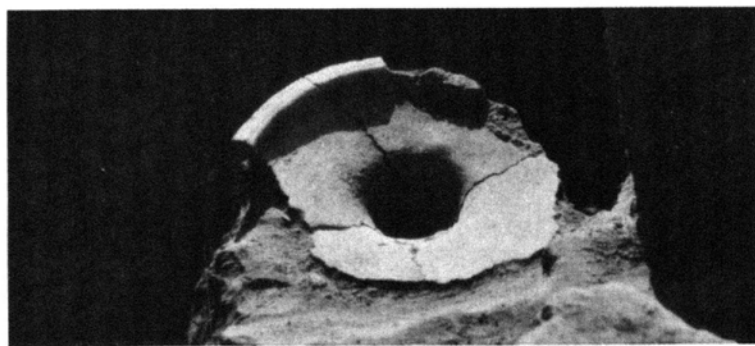

c

"CRUCIBLE" (*a*) AND BRAZIER (*b*) OF GUTIUM-UR III TIMES AND A LATE LARSA
"WASH BASIN" (*c*), ALL *in situ* AT TELL ASMAR
a D.800.102 *b* D.201.201a *c* E.062.210



JARS FROM TELL ASMAR, PROBABLY ALL OF LARSA DATE. SCALE, 4:5 (a-d) AND 2:5 (e-f)

a B.705.370	c A.666.422	e C.576.242
b A.586.462	d A.527.462	f C.226.540



MISCELLANEOUS UTENSILS FROM TELL ASMAR, PROBABLY ALL OF LARSA DATE. SCALE, 2:5

- | | | |
|--------------|--------------|--------------|
| a B.151.210 | d B.032.500 | h B.236.200c |
| b B.061.210 | e C.043.510 | i B.237.100 |
| c B.052.200b | f C.031.300 | j B.717.700 |
| | g B.236.200a | |



MISCELLANEOUS UTENSILS FROM TELL ASMAR, PROBABLY ALL OF LARSA
 DATE EXCEPT *d* (AGADE?). SCALE, 2:5 (*a-c*) AND 1:5 (*d-g*)
a B.527.340 *c* B.656.320 *f* C.547.720
b C.545.340c *d* C.064.300 *g* C.208.440
e C.228.340a



SMALL JARS WITH SUSPENSION LOOPS AND A FRAGMENT OF INCISED GRAY WARE FROM
TELL ASMAR, ALL OF LARSA DATE. SCALE, 4:5
a B.206.423a b B.206.423d c B.206.423e d B.206.423c



SHERDS OF INCISED GRAY WARE FROM TELL ASMAR, ALL OF LARSA
DATE EXCEPT *c* (GUTIUM-UR III?). SCALE, 4:5

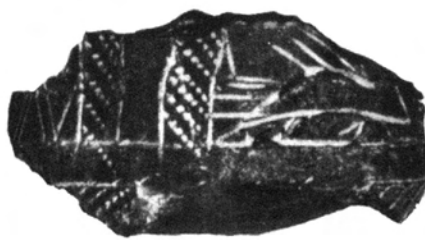

SHERDS OF INCISED GRAY WARE FROM TELL ASMAR, ALL OF LARSA DATE. SCALE, 4:5

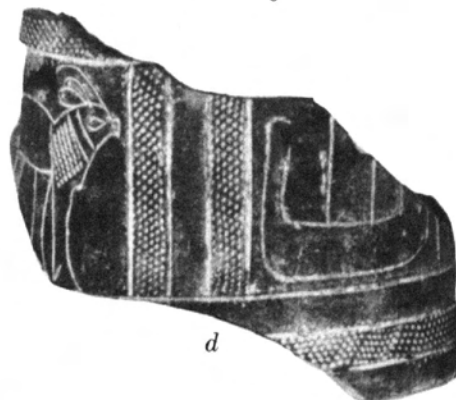
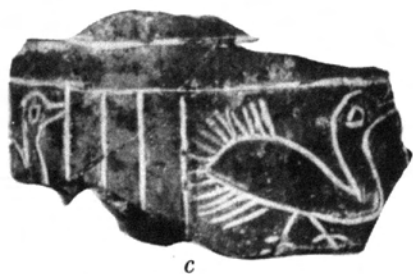
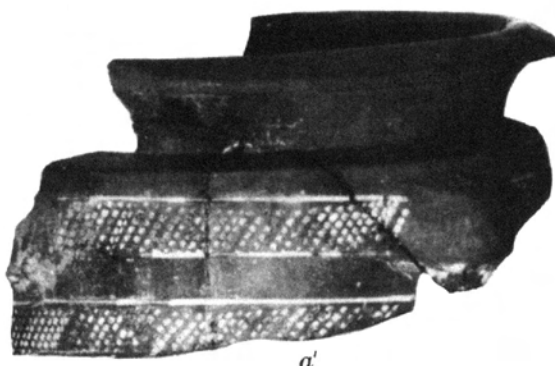
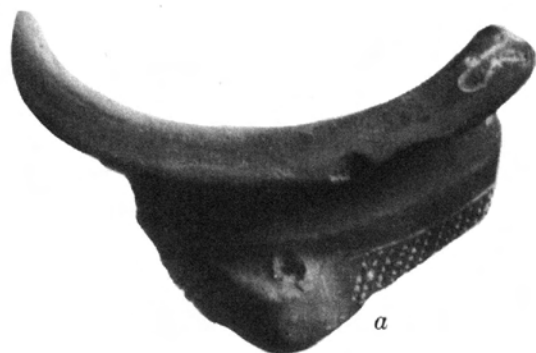

SHERDS OF INCISED GRAY WARE FROM TELL ASMAR, ALL OF LARSA DATE. SCALE, 4:5



UNUSUAL SHERDS OF VARIOUS PERIODS, MOSTLY LARSA, FROM KHAFAJAH (i) AND TELL ASMAR
SCALE, 4:5 (a, e, i) AND 2:5 (b-d, f-h)

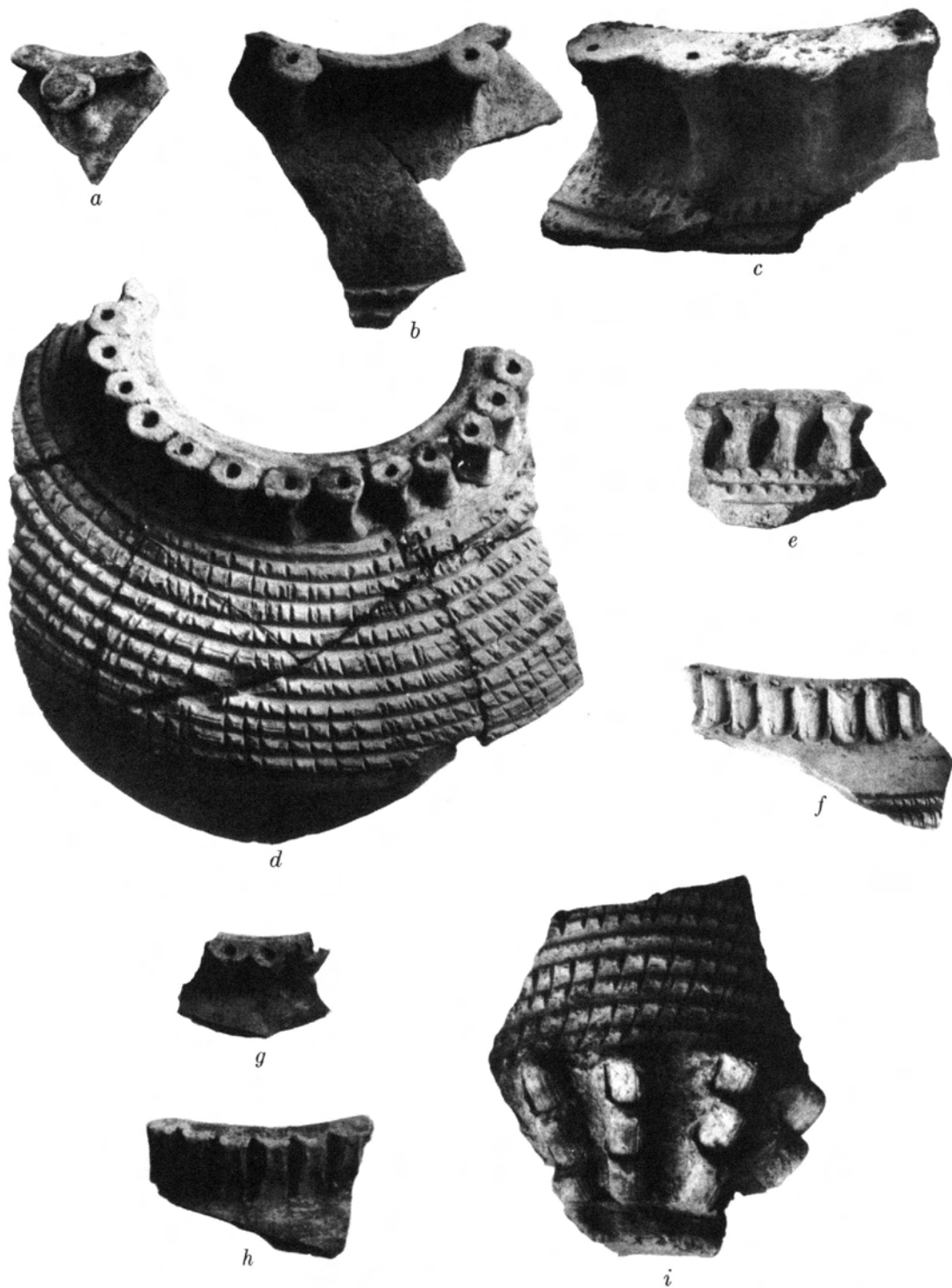

"COLUMN"-DECORATED FRAGMENTS FROM KHAFAJAH (*a*) AND TELL ASMAR, OF LARSA DATE EXCEPT *a* (ED III), *c* (PROTOIMP.), *h* (UNKNOWN), AND POSSIBLY *i*. SCALE, 2:5
i C.206.310



a



b

THE SNAKE JAR (E.544.310) BEFORE AND AFTER REMOVAL OF COVER (E.244.310)



a



b



c



d

THE SNAKE JAR WITH COVER STILL IN POSITION

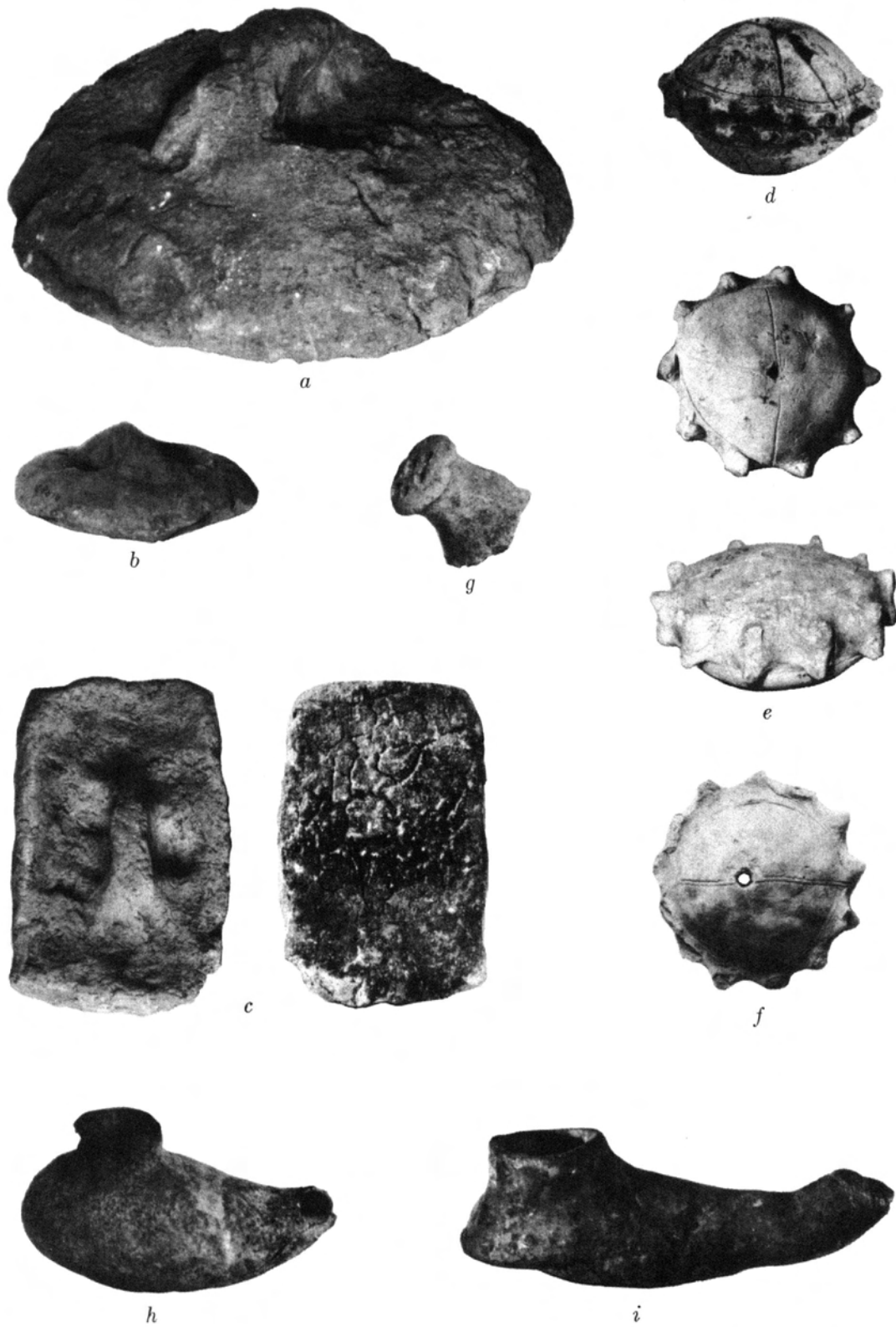

LIDS, A STRAINER SPOUT, AND TWO LAMPS FROM TELL ASMAR AND POSSIBLY KHAFAJAH (*i*), OF LARSA
DATE EXCEPT *b* (UNKNOWN) AND *i* (PURCHASED). SCALE, 2:5
d-f B.852 *h-i* B.812.542

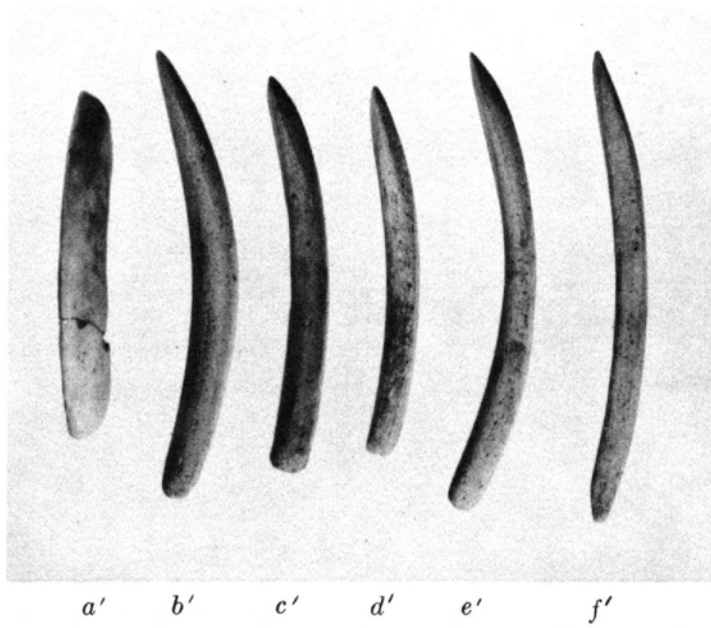
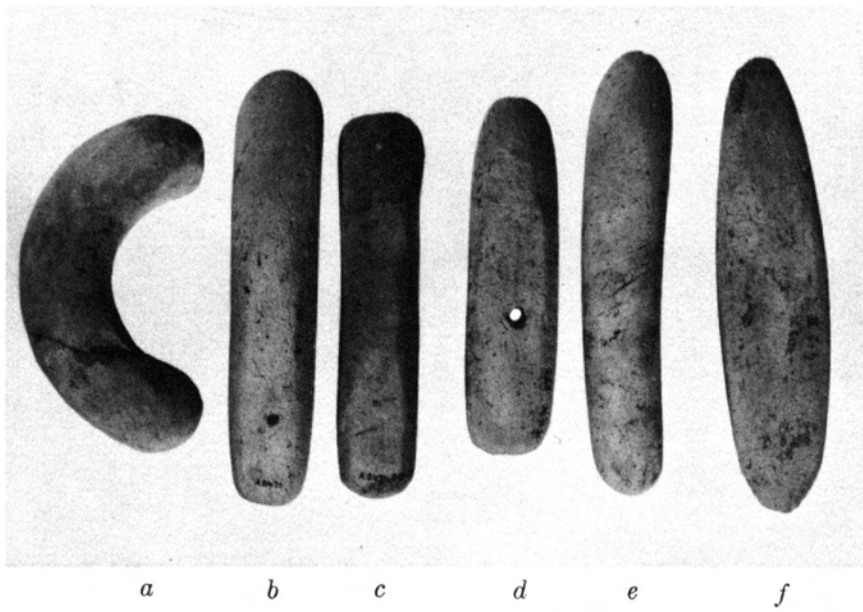

CLAY TOOLS OF THE LARSA PERIOD FROM TELL ASMAR, TOP (a-f)
AND PROFILE (a'-f') VIEWS. SCALE, 2:5



THIN-WALLED VESSELS OF THE OLD BABYLONIAN PERIOD FROM KHAFAJAH. SCALE, 2:5

a B.576.720a
b C.585.320

c B.576.720b

d B.656.720
e B.546.720

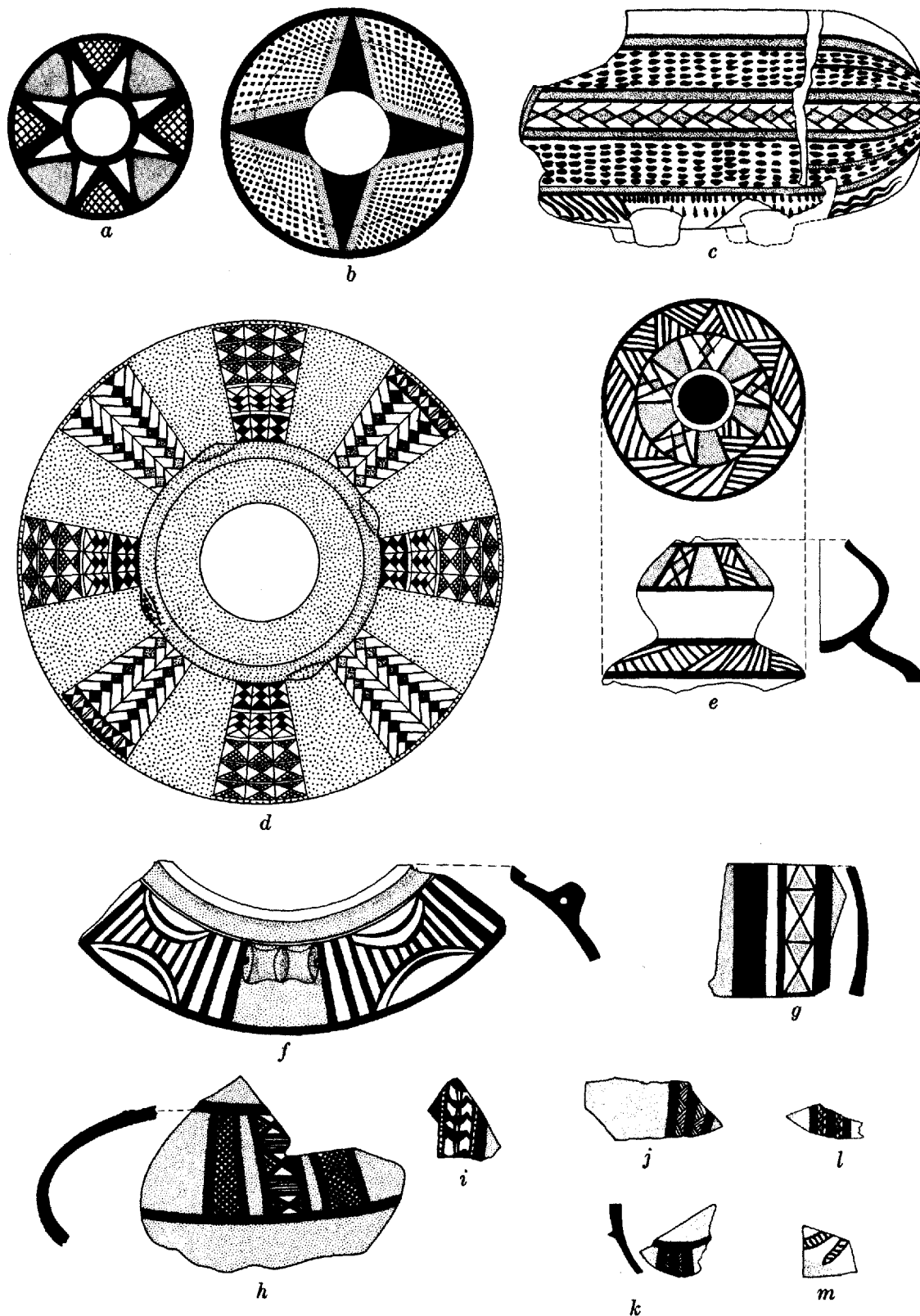

POLYCHROME POTTERY FROM KHAFAJAH, TELL AGRAB, AND TELL ASMAR, ALL PROTOLITERATE EXCEPT POSSIBLY *h-i*. SCALE, 1:5

a C.516.270

b B.653.240 (= Pl. 18 *d*)

c C.96

d D.515.370

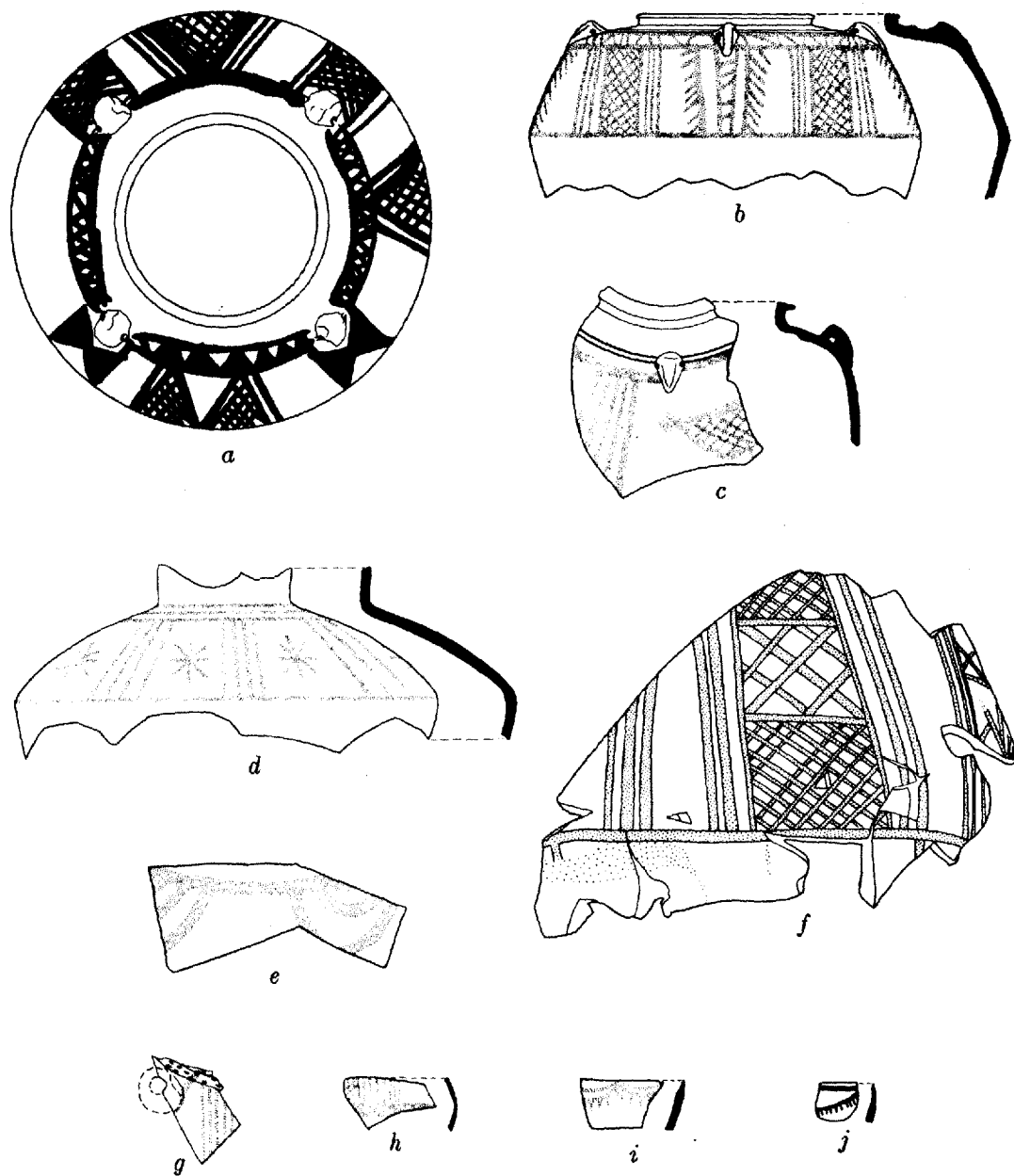

MONOCHROME-PAINTED POTTERY FROM PROTOLITERATE LEVELS AT KHAFAJAH (a-f) AND ED I LEVELS AT TELL ASMAR (g-j). SCALE, 2:5 (a) AND 1:5 (b-j)
 a C.603.253a b C.49--53



a

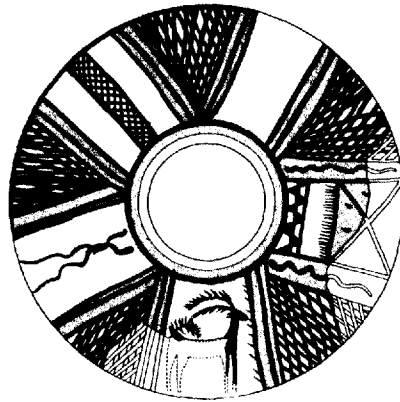

c

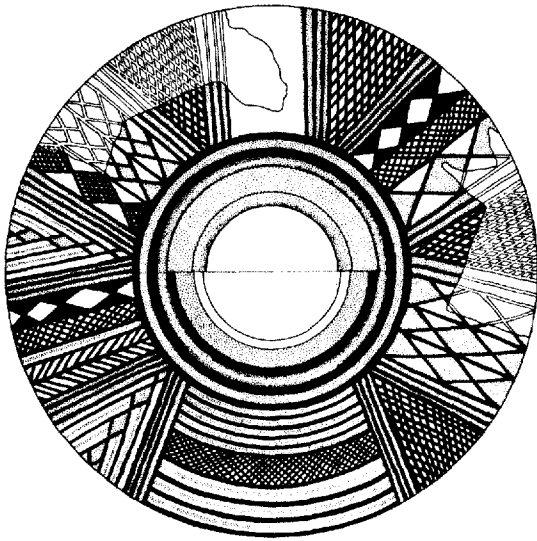

b



d

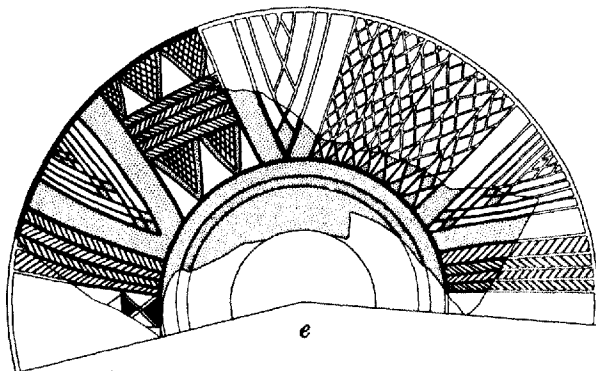

e

SHOULDER DESIGNS ON SCARLET-WARE VASES FROM TELL AGRAB. SCALE, 1:5
a C.525.370*b* *b* D.515.370

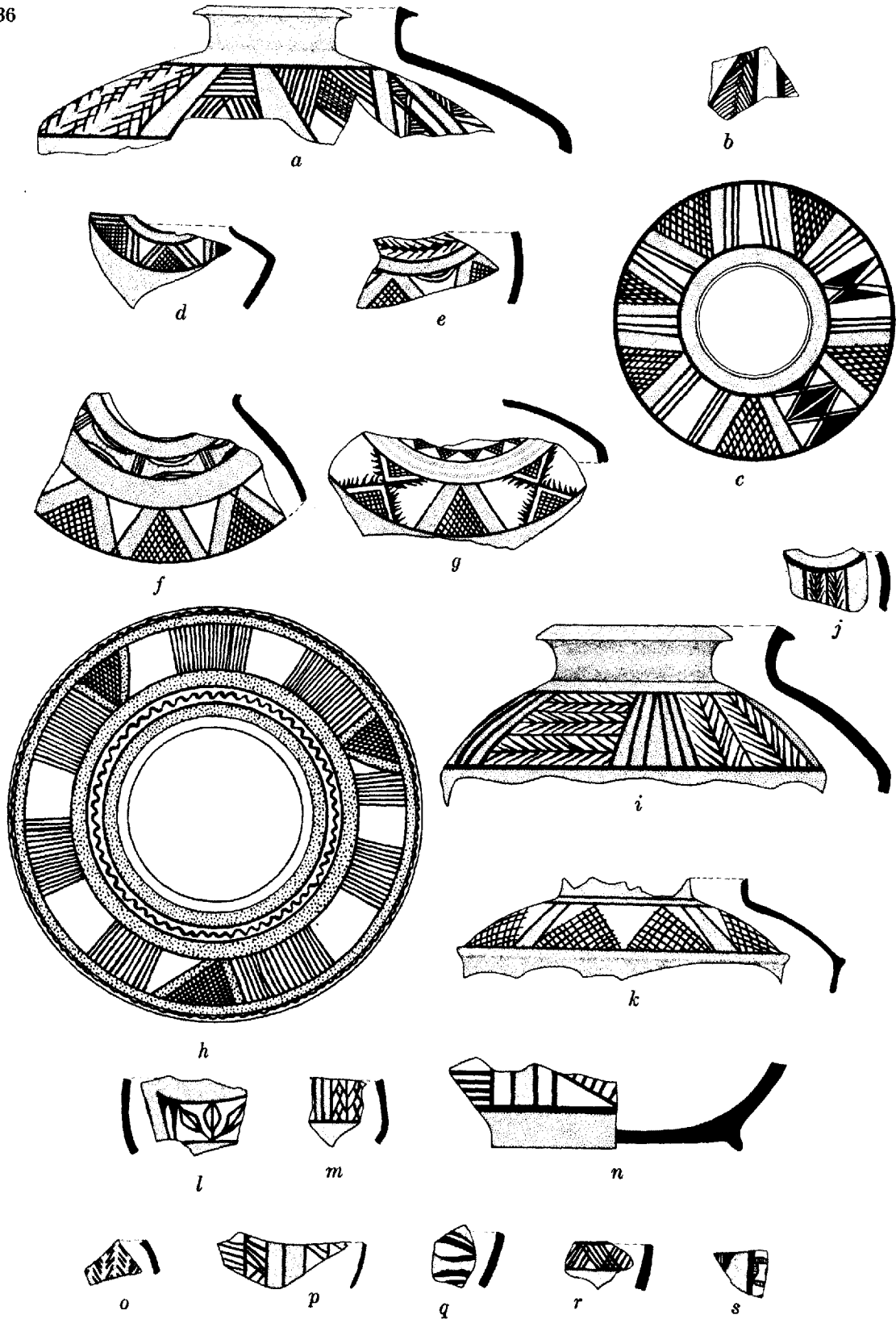

SCARLET WARE FROM KHAFAJAH AND TELL ASMAR. SCALE, 1:5 (a-g, i-s) AND 2:5 (h)
c C.516.370 h C.554.220

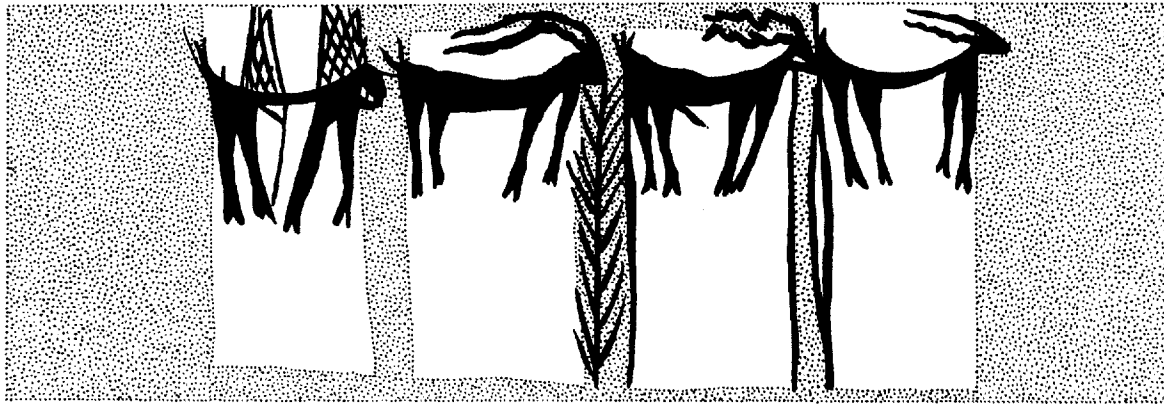

a

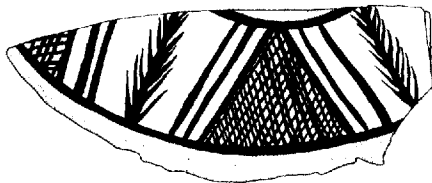

b

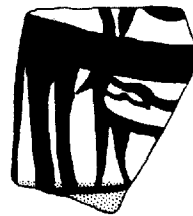

d

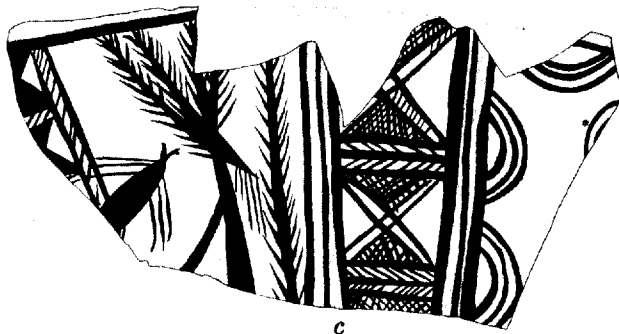

c

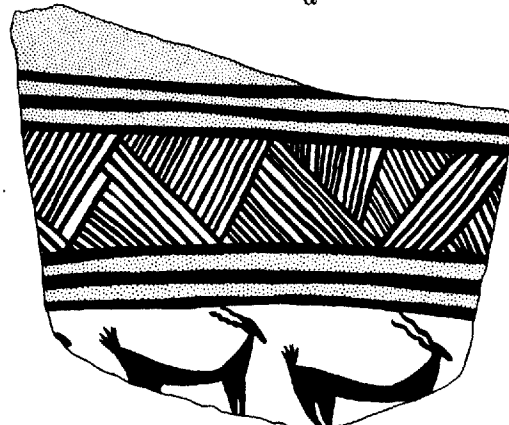

e

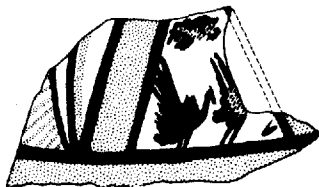

f



g



h

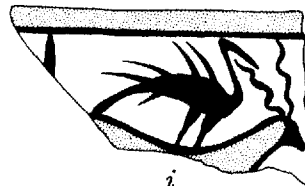

i

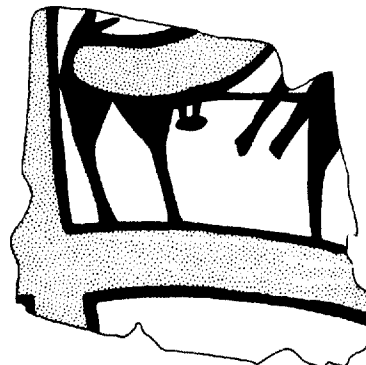

j

BODY DESIGN ON A SCARLET-WARE VASE (C.517.273) FROM TELL AGRAB, SCARLET-WARE SHERDS FROM TELL AGRAB AND KHAFAJAH. SCALE, 2:5 (*a, d-j*) AND 1:5 (*b-c*)

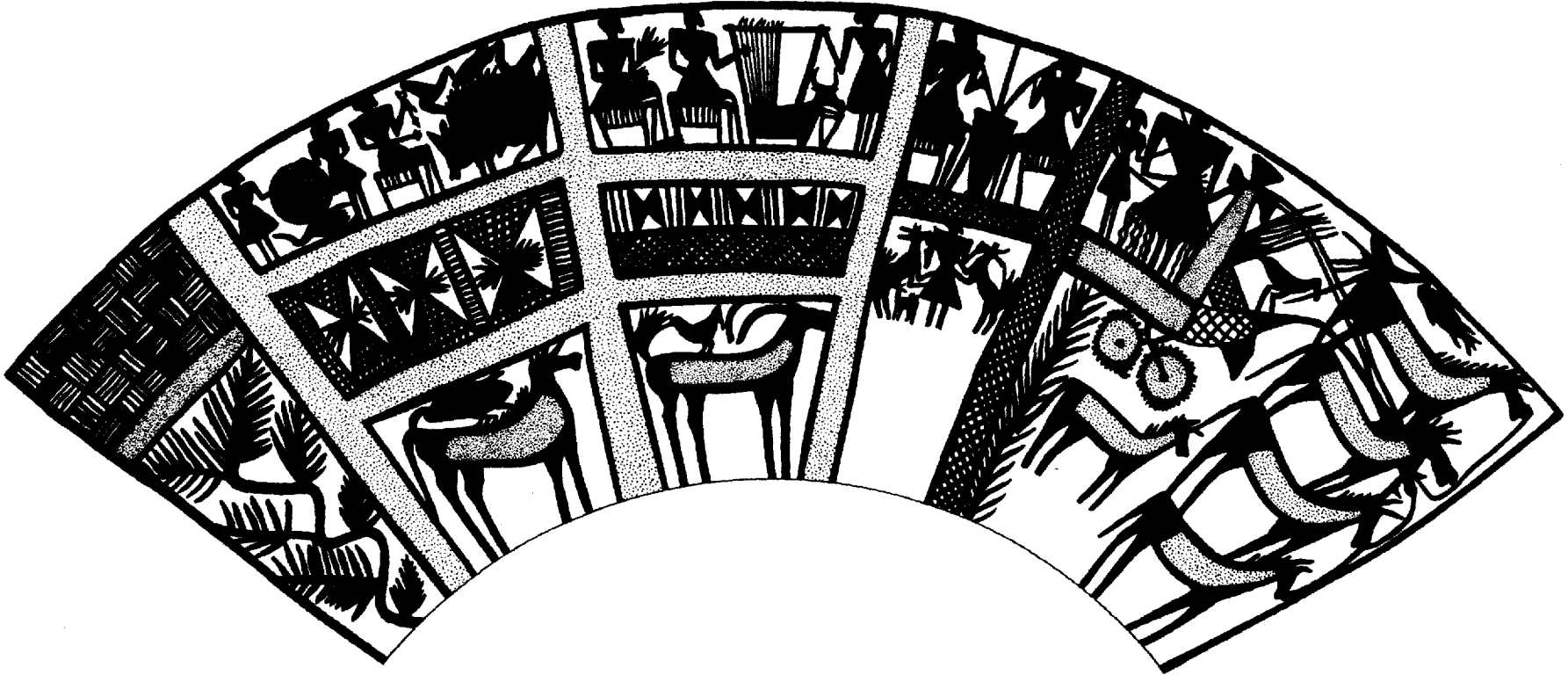

SUGGESTED RESTORATION OF BODY DESIGN ON A SCARLET-WARE VASE FROM KHAFAJAH
NOW IN THE BRITISH MUSEUM (Cf. PL. 62)

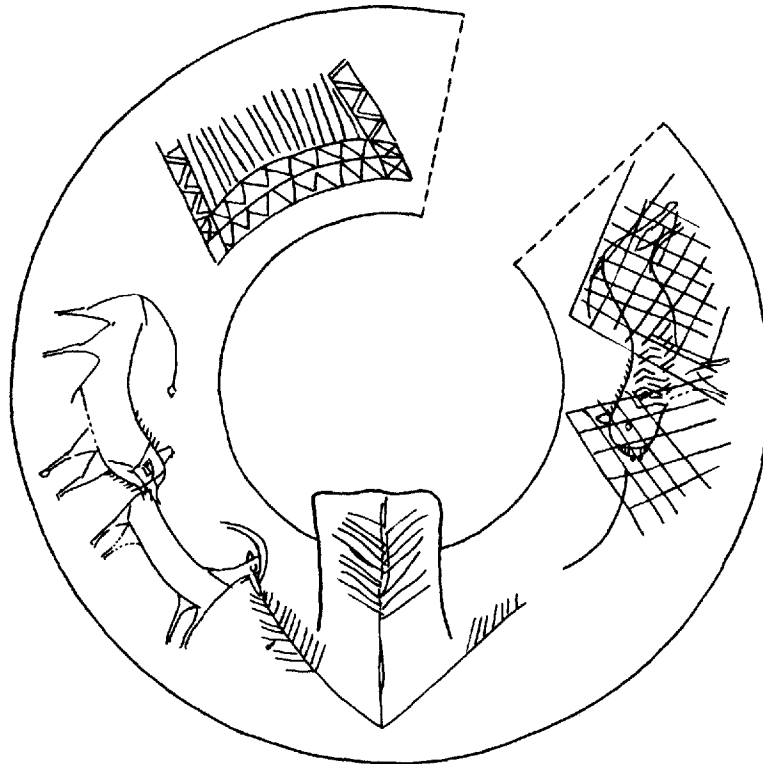

a

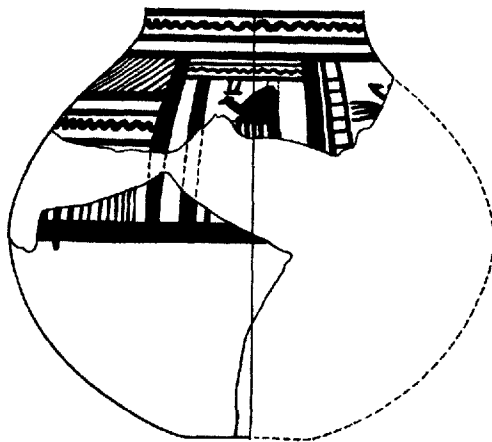

b

INCISED SHOULDER DESIGN ON AN ED III UPRIGHT-HANDLED JAR (D.526.371) FROM KHAFAJAH (*a*),
FRAGMENTS OF A UNIQUE PAINTED VESSEL (*b*) OF THE PROTOIMPERIAL PERIOD FROM
TELL ASMAR. SCALE, 1:5 (*a*) AND 2:5 (*b*)

A.001-A.224

Form	Photo on Plate	Site	Square, Locus, or Area	Grave	Building or Level	Date of Find-Spot	Remarks	Comparanda		
								Site	Reference	
A.001.300	103g	Kh.	R 44		Houses 3	ED III	Kh.I 61. See p. 100			
A.002.203		As.	M 31:15			E. Larsa	As.31:P.139x; C. See pp. 114-15			
A.002.500		Kh.	O 44:6		Houses 2	ED III	Kh.V 9			
A.002.600		As.	M 27:1			Larsa?	As.31:P.140c. See p. 114			
A.010.203		As.	D 17:2		Single-Shrine 1	ED III	As.33:21. See p. 98			
					N. Palace	Protoimp.	As.31:26. See p. 108			
A.014.101		Kh.	S 36		Houses 2 or 1?	ED III?	Kh.IX 45; P. See pp. 42 (n.59), 98			
A.014.700		Kh.	J 42:4		Houses 4	ED II	Kh.III 1314			
A.014.703		101h	Kh.		R 42:17	Sin X	ED III			Kh.IV 486; C. See pp. 98,143
A.021.201		As.	J 20:15		Houses Va	Protoimp.	As.32:846			
A.026.200	As.	K 19:3	Houses III	Gutium-Ur III	As.32:P.46. See p. 114					
A.032.503	As.	H 15	Surf.	Gutium-Ur III?	As.32:1021. Bowl (of ladle?) with perforated projection at rim for attachment					
A.035.600	101g	Kh.	P 44:10	155	Houses 2 or 1	ED III	Kh.III 823. See p. 100	Kish	"A," Pl. LIV 62	
A.041.503		Kh.	Mound A		Surf.	ED III?	Kh.III 230; C. See pp. 98,143			
A.043.210		Ish.	P 30:3		(Kititum IV)	L. Larsa or Old Bab.	Ish.P.2. See p. 115			
A.044.600		Kh.	Q 44:9		Houses 2	ED III	Kh.I 95b; B			
		As.	J 18:55*		Houses Va	Protoimp.	As.32:1013			
A.053.700		As.	J 20:40		Houses Vc	ED III	As.33:316			
A.055.100		As.	J 19:1		Houses III	Gutium-Ur III	As.32:P.20. See p. 114			
A.062.200		As.	D 15:3		29-28 m.	ED I	See p. 73 and Pl. 63:10			
A.111.210		As.	P 33?		Ibtqadad II	L. Larsa	As.31:P.141; C. See p. 115			
A.151.210		As.	J 19:35		Houses III	Gutium-Ur III	As.32:P.59. See p. 113			
A.173.200	Kh.	L 43:8			See A.573.200					
A.175.122	Kh.	Q 44:7?	Houses 2?	ED III?	Kh.III 804					
A.186.400	Kh.	P 44:15	Houses 2	ED III	Kh.III 952. See p. 100	Kish	"A," Pl. LII 39			
A.202.200	Kh.	M 42:1	Houses 3	ED III	Kh.III 372					
A.224.200	Kh.	K 43:3	Oval II	ED III	Kh.I 446; C. Handmade					

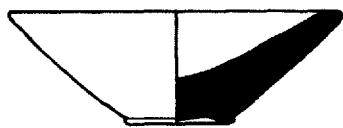

A.001.300

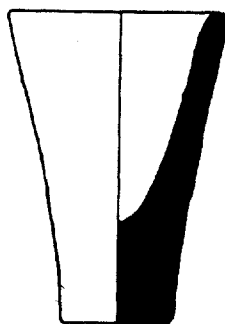

A.026.200

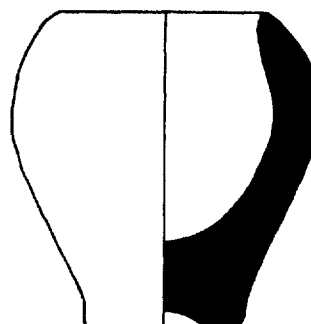

A.055.100



A.002.203

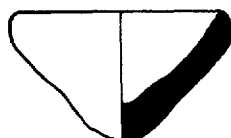

A.002.600

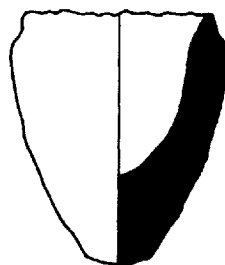

A.035.600



A.111.210

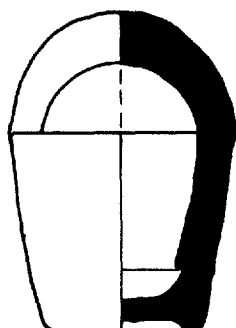

A.014.101



A.041.503

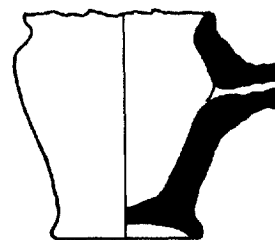

A.175.122

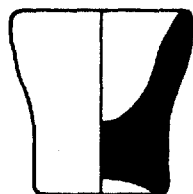

A.014.700

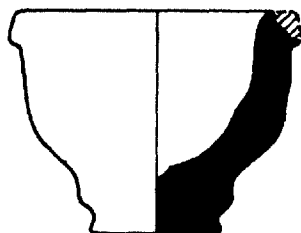

A.043.210



A.186.400

A. 235-A. 494

Form	Photo on Plate	Site	Square, Locus, or Area	Grave	Building or Level	Date of Find-Spot	Remarks	Comparanda	
								Site	Reference
A. 235.203		As.	Below D 17:18		33.50 m.	ED III?	As.34:58. See p. 98		
A. 237.823		As.	G 39			Agade?	As.35:22. See p. 112	Ur	RC, Types 240-41 (larger)
A. 243.900a	103f	Kh.	P 45:12		Houses 1	ED III	Kh.III 205; C. See p. 100	al-cUbaid	Type XCVII
A. 243.900b		Kh.	O 43:2		Houses 1	ED III	Kh.III 116; B. See p. 100		
A. 303.423		As.	G 19:5		Houses IVa	L. Agade	As.31:P.146; C. See pp. 112, 118		
A. 303.503		As.	E 14:2		N. Palace	Protoimp.	As.31:P.71; C. See p. 108; handmade		
A. 305.700		Kh.	O 42, robbers' hole			ED II or III	Kh.III 263		
A. 402.200		Kh.	Q 42:7		Sin IX	ED II or III	Kh.IV 177		
A. 415.273	101b	Kh.	L 43:9		Oval II	ED III	Kh.I 393. See pp. 100,143		
A. 424.353	101c	Kh.	K 43:5		Oval II	ED III	Kh.I 430. See pp. 100,143		
A. 444.250		As.	D 17:1		Surf.	Larsa?	As.32:480; C. See p. 117		
A. 446.830		Kh.	M 43:7		Oval II	ED III	Kh.III 1100; B. See p. 100		
A. 475.120		Kh.	Mound A		Surf.	ED III?	Kh.III 642. See p. 100	Kish	"A," Pl. LIII 12
A. 475.210		As.	E 15:1		N. Palace	Protoimp.	As.32:540		
A. 493.263	74j	Kh.	P 43:23	91	Houses 6	ED II	Kh.V 248; B. See pp. 83,98	Jamdat Nasr	Mackay, Pl. LXIV 9
	101i		K 42:2*		Houses 3	ED III	Kh.III 349. See p. 98		
A. 494.520		Kh.	P 44:10		Houses 2 or 1	ED III	Kh.III 824. See p. 100		

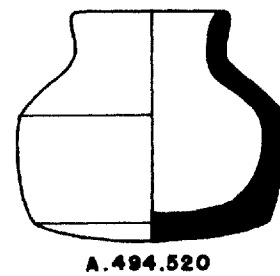
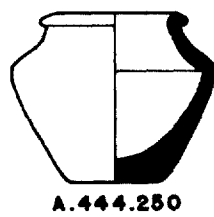
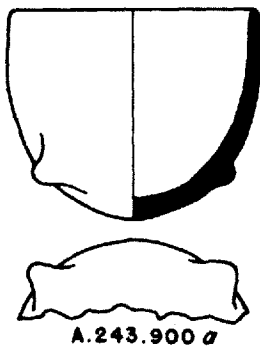
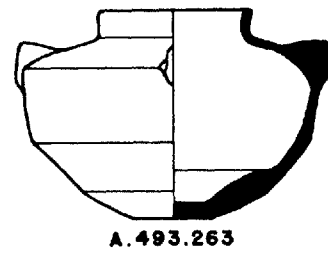
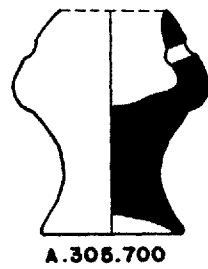
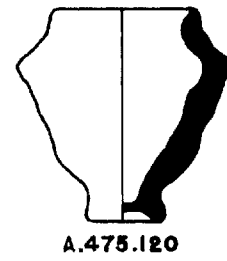
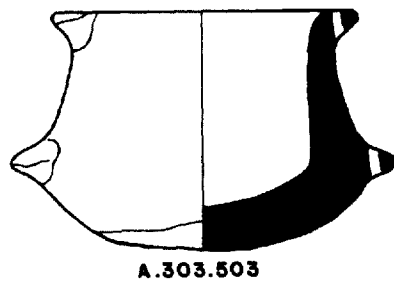
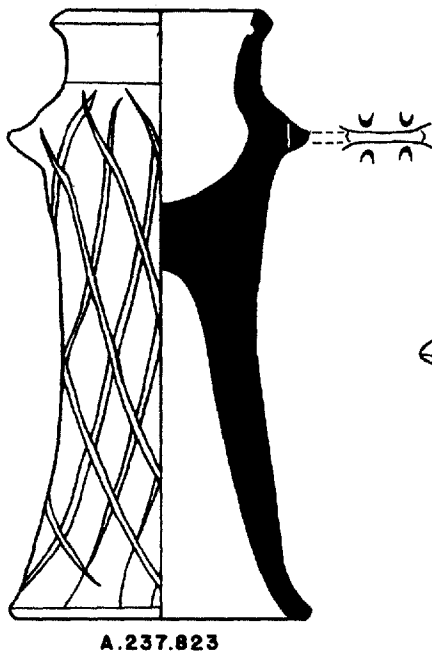
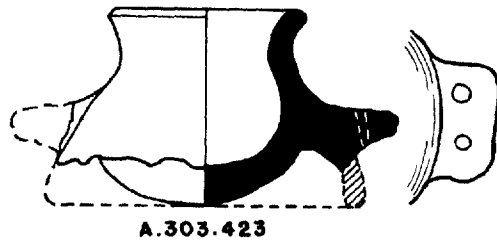
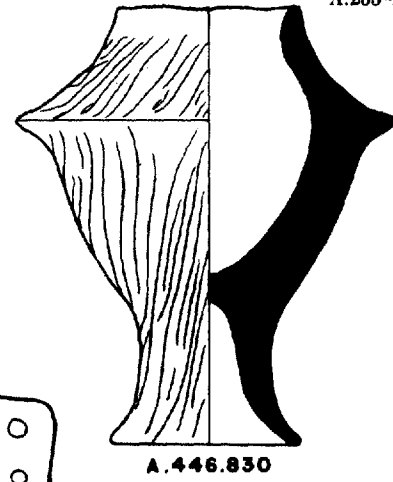
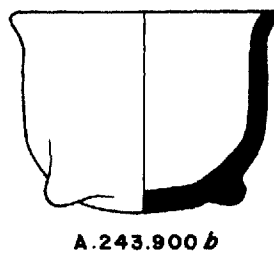
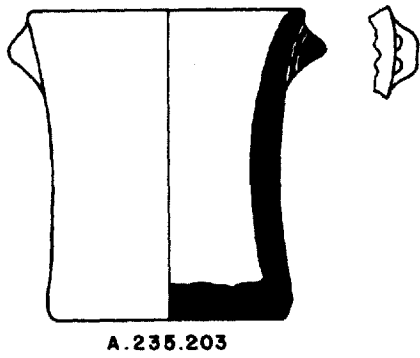

A.505-A.544

Form	Photo on Plate	Site	Square, Locus, or Area	Grave	Building or Level	Date of Find-Spot	Remarks	Comparanda	
								Site	Reference
A.505.450		Kh.	P 45:14		Houses 2	ED III	Kh.III 972. See p. 100		
A.506.860		As.	F 23:2			Agade?	As.31:P.147; C. See p. 112		
A.513.280	65:72	Ag.	Hill B		Top layer	ED I	Ag.36:562; B. See pp. 59,79		
A.514.280	23g	Kh.	P 42:50		(Sin III)	Protolit.c	Kh.VII 27; C. See p. 41		
A.514.270	98m	Kh.	O 43:5 N 44:7		Houses 2 Houses 3	ED III ED III	Kh.III 431; B See p. 95		
A.514.733	101a	Kh.	K 43:3		Oval II	ED III	Kh.I 454e; B. See pp. 98,143		
A.515.270	50c	As. Kh.	J 20:21 P 43:38		Houses Va Houses 9	Protoimp. ED I	As.33:17. See p. 108 Kh.V 298; C. See p. 59		
A.515.381		Kh.	K 43:3				See C.515.370a		
A.515.370		As.	E 17:6* E 17:9*		N. Palace Earlier N. Palace	Protoimp. ED III	As.32:P.40. See p. 108		
A.515.660		As.	G 19:3		Houses IVa	L. Agade	As.31:P.70; C. See p. 112		
A.516.151	101f	Kh.	L 43:8		Oval II	ED III	Kh.I 359. See pp. 87,98,143		
A.516.270		Kh.	P 42:15		Houses 7	ED I	See pp. 59,60		
A.516.320		Kh.	O 44:12		Houses 2	ED III	Kh.III 387. Handmade; incised zigzag on shoulder		
A.516.373	101d	Kh.	K 43:3		Oval II	ED III	Kh.I 454d; B. See pp. 98,143	Farah	Fara, Pl. 18a and Fig. 34 (much larger)
A.524.260		As.	D 17:1		Single-Shrine III	Protoimp.	As.32:804. See p. 108		
A.525.273	74i	Kh.	M 45:2		Oval I	ED II	Kh.II 250; C. See p. 83		
A.527.462	119d	As.	NE. of K 31:1		Bilalama	E. Larsa	As.30:P.21; C. See p. 117		
A.527.760	23b	Kh.	P 42:28		(Below Sin I)	Protolit.c	Kh.VII 77; C. See p. 41		
A.535.220		As.	J 20:25		Houses IVb	E. Agade	As.32:762		
A.544.212		As.	E 17		36.25 m.	Agade	As.32:421		

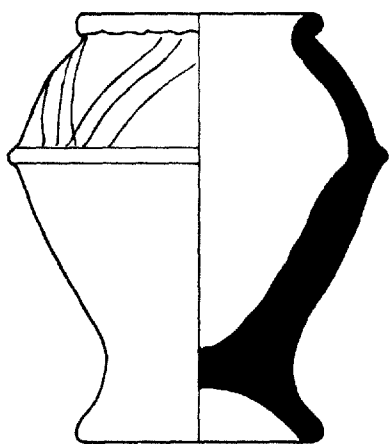

A.505.450

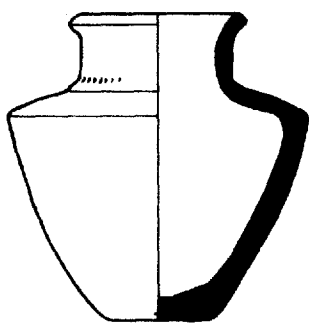

A.515.270

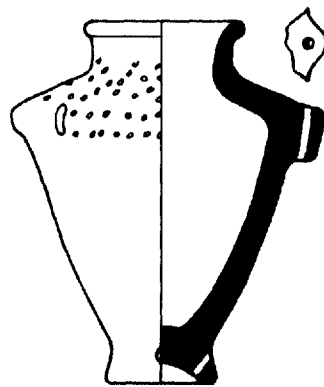

A.516.373

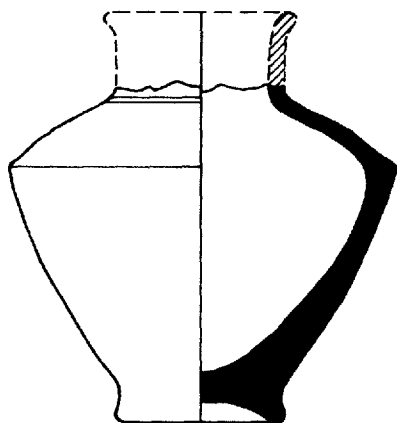

A.515.370

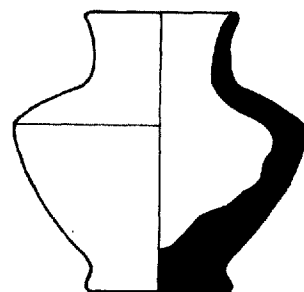

A.524.260

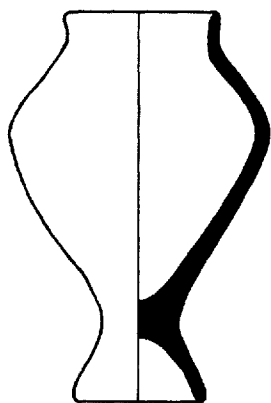

A.506.860

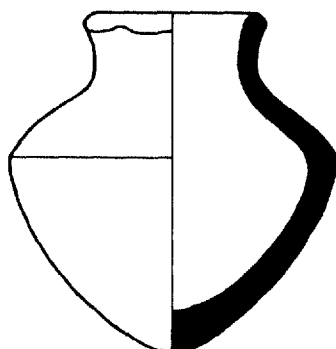

A.515.660

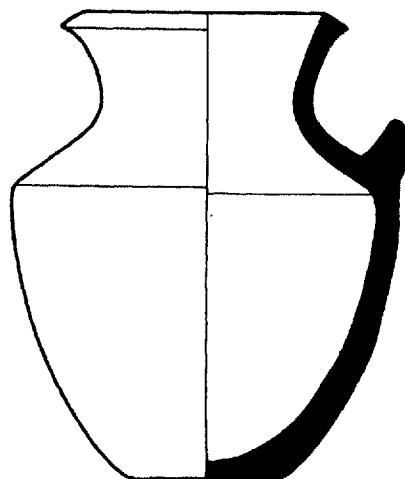

A.525.273

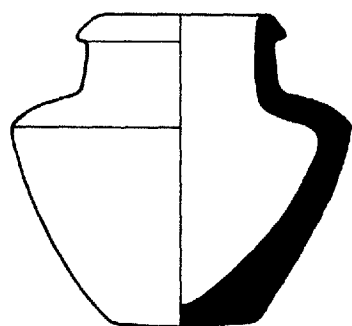

A.514.270

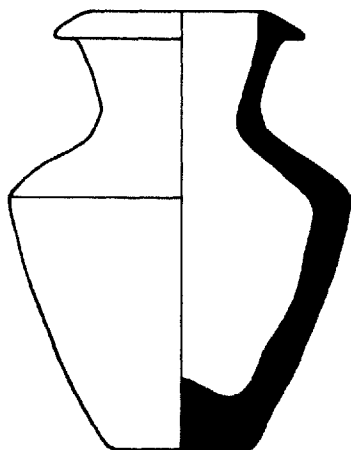

A.516.270

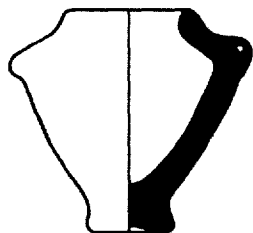

A.514.733

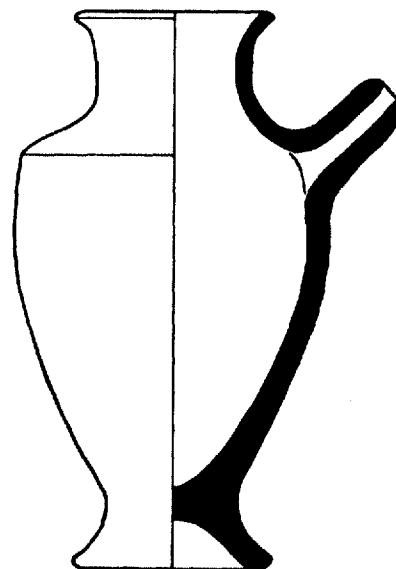

A.527.462

A.544-A.588

Form	Photo on Plate	Site	Square, Locus, or Area	Grave	Building or Level	Date or Find-Spot	Remarks	Comparanda	
								Site	Reference
A.544.520		As.	H 18:4 J 20:12		Houses IVa? Houses IVa	L. Agade? L. Agade	As.31:P.148; C. See p. 112		
A.545.320		As. Ish.	N. of K 31:1 V 32:11		Bilalama Houses	E. Larsa L. Larsa or Old Bab.	As.30:P.56. See p. 117 Ish.P.75		
A.545.380		As.	J 19:10		Houses II	Gutium-Ur III	As.32:P.8. See p. 114		
A.545.522		Kh.	Q 45:1		Houses 1	ED III	Kh.III 68. Rough, handmade; 2 holes, 1 plugged with bitumen		
A.545.540	103a	Kh.	O 44:15		Houses 2	ED III	Kh.I 269; C. See p. 100		
A.545.620		Kh.	P 45:14		Houses 2	ED III	Kh.III 976. See p. 100		
A.546.630		Kh.	S 36		Houses 2 or 1?	ED III?	Kh.IX 46; P. See p. 100	Kish Telloh	"A," Pl. LIV 63 G I, Pl. 57:1g
A.555.320		As.	F 17:10		N. Palace	Protoimp.	As.32:P.45. See p. 108		
A.556.320		Kh.	P 45:14		Houses 2	ED III	Kh.III 977. See p. 100		
A.556.423		Ish.	R 29:1 R 30:6 T 30:2?		Kititum IV Kititum I or II Kititum I or II	L. Larsa or Old Bab. Larsa Larsa	Ish.P.1. See pp. 117,121	Kish Telloh	Gen. II, Pl. 57:6 G I, Pl. 60:5=Pl. XIII 4024 (solid base)
A.556.500		As.	D 16:9		Outside N. Palace	Protoimp.?	As.32:442		
A.556.520		As.	J 19, NW. corner		Houses Va	Protoimp.	As.32:1377		
A.556.840		Kh.	L 42:5		Houses 3	ED III	Kh.III 1101; C. See p. 100		
A.557.320		Kh.	P 45		Houses 1	ED III	Kh.III 347. Cf. A.556.320; see p. 100		
A.565.610		As.	K 20:17		Houses Va	Protoimp.	As.32:775. See p. 108		
A.573.200		Kh.	L 43:8		Oval II	ED III	Kh.I 341. See p. 95; published in OIP LIII as A.173,200		
A.576.822		As.	E 15:20		Earlier N. Palace	ED III	As.32:1158		
A.586.462	119b	As.	N 34?		Ibīqādad II	L. Larsa	As.30:P.51; C. See p. 117		

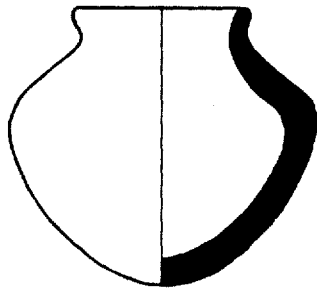

A.544.520

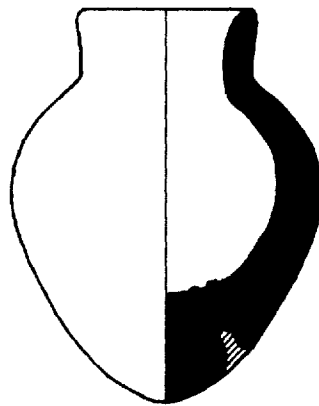

A.545.620

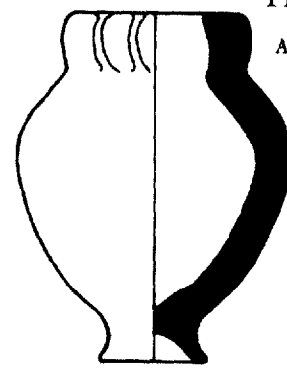

A.556.423

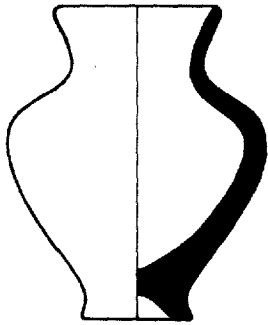

A.545.320

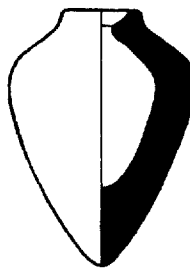

A.546.630

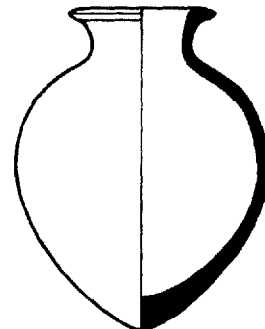

A.556.640

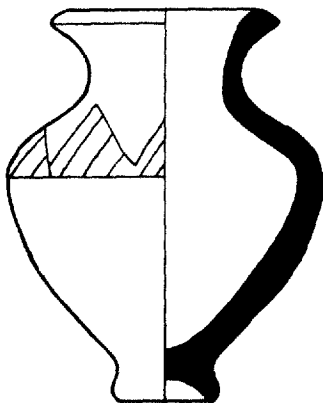

A.545.360

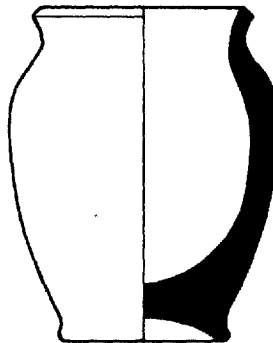

A.555.320

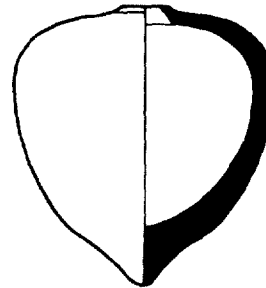

A.565.610

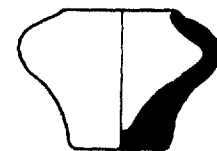

A.573.200

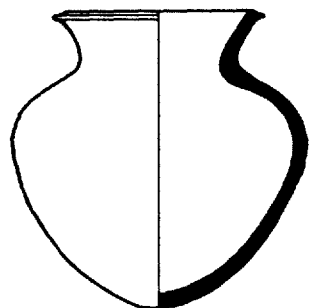

A.545.540

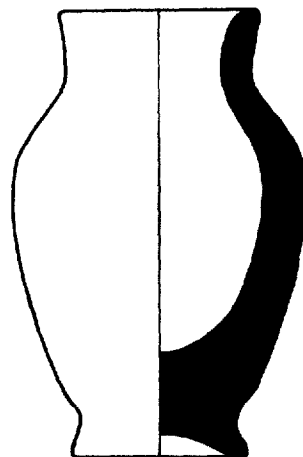

A.556.320

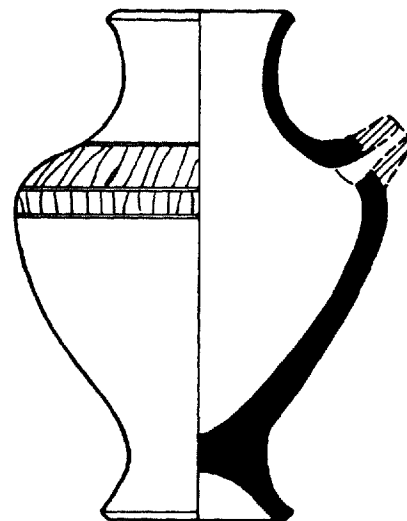

A.586.462

A.604-A.655

Form	Photo on Plate	Site	Square, Locus, or Area	Grave	Building or Level	Date of Find-Spot	Remarks	Comparanda	
								Site	Reference
A.604.223	22b	Kh.	O 43:40		(Sin II)	Protolit.c	Kh.VII 12; C. See p. 39	Jamdat Nasr Telloh Mostagedda	Mackay, Pl. LXIV 11 G I, Pl. III 5539 Pl. XXXV 24
A.604.270		Kh.	O 41:1		Houses 3 or 2	ED III	Kh.III 292. See p. 95		
A.604.520		As.	S. of O 33:6		Ibiqadad II	L. Larsa	As.31:P.17; C. See p. 117		
A.604.560		As.	E 15:2		N. Palace	Protoimp.	As.32:1129. See p. 108		
A.624.520		As.	J 20:12		Houses IVa	L. Agade	As.32:1334		
A.624.563		As.	H 17 H 18:7		Houses IVa or III	Agade? L. Agade or Gutium-Ur III	As.31:P.140a; C. See p. 112 As.31:P.140b; C.		
A.625.5--		Kh.	P 45:14		Houses 2	ED III	Kh.III 511. Rough, handmade; hole near base		
A.633.263	22a	Kh.	Q 42		(Sin I)	Protolit.c	Kh.VIII 219; P. See p. 40	Jamdat Nasr	Mackay, Pl. LXIV 8
A.644.520		As.	J 20:12		Houses III	Gutium-Ur III	As.32:751. Handmade		
A.645.510		Kh.	J 42:4		Houses 4	ED II	Kh.III 1319. Handmade		
A.645.720		Kh.	P 45:14		Houses 2	ED III	Kh.III 973. See p. 100		
		As.	E 16:40		Square Temple	ED II	As.33:549		
A.652.500	97n	Kh.	S 44:2		Houses 1 or above	ED III?	Kh.VIII 95; P. See p. 95	Kish Telloh	"A," Pl. LIV 48 G I, Pl. 58:2c, e
			S 44:2		Houses 1 or above	ED III?	Kh.VIII 94; B		
A.653.540		As.	G 18:1		Houses IVa	L. Agade	As.31:P.43; C. See pp. 112,114, 117		
			E 16:8		Houses above N. Palace	Larsa?			
			F 17:1		Houses above N. Palace	Larsa?			
			G 19, SW. corner		Houses IVa?	L. Agade?	2 specimens		
			G 19:6		Houses IV	Agade	4 or 5 specimens		
			H 18:7		Houses IVa or III	L. Agade or Gutium-Ur III			
			H 18:10		Houses III	Gutium-Ur III			
			K 31:1*		Bilalama	E. Larsa	Neck missing		
			N 30:1*			E. Larsa	2 specimens; necks missing		
A.654.520		Kh.	P 43:13		Houses 1	ED III	Kh.III 233. See p. 100		
			P 45:4*		Houses 1	ED III	Kh.III 102		
A.654.523		As.	D 17:1		Single-Shrine I	ED III	As.32:927. Handmade; perfo- rated lug at rim; cf. B.654,523		
A.654.543	101e	Kh.	P 45:7		Houses 1	ED III	Kh.III 122; C. See pp. 98,143		
A.654.720		Kh.	N 43:11		Houses 2	ED III	Kh.III 1204. See p. 100		
A.654.920		As.	K 21:10		Houses Va	Protoimp.	As.32:791. See pp. 99,108		
A.655.120		Ish.	R 30:6		Kititum I or II	Larsa	Ish.P.61. See p. 117		
A.655.220		Kh.	O 45:2		Oval II	ED III	Kh.I 313		

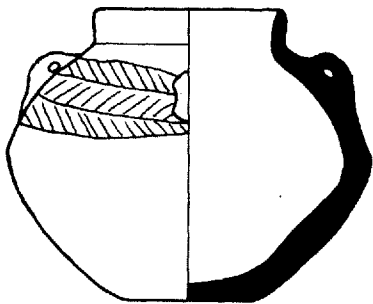

A.604.223

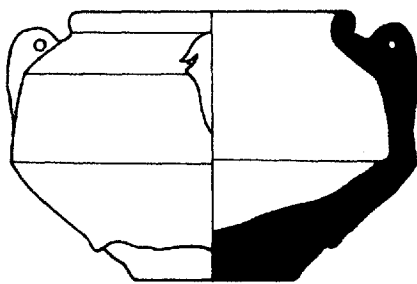

A.633.263

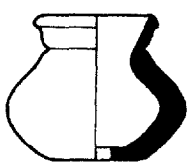
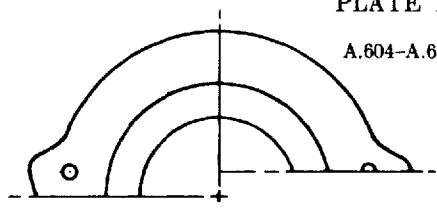

A.604.270

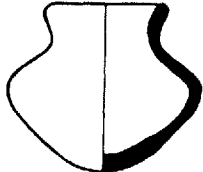

A.604.520

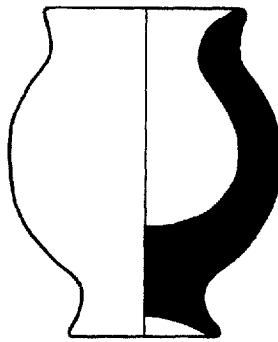

A.645.720

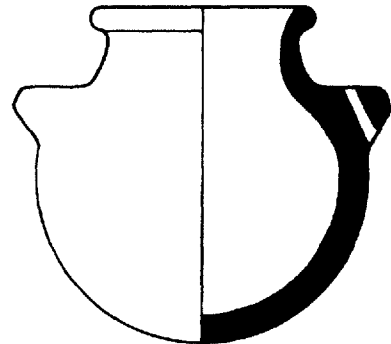

A.654.543

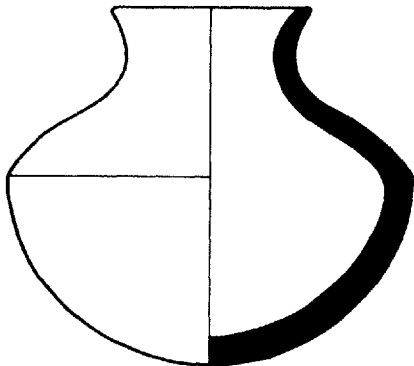

A.604.560

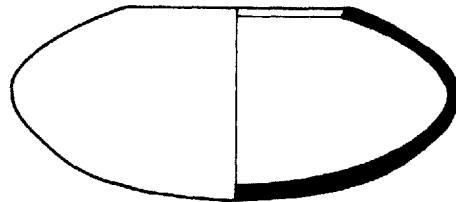

A.652.500

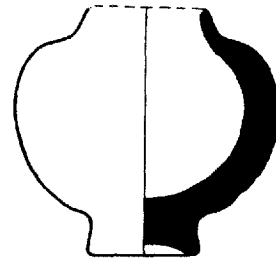

A.654.720

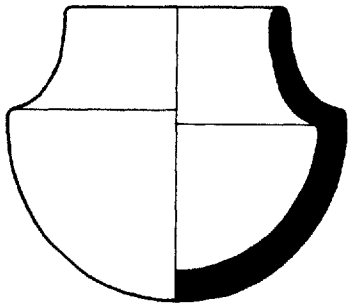

A.624.520

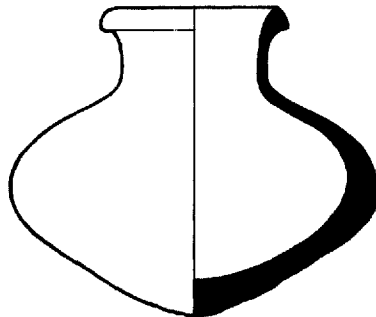

A.653.540

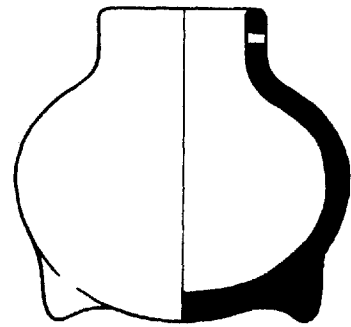

A.654.920

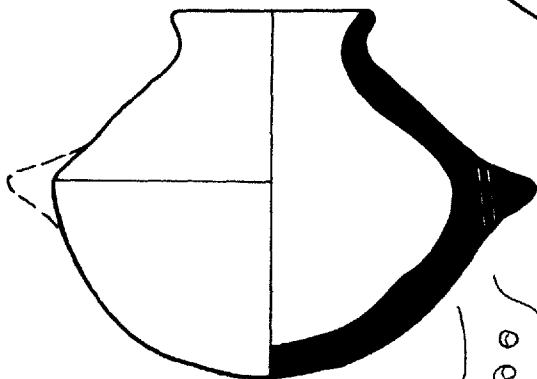

A.624.563

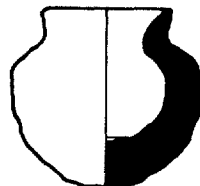

A.654.520

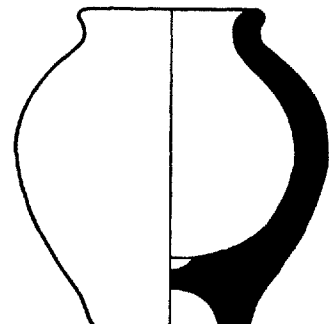

A.655.120

A.655-A.96

Form	Photo on Plate	Site	Square, Locus, or Area	Grave	Building or Level	Date of Find-Spot	Remarks	Comparanda	
								Site	Reference
A.655.520a	103e	Kh.	P 44:14 P 45:14*		Houses 1 Houses 2	ED III ED III	Kh.I 193. See p. 100 Kh.III 996	Telloh	G I, Pl. 58:1a
		As.	H 19:37		Houses Va	Protoimp.	As.32:1314. See p. 108		
A.655.520b		As.	F 17:1		Houses above N. Palace	Larsa?	As.31:P.145; B. See p. 117		
		Kh.	P 45:14		Houses 2	ED III	Kh.III 987. See p. 100; perforation near bottom		
A.658.700		As.	L 30:1			Larsa	As.31:P.138; C. See p. 117		
A.656.720		Kh.	O 44:5		Houses 2	ED III	Kh.III 58. See pp. 99-100		
A.663.520		Ish.	Q 30:4		Kititum I or II	Larsa	Ish.P.9. See p. 117		
A.666.422	119c	As.	L 28:2			Larsa	As.31:P.77; C. See p. 117		
A.704.220		As.	D 17:15		Archaic Shrine III	ED I	As.34:122. See pp. 59-60		
A.706.520		Ish.	V 31:6		Houses	L. Larsa or Old Bab.	Ish.P.62		
A.753.200		As.	D 15:3		27-26 m.	ED I	See p. 74 and Pl. 63:37		
A.754.500		Kh.	P 42:2, robbers' hole			ED III	Kh.III 553. Handmade		
A.756.520		As.	H 20:17		Houses Va	Protoimp.	As.32:1035. See p. 108	Ur	RC, Type 221 (unpierced)
A.758.540		As.	Unknown		Surf.	Larsa?	As.30:P.17; C. See p. 117		
A.765.500		Kh.	P 45		Houses 1	ED III	Kh.I 229		
A.785.520		As.	E 17:6		N. Palace	Protoimp.	As.32:P.41. See p. 108		
A.802.500		As.	D 15:3		27-26 m.	Protolit. or ED I	See p. 74 and Pl. 63:47		
A.831.203		As.	J 20:12		Houses IVa	L. Agade	As.32:1020. See pp. 98,112		
A.96	94i	Kh.	O 41:1		Houses 3 or 2	ED III	Kh.III 373; B. Cf. C.96 and see p. 94	Nuzi	Pl. 103 E

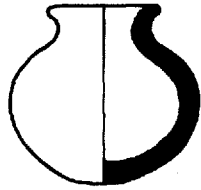

A.655.520 *a*

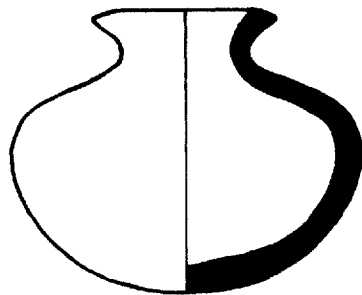

A.663.520

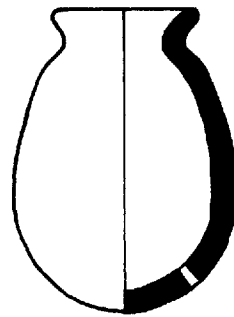

A.756.520

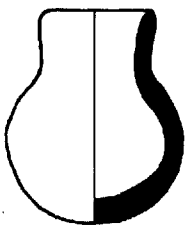

A.655.520 *b*

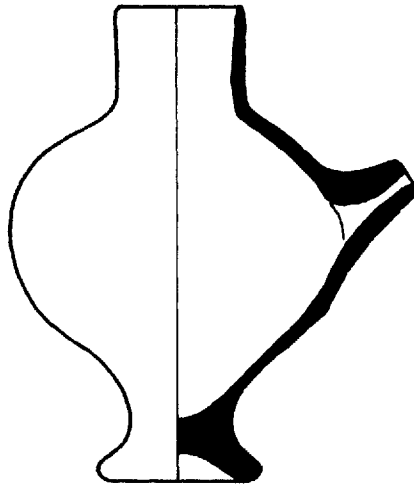

A.666.422

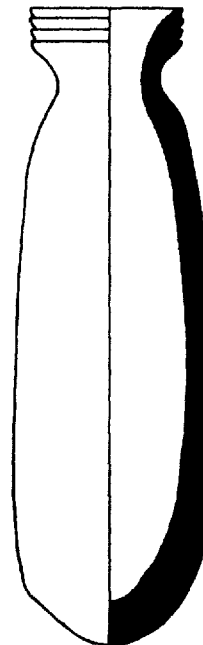

A.758.540

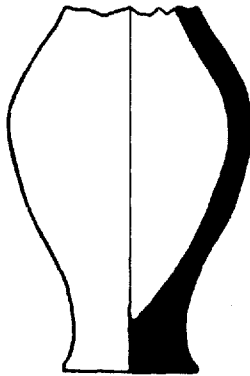

A.656.700

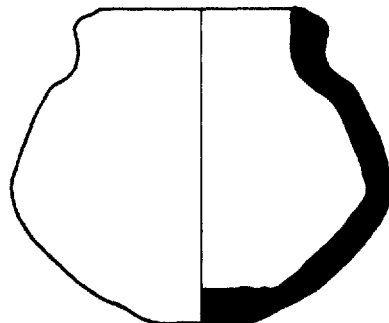

A.704.220

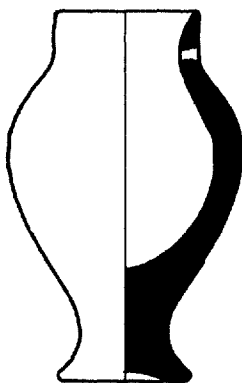

A.656.720

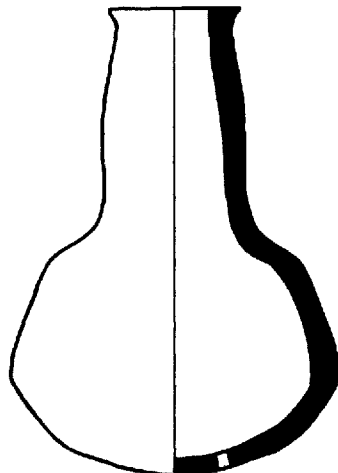

A.706.520

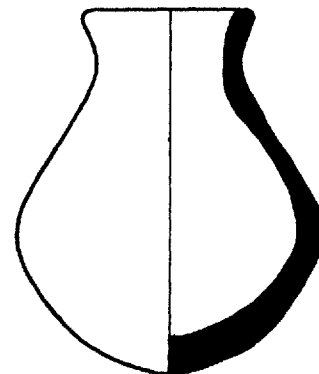

A.785.520

B.001-B.002

Form	Photo on Plate	Site	Square, Locus, or Area	Grave	Building or Level	Date of Find-Spot	Remarks	Comparanda	
								Site	Reference
B.001.200a	110c	As.	W. of E 16:19		N. Palace	Protoimp.	As.32:P.52. See p. 105	Warka	UVB IV, Pl. 20 B i"
			W. of E 16:19		N. Palace	Protoimp.			
	74a	Ish.	N. part R 30:6		Kititum IV	L. Larsa or Old Bab.	As.31:P.42d; C Ish.P.37		
		Kh.	Q 45:12		Nintu VI	ED II	Kh.VIII 42. See p. 82		
B.001.200b		As.	Q 45:12		Nintu VI	ED II	Kh.VIII 43		
			N 33		Ibiqadad II	L. Larsa	As.31:P.134a; C. See pp. 109, 115	Nuzi	Pl. 95 P
			J 19:6		Houses IVa-1	Agade or later	As.31:P.134c; C		
			P 30:3			E. Larsa	As.31:P.134b; C		
B.001.310		As.	E 14:1		N. Palace	Protoimp.	As.31:P.30; C. See pp. 102,106		
B.002.200a	96a	Kh.	R 45		Houses 1	ED III	Kh.I 23. See pp. 58-59,82, 94-95,105,109,113,142	Kish	"A," Pls. XVI 34-36 and LIV 17-18
			E 29:1	162	Houses 1 or above	Protoimp.?	3 specimens	Jamdat Nasr	LXVII 7
			E 29:2	161	Houses 1 or above	Protoimp.?	4 specimens	Warka	UVB IV, Pl. 20 A w and B m'
			J 42:6		Houses 4	ED II	Kh.III 1108		
			J 43:5		Houses 4	ED II	Kh.III 1368		
			K 42:3		Houses 4	ED II	4 specimens		
			K 42:4		Houses 3	ED III	Kh.III 1343 and 3 other specimens		
			K 42:5	168	Above Houses 2	ED III	Kh.III 612-13		
			K 42:8		Houses 4	ED II	3 specimens		
			K 42:13		Houses 3	ED III	4 specimens		
			K 42:13	122	Houses 3	ED III	9 specimens		
			K 42:13	123	Houses 3	ED III	10 specimens		
			K 42:13	124	Houses 3	ED III	3 specimens		
			K 42:17	130	Houses 3	ED III	Kh.III 1278-79		
			K 43:1		Oval III	ED III or Protoimp.	2 specimens		
			K 43:7		Houses 3	ED III	Kh.III 1301		
			K 43:8		Houses 4	ED II			
			K 43:10		Houses 4	ED II	5 specimens		
			K 43:11		Houses 4	ED II			
			L 42:3		Houses 3	ED III	4 specimens		
			L 42:5		Houses 3	ED III	3 specimens		
			L 42:6		Houses 3	ED III	3 specimens		
			L 42:8		Houses 3	ED III	Kh.III 1203 and 1 other specimen		
			M 42:1		Houses 3	ED III	Kh.III 489 and 1 other specimen		
			M 42:2		Houses 2	ED III			
			M 42:3		Houses 3	ED III			
			M 42:4		Houses 3	ED III	2 specimens		
			N 43:7		Houses 2	ED III	Kh.III 1173		
			N 43:9		Houses 2	ED III			
			N 43:11		Oval I	ED II	4 specimens		
			N 43:12	111	Houses 4	ED II	7 specimens		
			N 43:12	116	Houses 4	ED II	8 specimens		
			N 43:15	113	Houses 4	ED II	34 specimens		
			N 43:20	99	Houses 5	ED II	10 specimens		
			N 43:21	98	Houses 5	ED II	5 specimens		
			N 44:5	119	Houses 4	ED II	6 specimens		
			N 44:6	94	Houses 6	ED II	32 specimens		
			N 44:6	103	Houses 5	ED II	3 specimens		
			N 44:6	110	Houses 4	ED II	18 specimens		
			N 44:7	131	Houses 3	ED III	9 specimens		
			N 44:11	101	Houses 5	ED II	5 specimens		
			N 44:14	92	Houses 6	ED II	36 specimens		
			O 42:8	79	Houses 8	ED I	12 specimens		
			O 43:1		Houses 1	ED III	Kh.III 113-14		
			O 43:2		Houses 1	ED III			
			O 43:3	112	Houses 4	ED II			
			O 43:3	133	Houses 3	ED III	34 specimens		
			O 43:5		Houses 2	ED III	Kh.III 435-36		
			O 43:6	137	Houses 3	ED III	18 specimens		
			O 43:14	109	Houses 4	ED II	3 specimens		
			O 44:10		Houses 1	ED III			
			O 44:11		Houses 2 or 1	ED III			
			O 44:14		Houses 2 or 1	ED III	Kh.III 877		
			O 45:3		Houses 2	ED III	Kh.III 40		
			O 46, outside Oval		Houses 2	ED III			
			O 46, outside Oval		Houses 2	ED III	Kh.III 1097		
			O 47:1		Oval II	ED III			
			P 42:9	97	Houses 5	ED II	7 specimens		
			P 42:20	61	Houses 10	ED I	3 specimens		
			P 43:3		Houses 1	ED III			

B.002-B.003

Form	Photo on Plate	Site	Square, Locus, or Area	Grave	Building or Level	Date of Find-Spot	Remarks	Comparanda	
								Site	Reference
B.002.200a		Kh.	P 43:6		Houses 1	ED III			
			P 43:7		Houses 2 or 1	ED III			
			P 43:11		Houses 1	ED III	4 specimens		
			P 43:20	93	Houses 6	ED II			
			P 43:23	89	Houses 6	ED II	29 specimens		
			P 43:23	90	Houses 6	ED II	8 specimens		
			P 43:23	91	Houses 6	ED II	3 specimens		
			P 43:27	86	Houses 6	ED II	30 specimens		
			P 43:27	87	Houses 6	ED II	34 specimens		
			P 43:28	108	Houses 4	ED II	17 specimens		
			P 43:33	78	Houses 8	ED I	5 specimens		
			P 43:33	83	Houses 7?	ED I	16 specimens		
			P 43:34	70	Houses 9	ED I			
			P 43:37	59	Houses 10	ED I			
			P 43:39	76	Houses 9?	ED I	4 specimens		
			P 43:40	55	Houses 10	ED I	4 specimens		
			P 43:41	62	Houses 10	ED I	4 specimens		
			P 43:42	51	Houses 11	ED I	3 specimens		
			P 43:45	65	Houses 10	ED I	8 specimens		
			P 43:45	66	Houses 10	ED I	7 specimens		
			P 43:45	73	Houses 9	ED I	2 specimens		
			P 44:2		Houses 1	ED III			
			P 44:5		Houses 1	ED III			
			P 44:10		Houses 2	ED III			
			P 44:15		Houses 1	ED III	Kh.III 169		
			P 44:17		Houses 1	ED III	2 specimens		
			P 44:22		Houses 1	ED III	2 specimens		
			P 45		Houses 1	ED III	Kh.I 230a-b		
			P 45, rubbish		(Nintu VII)	ED III	Kh.I 63		
			P 45:2		Houses 1	ED III			
			P 45:5		Houses 2 or 1	ED III			
			P 45:8		Houses 2	ED III			
			P 45:10		Houses 1	ED III	3 specimens		
			P 45:11		Houses 2	ED III	Kh.III 479		
			P 45:13		Houses 1	ED III	3 specimens		
			P 45:14		Houses 2	ED III	Kh.III 478, 876		
			P 46:1		Houses 2	ED III			
			P 46:4		Houses 2	ED III			
			Q 43:2		Houses 2	ED III	Kh.III 278		
			Q 43:3		Houses 2	ED III			
			Q 43:5		Houses 2	ED III			
			Q 49:1	117	Houses 4 or 3	ED II or III	7 specimens		
			R 35:2	166	Near surf.	ED III?	5 specimens		
			R 44		Houses 2	ED III	Kh.I 43a-b, 64a-b, 65a-b		
			R 45:3		Houses 2	ED III	Kh.III 1347		
			S 42:1	144	Houses 2	ED III			
			V 44:2	156	Houses 1 or above	Protoimp.?			
B.002.200b		As.	D 15:2		Earlier N. Palace	ED III	As.32:982. See pp. 94-95,105, 109,113	Kish	"A," Pls. XVI 33 and LIV 17
			D 17:17			Protoimp.?		Jamdat Nasr	Mackay, Pl. LXVII 5
			D 17:18			Protoimp.?	2 specimens	Farah	Fara, Fig. 42, F 2809; MJ XXII, Pl. XIV 5
			D 17:19			Protoimp.?			
			E 16:26		Earlier N. Palace	ED III			
			H 20:2		Houses Va	Protoimp.	As.31:P.42 f; C	Ur	RC, Type 4a
			J 19:2		Houses III	Gutium-Ur III	As.32:P.13	al- ^c Uбайд	Type II
			J 19:13		Houses Vc	ED III		Mari	Syria XVI 8, Fig. 3
			J 19:50		Houses Vb	ED III			
			O 43:11		Small Temple IX	ED III	Kh.III 1249: 5 specimens, one inside another		
			B.002.200		Kh.	L 43:7			See B.022.210
B.002.500		Kh.	P 43:42	51	Houses 11	ED I	6 specimens		
B.003.200a		Kh.	Q 43:1		Houses 2	ED III	Kh.III 226. See p. 94	Kish	"A," Pl. LIV 21
			K 42:13	122	Houses 3	ED III			
B.003.200b	20d	Kh.	P 42:50		(Sin II)	Protolit. c	Kh.VII 31; C. See pp. 34,126, 135 (n. 52)	Jamdat Nasr	Mackay, Pl. LXVII 6
			N 43:12	111	Houses 4	ED II	2 specimens	Warka	UVB IV, Pl. 20 B g'
			P 43:27	86	Houses 6	ED II	5 specimens	Farah	Fara, Fig. 41, F 2807
			P 43:33	71	Houses 9	ED I	See p. 59		
			P 43:39	76	Houses 9?	ED I	18 specimens	Ur	RC, Type 7a
	49c						al- ^c Uбайд	Type IV	
B.003.210a		As.	D 15:3		30-29 m.	ED I	As.33:426. See pp. 59,73 and Pl. 63:1		
B.003.210b	65:58-65	Ag.	Hill B		Top layer	ED I	Ag.36:551 and 553 (B), 552 and 554 (C) and 4 unrecorded specimens. See pp. 59,79		
			74d	Kh.	N 44:11	101	Houses 5	ED II	See p. 83

Form	Photo on Plate	Site	Square, Locus, or Area	Grave	Building or Level	Date of Find-Spot	Remarks	Comparanda	
								Site	Reference
B.003.700		Kh.	K 42:13 K 42:13	124	Houses 4 Houses 3	ED II ED III	Kh.III 1366 Kh.III 1397. See p. 95		
B.007.700	46h	As.	D 17:26		Archaic Shrine III	ED I	As. 34:106 (C) and many others; see pp. 56-57,136-39	Telloh Warka	G I, Pl. VIII 4332 UVB IV, Pl. 20 A s and B y', c''
B.011.200		As.	J 19:11		Houses IVa	L. Agade	As.32:611		
B.016.200		Kh.	O 42:1		Houses 3 or 2	ED III	Kh.III 660. See p. 95	Ur al- ^c Ubaid	RC, Type 7d Type VIII
B.022.200	48a	Kh.	N 44:13	56	Houses 10	ED I	Kh.V 288; B. See p. 58	Kish	Kish IV, Pls. I 1 and XVI 2
	48b		N 44:13 P 43:40	56 55	Houses 10 Houses 10	ED I ED I	Kh.V 289; C. See p. 58		
B.022.210	97a	Kh.	L 43:7		Oval I or II	ED II or III	Kh.I 523b. See pp. 83,95,142; published in OIP LIII as B.002.200		
B.023.200		Kh.	N 44:14 O 43:55*	92 22	Houses 6 Houses 12	ED II Protolit.d			
B.023.210		Kh.	O 43:18 Unknown	72	Houses 9 Surf.	ED I ED III?	See pp. 95,142		
B.023.700		Kh.	P 43:54	4	31.95 m.	Protolit.c			
B.024.210		As.	E 15:2 D 16:7 D 16:9 D 17:18 Below E 15:10 E 17:8 F 23:1 J 18:19 Street N. of J 20:8 J 20:21		N. Palace Outside N. Palace Outside N. Palace Earlier N. Palace N. Palace Houses IVb Houses IVa Houses V	Protoimp. Protoimp.? Protoimp.? Protoimp.? ED III Protoimp. Agade? E. Agade L. Agade Protoimp.?	As.31:P.60a; B. See pp. 95,106, 109 As.31:P.60b; C		
B.025.210	74e	Kh.	O 43:16		Small Temple VIII	ED II	See p. 83		
B.031.200		As.	M 30:1 J 19:35 N 30:10 P 31:1 V 30:4		2 m. below surf. Houses III Bilalama Below Ituria Shamash	Larsa Gutium-Ur III E. Larsa Ur III L. Larsa or Old Bab.	As.30:P.22a; C. See pp. 113, 115,123 As.32:P.56 As.31:P.22c; C As.30:P.22b; C Ish.P.30	Nuzi Gaura	Pl, 50 J Pl, LXV 54
B.031.500	106a	Kh.	D 28:2			ED III?	Kh.VI 42; B. See p. 102		
B.031.510		As.	K 21:11		Houses Va	Protoimp.	As.32:303. See p. 106		
B.032.200a		As.	J 19:48 J 19:48		Houses IVb Houses IVb	E. Agade E. Agade	As.32:1307. See p. 109 As.32:1308	Kish Jamdat Nasr	"A," Pl. XVI 32 Mackay, Pl. LXVII 13
		Kh.	S 42:1	144	Houses 2	ED III	See p. 94	Telloh Ur al- ^c Ubaid	G I, Pl. VIII 4182 RC, Type 5b Type I
B.032.200b		As.	E 15:2 E 15:2 E 16:5 E 16:7 E 16:8 F 16:3 F 17:2, sounding G 19:3 H 18, East Street H 18:5 H 18:7 H 18:8 H 27 O 30:18		N. Palace N. Palace Houses above N. Palace Houses above N. Palace Houses above N. Palace Houses above N. Palace Surf. Houses III? Houses II Houses IVa or III Houses III or II Bilalama or below	Protoimp. Protoimp. Larsa? Larsa? Larsa? Larsa? Larsa? Agade? L. Agade? Gutium-Ur III? Gutium-Ur III L. Agade or Gutium-Ur III Gutium-Ur III Larsa? Gutium-Ur III or E. Larsa	As.31:P.97a; C. See pp. 105, 109,113,115 As.31:P.97b-e (C) and ca. 80 others		



B.001.200*a*

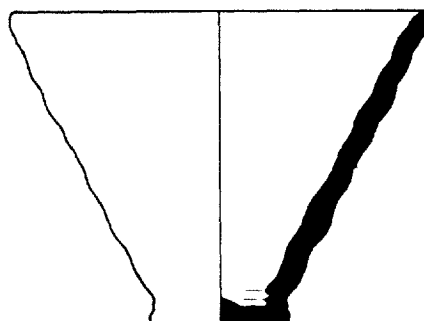

B.003.200*b*

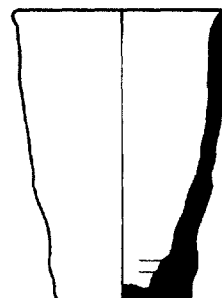

B.016.200

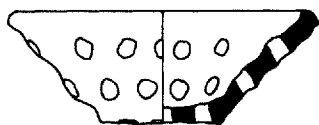

B.001.200*b*

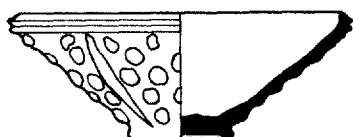

B.001.310

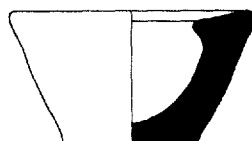

B.003.210*a*

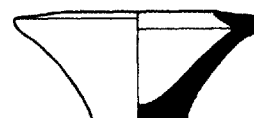

B.022.210

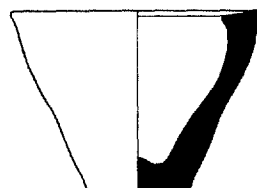

B.003.210*b*

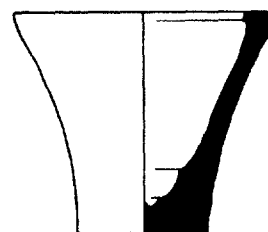

B.024.210



B.002.200*a*

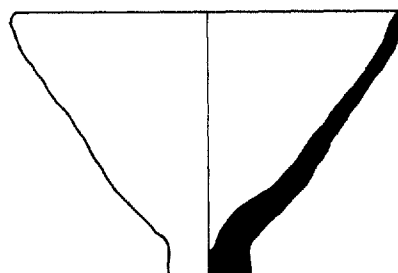

B.003.700



B.031.200

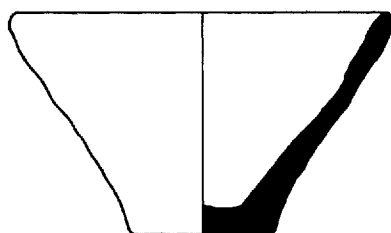

B.002.200*b*

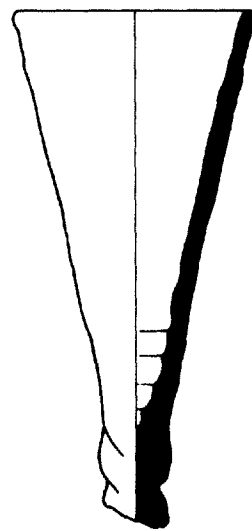

B.007.700

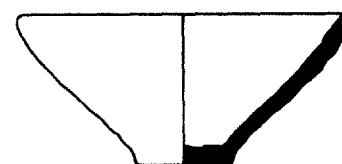

B.032.200*a*

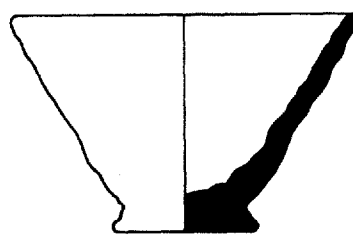

B.003.200*a*

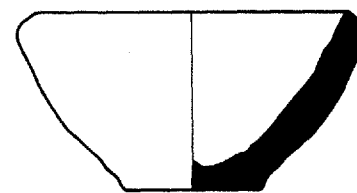

B.032.200*b*

B.032-B.047

Form	Photo on Plate	Site	Square, Locus, or Area	Grave	Building or Level	Date of Find-Spot	Remarks	Comparanda	
								Site	Reference
B.032.210		Ish.	T 31:2		Kititum IV	L. Larsa or Old Bab.	Ish.P.55.		
B.032.500	120d	Kh. As.	P 44:22 Q 49:1 O 30:18 S 36* S. Bldg. S. Bldg.	117	Houses 1 Houses 4 or 3 Bilalama Snake Shrine Ibiqadad II Ibiqadad II	ED III ED II or III E. Larsa Larsa L. Larsa L. Larsa	Kh.III 345. See p. 95 As.31:428c; C. See p. 115; green-buff, perforated As.35:93. Perforated As.31:428a; C. Buff, bitumen on rim, perforated As.31:428b; C. Pink-buff, perforated	Kish Ur Nuzi	"A," Pl. LIV 36 RC, Type 248 Pl. 95.J
B.033.200	74b	Kh.	N 44:6	94	Houses 6	ED II	See p. 83		
B.033.210	74c	Kh.	L 43:7 K 42:2		Oval I Houses 3	ED II ED III	Kh.I 523c. See p. 83; published in OIP LIII as B.033.310		
B.033.310		Kh.	L 43:7				See B.033.210		
B.033.700a	96g	Kh.	N 43:2		Houses 2	ED III	Kh.III 418; C. See pp. 95, 142		
B.033.700b	96f	Kh.	P 45:14 M 42:5* S 45:1	152	Houses 2 Houses 3 Houses 2	ED III ED III ED III	Kh.III 975 Kh.III 1135 Kh.VIII 105. See pp. 95, 142		
B.033.700c		Kh.	P 45:14 K 42:13 O 43:6	124 137	Houses 2 Houses 3 Houses 3	ED III ED III ED III	Kh.III 974. See p. 95 Kh.III 1398		
B.034.203	24c	Kh.	P 42:50		(Sin II)	Protolit.c	Kh.VII 30; B. See pp. 42-43		
B.041.200		As.	J 19:29		Houses IVa	L. Agade	As.32:792. See p. 109		
B.041.500	23j	Kh.	Q 42:26 O 43:43 O 43:55 Q 42:26 Q 42:39	48 8	Sin III Houses 11 32.50 m. Sin II	Protolit.c ED I Protolit.c Protolit.c Protolit.c	Kh.VII 145; C. See pp. 41-42 See C.041.500 Kh.VII 211; B. Red paint outside	Jamdat Nasr Telloh	Mackay, Pl. LXVI 24 G I, Pl. V 4729
B.041.503		Kh.	O 44:14		Houses 1	ED III	Kh.III 342a. See p. 98		
B.041.710		As.	G 18 E. of H 20:6		Houses Va	Agade? Protoimp.	As.31:P.99; B. See pp. 102, 110 As.32:P.30. See p. 106	Kish Susa	"A," Pl. XLV 4 Mém. I, Figs. 334 and 336; XIII, Pl. XLIV 4
B.041.900		Kh.	r 80			Old Bab.	Kh. VIII 216. See pp. 102, 123		
B.042.200	49d	Kh.	P 43:45 K 42:13*	36 122	Houses 11 Houses 3	ED I ED III	Kh.IX 226; B. See p. 59		
B.042.500a		As. Kh.	F 19:2 Q 42:17		Houses IVa Sin V	L. Agade Protolit.d or ED I	As.31:P.32; C. See p. 109; hand-made, bitumen-coated Cover of Kh. VII 15; C. Perforation in base; see C.533.313 for drawing and p. 41	Nuzi Gaura	Pl. 95 J and P Pl. LXVII 97
B.042.500b	114b	As.	G 18:1 H 18:3 H 18:6		Houses IV Houses IVa? Houses IVa?	Agade L. Agade? L. Agade?	As.31:P.48a; C. See p. 109 As.31:P.48b; C As.31:P.48c; C		
B.043.200a		As. Ag.	J 19:10 J 20:5 Hill B		Houses III Houses III Top layer	Gutium-Ur III Gutium-Ur III ED I	As.32:P.18. See p. 113 Ag.36:453; C. See p. 58; 10 cm. d. x 7 h.		
B.043.200b		As.	J 19:1 J 20:5		Houses II or I Houses III	Gutium-Ur III or E. Larsa Gutium-Ur III	As.32:P.6. See pp. 113, 115 As.32:454		
B.043.210a		As.	F 17:1		Houses above N. Palace	Larsa?	As.31:P.93; B. See p. 115		
B.043.210b		As.	F 17:5		36.25 m.	Agade	As.32:P.24. See p. 109		
B.043.210c		Kh.	O 41:2		Houses 3 or 2	ED III	Kh.III 296. See p. 95		
B.043.500		Kh.	O 42:5		Houses 3 or 2	ED III	Kh.III 1176. Rough ware		
B.043.503		Kh.	O 44:14		Houses 1	ED III	Kh.III 842b. See p. 98		
B.044.210		Kh.	O 44		Surf.	ED III	Kh.I 91		
B.047.700	70j	As.			Square Temple	ED II	See p. 82		

PLATE 147

B.032-B.043

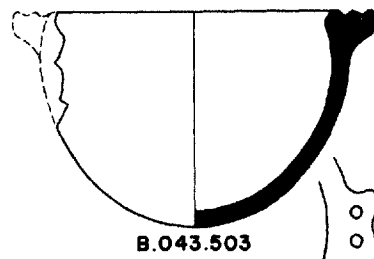
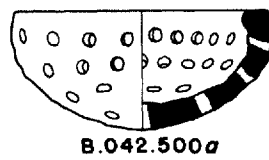
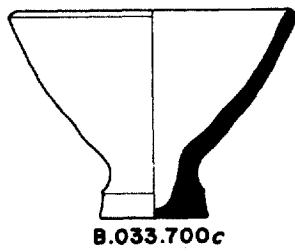
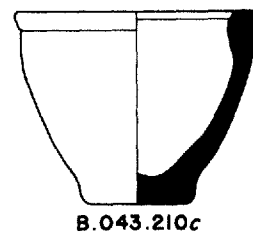
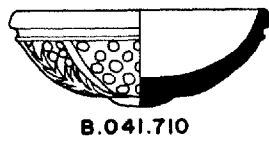
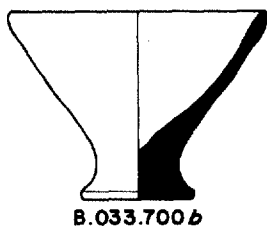
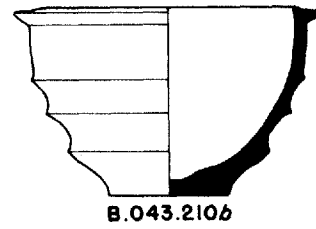
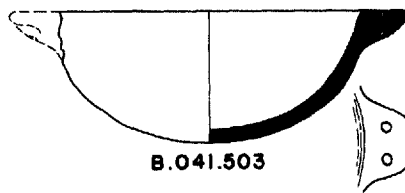
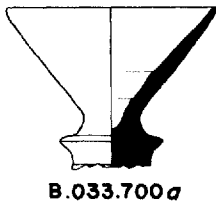
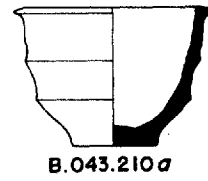
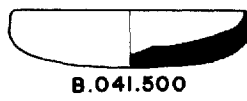
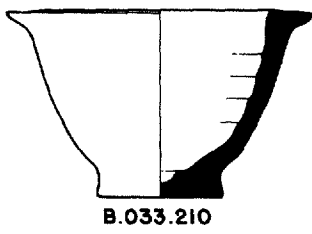
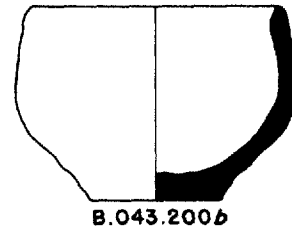
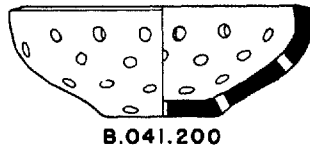
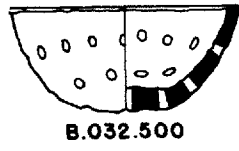
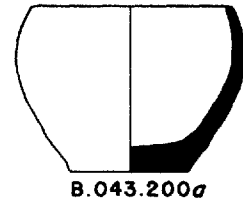
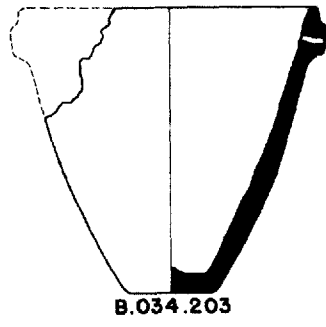
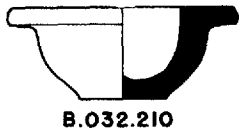

SCALE, 2:5

Form	Photo on Plate	Site	Square, Locus, or Area	Grave	Building or Level	Date of Find-Spot	Remarks	Comparanda	
								Site	Reference
B.052.200a		As.	O 29:5			Larsa	As.30:P.2. See p. 115	Ur	RC, Type 29
B.052.200b	120c	As.	J 19:1		Houses II or I	Gutium-Ur III or E. Larsa	As.32:P.7. See p. 115		
			J 19:1		Houses II or I	Gutium-Ur III or E. Larsa	As.32:P.19		
B.052.200c		As.	O 30:14 O 30:4 O 33		Bilalama	E. Larsa Larsa	As.31:P.38a; B. See p. 115 As.31:P.38c; C	Shaghir Bazar	Iraq III, Fig. 15:8
B.052.202		As.	L 27:2		Ibīqadad II	L. Larsa	As.31:P.38b; C		
B.052.503		Kh.	K 42:4		Houses 3	Larsa? ED III	As.31:P.81; C. See p. 115 Kh.IV 415		
B.054.700		As.	H 19:12		Houses Va	Protoimp.	As.32:P.36. See pp. 99, 106	Telloh	G II, Pl. XXX 4101
B.060.210	97b	Kh.	O 43:3		Houses 3?	ED III?	See pp. 95, 142		
B.061.210		As.	P 29:4		10 cm. below surf. Houses above N. Palace	Larsa? Larsa?	As.30:P.3. See pp. 109, 113, 115		
			F 17:2, sounding H 18:8 J 19:35 L 30:1 N 33 O 33:10		Houses IVa-II Houses III	Agade? Agade or later Gutium-Ur III		Telloh	G II, Pl. XXX 4101
	120b		P 33:2 P 33:4		Ibīqadad II Below Ibīqadad II Ibīqadad II	L. Larsa L. Larsa	As.32:P.57 As.30:P.3c; C As.30:P.3a; C		
B.062.200		As.	J 19:1		Houses II or I	Gutium-Ur III or E. Larsa	As.32:P.17		
B.062.210a		Ish.	R 29:1		Kittitum II	L. Larsa	Ish.P.63. See p. 115	Telloh	G II, Pl. XXX 4101
B.062.210b	97e	Kh.	L 43:7		Oval I or II	ED II or III	Kh.I 523a. See pp. 83, 95, 142		
B.063.200a		As.	H 18:14		24-23 m.	Protolit.d	See p. 77	Telloh Warka	G I, Pl. XI 4558 UVB IV, Pl. 20 B q'
B.063.200b		As.	E 17:9		Earlier N. Palace Earlier N. Palace	ED III ED III	As.33:150. See p. 94		
B.064.200		As.	D 15:3		22-21 m.	Protolit.d	See p. 75 and Pl. 63:63	Telloh	G I, Pl. XIII 1925
B.064.210		As.	E 14:1 E 17 J 19:27 J 20:15 K 19:27		N. Palace 34.50 m. Houses Va Houses Va Houses Va	Protoimp. Protoimp.? Protoimp. Protoimp. Protoimp.	As.31:P.96; C. See p. 106		
B.067.700		Kh.	Q 42:3		Sin IX	ED II or III	Kh.IV 403		
B.071.500		Kh.	Q 42:14		Sin V	Protolit.d or ED I	Kh.V 198. Hole in bottom	Telloh	G I, Pl. XIII 1925
B.072.200		As.	J 19:13 E 17:9		Houses Va Earlier N. Palace	Protoimp. ED III	As.32:1311 4 specimens; see p. 94		
B.072.210a	65:67	Ag.	Hill B		Top layer	ED I	Ag.38:549; C. See p. 79		
B.072.210b	113a	As.	J 19:15 E. of D 16:6 D 17:18		Houses IVa Outside N. Palace	L. Agade Protoimp.? Protoimp.?	As.32:789. See p. 109 See p. 106	Telloh Warka	G I, Pl. VIII 4332 UVB IV, Pl. 20 A s and B y', c' Type VII Mém. VIII, Fig. 270
B.073.210	97k	Kh.	O 44:4		Houses 2	ED III	Kh.I 270. See pp. 95, 142		
B.075.210		Ag.	M 14:4		31.50 m.	ED II	Ag.35:1012		
B.076.700	46a	Kh.	P 43:42	33	Houses 11	Ed I	Kh.IX 229; P. See pp. 56-57, 136-39	al- ^c Ubaid Musyan	Mém. VIII, Fig. 270
			O 42:8	79	Houses 8	ED I	2 specimens		
			O 43:24	80	Houses 8	ED I			
			P 43:39	69	Houses 9	ED I			
			P 43:40	55	Houses 10	ED I			
			P 43:41	62	Houses 10	ED I			
			P 43:42	51	Houses 11	ED I			
			P 43:45	57	Houses 10	ED I			
			P 43:45	65	Houses 10	ED I			
			P 43:45	66	Houses 10	ED I			
			P 43:53	81	Houses 8	ED I			
B.077.700a	46g	As.	D 17:26		Archaic Shrine III	ED I	As.34:109 (B) and many others; see pp. 56-57, 136-39	Kish Warka	Kish IV, Pls. I 6 and XVI 4 UVB IV, Pl. 20 A s and B y', c'' Type VII Fig. 4:8
		Kh.	Q 42:9* Q 42:17*		Sin VI Sin V and above	ED I ED I	Fragments of many Fragments of many		
B.077.700b	46c	Kh.	P 43:33	71	Houses 9	ED I	See pp. 56-57, 136-39 7 specimens	al- ^c Ubaid Eridu	Fig. 4:8
	46e		O 43:18	72	Houses 9	ED I			
	46d		O 43:29		Houses 10 or 9	ED I			
B.077.700		As.	D 15:3* D 15:3* H 18:14* H 18:14*		27-26 m. 29-28 m. 27-26 m. 29-27 m.	ED I ED I ED I ED I	See pp. 56-57, 74 and Pl. 63:44 See p. 73 and Pl. 63:5 See p. 75 and Pl. 64:11 See p. 75 and Pl. 64:9	al- ^c Ubaid Eridu	Fig. 4:8
	46b	Kh.	N 44:13	56	Houses 10	ED I	5 specimens		

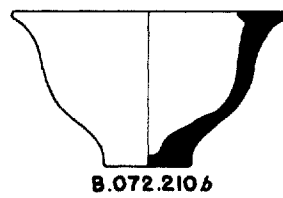
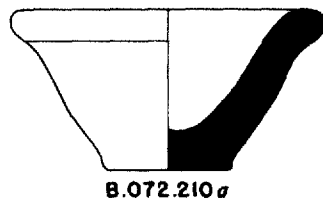
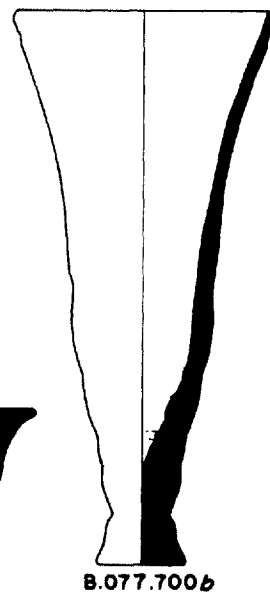
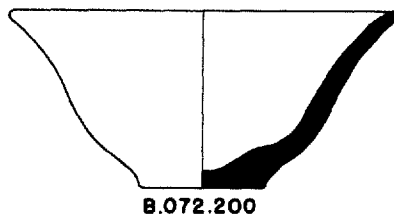
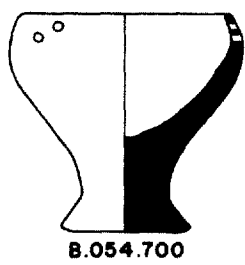
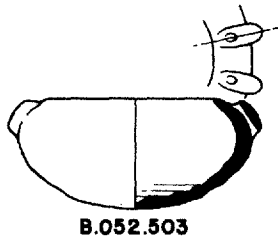
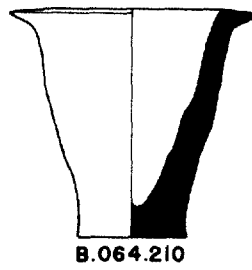
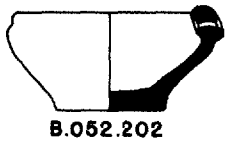
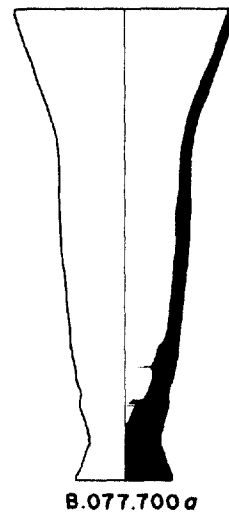
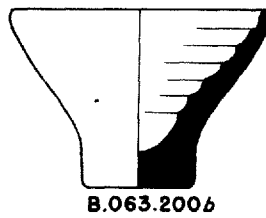
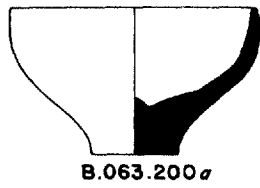
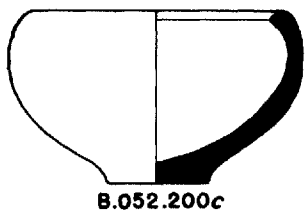
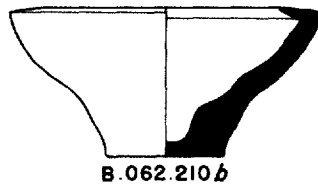
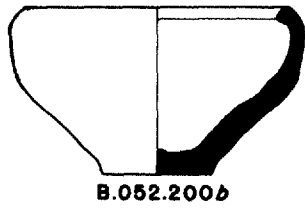
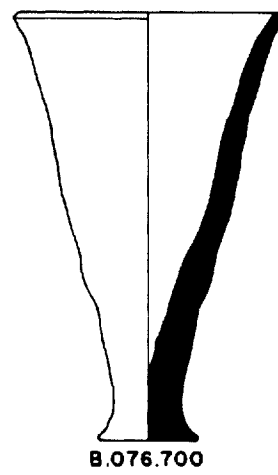
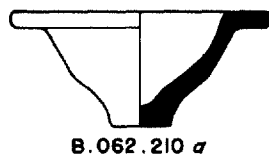
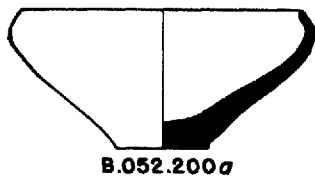

B.081-B.087

Form	Photo on Plate	Site	Square, Locus, or Area	Grave	Building or Level	Date of Find-Spot	Remarks	Comparanda	
								Site	Reference
B.081.210	97c	Kh.	K 43:5		Oval II	ED III	Kh.I 458. See pp. 95, 142		
B.082.200	96e	Kh.	O 43:6	137	Houses 3	ED III	See pp. 94, 142		
B.082.210	97g	Kh.	M 43:5		Oval III	ED III or Protoimp.	Kh.I 382. See pp. 95, 142		
			J 43:1		Houses 4 or above	ED II or III	Kh.III 1300		
B.083.200		As.	D 17:14		Archaic Shrine	ED I	As.34:87. See pp. 58-59, 79, 94, 142		
	65:57	Ag.	Hill B*		Top layer	ED I	Ag.36:550; B		
	49b	Kh.	N 43:12	116	Houses 4	ED II	2 specimens		
	96d		N 44:13	56	Houses 10	ED I	5 specimens		
			O 43:6	137	Houses 3	ED III	See p. 94		
			O 43:18	72	Houses 9	ED I	2 specimens		
	48a		O 43:24	80	Houses 8	ED I			
B.083.210a		Kh.	P 45:14		Houses 2	ED III	Kh.III 979. See p. 95		
			P 45:14		Houses 2	ED III	Kh.III 980		
			K 42:13	124	Houses 3	ED III	Kh.III 1399-1400		
B.083.210b		Kh.	P 45:14		Houses 2	ED III	Kh.III 981-82		
			K 42:4		Houses 3	ED III	Kh.III 1303		
			K 42:9		Houses 3?	ED III?			
			L 42:3		Houses 3	ED III			
	97f		O 43:3		Houses 3 or 2	ED III	See pp. 95, 142		
B.083.210c	97i	Kh.	O 44:18		Houses 2	ED III	Kh.I 289. See pp. 95, 142		
B.084.200		As.	H 18:14		26-25 m.	Protolit. d or ED I	See p. 76 and Pl. 64:31		
			H 18:14		27-26 m.	ED I	See p. 75 and Pl. 64:10		
			H 18:14		29-27 m.	ED I	See p. 75 and Pl. 64:1		
B.084.210a		As.	G 18:7		Houses IVb	E. Agade	As.32:P.2. See p. 109		
			J 19:15		Houses IVa	L. Agade			
			J 20:5		Houses IVa	L. Agade			
B.084.210b		Kh.	P 45:14		Houses 2	ED III	Kh.III 983. See p. 95		
			O 43:8		Houses 2 or 1	ED III	Kh.III 899		
B.084.210c	97h	Kh.	O 44:18		Houses 2	ED III	Kh.I 283. See pp. 95, 142		
B.084.710a		Kh.	P 45:12		Houses 1	ED III	Kh.III 204. See p. 95		
B.084.710b	97j	As.	Below E 15:10		Earlier N. Palace	ED III	As.32:809. See pp. 95, 106, 142		
			J 19:64		Houses Va	Protoimp.			
B.085.200		As.	J 20			Agade?	See pp. 58-59		
			D 17:26		Archaic Shrine III	ED I	As.34:111. Hole in side		
		Kh.	Q 42:26		Sin III	Protolit. c	Kh.VII 148; B. Cf. C.084.200		
B.085.210		As.	E 17:10*		Outside N. Palace	Protoimp.?	As.32:979. See pp. 95, 106		
			J 19:27		Houses Va	Protoimp.			
			J 19:50		Houses Vc	ED III			
			J 20:23		Houses Va	Protoimp.			
B.086.210		Kh.	P 44:21		Houses 1	ED III	Kh.III 886. See p. 95		
B.086.700	65:46 and 48-50	Ag.	Hill B		Top layer	ED I	Ag.36:556 (B), 557 (C), 559 (B) and 1 unrecorded specimen. See pp. 56-57, 79		
B.087.210		Kh.	P 45:14		Houses 2	ED III	Kh.III 875. See p. 95		
B.087.700		Kh.	P 43:33*	83	Houses 7?	ED I	See pp. 56-57, 79, 136-39		
	46f		P 43:42	51	Houses 11	ED I	Kh.IX 230; B		
		As.	D 17:10*		Archaic Shrine II	ED I	As.34:203		
	46i		D 17:26*		Archaic Shrine III	ED I	As.34:110 (B) and many others		
	65:47	Ag.	Hill B		Top layer	ED I	Ag.36:558; C		

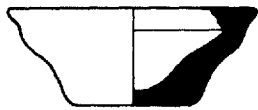

B.081.210

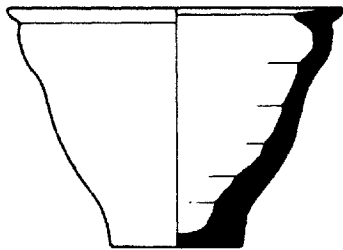

B.083.210c

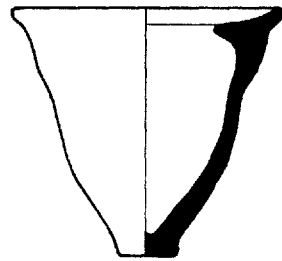

B.084.710a

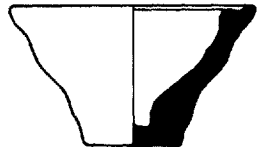

B.082.210

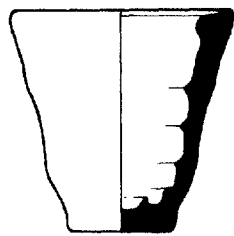

B.084.210a

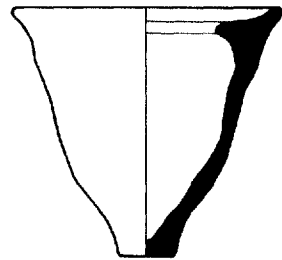

B.084.710b

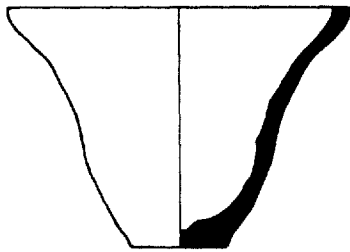

B.083.200

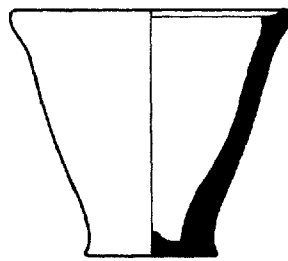

B.084.210b

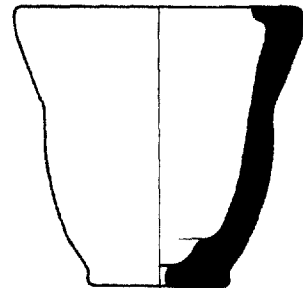

B.085.210

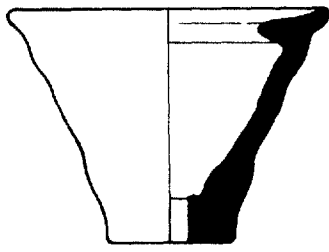

B.083.210a

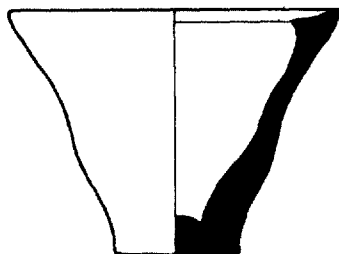

B.083.210b

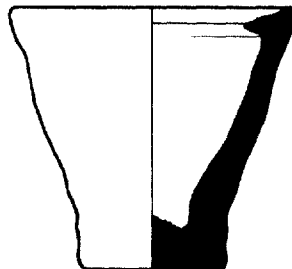

B.084.210c

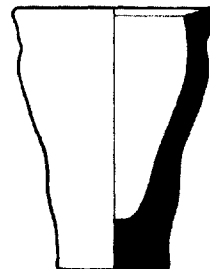

B.086.210

Form	Photo on Plate	Site	Square, Locus, or Area	Grave	Building or Level	Date of Find-Spot	Remarks	Comparanda	
								Site	Reference
B.111.210		As.	D 17:32		Archaic Shrine III	ED I	As.34:93. See p. 59		
B.123.200		Kh.	N 44:14	92	Houses 6	ED II		Abu Hatab	Fara, Fig. 63, F 1382
B.123.210	113c	As.	H 18:7		Houses IVa or III	L. Agade or Gutium-Ur III	As.31:P.115; C. See pp. 109, 113	Abu Hatab	Fara, Fig. 63, F 1382
B.140.210		Kh.	J 75			Larsa	Kh.VIII 231; B. See p. 115	Gaura	Pl. LXXIII 182
B.151.210		As.	O 29:5			Larsa	As.30:P.1a. See pp. 109, 113, 115, 117, 123	Warka	UVB VI, Fig. 7, W 14925 c
			E 16:4		Houses above N. Palace	Larsa?		Abu Hatab	Fara, Fig. 64, F 2867
			E 18:7		Houses above N. Palace	Larsa?		Ur	RC, Type 27
			F 16:3		Houses above N. Palace	Larsa?		Susa	Mém. I, Fig. 194
			F 16:5		Houses above N. Palace	Larsa?			
			F 17:1		Houses above N. Palace	Larsa?			
			F 17:4		Houses above N. Palace	Larsa?			
	113b		F 17:8		36.00 m.	Agade	As.32:P.44		
			G 18:3		Houses IVa	L. Agade			
			G 18:8		Houses III	Gutium-Ur III	As.30:P.1b; B		
			G 18:9			Agade or later			
			H 18:8		Houses IVa-II	Agade or later			
			J 19:5		Houses I	E. Larsa			
			J 19:7		Houses II	Gutium-Ur III			
			J 20:5		Houses III	Gutium-Ur III			
			K 19:3			Agade or later			
			M 31:9			Ur III			
			M 31:11			Ur III			
			M 33:2		2 m. below surf.	L. Larsa			
	120a		N 33:10			L. Larsa			
			O 30:17		Bilalama	E. Larsa	As.30:P.1i; C		
			P 30:4			E. Larsa	As.30:P.1h; C		
			P 33:13			L. Larsa			
			P 33:15			L. Larsa			
B.172.210		Kh.	J 43:2		Houses 3	ED III	Kh.III 1369. See p. 95		
B.173.222		As.	G 18:8		Houses IVa	L. Agade	As.31:P.191; C. See p. 110		
B.174.210a		As.	E 14:1 D 17:23*		N. Palace	Protoimp. Protoimp.?	As.31:P.62. See p. 106		
B.174.210b		As.	E 14:1		N. Palace	Protoimp.	As.31:P.3. See p. 106		
B.174.220a		As.	J 20:5 J 20:5		Houses III Houses III	Gutium-Ur III Gutium-Ur III	As.32:477 As.32:460. See p. 113	Kish Ur	"A," Pl. XV 22; Gen. I, Pl. 53:103 RC, Type 35
B.174.220b		As.	L 31:1			Larsa	As.30:P.11. See p. 116		
B.174.220c		As.	F 23:1			Agade?	As.31:P.69; C. See pp. 95, 106, 110	Ur	RC, Type 120 b
			G 18:4		Houses IV	Agade			
			G 19:4		Houses IVa	L. Agade	Several specimens		
			H 18:2		Houses II	Gutium-Ur III			
			H 18:2		Houses III?	Gutium-Ur III			
			H 19:12		Houses Va	Protoimp.	As.32:P.37		
			H 19:32		Houses IVb	E. Agade			
			J 19:48		Houses IVb	E. Agade			
			J 20:5		Houses IVa	L. Agade			
			J 20:15		Houses Va	Protoimp.	3 specimens		
			K 28:2			Agade			
		Kh.	K 42:13	124	Houses 3	ED III	Kh.III 1401		
B.174.220		Kh.	K 43:5				See B.184.220c		
B.174.740		Ish.	V 32:4		Houses	L. Larsa or Old Bab.	Ish.P.29. See p. 115	Nuzi	Pl. 50 R
B.175.220a		Kh.	M 42:2 N 43:6		Houses 2 Houses 2	ED III ED III	Kh.III 1048. See p. 95 Kh.III 1048	Kish Ur al-Ubaid	"A," Pl. LIII 1 RC, Type 109 a Type LXVIII
B.175.220b		As.	Below E 15:1		Earlier N. Palace	ED III	As.32:980. See p. 95	Kish	"A," Pls. XV 31 and LIII 1
B.175.221	98p	As.	E 16:32		Earlier N. Palace	ED III	As.32:704; B. See p. 92		
			K 19:34		Houses Va	Protoimp.	See p. 106		
B.175.224		Kh.	P 45:14 P 45:14 O 47:2		Houses 2 Houses 2 Surf.	ED III ED III ED III	Kh.III 985. See p. 95 Kh.III 986 Kh.III 874. Published in OIP LIII as B.176.224	Kish	"A," Pl. XV 44



B.111.210

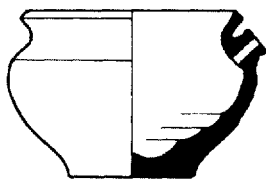

B.173.222

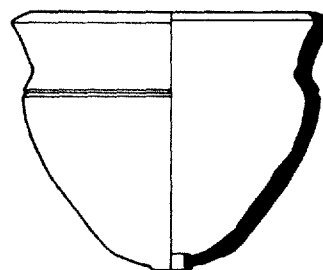

B.174.740

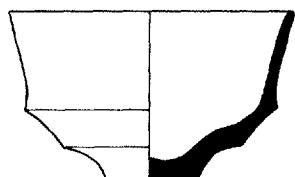

B.123.200

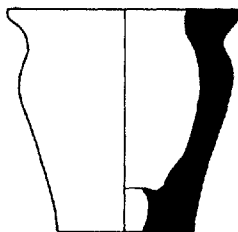

B.174.210a

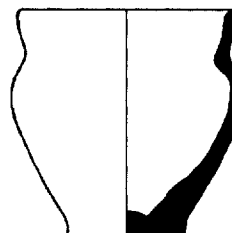

B.175.220a

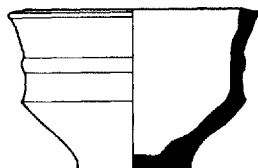

B.123.210

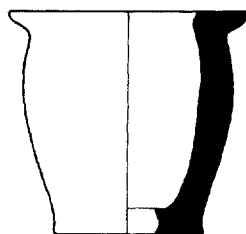

B.174.210b

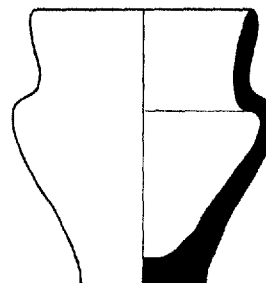

B.175.220b



B.140.210

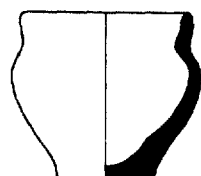

B.174.220a

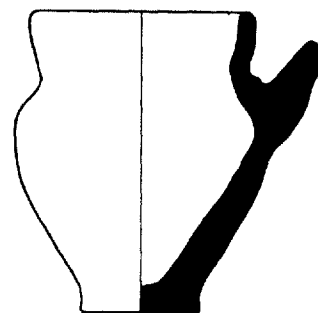

B.175.221

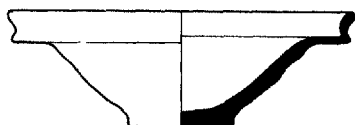

B.151.210

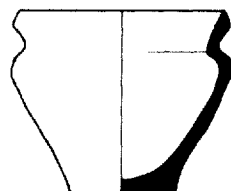

B.174.220b

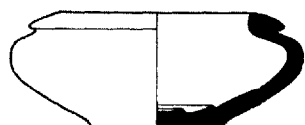

B.172.210

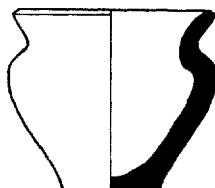

B.174.220c

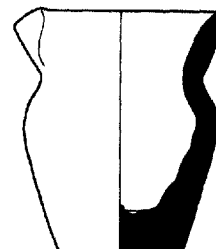

B.175.224

B.175-B.185

Form	Photo on Plate	Site	Square, Locus, or Area	Grave	Building or Level	Date of Find-Spot	Remarks	Comparanda	
								Site	Reference
B.175.720		As.	P 26:2		Near surf.	L. Larsa	As.33:731. See p. 116	Billa Shaghir Bazar Susa	MJ XXIII, Pl. LX 4 (painted) Iraq III, Fig. 17:5; IV, Fig. 24:11 (both painted) Mém. XXV, Fig. 76:21
B.175.760		Ish.			Kititum	L. Larsa or Old Bab.	Ish.P.60. See p. 116		
B.176.220a		As.	P 26:2		Near surf.	L. Larsa	As.33:730. See p. 116		
B.176.220b		As.	G 19:4 G 18:3 G 18:3		Houses IVa Houses IVa Houses IVa	L. Agade L. Agade L. Agade	As.31:P.67a; C. See p. 110 As.31:P.67b As.31:P.67c; B		
B.176.224a		Kh.	P 45:14 P 44:21		Houses 2 Houses 1	ED III ED III	Kh.III 872. See p. 95	Kish	"A," Pl. XV 45
B.176.224b		Kh.	O 42:3 P 45:14 Q 43:2	148	Above Houses 2 Houses 2 Houses 2	ED III ED III ED III	Kh.III 252. See p. 95 Kh.III 963 Kh.III 273		
B.176.224		Kh.	O 47:2				See B.175.224		
B.183.210		As.	D 17:32		Archaic Shrine III	ED I	As.34:120. See p. 59		
B.184.220a		As.	G 18:2 D 17:19 J 20:5 J 20:22		Houses IVa Houses III Houses Va	L. Agade Protoimp.? Gutium-Ur III Protoimp.	As.31:P.124; C. See pp. 106, 110, 113	Nuzi	Pl. 51 I
B.184.220b		Kh.	K 41:1		Houses 3	ED III	Kh.III 787. See p. 95	Jamdat Nasr	Mackay, Pl. LXVII 15-16
B.184.220c	98k	Kh.	K 43:5 L 42:4*		Oval III Houses 3	ED III or Protoimp. ED III	Kh.I 462. See pp. 95, 142; published in OIP LIII as B.174.220 Kh.III 788	Kish Ur al- ^c Ubaid	"A," Pl. XV 20-22 RC, Type 109 a Type LXVIII
B.185.220		As.	H 18:12 H 20:11* J 20:12 J 21:23		Houses IVb Houses Va Houses IVa Houses Va	E. Agade Protoimp. L. Agade Protoimp.	As.31:P.121; C. See pp. 106, 110 As.32:548	Kish Ur al- ^c Ubaid	"A," Pl. XV 30 RC, Type 109 a Type LXVIII
B.185.224		Kh.	P 45:14		Houses 2	ED III	Kh.III 978. See p. 95	Kish	"A," Pl. XV 42
B.185.260		As.	F 23:1			Agade?	As.31:P.61; C. See pp. 110, 111		

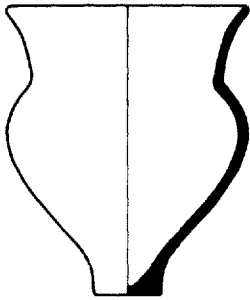

B.175.720

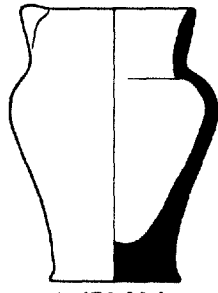

B.176.224*a*

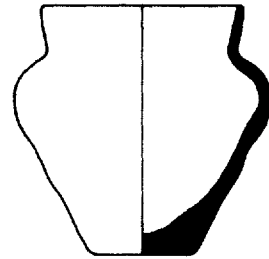

B.184.220*c*

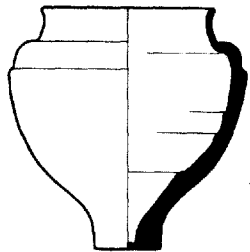

B.175.760

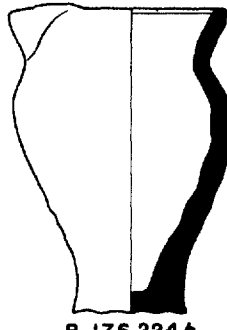

B.176.224*b*

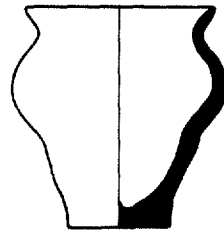

B.185.220

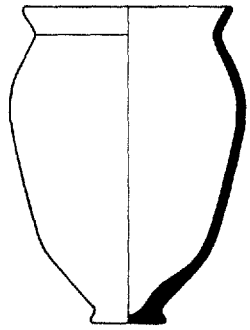

B.176.220*a*

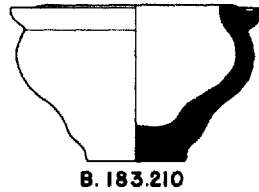

B.183.210

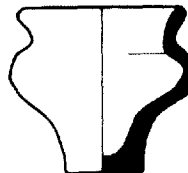

B.184.220*a*

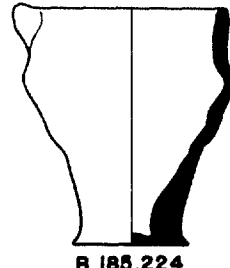

B.185.224

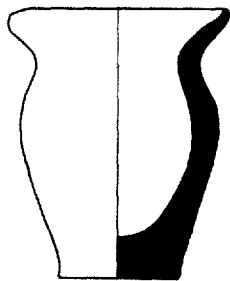

B.176.220*b*

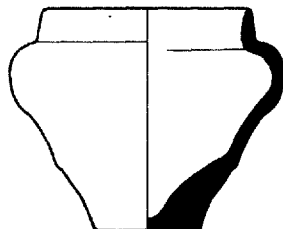

B.184.220*b*

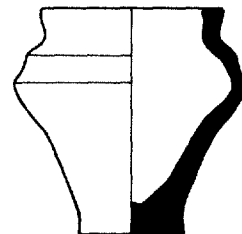

B.185.260

B.203 - B.226

Form	Photo on Plate	Site	Square, Locus, or Area	Grave	Building or Level	Date of Find-Spot	Remarks	Comparanda	
								Site	Reference
B.203.203		Kh.	P 44:1		Above Houses 1	ED III or Protoimp.	Kh.III 130. See p. 98		
B.203.510		Ag.	M 14:4		31.50 m.	ED II	Ag.35:987		
B.204.200		As.	K 40		Surf.	L. Larsa?	As.33:713		
B.206.423a	122a	As.	P 30:1 P 30:1		Ibalpiel I well Ibalpiel I well	L. Larsa L. Larsa	As.30:P.41d; B. See p. 119 As.30:P.41a; C. Published as As.30:P.40 in OIP XLIII, Fig. 130 c		
B.206.423b		As.	P 30:1 P 30:1		Ibalpiel I well Ibalpiel I well	L. Larsa L. Larsa	As.30:P.41b As.30:P.41c; C		
B.206.423c	122c	As.	L 31 O 29:8		Bilalama Near surf.	E. Larsa L. Larsa	As.30:P.18. See p. 119 As.30:P.6a; C. See p. 119; published as As.30:P.6 in OIP XLIII, Fig. 130 a		
B.206.423d	122b	As.	Q 33:5 N 33			L. Larsa	As.30:P.6b; C. 4 lugs, vertical rows of horizontal impressions		
B.206.423e	122d	As.	N 29		Surf. Near surf.	L. Larsa Larsa	As.30:P.40. See p. 119 As.30:P.8; C. See p. 119. Numerous sherds of similarly shaped vessels occurred in gray ware with white-filled incised decoration (see pp. 119-20 and Pls. 123-25)	Telloh	S, Pl. 44 bis: 6 a-b; C, pp. 36, 127, 147 f., 236=Pl. IV 2, 244=Pl. IV 1, 256; G II, Pls. 109:1 and 110:1,3-4=Pl. D
B.207.310a		Ish.	R 30:1		Kititum III	L. Larsa	Ish.P.13. See p. 116	Bismayah Nuzi Susa	Bismyah, p. 181 Pl. 56 I-S Mém. I, Fig. 337; XXV, Pl. XI
B.207.310b		Ish.	R 30:1		Kititum III	L. Larsa	Ish.P.16. See p. 116	Warka Abu Hatab	UVB VI, Fig. 7 Fara, Fig. 62, F 2860
B.224.443		As.	D 17:32		Archaic Shrine III	ED I	As.34:71. 4 pierced lugs; broken base	Kish	"A," Pl. LII 45 (suspension holes at rim)
B.225.540		As.	H 20:6		Houses Va	Protoimp.	As.32:P.50. See p. 107	Telloh	G II, Pl. 82:1 b
B.226.720a		Ish.	R 29:1		Kititum I or II	Larsa	Ish.P.59. See p. 116	Abu Hatab	Fara, Fig. 59, F 1922
B.226.720b		Ish.	R 29:1 R 29:1		Kititum II Kititum II	L. Larsa L. Larsa	Ish.P.44. See p. 116		
B.226.720c		Ish.	R 29:1 S. of R 33:3		Kititum IV Serai (Kititum IV)	L. Larsa Old Bab.	Ish.P.8. See p. 116	Kish Abu Hatab	Gen. I, Pl. 51:13; II, Pl. 56:3 Fara, Fig. 62, F 2859

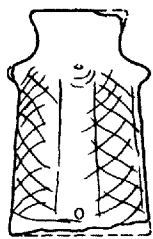

B.206.423 a

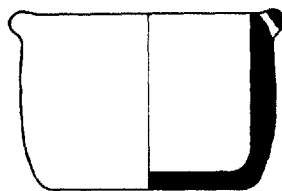

B.203.203

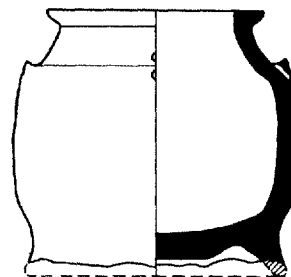

B.224.443

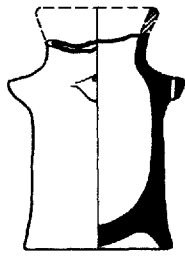

B.206.423 b

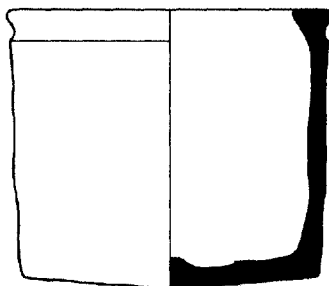

B.203.510

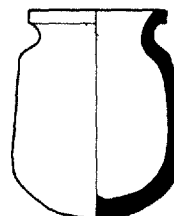

B.225.540

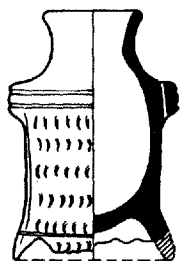

B.206.423 c

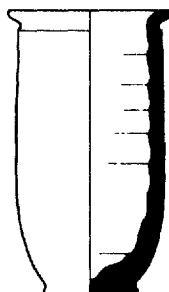

B.207.310 a

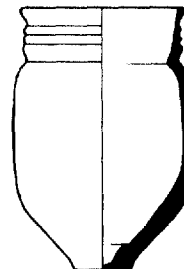

B.226.720 a

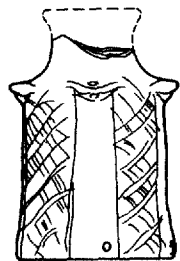

B.206.423 d

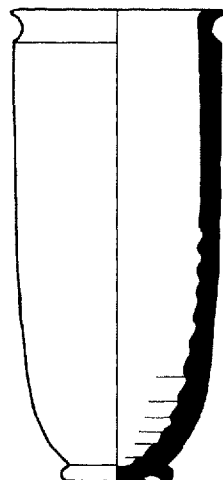

B.207.310 b

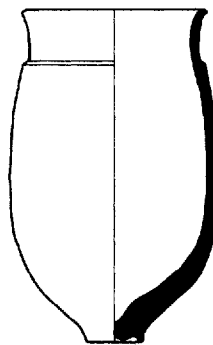

B.226.720 b

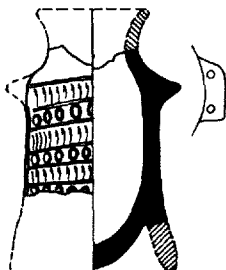

B.206.423 e

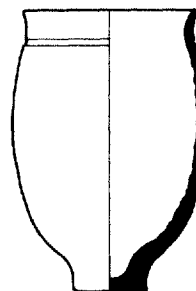

B.226.720 c

Form	Photo on Plate	Site	Square, Locus, or Area	Grave	Building or Level	Date of Find-Spot	Remarks	Comparanda	
								Site	Reference
B.236.000		Kh.	N 43:21 K 42:13* N 44:5* N 44:11 P 42:9 P 43:27	96 123 119 101 97 86	Houses 5 Houses 3 Houses 4 Houses 5 Houses 5 Houses 6	ED II ED III ED II ED II ED II ED II	Kh.III 1412		
B.236.200a	120g	As.	P 30:1 P 30:1 P 30:1 M 30:1		Ibalpiel I well Ibalpiel I well Ibalpiel I well Drain 3 m. below surf.	L. Larsa L. Larsa L. Larsa Larsa	As.30:P.15. See pp. 115, 123 As.30:P.15a-c (C), d (B) As.30:P.15e; C	Warka Farah Nuzi	UVB IX, Pl. 27 d (left) Fara, Fig. 41, F 2806 Pl. 76 O
		Ish.	M 32:5 V 31:6		Houses	Larsa L. Larsa or Old Bab.	Ish.P.56		
B.236.200b		Ish.	V 32:4		Houses	L. Larsa or Old Bab.	Ish.P.22. See pp. 115, 123	Nuzi	Pl. 76 P
B.236.200c		As.	Q 33:4			L. Larsa	As.31:P.25a; C. See pp. 115, 123	Kish	Gen. I, Pl. 51:38= Pl. III 3; II, Pl. 56:1
	120h		M 30:1 M 31:11 P 32:1		Drain 3 m. below surf.	Larsa L. Larsa L. Larsa	As.31:P.25b; C	Nuzi	Pl. 76 K
B.236.300		As.	P 32:1			L. Larsa	As.31:P.63. See pp. 115, 123	Nuzi Gaura Billa	Pl. 63 A Pl. LXXIII 187 and 190 MJ XXIII, Pl. LVII 2 (incised)
B.237.100	120i	As.	P 30:1		Ibalpiel I well	L. Larsa	As.30:P.49; C. See p. 115	Nuzi	Pls. 83 A and 76 I
B.237.200		Kh.	J 77			Larsa	Kh.VIII 181; B. See p. 115	Nuzi	Pl. 76 K
B.246.200a		As.	N 33:2 L 30:1		Below Ibiqadad II	L. Larsa Larsa	As.31:P.58a; C. See pp. 115, 148 As.31:P.58b (C), with black band at rim, and As.31:P.58c (B)	Ur Nuzi	RC, Type 14 a Pl. 76 J
B.246.200b		As.	P 30:1		Ibalpiel I well	L. Larsa	As.30:P.50; B	Bismayah	AJSL XXII 141, No. 9
B.246.500		Ish.	R 30:1		Kititum IV	L. Larsa	Ish.P.12. See p. 116		
B.247.200		Ish.	R 30:5		Kititum IV or above	L. Larsa	Ish.P.15. See p. 115		
B.247.700		As.	P 26:2		Near surf.	L. Larsa	As.33:729. See pp. 115-16		
B.255.200		As.	M 32:15 E. of J 20:6		Houses IVa	E. Larsa L. Agade	As.31:P.137x; C. See pp. 110, 115	Susa	Mém. XXV, Fig. 55:18
B.256.200	113 k	As.	F 16:2 Below F 17:4 F 17:6 J 19:1 J 19:12 J 20:5 J 20:8		N. Palace 36.50 m. 36.50 m. Houses II or I Houses II Houses III Houses IVa	Protoimp. Agade Agade Gutium-Ur III or E. Larsa Gutium-Ur III Gutium-Ur III L. Agade	As.31:P.136; C. See pp. 106, 110, 113, 115, 146, 147 As.32:476; B	Telloh Ur Susa	G I, Pls. XII (lower right) and XIII 3605; G II, Pl. III 1 b RC, Type 16 Antiquity V 336, Fig. 2 (upper left)

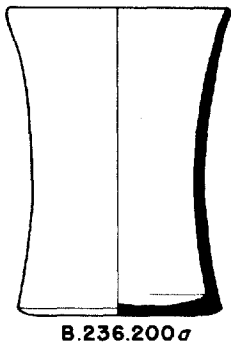

B.236.200 *a*

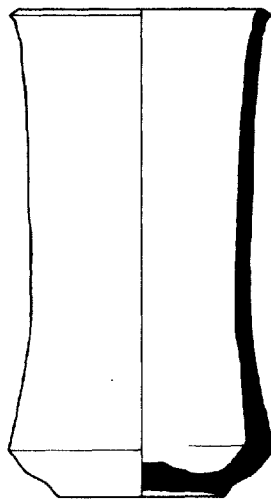

B.237.100

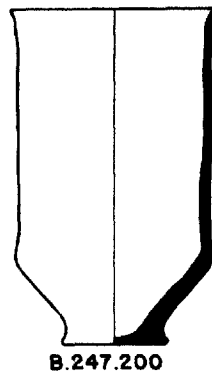

B.247.200

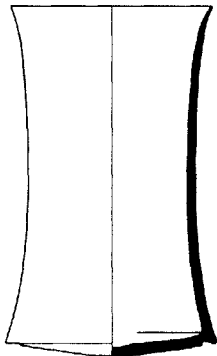

B.236.200 *b*

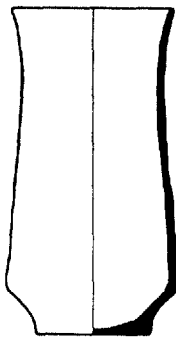

B.237.200

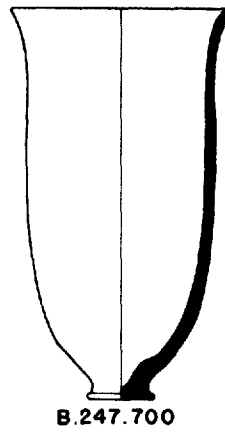

B.247.700

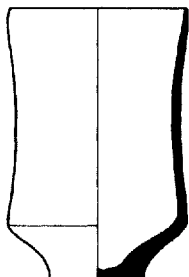

B.236.200 *c*

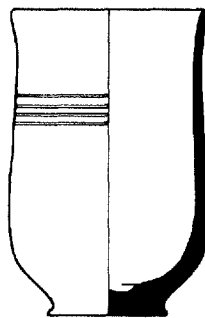

B.246.200 *a*

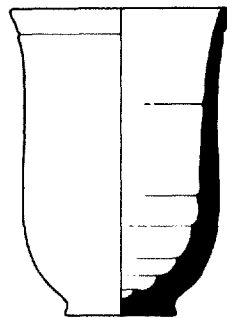

B.246.200 *b*

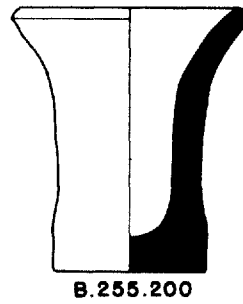

B.255.200

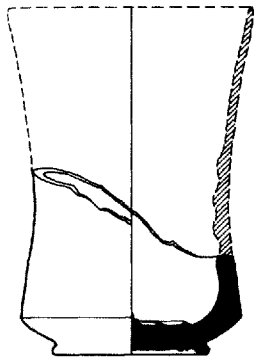

B.236.300

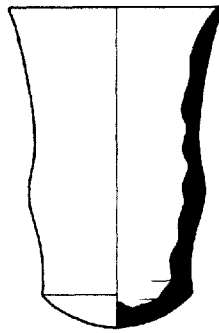

B.246.500

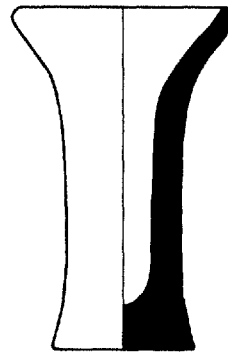

B.256.200

B.306-B.494

Form	Photo on Plate	Site	Square, Locus, or Area	Grave	Building or Level	Date of Find-Spot	Remarks	Comparanda	
								Site	Reference
B.306.503		Kh.	S 45:1	152	Houses 2	ED III	Kh.VIII 104. Gritty brown fabric		
B.311.220		Kh.	P 44:10		Houses 2 or 1	ED III	Kh.III 822. Solid lid		
B.356.000	70c	Kh.	N 43:20 N 44:6 N 44:6* N 44:7 N 44:14	99 110 110 131	Houses 5 Houses 4 Houses 4 Houses 3	ED II ED II ED II ED III	See pp. 81, 91 Kh.V 282; B		
	70b		O 43:3 O 43:3 P 43:23 P 43:23 P 43:27 P 43:28	133 133 89 91 87 108	Houses 6 Houses 3 Houses 3 Houses 6 Houses 6 Houses 4	ED II ED III ED III ED II ED II ED II	2 specimens Kh.V 292; C 3 specimens 3 specimens		
B.357.000		Kh.	N 43:15	113	Houses 4	ED II	See p. 81		
B.406.460		As.	H 20:30		Houses Vb	ED III	As.33:180		
B.406.462		As.	D 17:12		Square Temple	ED II	As.33:552		
B.413.253		Kh.	Q 42:39		Sin I	Protolit.c	Kh.VII 285; B. See p. 40; painted plum red		
B.414.270	23f	Kh.	O 43:55	6	32.50 m.	Protolit.c	Kh.IX 221a; B. See pp. 41-42	Susa	Mém. XIII, Pl. XXVII 2 (painted, lug on shoulder)
B.415.253		Kh.	Q 42:26				See B.455.253		
B.416.260	49h	Kh.	P 43:31		Houses 8	ED I	Kh.V 169. See p. 59		
B.416.371		Kh.	Q 45:12		Nintu VI	ED II	Kh.VIII 40		
B.416.373		Kh.	P 42			ED III?	See p. 98		
B.435.262		As.	E 17:10		Outside N. Palace	Protoimp.?	As.32:1103. Incised triangles on shoulder		
B.445.350		Kh.	Q 45:1		Houses 1	ED III	Kh.III 99; B. See p. 99		
B.446.262		As.	O 30:21		Below Bilalama	E. Larsa	As.31:P.113; B. See p. 117		
B.454.270		Kh.	P 43:55?	26?	Houses 12?	Protolit.d?		Jamdat Nasr Khazinah	Mackay, Pl. LXV 18 Mém. VIII, Fig. 269
B.454.642		Kh.	N 44:7	131	Houses 3	ED III	Kh.V 200. See pp. 91, 99		
B.455.253	22e	Kh.	Q 42:26		Sin III	Protolit.c	Kh.VI 334; C. Fine cream slip, burnished; see p. 40; published in OIP LVIII as B.415.253		
		As.	D 17:33		Earliest Shrine	Protolit.d	As.34:243. Published in OIP LVIII as C.455.253		
B.466.260	24d	Kh.	P 42:50		Houses 12	Protolit.d	Kh.VI 339; B. See p. 43		
B.466.470		As.	H 19:30 H 20:29 H 20:30		Houses IVa Houses Vb Houses Vb	L. Agade ED III ED III	As.32:P.33. See pp. 96, 110, 111 As.33:201 As.33:179		
B.475.250a		As.	M 33:5		Below Ibiqadad II	E. Larsa	As.31:P.91; B. See p. 117		
B.475.250b		As.	M 23, sounding			Larsa	As.30:P.59. See p. 117		
B.485.220	72c	Kh.	P 43:23	89	Houses 6	ED II	See p. 82		
B.486.220	72h	Kh.	P 43:23	89	Houses 6	ED II	See p. 82		
B.493.253	22f	Kh.	Q 42:26		Sin III	Protolit.c	Kh.VI 331; B. See p. 40		
B.493.653		As.	K 19?			Agade or later	As.34:162. See p. 110		
B.494.560		Kh.	L 43:9				See B.514.570		
B.494.570		Kh.	J 42:2		Houses 4	ED II	Kh.III 1076	Kish Telloh Assur	"A," Pl. LIV 7 G I, Pl. XII 1295 Pl. 26, Ass. 21617 e

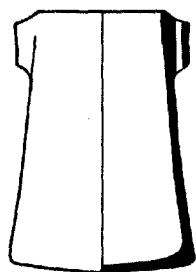

B.306.503

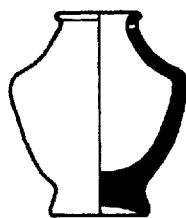

B.445.350

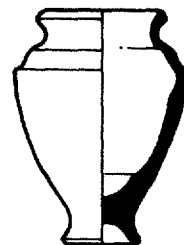

B.468.470

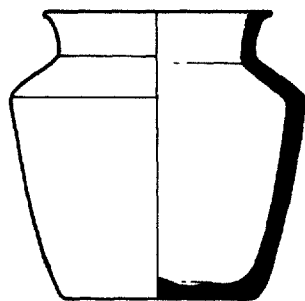

B.414.270

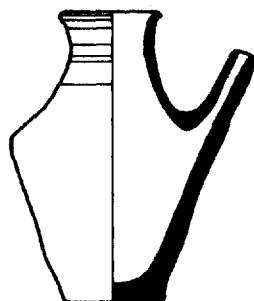

B.446.262

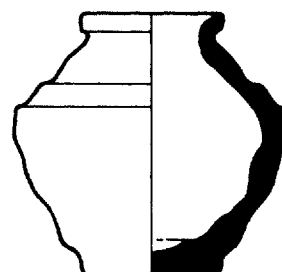

B.475.250a

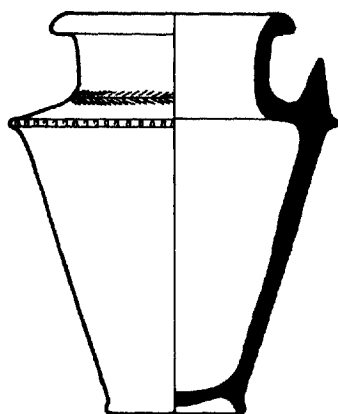

B.416.371

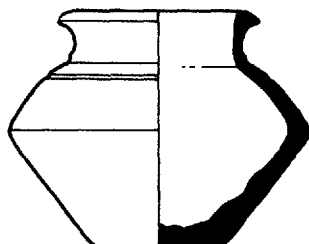

B.454.270

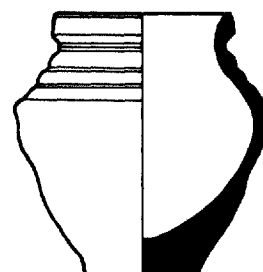

B.475.250b

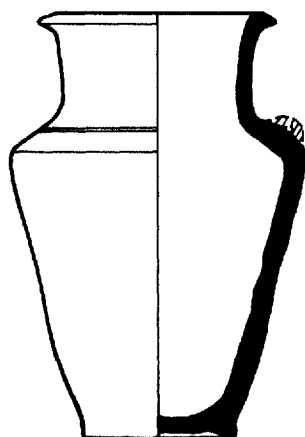

B.416.373

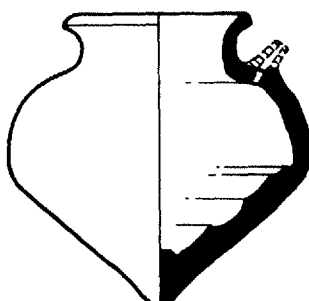

B.454.642

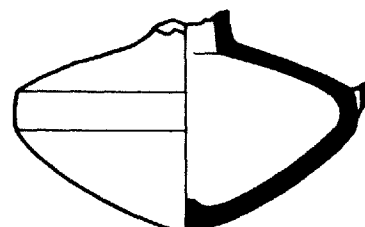

B.493.663

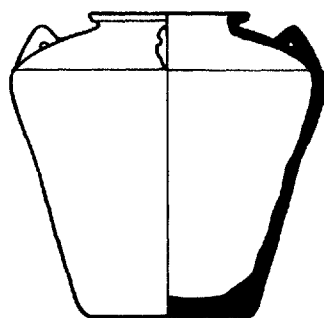

B.455.253

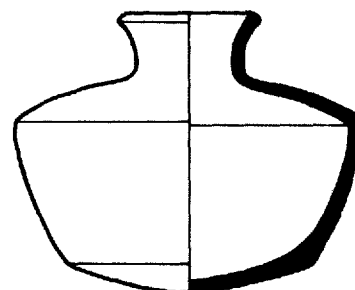

B.494.570

B.495-B.515

Form	Photo on Plate	Site	Square, Locus, or Area	Grave	Building or Level	Date of Find-Spot	Remarks	Comparanda	
								Site	Reference
B.495.220	73h	Kh.	N 43:21	96	Houses 5	ED II	See p. 81		
B.505.250	110i	As.	D 16		35.00 m.	Protoimp.	As.32:783; B. See pp. 105, 106, 110, 117		
			E 17		34.50 m.	Protoimp.?			
B.505.270a		As.	Q 33:18		Below Ibiqadad II	E. Larsa	As.31:P.23; C. See pp. 117, 118		
B.505.270b		Ish.	R 29:1		Kititum I or II	Larsa	Ish.P.65. See p. 117		
B.505.571	100c	As.	E 17:8		Earlier N. Palace	ED III	As.33:69. See pp. 87, 95		
B.506.270a		Ish.	R 29:1		Kititum II	L. Larsa	Ish.P.41. See p. 117		
B.506.270b		Ish.	R 29:1		Kititum II	L. Larsa	Ish.P.42. See p. 117		
B.506.270c		Ish.	R 29:1		Kititum II	L. Larsa	Ish.P.43. See p. 117		
B.506.370		Ish.	R 29:1		Kititum II	L. Larsa	Ish.P.40. See p. 117		
B.513.170	18c	Kh.	P 42:50		(Sin II)	Protolit.c	Kh.VII 28; C. See p. 36	Jamdat Nasr Farah al- ^c Ubaid	Mackay, Pl. LXV 23 (plain) Fara, Fig. 29 Type XXXIX
B.514.270		Kh.	P 43:40?		Houses 11?	ED I?			
B.514.373	100j	Kh.	L 43:10		Oval III	ED III or Protoimp.	Kh.I 477. See pp. 95, 98; published in OIP LIII as B.515.373		
B.514.560		Kh.	P 43:54		Houses 12	Protolit.d	Kh.IX 50; P		
B.514.570		Kh.	R 43:2		Houses 2 or 1	ED III	Kh.IV 401. See p. 99; published in OIP LVIII as found in Sin X		
			L 43:9*		Oval II	ED III	Kh.I 409. Published in OIP LIII as B.494.560		
	102e		Q 43, robbers' hole			ED III	Kh.II P.5. See p. 99		
B.514.572		Kh.	P 43:28	108	Houses 4	ED II	See p. 99		
B.515.220	98g	Kh.	O 43:3	133	Houses 3	ED III	See pp. 95, 142		
			O 43:43	52	Houses 11	ED I	See p. 59		
B.515.363	100g	Kh.	M 51		Houses 2?	ED III?	Kh.IX 90; B. See pp. 98, 143		
B.515.373		Kh.	Mound A L 43:10			ED III?	See p. 98 See B.514.373		
B.515.470		As.	E 15:16		Earlier N. Palace	ED III	As.32:1130		

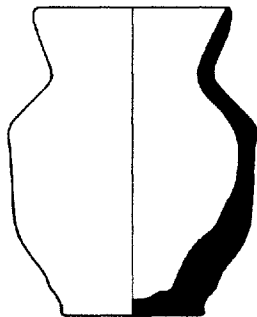

B.495.220

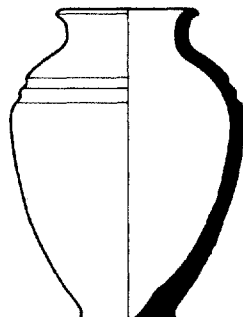

B.506.270*b*

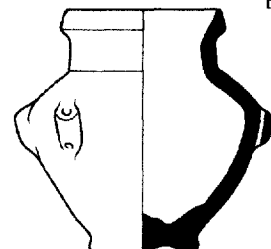

B.514.373

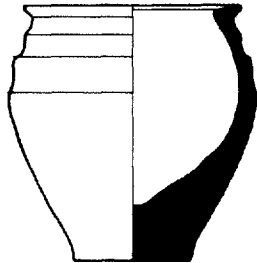

B.505.250

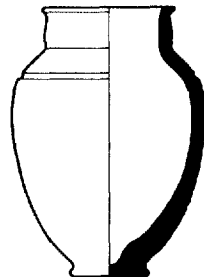

B.506.270*c*

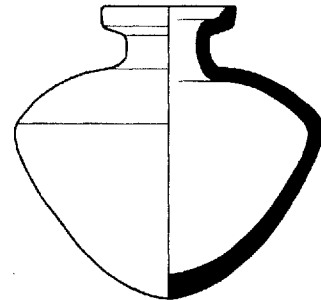

B.514.570

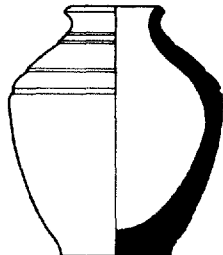

B.505.270*a*

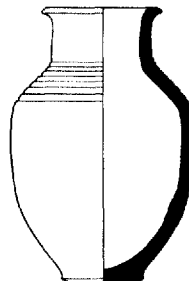

B.506.370

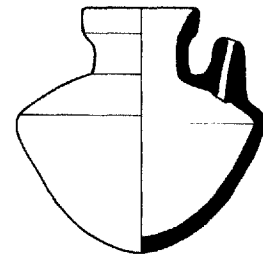

B.514.572

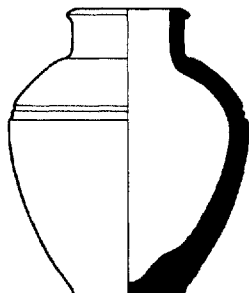

B.505.270*b*

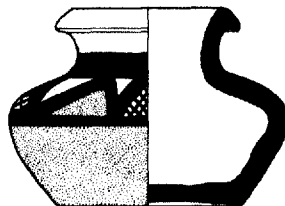

B.513.170

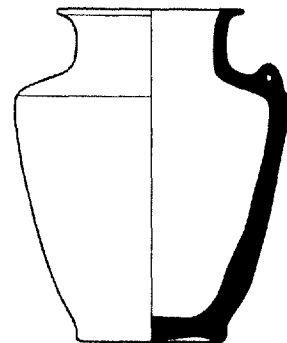

B.515.373

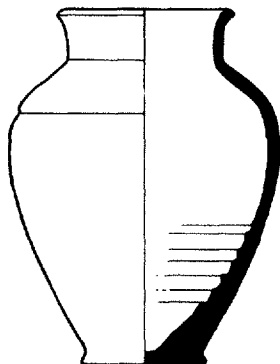

B.506.270*a*

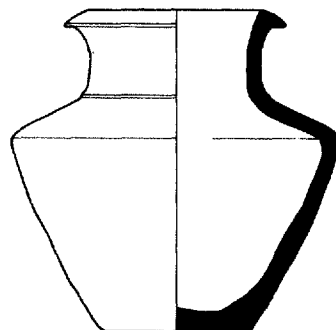

B.514.270

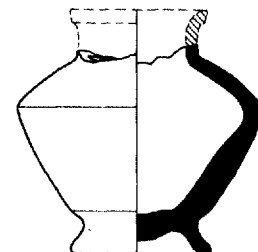

B.515.470

B.516-B.527

Form	Photo on Plate	Site	Square, Locus, or Area	Grave	Building or Level	Date of Find-Spot	Remarks	Comparanda	
								Site	Reference
B.516.263		Kh.	O 43:22		Houses 8	ED I	Kh.V 171	Jamdat Nasr	Mackay, Pl. LXV 30
B.516.270.		Kh.	O 43:14 P 43:32 P 43:53	109 81	Houses 4 Houses 8 Houses 8	ED II ED I ED I	Kh.V 203 Kh.V 172. See p. 59 Kh.IX 231; P		
B.516.271	107b	Kh.	L 43:3		Oval I or II	ED III	Kh.I 531; C. See pp. 87, 103		
B.516.273	23/	Kh.	Q 42:24		Sin IV	Protoimp.	Kh.VI 337. See pp. 42, 57		
B.516.371a	100a	Kh.	K 42:17	130	Houses 3	ED III	Kh.III 1282; C. See p. 87		
B.516.371b		Kh.	P 42:2, robbers' hole			ED III	Kh.III 324; B. See p. 87		
	100d		K 43:3*		Oval III	ED III or Protoimp.	Kh.I 402. See p. 87; published in OIP LIII as C.516.371		
B.516.371c		Kh.	O 45, robbers' hole			ED III	Kh.I 251. See p. 87		
B.516.471a		Kh.	P 47:1 P 45:14		Houses 2 Houses 2	ED III ED III	Kh.III 34 Kh.III 989		
B.516.471b	100b	Kh.	P 46:5		Houses 2	ED III	Kh.III 832; C. See p. 87		
B.516.473		As.	E 14:8		N. Palace	Protoimp.	As.32:1300. See p. 106		
B.524.270	65:32	Ag.	Hill B		Top layer	ED I	Ag.36:561; C. See p. 79		
B.524.271	65:71	Ag.	Hill B		Top layer	ED I	Ag.36:564; B. See pp. 60, 79		
B.524.570		Kh.	J 43:2 K 43:7		Houses 3 Houses 4	ED III ED II	Kh.III 1349 Kh.III 1350		
B.525.220	72f	Kh.	P 43:23 O 43:3	91 133	Houses 6 Houses 3	ED II ED III	See p. 82 2 specimens		
B.525.270		Kh.	O 43:18	72	Houses 9	ED I	See p. 59		
B.525.322		Ag.	M 14:4		31.50 m.	ED II	Ag.35:986		
B.525.670		Kh.	J 42:5 J 43:2		Houses 4 Houses 3	ED II ED III	Kh.III 1322 Kh.III 1348		
B.526.260		As.	L 31 H 18:26		Bilalama Houses IV	E. Larsa Agade	As.30:P.58; C. See p. 117 See p. 110		
B.526.270	72i	Kh.	P 43:23	91	Houses 6	ED II	See p. 82		
B.526.273		As.	D 17:32		Archaic Shrine III	ED I	As.34:72. See p. 58		
B.526.360	65:73	Ag.	Hill B		Top layer	ED I	Ag.36:560; B. See p. 79		
B.526.471		As.	E 16:16		N. Palace	Protoimp.	As.32:P.32; C. See pp. 105, 106		
B.527.340	121a	As.	N 31:5			L. Larsa	As.30:P.54; C. See pp. 111, 116, 123 3 specimens		
			D 16:9 H 18:21 K 19:3		36.25 m. Houses IVa Houses IVa	Agade L. Agade L. Agade			
B.527.380		As.	P 32:6			L. Larsa	As.31:P.31. See p. 117		
B.527.462		As.	W. of P 32:1 M 34*			L. Larsa	As.31:P.14a. See p. 117		
						L. Larsa	As.31:P.14b		

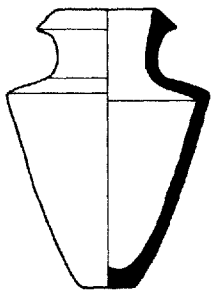

B.516.270

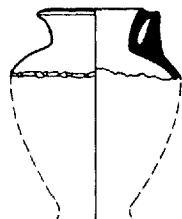

B.516.371c

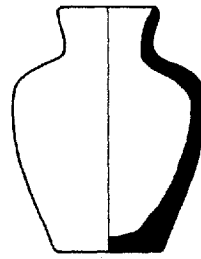

B.525.220

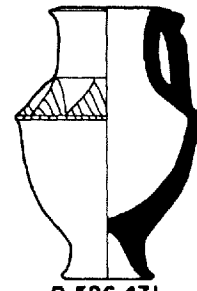

B.526.471

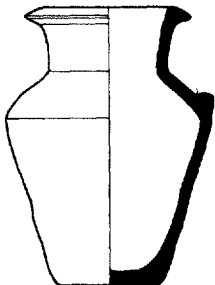

B.516.271

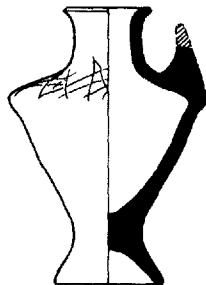

B.516.471a

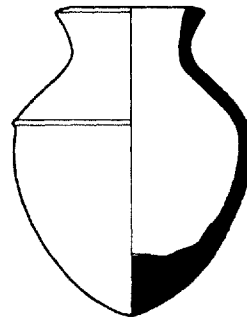

B.525.670

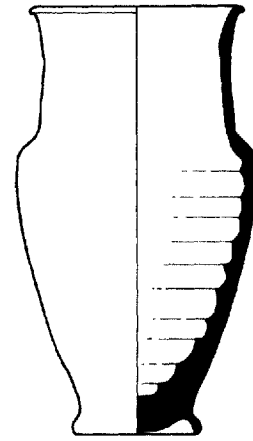

B.527.340

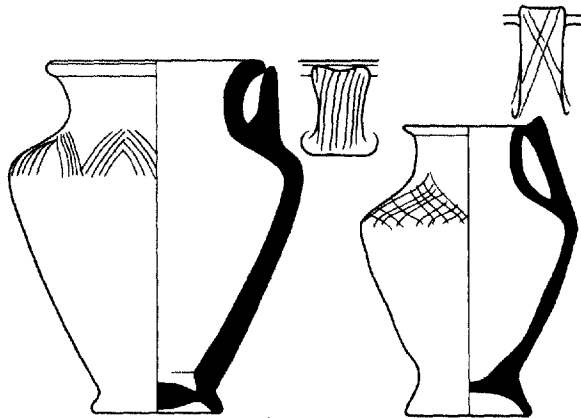

B.516.371a

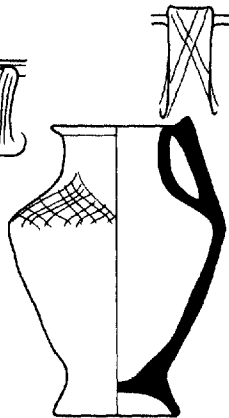

B.516.471b

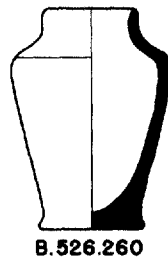

B.526.260

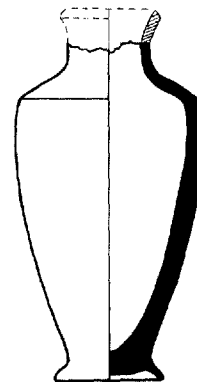

B.527.360

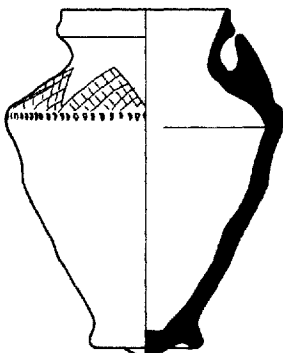

B.516.371b

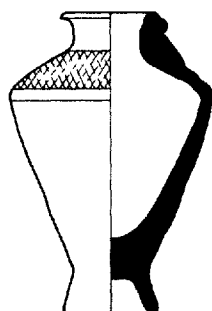

B.516.473

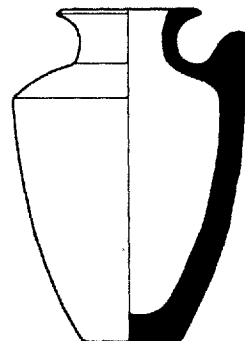

B.526.273

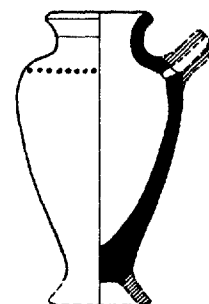

B.527.462

B.533-B.536

Form	Photo on Plate	Site	Square, Locus, or Area	Grave	Building or Level	Date of Find-Spot	Remarks	Comparanda	
								Site	Reference
B.533.230	38f, 65:12	Ag.	L 13:9		32.00 m.	ED II	Ag.36:563; C. See pp. 53, 78		
B.533.252		Ag.	Hill B		Top layer	ED I			
B.533.262		Kh.	P 42:50	8	32.70 m.	Protolit.c	Kh.VII 44; B. See p. 37	Jamdat Nasr	Mackay, Pl. LXIII 10 (curved spout)
B.534.220	98f	Kh.	N 44:7	131	Houses 3	ED III	See pp. 95, 142	Kish	"A," Pl. XV 26
B.534.520		Kh.	N 44:5 O 43:3	119 133	Houses 4 Houses 3	ED II ED III	Black paste		
B.535.220		As.	M 27:1 F 17:5 G 18:6		N. Palace Houses IVa	Larsa Protoimp. L. Agade	As.31:P.82a; B. See p. 116 As.31:P.82b; C See p. 110		
	73a 72a	Kh.	N 43:12 O 43:23	116	Houses 4 Houses 6	ED II ED II	See p. 82 See p. 82		
B.535.221		Kh.	K 42:13	124	Houses 3	ED III	Kh.III 1405		
B.535.223		Kh.	O 44:19 K 42:13	124	Houses 3 Houses 3	ED III ED III	Cf. B.575.223 Kh.III 1406		
B.535.240	98j	Kh.	O 43:6	137	Houses 3	ED III	See pp. 95, 142		
B.535.320		Kh.	P 43:45	65	Houses 10	ED I		Kish al-Ubaid	"A," Pl. LIII 5 Type LXXIII
B.535.610	102b	Kh.	K 42:13	124	Houses 3	ED III	Kh.III 1376; C. See pp. 99, 143		
B.536.220	73d	Kh.	N 43:12 N 44:14	116 92	Houses 4 Houses 6	ED II ED II	See p. 82		
B.536.224	113i	As.	H 18:7		Houses IVa or III	L. Agade or Gutium-Ur III	As.31:P.114; C. See pp. 110, 113		
B.536.240a		As.	J 20:5 P 30:1		Houses III Ibalpiel I well	Gutium-Ur III L. Larsa	As.32:461 As.30:P.52; C. See pp. 117, 118		
B.536.240b		As.	J 19:35		Houses III	Gutium-Ur III	As.32:P.16. See p. 113		
B.536.270		As.	L 30?			Larsa	As.30:P.10; B. See pp. 116-17		
B.536.520		Kh.	P 43:27	87	Houses 6	ED II			

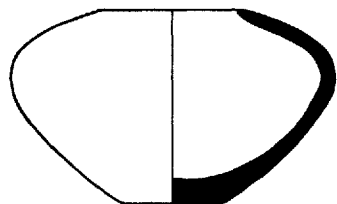

B.533.230

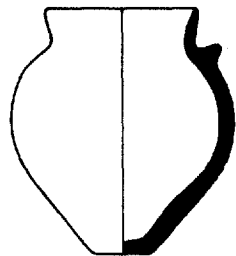

B.535.223

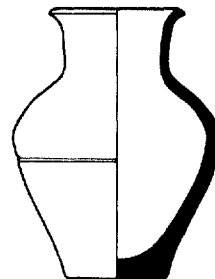

B.536.240a

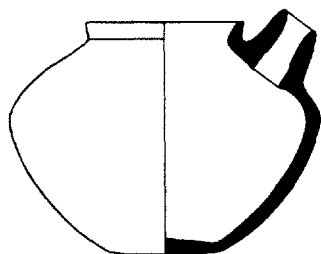

B.533.252

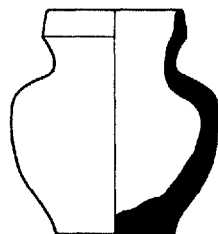

B.535.240

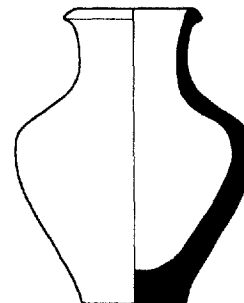

B.536.240b

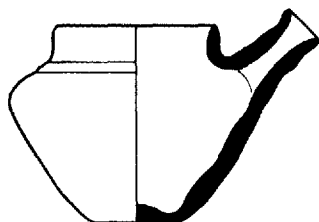

B.533.262

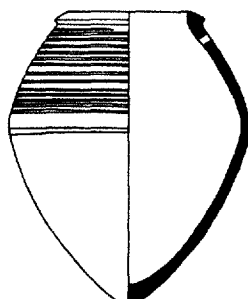

B.535.610

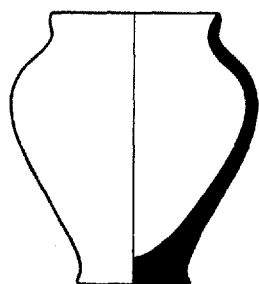

B.535.220

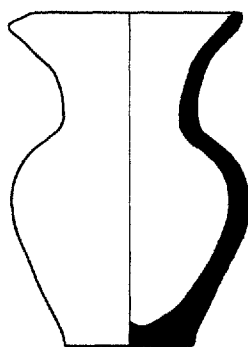

B.536.224

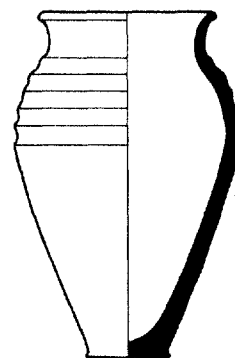

B.536.270

B.543-B.545

Form	Photo on Plate	Site	Square, Locus, or Area	Grave	Building or Level	Date of Find-Spot	Remarks	Comparanda	
								Site	Reference
B.543.520		As.	G 19:6 H 18:14		Houses IVa Houses IVb	L. Agade E. Agade	As.31:P.33; C. See pp. 110, 111 As.31:P.43b; C. Handmade, red-buff; narrow neck; 88 mm. d. x 55 h.	Ur	RC, Type 41b
B.544.222	18h	Kh.	P 43:60		Below Houses 12	Protolit.c	Kh.IX 129; B. See p. 37		
B.544.240		Kh.	P 43:54	1	31.95 m.	Protolit.c	Kh.IX 155; P. Disk base, overhanging rim, purple-red paint on rim and neck, cross-hatched design on shoulder		
B.544.520		Kh.	P 45:14		Houses 2	ED III	Kh.III 988. Cf. B.543.520; hole near base		
B.544.521		Kh.	P 43:54		Below Houses 12	Protolit.c	Kh.IX 224; B. See p. 38		
B.544.540		As.	H 18:8		Houses IVa-II	Agade or later	As.31:P.100; C. See pp. 110, 111	Shaghir Bazar	Iraq III, Fig. 12:4 and 10
B.544.541	50f	Kh.	O 43:20		Houses 7	ED I	Kh.V 168; B. See p. 60		
B.544.560	102d	Kh.	N 44:6 O 43:3	103 133	Houses 5 Houses 3	ED II ED III	Kh.V 251 See p. 99		
B.544.570		Kh.	Q 44:9		Houses 1	ED III	Kh.III 75. See p. 99	Kish	"A," Pl. XVI 6
B.545.220a	73b	Kh.	N 43:15 P 43:28	113 108	Houses 4 Houses 4	ED II ED II	See p. 82	Telloh Ur	G II, Pl. XXXII 3553 RC, Type 137
B.545.220b		As.	G 18:4		Houses IV	Agade	As.31:P.170a (B), b (C). See p. 110		
B.545.220c		Kh.	N 43:15		Houses 4	ED II			
		As.	N 30			Larsa	As.30:P.42a; B. See pp. 117, 118		
			N. of L 31:3 M 32:15 N 30:2 O 28:8 O 30:10 O 30:17		2 m. below surf. Surf. Above Bilalama	Larsa E. Larsa Larsa L. Larsa E. Larsa E. Larsa	As.30:P.42d; C As.30:P.42b; C As.30:P.7 As.30:P.42c; C Several specimens		
		Kh.	O 30:20 P 31:1 K 42:13 N 43:12 N 43:22 N 44:6 N 44:7 O 43:14 P 43:28 P 43:33 P 43:42	123 116 107 110 131 125 108 71 31	Houses 3 Houses 4 Houses 5 Houses 4 Houses 3 Houses 3 Houses 4 Houses 9 Houses 11	E. Larsa E. Larsa ED III ED II ED II ED III ED III ED II ED I ED I	Kh.III 1411 2 specimens 2(?) specimens. See pp. 95, 142 See pp. 95, 142 2 specimens; see p. 59		
B.545.222a	113f	As.	S. of J 20:4 D 17:19 H 18:2*		Houses III Houses III?	Gutium-Ur III Protoimp.? Gutium-Ur III?	As.32:P.42; C. See p. 113 As.31:P.107b; C. Thin walls; broken		
B.545.222b		As.	K 19:7		Houses III or II	Gutium-Ur III	As.32:P.15. See p. 113		
B.545.240a	72j	Kh.	P 42:9	97	Houses 5	ED II	See p. 82	Farah	Fara, Fig. 35, F 134
B.545.240b		Kh.	P 43:27 O 43:55 P 43:45	87 18 36	Houses 6 Houses 12 Houses 11	ED II Protolit.d ED I	Kh.IX 225; P See p. 59		
B.545.240c	107c	As.	N 33 E 16:5 N 30:2		Ibiquadad II Houses above N. Palace Below Bilalama	L. Larsa Larsa? Gutium-Ur III or E. Larsa	As.31:P.72a; C. See pp. 103, 117 As.31:P.72b; B	al-Ubaid	Type LXXIII

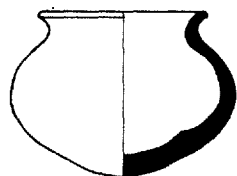

B.543.520

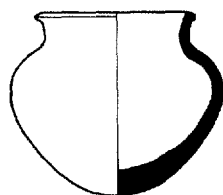

B.544.540

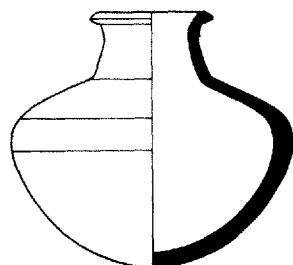

B.544.570

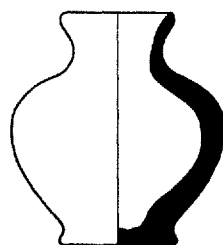

B.545.220 *a*

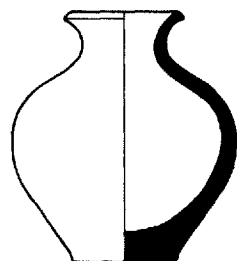

B.545.220 *b*

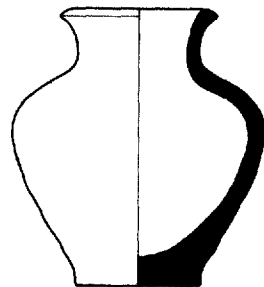

B.545.220 *c*

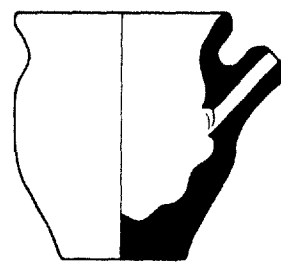

B.545.222 *a*

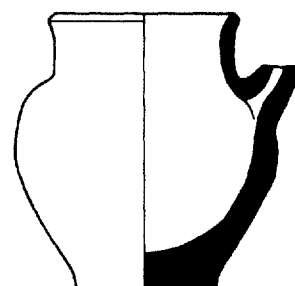

B.545.222 *b*

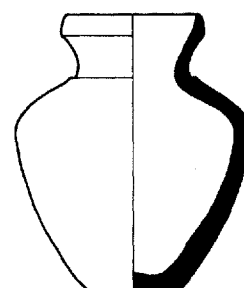

B.545.240 *a*

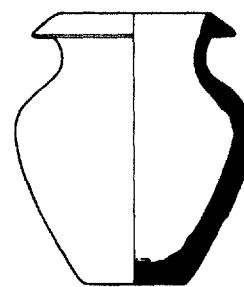

B.545.240 *b*

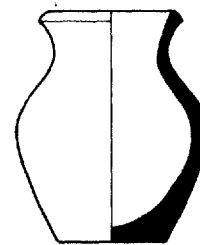

B.545.240 *c*

B. 545-B. 547

Form	Photo on Plate	Site	Square, Locus, or Area	Grave	Building or Level	Date of Find-Spot	Remarks	Comparanda	
								Site	Reference
B. 545.5-1		Kh.	P 44:14		Houses 1	ED III	Kh.III 826. Wheel-incised lines on shoulder		
B. 545.520		Kh.	O 43:43	47	Houses 11	ED I			
B. 545.540	102f 74m	Kh.	O 43:14 N 43:21 P 43:23	125 96 89	Houses 3 Houses 5 Houses 6	ED III ED II ED II	Kh.V 69. See p. 99 See p. 83; red paste		
B. 545.640a	102c	Kh.	P 44:12 O 43:23	104	Houses 2 Houses 5	ED III ED II	Kh.III 873; C. See p. 99 No perforations		
B. 545.640b		Kh.	N 43:15		Houses 3	ED III	Kh.III 1095. See p. 99		
B. 546.122		Kh.	O 44:10		Houses 1	ED III	Kh.III 1191. See p. 91		
B. 546.220	72d 72g	Ish. Kh.	Q 30:6 P 43:23 P 43:33 P 43:59	89 91 83 24	Kititum I or II Houses 6 Houses 6 Houses 7? Houses 12	Larsa ED II ED II ED I Protolit.d	Ish.P.57. See p. 117 3 specimens. See p. 82 See p. 82 Red paste; no angle between neck and body		
B. 546.222		As.	H 18:7		Houses IVa or III	L. Agade or Gutium-Ur III	As.31:P.116a. See p. 113		
B. 546.223		As.	D 17:33		Earliest Shrine	Protolit.d	As.34:245. See p. 42		
B. 546.240		As. Ish.	O 31:4 V 32:4		Houses	L. Larsa L. Larsa or Old Bab.	As.30:P.34; C. See pp. 117, 123 Ish.P.31		
B. 546.242	19h	Kh.	Q 42:26		Sin III	Protolit.c	Kh.VI 330; B. See pp. 37-38, 44, 46, 127		
B. 546.260		Ish.	R 30:1		Kititum III	L. Larsa	Ish.P.4. See p. 117		
B. 546.322		As.	E 16:18		N. Palace	Protoimp.	As.32:P.25. See p. 106		
B. 546.370		Ish.	R 30:1		Kititum III	L. Larsa	Ish.P.21. See p. 117		
B. 546.520	73j	Kh.	N 44:11 P 43:27	101 88	Houses 5 Houses 6	ED II ED II	See p. 82 2(?) specimens		
B. 546.620	73k	Kh.	N 43:20	99	Houses 5	ED II	See p. 82		
B. 546.640a		Kh.	P 45:14 R 44*	165	Houses 2 Above Houses 2	ED III ED III	Kh.III 871; B. See p. 99	Shaghir Bazar	Iraq III, Fig. 11:1
B. 546.640b		As.	E 16:2 G 19:4		N. Palace Houses IVa	Protoimp. L. Agade	As.31:P.64; C. See p. 107 See p. 111	Kish	"A," Pl. LIII 40
B. 546.640c		As.	J 19:50		Houses Vc	ED III	As.33:288. See p. 99		
B. 546.720	132e	Kh.	g 65			Old Bab.	Kh.VIII 107; B. See p. 123		
B. 547.320		Kh.	r 80			Old Bab.	Kh.VIII 217; B. See p. 123		

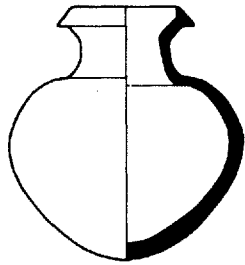

B.545.540

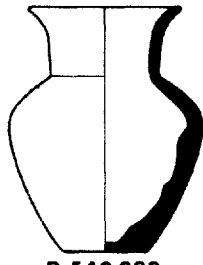

B.546.220

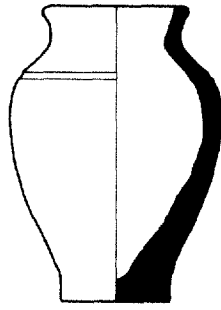

B.546.260

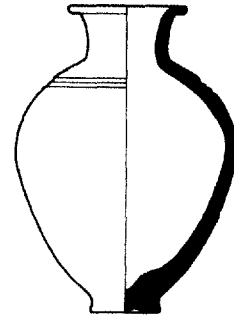

B.546.370

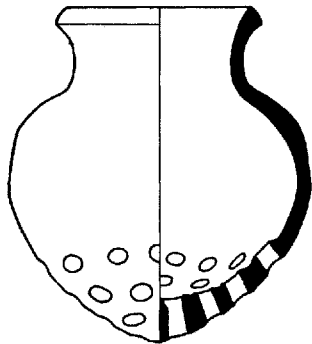

B.545.640a

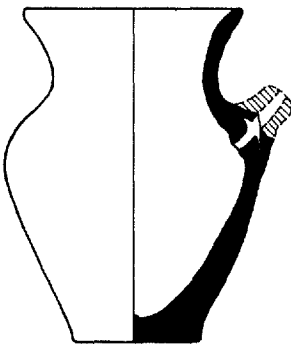

B.546.222

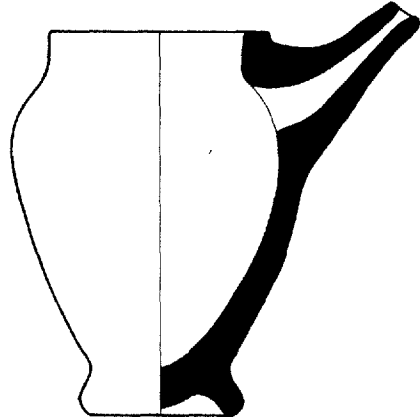

B.546.322

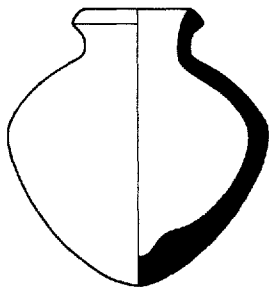

B.545.640b

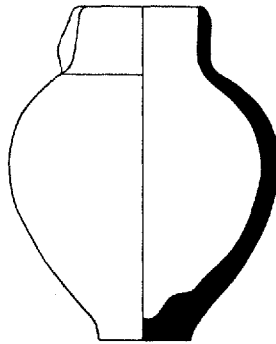

B.546.223

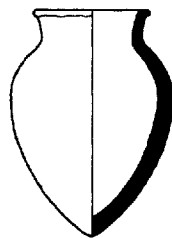

B.546.640a

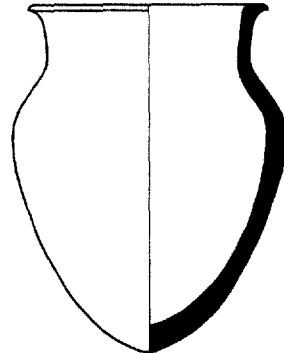

B.546.640c

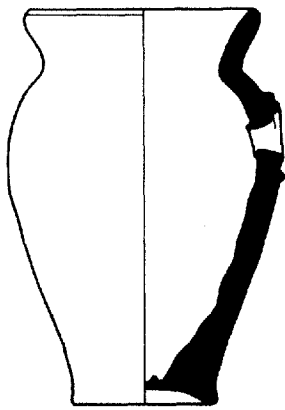

B.546.122

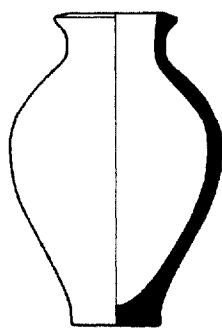

B.546.240

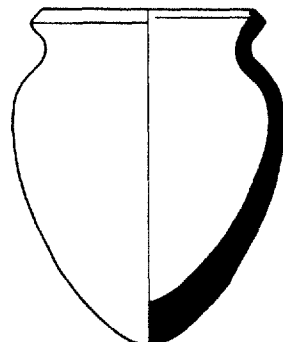

B.546.640b

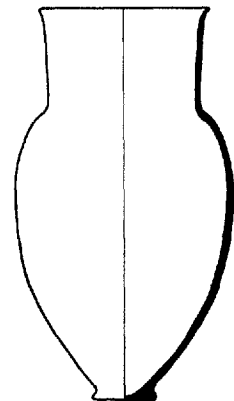

B.547.320

B.555-B.566

Form	Photo on Plate	Site	Square, Locus, or Area	Grave	Building or Level	Date of Find-Spot	Remarks	Comparanda	
								Site	Reference
B.555.220	98i	Kh.	P 42:9		Houses 3	ED III	See pp. 99, 142		
B.555.224	110f	As.	F 17:5		N. Palace	Protoimp.	As.32:444; B. See p. 106		
B.555.520		Kh.	J 42:2 F 29:1	126	Houses 3 or 2 Houses 2?	ED III ED III	Kh.III 733; B. See p. 99		
B.555.540a	102a	Kh.	R 45		Houses 1	ED III	Kh.I 20. See p. 99	Telloh	G II, Pl. XXX 2242
B.555.540b		As.	G 19:4 J 20:21		Houses IVa Houses Va	L. Agade Protoimp.	As.31:P.34; C. See p. 111 See p. 107		
B.556.220	73i	Kh.	N 43:12 N 44:6	116 103	Houses 4 Houses 5	ED II ED II	See p. 82		
	72e		N 44:14 P 43:23	92 89	Houses 6 Houses 6	ED II ED II			
B.556.222	110d	As.	J 21:9		Houses Va	Protoimp.	As.32:824. See p. 106		
B.556.420		Kh.	S 44:2		Houses 1 or above	ED III?	Kh.VIII 91; P		
B.556.422	98r	Kh.	Y 43		Houses 1 or above	ED III?	Kh.VIII 93; B. See p. 92		
B.556.471		As.	N 33		Ibiqadad II	L. Larsa	As.31:P.149. See pp. 117-18		
B.556.520		As.	D 17:29*		Archaic Shrine III	ED I	As.34:98		
	72/	Kh.	K 42:4 N 44:14	92	Houses 3 Houses 6	ED III ED II	Kh.IV 412 See p. 82		
B.556.540	113g	As.	J 21:1 K 28:2		Houses IVa	L. Agade Agade	As.32:650; B. See pp. 111, 113	Telloh Ur Nuzi Gaura.	S, Pl. 42:13; G II, Pl. XXX 3769 RC, Type 44 b Pl. 52 F-G Pl. LXIX 130
B.556.720		Kh.	r 80			Old Bab.	Kh.VIII 218; B. See pp. 123, 150 (n. 156)	Nuzi Nineveh	Pl. 78 B (with taller, more flaring neck) AAA XX, Pl. LXXIV 11
B.564.371	98o	Kh.	T 44:2		Houses 1 or above	ED III?	Kh.VIII 92; B. See p. 96		
B.566.560	72k	Kh.	P 43:23	91	Houses 6	ED II	See p. 82		
B.566.670		As.	H 20:9		Houses Va	Protoimp.	As.32:P.48. See p. 107		

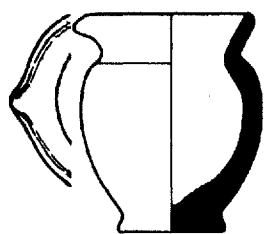

B.555.224

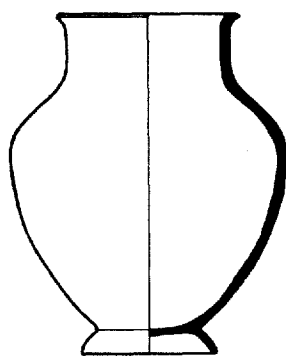

B.556.420

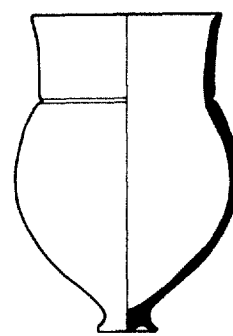

B.556.720

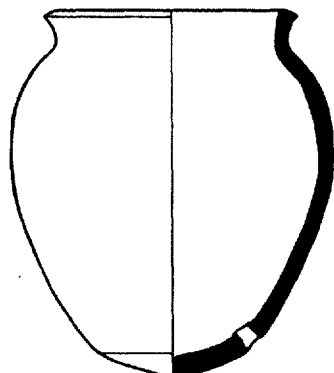

B.555.520

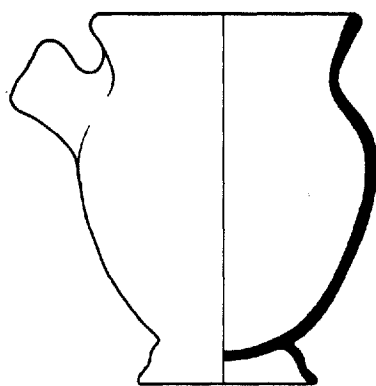

B.556.422

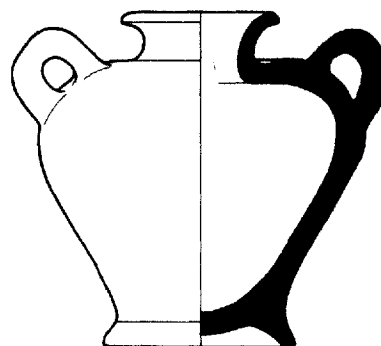

B.564.371

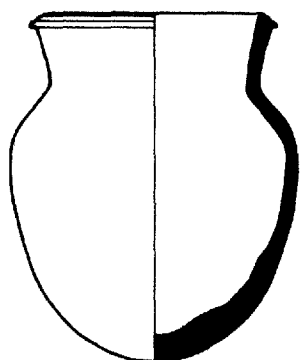

B.555.540a

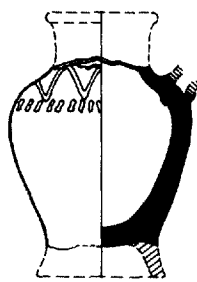

B.556.471

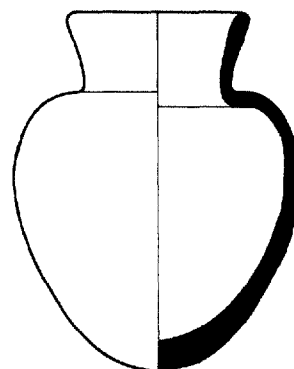

B.566.560

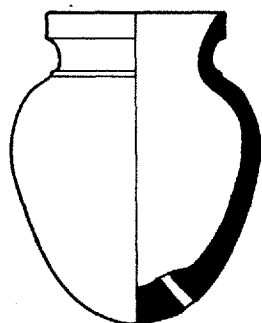

B.555.540b

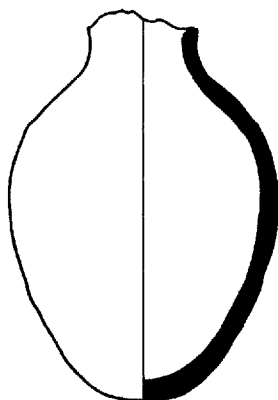

B.556.520

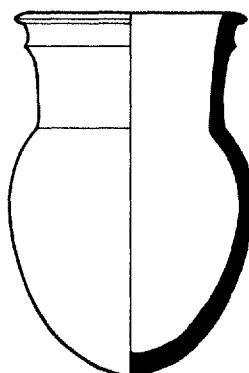

B.556.540

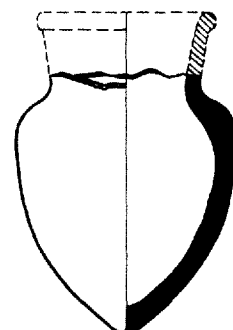

B.566.670

B.573-B.578

Form	Photo on Plate	Site	Square, Locus, or Area	Grave	Building or Level	Date of Find-Spot	Remarks	Comparanda	
								Site	Reference
B.573.220		Kh.	42:2		Houses 4	ED II	Kh. III 1152	Farah	Fara, Fig. 37, F 2788
B.573.240		As.	F 17:6 J 20:5		N. Palace Houses III	Protoimp. Gutium-Ur III	As.32:P.38. See pp. 106, 113 As.32:478		
B.574.220a		Kh.	L. 42:4		Houses 3	ED III	Kh.III 789. See p. 95	Ur al-CUbaid	RC, Type 122 Type XCII
B.574.220b		Kh.	O 41:1 K 42:4 K 42:9	167	Houses 3 or 2 Houses 3 Houses 2	ED III ED III ED III	Kh.III 280. See p. 95 Kh.IV 413 Kh.III 1030		
B.574.220c	98a	Kh.	K 43:3		Oval II	ED III	Kh.I 468a. See pp. 95, 142		
B.574.240		As.	G 18:1		Houses IV	Agade	As.31:P.46d; C. See pp. 110, 113		
	113j		H 18:4		Houses III or IVa	L. Agade?	As.31:P.46c; C		
B.575.220		Kh.	R 45	164	Above Houses 2	ED III	Kh.I 31g. See p. 95		
B.575.223	98h	Kh.	K 43:5		Oval II	ED III	Kh.I 456. See pp. 95, 142; cf. B.535.223		
			Q 49:1	117	Houses 4 or 3	ED II or III			
B.575.224		As.	E 16:1		Houses above N. Palace	Larsa?	As.31:P.2. See pp. 95, 106, 110	Farah	Fara, Fig. 38, F 2792
			D 17:17 E 15:2 E 15:18		N. Palace Earlier N. Palace	Protoimp.? Protoimp. ED III	As.32:1061		
			E 17 F 16:2 G 19:3 H 20:3 H 20:8 J 20:23 P 45:14		34.50 m. N. Palace Houses IVa Houses Va Houses Va Houses Va	Protoimp.? Protoimp. L. Agade Protoimp. Protoimp.			
B.575.225	98q	Kh.	Q 49:2 Q 49:2		Houses 2 Houses 2	ED III ED III	2 specimens Kh.III 962 Kh.IX 189; B. See p. 92 Kh.IX 188; P	Kish	"A," Pls. XV 15 and LII 32-34 (2 with convex bases)
								Farah Ur	Fara, Fig. 38, F 53 RC, Type 253 (no perforation, pointed base)
								al-CUbaid	Type XCIV (no perforation)
B.575.240		Kh.	K 42:5	168	Above Houses 2	ED III	Kh.III 621. See p. 95	Kish	"A," Pl. LIII 4
B.576.220	72b 98c	Kh.	L 42:5 N 44:6 O 43:3	94 133	Houses 3 Houses 6 Houses 3	ED III ED II ED III	Kh.III 1326 See p. 82 See pp. 95, 142 As. 32:859		
		As.	Below E 15:1*		Earlier N. Palace	ED III			
B.576.221		As.	F 17:8		N. Palace	Protoimp.	As.32:P.35. See p. 106		
B.576.224	110e	As.	E 16:18		N. Palace	Protoimp.	As.32:P.34. See p. 106		
B.576.720a	132a	Kh.	n 74-75, trench			Old Bab.	Kh.VIII 75; P. See p. 123		
B.576.720b	132c	Kh.	n 74-75, trench			Old Bab.	Kh.VIII 100; B. See pp. 123, 150 (n. 156)	Nuzi	Pl. 78 B-C (foot more elaborate)

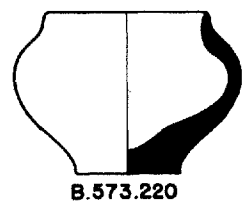

B.573.220

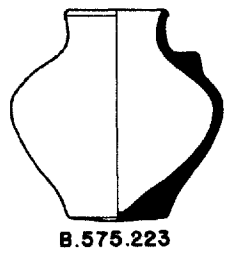

B.575.223

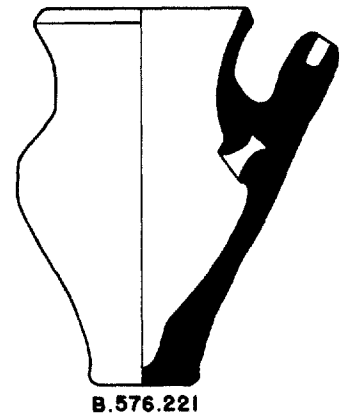

B.576.221

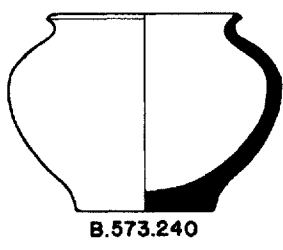

B.573.240

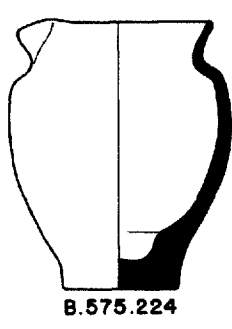

B.575.224



B.574.220a

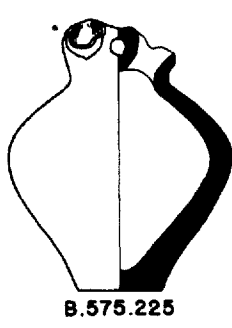

B.575.225

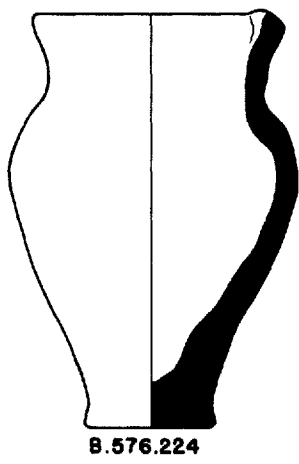

B.576.224

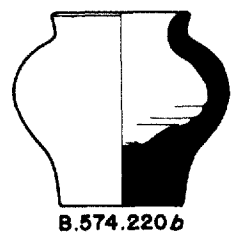

B.574.220b

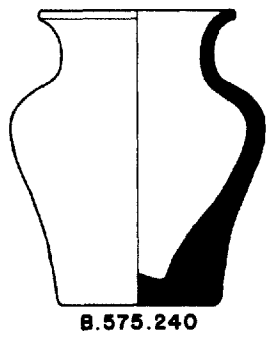

B.575.240

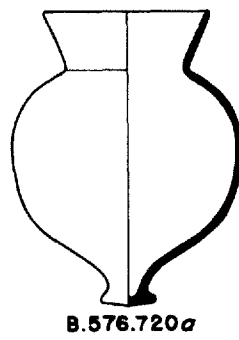

B.576.720a

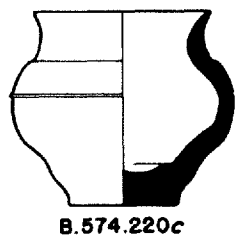

B.574.220c

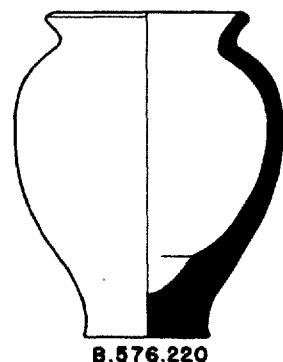

B.576.220

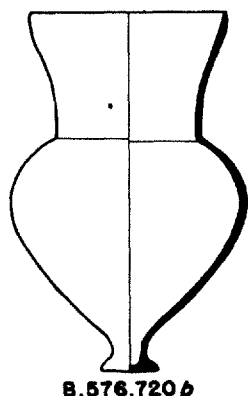

B.576.720b

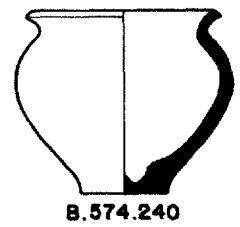

B.574.240

Form	Photo on Plate	Site	Square, Locus, or Area	Grave	Building or Level	Date of Find-Spot	Remarks	Comparanda	
								Site	Reference
B.577.420		As.	K 40		Surf.	L. Larsa?	As.33:712		
B.596.520		Kh.	K 42:4		Houses 3	ED III	Kh.IV 411		
B.601.230		Kh.	K 42:9		Houses 3	ED III	Kh.III 695. See p. 95		
B.601.530	74k	Kh.	M 43:3 L 42:7 L 43:1 L 43:1		Oval II Houses 3 Oval I Oval I	ED III ED III ED II ED II	Kh.III 5; B. See p. 95 Kh.III 1086 Kh.I 603b; B. See p. 83 Kh.I 603a; C		
B.603.240	23h	Kh.	P 42:23		(Sin III)	Protolit.c	Kh.VII 26; C. See p. 42	al- ^c Ubaid	Type XLVII
B.603.570		Kh.	J 43:2		Houses 3	ED III	Kh.III 1141		
B.604.270		Kh.	P 43:45	36	Houses 11	ED I	Kh.IX 127; P		
B.613.270	98n	Kh.	S 44		Houses 1 or above	ED III?	Kh.VIII 28. See p. 95		
B.625.260		Kh.	M 44:3		Oval II?	ED III?	Kh.III 439. From a burial		
B.625.521	50e	As.	D 17:29		Archaic Shrine III	ED I	As.34:99; C. See p. 60		
B.633.570a		As.	G 18:3*		Houses IVa	L. Agade	As.31:P.45a. See pp. 99, 107, 110		
			G 18:3* D 18:9		Houses IVa Outside N. Palace	L. Agade Protoimp.?			
			Below E 15:1 E. of F 19:1 G 19:6 Below H 18:5 H 20:13		Earlier N. Palace Houses IVa Houses IVa	ED III L. Agade L. Agade	 As.32:983 As.31:P.45b; C		
B.633.570b	111b	As.	J 19:6 K 20:1 P 43:7*		Houses III Houses III Houses 1	Gutium-Ur III Gutium-Ur III ED III	As.32:P.43. See pp. 99, 113 Kh.III 203	Gaura	Pl. LXIX 126
B.634.220		Kh.	P 42:23		(Sin III)	Protolit.c	Kh.VII 25		
B.634.570a		As.	J 19:64 Below H 20:29		Houses Vb Houses Vc	ED III ED III	As.32:1258. See p. 99	Kish	"A," Pl. XVI 28
B.634.570b		As.	J 21:23 H 20:35 J 19:64 K 19:23 K 20:12 K 20:12		Houses IVb Houses Vc Houses Vc Houses Va Houses Va Houses Va	E. Agade ED III ED III Protoimp. Protoimp. Protoimp.	As.33:122. See pp. 99, 107, 110 As.32:958	Kish	"A," Pl. XVI 28-29
B.634.570c	111a	As.	F 13?		Older town wall	ED III	As.34:89. See p. 99		
B.635.670a		Kh.	P 44:1		Above Houses 1 Houses 2?	ED III or Protoimp. ED III?	Kh.III 128. See pp. 99, 107		
B.635.670b		Kh.	E 29 Mound A		Near surf.	ED III or Protoimp.	See pp. 99, 107		
B.636.570	111c	As.	F 17:5		N. Palace	Protoimp.	As.32:P.12; B. See p. 107		
B.643.520		As.	D 15:3		22-21 m.	Protolit.d	See pp. 41, 75 and Pl. 63:77	Warka	UVB IV, Pl. 18 D f
B.644.220		As.	H 19:5		Houses IVb	E. Agade	As.31:P.125; C. See p. 110	Kish	"A," Pl. XV 16
B.644.322		As.	D 17:3		Single-Shrine	Protoimp.?	As.32:1363. Cf. B.545.222b; incised lines on shoulder		
B.644.520		As. Ag.	J 19:48 L 13:4*		Houses IVb 32.30 m.	E. Agade ED II	As.32:1309. See p. 111 Ag.36:279; B. Neck broken off; copper scraps inside		
B.644.540		As.	M 31:1			Larsa	As.31:P.90; C. See p. 115	Telloh	G II, Pl. XXXI 1359
B.644.720		Ish.	T 30:1 T 30:1 T 29:2		Kititum IV Kititum IV Kititum III	L. Larsa or Old Bab. L. Larsa or Old Bab. L. Larsa	Ish.P.10. See p. 116		



B.601.530

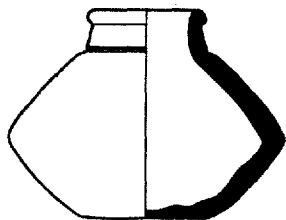

B.603.240

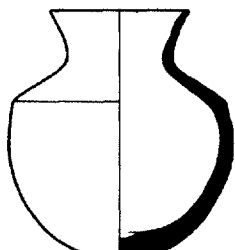

B.625.260

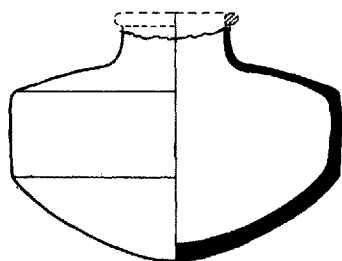

B.633.570*a*

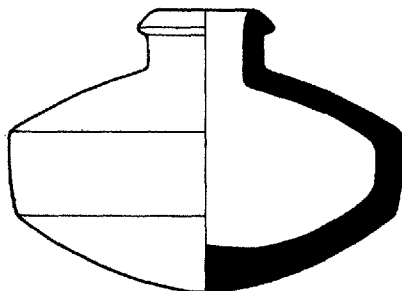

B.633.570*b*

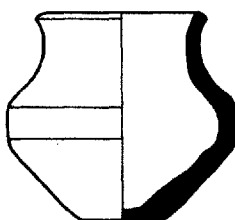

B.634.220

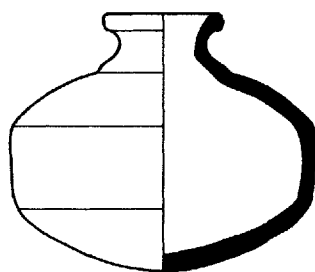

B.634.570*a*

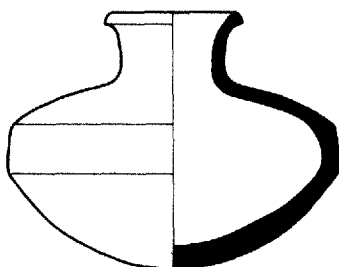

B.634.570*b*

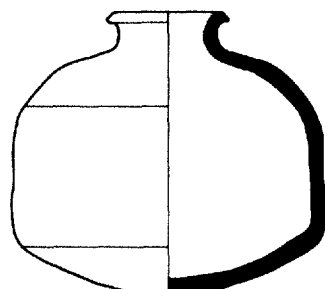

B.634.570*c*

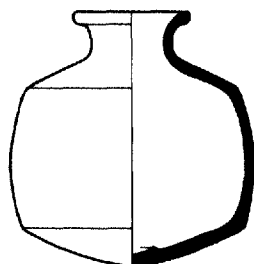

B.635.670*a*

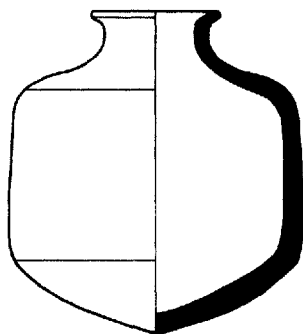

B.635.670*b*

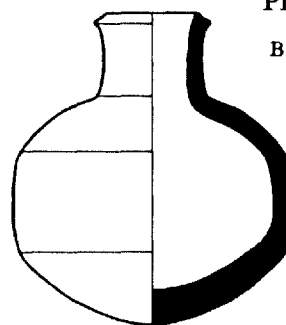

B.636.570

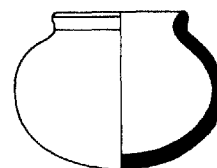

B.643.520

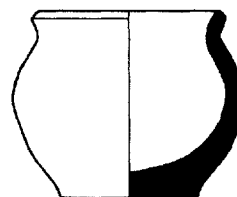

B.644.220

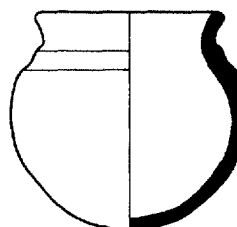

B.644.520

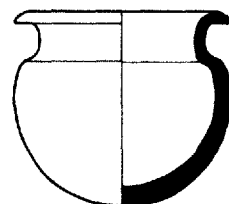

B.644.540

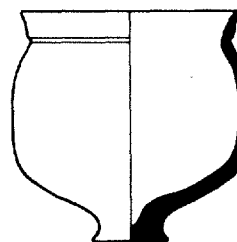

B.644.720

B.645-B.656

Form	Photo on Plate	Site	Square, Locus, or Area	Grave	Building or Level	Date of Find-Spot	Remarks	Comparanda	
								Site	Reference
B.645.220	110g	As.	F 15:9 E 15:20 E. of F 15:9 J 20:22		Street outside N. Palace Earlier N. Palace Surf. Houses Va	Protoimp. ED III	As.32:981. See p. 106 As.32:1002		
B.645.224		As. Kh.	J 20:8 P 45:14*		Houses IVa Houses 2	L. Agade ED III	As.32:P.68. See p. 110 Kh.III 995. See p. 95		
B.645.420		As.	J 20:12		Houses III	Gutium-Ur III	As.32:645		
B.645.540a		As.	M 32:11		Ituria	Ur III	As.31:P.110; B. See pp. 111, 113	Telloh Ur Nuzi Gaura Susa	S, Pl. 42:11; G II, Pls. XXXI 2403 and XXXIII 606 RC, Type 224 (larger) P. 52 F-G Pl. LXIX 130 Mém. XXV, Figs. 55:20 and 76:26; Antiquity V 336, Fig. 2 (lower right)
B.645.540b		Kh.	O 42:3	148	Above Houses 2	ED III	Kh.III 251; B. See p. 99; tightly fitting lid still in position	Telloh Ur	G II, Pls. XXX 2242 and XXXIII 988 RC, Type 48
B.646.224		Kh.	P 45:14		Houses 2	ED III	Kh.III 994		
B.646.340		Ish.	P 30:1		Kititum III or IV	L. Larsa	Ish.P.17. See p. 116	Warka Nuzi	UVB IX, Pl. 27 (right center) Pl. 51 AA
B.646.710		Ish.	R 29:7		Kititum III	L. Larsa	Ish.P.11. See p. 116		
B.647.240		Ish.	R 29:1		Kititum IV or above	L. Larsa or Old Bab.	Ish.P.6. See p. 123		
B.652.500		Ag.	L 13:9		32.00 m.	ED II		Abu Hatab	Fara, Fig. 64, F 2871
B.652.520	97m	Kh.	O 43:13		Houses 3?	ED III?	See p. 95		
B.653.240	18d	Kh.	P 42:50		(Sin II)	Protolit.c	Kh.VII 112; C. See Pl. 133b and pp. 36, 46, 127		
B.654.520		Kh.	P 42:20 P 43:51	20	Houses 10 Houses 12	ED I Protolit.d	See p. 41		
B.654.523		As.	H 18:26		Houses IVa	L. Agade	As.32:P.58. See p. 110		
B.655.212		As.	J 19:64		Houses Va	Protoimp.	As.32:1273		
B.655.520	103c	Kh.	L 43:3 S 42:1	144	Oval I or II Houses 2	ED III	Kh.I 532; C. See p. 100; contained beads	Abu Hatab Mari	Fara, Fig. 63, F 2863 Syria XIX, Pl. II 4
B.655.540a	103b	Kh.	K 43:3		Oval II	ED III	Kh.I 454c; B. See p. 100		
B.655.540b	112c	As.	E 17		Near N. Palace	Protoimp.	As.32:1128. See p. 107		
B.655.640	113f	As.	G 18:11		Houses IVb	E. Agade	As.31:P.119; C. See p. 111		
B.656.220	49e	Kh.	O 43:18	72	Houses 9	ED I	See p. 59		
B.656.320		As.	N 31:5 L 30			L. Larsa Larsa	As.30:P.9a; B As.30:P.9b; C. See pp. 117, 118		
B.656.520	121c	Kh.	K 42:4		Houses 3	ED III	Kh.IV 414		
B.656.720		Kh.	g 65			Old Bab.	Kh.VIII 109; B	Nuzi	Pl. 78 O (ridge inside, solid foot)
	132d		g 65			Old Bab.	Kh.VIII 108; P. See pp. 123, 150 (n. 156)	Susa	Mém. XXV, Fig. 75:9

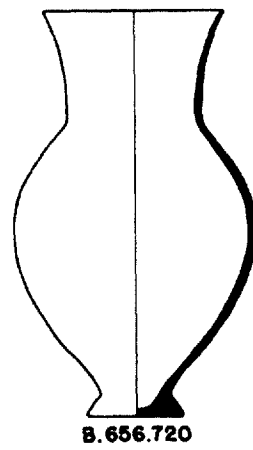
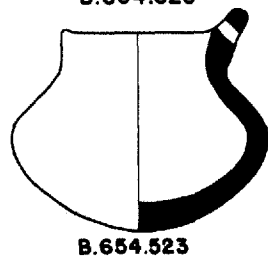
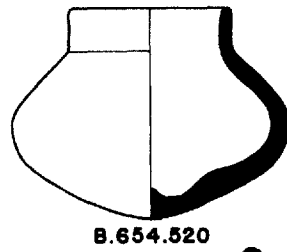
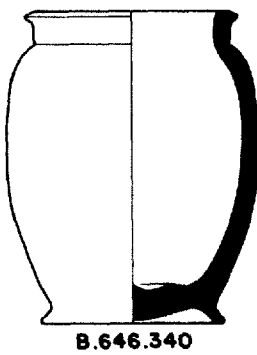
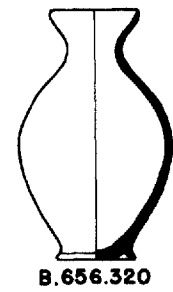
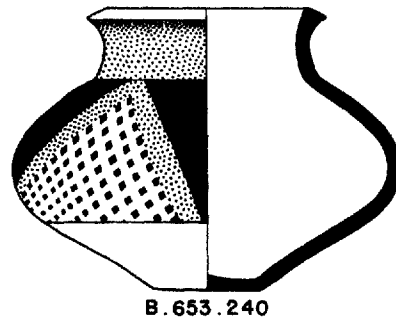
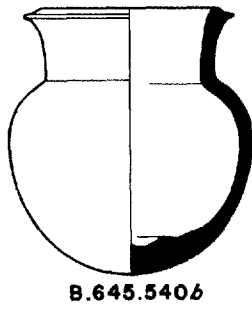
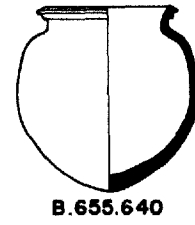
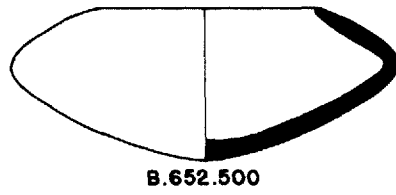
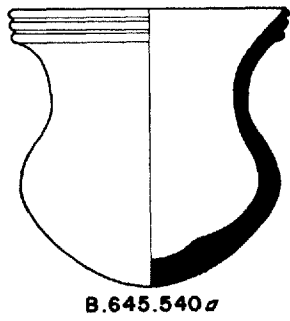
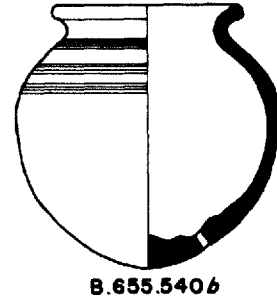
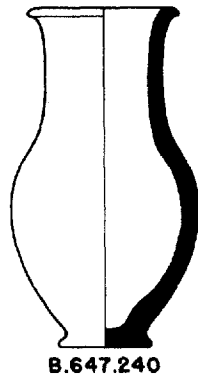
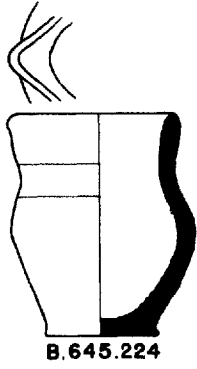
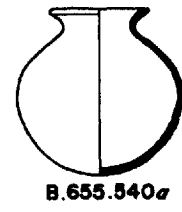
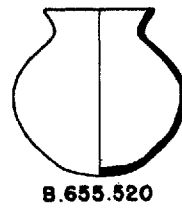
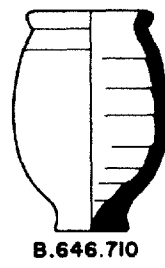
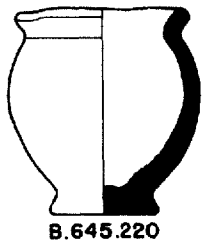

Form	Photo on Plate	Site	Square, Locus, or Area	Grave	Building or Level	Date of Find-Spot	Remarks	Comparanda	
								Site	Reference
B.663.213	22c	Ag.	M 15:5		32.00 m.	ED II	Ag.35:767; C. Protolit. survival; see pp. 39, 134	Jamdat Nasr Telloh Warka Nineveh Susa Mosta-gedda Badari	Mackay, Pl. LXIV 11-12 G I, Pls. 21:2 and 24:3 = Pl. V 4362 UVB IV, Pl. 19 D b AAA XIX, Pl. LXI 1; XX, Pl. LI 9 Mém. XIII, Pl. XXXII 2-3 and 7 (cf. Nos. 8 and 13-14 in stone); XXV Fig. 32:17 Pl. XXXV 24 Pl. XL 59 w G II, Pl. XXXII 2543
B.663.520	111h	As.	J 20:5 K 19:34		Houses II Houses Va	Gutium-Ur III Protoimp.	As.32:P.55. See pp. 107, 113 No ridge	Telloh	G II, Pl. XXXII 2543
B.663.540a		Kh.	P 42:15		Houses 7	ED I		Farah	Fara, Fig. 40, F 2799
B.663.540b	102g	Kh.	K 43:5 J 42:2		Oval II Houses 4	ED III ED II	Kh.I 455. See p. 99 Kh.III 1077	Ur al-C'Ubaid	RC, Types 50 a and 52 a Type XLIV
B.664.520a		Kh.	J 42:4		Houses 4	ED II	Kh.III 1270	Warka	UVB IV, Pl. 20 B b'; X, Pl. 25 e
B.664.520b		As.	D 17:32		Archaic Shrine III	ED I	As.34:95. See pp. 60, 138	Farah	Fara, Pl. 19 f; MJ XXII, Pl. XV 1
	70i		D 17:14		Archaic Shrine IV	ED I	As.33:610; C. No hole in shoulder	Susa	Mém. XIII, Pl. XXIX 4
	70g	Kh.	O 43:22		Houses 7?	ED I?			
	70h		Q 42:12		Sin VII	ED I			
B.664.520c		Kh.	O 43:15		Houses 6	ED II	Kh.V 206; B. See p. 81; wall thickness unknown because specimen unbroken		
	70f		O 43:16		Small Temple VI	ED II	Kh.V 161; C. Hole in shoulder; see p. 81		
B.664.540a	111d	As. Kh.	H 18:27 K 44:1* O 43:3*		Houses IVb Oval I Houses 2	E. Agade ED II ED III	As.32:866; B. See pp. 99, 110 Kh.III 1098. Neck missing Kh.III 467. Incised decoration on shoulder; neck missing	Gaura Susa	Pl. LXIX 125 Mém. XXV, Fig. 55:23
B.664.540b		As.	D 17:29		Archaic Shrine III	ED I	As.34:97	Jamdat Nasr	AJA XXXIX, Pl. XXXII 4-5
B.664.540c		As.	O 30:19 L 30:1 M 30:3 N 30:1*			Larsa Larsa Larsa Larsa	As.31:P.39a; C. See p. 117 As.31:P.39b; B 2 specimens; necks missing	Shaghir Bazar	Iraq IV, Fig. 17:20
B.664.570		As.	D 17:29		Archaic Shrine III	ED I	As.34:115. See p. 138	Jamdat Nasr Telloh	AJA XXXIX, Pl. XXXII 4-5 G I, Pl. XII 868
B.665.520		As. Kh.	J 21:23 O 43:15* P 43:33		Houses Va Houses 6 Houses 9	Protoimp. ED II ED I	As.33:336. See p. 107 Kh.V 204	Kish Mari	"A," Pl. LIII 45 Syria XVI 8, Fig. 3
B.665.540	74f	Kh.	N 44:6	74	Houses 6	ED II	See p. 83		
B.665.540a	113e 49f	As. Kh.	H 18:13 P 43:35	84	Houses IVb Houses 7	E. Agade ED I	As.31:P.128; C. See pp. 110-11 See p. 59	Ur	RC, Type 217
B.666.540b		Kh.	O 44:10		Houses 1	ED III	Kh.III 1192; B. See p. 99	Kish Ur	"A," Pl. LIII 53 RC, Type 106 b

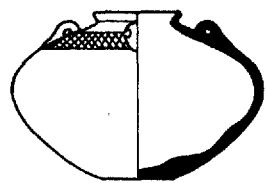

B.663.213

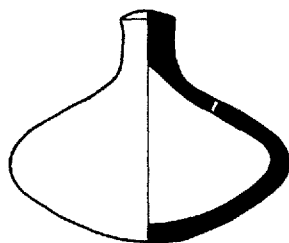

B.664.520*b*

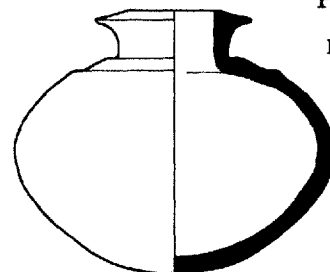

B.664.570

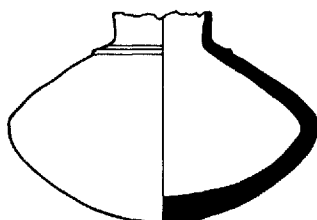

B.663.520

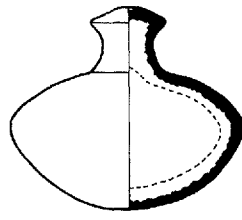

B.664.520*c*

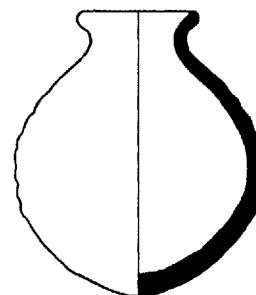

B.665.520

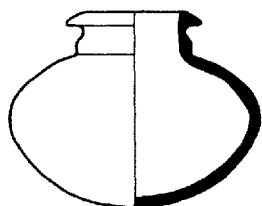

B.663.540*a*

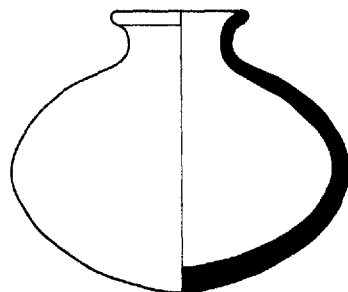

B.664.540*a*

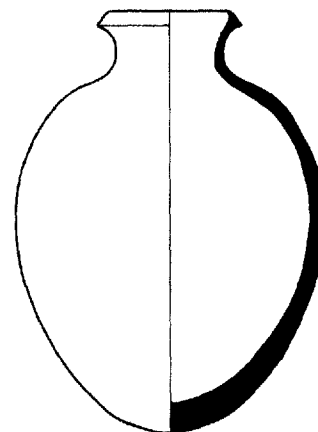

B.666.540*a*

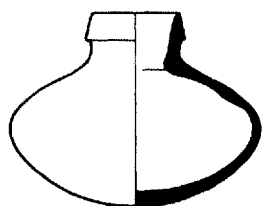

B.663.540*b*

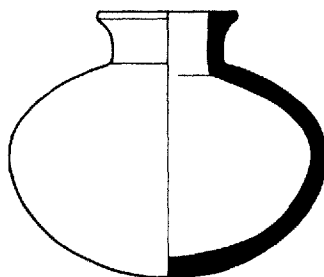

B.664.540*b*

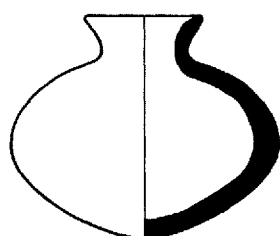

B.664.520*a*

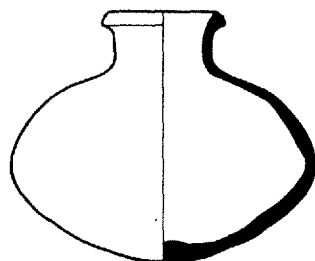

B.664.540*c*

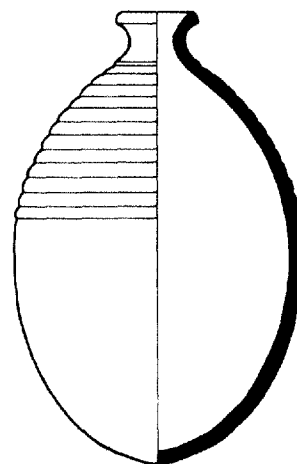

B.666.540*b*

B.666-B.717

Form	Photo on Plate	Site	Square, Locus, or Area	Grave	Building or Level	Date of Find-Spot	Remarks	Comparanda	
								Site	Reference
B.666.620		As.	D 17:32		Archaic Shrine III	ED I	As.34:80. See p. 59		
B.666.640		Kh.	L 42:5		Houses 3	ED III	Kh.III 1328. See p. 99		
B.675.220a	98e	Kh.	R 45		Houses 1	ED III	Kh.I 22. See pp. 95, 142	Kish	"A," Pl. XV 19
B.675.220b	98f 73c	Kh.	R 45 N 44:6 Q 45	110	Houses 1 Houses 4 Nintu VII	ED III ED II ED III	Kh.I 21. See pp. 95, 142 See p. 82 Kh.III 173		
B.676.422		As.	E 15:2		N. Palace	Protoimp.	As.32:1322. See p. 106		
B.703.240	23e	Kh.	P 42:50	8	32.70 m.	Protolit.c	Kh.VII 41; B. See pp. 41-42	Telloh	G I, Pl. VI 5191
B.703.560		As.	J 19:52 E 17:9		Houses Va Earlier N. Palace	Protoimp. ED III	As.32:1250. See p. 107	Kish	"A," Pl. XVI 30; Kish IV, Pl. II N
B.704.570		As.	J 20:21 J 21:26 F 15:9		Houses Va Houses Va Street outside N. Palace	Protoimp. Protoimp. Protoimp.	As.32:865	Kish	"A," Pl. XVI 28
B.705.370	119a	As.	D 17:17 E 17 Below H 18:26 J 20:22 W 42, trench		Houses Va Near surf.	Protoimp.? Protoimp.? Protoimp. Protoimp.	As.35:35; B. See pp. 114, 117, 149		
B.706.360		As.	M 32:5 M 32:5 J 19:7 M 32:6 M 32:15 W. of M 32:8 O 30:17 O 30:18 O 31:8		Houses III or II Bilalama	Larsa Larsa Gutium-Ur III L. Larsa E. Larsa E. Larsa	As.30:P.13a; C. Black band at rim. See pp. 114, 116, 148	Susa	Mém. XXV, Fig. 76:20
B.706.370		As.	H 20		Surf.	Larsa Larsa Larsa	As.30:P.13d As.30:P.13b; C As.30:P.13c; C	Susa	Mém. I, Fig. 166; XXV, Fig. 76:22; XXIX, Fig. 65:3
B.717.700	120j	As.	M 33:2		2 m. below surf.	L. Larsa	As.31:P.92; C. See p. 116	Susa	Mém. XIII, Pl. XXVII 5 and 7 (painted)

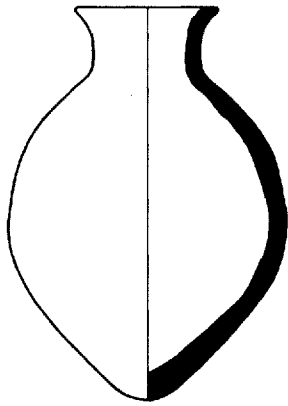

B.666.620

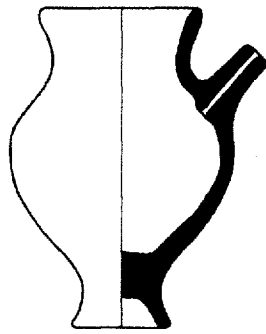

B.676.422

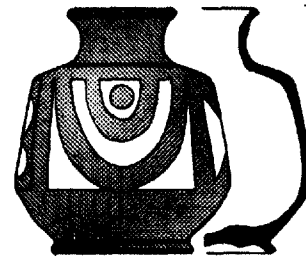

B.705.370

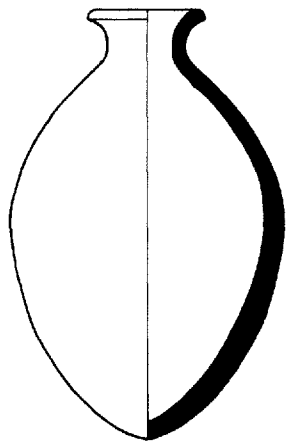

B.666.640

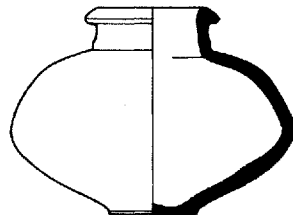

B.703.240

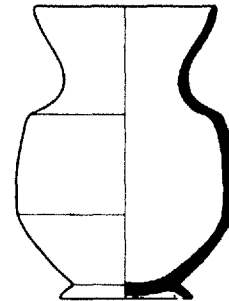

B.706.360

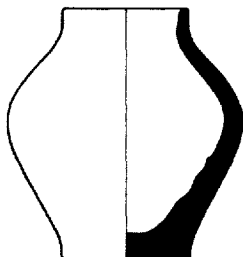

B.675.220a

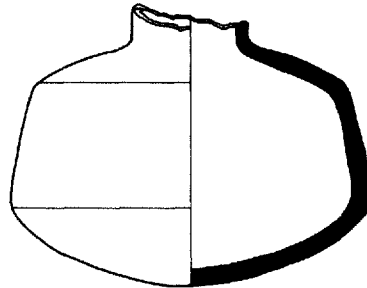

B.703.560

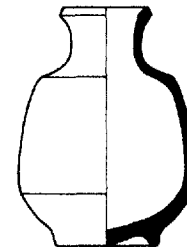

B.706.370

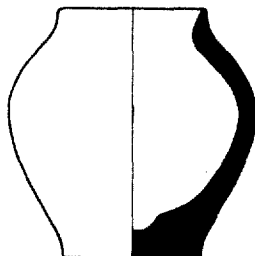

B.675.220b

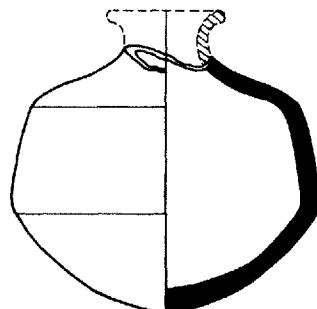

B.704.570

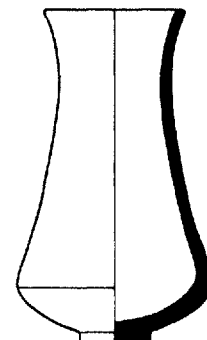

B.717.700

B.741-B.788

Form	Photo on Plate	Site	Square, Locus, or Area	Grave	Building or Level	Date of Find-Spot	Remarks	Comparanda	
								Site	Reference
B.741.300		As.	N. of J 19:67		Houses Va	Protoimp.	As.32:1319. See p. 106		
B.743.510		Kh.	K 42:13	124	Houses 3	ED III	Kh.III 1402. Cf. C.743.510		
B.754.220		As.	H 20:10		Houses Va	Protoimp.	As.32:1014		
B.754.540	65:45 48c	Ag. Kh.	M 14:15 N 44:13	58	30.50 m. Houses 10	ED I ED I	Ag.36:568; C. See pp. 58, 79 Kh.V 285; C. See pp. 58, 137 (n. 58), 138 (n. 78)		
B.755.520	103d	Kh.	O 43:3	133	Houses 3	ED III	Kh.V 50. See p. 100		
B.755.540	112a	As.	E 16:18		N. Palace	Protoimp.	As.32:468. See p. 107	Mari	Syria XVI 8, Fig. 3
B.756.220		Ish.	R 30:1		Kititum III	L. Larsa	Ish.P.5. See p. 116	Kish Susa	Gen. I, Pl. 48:126 Mém. I, Fig. 159
B.756.521		Kh.	R 43:2		Houses 2 or 1	ED III	Kh.IV 368; B. Suspension loops on neck; published in OIP LVIII as found in Sin X		
B.756.720		As.	E 16:40		Square Temple	ED II	As.33:542		
B.757.320		Kh.	r 80			Old Bab.	Kh.VIII 232; B. See p. 123		
B.757.605	24b	Kh.	P 43:59		Houses 12	Protolit.d	Kh.IX 116; B. See p. 42	Jamdat Nasr	Mackay, Pl. LXIV 32 = Pl. LXXVI 2519 (much shorter)
B.766.320a		Ish.	S 30:2		Kititum III	L. Larsa	Ish.P.58. See p. 117		
B.766.320b		Ish.	R 30:1		Kititum IV or above	L. Larsa or Old Bab.	Ish.P.14. See pp. 117, 123	Susa	Mém. I, Fig. 165
B.786.520		As.	F 23:1			Agade?	As.31:P.80; C		
B.787.320a		As.	P 34:3			Larsa	As.31:P.59. See p. 117	Susa	Mém. XXV, Fig. 75:7
B.787.320b		As.	P 30:1 P 30:1		Ibalpiel I well Ibalpiel I well	L. Larsa L. Larsa	As.30:P.48a; B. See p. 117 As.30:P.48b; C		
B.788.320		Ish.	W 30		(Shamash Temple) City wall	L. Larsa or Old Bab. L. Larsa or Old Bab.	Ish.P.68		
			S 30:2		Kititum I or II	Larsa			

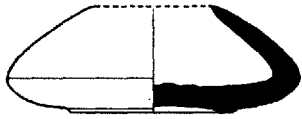

B.741.300

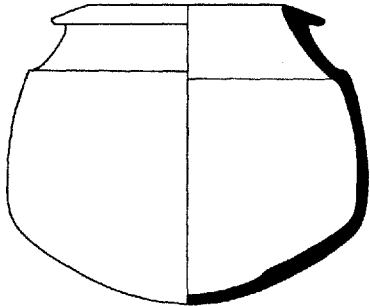

B.754.540

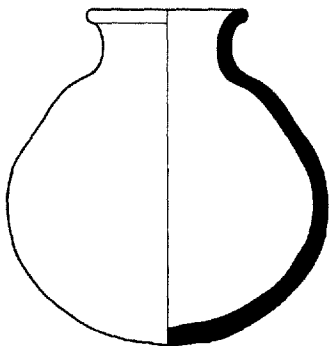

B.755.540

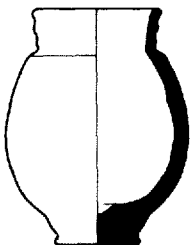

B.756.220

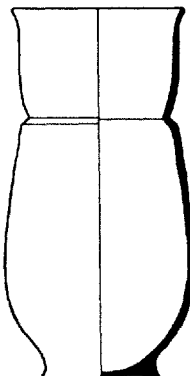

B.757.320

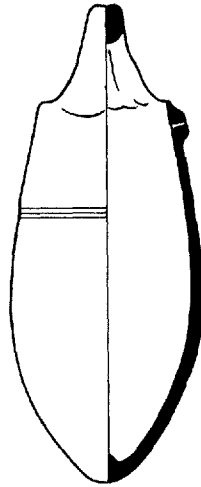

B.757.605

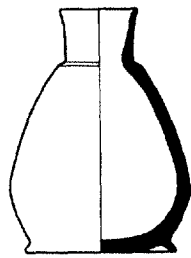

B.766.320 a

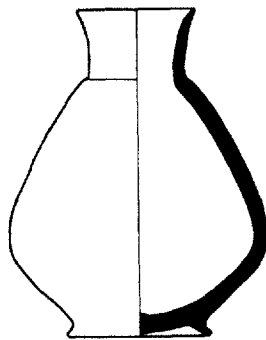

B.766.320 b

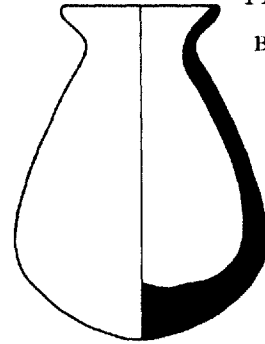

B.786.520

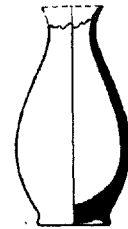

B.787.320 a

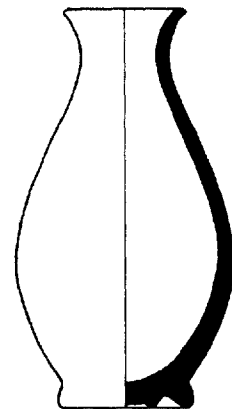

B.787.320 b



B.788.320

B.806-B.882

Form	Photo on Plate	Site	Square, Locus, or Area	Grave	Building or Level	Date of Find-Spot	Remarks	Comparanda	
								Site	Reference
B.806.570	75e	Kh.	Mound A		Houses 4?	ED II?	Kh.V 208; B. See pp. 83, 100, 142	Telloh	G I, Pl. XIII 1176
	75d		N 44:6	94	Houses 6	ED II			
	75a		N 44:14	92	Houses 6	ED II			
	75c		P 42:9	97	Houses 5	ED II			
B.807.570	75b	Kh.	N 44:6	110	Houses 4	ED II	Kh.V 207; C. See pp. 83, 100, 142		
B.812.542		As.	P 33:9		Below Ibiqadad II	E. Larsa	As.31:P.27a; B		
			M 34:2		Below Ibiqadad II	E. Larsa	Unbaked		
			M 34:11		Below Ibiqadad II	E. Larsa	3 unbaked specimens		
			Between N 30:3 and O 31:5*		Below Bilalama	E. Larsa	Unbaked, blackened spout		
	130h		P 32:2		1 m. below surf.	Larsa	As.31:P.27b; C. See p. 122		
	130i	Kh.?					C (A 9298). Purchased; see p. 122		
B.813.522		As.	K 19:3		Houses III or II	Gutium-Ur III	As.32:P.9. See pp. 114, 122		
B.816.521a	102k	As.	F 13?		Older town wall	ED III	As.34:90; C. See pp. 99-100, 107		
	75f	Kh.	F 17:5 Mound A		N. Palace	Protoimp. ED II or III?	As.32:512 Kh.II P.3. See pp. 83, 100		
B.816.521b	102i	As.	F 17:5		N. Palace	Protoimp.	As.32:P.11; B. See pp. 99-100, 107		
			Below H 20:35		Houses Vc	ED III			
B.816.521c	102h	As.	K 19:19		Houses Vb	ED III	As.32:1142; C. See pp. 99-100, 107	Farah	Fara, Pl. 19h; MJ XXII, Pl. XVII 1
			F 17:7		N. Palace	Protoimp.			
			Below H 18:26		Houses Va	Protoimp.			
			Below H 19:30		Houses Va	Protoimp.			
B.816.521	102j	Kh.	O 45:2		Oval II Surf.	ED III	Kh.I 321. See pp. 99-100		
	102j		Q 45		Houses 2	ED III	Kh.I 70. Top only preserved		
			R 45			ED III	Kh.I 28		
B.834.203	50d	Kh.	P 43:38		Houses 9	ED I	Kh.V 299; B. See p. 59		
B.852	130d	As.	L 30:1			Larsa	As.31:535b; C. See p. 122	Kish	Gen. I, Pl. 53:117;
	130f		M 27:1			Larsa	As.31:446; B		II, Pl. 57:5 a
	130e		M 33:4			L. Larsa	As.31:535a; C		
		Ag.	E 16, well			Larsa?	Ag.35:104		
B.882	71c	Kh.	R 42:2		Sin VIII	ED II	Kh.IV 391. See pp. 81-82		

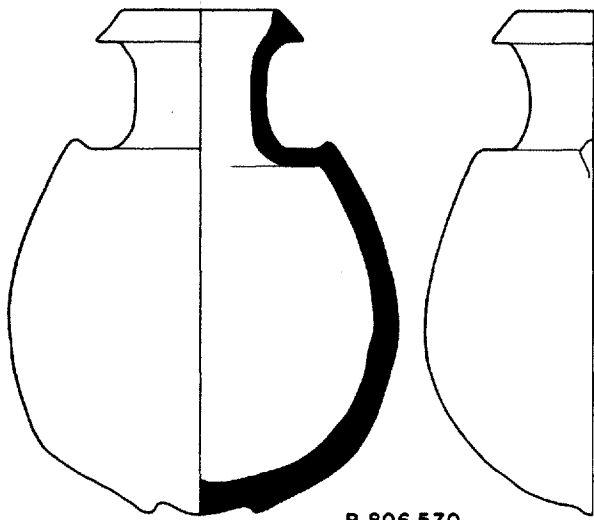

B.806.570

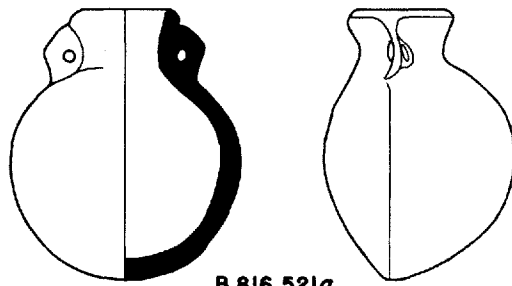

B.816.521a

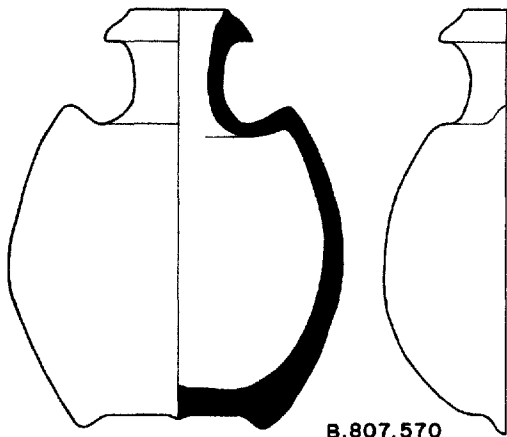

B.807.570

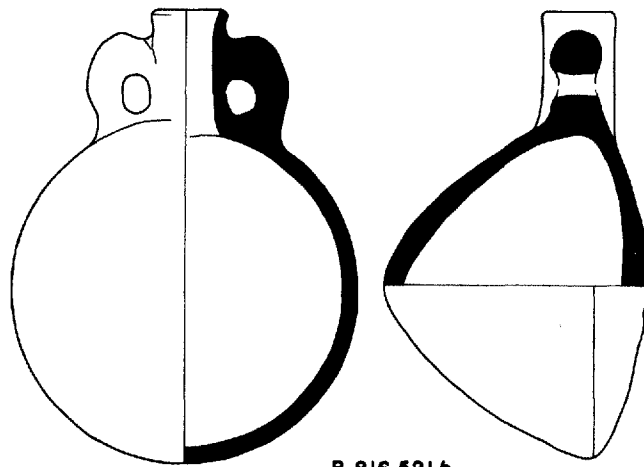

B.816.521b

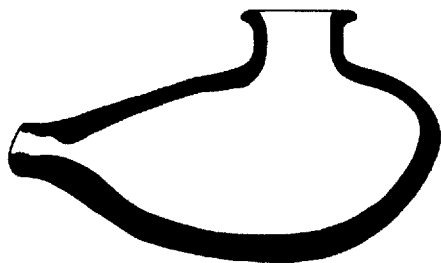

B.812.542

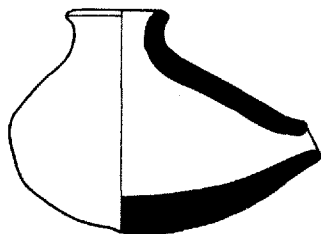

B.813.522

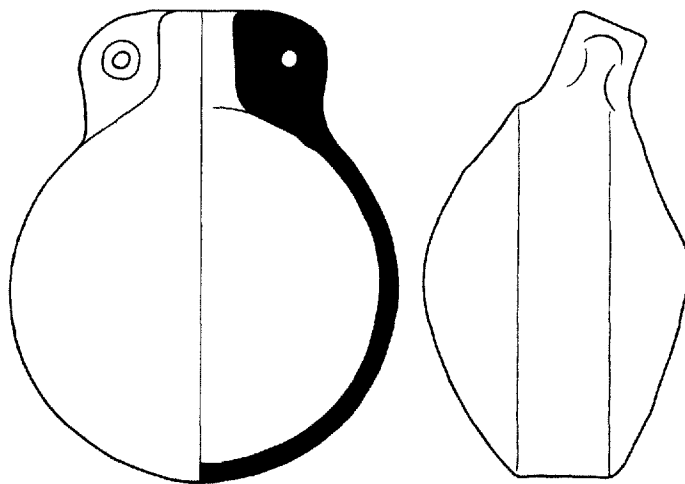

B.816.521c

Form	Photo on Plate	Site	Square, Locus, or Area	Grave	Building or Level	Date of Find-Spot	Remarks	Comparanda	
								Site	Reference
C.001.200a		As.	F 23:1 F 16:2 F 17:9A F 23:2 G 19:4 H 27 J 19:48 K 19:20 K 19:34		N. Palace N. Palace Houses IVa Houses IVb Houses Va Houses Va	Agade? Protoimp. Protoimp. Agade? L. Agade Larsa? E. Agade Protoimp. Protoimp.	As.31:P.42a; C. See pp. 105, 109, 115 As.32:P.66 As.31:P.42b-c; C As.31:P.42e; C	Abu Hatab	Fara, Fig. 64, F 1492 = Pl. 73 k
C.001.200b		As. Ish.	J 19:3 P 30:1		Houses I Kititum III or IV	E. Larsa L. Larsa	As.32:P.21. See p. 115 Ish.P.38a-b	Kish	Kish IV, Pl. I 1a
C.001.210		As.	J 19:27		Houses IVb	E. Agade	As.32:1133		
C.002.200		Kh.	N 43:12 P 43:27 P 43:45	111 87 57	Houses 4 Houses 6 Houses 10	ED II ED II ED I	See pp. 58-59 3 specimens		
C.002.210	21b 21a	Kh.	P 42:28 P 42:28 P 43:54		(Below Sin I) (Below Sin I) Below Houses 12	Protolit.c Protolit.c Protolit.c	Kh.VII 78; B. See pp. 39, 126, 127-28 Kh.VII 79; C 4 specimens	Jamdat Nasr Telloh Warka Ur Eridu Nuzi Nineveh Grai Resh al-Nish Dhahab Hamah Judaidah Chatal Hdydk Carchemish Susa Siyalk	Mackay, Pl. LXVII 22-23 G I, Pl. VIII 4241 UVB IV, Pl. 19 A t' (convex base) AJ X, Pl. XLIII b Figs. 3:4 and 4:10 Pl. 50 A AAA XIX, Pl. LXI 26; XX, Pl. LI 3 Iraq V 140 and Fig. 5, Group IV 17 ibid. Memnon I, Fig. 1 (top left) Pl. IV 3 Lowest floor of phase G Highest floor of phase F Unpub. (information from R. J. Braided-wood) Mém. I, Figs. 91, 118, and 121; XX 102, Fig. 1:4 Pl. XXVI 7 (b much taller)
C.002.500	97f	Kh.	O 43:6	137	Houses 3	ED III	See p. 95		
C.003.200		Kh.	P 43:39 P 43:42 P 43:45 P 43:53 P 43:61	69 33 75 81 13	Houses 9 Houses 11 Houses 9 Houses 8 Houses 12	ED I ED I ED I ED I Protolit.d	See pp. 34, 58-59 10 specimens 3 specimens		
C.003.203	101j	As.	E. of D 16:6		Outside N. Palace	Protoimp.?	As.32:1305; C. See p. 105		
C.011.201a	104d 104f	Kh.	J 43:6 J 42:4 P 44:9 R 45		Houses 3 Houses 2 Houses 2 Houses 3 or 2	ED III ED III ED III ED III	Kh.III 1365. See pp. 100, 143 Kh.I 192 Kh.I 19	Kish Nuzi Nineveh Gaura	"A," Pl. LII 25-26; Kish IV, Pl. I 14 Pl. 95 B AAA XX, Pl. LXXI 7 (small) Pl. XXIX b = Pl. LXXV 212
C.011.201b		Kh.	O 43:6		Houses 3	ED III	See p. 100		
C.012.200		Kh.	P 43:27	87	Houses 6	ED II			
C.012.203		Kh.	P 44:6 O 44:10		Houses 2 Houses 1	ED III ED III	Kh.III 1236. See p. 100 Kh.III 1255	Kish	"A," Pl. LII 24
C.013.210		Kh.	O 44:10 O 44:10		Houses 1 Houses 1	ED III ED III	Kh.III 1194. See p. 101 Kh.III 1195-96		
C.014.300	45b	Kh.	P 42:14		Houses 8	ED I	Kh.V 196; B. See pp. 55, 137, 139	Kish	Kish IV, Pls. I 16 and XVI 5
C.014.310	45a, 65:43	Ag.	Hill B		Top layer	ED I	Ag.36:571; C. See pp. 55, 79, 137, 139; hole in bottom	Kish	Kish IV, Pl. XVI 5
C.022.300		Kh.	Mound A			ED III?	See pp. 95, 112	Kish	"A," Pl. LII 19
C.023.200		Kh.	P 43:39 P 43:45	89 57	Houses 9 Houses 10	ED I ED I	4 specimens 5 specimens		
C.025.200							See C.026.410		
C.026.410		Kh.	Q 42:7		Sin IX	ED II or III	Kh.IV 504. Published in OIP LVIII as C.025.200		
C.031.200		Kh.	P 43:45	66	Houses 10	ED I			
C.031.300	120f	As.	E 16:9?		Houses above N. Palace	Larsa?	As.31:P.109; C. See p. 115		
C.032.200		Kh.	O 43:3 P 43:39	133 76	Houses 3 Houses 9?	ED III ED I			
C.032.210		Kh.	P 42:15		Houses 7	ED I			



C.001.200 a



C.001.200 b

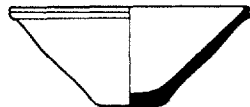

C.001.210

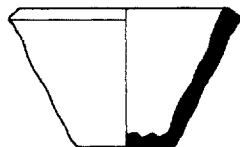

C.002.210

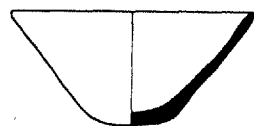

C.002.500



C.003.203

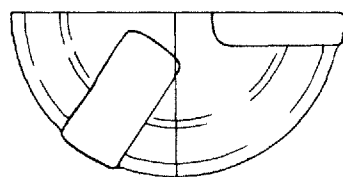
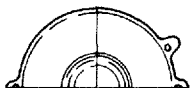

C.011.201 a

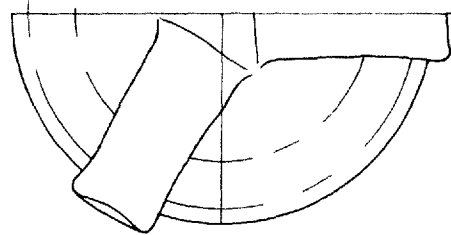

C.011.201 b

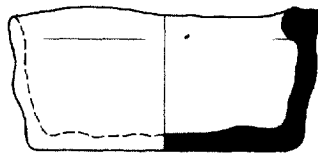
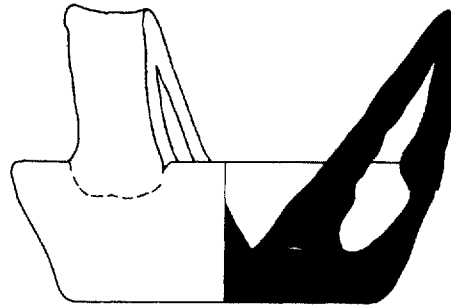

C.012.203

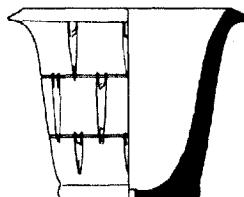
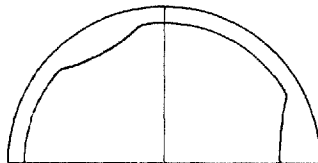

C.014.310

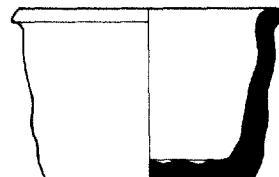

C.013.210

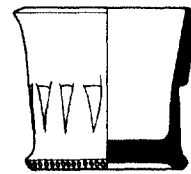

C.014.300

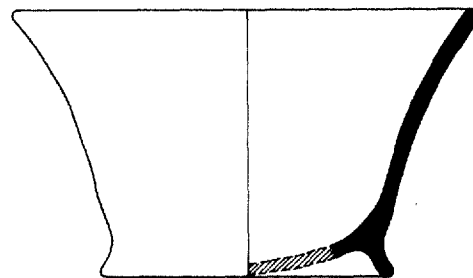

C.022.300

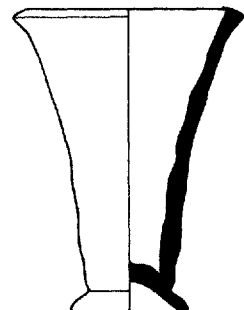

C.026.410

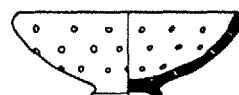

C.031.300

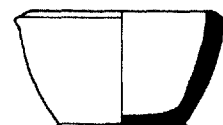

C.032.210

Form	Photo on Plate	Site	Square, Locus, or Area	Grave	Building or Level	Date of Find-Spot	Remarks	Comparanda	
								Site	Reference
C.032.304		Kh.	O 43:11		Small Temple IX	ED III	2 specimens. See p. 95		
C.041.200		As.	D 17:11		Archaic Shrine IV	ED I	As.33:714. Perforated base		
C.041.500	23i	Kh.	Q 42:39 P 43:51 Q 42:26		Sin II Below Houses 12 Sin III	Protolit.c or d Protolit.c	Kh.VII 283; C. Traces of red paint outside; see pp. 41-42 Kh.IX 197; B. Red paint all over Kh.VII 175; B. Published in OIP LVIII as B.041,500; white slip inside, red paint outside	Jarndat Nasr Ur al-cUbaid	Mackay, Pl. LXVI 30 G I, Pl. V 4729 RC, Type 18 a Type XV
C.042.200	110b	As.	H 18:6 H 18:6 J 19:13 J 20:23 J 21:26 K 28:2		Houses III Houses III Houses Va Houses Va Houses Va	Gutium-Ur III Gutium-Ur III Protoimp. Protoimp. Protoimp. Agade	As.31:P.102a; C. See p. 113; found beside oven As.31:P.102b; C. Found beside oven See p. 105	Farah	Fara, Fig. 42, F 2815
C.042.203	104b	As.	E 15:2		N. Palace	Protoimp.	As.32:589. See p. 108		
C.042.204		Kh.	R 45		Houses 1	ED III	Kh.I 27. See p. 95		
C.043.310		As. Ish.	N 30:1 Road S. of Kititum Temple		(Kititum IV?)	Larsa L. Larsa or Old Bab.	As.31:P.122; B. See p. 115 Ish.P.76	Abu Hatab Nuzi	Fara, Fig. 58 Pl. 80 A
C.043.510	120e	As.	M 32:6			L. Larsa	As.31:P.94; C. See p. 115		
C.044.200	74f	Kh.	N 44:6	103	Houses 5	ED II	Kh.V 243; C. See p. 83	Warka	UVB IV, Pl. 20 B r'
C.044.210		Ish.	Road S. of Kititum Temple			L. Larsa or Old Bab.	Ish.P.66. See p. 115		
C.044.310		Ish.	X 32?		City Gate	L. Larsa or Old Bab.	Ish.P.46. See p. 115	Abu Hatab	Fara, Fig. 58
C.045.700	65:76	Ag.	Hill B*		Top layer	ED I	Ag.36:577. See pp. 59, 79	Nuzi	Pls. 79 DD and 80 H
C.052.202	74g	Kh. As.	O 43:55 Below E 15:10*	94	Houses 12 Houses 6 Earlier N. Palace	Protolit.d ED II ED III	See p. 81 As.32:1160. Rim sherd with spout; see pp. 91-92		
C.053.200	96b	Kh.	R 44	165	Above Houses 2	ED III	Kh.I 55c; C. See pp. 94, 142		
C.053.212		As.	L 30:1			Larsa	As.31:P.151. See p. 115		
C.053.312	114c	As.	J 20:4 J 18:21 J 19:16* J 20:10* J 20:15 J 21:1* K 20:1		Houses IVa Houses IVb Houses IVa Houses IVa Houses Va Houses IVa Houses IVa	L. Agade E. Agade L. Agade L. Agade Protoimp. L. Agade L. Agade	As.32:P.64; B. See pp. 91, 92, 106, 111 As.32:1270 As.32:134 As.32:579 As.32:546-47 2 specimens	Susa	Mém. XII, Figs. 414-16
C.063.200		Kh.	P 43:45	57	Houses 10	ED I	4 specimens		
C.064.300	121d	As.	G 19			Agade?	As.30:P.55; C. See p. 112		
C.072.200		As.	K 19:20		Houses Va	Protoimp.	As.32:939. See p. 105		
C.073.200		Kh.	P 43:53	81	Houses 8	ED I	2 specimens		
C.075.404		Kh.	P 45:14		Houses 2	ED III	Kh.III 984. See p. 95		
C.077.500	50a 50b	Kh.	N 44:13 P 43:25		Houses 11 Houses 5	ED I ED II	Kh.V 202; C. See pp. 59, 82 Kh.V 252; B	Susa	Mém. XX 102, Fig. 1:3
C.082.200		As.	D 17:8		Square Temple	ED II	As.33:366	Kish Warka	"A," Pl. LIV 18 UVB IV, Pl. 20 B n'
C.082.210		As.	E 16:40		Square Temple	ED II	As.33:543. Scalloped or notched rim?		
C.082.310	96h	Kh.	P 42		Surf.	ED III?	See p. 95		
C.083.200	96c	Kh.	N 44:7 O 43:3	131 133	Houses 3 Houses 3	ED III ED III	See pp. 94, 142		
C.084.200a		As.	H 18:14 H 18:14		22-21 m. 24-23 m.	Protolit.d Protolit.d	See pp. 34, 78 and Pl. 64:78 See p. 77	Nineveh	AAA XIX, Pl. LXI 27; XX, Pl. LI 5
C.084.200b		As.	D 17:33		Earliest Shrine	Protolit.d	As.34:244. See p. 34	Warka	UVB IV, Pl. 20 B k'
C.084.310	96i	As.	E 17:11		Below Single-Shrine I	ED III	As.33:107. See p. 95	Nuzi	Pl. 50 Q
C.086.200		As.	D 17:35		Archaic Shrine II	ED I	As.34:208. See pp. 58-59		

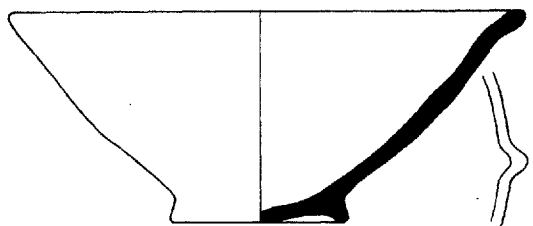

C.032.304

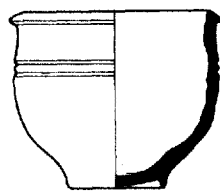

C.044.310

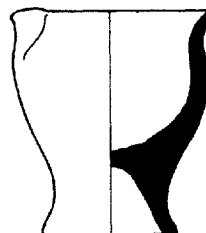

C.075.404



C.041.500

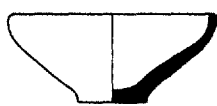

C.042.200

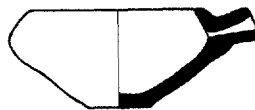

C.052.202

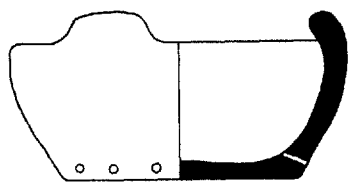

C.053.200

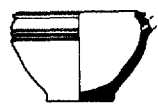

C.053.212

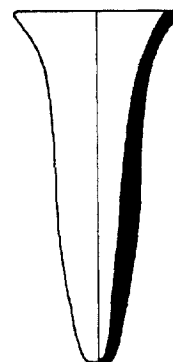

C.077.500

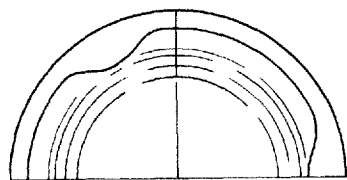

C.042.203

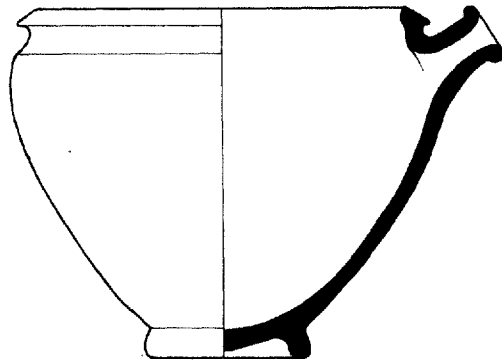

C.053.312

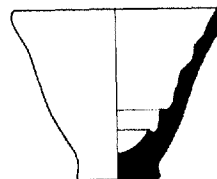

C.084.200 a

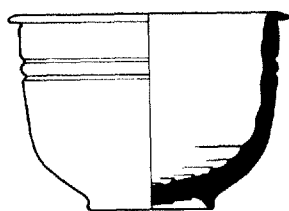

C.043.310

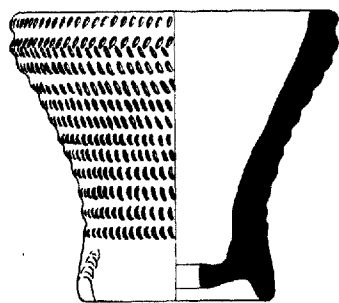

C.064.300

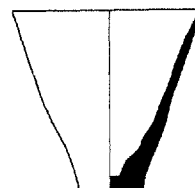

C.084.200 b

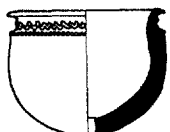

C.043.510

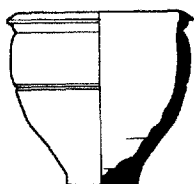

C.044.210

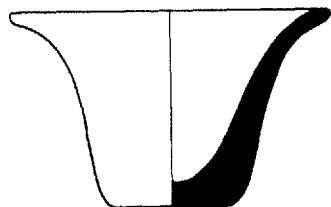

C.072.200

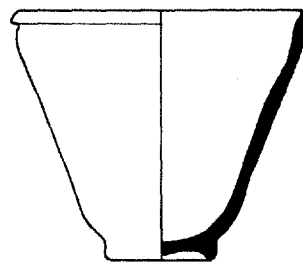

C.084.310

Form	Photo on Plate	Site	Square, Locus, or Area	Grave	Building or Level	Date of Find-Spot	Remarks	Comparanda	
								Site	Reference
C.111.210		As.	E 17 J 20:4*		Surf. Houses IVa	Gutium-Ur III? L. Agade	As.31:P.47; C. See p. 113 As.32:423		
C.111.310a		As.	K 19:7		Houses III or II	Gutium-Ur III	As.32:P.14; B. See pp. 113, 123	Nuzi	Pl. 91 K
C.111.310b		As.	E 16:3		Houses above N. Palace	Larsa?	As.31:P.103; C. See pp. 115, 123		
C.142.310		Kh.	N 43:15	132?	Houses 3	ED III	Kh.V 81		
		As.	K 31:1 F 18:3		Bilalama Houses above N. Palace	E. Larsa Larsa?	As.30:P.23. See pp. 105-6, 115		
			J 19:1		Houses II or I	Gutium-Ur III or E. Larsa			
		Kh.	J 19:59* K 42:13*	123	Houses Va Houses 3	Protoimp. ED III	Gray ware; perhaps part of "fruit stand"		
C.175.720		As.	P 27:4		Naramsin	L. Larsa	As.33:365. See pp. 116, 123		
C.176.720		Ish.	S 30:2		Kititum IV or above	L. Larsa or Old Bab.	Ish.P.26. See p. 123		
C.200.210	20e	Kh.	Q 42:40 P 43:43	35	Sin II Houses 11	Protolit.c ED I	Kh.VII 230; B. See pp. 39, 60	Kish Jamdat Nasr Uqair	Kish IV, Pl. VII 1 Mackay, Type M JNES II, Pl. XVI (top)
C.201.200	69bd	Kh.	O 43:8 O 43:16		Houses 2 or 1 Small Temple VI	ED III ED II	Kh.III 1256. See p. 101 Kh.V 245b; B. Belongs with C.234.000; see pp. 56, 81	Kish Jamdat Nasr Ur al-Ubaid	"A," Pl. LII 20 Mackay, Pl. LXVI 28 RC, Type 1 Type XX
C.201.203	104c	As.	J 20:15 E 16:26		Houses Va Earlier N. Palace	Protoimp. ED III	As.32:938; B. See pp. 101, 108	Kish	"A," Pl. LII 22 and 24
C.201.205		As.	F 17:1		Houses above N. Palace	Larsa?	As.31:P.130; C. See pp. 101, 118		
C.202.200							See C.802.200		
C.202.203	104a	Kh.	P 44:16		Houses 2 or 1	ED III	Kh.I 204. See pp. 100, 143		
C.204.210		As.	N. of H 20:13		Houses Va	Protoimp.	As.32:1371. See p. 108		
C.206.310	127i	As.	O 30:17			Larsa?	As.31:816; C. See pp. 118, 121		
C.206.400	65:41	Ag.	Hill B, room V		Top layer	ED I	Ag.36:450; B. See pp. 56, 79		
C.206.410		As.	F 17:5		N. Palace	Protoimp.	As.32:P.23; B. See pp. 101, 108		
C.206.510		As.	Outside P 30:4 Outside P 30:4			E. Larsa E. Larsa	As.31:P.75. See p. 115 2 specimens	Telloh Ur	S, Pl. 42:11 RC, Type 225
C.208.320		Ish.	P 30:1 R 29:1 V 32:6		Kititum III or IV Kititum II Houses	L. Larsa L. Larsa L. Larsa or Old Bab.	Ish.P.32		
C.208.440	121g	As.	O 30:9 K 31:3* L 30:1 M 32:3* M 32:6 M 32:15 O 30:3			Larsa Larsa Larsa L. Larsa L. Larsa E. Larsa L. Larsa	As.30:P.36a; B Bases of 2 specimens As.30:P.36c; C Bases of 3 specimens As.30:P.36b; C. See pp. 116, 149		
C.211.200		As.	J 19:2		Houses IVa	L. Agade	As.32:942. See p. 110		
C.213.200		As.	E 16:4 E 17:9 J 20:23		Above N. Palace Outside N. Palace Houses Va	Agade? Protoimp.? Protoimp.	As.32:1099. See pp. 105, 110	Kish Farah	"A," Pl. LIV 26 Fara, Pl. 19 a



C.III.210



C.201.203



C.III.310 a

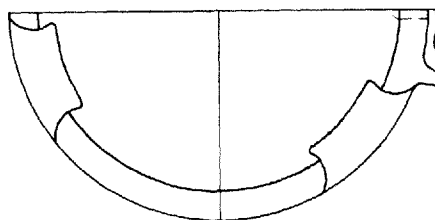

C.201.205

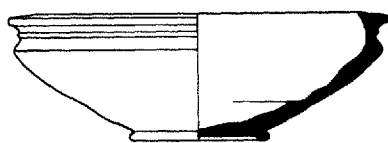

C.III.310 b

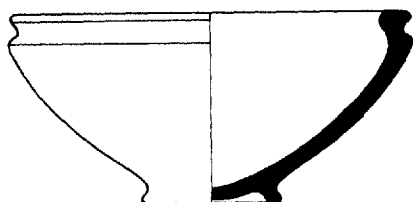
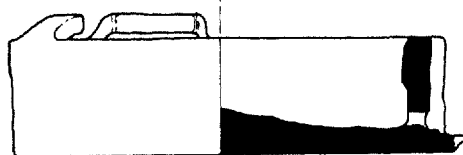

C.142.310

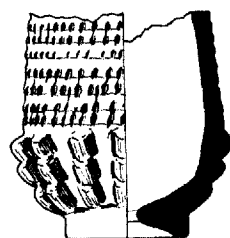

C.206.310

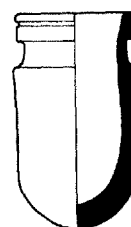

C.206.510

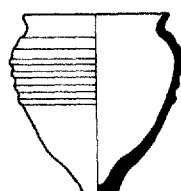

C.175.720

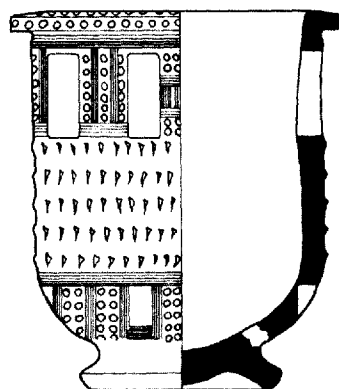

C.206.410



C.208.320

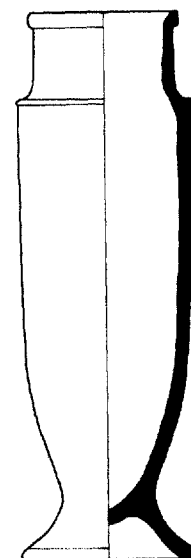

C.208.440

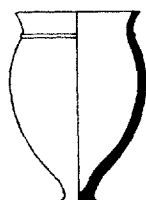

C.176.720



C.201.200



C.211.200

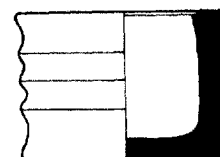

C.213.200

Form	Photo on Plate	Site	Square, Locus, or Area	Grave	Building or Level	Date of Find-Spot	Remarks	Comparaanda	
								Site	Reference
C.213.210		Kh.	Q 44:11 O 44:10 P 45:8 Q 44:8		Houses 1 Houses 1 Houses 1 Houses 1	ED III ED III ED III ED III	Kh.III 168; B Kh.III 1172	Kish Farah Bismayah	"A," Pl. LIV 26 Fara, Pl. 19 a AJSL XXII 141, No. 36
C.215.210	105c	As.	F 15:9 J 19:59 P 26:3		Street outside N. Palace Houses Vc Near surf.	Protoimp. ED III L. Larsa	As.32:984. See pp. 101, 105	Farah Assur Gaura	Fara, Pl. 19 a-b Fig. 14 (left) Pl. LXXI 160 (ring base)
C.216.210		As.	G 18:1 D 16:7 D 17:3 E 17:6 F 15:10 F 17:5 F 17:6 G 18:8 J 19:53 J 20:1		Houses IV Outside N. Palace Single-Shrine II or III N. Palace N. Palace N. Palace N. Palace Houses IVa Houses Va Houses Va	Agade Protoimp.? Protoimp. Protoimp. Protoimp. Protoimp. Protoimp. Protoimp. Protoimp.	As.31:P.89a; C. See pp. 101, 105, 110 As.32:506-7 As.31:P.89c As.32:P.29 As.31:P.89b	Farah Assur	Fara, Fig. 37, F 2784 Fig. 14 (right)
C.225.310a		Kh.	P 42:15		Houses 7	ED I			
C.225.310b		Kh.	Mound B			Old Bab.	See p. 123		
C.226.220		Kh.	V 44:3		Houses 1 or above	ED III?		Ur al-Ubaid	RC, Type 118 Type XXVIII
C.226.540		As.	O 30:18 M 27:1 N 30:1			E. Larsa Larsa E. Larsa	As.31:P.16a. See p. 118 As.31:P.16c As.31:P.16b; C	Susa	Mém. XXV, Fig. 76:15
C.228.340a	119f	As.	P 30:1		Ibalpiel I well	L. Larsa	As.30:P.47; C. See pp. 116, 123, 149	Kish	Kish IV, Pl. II Pa
C.228.340b		Ish.	Q 30:4		Kititum IV or above	L. Larsa or Old Bab.	Ish.P.51. See pp. 116, 123		
C.233.100		As.	J 20:15		Houses Va	Protoimp.	As.32:940. See pp. 108, 112	Kish	"A," Pl. LII 21 (hole in base)
C.234.000	69a, c-d	Kh.	O 43:16		Small Temple VI	ED II	Kh.V 245a; B. See pp. 56, 81 and C.201.200		
C.235.370		Kh.	N 44:14	92	Houses 6	ED II		Farah	Fara, Pl. 19 d and Fig. 37, F 2785 (both with convex base)
C.236.010	45d, 65:39, 65:40	Ag.	Hill B Hill B		Top layer Top layer	ED I ED I	Ag.36:546; B. See pp. 55, 79, 137, 139 Ag.36:545; C		
C.236.210		As.	E 13		Gate of older town wall	ED III	As.34:206. Relief bands near rim and base		
C.245.300		As.	G 18:7		Houses IVb	E. Agade	As.32:P.1. See p. 110		
C.246.210		As.	G 18:1		Houses IV	Agade	Cf. C.246.310		
C.246.310		As.	N 32 N 31 N 34*		Bilalama Ibiqadad II	Larsa E. Larsa L. Larsa	As.31:P.104; C. See pp. 101, 118 Base squared off (cf. Pl. 121d) Base only C (A 9875). Purchased; see pp. 101, 108	Assur	Fig. 15 (left)
C.247.500		As.	S 36		Snake Shrine	Larsa	As.35:63		
C.257.210	114g	As.	H 18:7 H 18:7 F 17:6 H 18 H 18:21 J 19:12		Houses III Houses III N. Palace Houses III Surf. Houses III	Gutium-Ur III Gutium-Ur III Protoimp. Gutium-Ur III Gutium-Ur III Gutium-Ur III	As.31:P.108a; B. See pp. 106, 110, 113, 146, 147 As.31:P.108b; C Many specimens As.32:P.49	Telloh Ur Bismayah	G I, Pl. XII (lower right) RC, Type 16 Bismaya, p. 216

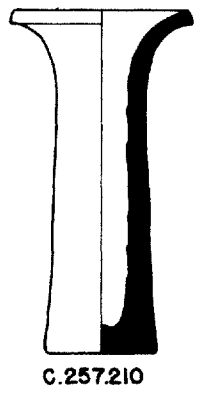
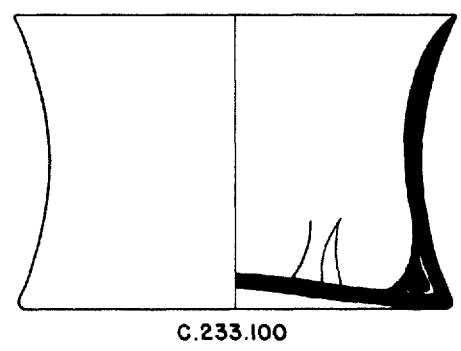
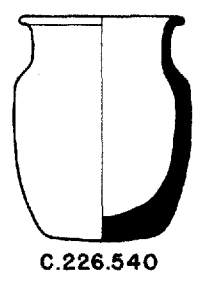
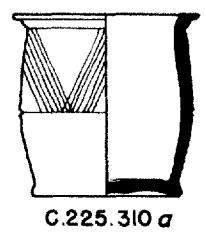
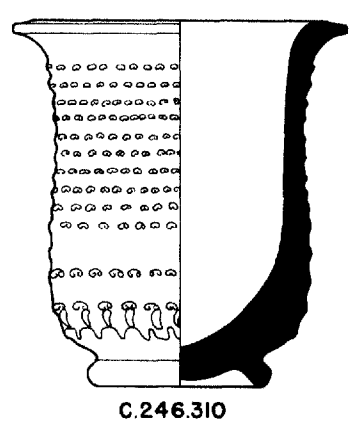
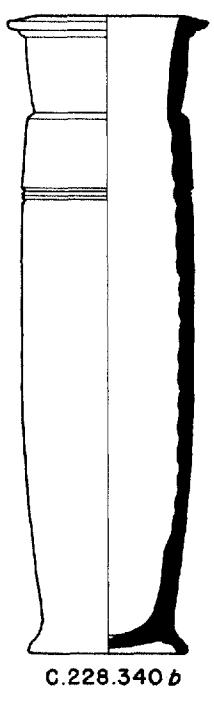
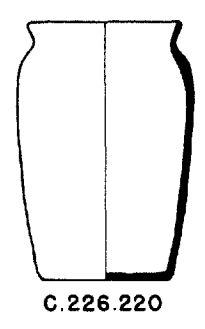
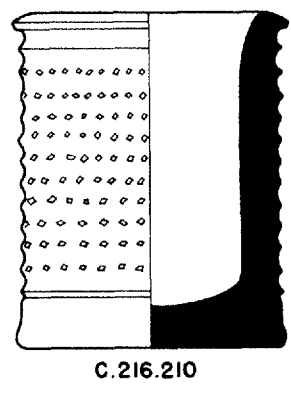
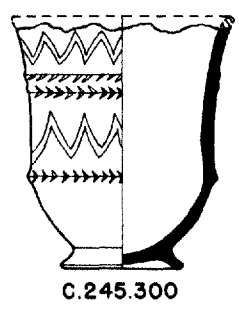
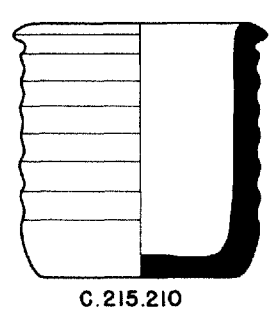
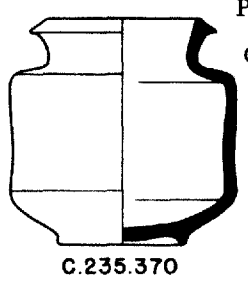
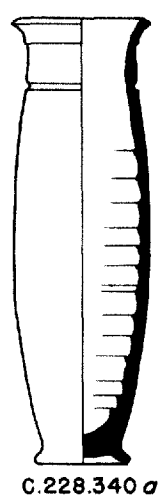
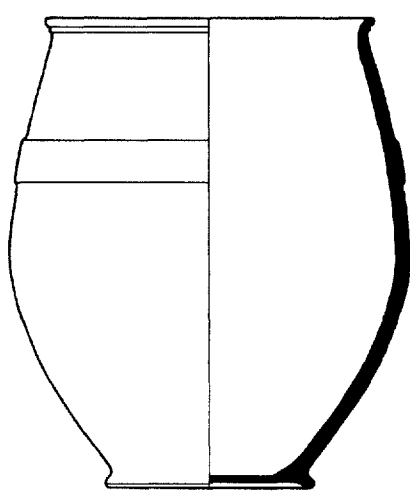
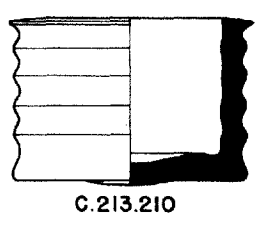

C.303-C.357

Form	Photo on Plate	Site	Square, Locus, or Area	Grave	Building or Level	Date of Find-Spot	Remarks	Comparanda	
								Site	Reference
C.303.200	105d	As.	E 16:11		N. Palace	Protoimp.	As.33:333. See pp. 101, 105		
C.305.400	24a	Kh.	Q 42:26		Sin III	Protolit.c	Kh.VII 251; C. See pp. 34-35, 42, 56, 101, 134, 136		
C.305.800	105a	Kh.?					C (A 9676). Purchased; see p. 101		
C.352.000		Kh.	P 43:4		Houses 2	ED III	Kh.III 174. See p. 91	Ur	RC, Type 244
C.352.010		Kh.	K 42:9 K 42:13	167 124	Houses 2 Houses 3	ED III ED III	Kh.III 1025. See p. 91 Kh.III 1403-4	al-Ubaid	Type XCVI
C.353.010a		Kh.	K 42:5	168	Above Houses 2	ED III	Kh.III 622; B. See p. 91	Ur Gaura Susa	RC, Type 245 Pl. LXXIV 199 Mém. XXV, Fig. 76:43
C.353.010b		Kh.	N 44:5	119	Houses 4	ED II		Nuzi Mari	Pl. 94 G and I Syria XIX, Pl. II 4
C.353.010		Kh.	L 42:5		Houses 3	ED III	Kh.III 1324		
C.354.000		Kh.	K 44:1		Oval I	ED II	Kh.III 1099		
C.354.010		As.	E 17:11		Below Single-Shrine I	ED III	As.33:90. See p. 91	Farah	Fara, Pl. 20 c
C.355.010	68g	As.	D 17:6		Square Temple	ED II	As.33:674; C. See pp. 81, 91, 141		
C.356.000		Kh.	N 44:7 P 43:23	131 91	Houses 3 Houses 6	ED III ED II	2(?) specimens. See p. 91 See p. 81	Mari	Syria XIX, Pl. II 4
C.356.010	68f	As.	D 17:5		Square Temple	ED II	As.33:362; B. See pp. 81, 141		
C.357.000a		Kh.	O 43:6	137	Houses 3	ED III	See pp. 81, 91		
C.357.000b		Kh.	N 44:6	103	Houses 5	ED II	See pp. 81, 91	Assur	Pl. 20 f'
C.357.000	70a 70d	Kh.	N 44:14 P 43:23	92 89	Houses 6 Houses 6	ED II ED II	Kh.V 287; B. See p. 81 Kh.V 294; C		
C.357.010a	68c	Ag.	L 13:6		32.50 m.	ED II	Ag.35:1133; C. See pp. 81, 141	Assur	Pl. 20 d-h
C.357.010b	68b	As.	D 17:5 D 17:6*		Square Temple Square Temple	ED II ED II	As.33:149; C. See pp. 81, 141 As.33:116	Kish Farah Assur	"A," Pl. XII 19 Fara, Pl. 20 b and Fig. 43, F 2834 Pl. 20 b
C.357.010	45c	Kh.	R 42		Sin VI	ED I	Kh.VII 284; C. See pp. 55, 137, 139; used as drain	Kish	Kish IV, Pl. I 15 - Pl. XVI 6

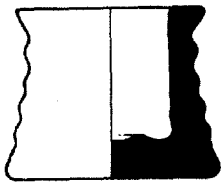

C.303.200

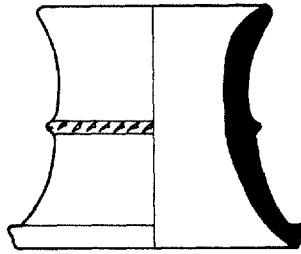

C.354.010

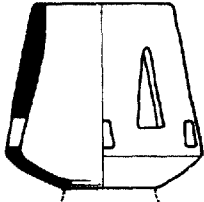

C.305.400

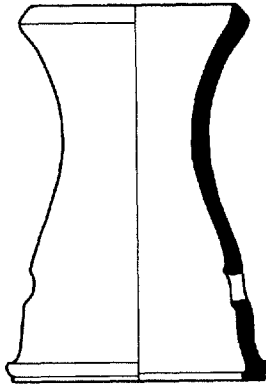

C.356.010

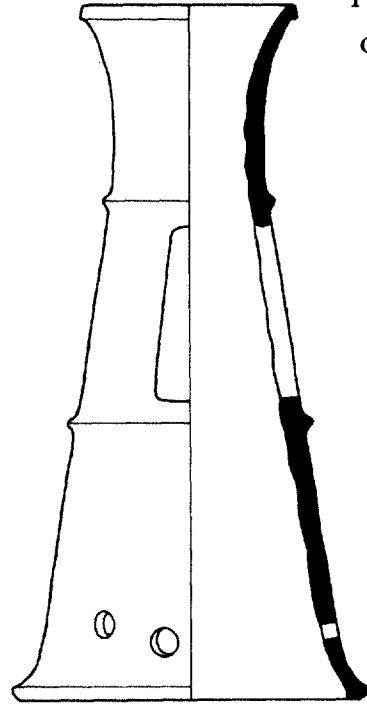

C.357.010 a

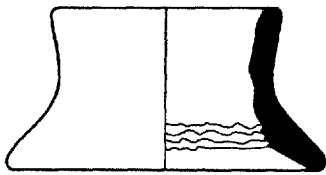

C.352.000



C.352.010

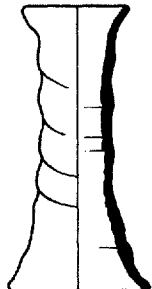

C.357.000 a

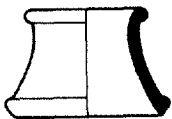

C.353.010 a

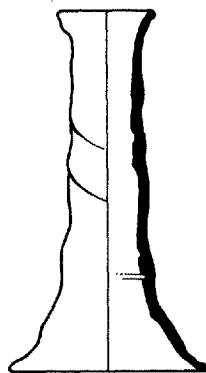

C.357.000 b

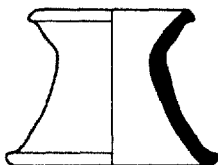

C.353.010 b

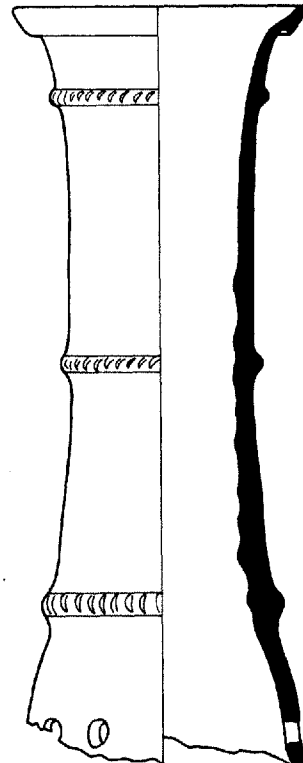

C.357.010 b

C.357-C.39-

Form	Photo on Plate	Site	Square, Locus, or Area	Grave	Building or Level	Date of Find-Spot	Remarks	Comparanda	
								Site	Reference
C.3--_083	45f	As.	D 17:15		Archaic Shrine IV	ED I	As.34:70. See pp. 55, 137, 139		
C.357_073	45g	As.	D 17:10		Archaic Shrine IV	ED I	As.35:502; B. See pp. 55, 137, 139		
C.358.010	68a	Ag.	M 14:15		31.00 m.	ED II	Ag.36:304; B. See pp. 81, 141		
C.3--.0--	45e	As.	D 17:24		Archaic Shrine IV	ED I	As.34:69; B. See pp. 55, 137, 139		
C.35-.0--a	68d	As.	D 17:9		Square Temple	ED II	As.33:494. See pp. 81, 141		
C.35-.0--b	45h	As.	D 17:11		Archaic Shrine IV	ED I	As.33:627. See pp. 55-56, 137, 139	Assur	Pl, 18:15
C.39-.0--	68e	As.	D 17:8		Square Temple	ED II	As.33:495; B. See pp. 81, 141		

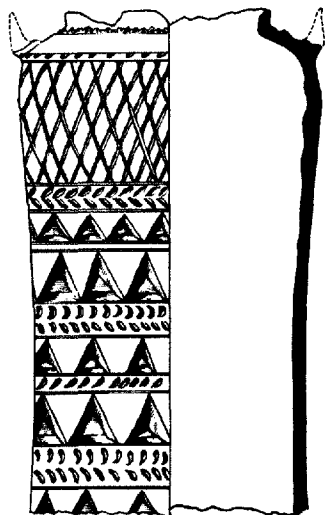

C.3--.063

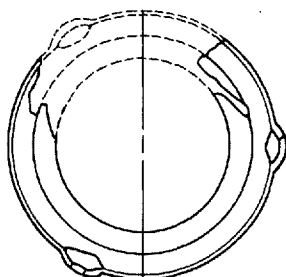
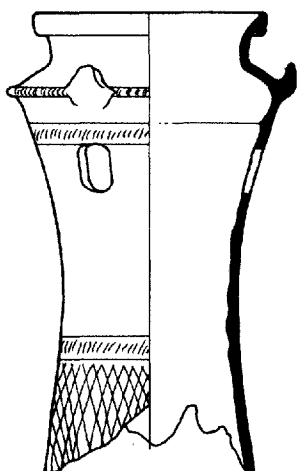

C.357.073

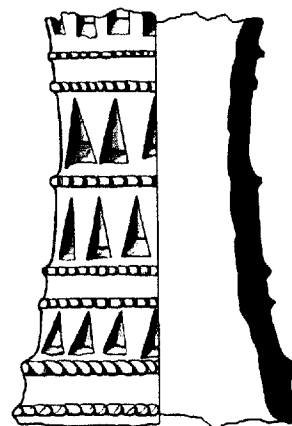

C.3-- 0--

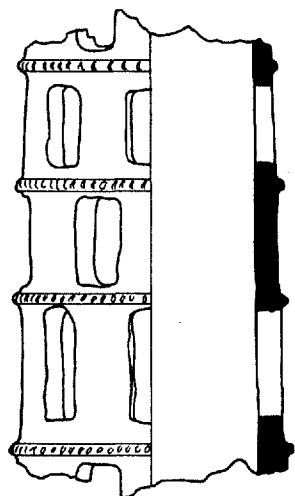

C.35-.0-- a

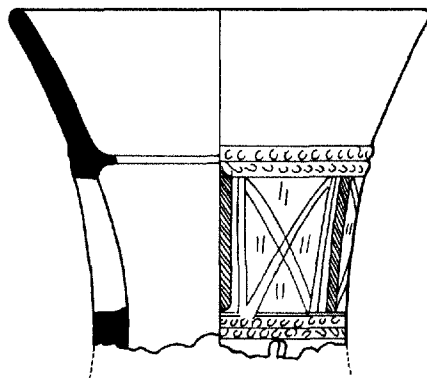

C.35-.0-- b

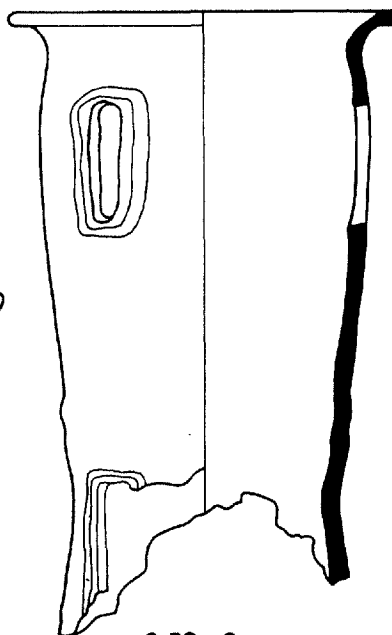

C.39-.0--

Form	Photo on Plate	Site	Square, Locus, or Area	Grave	Building or Level	Date of Find-Spot	Remarks	Comparanda	
								Site	Reference
C.363.810a		Kh	R 45 K 42:13 K 42:13*	122 123	Houses 2 Houses 3 Houses 3	ED III ED III ED III	Kh.I 45; B. See p. 90	Kish Farah	"A," Pl. XLIX 14 MJ XXII, Pl. XVII 2
C.363.810b	88e	Kh.	R 45 E 29:1 E 29:2*	164 162 161	Above Houses 2 Houses 1 or above Houses 1 or above	ED III Protoimp.? Protoimp.?	Kh.I 31f; C. See pp. 91, 105, 143-47	Kish Farah Mohenjo Daro	"A," Pl. XI 1 Fara, Pl. 20 d Pl. LV 5 (painted)
C.364.810a		Kh.	K 42:2 K 42:12 N 44:7 Q 49:1		Houses 4 Houses 3 Houses 3 Houses 4 or 3	ED II ED III ED III ED II or III	Kh.III 1127. See pp. 85, 90, 142-47	Kish Assur	"A," Pls. XI 1 and XLIX 9 Fig. 31 c
C.364.810b	88d	Kh.	P 42:2, robbers' hole N 44:5* Q 49:1 Q 49:1		Houses 4 Houses 4 or 3 Houses 4 or 3	ED III ED II ED II or III ED II or III	Kh.III 323; C. See pp. 85, 90, 142-47 Stem only Kh.IX 130; B. Incised decoration on base Plain base	Kish Ur	"A," Pl. XLIX 9 RC, Type 243
C.365.810a	88c 88a-b	Kh.	O 43:6 N 43:12 O 43:3	137 111 133	Houses 3 Houses 4 Houses 3	ED III ED II ED III	See pp. 85, 90, 142-47 3 specimens	Kish	"A," Pl. XLIX 8
C.365.810b	81e	Kh.	K 42:5 E 29:3* J 42:4* K 42:13 L 42:3* N 47:2 O 50:1 P 50:2 Q 43:9 V 44:1 Below H 20:40* J 20:38*	168 159 124 146 141 153	Above Houses 2 Houses 1 or above Houses 2 Houses 3 Houses 3 Oval II Houses 2 Houses 3 Houses 2 Houses 2 Houses Vc Houses Vc	ED III Protoimp.? ED III ED III ED III ED III ED III ED III ED III ED III ED III	Kh.III 620; C. See pp. 90, 105, 143-47 Rim only Kh.III 1407 Rim only Kh.VIII 189 As.33:287b. Bowl of As.33:287a	Kish	"A," Pl. XLIX 12
C.365.810c		Kh.	J 42:2 K 42:9 R 35:2*	126 167 166	Houses 3 or 2 Houses 2 Near surf.	ED III ED III ED III?	Kh.III 734. See pp. 88, 90 Kh.III 757	Kish Mari	"A," Pls. XI 6 and L 4 Syria XVI 139, Fig. 18 (taller)
C.365.810d	81d 89j 89i	Kh. Ag. As.	N 44:7 O 45:2* O 45:8* P 45:14* P 45:14* E 17:9* Q 13	131 2	Houses 3 Oval II Oval II Houses 2 Houses 2 Earlier N. Palace	ED III ED III ED III ED III ED III ED III	See pp. 90-91, 143-47 Kh.I 335. Stem fragment with incised multiple zigzag Kh.I 264 Kh.III 482. Stem only; covered with incised multiple zigzags Kh.III 1387. Stem fragment with 2 notched ridges and 2 openings As.33:34 Published in OIP LVIII as C.365.810e See C.365.810d	Kish Farah Susa	"A," Pls. XII 14, XLIX 17, and L 5 Fara, Pl. 20 a (frag.) Mém. XXV, Fig. 55:6
C.365.810e		Ag.	Q 13	2					
C.365.810		Kh.	N 43:2 S 42:1 V 44:2	143 144 156	Houses 2 Houses 2 Houses 1 or above	ED III ED III Protoimp.?	See p. 105		
C.366.810	81a 81c	Kh.	P 43:23 N 43:15* P 43:23* P 43:28*	91 113 89 108	Houses 6 Houses 4 Houses 6 Houses 4	ED II ED II ED II ED II	See pp. 85, 142	Assur	Pl. 18:25
C.367.810	81b	Kh.	N 44:6 P 43:28	110 108	Houses 4 Houses 4	ED II ED II	Kh.V 293; C. See pp. 85, 142 Kh.V 290; B. With plain notches and no undulating line on rim	Assur	Pl. 18:18
C.39-0--	88e	As.	D 17:8		Square Temple	ED II	As.33:495; B. See Pl. 173 for drawing and p. 81		

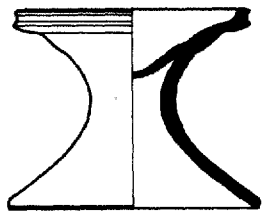

C.363.810 *a*

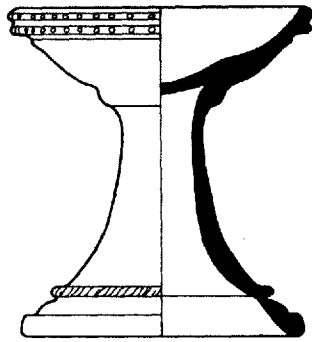

C.365.810 *b*

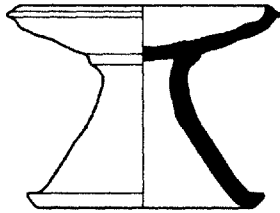

C.363.810 *b*

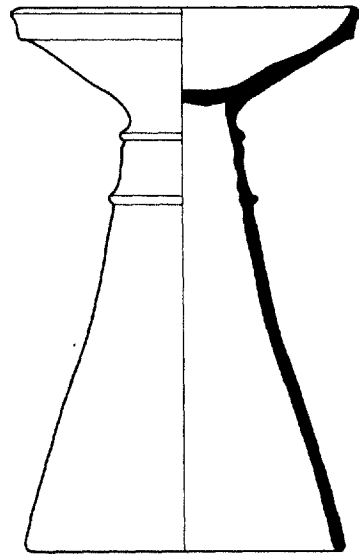

C.366.810

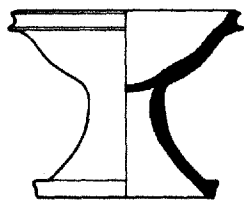

C.364.810 *a*

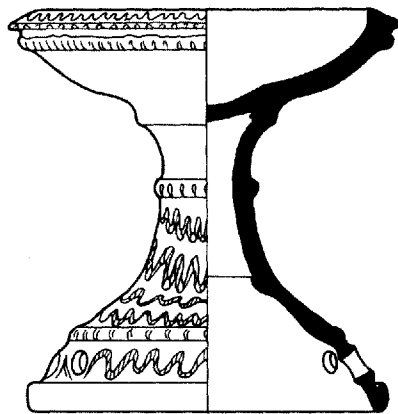

C.365.810 *c*

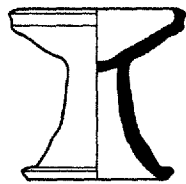

C.364.810 *b*

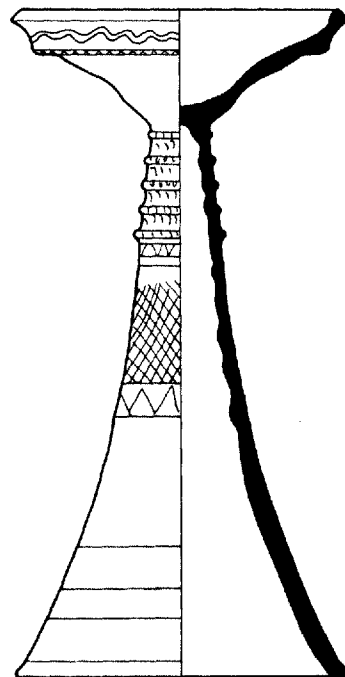

C.367.810

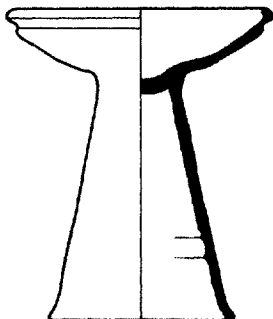

C.365.810 *a*

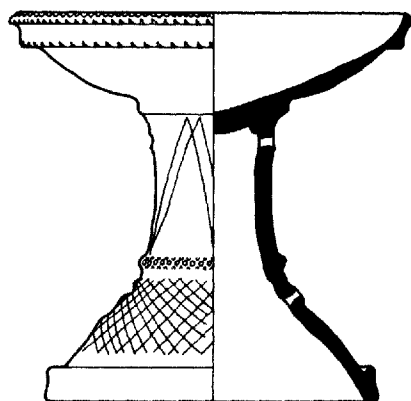

C.365.810 *d*

C.404-C.427

Form	Photo on Plate	Site	Square, Locus, or Area	Grave	Building or Level	Date of Find-Spot	Remarks	Comparanda	
								Site	Reference
C.404.350		Kh.	E 29:3	159	Houses 1 or above	Protoimp.?	Kh.VI 39. See pp. 96, 107	Kish	"A," Pl. XIII 23
			P 36:1*	160	Houses 1 or above	Protoimp.?	Undecorated; no ridge		
			S 42:1	144	Houses 2	ED III	Undecorated		
			V 44:1	153	Houses 2	ED III			
C.404.362	74h	Kh.	O 43:11		Small Temple VIII	ED II	2 specimens. See pp. 81, 91		
C.405.362		Kh.	K 42:13*	122	Houses 3	ED III	6 specimens		
C.405.363		As.	P 43:42	51	Houses 11	ED I	As.33:235. See pp. 97, 117, 121		
C.406.340	99k 99/	Kh.	V 44:2	156	Houses 1 or above	Protoimp.?	Kh.VIII 187. See pp. 96, 106	Nuzi	Pl. 53 A
			V 44:2	156	Houses 1 or above	Protoimp.?	Kh.VIII 188		
C.406.370		Kh.	V 44:1	153	Houses 2	ED III	See p. 96		
C.412.253	32d	Kh.	P 43:54		Below Houses 12 (33.70 m.)	Protolit.d?	Kh.LX 194; P. See Pl. 2 and pp. 45-46	Jamdat Nasr	AJA XXXIX, Pl. XXX 5
C.413.253a	22d	Kh.	Q 42:26		Sin III	Protolit.c	Kh.VII 172; C. See p. 40	Jamdat Nasr	Mackay, Pl. LXIV 7 and 13; AJA XXXIX, Pl. XXX 7
C.413.253b		Kh.	Q 42:26		Sin III	Protolit.c	See p. 40	Jamdat Nasr Farah	Mackay, Pl. LXIV 13; AJA XXXIX, Pl. XXX 6 MJ XXII, Pl. XXV 2
C.413.253c		Kh.	Q 42		(Sin I)	Protolit.c	Kh.VIII 220; B. See p. 40; published in OIP LVIII as C.414.253		
C.414.253		Kh.	Q 42:26		Sin III	Protolit.c	Kh.VII 174. See p. 40; reddish paste, cream slip	Jamdat Nasr	Mackay, Pl. LXIV 13; AJA XXXIX, Pl. XXX 6
			Q 42:26		Sin III	Protolit.c	Kh.VII 177; C. Dark red paint over light slip		
			Q 42				See C.413.253c		
C.416.370		Kh.	P 43:40-41	54	Houses 10	ED I			
C.417.262		Kh.	P 43:42	51	Houses 11	ED I	2 specimens		
C.427.570	114h	As.	J 20:10		Houses III	Gutlum-Ur III	As.32:P.27. See pp. 114, 148	Susa	Mém. I, Fig. 147

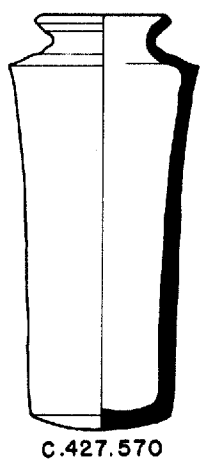
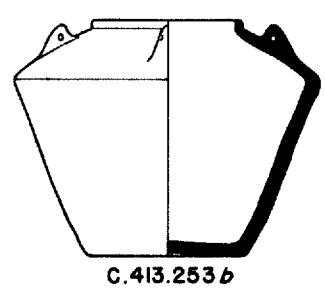
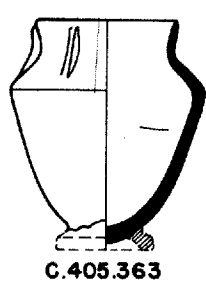
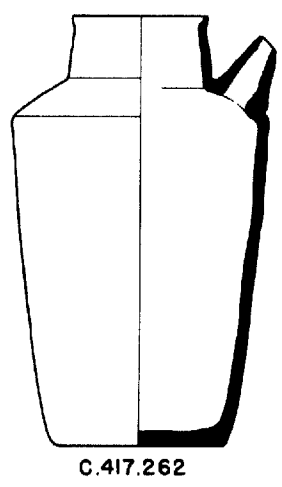
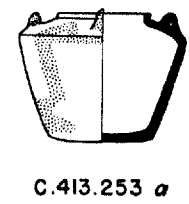
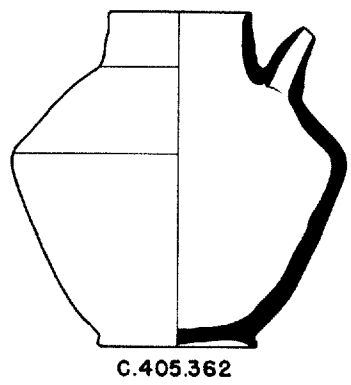
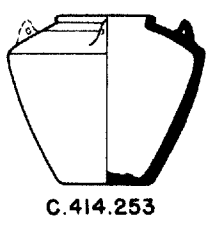
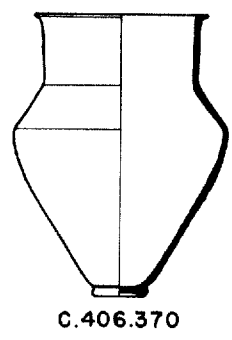
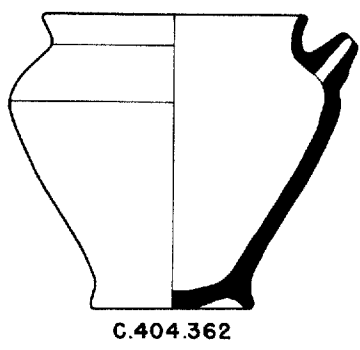
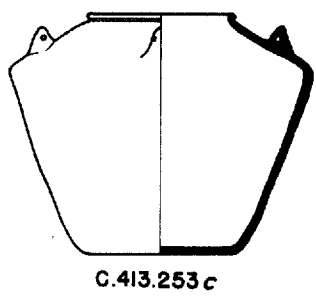
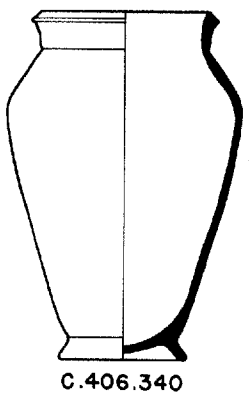
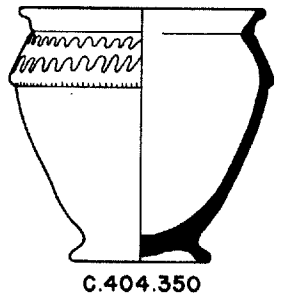

Form	Photo on Plate	Site	Square, Locus, or Area	Grave	Building or Level	Date of Find-Spot	Remarks	Comparanda	
								Site	Reference
C.447.360		As.	P 32:1		60 cm. below surf.	Larsa	As.30:P.53; C. See p. 117		
C.455.253†		As.	D 17:33				See B.455.253		
C.455.353	44b	Kh.	P 42:24		Houses 11	ED I	Kh.VI 328; B. See pp. 55, 137		
C.456.353	42c, 44d	As.	D 17:15		Archaic Shrine II	ED I	As.34:152; B. See pp. 54-55, 137		
C.466.370		As.	J21* F 17:6 F 17:9 J 19:48 J 20:15		N. Palace N. Palace Houses IVb Houses Va	Protoimp.? Protoimp. Protoimp. E. Agade Protoimp.	As.31:P.9; B. See pp. 107, 111 Several specimens	Nuzi Assur Susa	Pl. 53 C Pl. 60 Mém. XXV, Fig. 55:8; Antiquity V, Pl. VIII
C.466.450		As.	G 18:2 W. of E 17:6 H 18:21 J 18:1 J 18:9 J 19:4		Houses IVa Outside N. Palace Houses IVa Houses IVa Houses IVb Houses IVa	L. Agade Protoimp.? L. Agade L. Agade E. Agade L. Agade	As.31:P.123; C. See pp. 107, 111-12, 146	Ur Nuzi Gaura Susa	RC, Type 198 b Pl. 52 I Pl. LXX 143 Mém. XX 131, Fig. 36 (left)
C.466.470		As.	H 18:12 E 16:18 G 18:11 H 18:14 J 19:1 J 20:10		Houses IVb N. Palace Houses IVb Houses IVb Houses II Houses IVa	E. Agade Protoimp. E. Agade E. Agade Gutium-Ur III L. Agade	As.31:P.106. See pp. 107, 111, 113	Assur Susa	Pl. 60 Mém. XXIX, Fig. 69:21; Antiquity V, Pl. VIII
C.466.570		As.	H 20:13		Houses Va	Protoimp.	See p. 107		
C.467.350		As.	G 13		Surf.	Agade?	As.34:163. See pp. 111-12		
C.467.560		As.	N 30:8		Below Bilalama	E. Larsa	As.31:P.44. See p. 118		
C.475.360		As.	J 19:21		Houses IVa	L. Agade	As.32:P.26. See p. 111		
C.475.370		As.	D 15:9		Earlier N. Palace	ED III	As.32:1306		
C.476.350		Kh.	P 36:1	160	Houses 1 or above	Protoimp.?	See p. 107		
C.477.270		As.	G 18:11 J 19:4		Houses IVb Houses IVa	E. Agade L. Agade	As.31:P.172. See p. 111		
C.477.350		Kh.	P 36:1	160	Houses 1 or above	Protoimp.?	See p. 107		
C.485.220		As.	M 34:12		Ibiquadad II	L. Larsa	As.31:P.95. See p. 118		
C.486.222		As.	D 16:9		Outside N. Palace	Protoimp.?	As.32:505. See p. 106		
C.486.320		As.	D 17:11		Archaic Shrine IV	ED I	As.33:639		

†In OIP LVIII a specimen of this form was erroneously listed from Kh. Q 42:24, Sin III or IV.

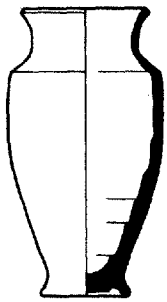

C.447.360

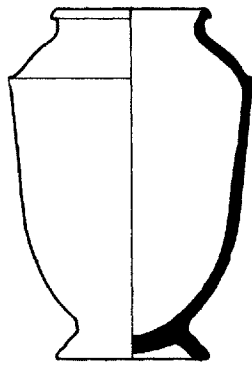

C.466.470

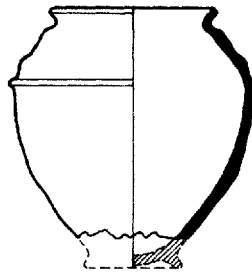

C.475.360

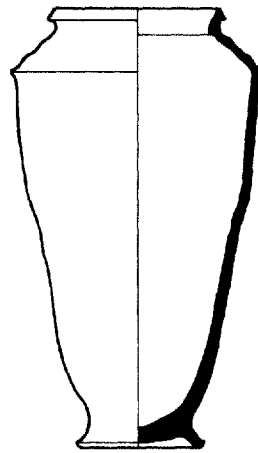

C.477.350

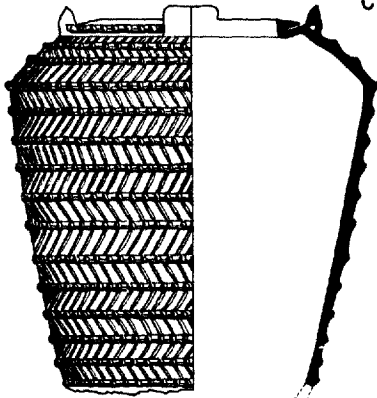

C.456.353

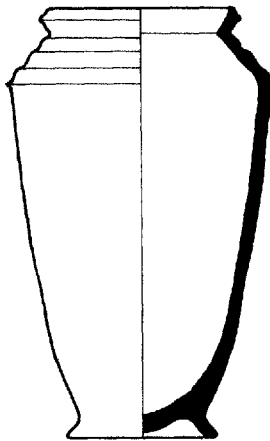

C.467.350

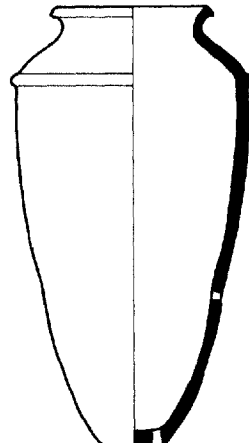

C.477.270

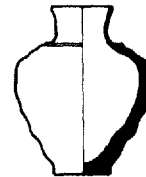

C.485.220

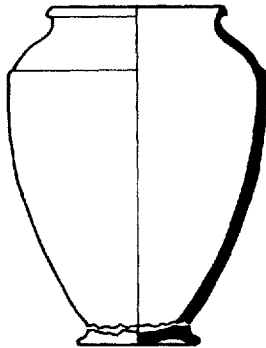

C.466.370

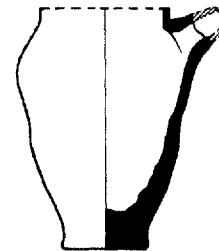

C.486.222

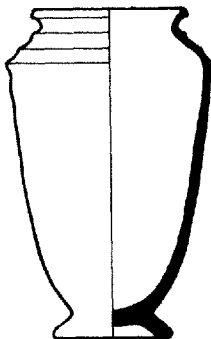

C.466.450

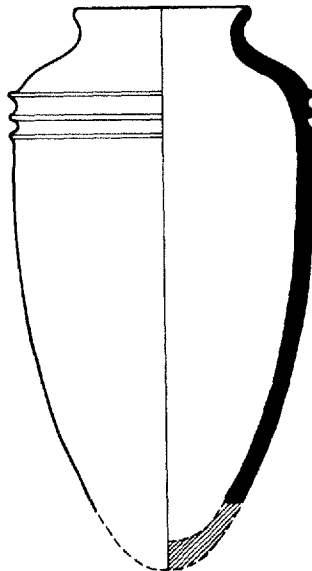

C.467.560

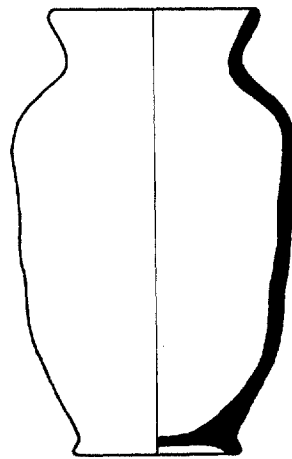

C.486.320

C.493-C.507

Form	Photo on Plate	Site	Square, Locus, or Area	Grave	Building or Level	Date of Find-Spot	Remarks	Comparanda	
								Site	Reference
C.493.253	28b	Kh.	Q 42:47		Sin I	Protolit.c	Kh.VII 280; C. See pp. 44-45, 127, 132; published in OIP LVIII as C.495.253		
C.493.360		Kh.	Mound B?			Old Bab.?	See p. 123		
C.494.253 [†]	28a	Kh.	Q 42:47		Sin I	Protolit.c	Kh.VII 281; B. See pp. 44-45, 127, 132		
C.494.273	29a	Kh.	Q 42:38		Sin III	Protolit.c	Kh.VII 152; B. See p. 45		
C.495.253							See C.493.253		
C.495.253	29b	Kh.	Q 42:26*		Sin III	Protolit.c	Kh.VII 180; C. See p. 45		
C.495.253			Q 42:26		Sin III	Protolit.c	Kh.VII 181; C. See Pl. 134b and p. 45		
C.495.253	29c		Q 42:39		Sin I	Protolit.c	Kh.VII 286; C. See pp. 37, 40		
C.503.470		Kh.	Q 42:9	167	Houses 2	ED III	Kh.III 1378		
C.504.360	99b	Kh.	R 45	164	Above Houses 2	ED III	Kh.I 31c. See p. 96	Kish	"A," Pl. LI 7
C.504.367	93b	Kh.	Q 45:7		Nintu VII	ED III	Kh.IX 74; B. See pp. 93, 143		
C.504.370		Kh.	K 42:5	168	Above Houses 2	ED III	Kh.III 615. See pp. 88, 96	Kish	"A," Pl. LI 11
			R 45*	163	Above Houses 2	ED III	Kh.I 18f; C		
C.505.320	99f	Kh.	N 44:5	119	Houses 4	ED II	See pp. 82, 96		
C.505.353	44a	As.	D 17:35		Archaic Shrine II	ED I	As.34:155; B. See pp. 54-55, 137		
C.505.360		Kh.	R 45	164	Above Houses 2	ED III	Kh.I 31e. See p. 96		
C.505.370a	99c	Kh.	R 45	164	Above Houses 2	ED III	Kh.I 31i. See p. 96		
C.505.370b		Kh.	K 42:12		Houses 3	ED III	Kh.III 771. See p. 96	Kish	"A," Pl. LI 10
			K 42:5*	168	Above Houses 2	ED III	Kh.III 617		
			P 50:2	141	Houses 3	ED III			
C.505.370c		Kh.	P 46:5		Houses 2	ED III	Kh.III 490. See p. 96	Kish	"A," Pl. XIII 25
			P 50:1	145	Houses 2	ED III			
C.505.470		As.	Below D 17:18		33.50 m.	ED III	As.34:57. See p. 96		
C.506.371	77a	Kh.	N 44:5	119	Houses 4	ED II	Kh.V 301; C. See pp. 84, 88; published in OIP LIII as C.516.371 from Oval I		
C.506.470a		Kh.	J 42:4		Houses 4	ED II	Kh.III 1206. See p. 96		
C.506.470b		Kh.	K 42:5	168	Above Houses 2	ED III	Kh.III 616. See p. 96	Kish	"A," Pl. LI 10
			J 42:4		Houses 3	ED III	Kh.III 884		
C.506.470c		Kh.	K 42:7		Houses 3	ED III	Kh.III 649. See p. 96		
			O 43:2*		Houses 1	ED III			
C.506.470d		Kh.	V 44:2	154	Houses 2	ED III	Kh.VIII 195. See p. 96	Ur	RC, Type 194
C.507.570		As.	M 32:5			Larsa	As.30:P.57. See p. 118		

[†]In OIP LVIII a specimen of this form was erroneously listed from Kh. Q 42:26, Sin III.

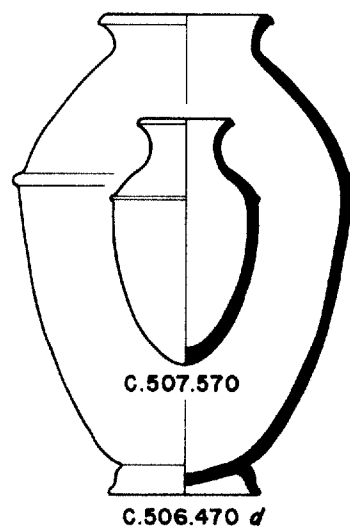
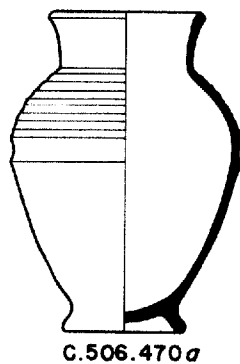
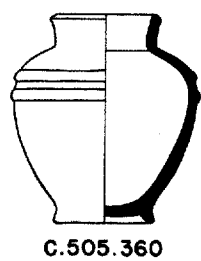
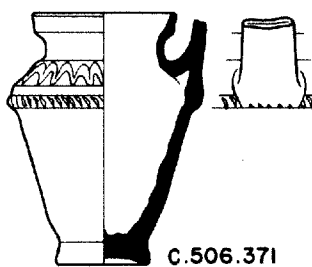
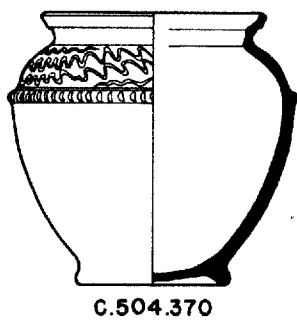
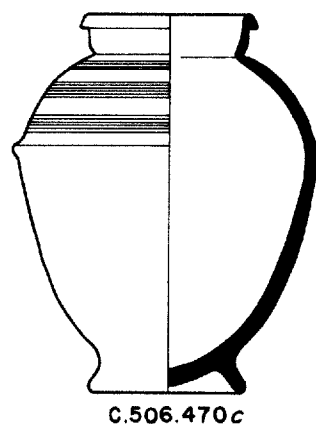
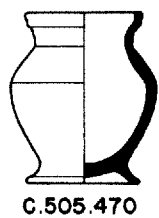
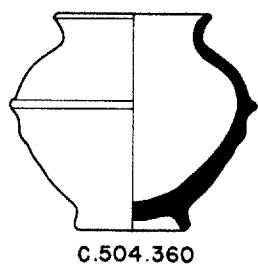
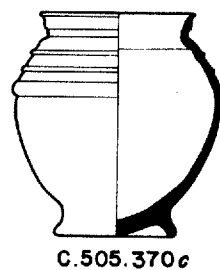
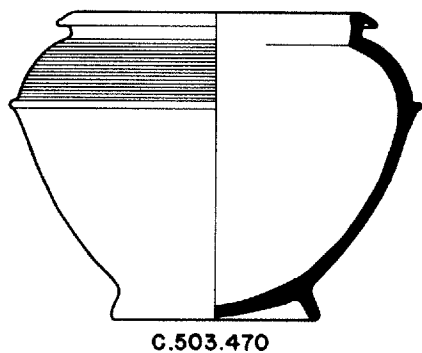
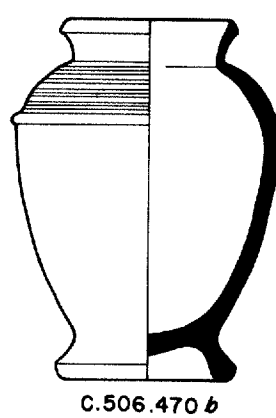
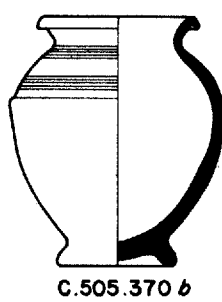
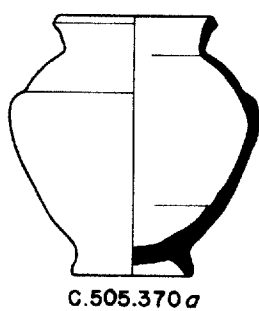
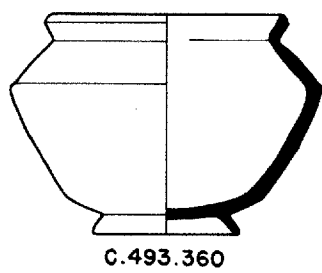

Form	Photo on Plate	Site	Square, Locus, or Area	Grave	Building or Level	Date of Find-Spot	Remarks	Comparanda	
								Site	Reference
C.513.270		Kh.	P 43:54	4	31.95 m.	Protolit.c	Kh.IX 220; B. Purple-red paint, obscure red and black design on shoulder; cf. B.513.170		
C.514.262		Kh.	O 43:55	14	Houses 12	Protolit.d	2 specimens		
C.514.350		Kh.	J 42:2	126	Houses 3 or 2	ED III	Kh.III 1379. Cf. C.404.350		
C.514.353	59	Kh.	P 43:42		Houses 11	ED I	Kh.IX 60; B. See Pls. 13-14 and pp. 53, 68-69		
C.514.362	37a	Kh.	N 44:13	44	Houses 11	ED I	See pp. 52, 135-36, 137, 138	Kish Jamdat Nasr Farah	"A," Pl. LI 20 Mackay, Pl. LXIII 25 (taller) MJ XXII, Pl. XXIV 1 (with painted bands and no beading)
C.514.370a	73g 54c	Kh.	P 43:23 P 43:43*	89	Houses 6 Houses 11	ED II ED I	Kh.V 116; C. See p. 80 Kh.IX 157; B. See Pl. 8 and p. 64	Ur al-Ubaid	AJ X, Pl. XL b Type LXXXVII
C.514.370b	54a, 65:28 54b 54d	Ag. Kh.	Hill B* Hill B O 43:42 O 43:45*		Top layer Top layer Houses 11 Houses 11	ED I ED I ED I	Ag.36:456; C. See pp. 64, 79 Ag.36:455; B Kh.IX 102; B. See Pl. 8 Kh.IX 158; P		
C.514.540		As.	D 17:11		Archaic Shrine IV	ED I	As.33:558. Cf. B.514.570		
C.515.262		Kh.	O 43:55 P 43:37 P 43:42 P 43:45 P 43:45	5 59 49 57 65	32.15 m. Houses 10 Houses 11 Houses 10 Houses 10	Protolit.c ED I ED I ED I ED I	See p. 38 2 specimens 4 specimens 3 specimens		
C.515.265		Kh.	P 42:50	9	32.70 m.	Protolit.c	Kh.VII 73. See pp. 38, 42	Jamdat Nasr	Mackay, Pl. LXIII 30
C.515.270	73f	Kh.	N 44:6	94	Houses 6	ED II	See p. 80		
C.515.361		Kh.	R 45	164	Above Houses 2	ED III	Kh.I 31h		
C.515.362	37c 37b 37g	Kh.	P 43:42 P 43:42 O 43:24 O 43:43 P 43:41 P 43:44* P 43:45 P 43:45	51 51 80 34 50 46 57 65	Houses 11 Houses 11 Houses 8 Houses 11 Houses 11 Houses 11 Houses 10 Houses 10	ED I ED I ED I ED I ED I ED I ED I ED I	See pp. 52, 135-36, 137, 138 Notched ridge 5 specimens	Jamdat Nasr	Mackay, Pl. LXIII 25 (no beading)
C.515.370a	99a	Kh.	K 43:3		Oval II	ED III	Kh.I 454; B. See pp. 95-96; published in OIP LIII as A.515.361 See p. 82	Kish Farah	"A," Pl. LI 6 MJ XXII, Pl. XV 3
	72m		N 44:6 P 43:44	94 29	Houses 6 Houses 11	ED II ED I			
C.515.370b		Kh.	L 42:5 P 42:15		Houses 3 Houses 7	ED III ED I	Kh.III 1323		
C.515.370	36e	Kh.	O 43:43		Houses 12	Protolit.d	Kh.IX 153; B. See Pl. 8 and pp. 49-50, 60		
C.515.371	78b 60-61	Kh.	N 44:14 N 44:14 K 51:1	92 92	Houses 6 Houses 6 Houses 4?	ED II ED II ED II?	Kh.V 286; C. See p. 84 Kh.IX 150; P. See Pl. 15 and pp. 69, 80		
	76f		N 44:6* E. of N 44:6	110	Houses 4	ED II ED II?	See p. 84		
	76c		N 44:11 O 43:14 P 42:9* P 43:23 P 43:27 P 43:27	101 109 97 89 86 87	Houses 5 Houses 4 Houses 5 Houses 6 Houses 6 Houses 6	ED II ED II ED II ED II ED II ED II	See p. 83 2(?) specimens		
C.515.373	47h	Ag. Kh.	O 13:1 P 43:40		30.50 m. Houses 11	ED I Protolit. d or ED I	Ag.35:47; B. See p. 57 Kh.IX 196; P. See Pl. 2 and p. 57		
	55b		P 43:42	31	Houses 11	ED I	Kh.IX 100; P. See Pl. 9 and p. 65		
	56a		P 43:42		Houses 10	ED I	Kh.IX 61; B. See Pl. 10 and p. 66		
C.515.463	100f	Kh.	O 43:6	137	Houses 3	ED III	See p. 97		
C.515.561		As.	W. of E 16:7		Houses above N. Palace	Agade?	As.32:P.4. See p. 110		
C.515.870	100e	Kh.	K 42:13 P 50:2	122 141	Houses 3 Houses 3	ED III ED III	Kh.III 1381. See pp. 97-98	Kish	"A," Pl. LII 7
C.516.240		As.	J 19:54 J 18:1		Houses Vb Houses IVa	ED III L. Agade	As.32:1264. See p. 96 As.32:1269		

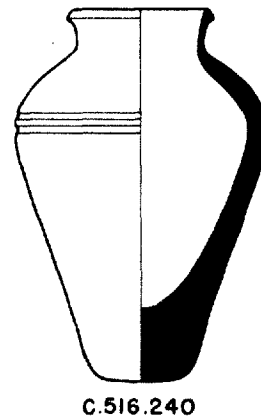
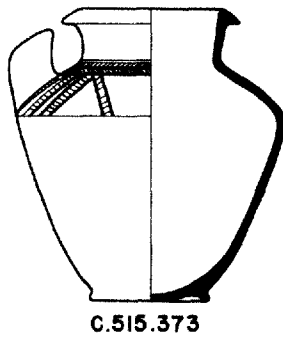
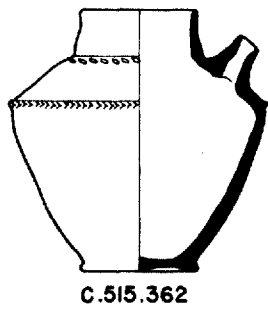
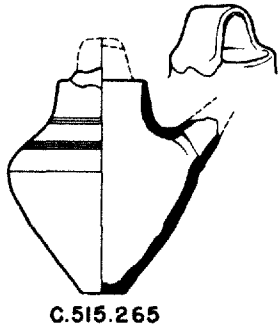
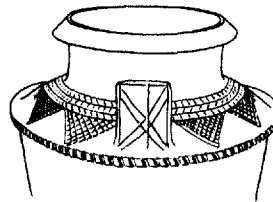
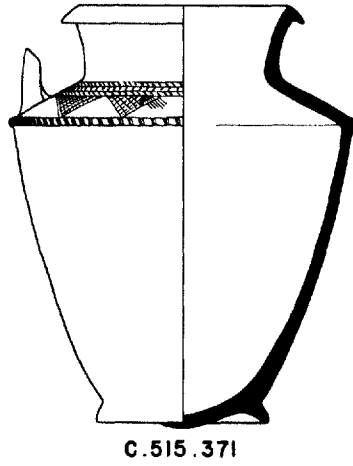
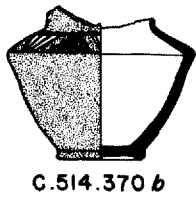
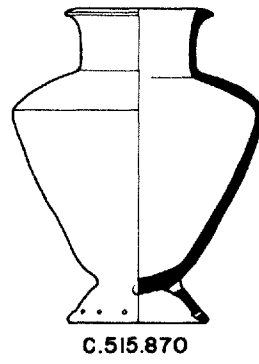
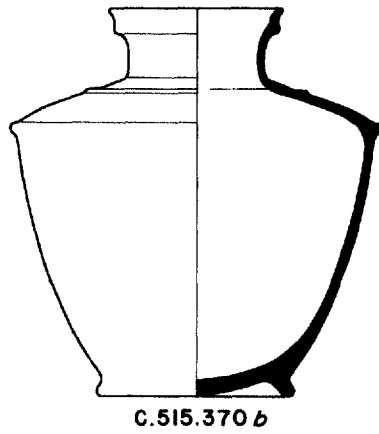
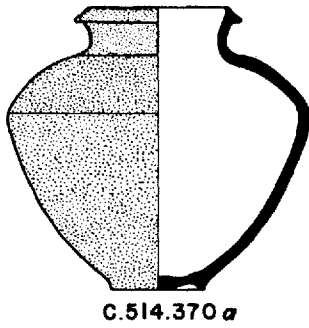
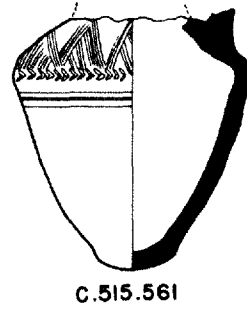
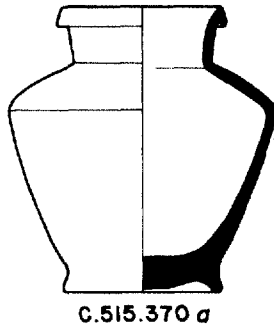
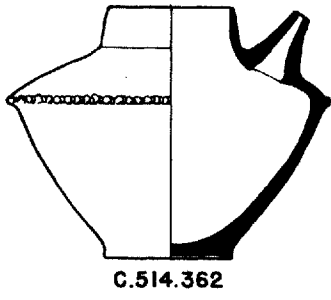

Form	Photo on Plate	Site	Square, Locus, or Area	Grave	Building or Level	Date of Find-Spot	Remarks	Comparanda	
								Site	Reference
C.516.262		Kh.	O 42:8 P 42:20 P 43:37 P 43:39 P 43:40 P 43:45 P 43:45 P 43:45 P 43:45 P 43:45 P 43:53	79 61 59 76 55 65 66 67 75 81	Houses 8 Houses 10 Houses 10 Houses 9? Houses 10 Houses 10 Houses 10 Houses 10 Houses 9 Houses 8	ED I ED I ED I ED I ED I ED I ED I ED I ED I ED I	3(?) specimens 2 specimens		
C.516.270	18b 18a	Kh.	P 43* Q 42		(Sin II) (Below Sin I)	Protolit.c Protolit.c	Kh.IX 148; B. See pp. 35, 126 Kh.IX 159; P. See Pls. 1 and 133 a and pp. 35, 126		
C.516.273	47b	Kh.	O 43:24 P 42:20 P 43:60	80 30 25	Houses 8 Houses 11 Houses 12	ED I ED I Protolit.d	See p. 57 Cf. C.516.373 Notched ridge and 4(?) lugs around shoulder, traces of red paint		
C.516.362	67d	Kh.	N 43:12 N 44:11 P 42:20 P 43:39 P 43:45 P 43:45 P 43:45	111 101 40 76 57 65 73	Houses 4 Houses 5 Houses 11 Houses 9? Houses 10 Houses 10 Houses 9	ED II ED II ED I ED I ED I ED I ED I	See p. 80 5(?) specimens 5 specimens		
C.516.370		Kh. As.	P 43:41 P 43:41 P 43:51* D 17:15*	50 62 27	Houses 11 Houses 10 Houses 12 Archaic Shrine III	ED I ED I Protolit.d ED I	Plain; see p. 59 Plain Plain As.34:144. Painted; see Pl. 136c and p. 63		
C.516.371a		As.	J 20:1 H 20:11 S. of H 20:20 F 15:9*		Houses Va Houses Va Houses V Street outside N. Palace	Protoimp. Protoimp. Protoimp.? Protoimp.	As.32:1019. See p. 105 As.32:864. Sherds with broken handle	Kish Ur	"A," Pl. XLVIII 2 RC, Type 210
C.516.371b	77c 77b 76e 77f	Kh.	K 42:11* N 43:12 N 43:12 N 43:22 P 43:23 P 43:27 P 43:28 Q 49:1 Q 49:1	116 116 107 89 87 108 117 117	Houses 4 Houses 4 Houses 4 Houses 5 Houses 6 Houses 6 Houses 4 Houses 4 or 3 Houses 4 or 3	ED II ED II ED II ED II ED II ED II ED II or III ED II or III	Kh.III 1380 See pp. 84, 88, 89 Kh.V 113 2 specimens 2 specimens 2 specimens Kh.IX 232; P		
C.516.371		Kh.	K 43:3 N 44:5				See B.516.371b See C.506.371		
C.516.372		Kh.	P 43:45	66	Houses 10	ED I	2 specimens		
C.516.373	47a 47c 55c 57	Kh. Ag.	N 44:13 N 44:13 O 42:8 O 43:41 P 43:42 P 43:42 P 43:44 P 43:45* P 43:45 P 43:45 P 43:53	44 43 79 58 33 51 29 66 67 75 81	Houses 11 Houses 11 Houses 8 Houses 10 Houses 11 Houses 11 Houses 11 Houses 10 Houses 10 Houses 9 Houses 8	ED I ED I ED I ED I ED I ED I ED I ED I ED I ED I	See p. 57 Kh.IX 164; P. See Pl. 9 and pp. 65-66 Ag.36:580; B. See Pl. 12 and pp. 67, 139 (n.91) Ag.36:540. See p. 78 Ag.36:541; C. See pp. 57, 78 Ag.36:543; B. See p. 78 Ag.36:547; B. See p. 79	Ur	AJ X, Pl. XL b
C.516.470	65:20 47k 65:18 65:22 65:24	Ag.	Hill B* Hill B Hill B Hill B*		Top layer Top layer Top layer	ED I ED I ED I			
C.516.471	84d	Kh.	P 43:28 R 35:2 O 50:1 S 42:1 V 44:1 V 44:2	108 166 144 153 154	Houses 4 Near surf. Sin X? Houses 2 Houses 2 Houses 2 Houses 2	ED II ED III? ED III? ED III ED III ED III	See p. 87 Handle (Kh. IX 237) shown on Pl. 87j	Kish	"A," Type A
C.517.262		Kh.	O 42:8	79	Houses 8	ED I			
C.517.273	55d, 65:21	Ag.	Hill B		Top layer	ED I	Ag.36:454; B. See Pl. 137a and pp. 66, 78		
C.517.371	77g	Kh.	O 43:6	137	Houses 3	ED III	See pp. 84, 87		
C.524.262	19i	Kh.	O 43:36		Houses 12	Protolit.d	See pp. 38, 126, 135-36		
C.524.350	71a	Kh.	N 44:11	101	Houses 5	ED II	Kh.V 205; B. See pp. 82, 88, 141		
C.524.362	37f	Kh.	N 44:13	56	Houses 10	ED I	2 specimens. See p. 52		
C.525.262a		Kh.	P 43:45	67	Houses 10	ED I			
C.525.262b		Kh.	O 42:8 N 44:13*	79 44	Houses 8 Houses 11	ED I ED I		al-CUbaid	Type LXXXVII
C.525.262c	37h	Kh.	O 42:8	79	Houses 8	ED I	6 specimens. See p. 52	Farah	Fara, Pl. 17c
C.525.352	93a	Kh.	K 42:9	167	Houses 2	ED III	Kh.III 1373; B. See pp. 91, 93, 143		

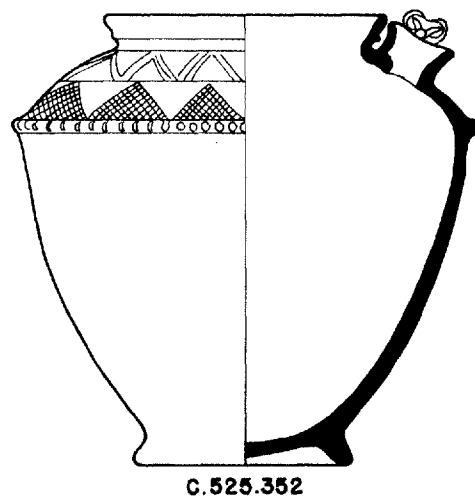
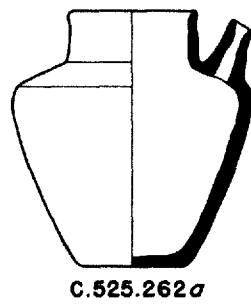
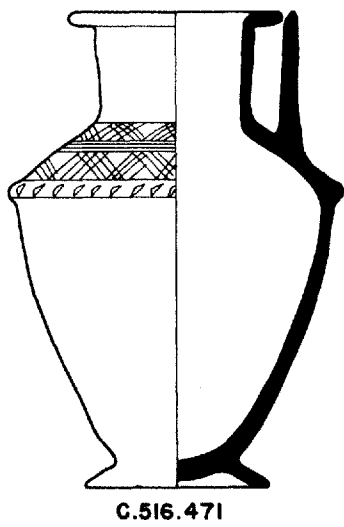
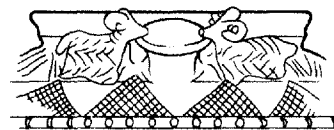
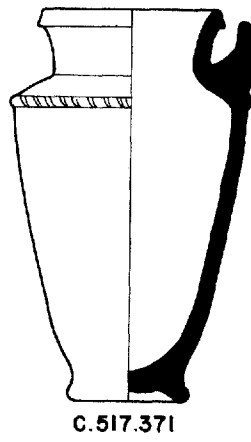
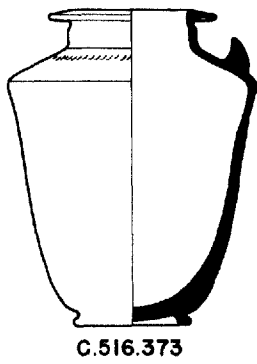
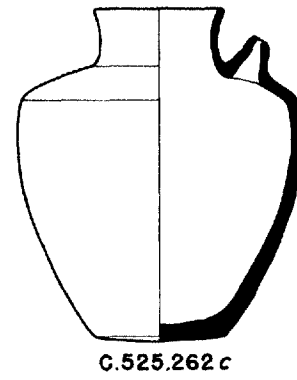
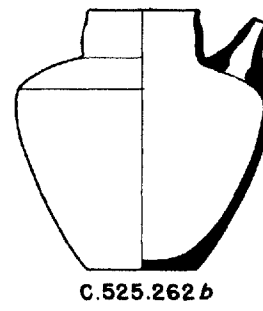
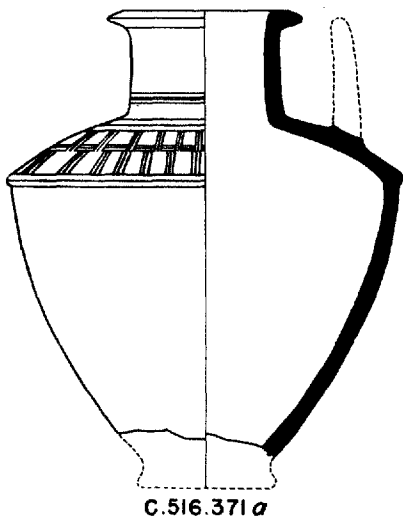

C. 525 - C. 526

Form	Photo on Plate	Site	Square, Locus, or Area	Grave	Building or Level	Date of Find-Spot	Remarks	Comparanda	
								Site	Reference
C. 525.362a	38e, 65:6 38d, 65:10 65:8	Ag.	Hill B		Top layer	ED I	Ag.36:534; C. See pp. 53, 78, 135-36		
			Hill B		Top layer	ED I	Ag.36:532; C		
C. 525.362b	67c	Kh.	Hill B N 44:13	56	Top layer Houses 10	ED I ED I	Ag.36:533; B Notched ridge as on C.515.362		
		Kh.	P 43:27	86	Houses 6	ED II	See p. 80; reserved slip on shoulder		
C. 525.370a	67f	As.	P 43:20 P 43:41 E 17:20*	93 62	Houses 6 Houses 10 Square Temple	ED II ED I ED II	As.33:424. See pp. 81, 141	Jamdat Nasr Farah Ur al-Ubaid	AJA XXXIX, Pl. XXXII 2 Fara, Fig. 34, F 54 RC, Type 158 Type XLII
		Kh.	N 43:15 E 29:2	113 161	Houses 4 Houses 1 or above	ED II Protoimp. ?	Kh.V 115. See p. 96		
C. 525.370b	52a	Ag.	Hill B, room VII		Top layer	ED I	Ag.36:475; C. See Pl. 135a and pp. 61, 96		
		Kh.	N 43:21*	98	Houses 5	ED II	Beveled ledge rim, plain ridge between body and shoulder		
C. 525.370c		Kh.	K 41:2		Houses 3	ED III	Kh.III 1103. Incised straight and undulating lines on shoulder		
C. 525.373		As.	D 16:31		Archaic Shrine II	ED I	As.34:146. See pp. 57-58 and OIC No. 20, Pl. IV 8		
			D 17:10		Archaic Shrine II	ED I	As.34:201. See p. 57 and ibid. Pl. IV 9		
C. 525.460		Kh.	P 43:23	89	Houses 6	ED II			
C. 525.462	90b	Kh.	O 43:6	137	Houses 3	ED III	See p. 91; cf. D.526.362		
C. 525.470a		Kh.	K 42:12		Houses 3	ED III	Kh.III 770. See p. 96		
C. 525.470b		Kh.	O 42:3	148	Above Houses 2	ED III	Kh.III 253		
C. 525.471	84a	Kh.	P 50:2	141	Houses 3	ED III	See p. 88		
C. 525.550		As.	H 20:13		Houses Va	Protoimp.	As.32:1017. See p. 108		
C. 526.262a	65:11	Ag.	Hill B		Top layer	ED I	Ag.36:536; B. See pp. 53, 78	al-Ubaid	Type LXXXII
C. 526.262b	37j	Kh.	O 42:8 P 43:34 P 43:41	79 70 62	Houses 8 Houses 9 Houses 10	ED I ED I ED I	14 specimens. See p. 52		
	37k, 65:7	Ag.	Hill B		Top layer	ED I	Ag.36:537; C. See p. 52, 78		
C. 526.262c	67h	As.	E 17:20		Square Temple	ED II	As.33:425. See p. 81		
C. 526.353		As.	D 17		Archaic Shrine II	ED I	As.34:207; B		
C. 526.362a	38g	Kh.	N 44:15		Houses 8	ED I	Kh.V 254; B. See p. 53		
C. 526.362b	38c	Kh.	P 43:34	70	Houses 9	ED I	See pp. 53, 81, 91	Farah Ur al-Ubaid	Fara, Fig. 31, F 2769 RC, Type 212 Type LXXXIII
			N 43:21	96	Houses 5	ED II	2 specimens		
			N 44:6	110	Houses 4	ED II	2 specimens		
			N 44:7	131	Houses 3	ED III	3 specimens		
			O 43:3	133	Houses 3	ED III	Kh.V 246; B		
			O 43:3	133	Houses 3	ED III	3(?) specimens		
			O 43:6	137	Houses 3	ED III	Kh.V 270; C		
			P 43:23	91	Houses 6	ED II			
			P 43:40	55	Houses 10	ED I	2 specimens		
			P 43:41	62	Houses 10	ED I			

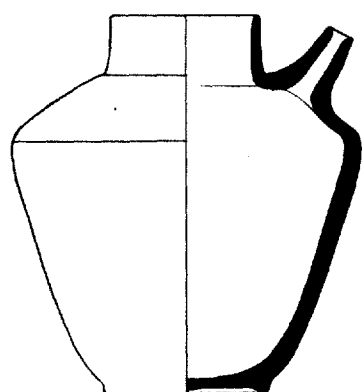

C.525.362 *a*

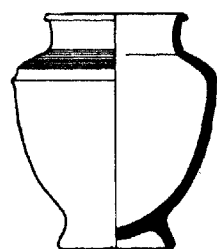

C.525.470 *a*

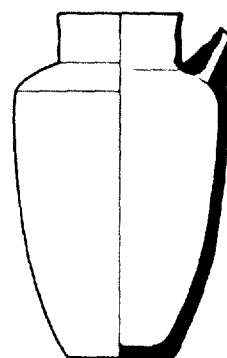

C.526.262 *b*

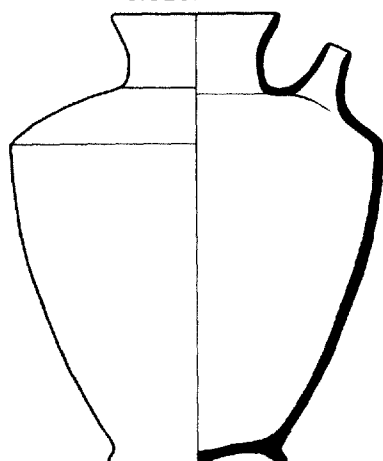

C.525.362 *b*

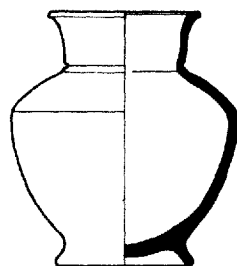

C.525.470 *b*

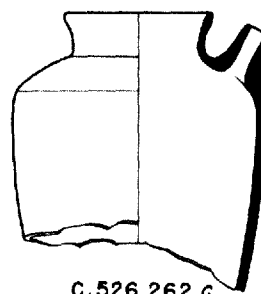

C.526.262 *c*

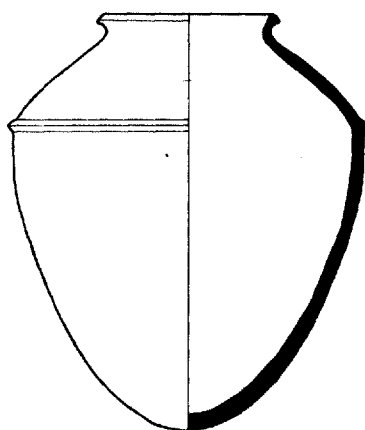

C.525.550

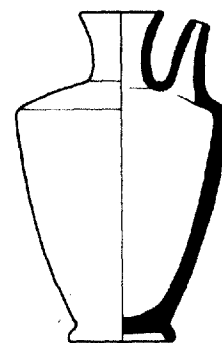

C.526.362 *a*

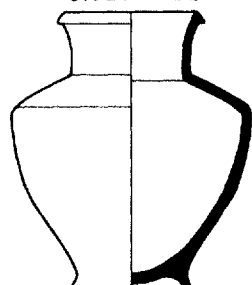

C.525.370 *a*

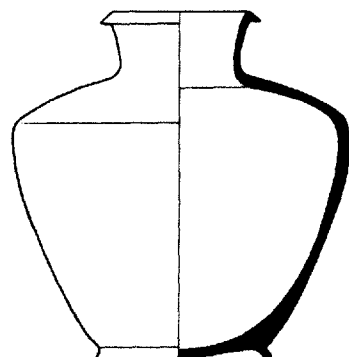

C.525.370 *b*

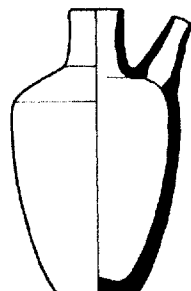

C.526.262 *a*

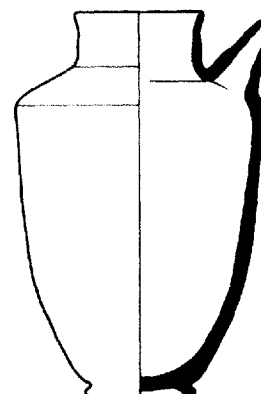

C.526.362 *b*

Form	Photo on Plate	Site	Square, Locus, or Area	Grave	Building or Level	Date of Find-Spot	Remarks	Comparanda	
								Site	Reference
C.526.370		Kh.	P 43:45	75	Houses 9	ED I	Cf. C.525.370a		
C.526.371a		Kh.	F 36		Town wall	ED III?	See pp. 83-85, 87-90; zigzag (cf. Pl. 78a) on shoulder on either side of handle	Kish Musyan	Kish IV, Pl. I 9 Mém. VIII, Fig. 104
	76d		N 44:6	103	Houses 5	ED II			
	78a		O 43:3	133	Houses 3	ED III			
			P 43:23	89	Houses 6	ED II	Kh.V 247; B		
C.526.371b	79b, 85a	Kh.	R 45		Houses 3	ED III	Kh.I 79; C. From disturbed burial. See pp. 83-85, 87-90		
	79a		K 42:13	122	Houses 3	ED III			
			K 42:13	124	Houses 3	ED III	Kh.III 1374; C		
	77e		K 42:13*	124	Houses 3	ED III			
			N 44:7	131	Houses 3	ED III	2(?) specimens		
C.526.371		Kh.	P 43:23	91	Houses 6	ED II	2 specimens. See pp. 83-85, 87-90		
	84b		M 51*		Houses 2?	ED III?			
	76b		P 43:27	87	Houses 6	ED II	4(?) specimens		
			P 43:33*	83	Houses 7?	ED I	See p. 83, n. 129; handle shown on Pl. 86o (see p. 89)		
			P 43:39	76	Houses 9?	ED I	See p. 83, n. 129		
C.526.373a	47d	Kh.	P 43:33	78	Houses 8	ED I	See pp. 57, 138	Kish	Kish IV, Pl. I 12 (flat base)
		Ag.	P 43:33	78	Houses 8	ED I	2(?) specimens		
			N 13:1				See D.526.373		
C.526.373b	47f	Kh.	O 43:3	133	Houses 3	ED III	ED I survival? See pp. 57, 97, 138	al- ^c Ubaid Mari	Pl. LIII (top right) Syria XLX, Pl. II 4 = p. 84, Fig. 1 B (more ovoid)
			O 43:6*	137	Houses 3	ED III	ED I survival? See pp. 57, 97, 138		
C.526.373		Kh.	N 44:13	56	Houses 10	ED I	2 unpainted specimens		
	55a		O 43:43	47	Houses 11	ED I			
	47e		O 43:43	52	Houses 11	ED I	Kh.VI 69; B. See Pl. 9 and p. 65		
			P 43:33*	83	Houses 7?	ED I	See p. 57		
			P 43:35*	84	Houses 7	ED I			
	47j, 65:17	Ag.	Hill B		Top layer	ED I	Ag.36:548; C. See pp. 57, 78; 2 incised lines on shoulder		
	65:16		Hill B*		Top layer	ED I	Ag.36:576; B. See p. 78		
	55e		Hill B, room VI*		Top layer	ED I	Ag.36:471; B. See p. 66		
	56b		N 12:1*		30.00 m.	ED I	Ag.35:1032; B. See Pl. 11 and p. 66		
C.526.460		Kh. As.	P 46:4 D 17:11*		Houses 2 Archaic Shrine IV	ED III ED I	Kh.III 481; B. See p. 96 As.33:728		
C.526.471a		Kh.	Y 43		Houses 1 or above	ED III?	Kh.VIII 96; B. See pp. 87-90	Kish	"A," Pl. X 21 (goddess handle)
			E 29:1	162	Houses 1 or above	Protoimp.?	See p. 105		
	87e		R 45*	163	Above Houses 2	ED III	Kh.I 18d; C		
	84c		T 44?		Houses 2?	ED III?			
C.526.471b		Kh.	U 46?		Near surf.	ED III	See pp. 87-90	Kish Mari	"A," Pl. XLVIII 1 (goddess handle) Syria XVI 9, Fig. 4 (lower base) Mém. XXV, Fig. 55:5
C.526.471c		Kh.	K 42:9	167	Houses 2	ED III	Kh.III 1027. See pp. 87-90	Kish Susa	"A," Type A Antiquity V, Pl. IX
			K 42:5*	168	Above Houses 2	ED III			
			K 42:7*		Houses 3	ED III	Neck only		
		Ag.	K 42:13*	123	Houses 3	ED III	Base only		
			Q 13	2			See C.526.471d		
C.526.471d		Kh.	E 29:3	159	Houses 1 or above	Protoimp.?	See pp. 87, 105	Kish	"A," Type A
			E 29:2*	161	Houses 1 or above	Protoimp.?			
	84f	Ag.	Q 13	2			Ag.35:563; C. See p. 88; published in OIP LVIII as C.526.471c		
C.526.471e	77d	Kh.	O 43:6	137	Houses 3	ED III	See pp. 84, 87-90		
			N 44:7	131	Houses 3	ED III	No design on shoulder; plant motif on handle		
C.526.471f		Kh.	K 42:17	130	Houses 3	ED III	Kh.III 1277; B. See pp. 87-90		
			K 42:9	167	Houses 2	ED III	Kh.III 1372; C		

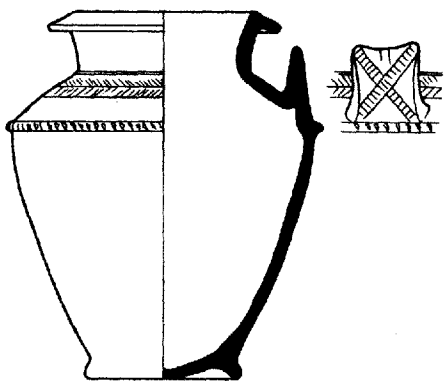

C.526.371a

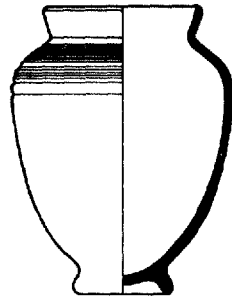

C.526.460

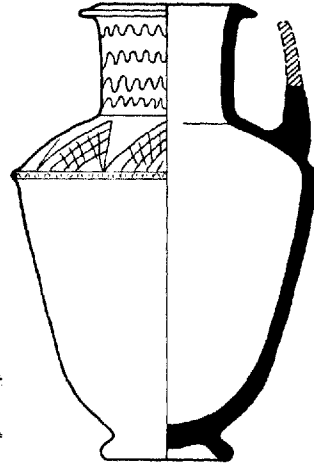

C.526.471d

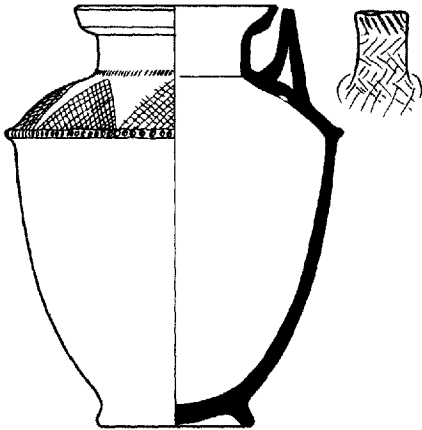

C.526.371b

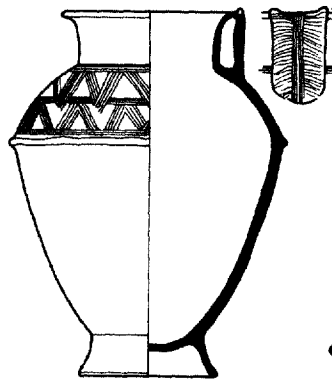

C.526.471a

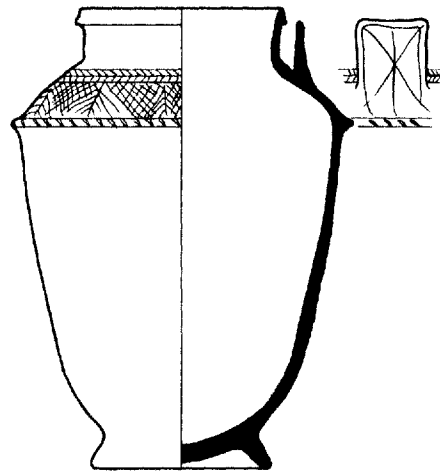

C.526.471e

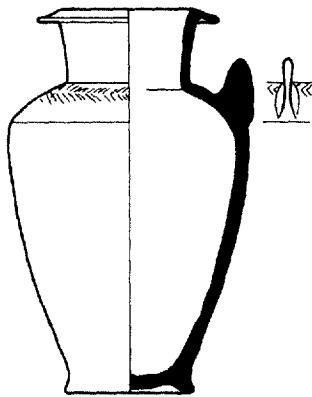

C.526.373a

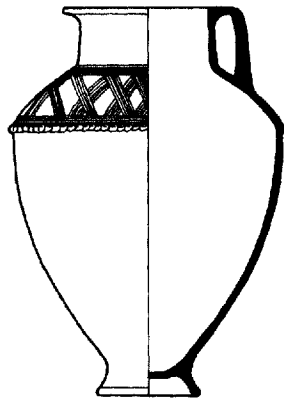

C.526.471b

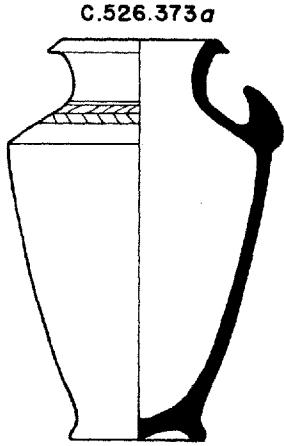

C.526.373b

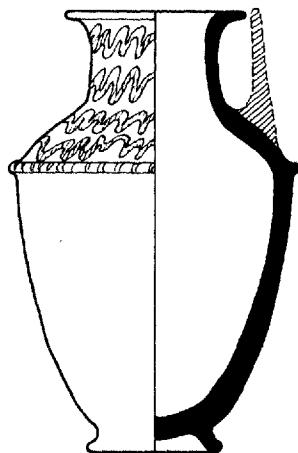

C.526.471c

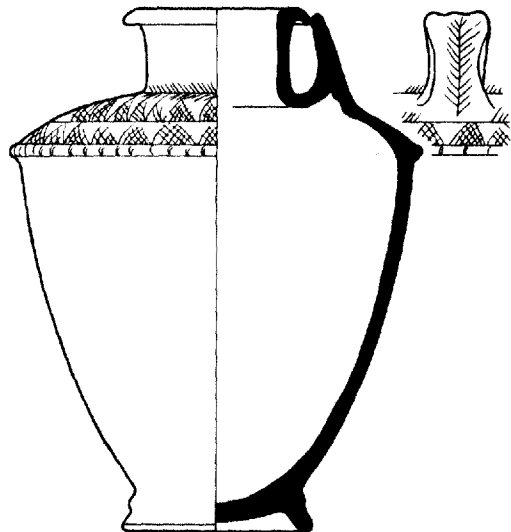

C.526.471f

C. 527-C. 544

Form	Photo on Plate	Site	Square, Locus, or Area	Grave	Building or Level	Date of Find-Spot	Remarks	Comparanda	
								Site	Reference
C. 527.362	90e	Kh.	L 42:8 K 42:13 K 42:13	123 124	Houses 3 Houses 3 Houses 3	ED III ED III ED III	Kh.III 1150; B Kh.III 1413-14 Kh.III 1375; C. See p. 91	Kish	"A," Pl. LI 23
C. 527.471	84e	Kh.	V 44:2	156	Houses 1 or above	Protoimp.?	Kh.VIII 192; P. See pp. 87, 88, 89, 105	Kish	"A," Type A
C. 533.313	40a	Kh.	Q 42:17 Q 42:17		Sin V Sin V	Protolit.d or ED I Protolit.d or ED I	Kh.VII 15; C. See pp. 41, 53; cover is of form B.042.500a Kh.VII 14		
C. 534.222	19g 19e	Kh.	P 43:54 O 43:55	10 18	32.85 m. Houses 12	Protolit.c Protolit.d	See p. 38 See p. 37	Telloh	G I, Pl. VII 4806 (long, curved spout)
C. 534.240		Kh.	P 43:58		Houses 12	Protolit.d	Kh.IX 219; P. See p. 36	Jamdat Nasr	Mackay, Pl. LXV 35
C. 534.262	19a	Kh.	P 43:45 P 43:54	57 1	Houses 10 31.95 m.	ED I Protolit.c	See p. 37		
C. 534.313	40b	As.	D 17:15		Archaic Shrine II (Sin II)	ED I	As.34:168; C. See p. 53		
C. 534.620		Kh.	P 42:50			Protolit.c	Kh.VII 32		
C. 535.222	37d	Kh.	N 43:2* N 44:13	143 43	Houses 2 Houses 11	ED III ED I	See p. 52		
C. 535.240	23k 18g	Kh.	P 42:20 O 43:55 P 43:54 P 43:60	22 10 25	Houses 11 Houses 12 32.85 m. Houses 12	Protolit.d Protolit.d Protolit.c Protolit.d	Kh.IX 228; B. See p. 42 Kh.IX 223; P. Narrow base Kh.IX 154; B. See p. 36 Narrow base		
C. 535.242	19d	Kh.	P 42:50	8	32.70 m.	Protolit.c	Kh.VII 113; C. See pp. 37, 132, 134	Jamdat Nasr al- ^c Ubaid Brak Susa Badari	Mackay, Pl. LXIII 11 Type P xv B (painted) ILN, Oct. 15, 1938, p. 698 Mém. XXV, Fig. 32:8 Pl. XXXVIII 58 1
C. 536.270	18e	Kh.	P 42:50		(Sin II)	Protolit.c	Kh.VII 34; C. See pp. 36, 135 (n. 52)	Jamdat Nasr al- ^c Ubaid	Mackay, Pl. LXV 28 Type LV
C. 536.520		As.	J 19:54		Houses Vb	ED III	As.32:1263. See p. 96		
C. 536.540		As.	H 18:14		22-21 m.	Protolit.d	See pp. 36, 77 and Pl. 64:57		
C. 537.240		Kh.	P 43:54	1	31.95 m.	Protolit.c	See p. 36		
C. 537.270	18f	Kh.	P 43:60	25	Houses 12	Protolit.d	Kh.IX 222; B. See pp. 36, 126		
C. 544.222		Kh.	P 42:50	8	32.70 m.	Protolit.c	Kh.VII 40; B. See p. 38		
C. 544.310		Kh.	P 43:39	76	Houses 9?	ED I			
C. 544.312		As.	J 19:10 D 16:9 F 17:9A* H 18:21		Houses III 36.25 m. N. Palace Houses IVa	Gutium-Ur III Agade Protoimp. L. Agade	As.32:P.54. See pp. 106, 111, 113, 146 3 specimens As.32:P.63. Upper part only	Ur	RC, Type 215
C. 544.320		Kh.	N 44:5	119	Houses 4	ED II			
C. 544.520		Kh.	P 43:55-56	11	33.25 m.	Protolit.c	See p. 41		
C. 544.540	23c	Kh.	P 42:50		(Sin II)	Protolit.c	Kh.VII 35; C. See p. 41		

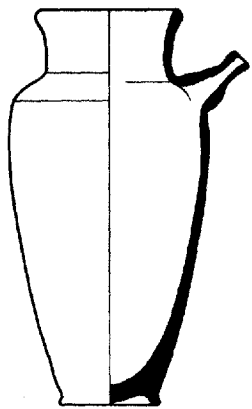

C.527.362

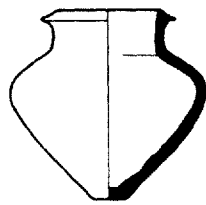

C.534.240

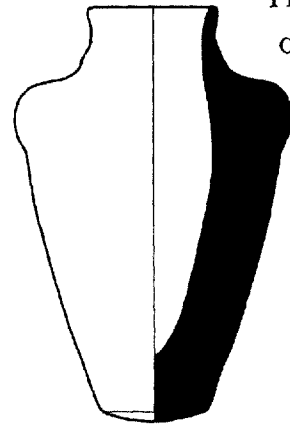

C.536.520

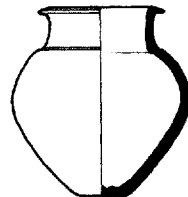

C.535.240

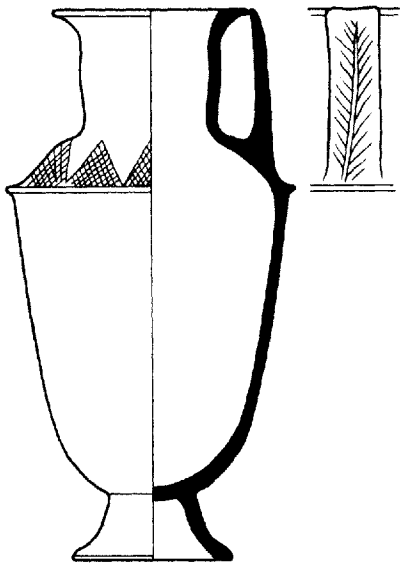

C.527.471

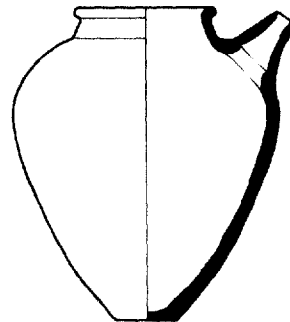

C.535.242

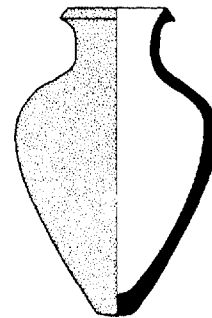

C.536.540

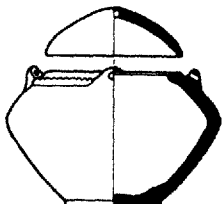

C.533.313

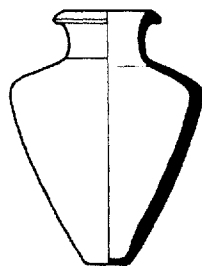

C.536.270

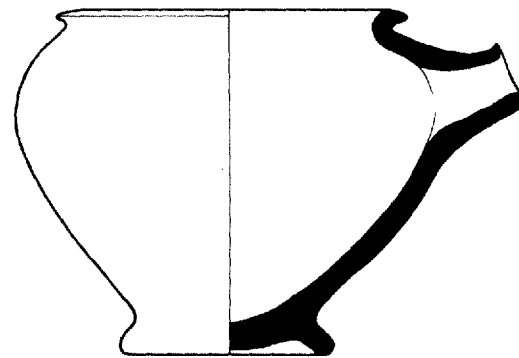

C.544.312

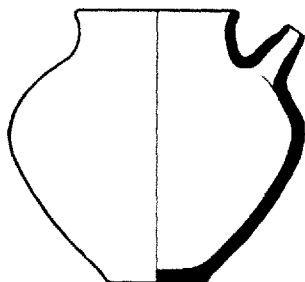

C.534.222

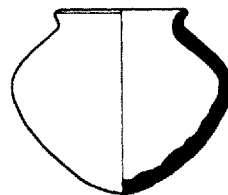

C.544.520

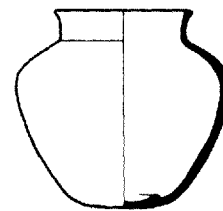

C.544.540

Form	Photo on Plate	Site	Square, Locus, or Area	Grave	Building or Level	Date of Find-Spot	Remarks	Comparanda	
								Site	Reference
C. 545.220		As.	D 17:16		Archaic Shrine III	ED I	As.34:112		
		Kh.	P 43:28*	108	Houses 4	ED II			
C. 545.222	37e	Kh.	N 44:13	56	Houses 10	ED I	See p. 52		
			P 43:33	78	Houses 8	ED I			
			P 43:39	69	Houses 9	ED I	2 specimens		
			P 43:45	86	Houses 10	ED I	2 specimens		
			P 43:45*	75	Houses 9	ED I			
		As.	E 16:45*		Archaic Shrine II	ED I	As.34:204		
C. 545.242	38b, 65:3	Ag.	Hill B		Top layer	ED I	Ag.36:539; C. See pp. 52-53, 78, 137		
C. 545.310		Kh.	L 42:5		Houses 3	ED III	Kh.III 1325. See p. 96	Kish Tellioh	"A," Pl. XIII 4 G II, Pl. XXVIII 3767
C. 545.320		Kh.	K 42:9	167	Houses 2	ED III	Kh.III 1028	Kish	"A," Pl. XIII 11
			K 42:2		Houses 4	ED II	Kh.III 1125		
			K 42:2		Houses 4	ED II	Kh.III 1128; B		
			K 42:13*	124	Houses 3	ED III	Kh.III 1408-10 and 1 unrecorded specimen. 2 with slight rims		
			K 42:17	130	Houses 3	ED III	Kh.III 1281 and 2 unrecorded specimens		
		99d	L 42:5	143	Houses 3	ED III	Kh.III 1327		
			N 43:2		Houses 2	ED III	See p. 96		
		99i	Q 42:11		Sin VI	ED I			
			R 44	165	Above Houses 2	ED III	Kh.I 55a; C. See p. 96		
			R 44	165	Above Houses 2	ED III	Kh.I 55b		
			R 45	164	Above Houses 2	ED III	Kh.I 31a		
		99h	Mound A		Near surf.	ED III?	See p. 96		
C. 545.322		Kh.	P 43:34	70	Houses 9	ED I			
C. 545.340a		Kh.	O 43:1		Houses 1	ED III	Kh.III 127. See p. 96		
C. 545.340b		Kh.	K 42:9	167	Houses 2	ED III	Kh.III 1026. See p. 96		
			Q 49:1	117	Houses 4 or 3	ED II or III			
C. 545.340c	121b	As.	P 30:1?		Ibalpiel I well?	L. Larsa?	As.30:P.43a; C. See pp. 118, 122		
			N 30:1*			Larsa	As.30:P.43b; B. Broken		
			P 34:1*		Ibiqadad II	Larsa	Broken		
C. 545.340d		As.	P 30:1?		Ibalpiel I well?	L. Larsa?	As.30:P.44a; C. See p. 118		
			K 31:1			Larsa	As.30:P.44b; B		
		107a	S 41:1		Houses 2	ED III	Kh.IX 87. See p. 103		
C. 545.342	30	As.	D 17:34		Earliest Shrine	Protolit.d	As.34:246; B. See Pl. 3 and pp. 46, 127		
			D 17:34		Earliest Shrine	Protolit.d	As.34:247		
C. 545.420		Kh.	Q 49:1	117	Houses 4 or 3	ED II or III			
C. 545.440		As.	SE. of K 31:1		2 m. below surf.	Larsa	As.30:P.24. See p. 118		
C. 545.520		Kh.	R 44	165	Above Houses 2	ED III	Kh.I 55f		
C. 545.640		Kh.	K 42:7		Houses 3	ED III	Kh.III 648. See pp. 82, 99	Kish	"A," Pl. LIII 51
			K 42:10		Houses 4	ED II	Kh.III 1297		
			K 43:10		Houses 4	ED II			
C. 546.222		Kh.	P 43:54	4	31.95 m.	Protolit.c	See p. 37		
C. 546.240		Kh.	O 43:55	5	32.15 m.	Protolit.c	Kh.IX 227; P. See p. 36		
C. 546.262		Kh.	P 43:23	89	Houses 6	ED II	See p. 81		
C. 546.320		As.	N 31:10		Above Bilalama	E. Larsa	As.31:P.11. See p. 118		
			M 33:3		Below Ibiqadad II	E. Larsa			
		Kh.	P 43:54*	19	Houses 12	Protolit.d	Part of neck only; plain greenish ware, wide neck		
C. 546.340		As.	F 17:10		N. Palace	Protoimp.	As.32:509		
			J 19:27		Houses Va	Protoimp.	As.32:1268		
C. 546.362		Kh.	N 44:6	94	Houses 6	ED II	See p. 80		
			P 43:27	86	Houses 6	ED II	2(?) specimens		
C. 546.540		As.	E 15:1*		N. Palace	Protoimp.	As.32:424. Neck missing		
			H 19:38*		Houses Vb?	ED III	As.33:671. Notched ridges on shoulder and upper body; lower part missing		
C. 546.620		Kh.	P 43:45	73	Houses 9	ED I			
C. 546.640		As.	E 15:2		N. Palace	Protoimp.	As.31:P.12; C. See pp. 107, 111		
			D 17:17			Protoimp.?			
			G 18:1		Houses IV	Agade			
			K 20:32		Houses Va	Protoimp.			
C. 547.242	114e	As.	G 18:3		Houses IVb	E. Agade	As.31:P.116b; C. See p. 111		

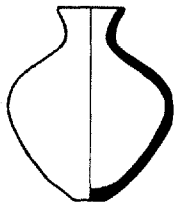

C.545.220

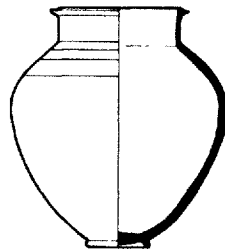

C.545.340*b*

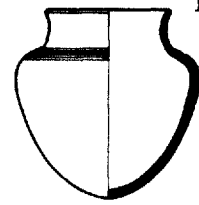

C.545.520

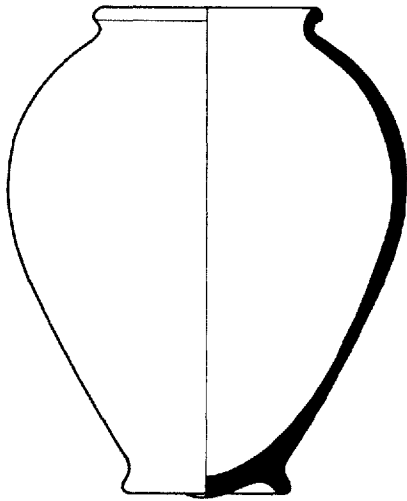

C.545.310

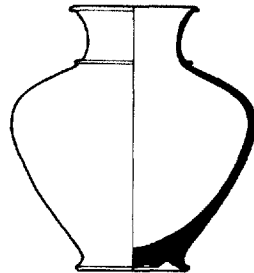

C.545.340*c*

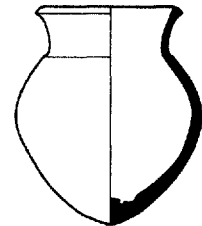

C.545.640

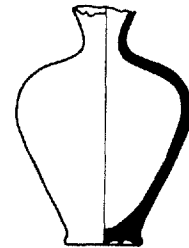

C.546.320

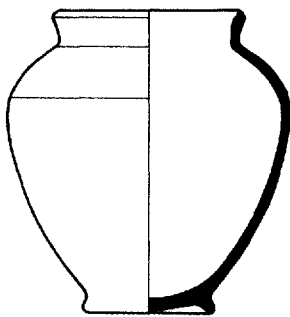

C.545.320

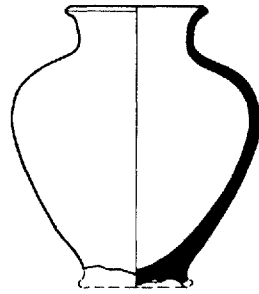

C.545.340*d*

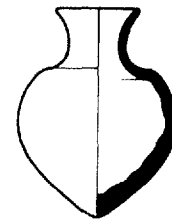

C.546.620

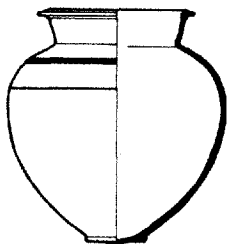

C.545.340*a*

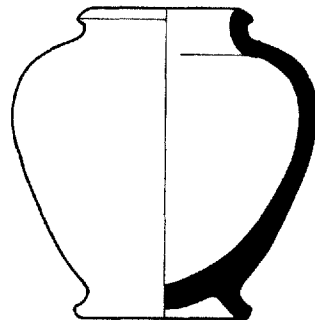

C.545.440

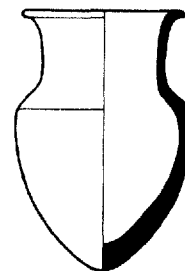

C.546.640

Form	Photo on Plate	Site	Square, Locus, or Area	Grave	Building or Level	Date of Find-Spot	Remarks	Comparanda	
								Site	Reference
C.547.320		Ish.	Q 29:3 R 30:1 V 32:12		(Kititum IV) Kititum III Houses	L. Larsa or Old Bab. L. Larsa L. Larsa or Old Bab.	Ish.P.28. See p. 117		
C.547.640a		As.	P 30:1		Ibalpiel I well	L. Larsa	As.30:P.12; C. See p. 118	Susa	Mém. XXV, Fig. 75:5
C.547.640b		As.	P 30:1		Ibalpiel I well	L. Larsa	As.30:P.120; C. See p. 118	Telloh Warka Babylon Ur al- ^c Ubaid	S, Pl. 42:1; G II, Pl. XXVIII 1115 UVB VI, Fig. 7, W 15255 a Koldewey, Fig. 165 (upper left) RC, Type 61 Type XXXIII
C.547.720	121f	As. Ish.	P 30:1 P 30:1 R 29:7 R 33:6 R 35:10, grave S 30:1 T 29:2 T 32, Road S. of Kititum Temple V 32:2 V 32:8 V 32:9 W 31:2		Ibalpiel I well Ibalpiel I well Kititum III Serai (Kititum IV) Serai (Kititum IV) Kititum I or II Kititum IV (Kititum IV?) Houses Houses Houses Shamash	L. Larsa L. Larsa L. Larsa L. Larsa L. Larsa or Old Bab. Larsa L. Larsa or Old Bab. L. Larsa or Old Bab. Larsa Larsa Larsa Larsa	As.30:P.14a. See pp. 116, 123, 149 As.30:14b; C Several specimens Ish.P.25		
C.548.720		As.	P 30:1 P 30:1		Ibalpiel I well Ibalpiel I well	L. Larsa L. Larsa	As.30:P.16a; C. See p. 116 As.30:P.16b (B) and several other specimens	Susa	Mém. I, Fig. 162
C.554.220		As.	D 17:16		Archaic Shrine III?	ED I	As.33:722; C. See Pl. 136h and p. 64		
C.554.520		Kh.	P 43:58	16	Houses 12	Protolit.d	See p. 41		
C.555.320		As.	P 30:1 K 31:1 O 30:18		Ibalpiel I well In or near kilns	L. Larsa Larsa Larsa	As.30:P.20. See p. 118		
C.555.353		As.	D 17:26		Archaic Shrine II	ED I	As.34:145		
C.555.420	99g	Kh. Ag.	R 45 O 42:6 P 46:4 R 45:3 S 42:1* V 44:1 V 44:2 Q 13	164 144 153 154 2	Above Houses 2 Houses 3 or 2 Houses 2 Houses 2 Houses 2 Houses 2 Houses 2	ED III ED III ED III ED III ED III ED III ED III	Kh.I 31b. See p. 96 Kh.III 1165-66 Kh.III 480 Kh.III 1367 2(?) specimens 2(?) specimens 3 or 4 specimens	Kish	"A," Pl. XIII 4
C.555.423		Kh.	P 44:6		Houses 2	ED III	Kh.III 825. See p. 98		
C.555.440		As.	H 18:7		Houses IVa or or III	L. Agade or Gutium-Ur III	As.31:P.111; C. See pp. 113-14		
C.555.510		As.	H 18:2		Houses III?	Gutium-Ur III?	As.31:P.105. See p. 114	Ur Shaghir Bazar	RC, Type 201 Iraq IV, Fig. 19:10
C.555.520		As.	D 17:16		Archaic Shrine III	ED I	As.34:126. Cf. C.594.220		
C.555.520		Kh.	S 42:1	144	Houses 2	ED III			
C.555.522	91a	As.	E 17:11		Below Single-Shrine I	ED III	As.33:106; B. See pp. 88, 92, 143; base may not belong with top	Kish	JRAS, 1930, Pl. X (ring base, no rim)
C.555.921	70k	Ag.	M 14:8		32.50 m.	ED II	Ag.35:516; B. See pp. 82, 142	Assur	WVDOG XXXIX, Fig. 32 (no handles)
C.556.242	38a 65:5 65:2 65:4	Kh. Ag.	O 42:8 O 42:8 Hill B Hill B Hill B	79 79	Houses 8 Houses 8 Top layer Top layer Top layer	ED I ED I ED I ED I ED I	3 specimens. See pp. 52-53, 137 Ag.36:538; B. See p. 78 Ag.36:530; B. See p. 78 Ag.36:531; C. See p. 78	Kish Farah al- ^c Ubaid Nineveh	Kish IV, Pl. I 2 b Fara, Fig. 32, F 2768 (no rim) Type LXXXV AAA XIX, Pl. LXI 16

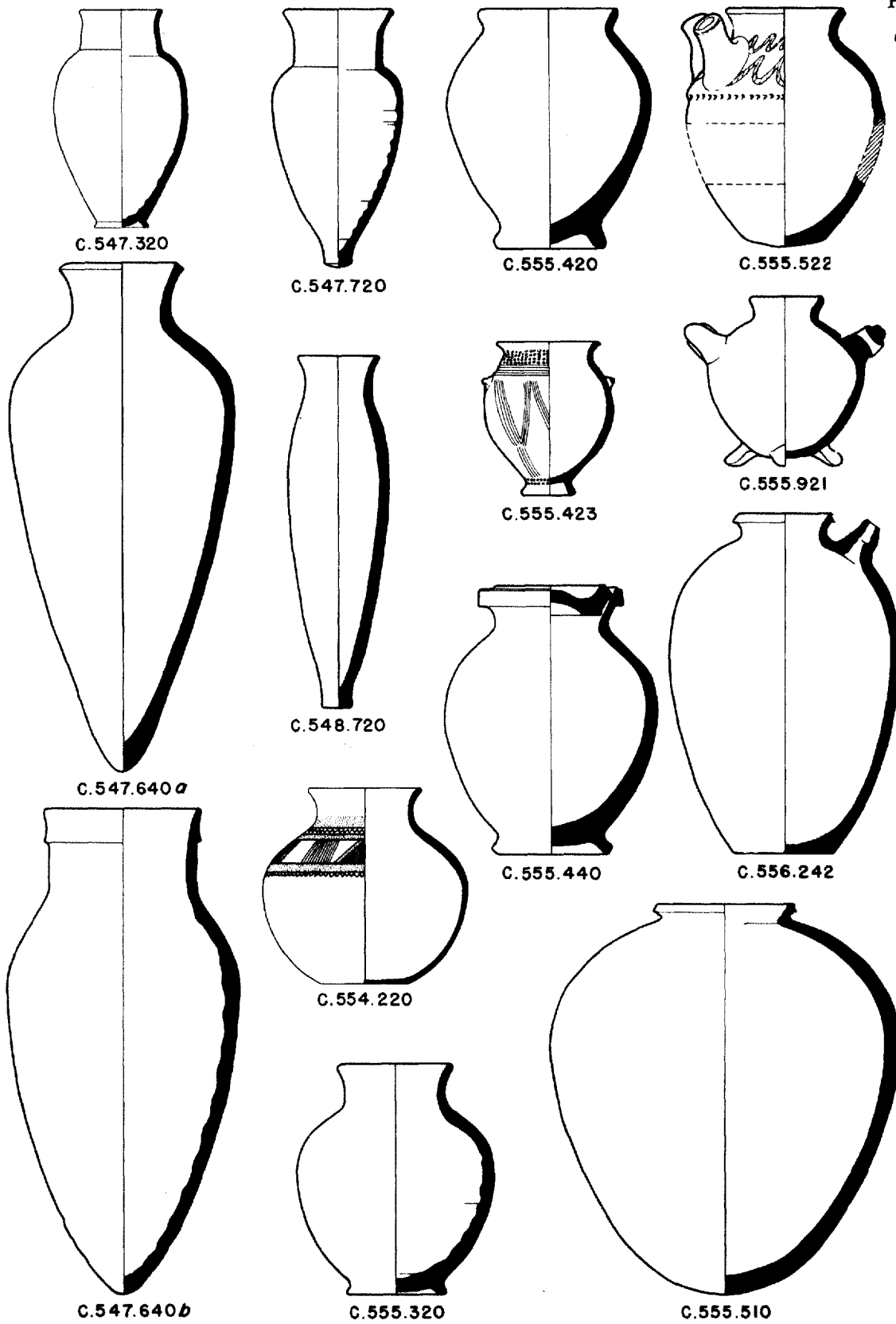

C. 556-C. 587

Form	Photo on Plate	Site	Square, Locus, or Area	Grave	Building or Level	Date of Find-Spot	Remarks	Comparanda	
								Site	Reference
C. 556.320		Ish.	P 30:3		(Kititum IV)	L. Larsa or Old Bab.	Ish.P.27. Cf. C.547.320; see p. 118		
		Kh.	P 44:8 S 42:1	144	Houses 1 Houses 2	ED III ED III	Kh.I 183 2(?) specimens		
C. 556.322		As.	E 15:2 F 17:5 H 19:5		N. Palace N. Palace Houses IVb	Protoimp. Protoimp. E. Agade	As.31:P.5a. See pp. 91, 106, 111 As.31:P.5c As.31:P.5b	Ur al-CUbaid	RC, Type 208 Type LXXXIX
	90c	Kh.	O 43:6	137	Houses 3	ED III			
C. 556.362		Kh.	P 43:23	89	Houses 6	ED II	See p. 81		
C. 556.420		Kh.	R 45	163	Above Houses 2	ED III	Kh.I 18e; C. See p. 96		
C. 556.440		Kh.	P 50:2	141	Houses 3	ED III			
C. 556.540		Kh.	K 42:9	167	Houses 2	ED III	Kh.III 1029. See p. 99	Ur	RC, Types 93 and 103
C. 556.640		Kh.	K 42:7		Houses 3	ED III	Kh.III 647; B. See p. 99	Kish Telloh Ur	"A," Pl. LIII 41 G II, Pls. XXX 2242 and XXXIII 988 RC, Type 48
C. 557.170		Ish.			City wall	L. Larsa or Old Bab.	Ish.P.24. See p. 116		
C. 557.372		As.	J 21:26		Houses IVb	E. Agade	As.32:802. See p. 111	al-CUbaid	Type LXXXIX
C. 557.422		As.	H 18:14		32.70 m.	ED II	As.33:224. See p. 81	Ur al-CUbaid	RC, Type 208 Type LXXXIX
C. 557.470		Kh.	P 45:8		Houses 1	ED III	Kh.III 404. See p. 96	Ur	RC, Type 148 (not incised)
C. 557.620	48e, 65:44	Ag.	Hill B		Top layer	ED I	Ag.36:570; C. See pp. 58, 59, 79		
C. 557.640	112e	As.	E 15:2		N. Palace	Protoimp.	As.31:P.6; C. See p. 107. Classified under C.882 also		
C. 558.320		Ish.	R 29:7		Kititum III	L. Larsa	Ish.P.19. See p. 116	Kish Susa	Gen. I, Pl. 50:135 Mém. I, Fig. 162
C. 565.340		Kh.	K 42:5 K 42:17	168 130	Above Houses 2 Houses 3	ED III ED III	Kh.III 614; B. See p. 96		
C. 565.360		Kh.	P 43:23	89	Houses 6	ED II			
C. 565.540		As.	J 19:55 D 17		Houses Va Near Single-Shrine	Protoimp. ED III or later	As.32:1345. See pp. 107, 111	Kish Telloh	"A," Pl. LIV 56 G II, Pl. XXXIII 988
			K 28:2			Agade?			
C. 566.350		As.	J 20:12 J 19:40*		Houses IVa Houses IVb	L. Agade E. Agade	As.32:1018. See p. 111 Sherd		
C. 576.242	119e	As.	E 16:6		Houses above N. Palace	Larsa?	As.31:P.107a; C. See p. 117		
C. 585.320	132b	Kh.	n 74-75, trench			Old Bab.	Kh.VIII 99; B. See p. 123	Babylon Ur	WVDOG XLVII, Fig. 9 k RC, Type 237 (much thicker; stump base)
C. 586.420		Ag.	Q 13	2			Cf. C.686.420		
C. 587.862	110h	As.	H 20:22		Houses Va	Protoimp.	As.32:1143. See p. 106		

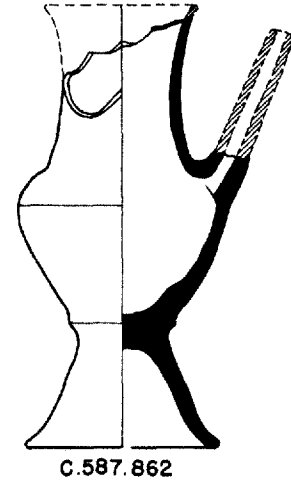
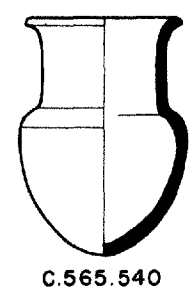
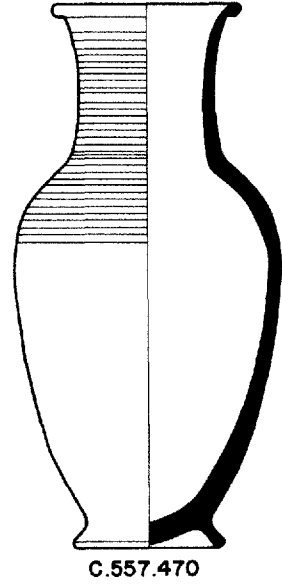
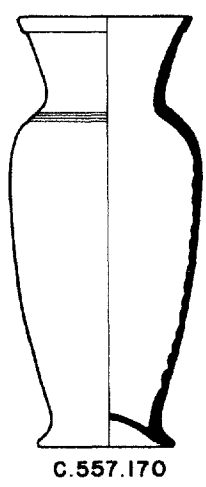
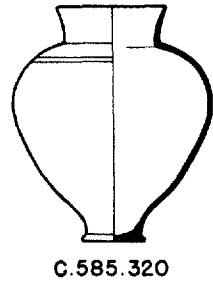
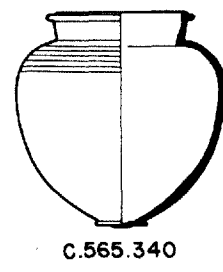
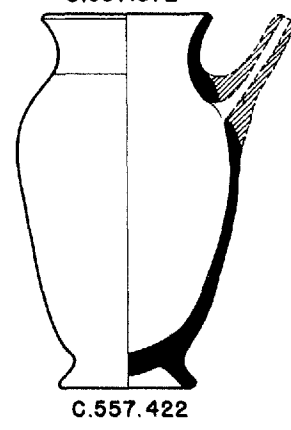
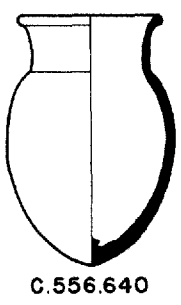
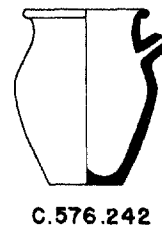
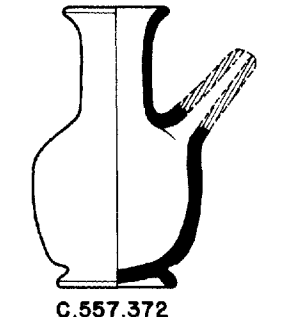
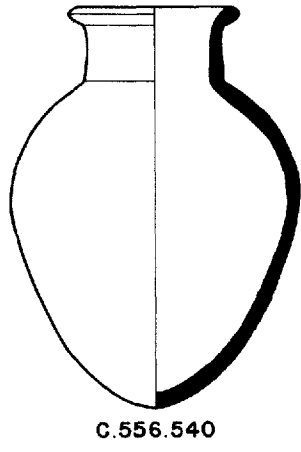
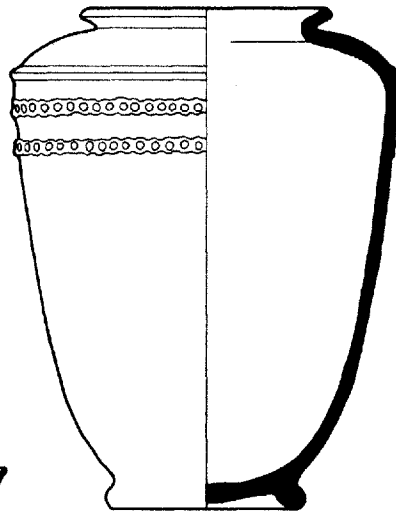
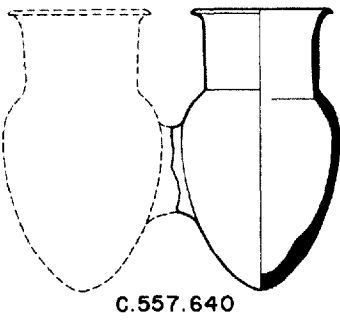
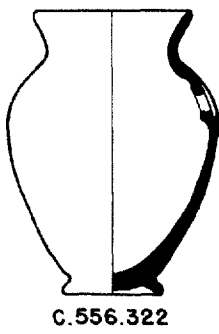
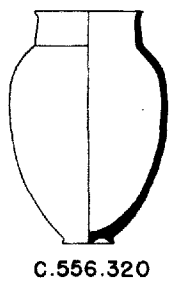

Form	Photo on Plate	Site	Square, Locus, or Area	Grave	Building or Level	Date of Find-Spot	Remarks	Comparanda	
								Site	Reference
C.594.220		As.	D 17:10		Archaic Shrine III	ED I	As.34:159		
C.596.362	67g	Kh.	N 44:14	92	Houses 6	ED II	See p. 81		
C.596.440a		Kh.	E 29:1	162	Houses 1 or above	Protoimp.?	See p. 107		
			E 29:2	161	Houses 1 or above	Protoimp.?	2 specimens		
			E 29:3	159	Houses 1 or above	Protoimp.?	2 specimens		
C.596.440b		As.	E 16:22 D 17:2		N. Palace Single-Shrine II	Protoimp. Protoimp.	As.32:588. See p. 107		
			D 17:19 E 17:9		Earlier N. Palace?	Protoimp.? ED III?			
		Ag.	Q 13	2			3 specimens		
		Kh.	E 29:1	162	Houses 1 or above	Protoimp.?	2 specimens		
C.603.200	32a	Kh.	P 43:58		Houses 12	Protolit.d	Kh.IX 163; B. See Pl. 3 and p. 47		
C.603.253a [†]	28c	Kh.	Q 42:26		Sin III	Protolit.c	Kh. VI 335; C. See Pl. 134 a and pp. 45, 127, 132	Jamdat Nasr	Mackay, Pls. LXIV 8 and LXXIX 5; AJA XXXIX, Pl. XXX 8
C.603.253b		Kh.	Q 42:26		Sin III	Protolit.c	Kh.VII 178; B. See p. 40	Jamdat Nasr	AJA XXXIX, Pl. XXXI
C.603.253	22h	Kh.	P 43:60*		Houses 12	Protolit.d	Kh.IX 233; B. See p. 40	Jamdat Nasr	Mackay, Pl. LXXVII 2
C.603.270		Kh.	Q 42:26		Sin III	Protolit.c	Kh.VII 150; B. See p. 36	Jamdat Nasr Farah Khazinah	Mackay, Pl. LXV 21 Fara, Fig. 29; MJ XXII, Pl. XXIV 3 Mém. VIII, Fig. 269
C.603.340	36b	Kh.	P 43:60		Houses 12	Protolit.d	Kh.IX 101; B. See Pl. 8 and pp. 49, 126	Jamdat Nasr	AJA XXXIX, Pl. XXX 1-2
		As.	H 18:14*		24-23 m.	Protolit.d	As.34:235; C. See pp. 49, 77 and Pl. 64:42		
C.604.353		Kh.	P 43:58		Houses 12	Protolit.d	Kh.IX 234; P. See p. 41		
C.604.370	33	Kh.	L 44:5		Oval I	ED II	Kh.IV 473. See Pl. 5 and pp. 48, 80, 126, 135-36; Protolit. survival; published in OIP LIII as C.606.373	Farah	MJ XXII, Pl. XXII
			P 43:58		Houses 12	Protolit.d	Kh.IX 152; P. See p. 49	Jamdat Nasr	Mackay, Pl. LXVI 39
C.605.240	49g	Kh.	P 43:53	81	Houses 8	ED I	Kh.IX 131. See p. 59	Jamdat Nasr al-Ubaid	Mackay, Pl. LXVI 2 Type P xiii
C.605.340	32c 36c	Kh.	P 43:51 P 43	27	Houses 12 Houses 12	Protolit.d Protolit.d	Kh.IX 151; B. See p. 47 Kh.IX 241; B. See p. 49	Jamdat Nasr Musyan	Mackay, Pl. LXXXVII 3 Mém. VIII, Fig. 277
C.606.320		Kh.	Mound B			Old Bab.	See p. 123		
C.606.373		Kh.	L 44:5				See C.604.370		
C.606.620		As.	Below D 17:18		33.50 m.	ED III?	As.34:59		
C.634.253	22g	Kh.	Q 42:26		Sin III	Protolit.c	Kh.VII 149; C. See p. 40. Classified under C.882 also		
C.634.373		Kh.	Q 42:26		Sin III	Protolit.c	Kh.VII 151; B. See p. 40. Classified under C.883 also	Susa	Mém. XIII, Pl. XXXII 9
			Q 42:26		Sin III	Protolit.c	Kh.VII 253; B. Sepia monochrome design	Makran	Pl. XIII Sh. T. vi 3
C.634.453		Kh.	Q 42:26		Sin III	Protolit.c	Kh.VII 173; B. See pp. 40, 45. Classified under C.882 also		
C.635.360		Ish.	V 32:11		Houses	L. Larsa or Old Bab.	Ish.P.7. See p. 116		
C.646.222		As.	G 19:3 G 19:3		Houses IVa Houses IVa	L. Agade L. Agade	As.31:P.27. See p. 111		
C.646.422		As.	H 20:22		Houses Va	Protoimp.	As.32:P.43a. See p. 106		

[†] In OIP LVIII a specimen of this form was erroneously listed from Kh. Q 42:24, Sin III or IV.

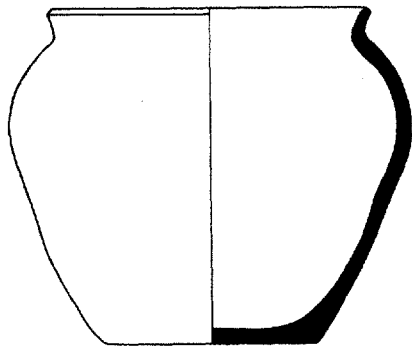

C.594.220

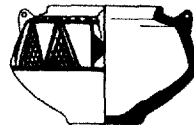

C.603.253 *a*

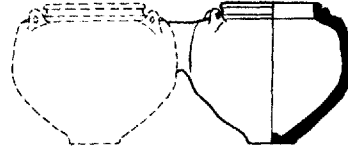

C.634.253 (= C.882)

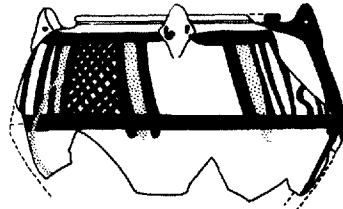

C.603.253 *b*



C.634.373 (= C.883)

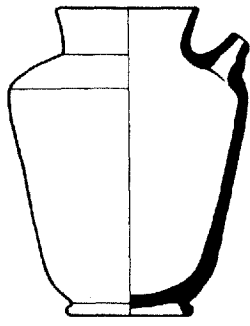

C.596.362

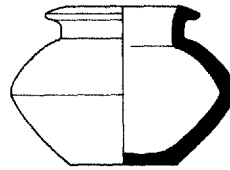

C.603.270

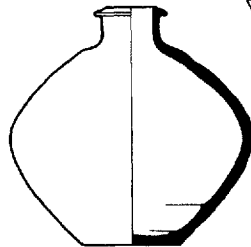
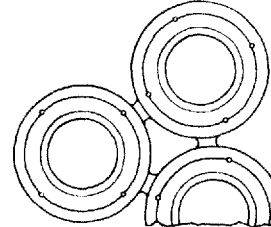

C.605.240

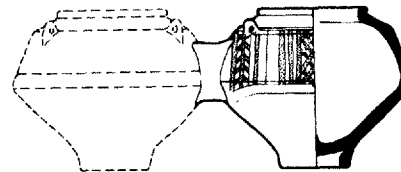

C.634.453 (= C.882)

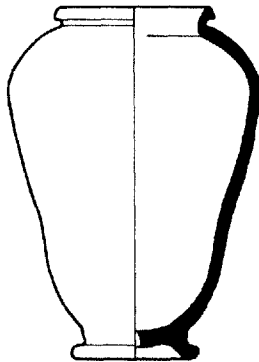

C.596.440 *a*

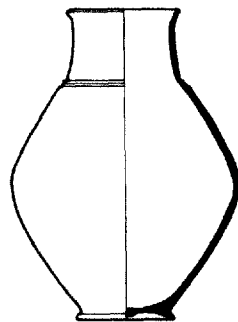

C.606.320

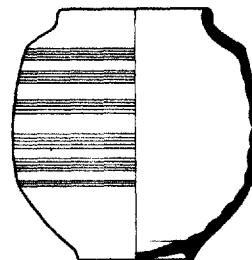

C.635.360

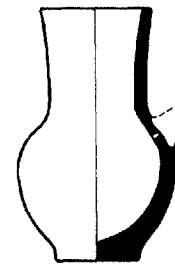

C.646.222

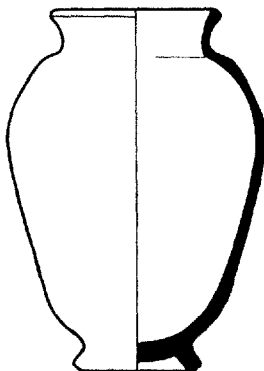

C.596.440 *b*

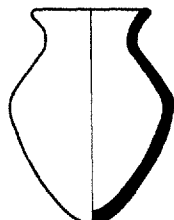

C.606.620

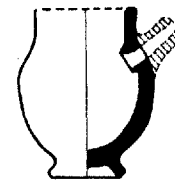

C.646.422

C.653-C.655

Form	Photo on Plate	Site	Square, Locus, or Area	Grave	Building or Level	Date of Find-Spot	Remarks	Comparanda	
								Site	Reference
C.653.520	112d	As.	F 17:10		N. Palace	Protoimp.	As.32:508; B. See p. 107		
C.653.620		Kh.	T 44:1	151	Houses 2	ED III	Kh.VIII 118. See p. 99		
C.654.222	24e	Kh.	Q 42:24		Sin IV	Protolit.d	Kh.VI 329; C. See pp. 38, 43	Telloh	G I, Pl. III 5481
C.654.240	23a	Kh.	P 43:54	2	31.95 m.	Protolit.c	Kh.IX 190; B. See p. 41		
C.654.242	19c	Kh.	O 43:50		32.00 m.	Protolit.c	Kh.VII 115; B. See pp. 37, 125, 133, 134	Nineveh	AAA XX, Pl. LII 12
C.654.503		Kh.	L 43:10		Oval II	ED III	See p. 99	Mari Palestine	Syria XIX, Pl. II 4 Duncan, 30 Y 2-5; OIP XXXIII, Pls. 10:10 and 15:3 Fig. 46
C.654.510		Kh.	J 42:7 N 47:2		Houses 4 Oval I	ED II ED II	Kh.III 1321; B	Ghassul Kish	Kish IV, Pl. I BB
C.654.520		As. Kh.	L 19:1 J 19:13 E 29:2	161	Houses Va Houses Vc Houses 1 or above	Protoimp. ED III Protoimp.?	As.33:131. See p. 108	Kish Ur	"A," Pl. XVI 2 RC, Type 83c
C.654.540		Kh.	P 43:54 O 43:14 P 43:60	2 109 25	31.95 m. Houses 4 Houses 12	Protolit.c ED II Protolit.d	See p. 41 See p. 41		
C.655.222	19b	Kh.	O 43:50		32.00 m.	Protolit.c	Kh.VII 114; C. See pp. 37, 125, 133, 134		
C.655.240		As.	O 30:3		Above Bilalama	E. Larsa	As.30:P.45; B. See p. 118	Kish	Kish IV, Pl. II AL
C.655.340a		Kh.	O 42:2		Houses 3 or 2	ED III	Kh.III 229. See p. 96		
C.655.340b	73e	Kh.	N 44:5	119	Houses 4	ED II	See p. 82		
C.655.370a		Kh.	K 42:9	167	Houses 2	ED III	Kh.III 1330. See p. 96		
C.655.370b		Kh.	Mound A			ED III?	See p. 96		
C.655.370c		Kh.	L 42:5		Houses 3	ED III	Kh.III 1102 (B) and 1151. See p. 96		
C.655.460	99e	Kh.	S 45:1	152	Houses 2	ED III	Kh.VIII 190. See p. 96		
C.655.510		Kh.	O 43:55	22	Houses 12	Protolit.d	See pp. 41-42		
C.655.540		Kh.	P 43:55	17	Houses 12	Protolit.d	See p. 41		

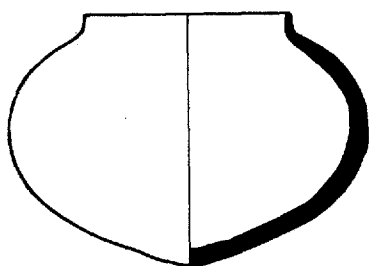

C.653.620

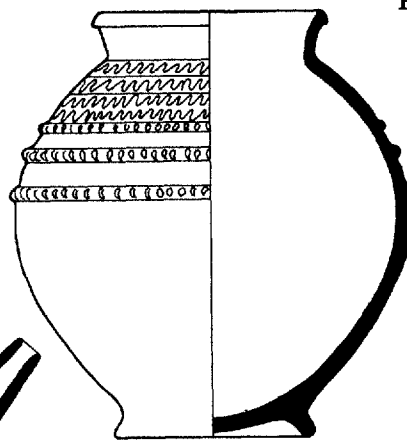

C.655.370 a

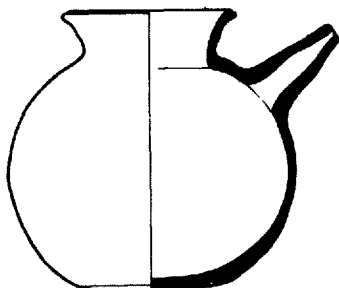

C.654.242

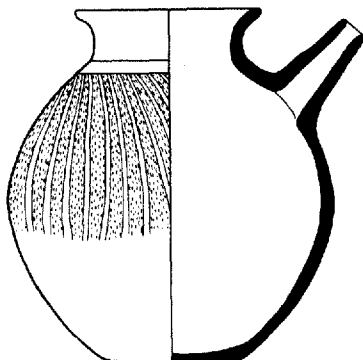

C.655.222

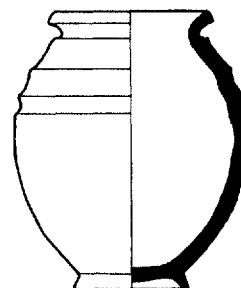

C.655.370 b

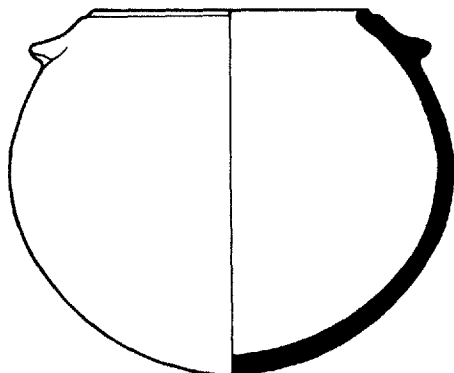

C.654.503

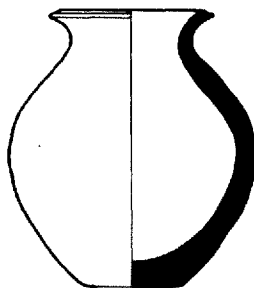

C.655.240

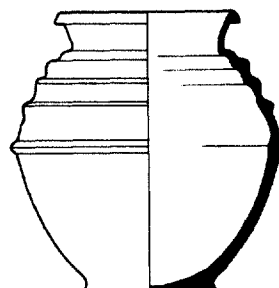

C.655.370 c

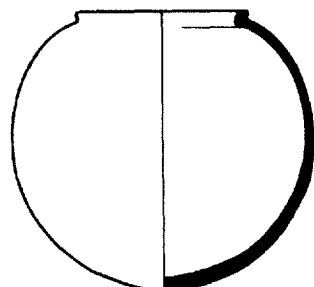

C.654.510

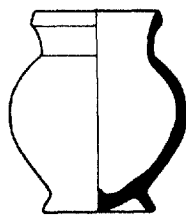

C.655.340 a

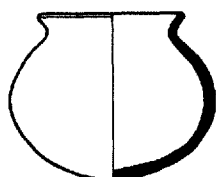

C.654.520

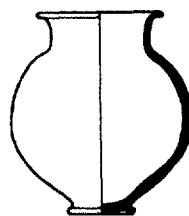

C.655.340 b

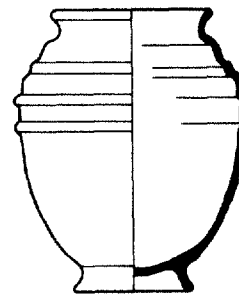

C.655.460

C.656-C.686

Form	Photo on Plate	Site	Square, Locus, or Area	Grave	Building or Level	Date of Find-Spot	Remarks	Comparanda	
								Site	Reference
C.656.340		As.	O 30:3		Above Bilalama	E. Larsa	As.30:P.46; C. See p. 118		
C.656.540	112b	As. Kh.	J 19:57 E 29:1	162	Houses Vb or a Houses 1 or above	ED III or Protoimp. Protoimp.?	As.32:1132. See pp. 99, 107		
C.657.242		As.	H 18:7		Houses IVa or III	L. Agade or Gutium-Ur III	As.31:P.112; B. See p. 113		
C.657.522	114d	As.	J 18:13		Houses IVa	L. Agade	As.32:649. See p. 111		
C.663.540		As.	D 17:32		Archaic Shrine III	ED I	As.34:107		
C.664.640	111e	As.	J 19:29 E 17 J 20:12		Houses IVa Square Temple Houses IVa	L. Agade ED II L. Agade	As.32:788. See p. 110		
C.665.222	19f	Kh.	P 43:54	10	32.85 m.	Protolit.c	See pp. 37, 135 (n. 52)	Warka	UVB IV, Pl. 19 C 1'
C.665.323		Kh.	Mound A			ED III?	See p. 102		
C.665.341		As.	J 19:27		Houses Vb	ED III	As.33:154. See p. 102		
C.665.541		As.	H 19:3		Houses Va	Protoimp.	As.32:1271; B. See pp. 102, 105		
C.665.543a		As.	Passage N. of H 20:45		Houses Vb	ED III	As.33:198. See pp. 102, 144 (n. 113)		
C.665.543b		As.	J 20:15		Houses Va	Protoimp.	As.33:145. See pp. 102, 105, 144 (n. 113)	Siyalk	Pl. XXVII 6 (traces of 2 spouts; no lugs)
C.665.543c		As.	J 20:2 J 19:13		Houses Va Houses Vc	Protoimp. ED III	As.33:153. See pp. 102, 105, 144 (n. 113)	Nuzi	Pl. 42 P (2 spouts; no lugs)
C.665.543d	105g	As.	J 19:64 H 19:3 J 18:10		Houses Va Houses Va Houses IVb	Protoimp. Protoimp. E. Agade	As.32:1272; C. See pp. 102, 105, 110, 144 (n. 113), 147 As.32:1267	Telloh	S, Pl. 42:21
C.665.621		As.	K 20:31		Houses Va	Protoimp.	As.33:10. See p. 107		
C.665.740		Kh.	g 67:2			Old Bab.	Kh.VIII 246; B. See p. 123		
C.666.520	65:52 65:53	Ag.	Hill B Hill B		Top layer Top layer	ED I ED I	Ag.36:578; B. See pp. 59, 79, 82 Ag.36:555; C. See pp. 79, 82		
C.686.420	100h	Kh.	R 45	164	Above Houses 2	ED III	Kh.1 31k; C. See p. 97	Kish	"A," Pls. XIV 9-14 and LII 1
C.686.443	100i	Kh.	P 45:14		Houses 2	ED III	Kh.III 870; C. See p. 97		

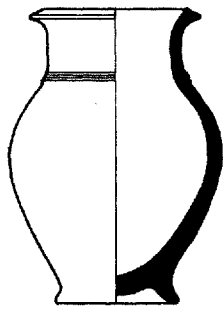

C.656.340

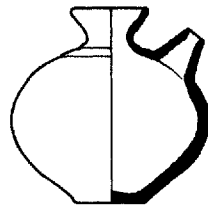

C.665.222

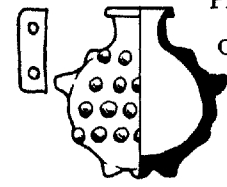

C.665.543c

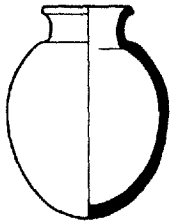

C.656.540

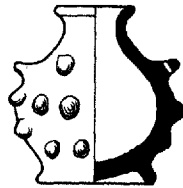

C.665.323



C.665.543d

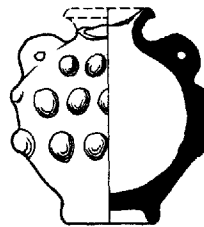

C.665.341

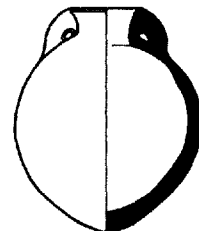

C.665.621

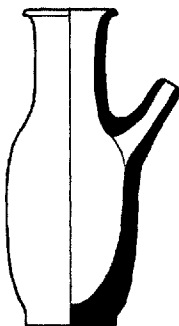

C.657.242

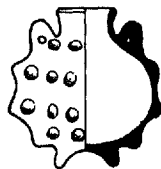

C.665.541

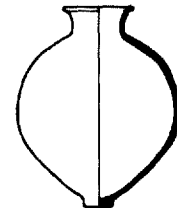

C.665.740

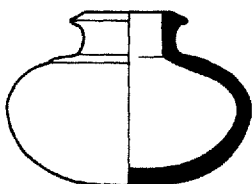

C.663.540

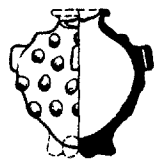

C.665.543a

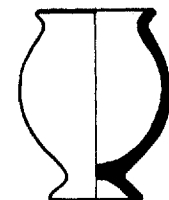

C.686.420



C.664.640

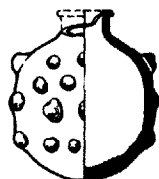

C.665.543b



C.686.443

Form	Photo on Plate	Site	Square, Locus, or Area	Grave	Building or Level	Date of Find-Spot	Remarks	Comparanda	
								Site	Reference
C. 702.253		Kh.	Q 42:26		Sin III	Protolit.c	Kh.VII 146; B	Jamdat Nasr	Mackay, Pl. LXIV 10
C. 743.510	23d	Kh.	P 42:50		(Sin II)	Protolit.c	Kh.VII 33; B. See pp. 41, 134	Nineveh	AAA XIX, Pl. LXI 3; XX, Pl. LIII 3
C. 743.570	111f	As.	W. of E 16:19 D 17:19 J 20:22		N. Palace	Protoimp. Protoimp.? Protoimp.	As.32:P.53. See p. 107	Farah	MJ XXII, Pl. XXV 1
C. 744.220	32b	Kh.	P 43:51	15	Houses 12	Protolit.d	Kh.IX 156; P. See p. 47		
C. 744.340	36a	Kh.	P 42:50	23	Houses 12	Protolit.d	Kh.VI 336; C. See p. 50		
C. 745.270		As.	D 17:33		Earliest Shrine	Protolit.d	As.34:251. See p. 50		
C. 753.510		Kh.	P 43:59	24	Houses 12	Protolit.d	See p. 41		
C. 754.440	54e, 65:30	Ag.	Hill V, room VII		Top layer	ED I	Ag.36:473; C. See pp. 50, 64, 79		
C. 754.521		Kh.	L 42:4 L 42:5* L 42:6* M 42:4* N 43:11*		Houses 3 Houses 3 Houses 3 Houses 3 Houses 2	ED III ED III ED III ED III ED III	Kh.III 791. See p. 99	Kish	Kish IV, Pl. II AO
C. 756.340		Ish.	R 30		Kititum IV	L. Larsa or Old Bab.	Ish.P.35. See p. 149	Telloh Ur	G II, Pl. XXIX 1022 RC, Type 76
C. 756.520		Kh.	N 51		Houses 2 or 1	ED III	Kh.IX 221; B. Gray ribbed ware, burnished		
C. 757.340		Ish.	R 30:1		Kititum III	L. Larsa	Ish.P.49. See pp. 116, 149	Abu Hatab	Fara, Fig. 60, F 1924
C. 757.540	113h	As.	J 21:1 N. of H 19:4 H 19:25		Houses IVa Houses Va	L. Agade Protoimp.	As.32:578; C. See p. 111	Babylon	WVDOG XLVII, Fig. 2h (Hammurabi level)
C. 758.510		As.	Q 32:6 O 33:15 Q 33:13		Houses IVa	L. Agade	As.32:1260; B		
C. 777.340	114f	Ish.	R 29:1		Ibiquadad II	L. Larsa	As.31:P.4; B. See p. 117		
C. 777.340		As.	K 19:3		Kititum II	L. Larsa	Ish.P.47		
C. 777.340		As.	K 19:3		Houses IVa	L. Agade	As.32:527; B. See pp. 111, 147	Telloh	G II, Pls. XXVIII 2793 and 3755, XXIX 614
C. 787.340		As.	Q 33:13		Ibiquadad II	L. Larsa	As.31:P.7; C. See p. 117	Bismayah Susa	Bismyah, p. 216 Mém. I, Fig. 149
C. 802.200		As.	E 17:9		Outside N. Palace	Protoimp.?	As.32:1379. See pp. 101, 105, 135		
C. 802.200		Kh.	Q 42:11		Sin VI	ED I	See pp. 39, 60; not ribbed; published in OIP LVIII as C.202.200	Jamdat Nasr	Mackay, Pl. LXVI 22=Pl. LXXVI 3352
C. 802.200			Q 42:15		Sin V	Protolit.d	See pp. 39, 60; not ribbed; published in OIP LVIII as C.202.200		
C. 803.200		Kh.	O 44:10 O 44:10		Houses I Houses I	ED III ED III	Kh.III 363. See p. 101 Kh.III 364, 1171 (B), 1197		
C. 805.200		As.	J 19:13		Houses Vc	ED III	As.33:289. See p. 101		
C. 805.210		As.	J 19:55 J 19:64 J 19:64 J 20:21*		Houses Va Houses Va Houses Va Houses Va	Protoimp. Protoimp. Protoimp. Protoimp.	As.32:1262. See pp. 101, 105 As.32:1261; B 2(?) specimens		
C. 806.610		As.	H 18:14		24-23 m.	Protolit.d	As.34:234. See pp. 43, 77	Jamdat Nasr	Mackay, Pl. LXVI 9-10 (no perforations)

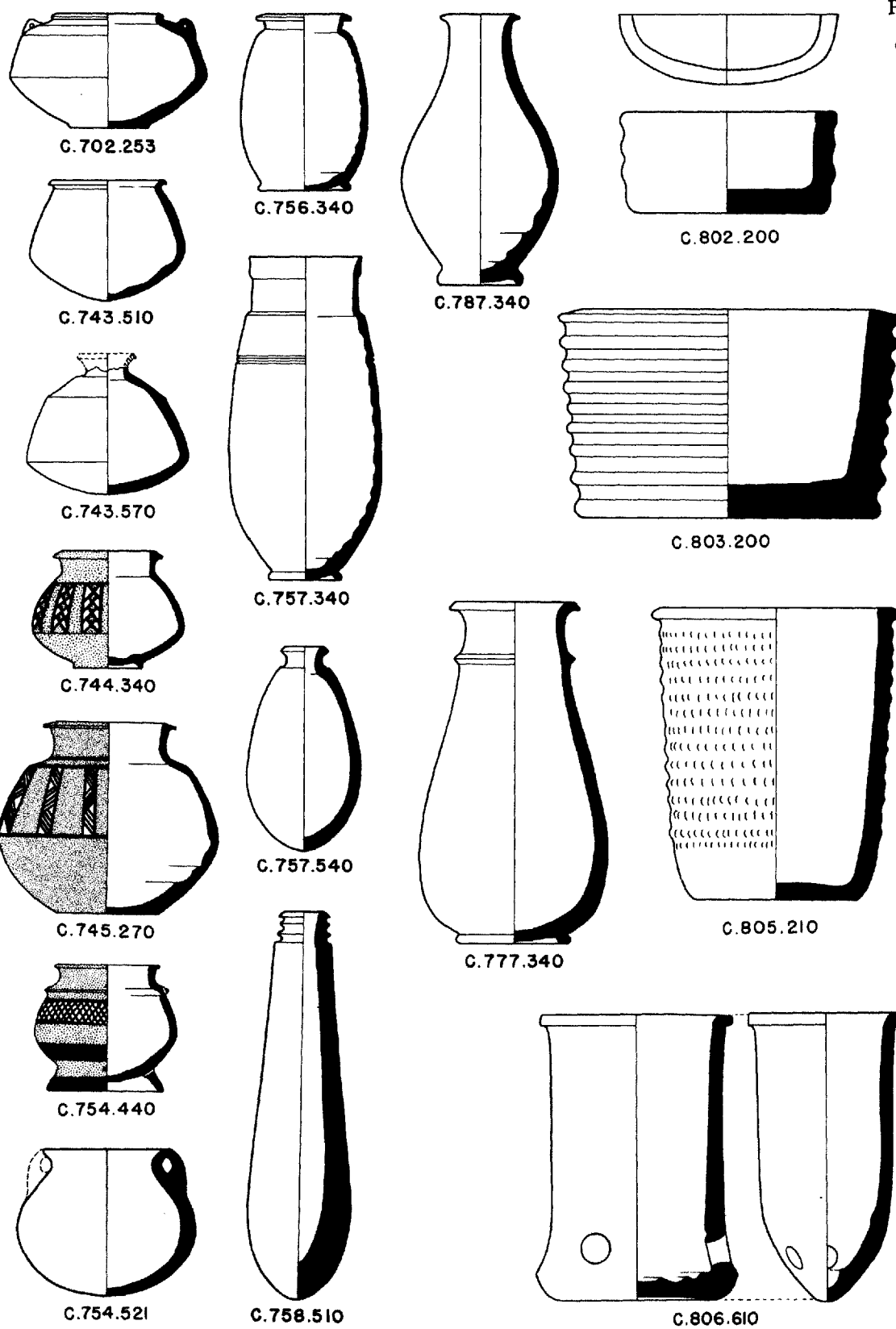

Form	Photo on Plate	Site	Square, Locus, or Area	Grave	Building or Level	Date of Find-Spot	Remarks	Comparanda	
								Site	Reference
C.861	107d	Kh.	O 46:1 O 46:1		Oval I Oval I	ED II ED II	Kh.II 97; B. See pp. 82, 103 Kh.II 285		
C.882	112e	As.	E 15:2		N. Palace	Protoimp.	As.31:P.6; C. See p. 107. Clas- sified under C.557.640 also, q.v. for drawing		
	22g	Kh.	Q 42:26		Sin III	Protolit.c	Kh.VII 149; C. See p. 40. Clas- sified under C.634.253 also, q.v. for drawing		
			Q 42:26		Sin III	Protolit.c	Kh.VII 173; B. See pp. 40, 45. Classified under C.634.453 also, q.v. for drawing		
C.883		Kh.	Q 42:26		Sin III	Protolit.c	Kh.VII 151; B. See p. 40. Clas- sified under C.634.373 also, q.v. for drawing	Susa	Mém. XIII, Pl. XXXII 9
C.95	94a	As.	W. of D 15:3		32.60 m.	ED II or III	As.32:780; C. See pp. 86, 93		
	27	Kh.	O 43:21		Small Temple VI	ED II	Kh.V 173; B. See Pl. 7 and pp. 44, 80, 126. Protolit. sur- vival?	Palestine	Vincent, Fig. 202 (Gezer)
								Susa	Mém. XIII, Pl. XXX 9
	25a		Q 42:26		Sin III	Protolit.c	Kh.VI 333; C. See p. 43		
C.96	94f	As.	G 19:14		Houses IV	Agade	As.31:P.38; C. See pp. 86, 94, 112-13, 122	Kish Babylon	"A," Pl. XLVI 3 WVDOG XLVII, Fig. 39 (much later)
	94h		J 19:27*		Houses Vc or b	ED III	As.33:140. See p. 94		
	94c		J 20:21 O 30:17		Houses Va Bilalama	Protoimp. E. Larsa	As.33:18. See pp. 94, 109 As.31:376a; C	Ur	RC, Pl. 188a; AJ X, Pl. XLI a
	94d	Kh.	N. Palace K 42:4		Surf. Houses 3	Larsa? ED III	As.31:376b; C. See p. 122 Kh.III 1337. Neck of wheeled animal vase with loop	Nuzi Khorsa- bad	Pl. 103 A OIP XL, Pl. 63:245
	94b		L 43:10 M 43:1		Oval II Oval II or III	ED III ED III or Protoimp.	Kh.II P.4; C. See pp. 93-94 Kh.III 1063. Ram's-head spout	Susa	Encyclopédie I 9 (Jan., 1836) p. 282
	94e		O 43:13 P 45:14		Houses 6 or 5 Houses 2	ED II ED III	See p. 86 Kh.III 992. Frag. of wheeled animal vase with loop		
			Q 42:19		Sin V	Protolit.d	See Pl. 133c and pp. 44, 50	Jamdat Nasr	Mackay, Pl. LXXXVI 2
	25b, 26		Q 42:24		Sin IV	Protolit.d	Kh.VI 411; B. See p. 43	Arpa- chyyah Telloh	Pl. V a (much earlier) G I, Pl. 14:4
			Q 44:10 R 45 Mound A M 14:4		Houses 1 Houses 2 or 1 Surf. 32.30 m.	ED III ED III ED III ED II	Kh.III 348. Animal-head spout Kh.I 32. Ram's-head spout Kh.V 28. Ram's-head spout Ag.35:499. Bull's-head spout; see p. 86		
	94g		Unknown		Surf.	Larsa?	Ag.35:105. See p. 122		
C.98	106f	As.	H 20:3		Surf.	Larsa	As.32:545. See p. 103		
C.99	82-83	Kh.	R 42:2		Sin VIII	ED II	Kh.IV 476; B. See pp. 85-86, 94		
D.022.410		As.	H 19:5		Houses IVb	E. Agade	As.32:701. See p. 112		
D.032.300		Kh.	N 44:15	63	Houses 10	ED I			
D.044.510		As.	O 33:3		Below Ibiquadad II	L. Larsa	As.31:P.88a-b; C. See pp. 115, 118-19	Telloh Nuzi	G II, Pl. XXXIII 803 Pl. 81 F (hole in base)
								Susa	Mém. XXV, Fig. 76:5
D.201.201a	118b	As.	H 18:3		Houses III	Gutium-Ur III	As.31:P.127. See pp. 100-101, 114		
			J 19:5*		Houses III	Gutium-Ur III			
D.201.201b		As.	E 16:3		Houses above N. Palace	Larsa?	As.31:P.126a. See pp. 100-101, 108, 112, 114, 118		
	117a		E 18:3		Houses above N. Palace	Larsa?			
			D 16		Outside N. Palace	Protoimp.?			
			E 17:6 H 18:4		N. Palace Houses IVa?	Protoimp. L. Agade?	As.31:P.128b; C		
	116a		J 19:5		Houses II	Gutium-Ur III	As.32:P.65		
	117b		J 19:12 N. of J 19:67		Houses II Houses Vc or b	Gutium-Ur III ED III			
D.301.112		As.	N 34:11		Below Ibiquadad II	L. Larsa	As.31:P.137; C. See pp. 101, 118		
D.307.010		As.	F 13?		Older town wall	ED III	As.34:121; B		
D.333.250		As.	F 16:2 J 19:13		N. Palace Houses IVa	Protoimp. L. Agade	As.32:857. See pp. 108, 112		

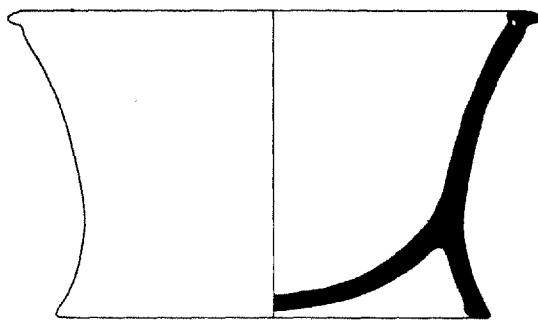

D.022.410

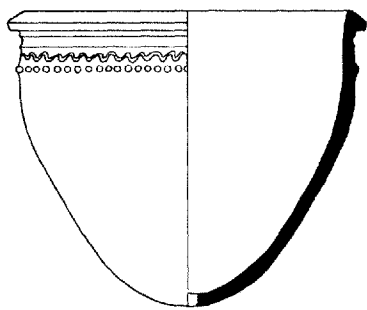
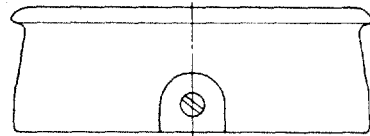

D.044.510

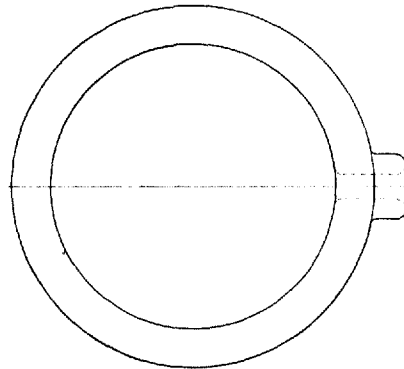

D.301.112

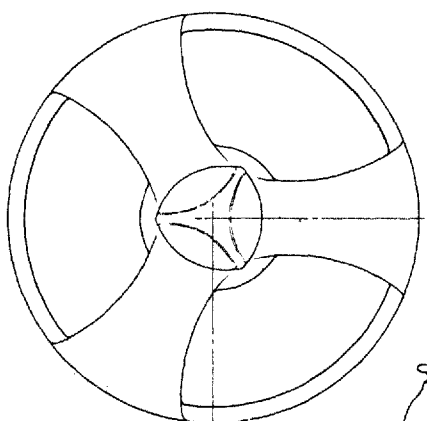
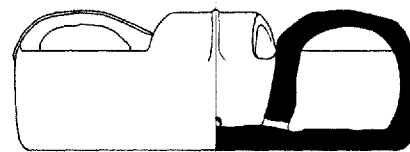
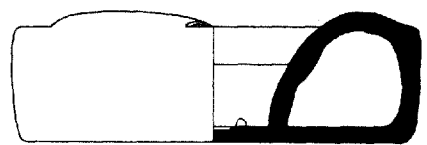

D.201.201 a

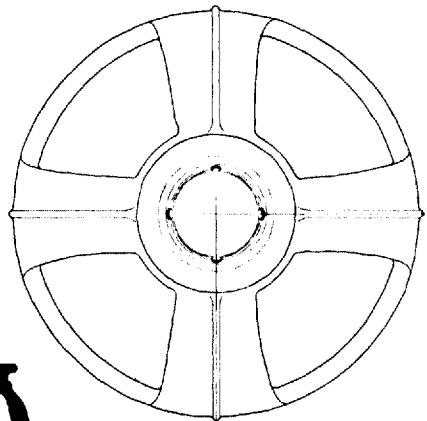

D.201.201 b

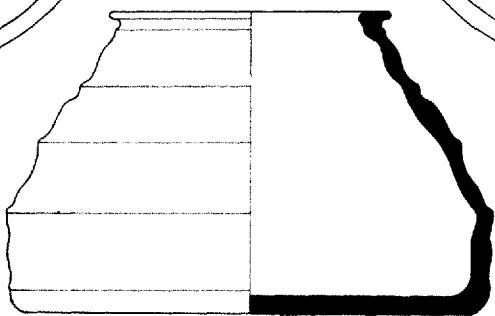

D.333.250

Form	Photo on Plate	Site	Square, Locus, or Area	Grave	Building or Level	Date of Find-Spot	Remarks	Comparanda	
								Site	Reference
D.465.360		As.	E 16:22 J 19:13 S 42:1	144	N. Palace Houses Vb? Houses 2	Protoimp. ED III? ED III	As.32:810. See pp. 97, 107		
D.465.460	115a	As.	F 17		34.50 m.	Protoimp.?	As.32:1188. See p. 108		
D.465.550		As.	E 16:18 H 18:24 H 20:20		N. Palace Houses IVa Dug in from Houses IVa	Protoimp. L. Agade L. Agade	As.32:735. See pp. 108, 112 6 ridges below shoulder	Ur	RC, Type 200
D.468.360	115b	As.	J 20:10 K 19:7 E 15:1 S. of H 20:20* K 20:1		Houses IVa Houses IVa N. Palace Houses Va Houses IVa	L. Agade L. Agade Protoimp. Protoimp. L. Agade	As.32:439. See pp. 107, 112, 146	Ur Nuzi	RC, Type 197 Pl. 52 I
D.494.470		Kh.	P 44:13		Houses 2 or 1	ED III	See p. 97		
D.495.520		As.	P 33:2		Ibiqadad II	L. Larsa	As.31:P.133; C. See p. 118	Nuzi	Pl. 67 A
D.504.353a	41a	As.	D 17:15 D 17* D 17:10* D 17:14*		Archaic Shrine III Archaic Shrine II Archaic Shrine II Archaic Shrine II	ED I ED I ED I ED I	As.34:156; B. See pp. 53-54, 55, 126, 137 As.34:202 As.34:200 As.34:199	Kish	Kish IV, Pl. I 4
	42a		E 17:30*		Archaic Shrine II	ED I	As.34:151		
D.504.353b	41c, 42d	As.	D 17:14		Archaic Shrine III	ED I	As.34:150; C. See pp. 53-54, 126, 137		
D.514.362	91e	Kh.	L 43:3		Oval II	ED III	Kh.I 642. See pp. 91, 97		

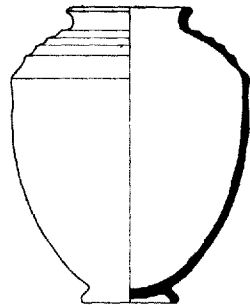

D.465.360

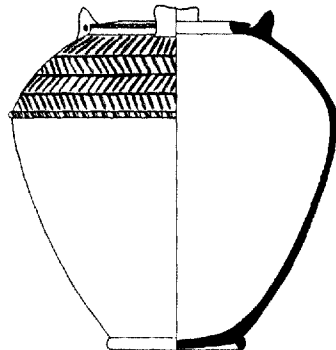

D.504.353a

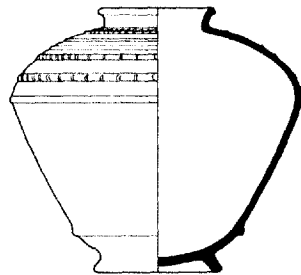

D.494.470

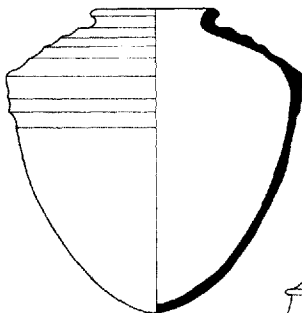

D.465.550

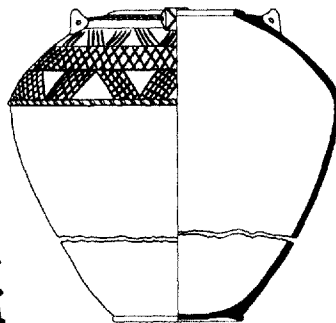

D.504.353b

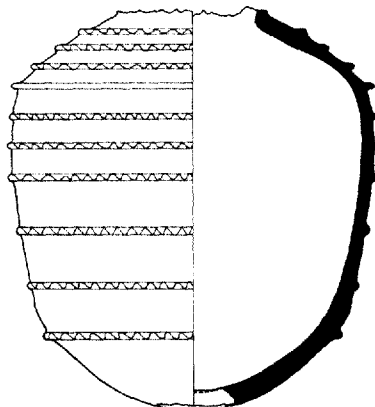

D.495.520

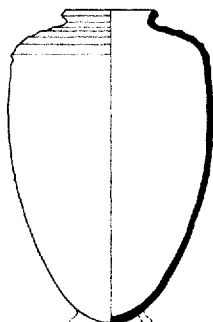

D.466.360

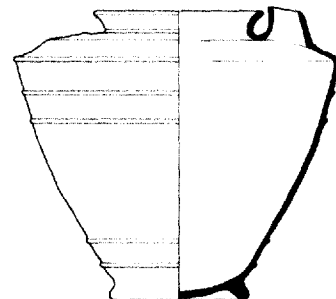

D.514.362

D.514-D.524

Form	Photo on Plate	Site	Square, Locus, or Area	Grave	Building or Level	Date of Find-Spot	Remarks	Comparanda	
								Site	Reference
D.514.370a	52c	As.	D 17:15		Archaic Shrine III	ED I	As.34:147; B. See pp. 61, 63, 135-36		
D.514.370b	66a	As.	D 17:31		Archaic Shrine III	ED I	As.34:148; C. See pp. 72, 135-136; published in OIP LVIII as D.515.370		
		Kh.	P 43:45		Houses 9 or 8	ED I	Kh.LX 104; B. See Pl. 16 and pp. 61, 72, 135-36 See p. 72		
D.515.362	66b		Mound A*			ED I?			
		87b	Kh.	N 43:12	116	Houses 4	ED II	Reserved slip; see pp. 80, 141	
				N 43:15	113	Houses 4	ED II		
				P 43:23	89	Houses 6	ED II	2 specimens	
D.515.370	52b	Ag.	Hill B, room VII		Top layer	ED I	Ag.36:470; C. See Pl. 135b and pp. 61, 135-36		
		65:26	As.	D 17:31		Top layer	ED I	Ag.36:572; B. See p. 79 See D.514.370b	
		66d 34	Kh.	N 44:14	92	Houses 6 Houses 12 or 11	ED II Protolit.d	See pp. 80, 141 Kh.VIII 283; P. See Pl. 133d and p. 48	Farah
			P 43:42	33	Houses 11	ED I			
D.515.373	55:19	Ag.	Hill B		Top layer	ED I	Ag.36:542; C. See p. 78		
D.516.362		Kh.	N 43:12	111	Houses 4	ED II			
			N 44:6	110	Houses 4	ED II			
D.516.363	42f, 65:35	Ag.	M 14:15		30.50 m.	ED I	Ag.36:567; B. See pp. 54, 79, 137		
D.516.371	80a	As.	D 17:22		Archaic Shrine IV	ED I	As.34:68. See pp. 83, 84-85, 88		
D.524.370	66e	Kh.	N 44:11	101	Houses 5	ED II	See pp. 80, 141		
	35a		P 43:59		Houses 12	Protolit.d	Kh.LX 149; B. See Pl. 6 and pp. 48-49, 126, 135-36		

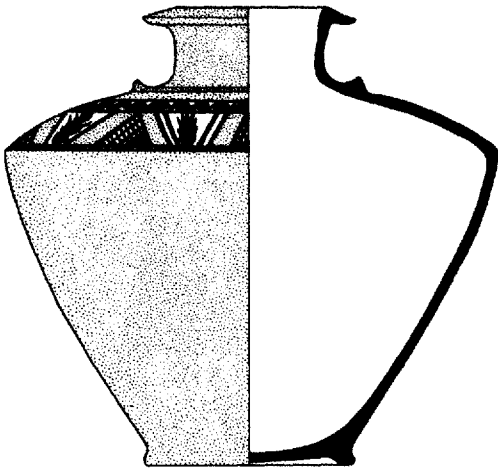

D.514.370 a

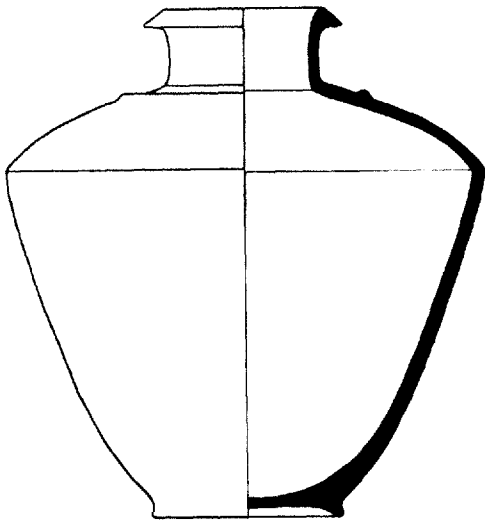

D.515.370

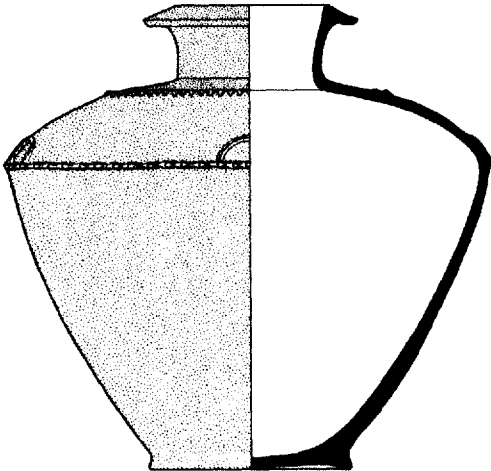

D.514.370 b

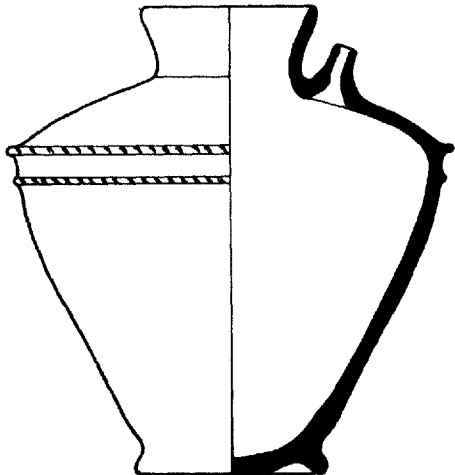
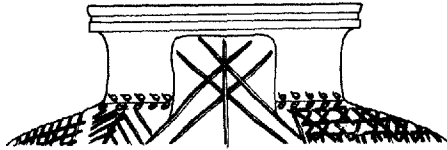

D.515.362

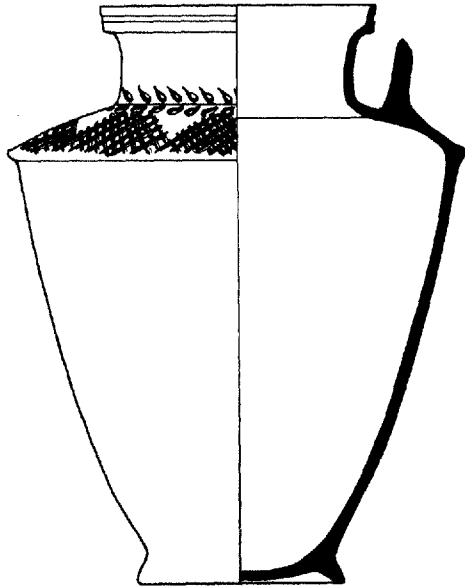

D.516.371

D.525-D.535

Form	Photo on Plate	Site	Square, Locus, or Area	Grave	Building or Level	Date of Find-Spot	Remarks	Comparanda	
								Site	Reference
D.525.362	87a	Kh.	N 43:15 N 43:12 N 43:12 N 43:12 N 43:20 N 44:8 N 44:7 N 44:14 O 43:14 P 43:20* P 43:23 P 43:23 P 43:27 P 43:28	111 111 118 99 110 131 92 109 93 89 91 87 108	Houses 4 Houses 4 Houses 4 Houses 4 Houses 5 Houses 4 Houses 3 Houses 6 Houses 4 Houses 6 Houses 6 Houses 6 Houses 6 Houses 4	ED II ED II ED II ED II ED II ED III ED II ED II ED II ED II ED II ED II ED II ED II	Kh.V 82. See pp. 91, 97 Kh.V 112; C. See pp. 80, 141 2 specimens 2(?) specimens 3 specimens 3 specimens 3 specimens 2 specimens		
D.525.370	68c	Kh.	N 43:12 O 43:18*	111 72	Houses 4 Houses 9	ED II ED I	Kh.V 114; B. See p. 80 See pp. 72, 135-36, 141	Susa Musyan	Mém. XIII, Pl. XXX 7 (painted) Mém. VIII, Fig. 104
D.525.371	51a, 6537	Ag.	M 14:15		30.50 m.	ED I	See pp. 60, 79		
D.525.670		As.	O 30:2 Q 33:5*		Top layer Ibiqadad II	Larsa L. Larsa	As.31:P.68. See p. 118		
D.526.370a		As.	D 14:4 J 18:6 J 19:2		Earlier N. Palace Houses IVa Houses IVa	ED III L. Agade L. Agade	As.31:P.144. See p. 97	Telloh	G II, Pl. XXVIII 3483
D.526.370b	44c	As.	E 17:30		Archaic Shrine III	ED I	As.34:148; C. See pp. 55, 137		
D.526.371		Kh.	P 45 N 44:7	131	Houses 3	ED III? ED III	Kh.III 1371; B. See pp. 83-85, 87-90, 97 See Pl. 139a		
	80b, 85b 76a	As.	E 18:46*		Archaic Shrine IV	ED I	As.33:723; C		
D.526.373	47g	Ag.	N 13:1		30.30 m.	ED I	Ag.35:1136. See p. 57; pub- lished in OIP LVIII as C.526.373a		
	47i, 6525		Hill B*		Top layer	ED I	Ag.36:535; B. See pp. 57, 79		
D.535.322	37i	Kh.	P 43:33	83	Houses 7?	ED I	See p. 52		
D.535.342	31d	Kh.	O 43:43	52	Houses 11	ED I	Kh.VI 371; B. Protolit. sur- vival? See pp. 46-47, 127		

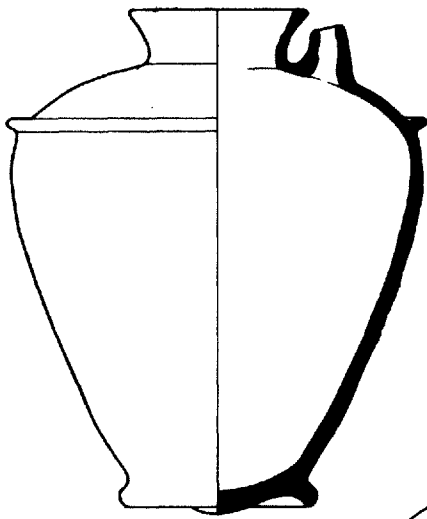

D.525.362

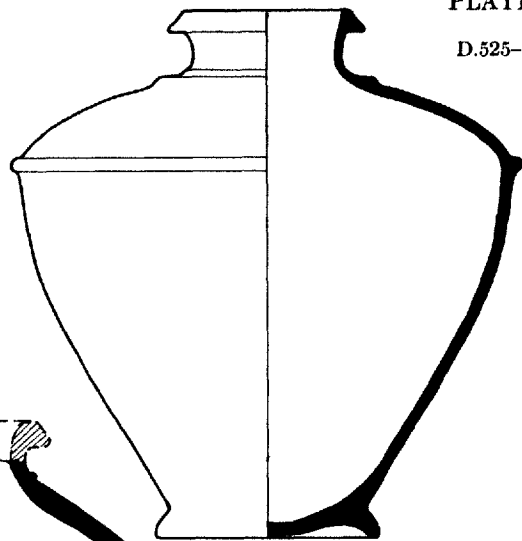

D.525.370

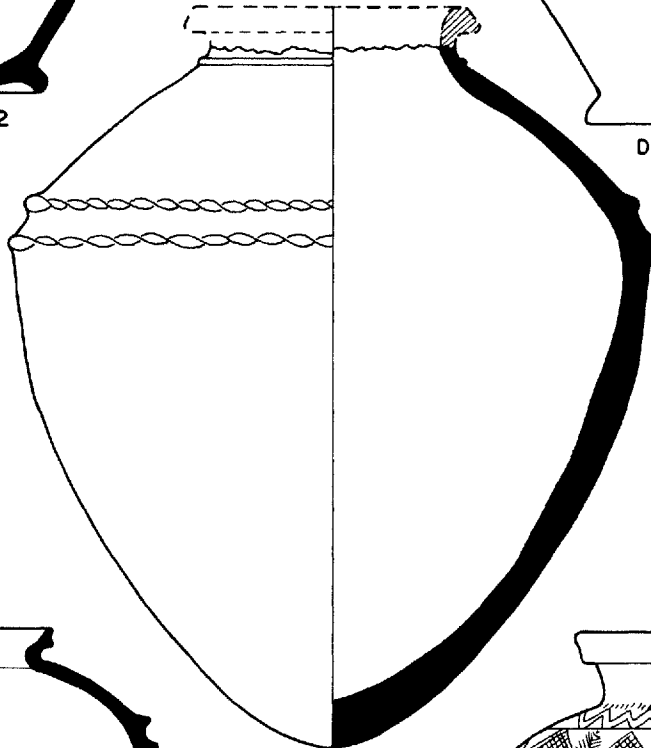

D.525.670

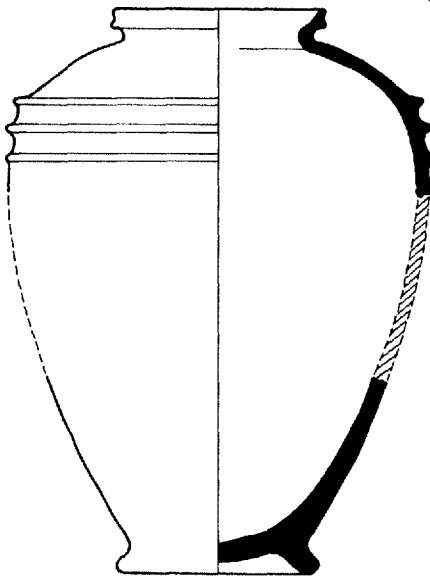

D.526.370 a

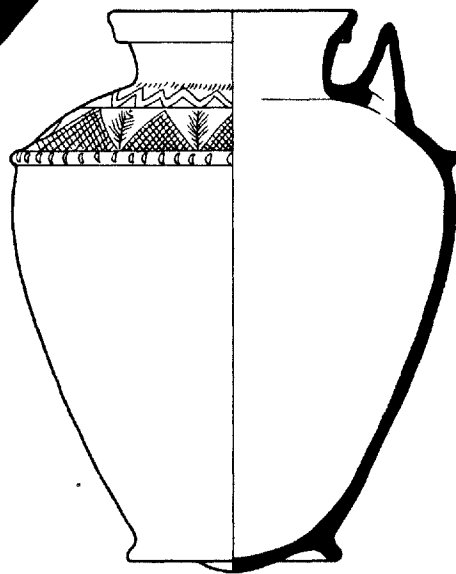

D.526.371

Form	Photo on Plate	Site	Square, Locus, or Area	Grave	Building or Level	Date of Find-Spot	Remarks	Comparanda	
								Site	Reference
D.535.542		As.	E 16:46		Archaic Shrine IV	ED I	As.33:726-27. See p. 53		
		Kh.	K 46:4*		Oval I or II	ED II or III	See OIP LIII, Fig. 30		
D.544.240	39b	As.	D 17:31		Archaic Shrine III	ED I	As.34:157. See pp. 53, 138		
D.544.340	35b	Kh.	P 43?		Houses 12?	Protolit.d?	Kh.IX 217; B. See p. 48		
D.544.353	41b	Ag.	Hill B?			ED I?	See pp. 53-54, 137		
D.544.540	65:77	Ag.	Hill B		Top layer	ED I	Ag.36:575; B. See pp. 59, 79		
D.545.222	39a	Kh.	P 43:33	78	Houses 8	ED I	See pp. 53, 133, 138, 141		
D.545.320	49i	Kh.	O 43:18	72	Houses 9	ED I	See p. 59		
D.545.322	65:1	Ag.	Hill B		Top layer	ED I	Ag.36:579; B. See pp. 53, 72, 78		
D.545.342		Kh.	P 43:23	80	Houses 6	ED II			
D.545.542		Kh.	J 43:2		Houses 3	ED III	See pp. 91, 97		
		As.	E 17:16*		Archaic Shrine II	ED I	As.34:205. See p. 53 and OIC No. 20, Pl. IV 5; published in OIP LVIII as D.546.542		
D.545.626	20a-a'	Kh.	P 42:50		(Sin II)	Protolit.c	Kh.VII 116; C. See pp. 38, 126	Jamdat Nasr Telloh al- ^c Ubad Nineveh Susa	Mackay, Pl. LXIV 27 G I, Pls. 23:1 and VI 4304 Pl. XX 1453 (frags. with similar decoration) AAA XIX, Pl. LXI 21 (flat base; much smaller); XX, Pls. LI 6 (flat base) and LII 14 (flat base; much smaller) Mém. XXV, Fig. 33:1-2
D.545.640		As.	N 30:6 L 30:1 N 31:3 O 30:3			Larsa Larsa Larsa Larsa	As.30:P.35; C. See p. 118 As.30:P.35c; C As.30:P.35b; C As.30:P.35a		
D.546.540a	115d	As.	J 19:11		Houses IVa	L. Agade	As.32:647. See p. 112		
D.546.540b		As.	D 16:8		Outside N. Palace	Protoimp.?	As.32:852. See pp. 108, 112	Ur Assur	RC, Type 201 Pl. 25a
			D 15:1 Below H 18:22		N. Palace Houses IVb	Protoimp. E. Agade			
		Kh.	J 19:6 J 20:12 R 45*	164	Houses IVa-I Houses IVa Above Houses 2	Agade or later L. Agade ED III	Kh.I 31L		
D.546.542		As.	E 17:16				See D.545.542		
D.555.340		As.	D 17:18		34.00 m.	ED III?	As.34:60. See p. 97		
D.555.510a		As.	G 18:3		Houses IVa	L. Agade	As.31:P.20. See p. 112	Ur	RC, Type 79
D.555.510b		As.	E 16:34		Earlier N. Palace	ED III	As.32:851. See pp. 99, 108, 112	Kish Assur	"A," Pl. LIV 6 Pl. 25 a
			D 17:19 J 19:64 J 20:10 J 20:12		Houses Va Houses IVa Houses IVa	Protoimp.? Protoimp. L. Agade L. Agade			

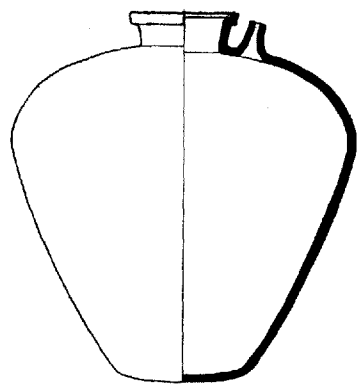

D. 535.542

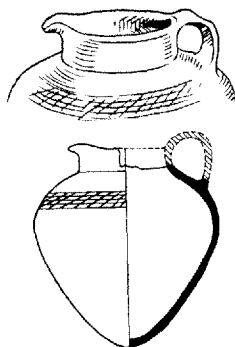

D. 545.626

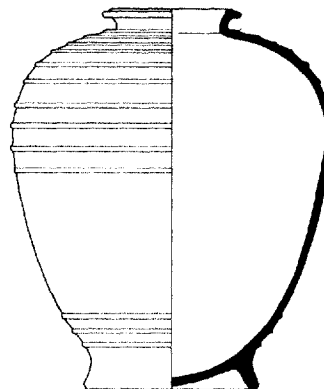

D. 555.340

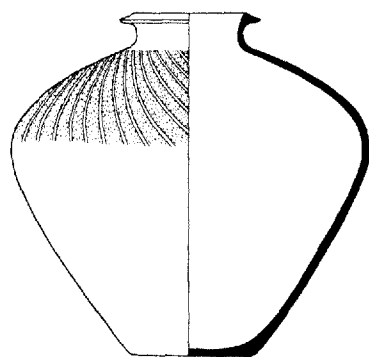

D. 544.240

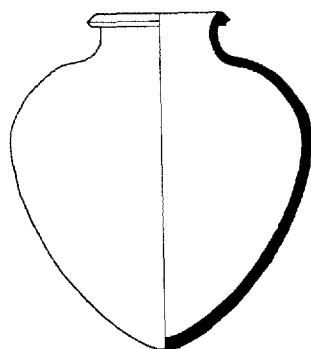

D. 545.640

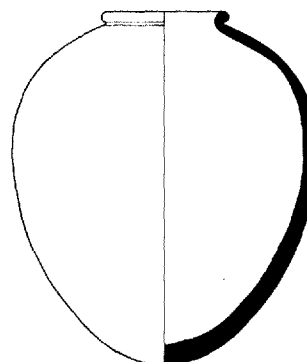

D. 555.510 *a*

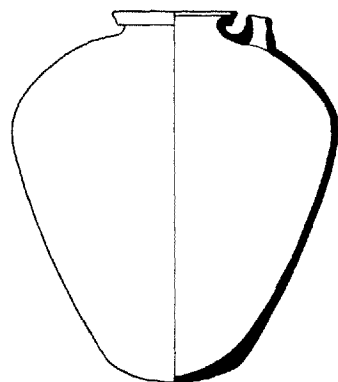

D. 545.542

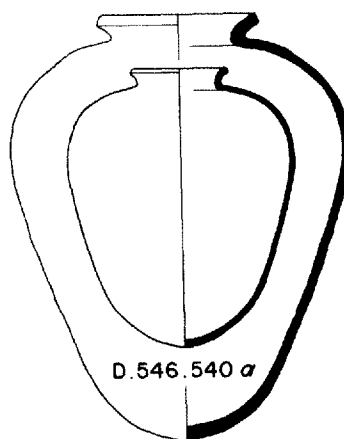

D. 546.540 *a*

D. 546.540 *b*

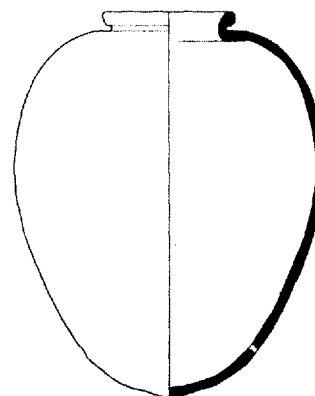

D. 555.510 *b*

D. 555-D. 596

Form	Photo on Plate	Site	Square, Locus, or Area	Grave	Building or Level	Date of Find-Spot	Remarks	Comparanda	
								Site	Reference
D. 555.540	108	As.	J 18:19		Houses IVb	E. Agade	As.32:1265. See p. 112	Gaura	Pl. LXX 142
D. 556.540a		Kh.	P 42:9		Houses 3	ED III	See pp. 97, 104		
D. 556.540b		Kh.	P 44:12		Houses 2	ED III	See pp. 97, 112		
D. 556.640		As.	O 34:5 J 20:10		Ibīqadad II Houses III	L. Larsa Gutium-Ur III	As.31:P.74; C. See pp. 114, 118		
D. 565.310		Kh.	Q 44:1 N 46:1		Houses 2 or 1 Oval I	ED III ED II	Kh. III 1377. See p. 97		
D. 566.370		Kh.	N 46:1		Oval I	ED II			
D. 596.540		As.	J 20:10 D 17:19 H 18:5		Houses IVa Houses IVb	L. Agade Protoimp.? E. Agade	As.32:P.60. See pp. 107, 112 As.32:648; B		
		115c							

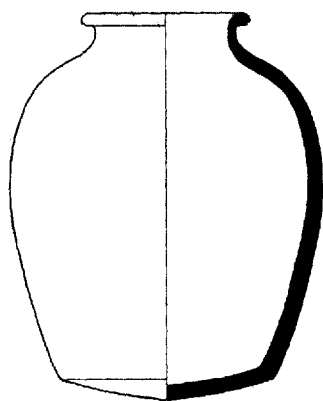

D.555.540

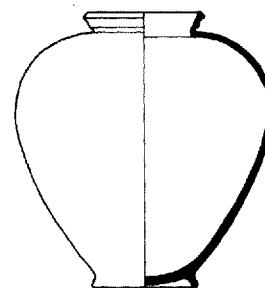

D.565.310

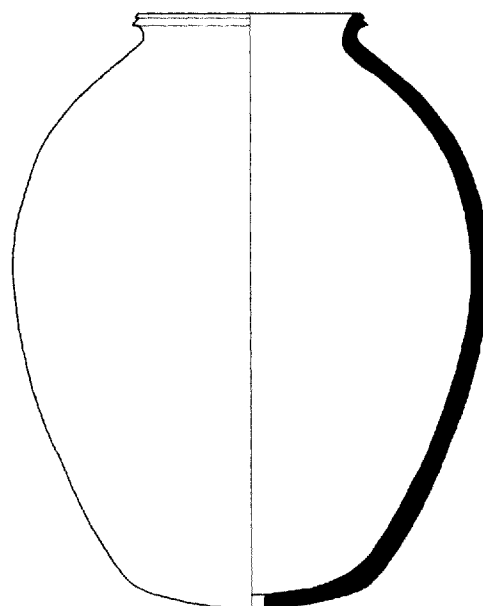

D.556.540 *a*

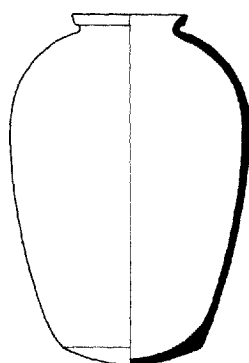

D.556.540 *b*

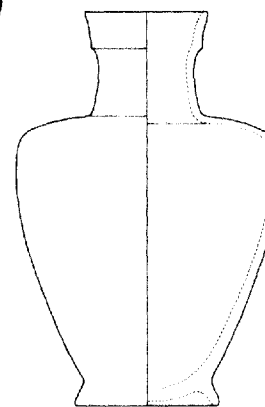

D.566.370

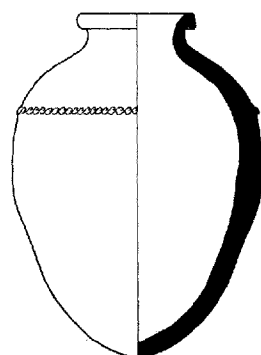

D.556.640

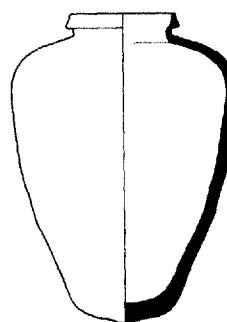

D.596.540

D.654-D.801

Form	Photo on Plate	Site	Square, Locus, or Area	Grave	Building or Level	Date of Find-Spot	Remarks	Comparanda	
								Site	Reference
D.654.310		As.	E 14: 1 E 16: 17		N. Palace N. Palace	Protoimp. Protoimp.	As.32:734. See p. 108 Sunk below floor, cutting wall below		
D.656.540		As.	F 17: 5 J 18: 1*		N. Palace Houses IVb	Protoimp. E. Agade	As.32:P.62. See p. 108 Upper part only		
D.665.542		Kh.	P 42: 50		(Sin II)	Protolit.c	Kh.VII 111; B. See p. 46		
D.743.310		Kh.	N 43: 15		Houses 4	ED II			
D.755.543		As.	G 18: 11		Houses IVb	E. Agade	As.31:P.118; B. See p. 112		
D.80-.-.-		Kh.	P 45: 14		Houses 2	ED III			
D.800.102	118a	As.	H 18: 5		Houses III or II	Gutium-Ur III	As.31:P.139b; C. See pp. 101, 114	Warka	UVB X, Pl. 29 a
D.800.200		As.	G 18: 9 W. of M 31: 17		Houses IVa Below Bilalama	L. Agade E. Larsa	As.31:P.129a; C. See pp. 112, 114, 118 As.31:P.129b; C	Bismayah Nuzi	AJSL XXII 141, No. 46 (4 compartments) Pl. 81 A-C
D.801.201	117c 104e	As.	J 19: 43 E 17		Houses IVb	E. Agade Protoimp.?	As.32:858. See pp. 108, 112 As.32:504		

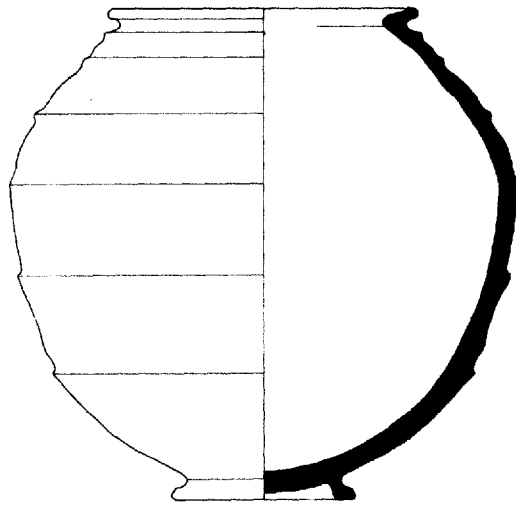

D. 654. 310

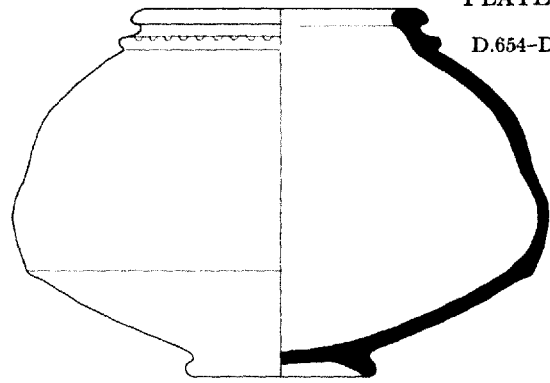

D. 743. 310

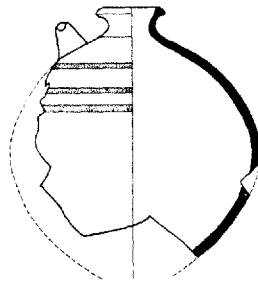

D. 665. 542

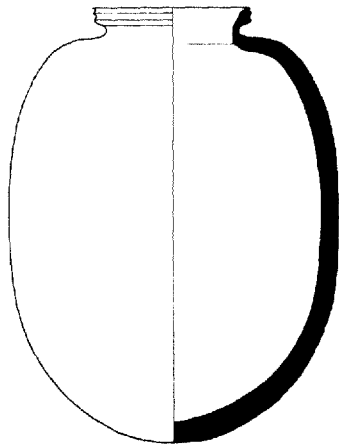

D. 656. 540

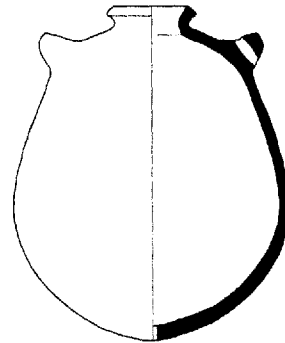

D. 755. 543

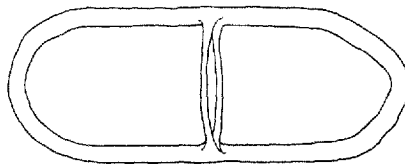

D. 800. 200

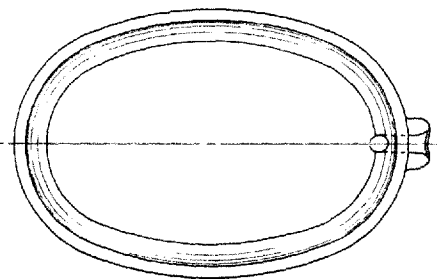

D. 800. 102

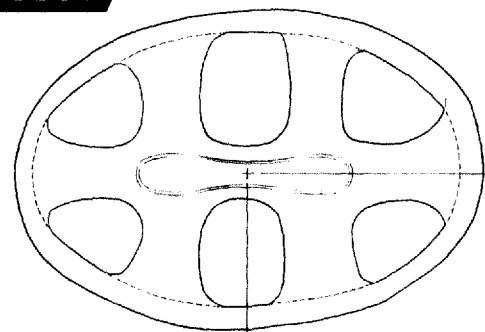

D. 801. 201

Form	Photo on Plate	Site	Square, Locus, or Area	Grave	Building or Level	Date of Find-Spot	Remarks	Comparanda	
								Site	Reference
E.05-,-,-		Kh.	O 42:8	79	Houses 8	ED I			
E.062.210	118c	As.	N 34:11		Below Ibiqadad II	L. Larsa	See p. 119		
E.084.310		Kh.	K 42:4		Oval I	ED II	Hole in base		
E.202.010		As.	L 31:2 L 31:1 M 31:1 M 31:9			L. Larsa L. Larsa Larsa L. Larsa	As.30:P.30. See p. 119 3 specimens Lower part of vat used as top; see OIP XLIII, Fig. 70	Telloh Farah Nippur Bismayah	G II, Pl. 75:1 MJ XXII, Pl. III 2 Pl. facing p. 362 Bismya, p. 346
			N 30:11 N 31:10 O 29:2 O 30:17 P 31:1			Larsa Larsa L. Larsa Ur III Larsa	See OIP XLIII, Fig. 47 See p. 114		
E.204.010		Kh.	Q 42:16		Sin IV	Protolit.d	See OIP LVIII 23 and Figs. 17, 19		
E.205.310		Kh.	R 42:2 R 42:2		Sin VIII Sin IX	ED II ED II	2 specimens. See OIP LVIII, Fig. 67		
E.208.010		As.	O 30:18			Ur III	Tubular drain pipes; see p. 114 and OIP XLIII, Figs. 17-18	Telloh Mohenjo Daro	G II, Pl. XXIX 613 Pls. CVIII 30 and CX 35
E.223.000		As.	M 32:3			L. Larsa	As.30:P.32. See p. 119		
E.223.010		As.	M 31:1 SW. of M 31:1 M 31:6 N 31:1 S. of N 31:3 N 31:4 O 29:6 O 30:3 O 30:5 P 29:5			Larsa Larsa Larsa L. Larsa L. Larsa L. Larsa L. Larsa	As.30:P.27. See p. 119		
E.225.310		Kh.	R 42:2		Sin IX	ED II	See pp. 104, 119 and OIP LVIII, Fig. 67		
			L 45:1 L 45:3 M 44:7 N 45:2 N 31:1		Oval II Oval II Oval III Oval II	ED III ED III ED III ED III Larsa	Lower part only 3 specimens. See OIP XLIII, Fig. 69		
E.229.010		As.	O 31:3			Larsa	As.31:P.98. See p. 119		
E.232.010	109	Kh. As.	P 42:9 Between Q 32:4 and Q 32:6		Houses 4 Ibiqadad II	ED II L. Larsa	See pp. 104, 119 See OIP XLIII, Fig. 81		

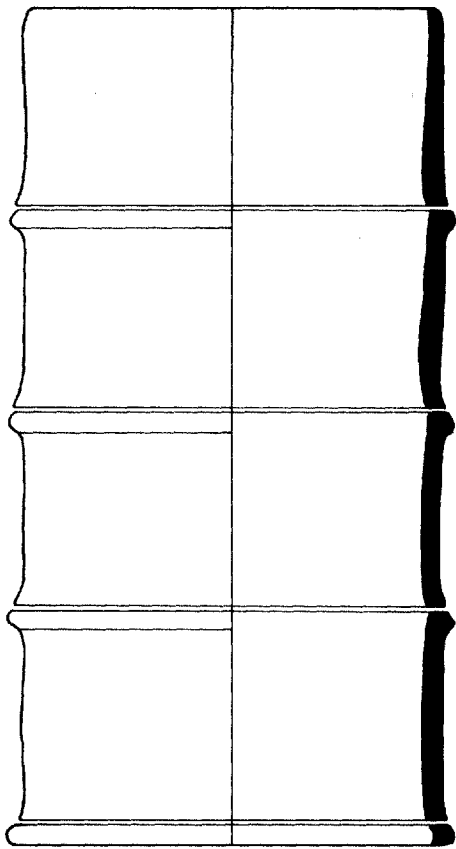

E.202.010

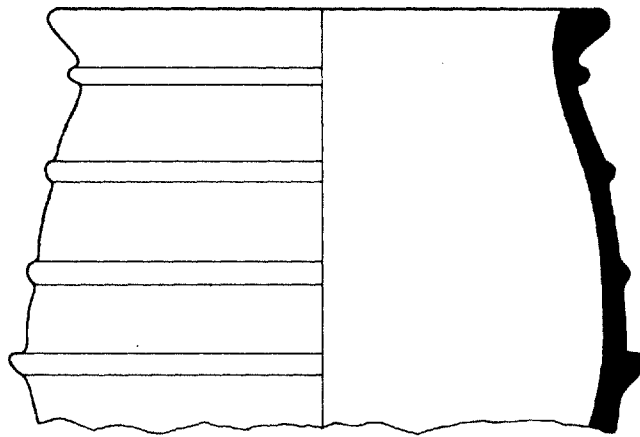

E.223.010

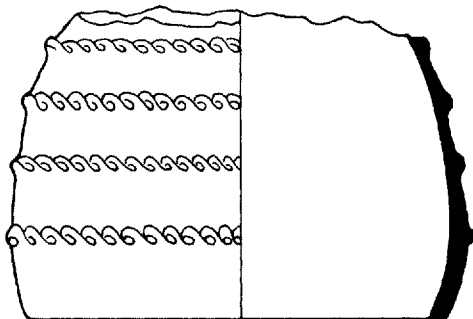

E.223.000

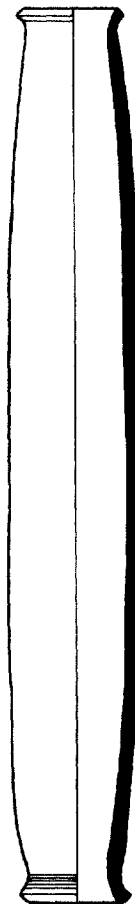

E.229.010

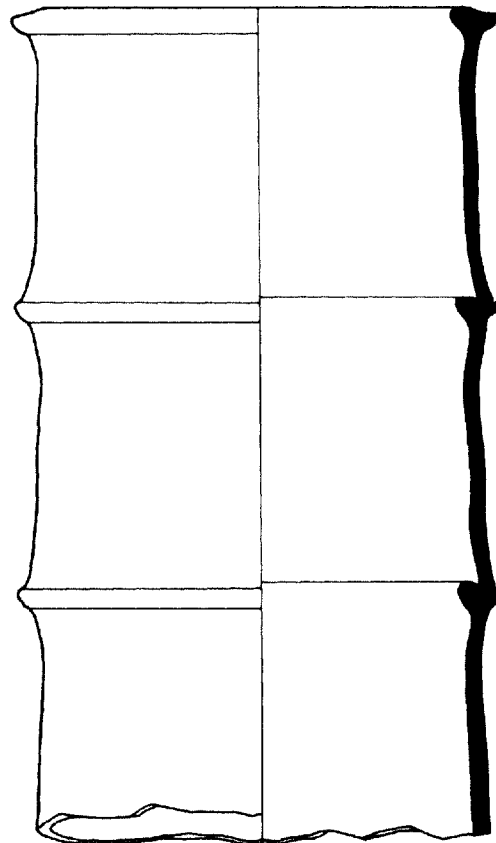

E.232.010

E.235-E.313

Form	Photo on Plate	Site	Square, Locus, or Area	Grave	Building or Level	Date of Find-Spot	Remarks	Comparanda	
								Site	Reference
E.235.010		As.	E 16:34		Earlier N. Palace	ED III	As.32:856. See p. 104		
		Kh.	M 44:8		Oval I	ED II	See OIP LIII, Fig. 113		
E.235.310		Kh.	M 43:6		Oval II	ED III	2 specimens, 1 with hole in bottom; see p. 104 and OIP LIII, Figs. 84 and 114		
			M 44:6		Oval II	ED III			
E.244.310	128a, 129	As.	S 37		Snake Shrine	Larsa	As.35:98; B? See pp. 119, 121-22 and Front. d-g		
E.257.010		As.	H 18:2		Houses III	Gutium-Ur III	See p. 114; through NE. wall		
E.303.010		Kh.	O 43:16		Small Temple IX	ED III	See p. 104	Telloh	G II, Pl. 124:3
E.313.010		As.	M 32:5 K 31:1 L 32:2 M 32:2 M 32:3 N 30:4 S. of O 30:5			Larsa E. Larsa Larsa L. Larsa L. Larsa Larsa Larsa	As.30:P.28. See p. 119 2 specimens		
E.313.020		As.	O 30:18			Ur III	Vertical rows of holes; see p. 114 and OIP XLIII, Figs. 17-18		
E.313.040		As.	O 29 J 18:4		Houses IVa	Larsa L. Agade	As.30:P.29. See pp. 119, 149 See p. 112	Telloh Susa	G II, Pl. 79:4 Mém. I, Fig. 323

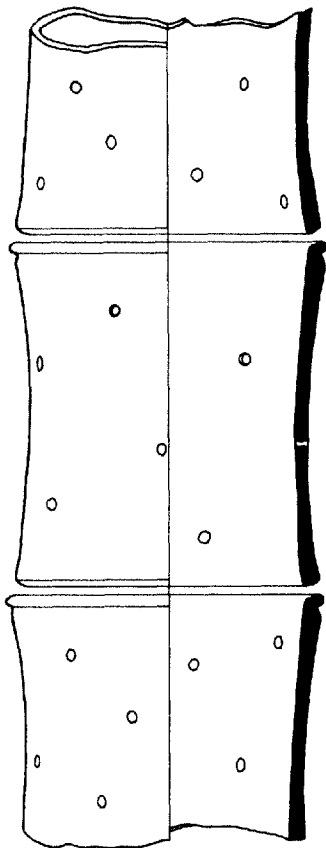

E.235.010

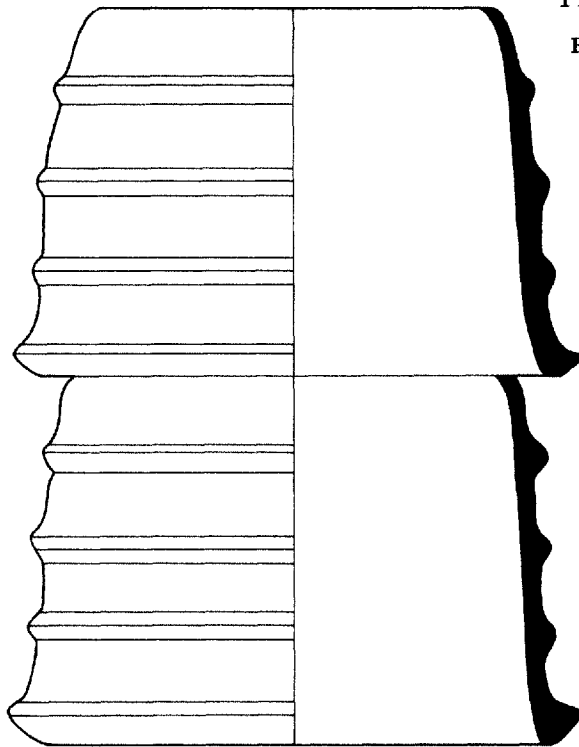

E.313.010

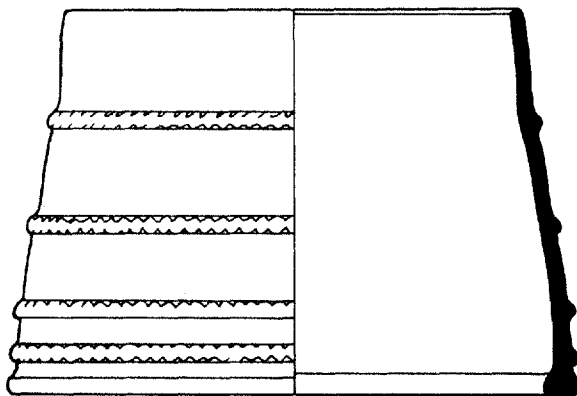

E.303.010

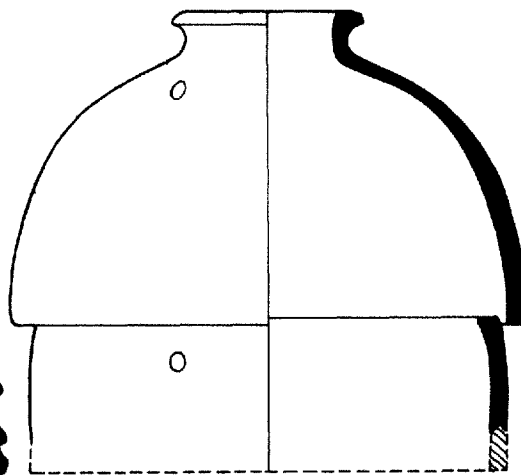

E.313.040

E.314-E.800

Form	Photo on Plate	Site	Square, Locus, or Area	Grave	Building or Level	Date of Find-Spot	Remarks	Comparanda	
								Site	Reference
E.314.010		As.	P 29:3 W. of L 32:1 M 31:1 N 30:4 N. of N 31:1 NE. of N 31:1 O 29:5 O 29:6 O 30:1 Below O 30:6 N. of O 31:1			Larsa Larsa Larsa Larsa Larsa Larsa L. Larsa Larsa L. Larsa Larsa	As.30:P.26, See p. 119 See OIP XLIII, Fig. 63	Telloh	G II, Pl. 119:3
E.544.310	128b	As.	S 37		Snake Shrine	Larsa	As.35:97; B? See pp. 119, 121-22 and Front, a-c		
E.588.000	65:78	Ag.	Hill B		Top layer	ED I or later	Ag.36:574; B. See pp. 59, 79		
E.655.000		As. Ish.	L 31:4 S 29:7		Kititum III	E. Larsa L. Larsa	As.30:P.31. See p. 119 Ish.P.34		
E.800.201		Kh.	N 44:6	110	Houses 4	ED II	Coffin		

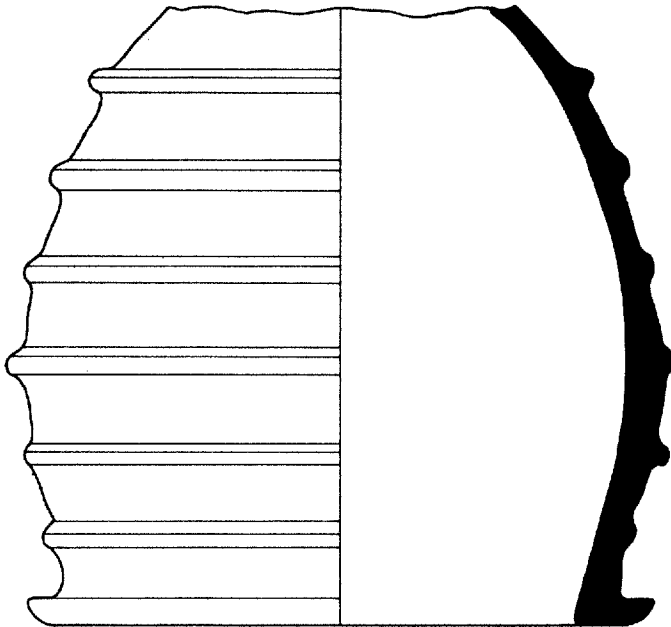

E.314.010

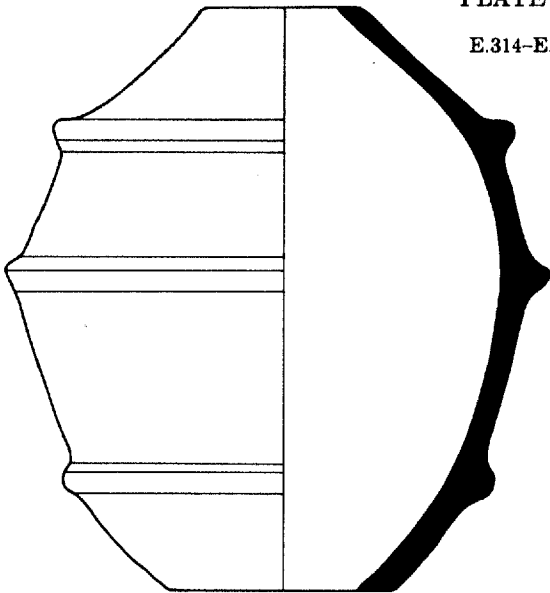

E.655.000

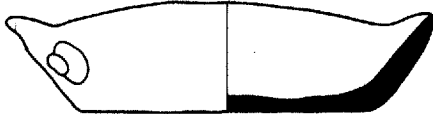
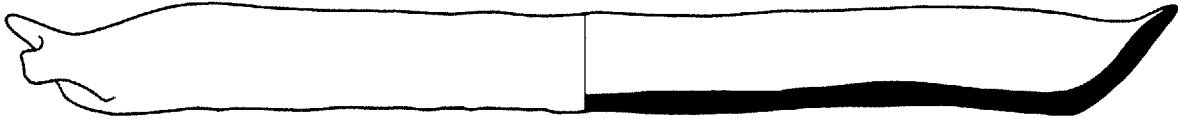
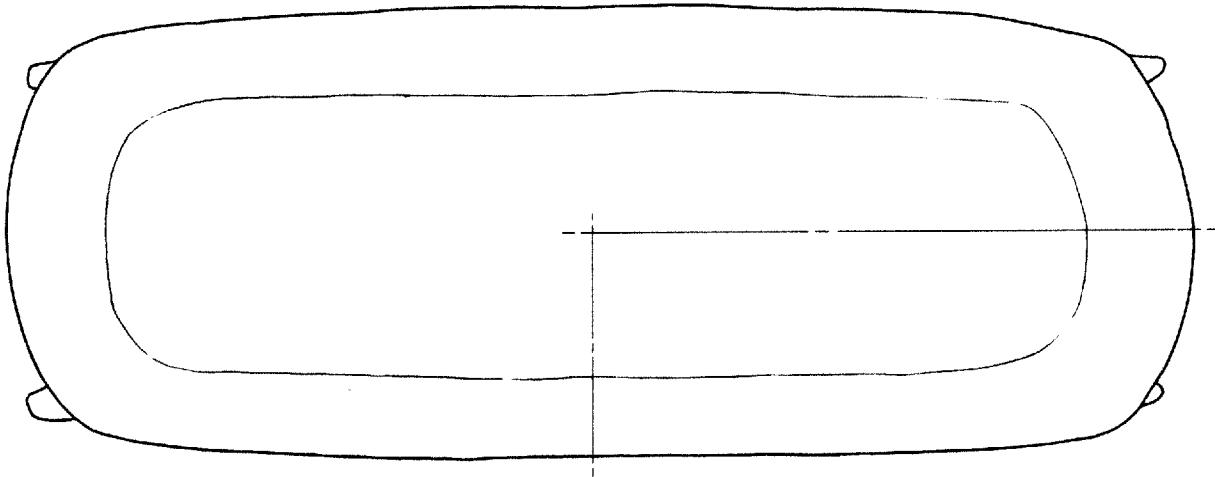

E.800.201

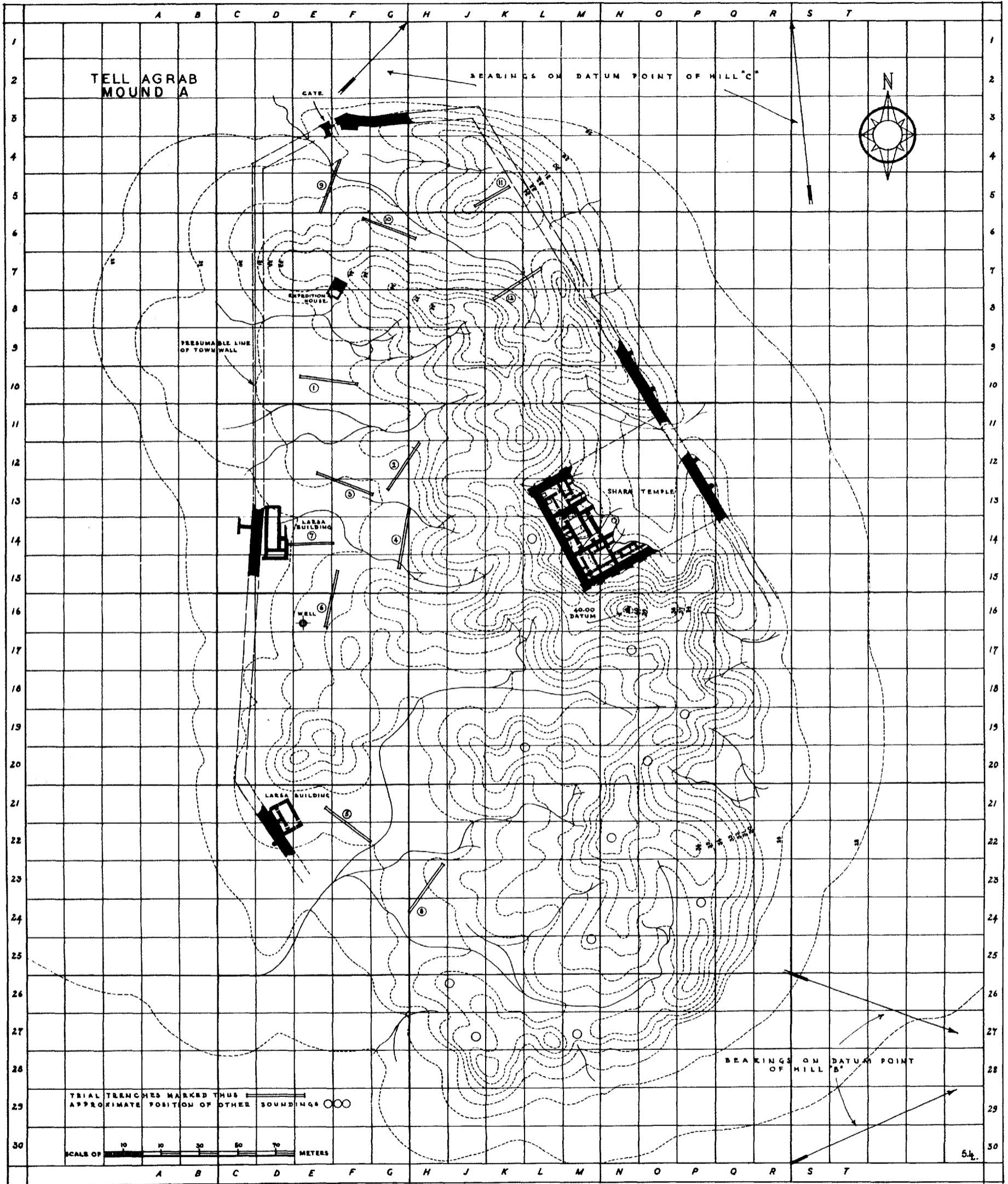

CONTOUR MAP OF MOUND A AT TELL AGRAB SHOWING EXCAVATED AREAS. SCALE, 1:2000

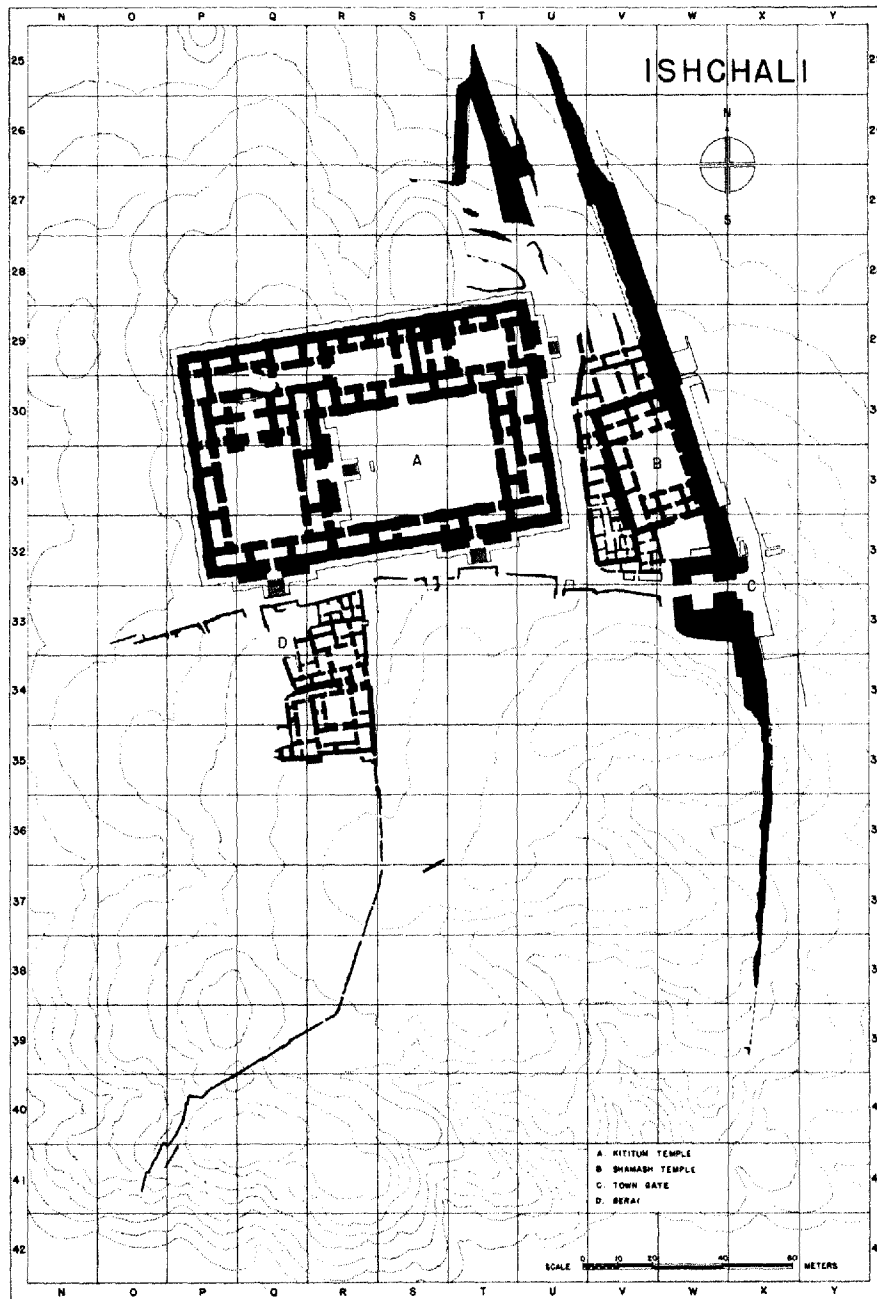

CONTOUR MAP OF EXCAVATED AREA AT ISHCHALI. SCALE, 1:2000

TABLE III
STRATIGRAPHIC CORRELATION OF ALL EXCAVATIONS ON THE DIYALA SITES

	KHAFAJAH						TELL ASMAR				TELL AGRAB		ISHCHALI	
	MOUND A					MOUNDS B-D	ABU TEMPLE	HOUSES	NORTHERN PALACE	PALACE OF RULERS AND GIMILSIN TEMPLE	SHARA TEMPLE	HOUSES AND SOUNDINGS	KITITUM TEMPLE	OTHER BUILDINGS
	Sin Temple	Houses	Small Temple in O 43	Nintu Temple	Temple Oval									
OLD BABY-LONIAN PERIOD						Dur Samsuiluna and houses on Mounds B and C								
ISIN-LARSA PERIOD	LATE					Temple and houses in Citadel on Mound D				Audience Hall (Naramsin) Southern Bldg. (Ibiqadad II)		Buildings on west flank of Mound A	IV III II	(Shamash Temple Serai) City Wall and Gate Houses
	EARLY						I	Houses	Palace of Rulers (built by Ilushuilia)	I (original building)	Unexcavated			
END OF GUTTIUM, UR III						Unexcavated	II III	Houses	Gimilsin Temple (built by Ituria)					
AGADE PERIOD	LATE						IV a	Houses						
	EARLY		Some brick work at northwest corner of mound				Single-Shrine IV	IV b	Debris					
PROTO-IMPERIAL PERIOD		Scattered burials					Single-Shrine III II	V a	Main level of Palace					
EARLY DYNASTIC PERIOD	III b		1				Single-Shrine I	V b V c	Earlier Palace Houses					
	III a	X ↑ IX	2 3	X IX	Houses 1 ↑ Debris					Latest building				
	II	IX ↑ VIII	4 5 6	VIII VII VI	VII VI V		Square Temple III-I	Sounding in H 18:14 (debris)	Sounding in D 15:3 (debris)	Main level Intermediate foundations				
	I	VII	7	V	IV		Archaic Shrine IV-I	Sounding in H 18:14 (26-29 m.)	Sounding in D 15:3 (26-30 m.)	Earlier building	Houses on Hills B and C			
		VI	8 9 10	IV III II	III II I							Earliest remains		
	PROLITERATE PERIOD	d	↑ V ↑ IV	11 12	I	I		Earliest Shrine	Sounding in H 18:14 (21-26 m.)	Sounding in D 15:3 (21-26 m.)	Unexcavated	Sounding on Hill B		
c		III II I Debris	Isolated brickwork	Isolated brickwork			3 m. of debris Virgin soil	Virgin soil	Virgin soil					

In this chart the various remains are dated to the periods in which they were built. As shown by arrows, some of these buildings survived in use from one period into another. There is no vertical time scale, and the heights of the boxes are not proportionate to the duration of the periods which they represent. Subdivisions of different buildings which happen to fall on the same horizontal line within a cultural period are not necessarily strictly contemporaneous. indicates the surface of a site in a particular area.