

Hmotná kultura a každodenní život III

vesnice





literatura

- Belcredi, L. 2006: Bystřec. O založení, životě a zániku středověké vsi. Brno.
- Dějiny hmotné kultury I(1), 1985.
- Le Goff, Jacques, 1999: Středověký člověk a jeho svět. Praha.
- Měchurová, Z. 1997: Konůvky – zaniklá středověká tvrz ve Ždánickém lese. Studie AÚ AV ČR v Brně 17/1.
- Nekuda, V. 1975: Pfaffenschlag. Zaniklá středověká ves u Slavonic. Brno.
- Nekuda, R. – Nekuda, V. 1997: Mstěnice 2, zaniklá středověká ves. Brno.
- Nový, L. a kol., 1974: Dějiny techniky v Československu do konce 18. st. Praha, 63–146.
- Vařeka, P. 2004: Archeologie středověkého domu I. Proměny vesnického obydlí v Evropě v průběhu staletí, 6.–15. století. Praha.

kolonizace

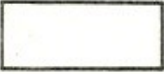
■ vnitřní

■ vnější

-  Staré sídelní území do 12. stol.
-  Oblasti lesní
-  Kolonizované území ve 14. stol.
-  Kolonizované území ve 13. stol.

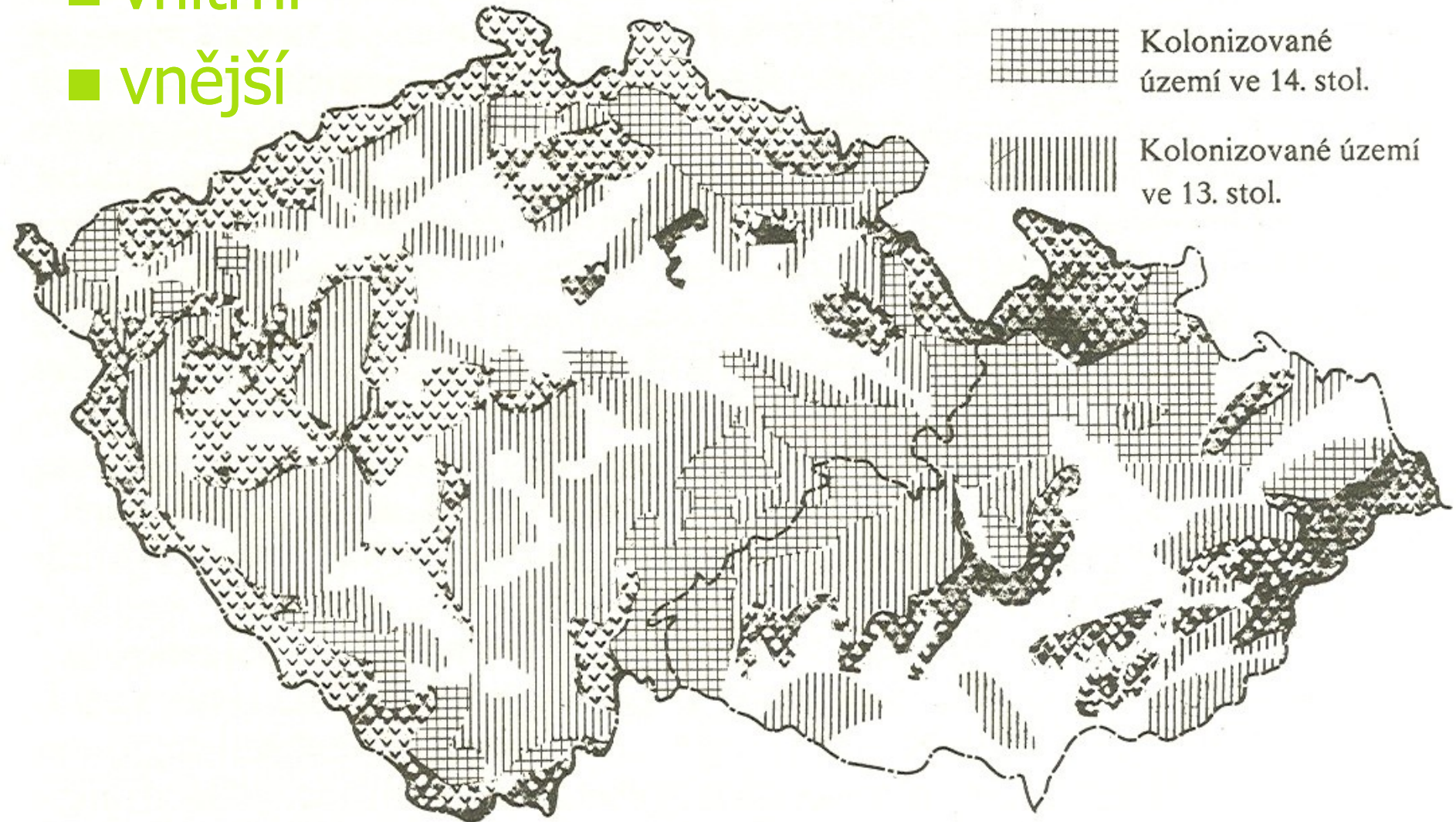

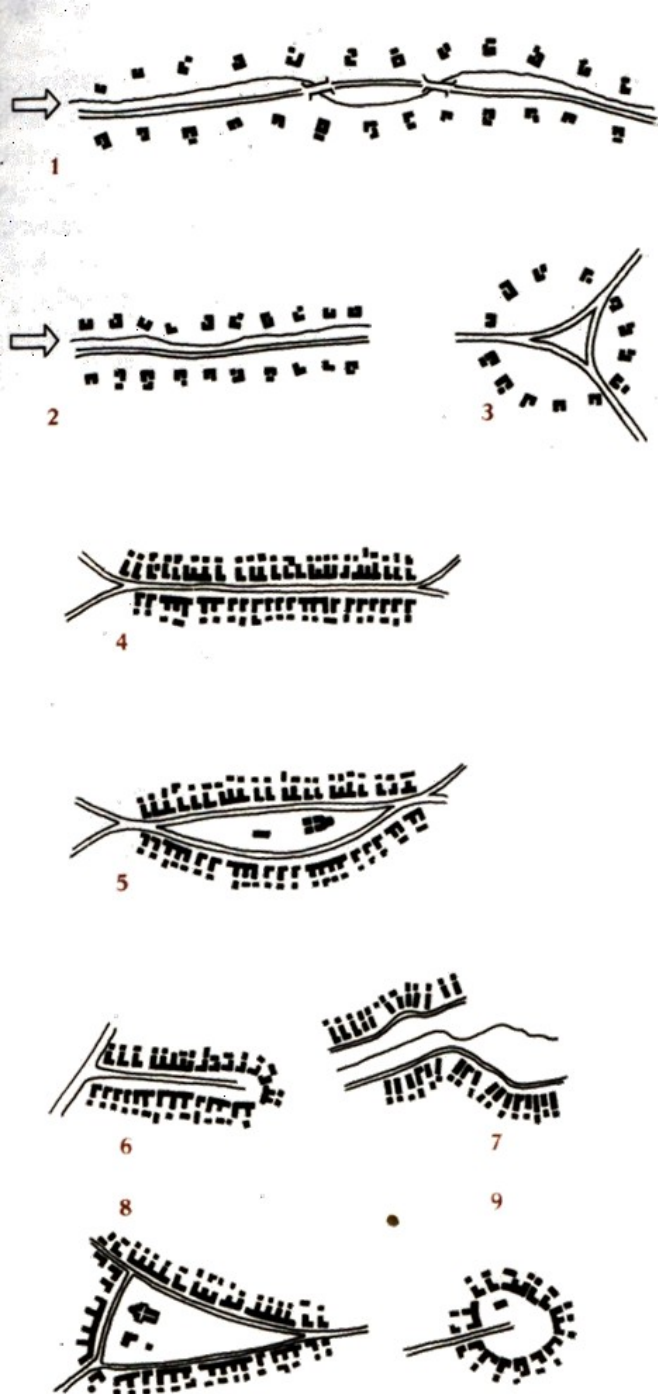

■ Půdorysy vesnic:

■ volně roztroušené vsi

■ lesní lánové vsi:

– dlouhé, po obou březích potoka (1)

– krátké dvojřadé (2)

■ lesní návesní (3)

■ silniční vsi:

– dvě řady domů v těsném sousedství (4)

– silniční návesovka (5)

– ulicovka (6)

■ řádkový půdorys (7)

■ návesní vsi:

– návesovka (8)

– okrouhlice (9)

Plužiny

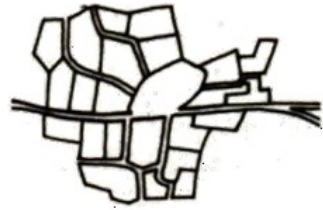

1



2



3



4

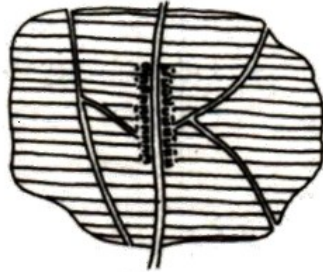

5

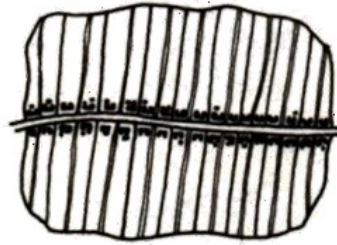

6

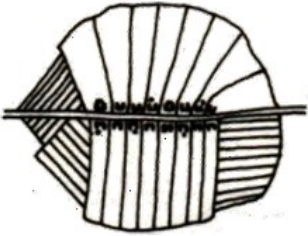

7



8

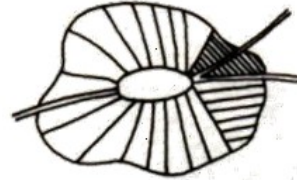

9



10



11

1. úseková
2. dělených úseků
3. traťová
4. nepravá traťová
5. délková
6. záhumenicová – lesní lánová
7. záhumenicová klínová a pásová
8. záhumenicová paprscitá
9. kompaktní
10. rozštěpená
11. rozptýlená

Pfaffenschlag (Slavonice)



Bystřec (Jedovnice)

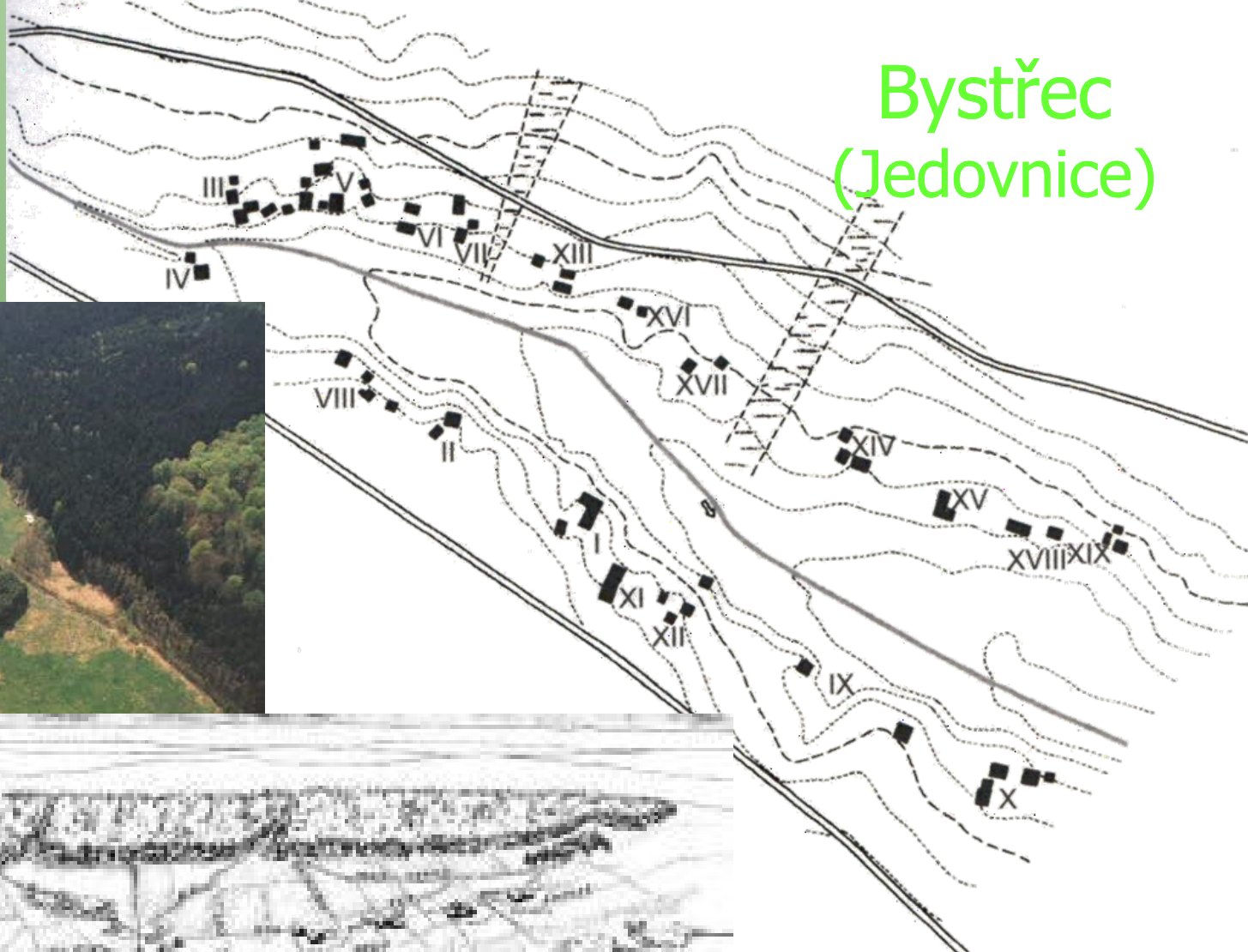

Konůvky (Ždánický les)

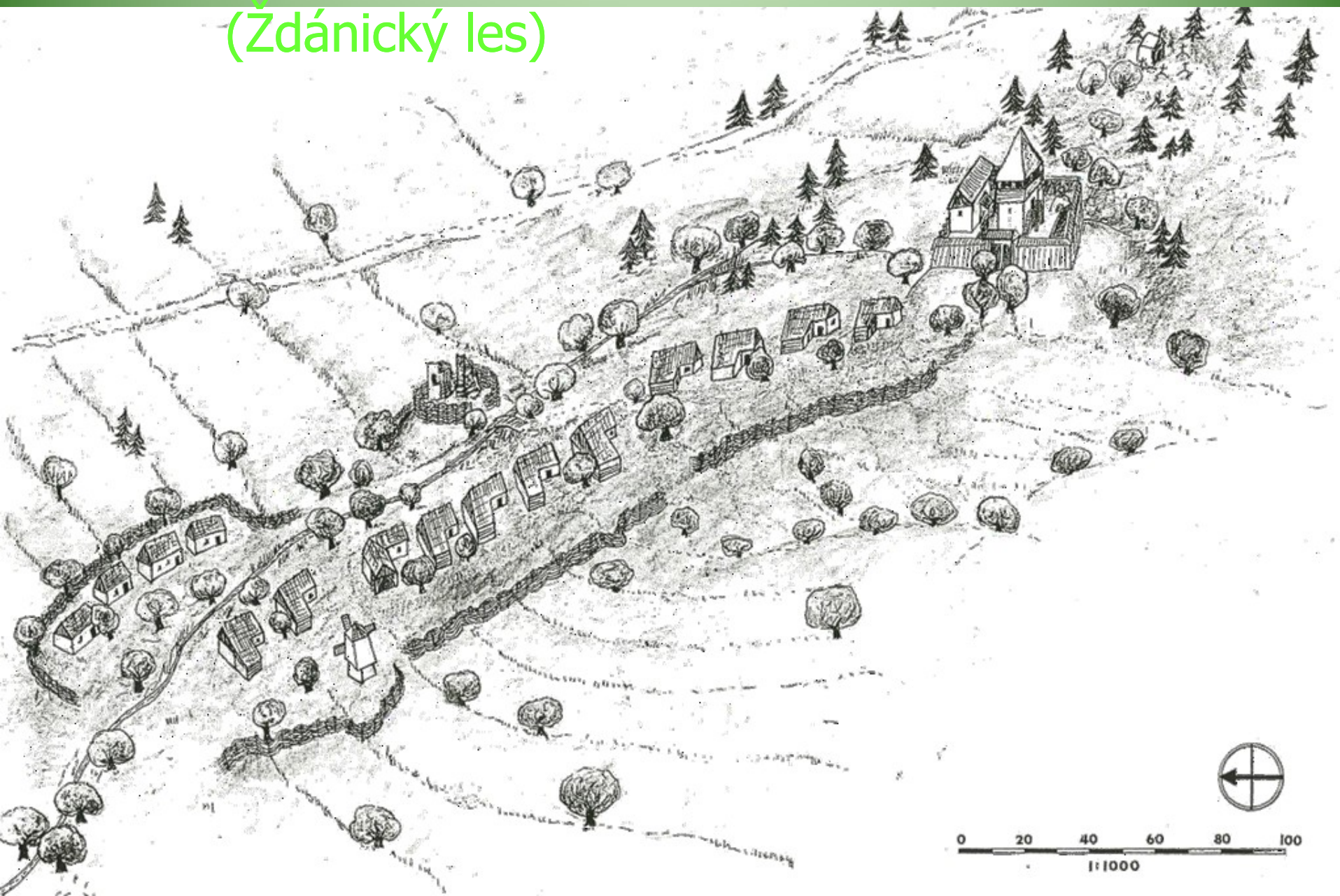



Mstěnice

2. polovina 11. – 1. polovina 12. století

vesnice

- rychta
- farní kostel

- fara
- hřbitov
- krčma
- kovárna
- mlýn
- trvz

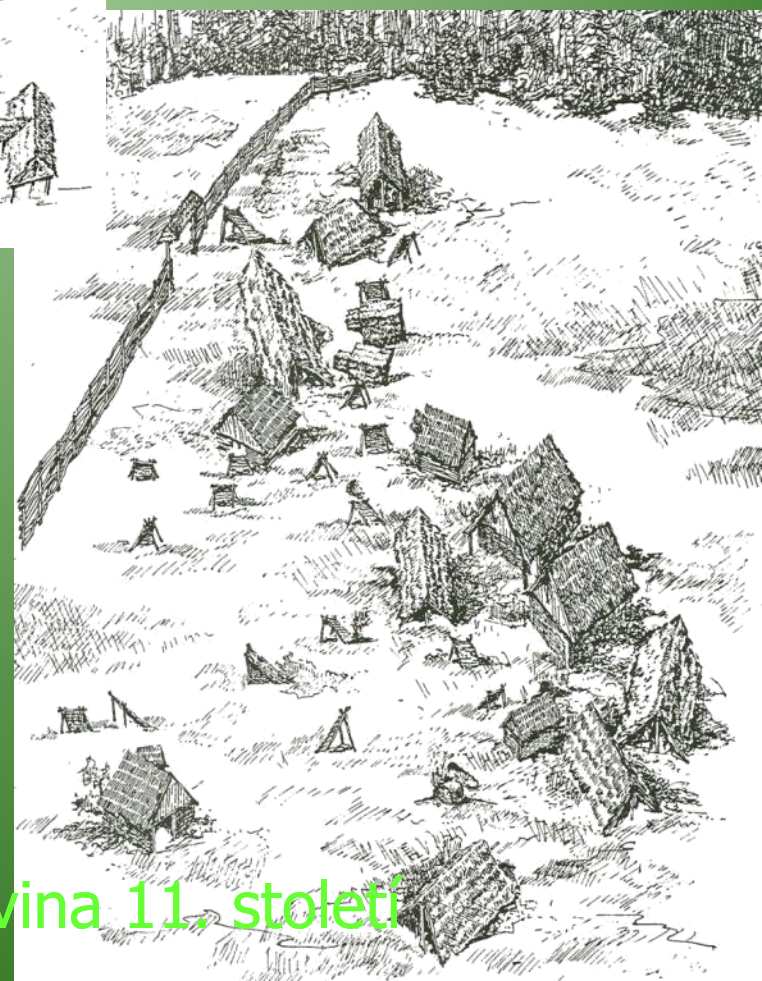

Mstěnice

10. – 1. polovina 11. století

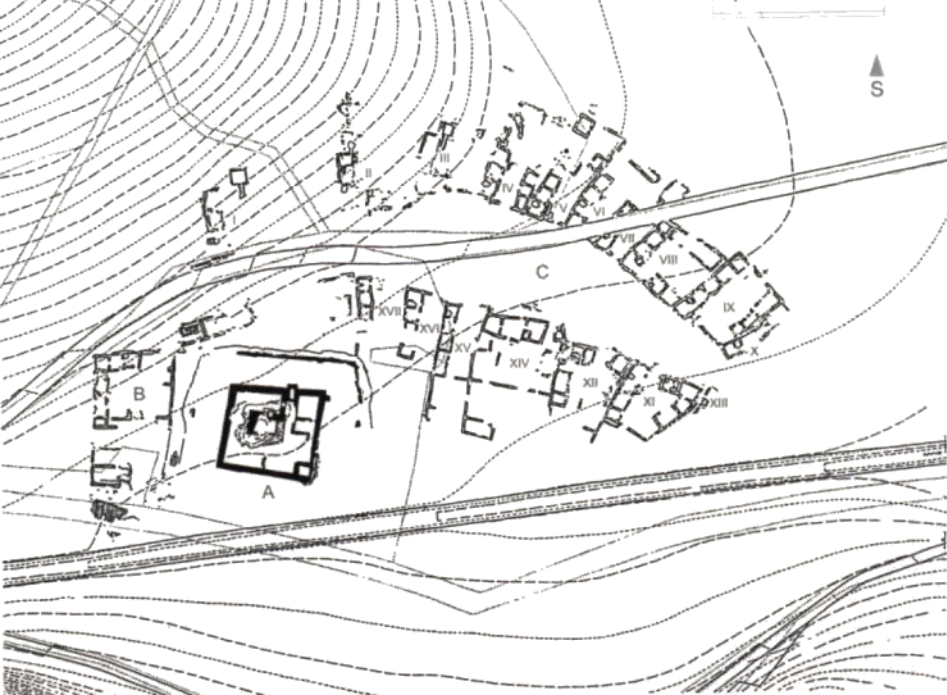

Mstěnice (Rouchovany)



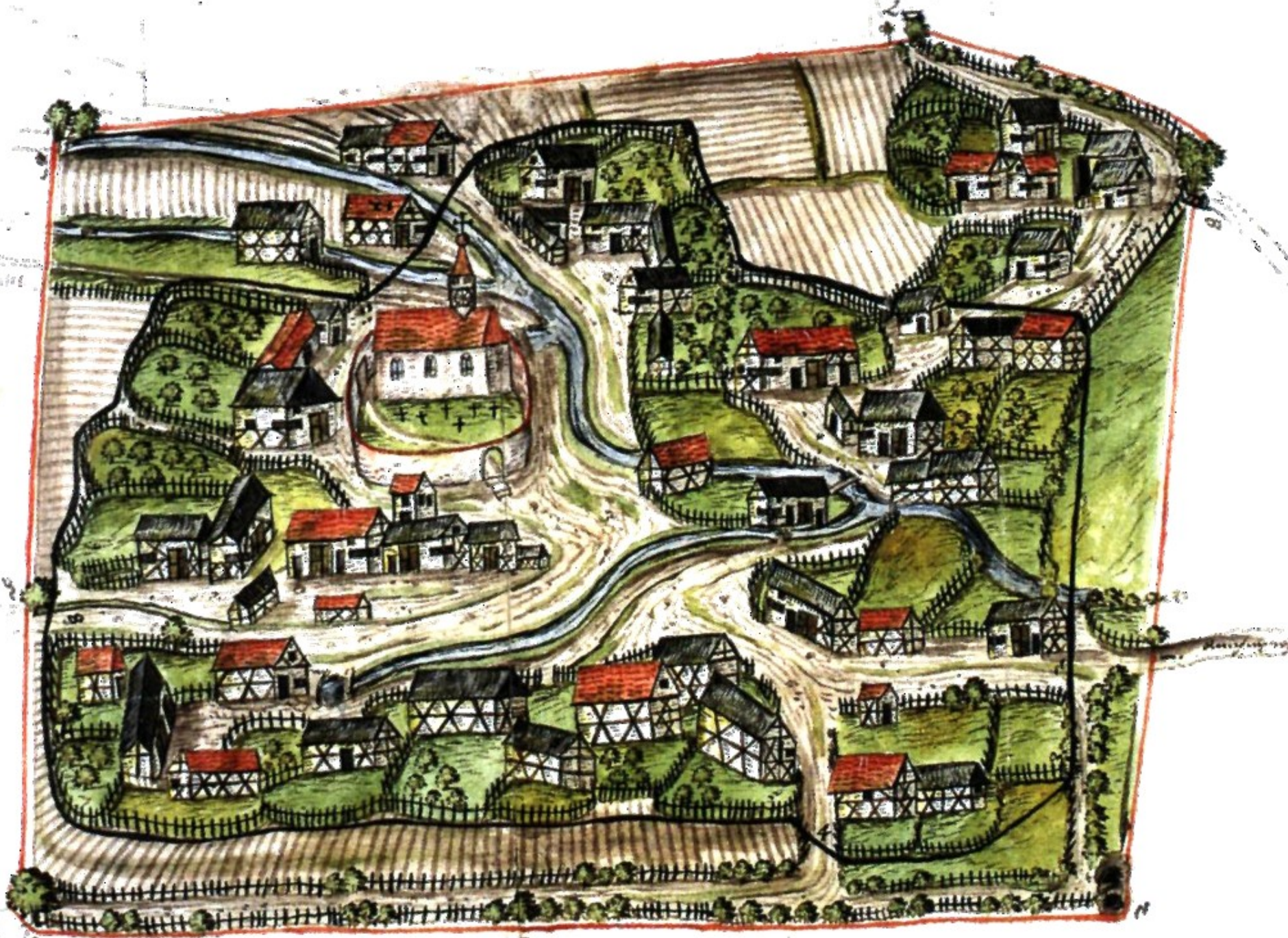

sociální struktura

- pán
- poddaný (poplatky, naturálie, roboty, rekvizice)
 - rolníci
 - podsedci
 - chudina
 - řemeslníci
 - rychtář (šafář, mlynář, krčmář)
- svobodník
- nápravník
- farář

půda

- v přímém užívání pána
- v pronájmu rolníků
- ve společném užívání
- lesy
- vodní toky

výměra

- lán (přes 18 ha)
- strych, korec
 - zásevek
- jitro
 - záhon (od 15.st.)
 - brázda

zemědělská půda

- klučení
- trojpolní hospodaření
 - ozim
 - jař
 - úhor



polní práce

- orba
- vláčení
- setí
- sklizeň

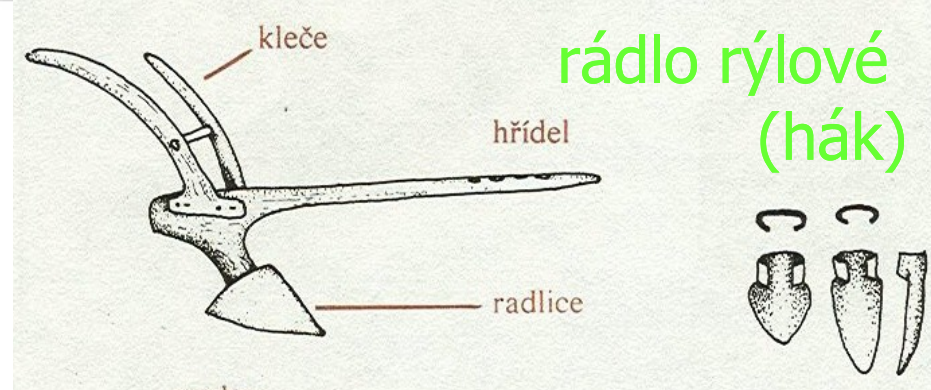

radlice

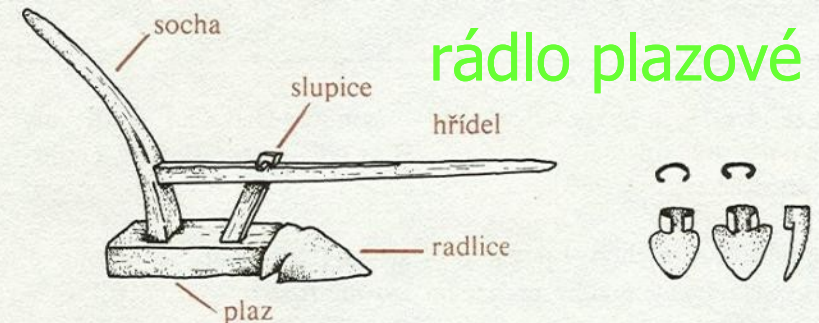
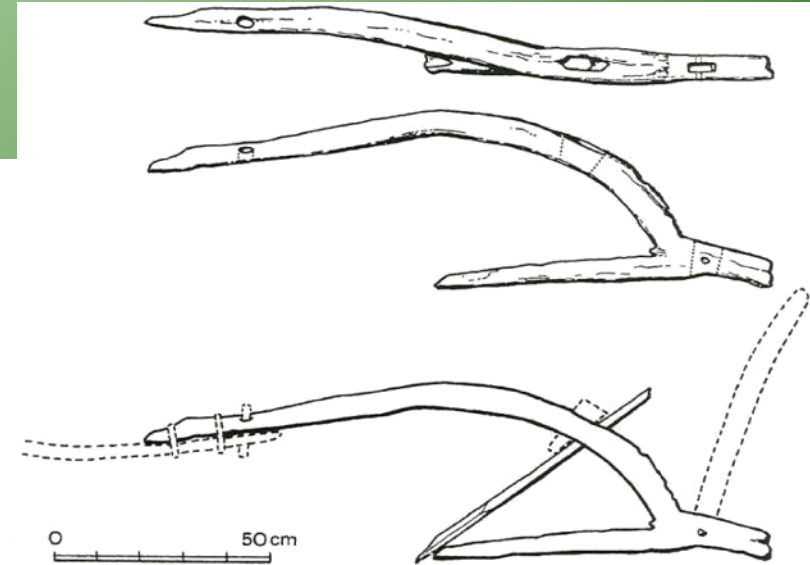

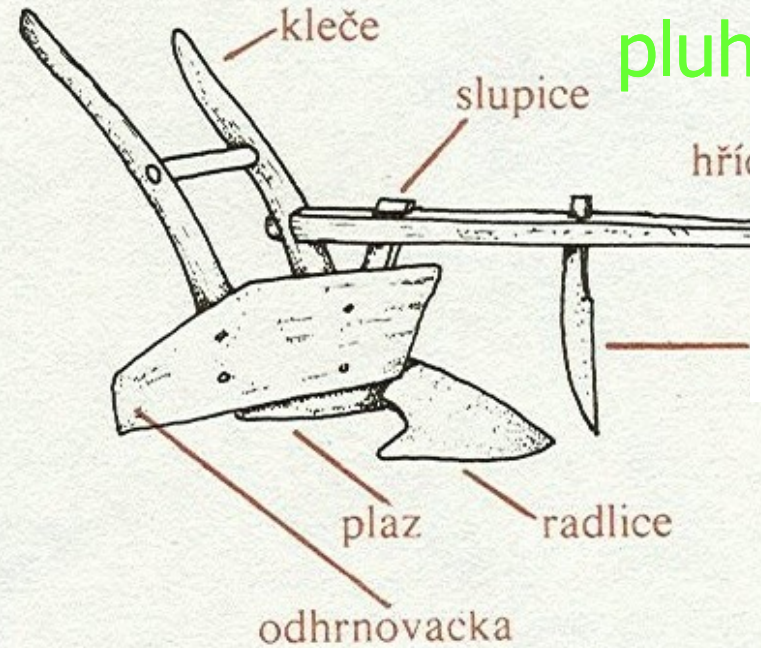

pluh



asymetrická radlice

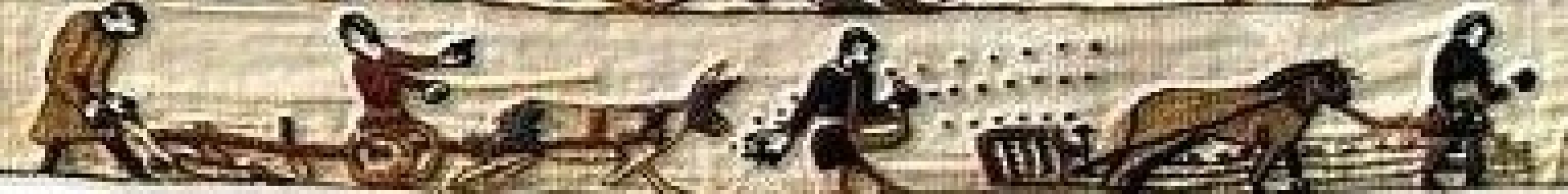



- krojidlo
- asymetrická radlice
- kopinatá radlička
- otky



orba

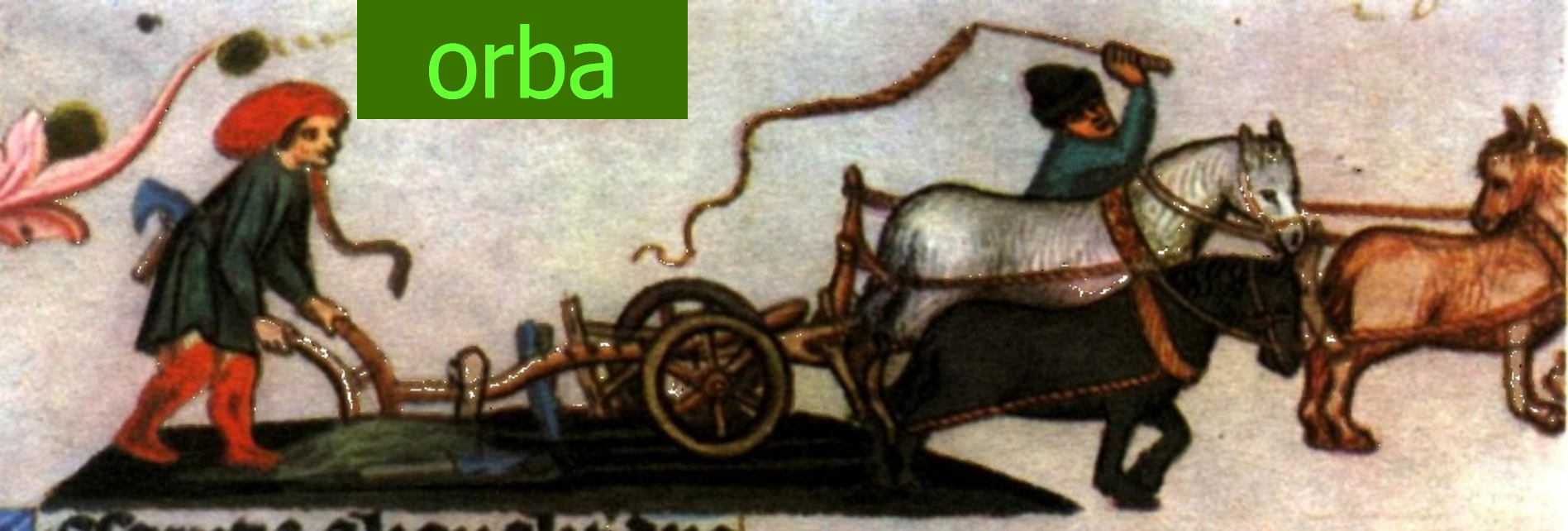

kolový pluh



zápřah

jho

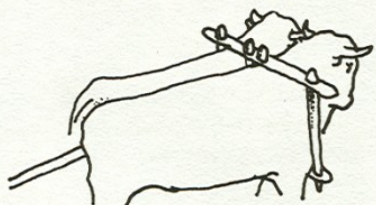
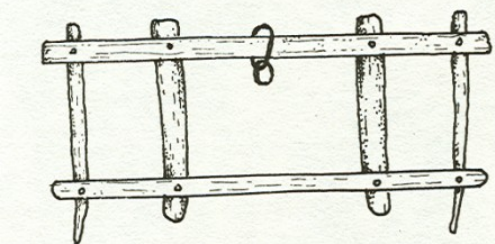
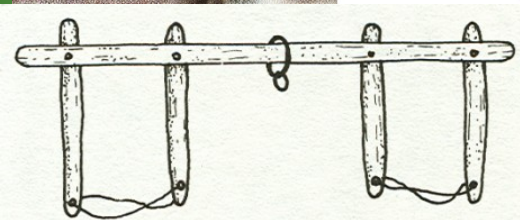
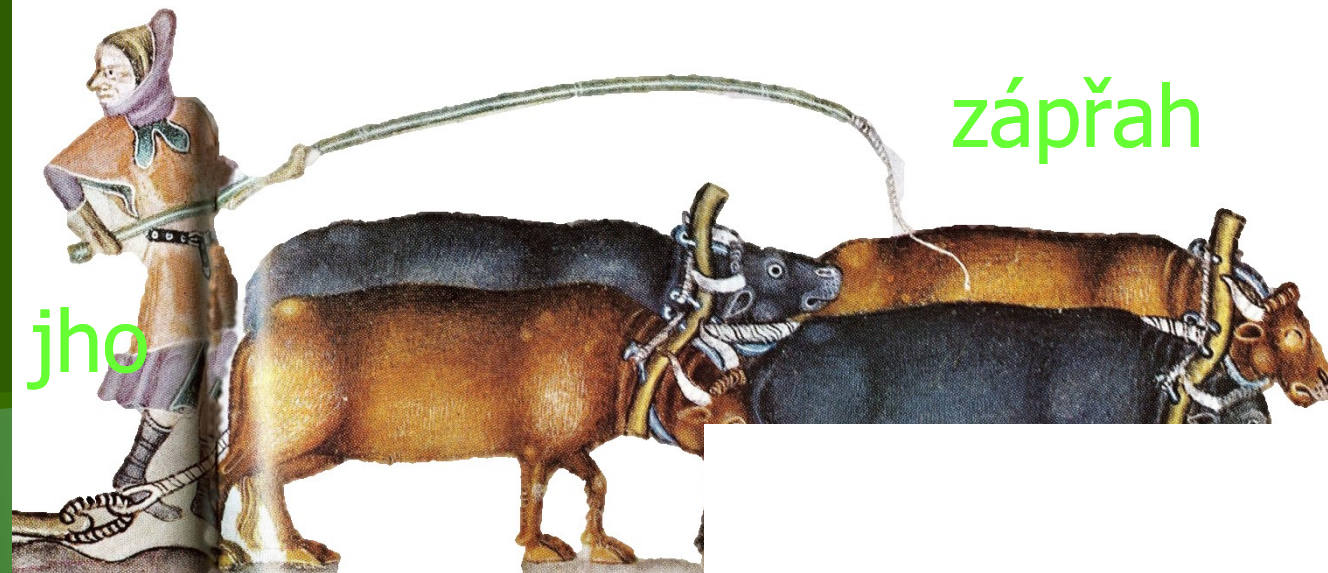

chomout

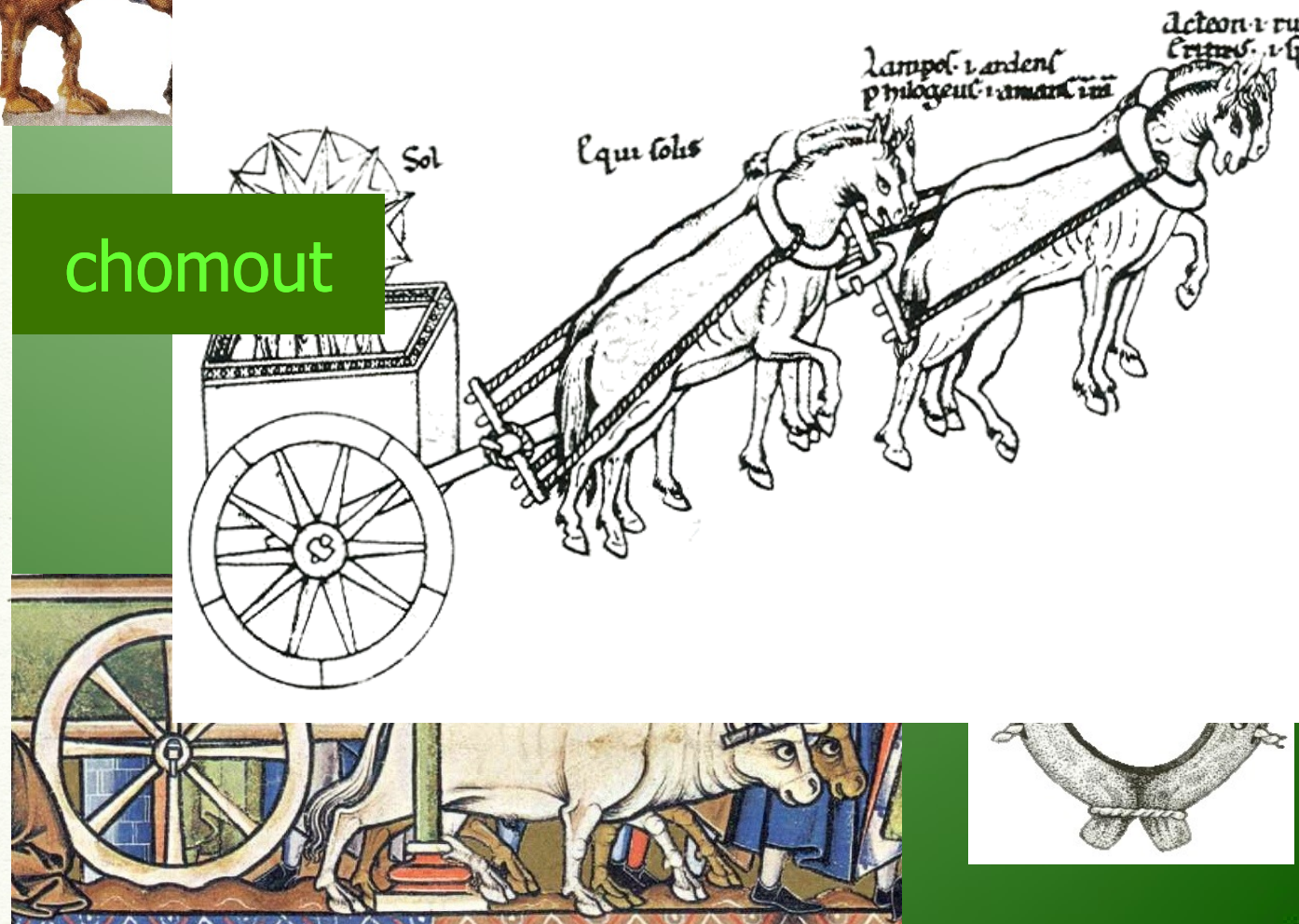

Sicut in irritacione: secundum diē



vláčení - brány



setba



men humi iacto



T	R	B	E
xvi	a		a
v	b	vi	H
xiii	c	v	H
ii	d	iiii	H

se sang
Barbye
oye.



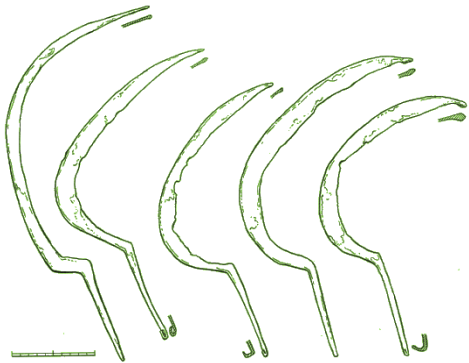

srpy



žně





senné vidle

mláčení

cepy

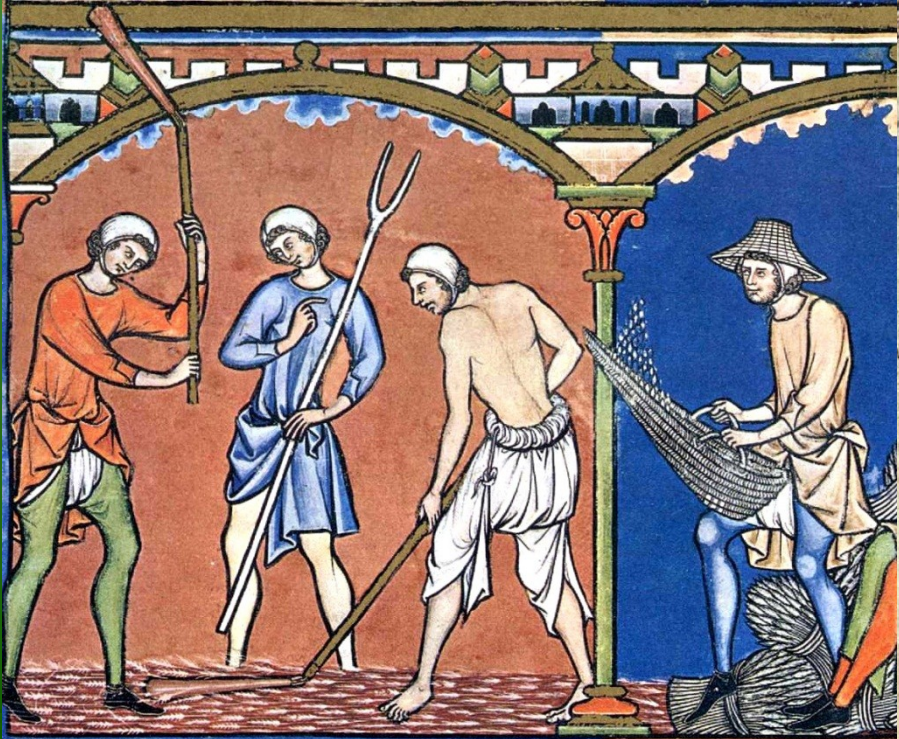

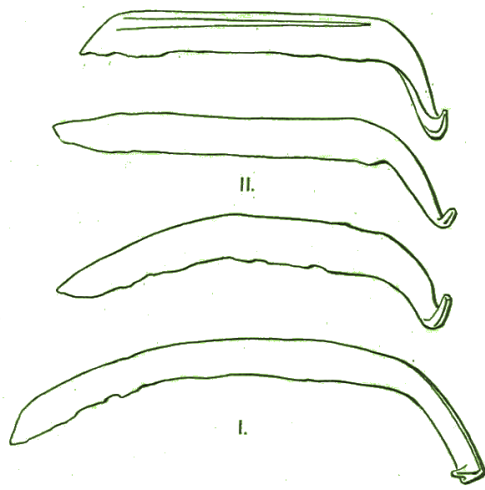

hrábě



lopata



vesnický dům

- zahloubený
 - zemnice
 - polozemnice
- nadzemní
 - roubený
 - kůlový

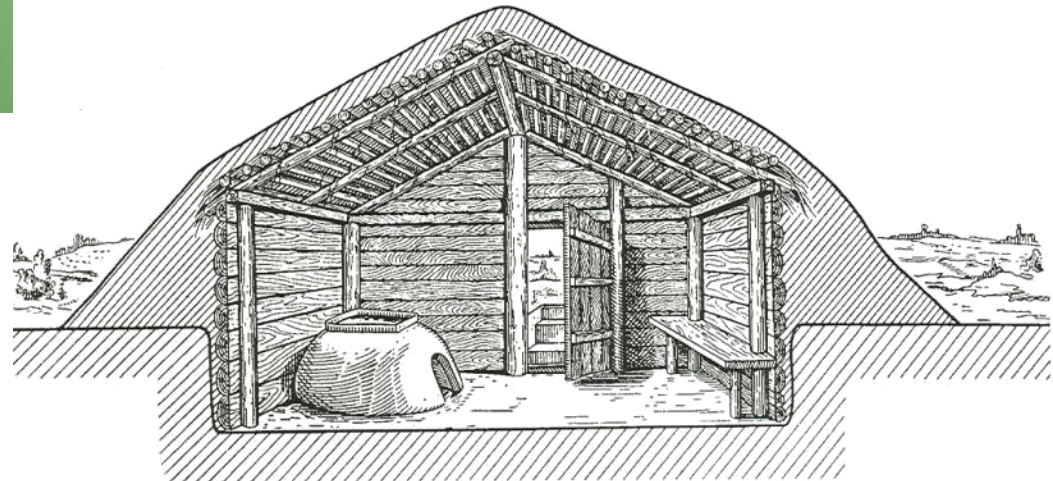
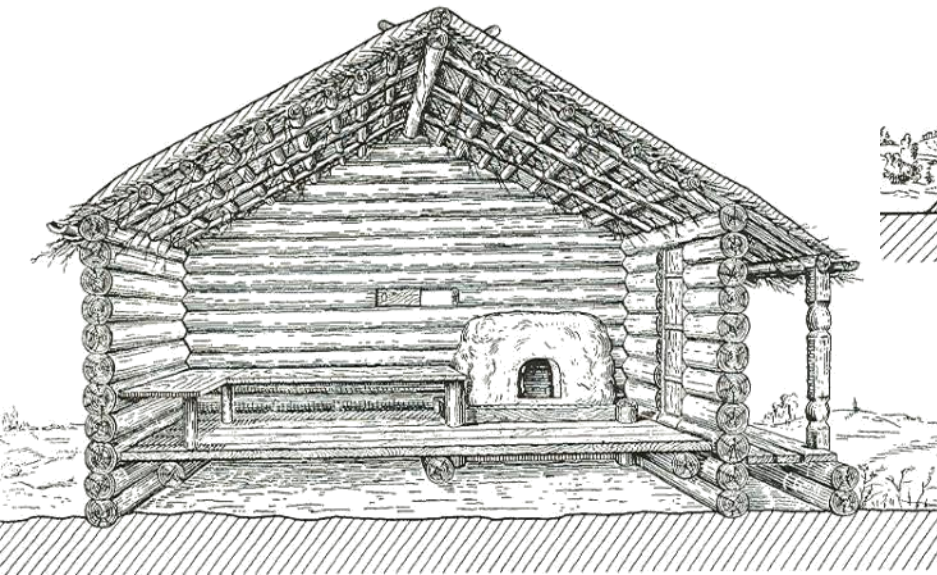

trojdílný dům

- jizba (světnice)
- síň
- komora (špýchar) nebo chlév

- vstup ve štítové stěně jizby (A)
- vstup v okapové stěně jizby (B)

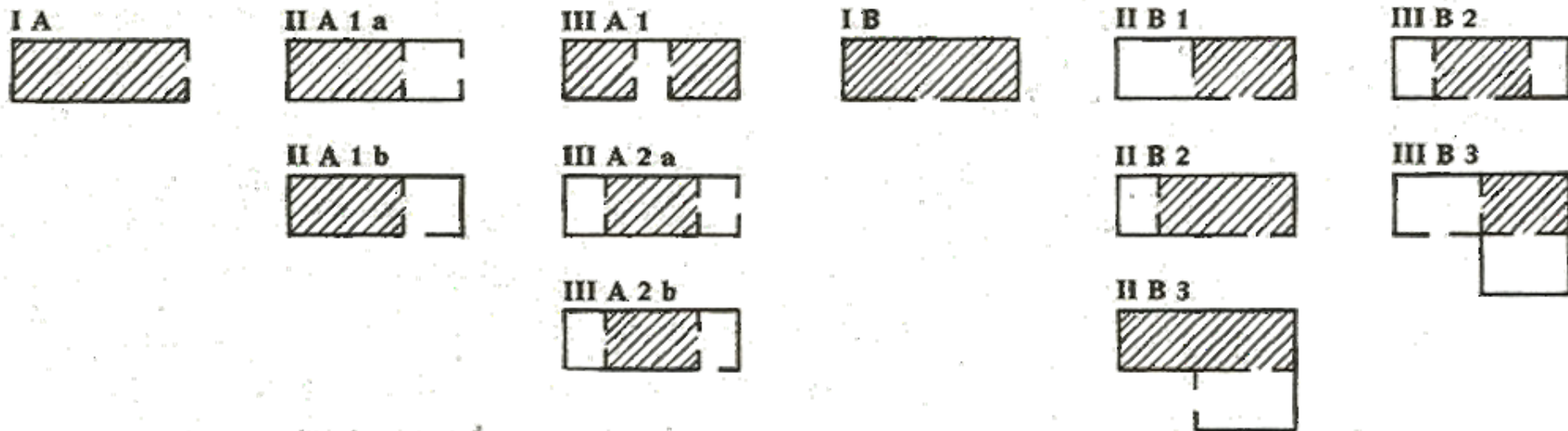

I-III JEDNOTLIVÁ VÝVOJOVÁ STADIA

■ VYTÁPĚNÁ MÍSTNOST

dům komorový

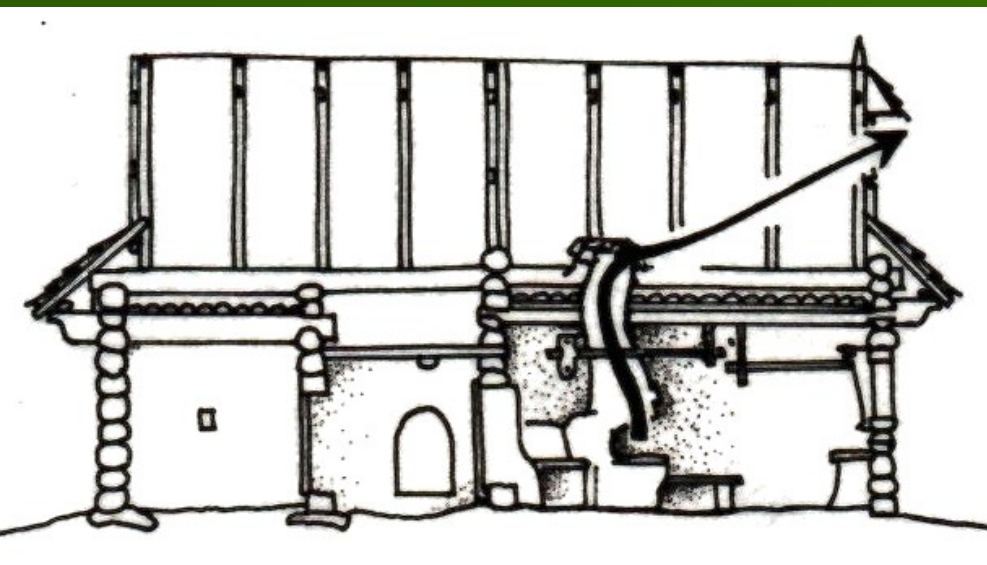

dům špýcharový

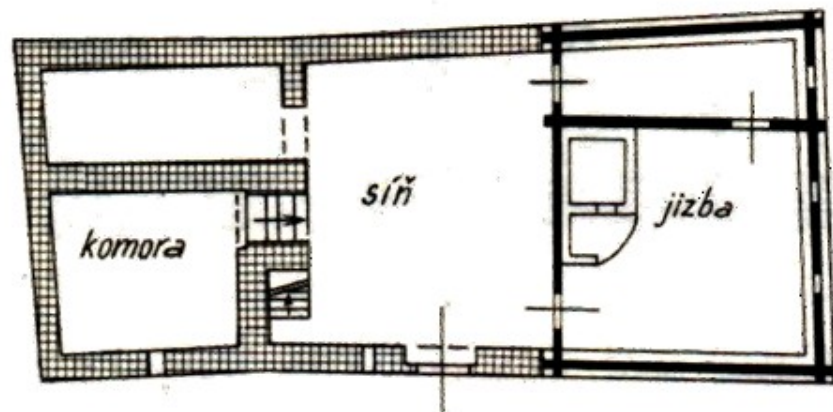
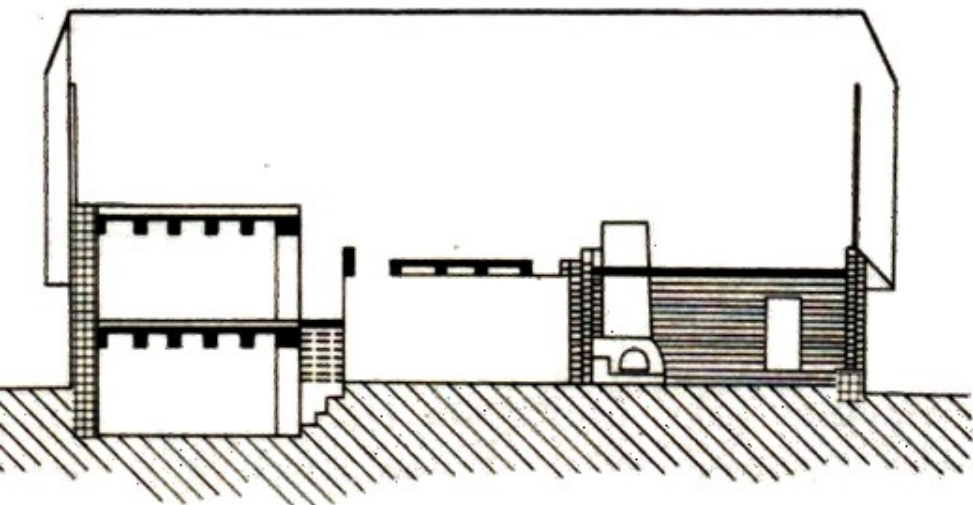
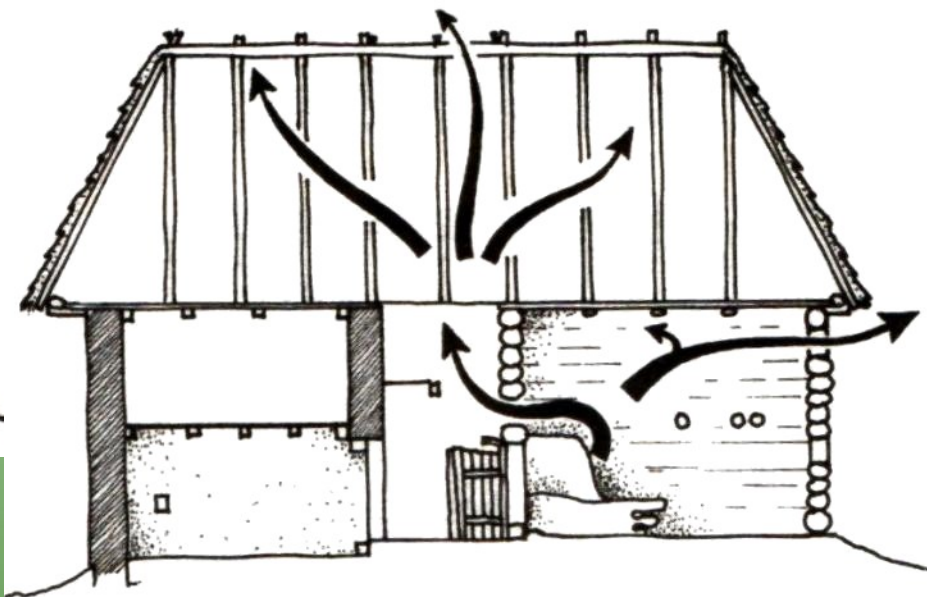

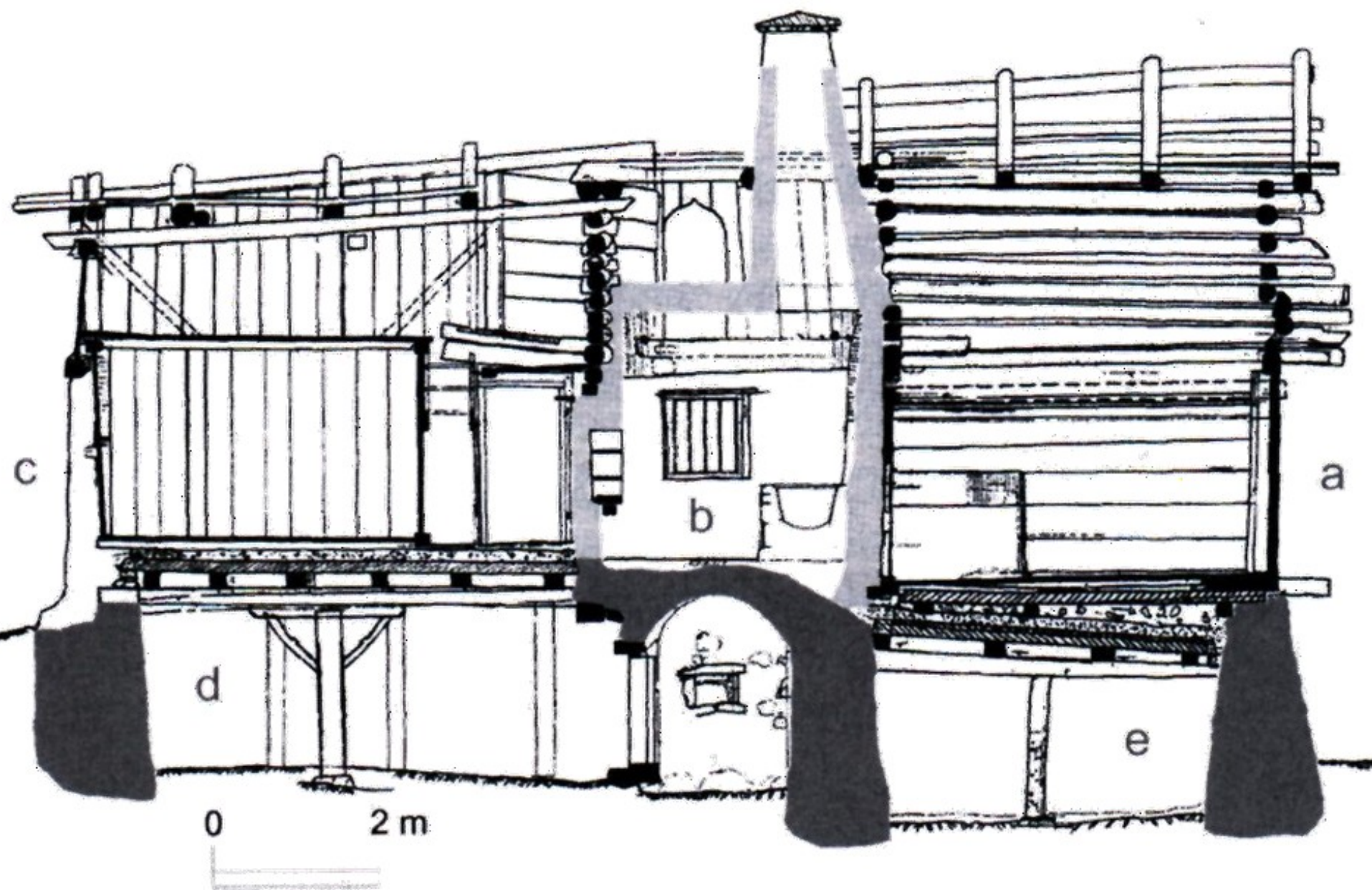



2

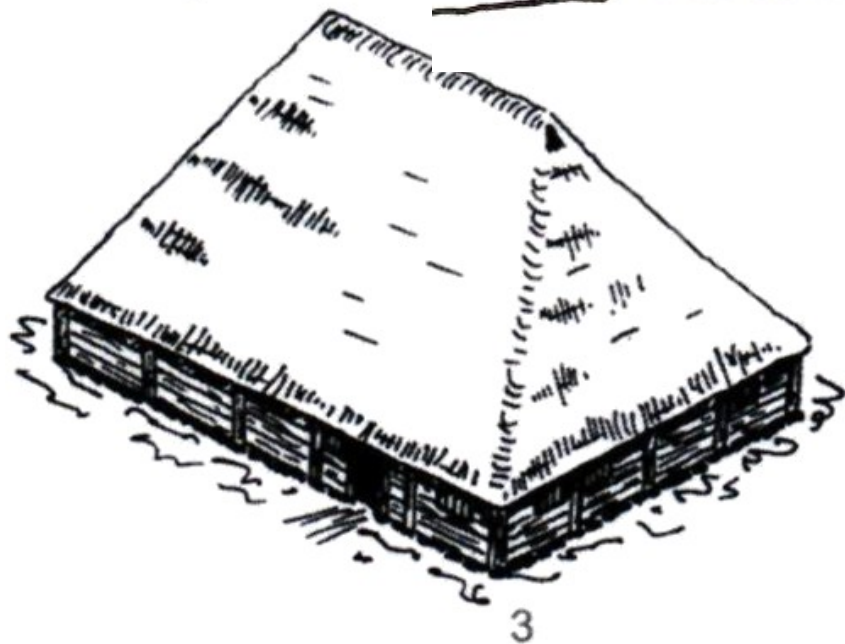
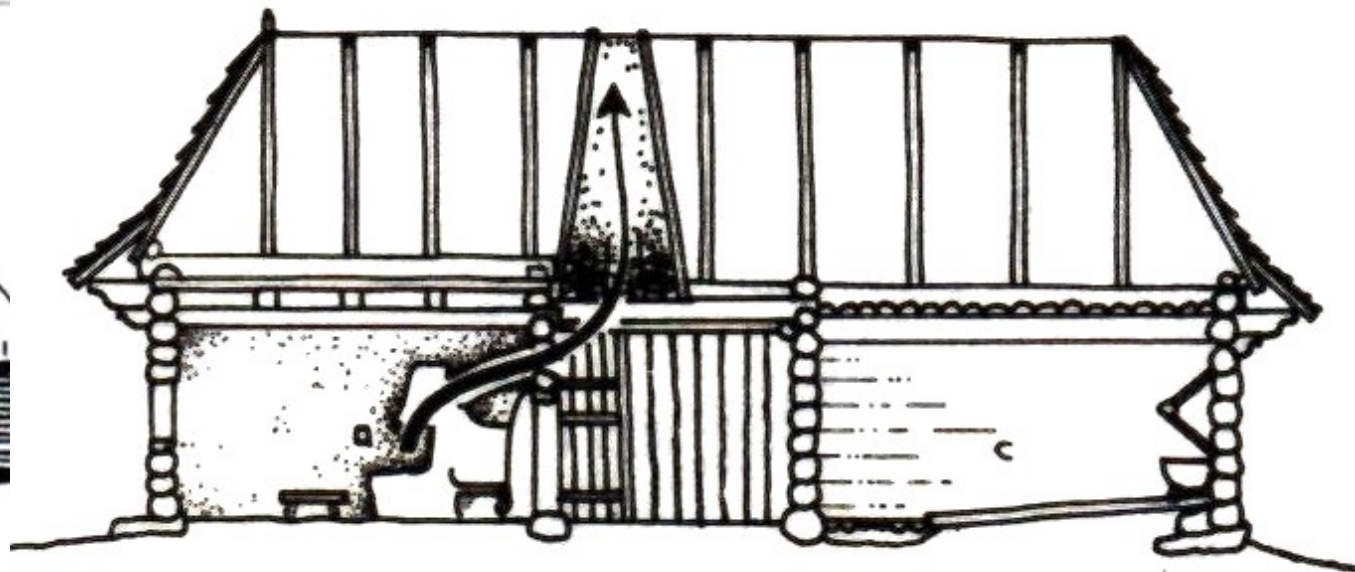

3

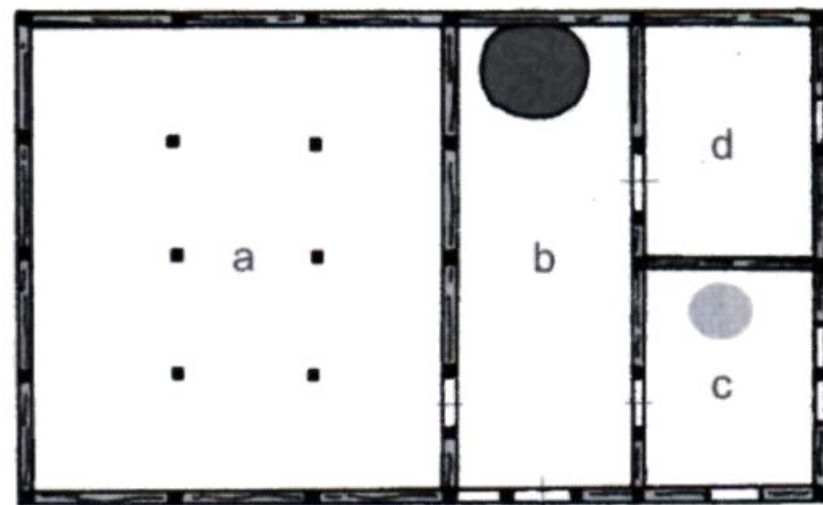

1

0

5 m



dům chlěvní

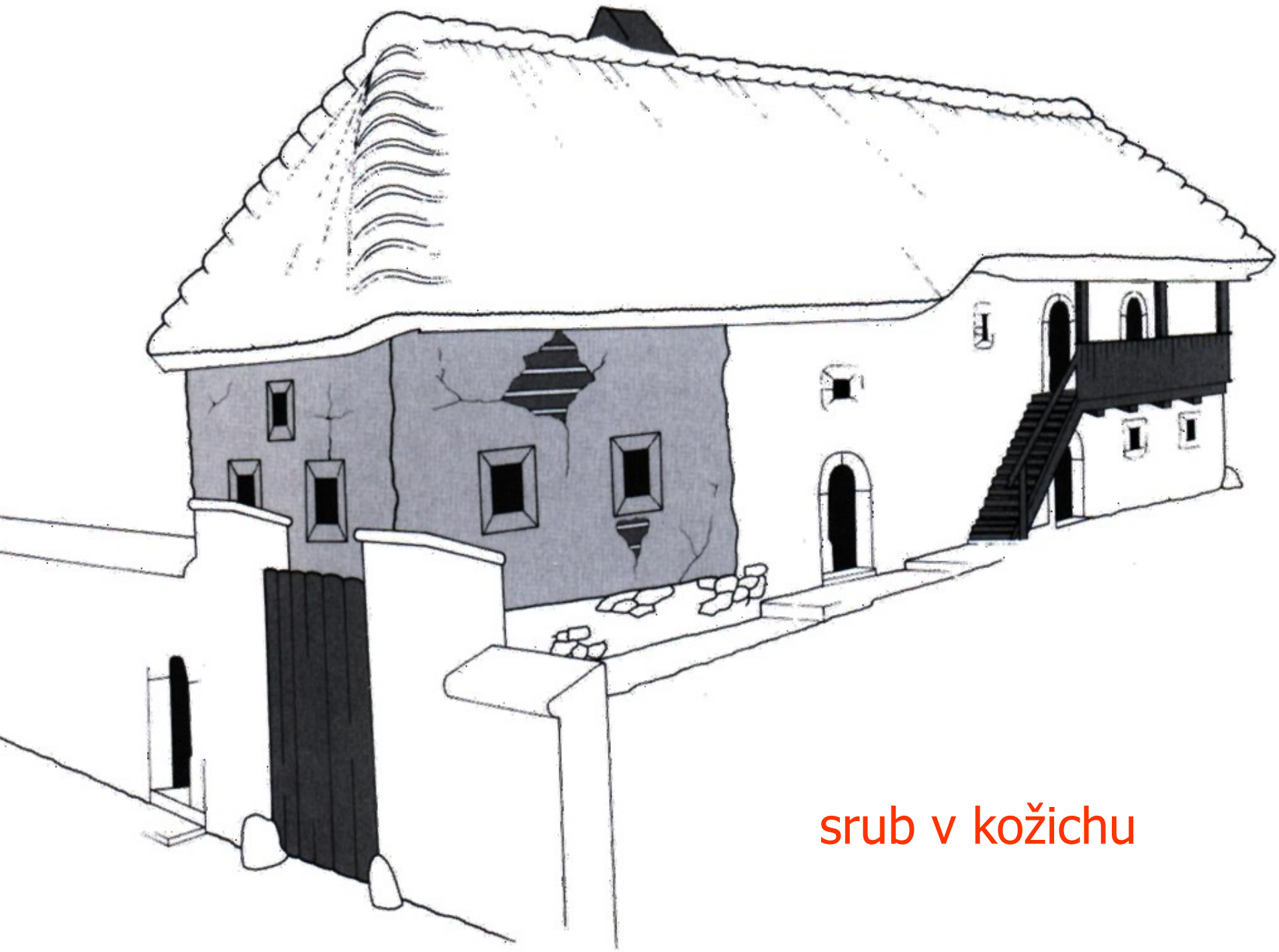

srub v kožichu



otevřené ohniště

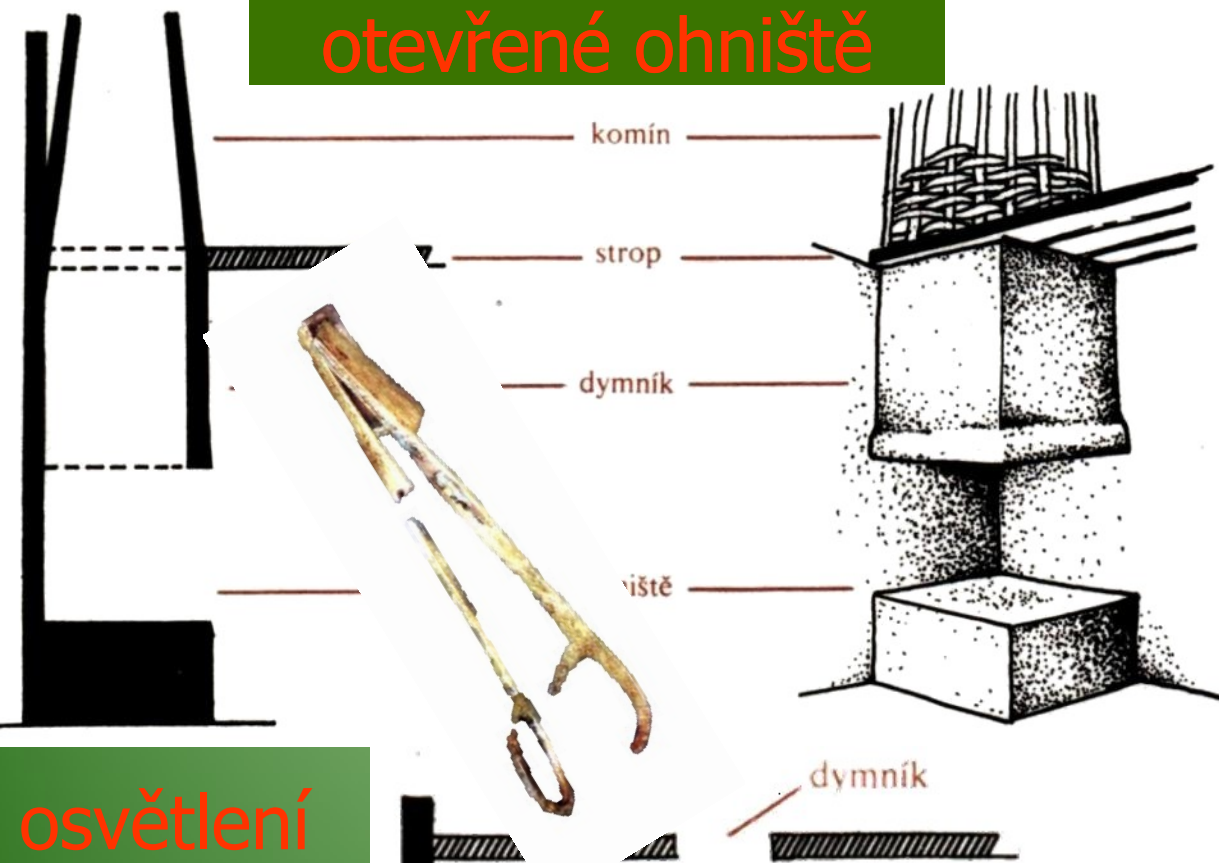

oheň

- křesadlo (ocílka)
- křesací kámen
- troud (hubka)
- sirný knot

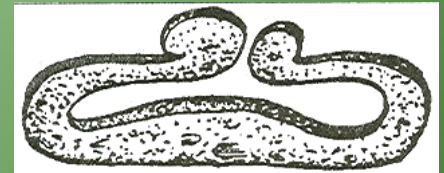

osvětlení

- louč
- svíce
- kratiknot

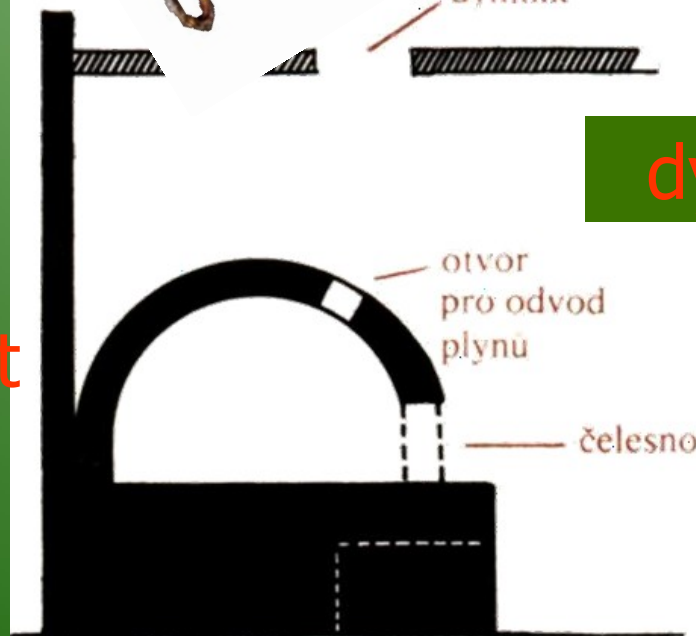

dýmná pec

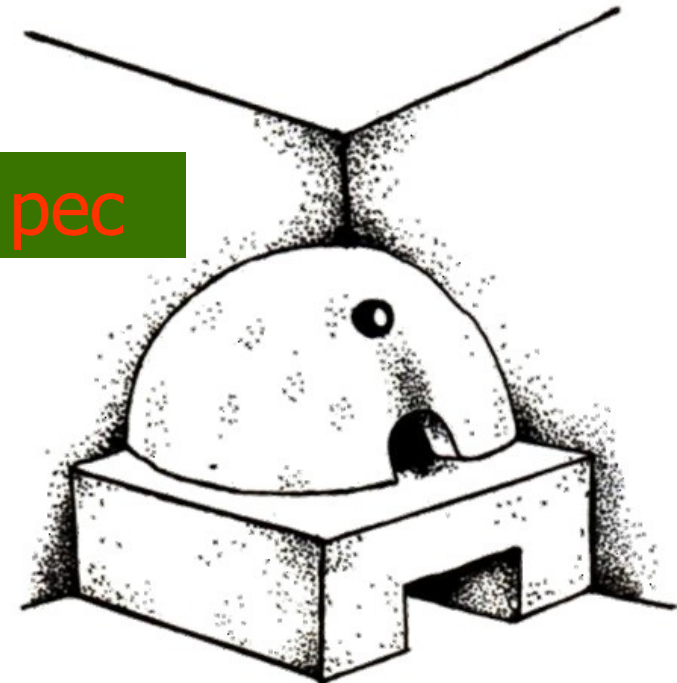

hřebenová vaznice

sedlová střecha

**došky – žitná sláma,
rákos**

kleštiny

krokve

socha

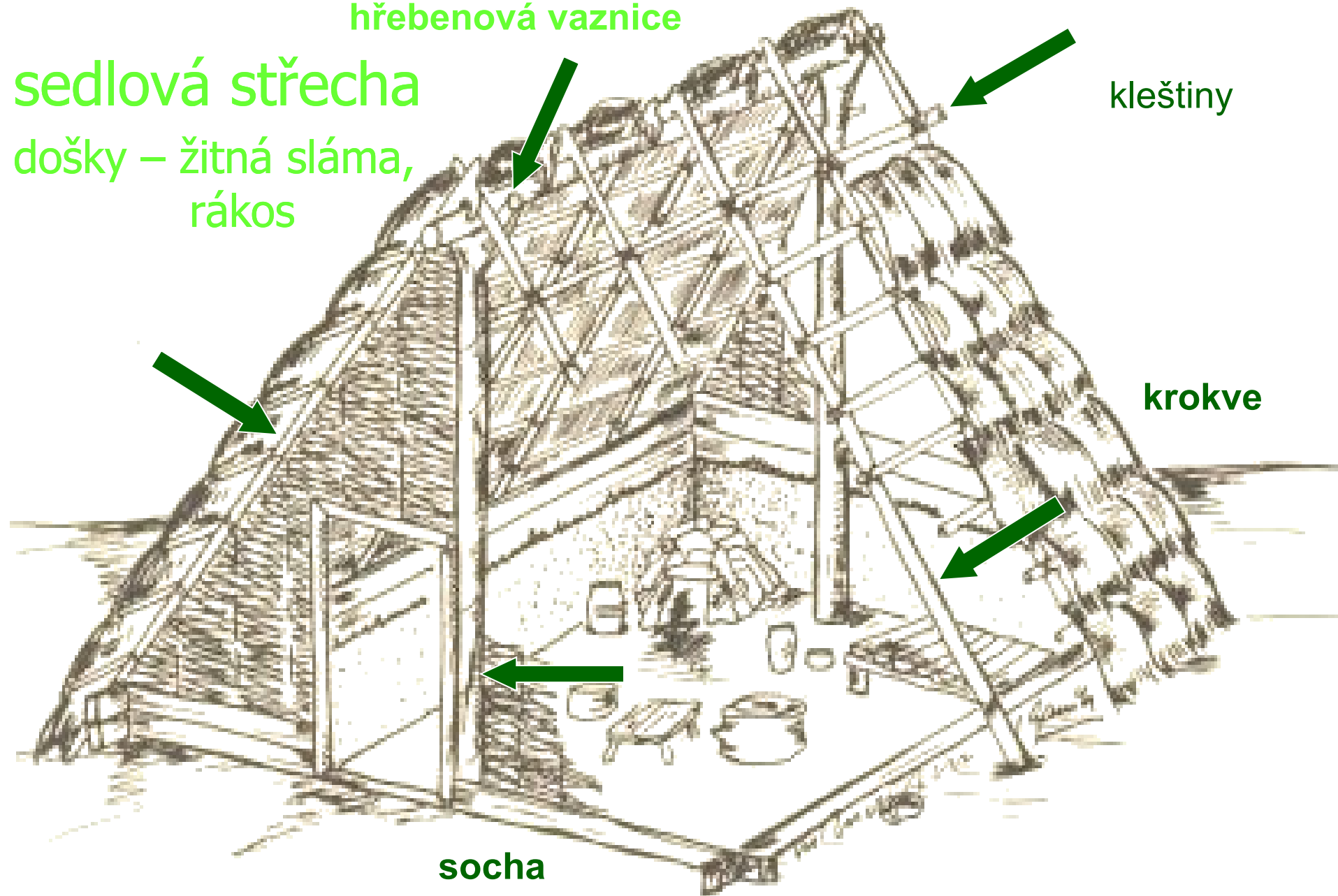

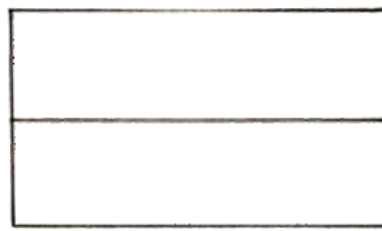
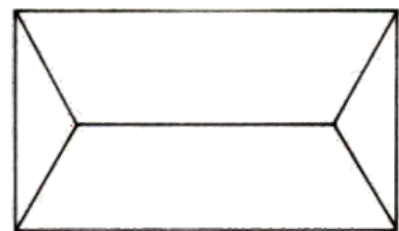
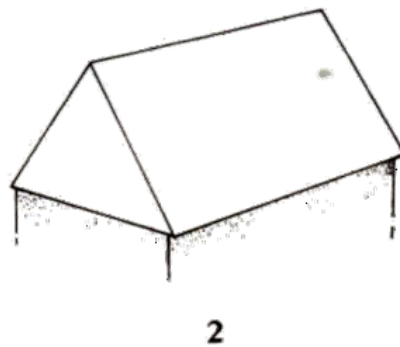
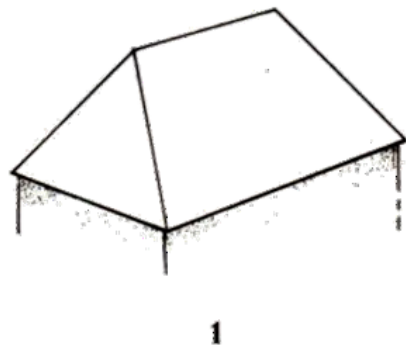
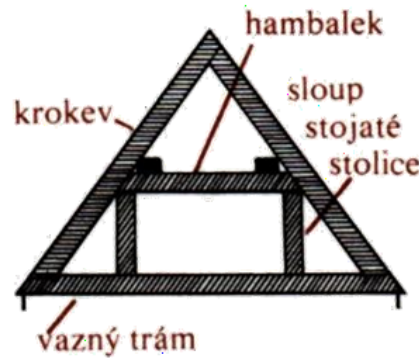
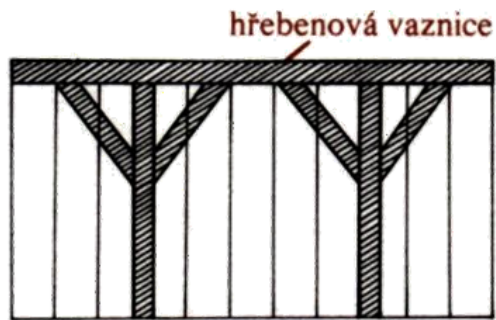
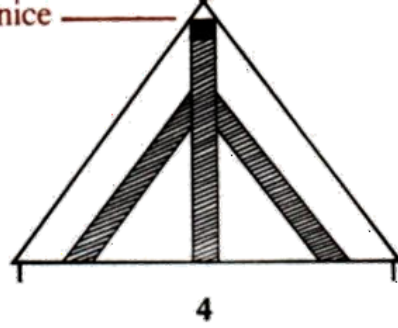
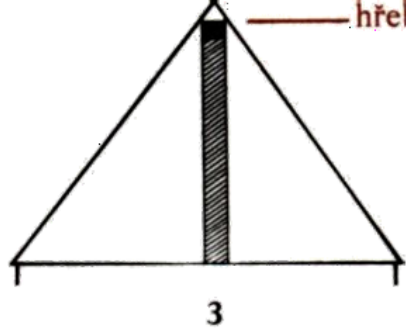

střecha

- vazný trám
- krokev
- hřebenová vaznice
- hambalek

1. valbová
2. sedlová
3. pultová

hospodářské stavby

- obilní jámy (zásobnice)
- sýpky
- stodoly
- kůlny
- chlévny
- sklepy
- studny
- pece

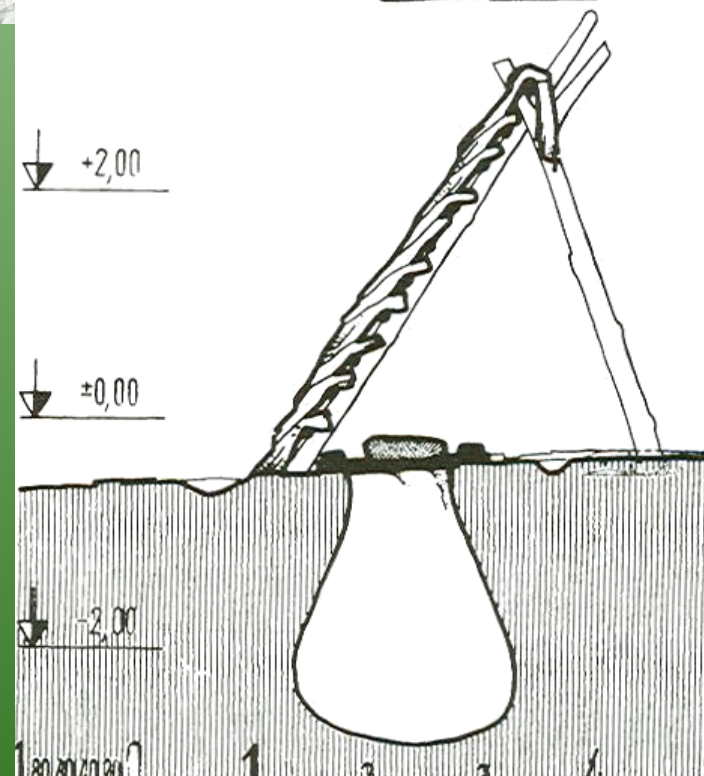
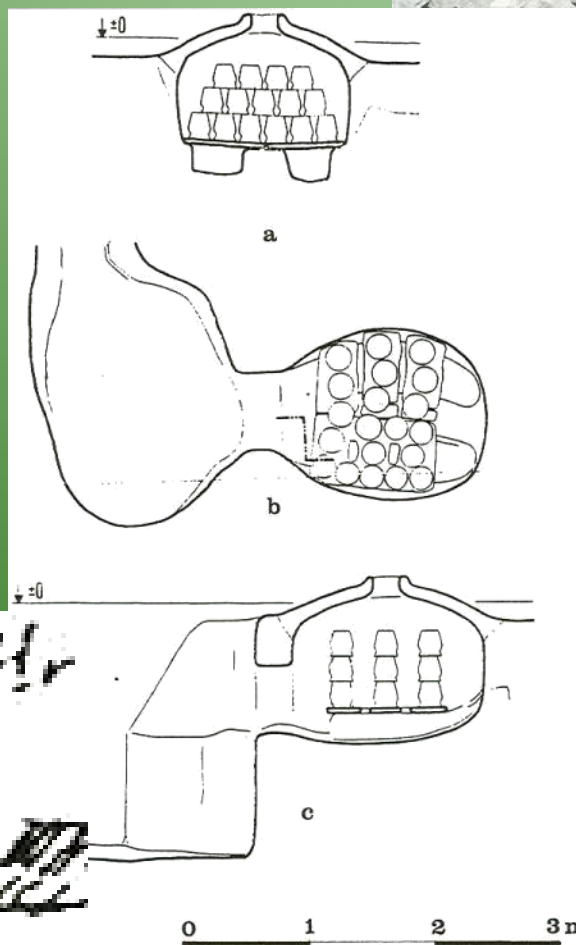
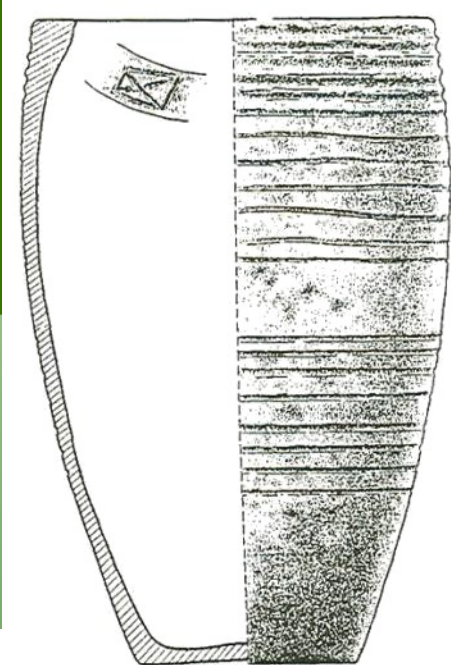
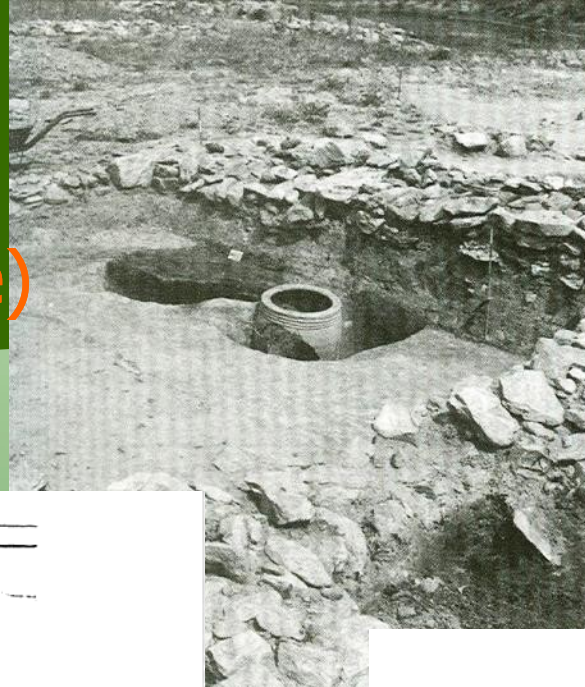

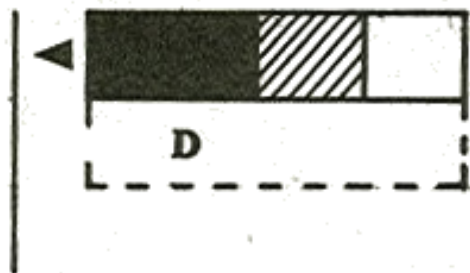

USEDLOST
JEDNOTRAKTOVÁ -
RADOVÁ

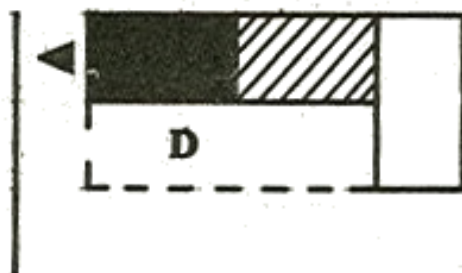

USEDLOST
DVOUSTRANNÁ
(HÁKOVÁ)

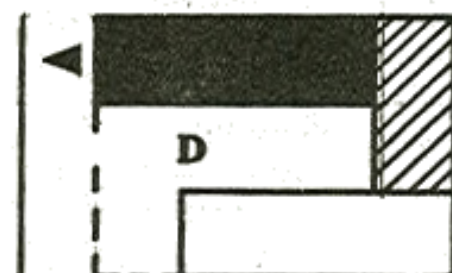

USEDLOST
TROJSTRANNÁ
(PODKOVOVITÁ)

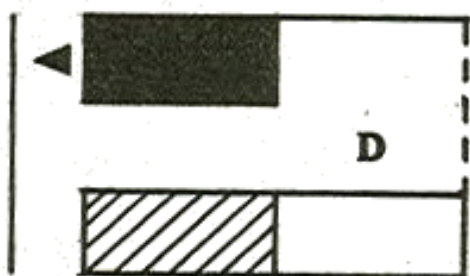

USEDLOST
PÁROVA

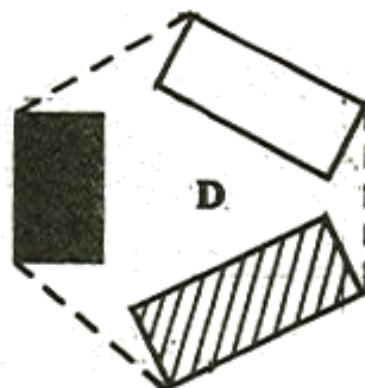

USEDLOST
ROZPTÝLENÁ
(HROMADNÁ)

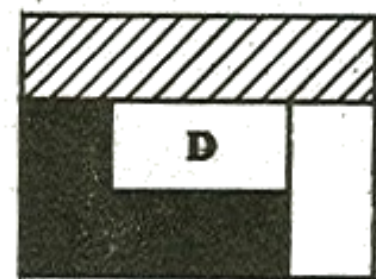

USEDLOST
ČTYŘSTRANNÁ

 OBYTNÉ STAVENÍ

 CHLÉV

 STODOLA (KÚLNA)

D
DVŮR

ŠIPKOU VYZNAČENA ORIENTACE
(KE KOMUNIKACI NEBO K NÁVSI)

usedlost



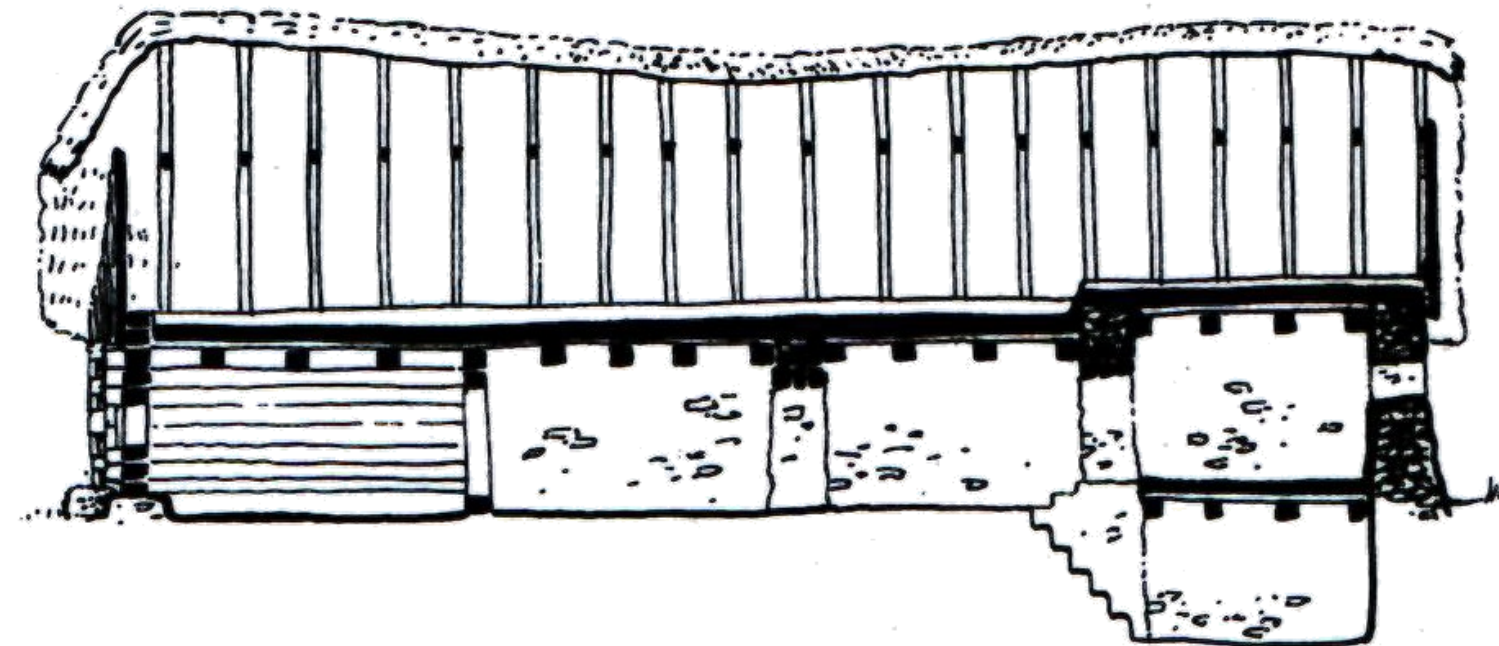
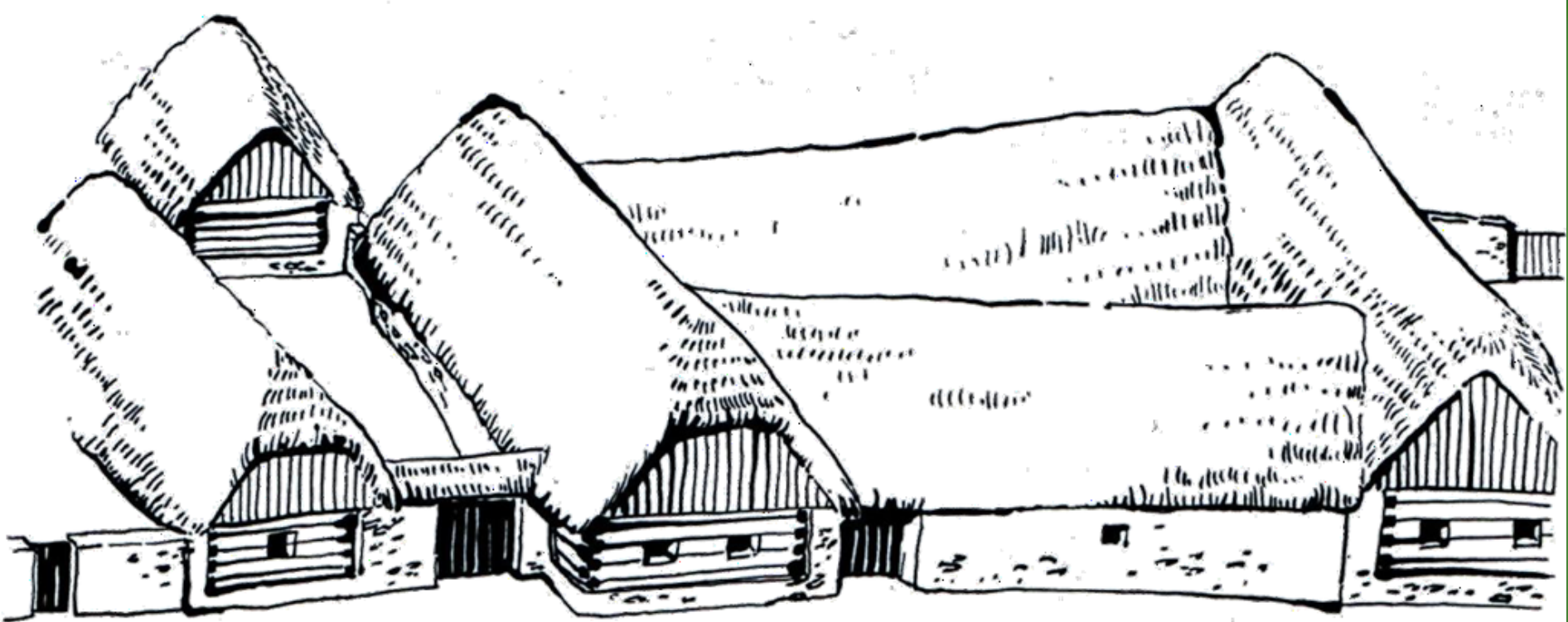

usedlost

kovárna

- kovadlina
- výheň
- měch
- kladivo
- kleště





stoupa

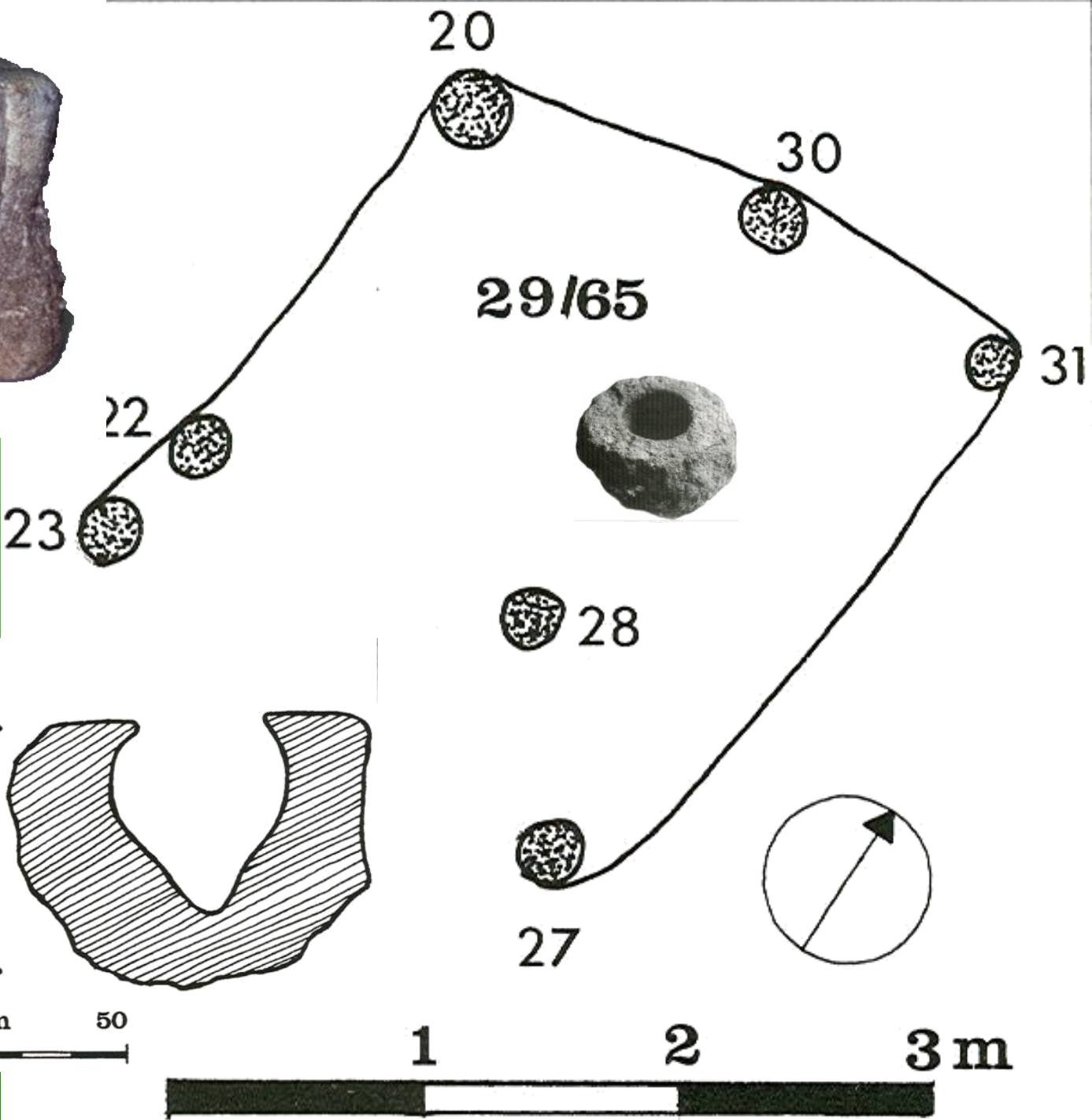
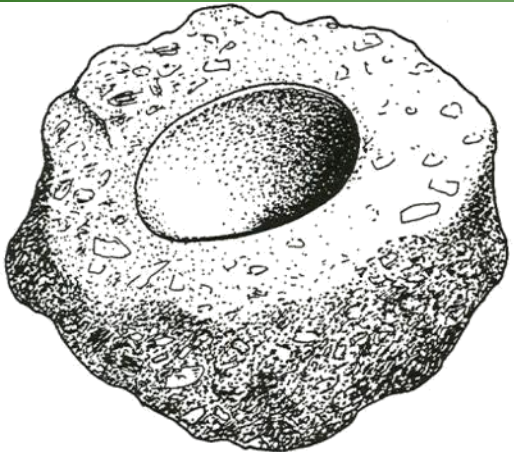

0 cm 50

1 2 3 m

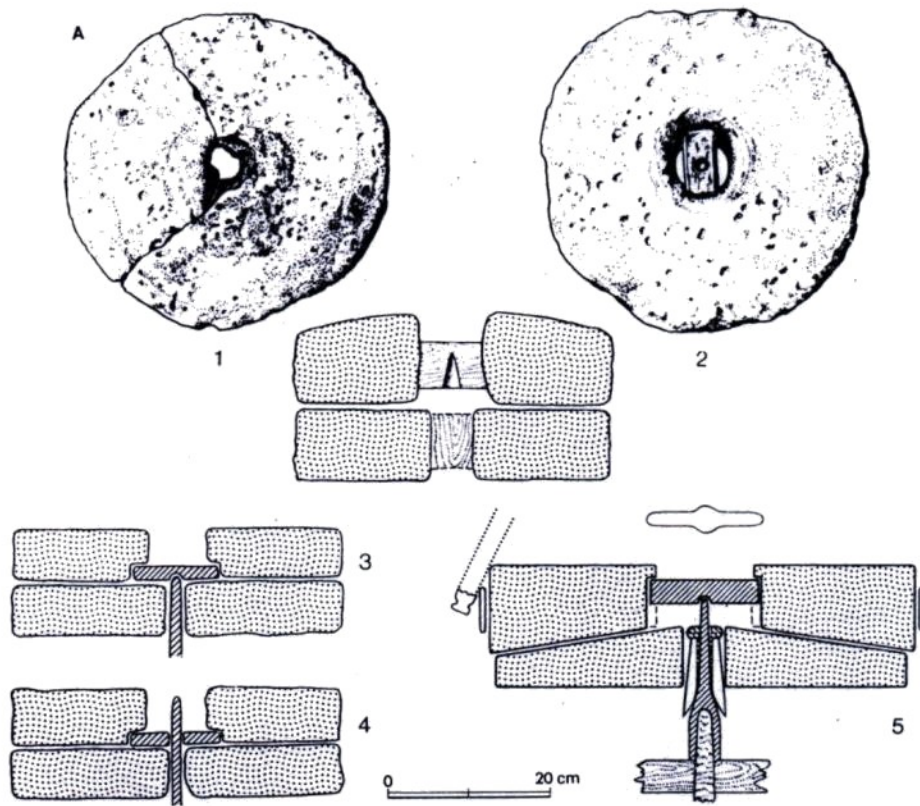

ruční rotační mlýn

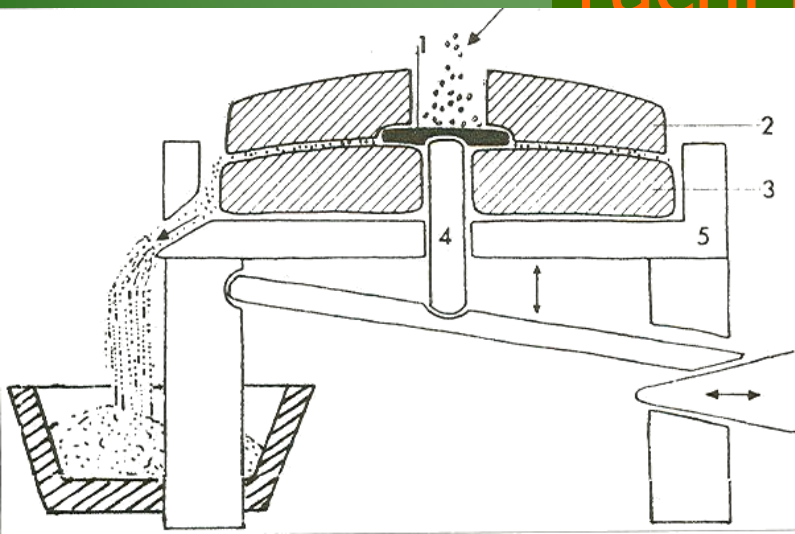

vodní mlýn

- na spodní vodu (lopatkový)
- na svrchní vodu



nasýpací koš

běhoun

spodní kámen

paleční převod

paleční kolo

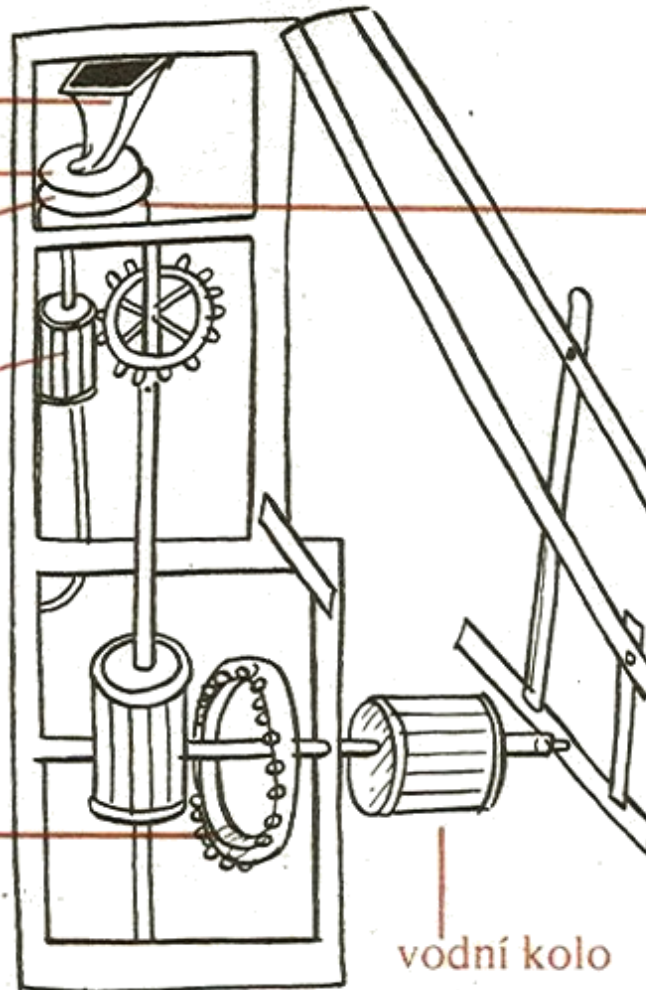

mlýnská stolice

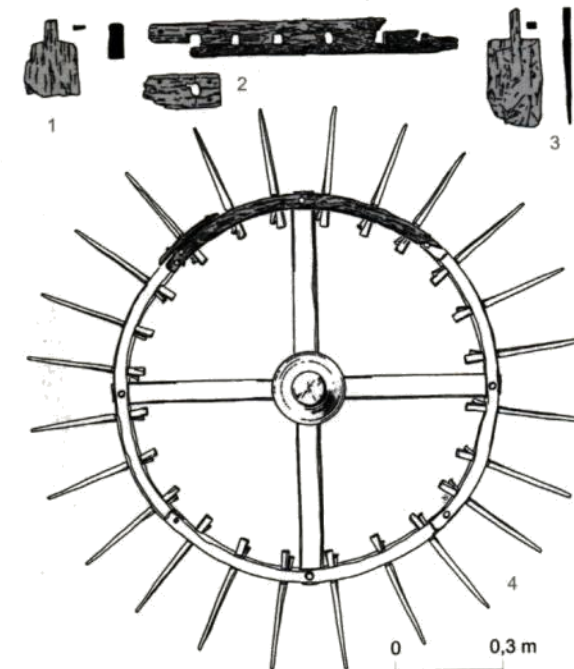

Conrad Kyeser: Belfortis, kolem 1440

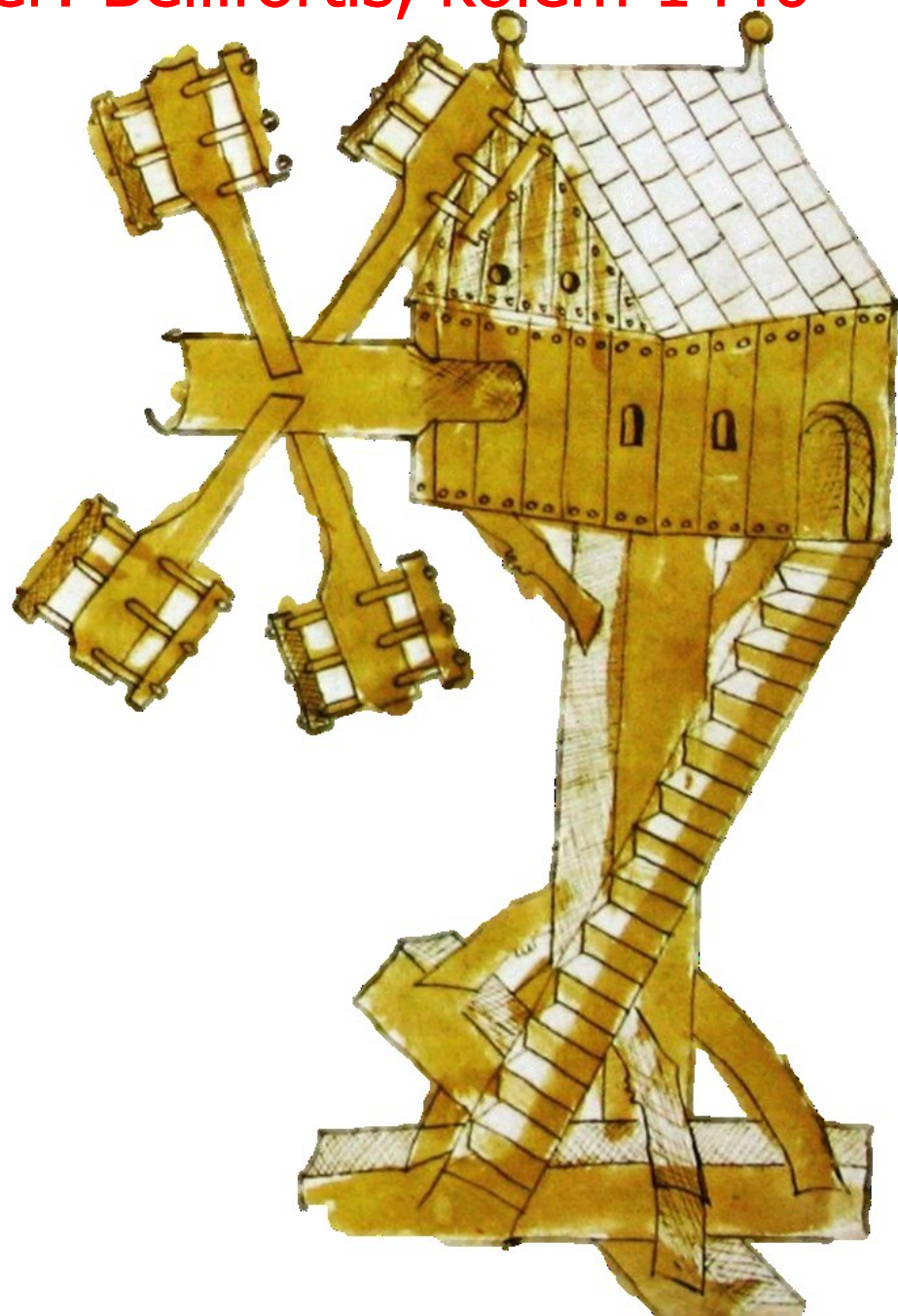
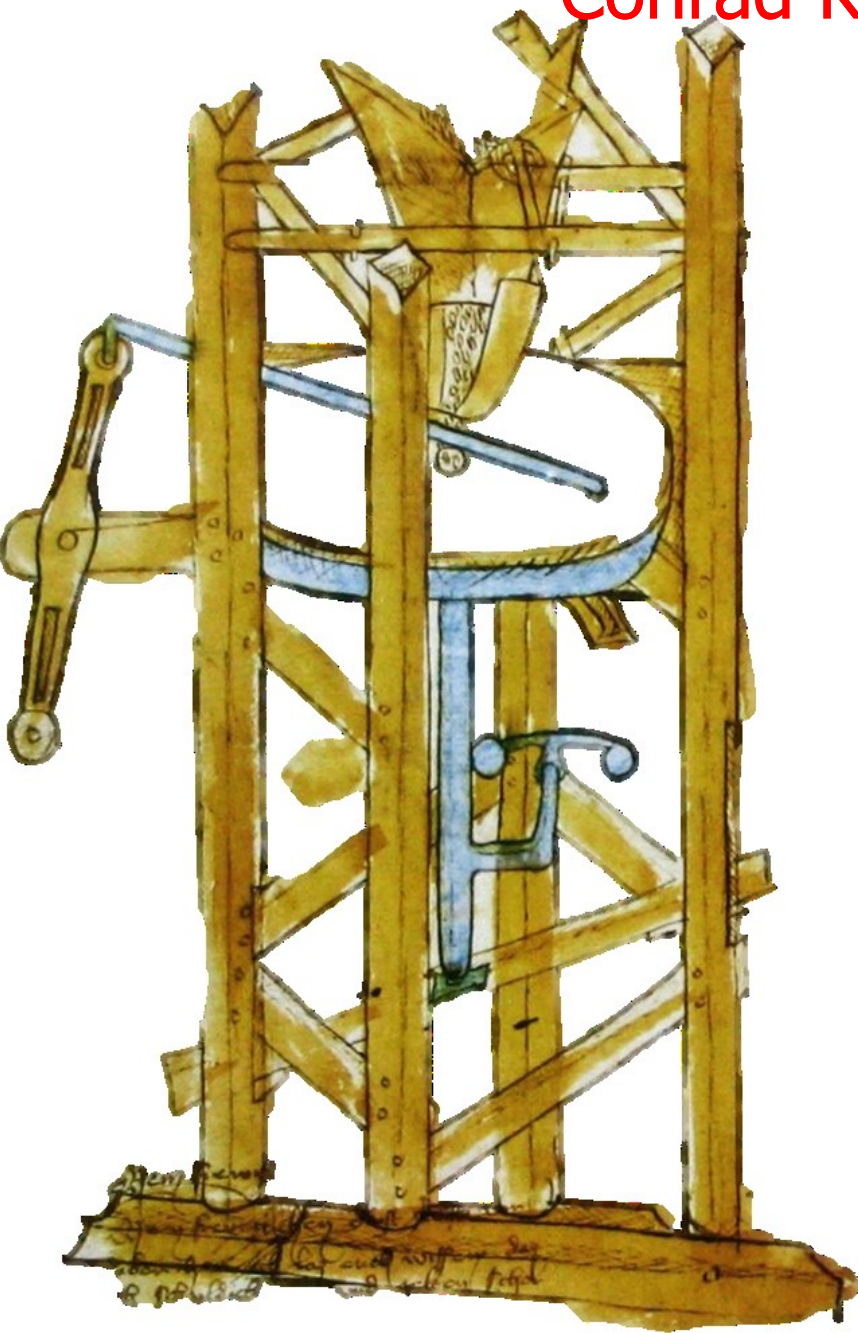

větrný mlýn

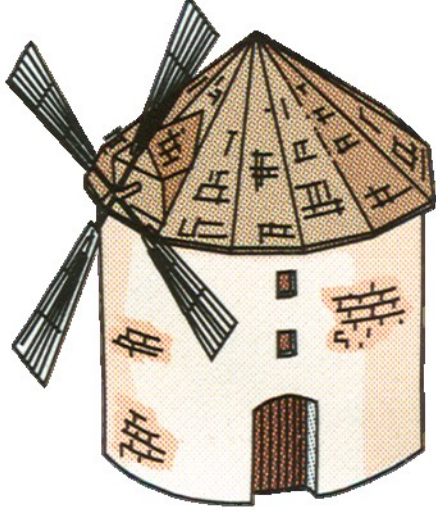
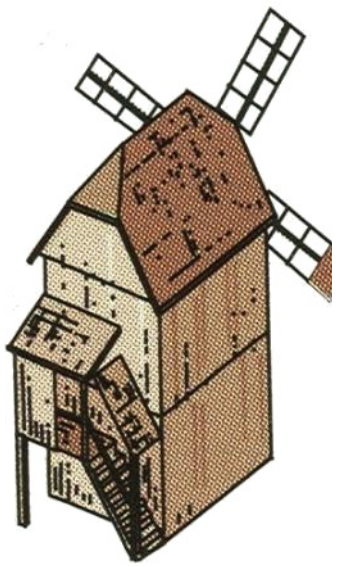

křídla (lopaty)

hřídel

lub (kryt mlýnských kamenů)

kláda k natáčení mlýna

kříž z trámů

paleční kolo

céví (kladnice)

násypka na obilí

apoštolé

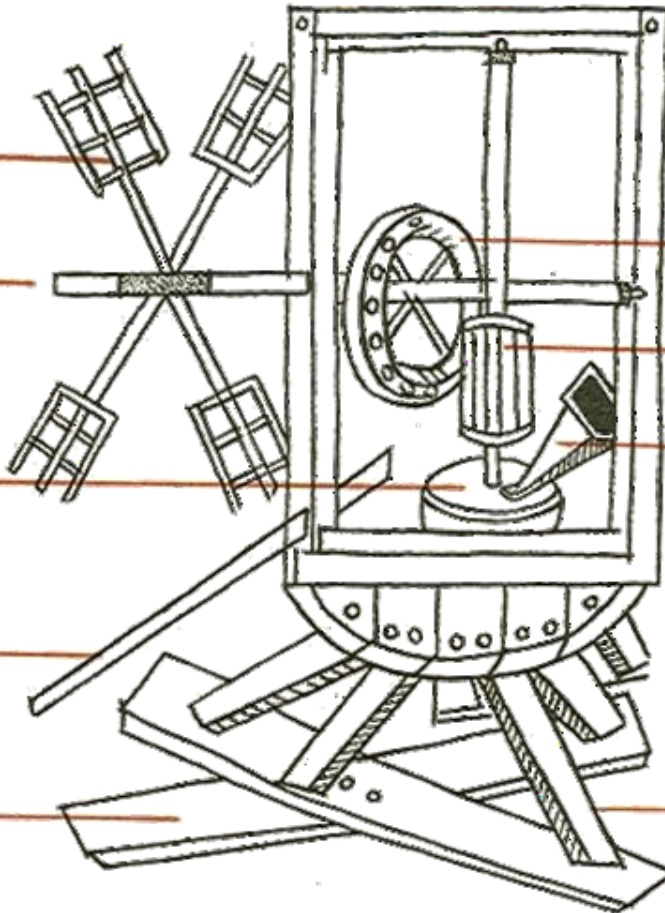



kalendáře – polní práce

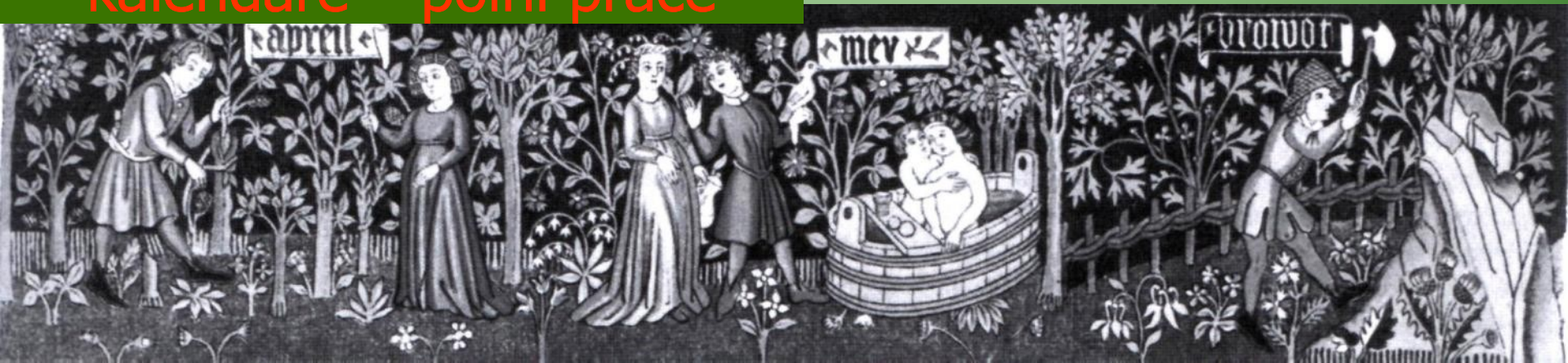





sadařství

vinařství



vinařský nůž



vinařský lis





motyky



ryc

drůbež





chov ovčí





šérové nůžky





hnojné vidle



chov vepřů

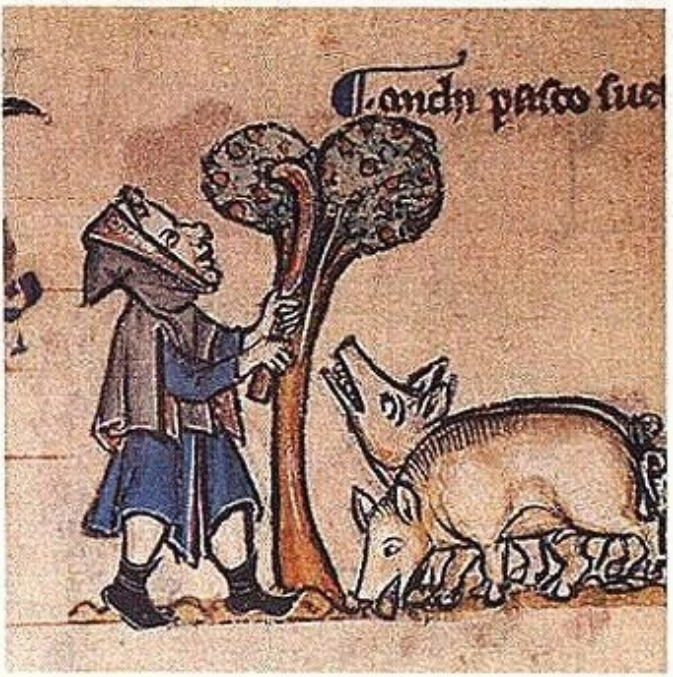

včelařství

brtr

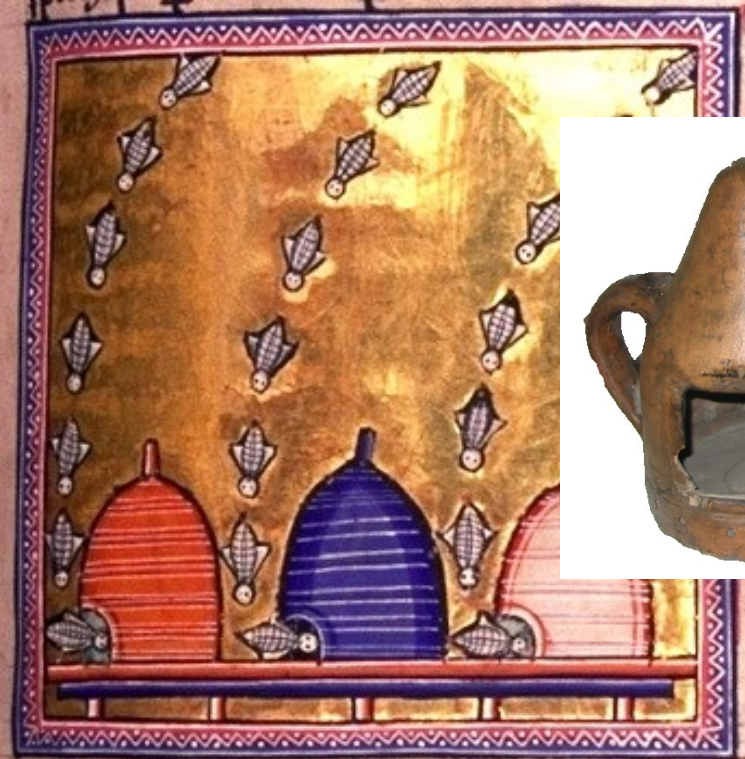
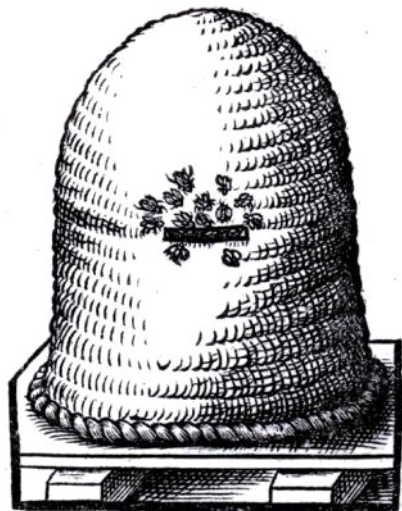

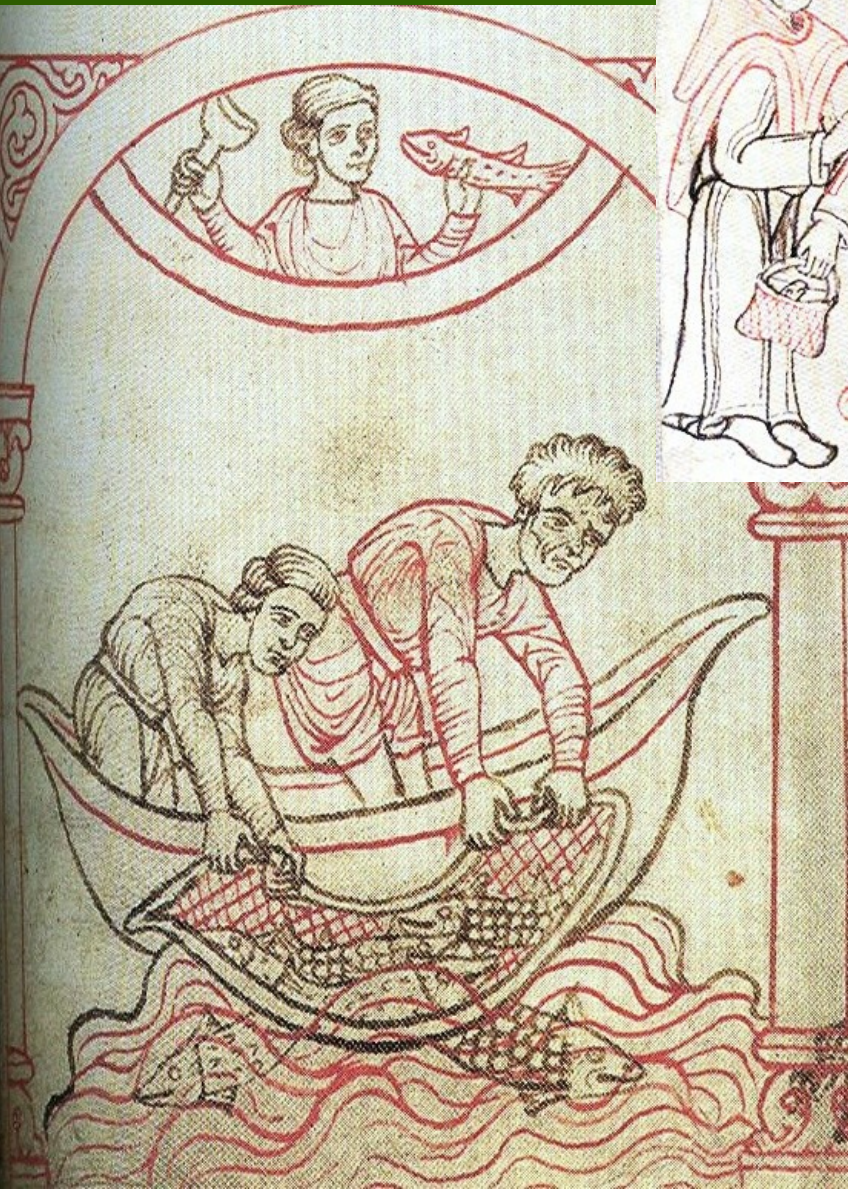

rybolov

- síť
- vrše
- udice

zásobování dřevem

- lesy
- odlesňování
 - zemědělská půda
 - těžba rud
 - dřevěné uhlí
 - palivové dříví
 - stavební dřevo
- porosty
 - smrk
 - jedle, buk
 - jedle, dub, borovice
 - dub, habr, topol, jilm, jasan



magie, pověry

hromový
kámen

