

# Hmotná kultura a každodenní život III

hornictví, hutnictví, mincování  
železářství

# literatura

- Agricola, G. 1976: Dvanáct knih o hornictví a hutnictví. Bibliografie a prameny. Praha.
- Dějiny hmotné kultury I (2), 1985. Praha.
- Hrubý, P. 2014: Od hertovního stříbra až téměř k minci neboli od hutí až téměř k mincovnám, *Archaeologia historica* 39, 310–339.
- Krajíc, R. 2003: Sezimovo Ústí. Archeologie středověkého poddanského města 3. Kovárna v Sezimově Ústí a analýza výrobků ze železa. Díl I., II. Praha.
- Merta, J. 2011: Historie využití kovových materiálů. In: *Konzervování a restaurování kovů. Ochrana předmětů kulturního dědictví z kovů a jejich slitin*, 322–356. Brno.
- Nový, L. a autorský kolektiv, 1974: Dějiny techniky v Československu do konce 18. století. Praha.
- Studničková, M. – Purš, I. 2010: *Iluminace*. Kutná Hora.





šachtová  
stavbě, sha  
rudy, pec

měděná huť



tavba v otevřené nístěji

– Krupka, Loketsko, Slavkovský les, Krušné hory

• měď

– Kutná Hora, Krušné Hory, Kraslice, Hora sv

• železo

šachtové pece s předpecími



rýžování



# horní města

- přímo v těžebním prostoru
- poblíž hornických osad
- vzdálená od těžebního prostoru

- horní regál

- úřady/profese

- nejvyšší mincmistr
- horní hofmistr
- urburéř
- perkmistr
- písař urbury
- kverk
- hutman
- havíř
- hašplíř

Kutnohorský graduál, asi 1490





# důlní díla

- šachty úklonné
- šachty svislé
- štoly hledací
- štoly dědičné
- větrací věže

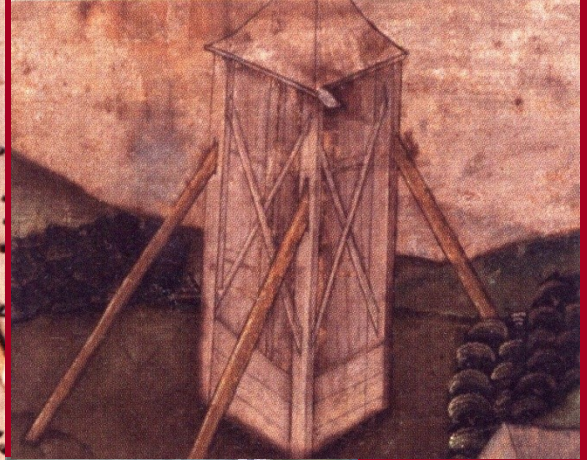



ražba  
želízkováním  
sázením ohněm





# hornické šlígle



herlík (pucka)



mlátek

želízko

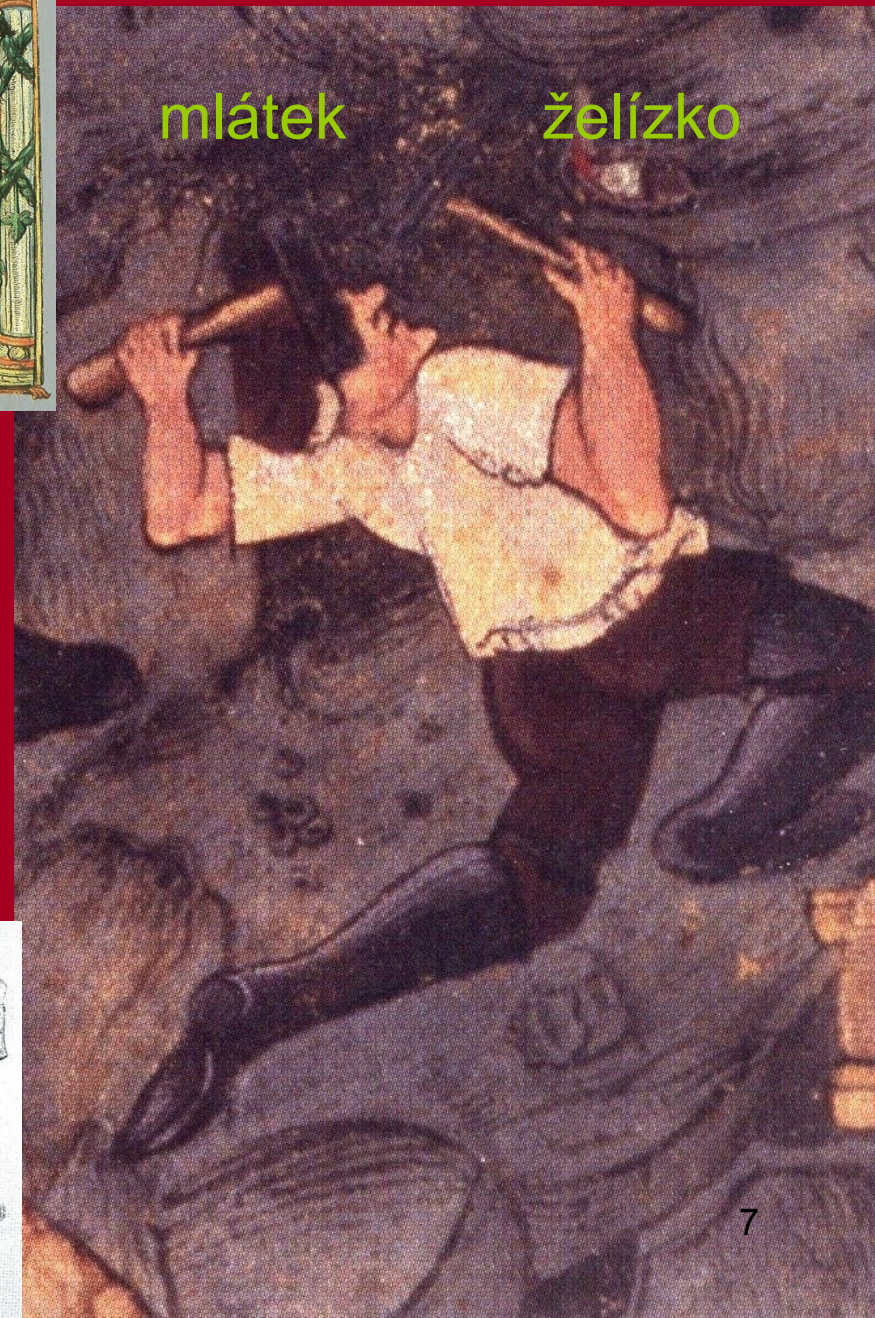



# hornické nástroje

krace

4

důlní želízka

5

2

špičák

1





perkytle







žebříky

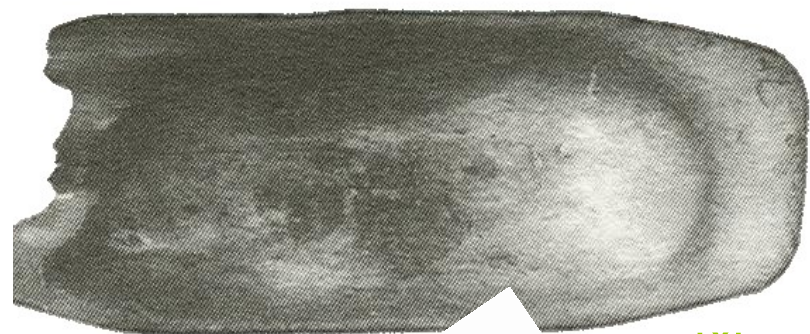

necičky

flek



kahánek





vrátek, rumpál, hašpl





# žentour (trejv)

A – otočný svislý hřídel

B – buben k navíjení provazů

C – rameno žentouru

D – kladky

E – kožený měch na těžení vody

F – ústí šachty

G – těžní provazy

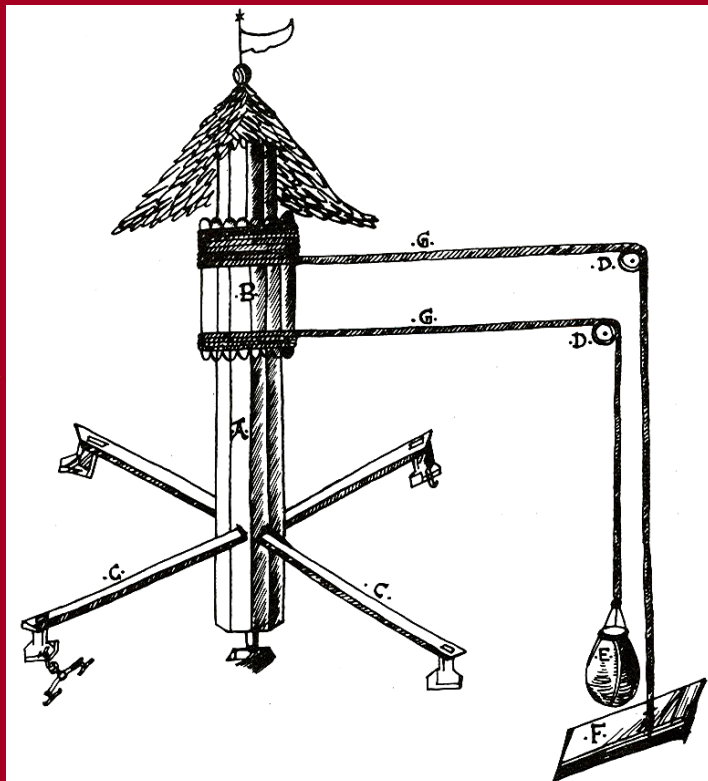



# rozdílení rudy - dražba



- drcení rubaniny
- propírání rudy
- třídění rudy
- rozdružování (oddělování rudných zrn od jaloviny)
- rudokupci
- tavba rudy



# tavení rudy

- pražení (hromady, štaďly)
- tavba (šachtové pece, olovo, dřevěné uhlí)
- hutní olovo
  - klejt (oxid olovnatý)
  - plik (vytavený bochánek stříbra)
- měchy

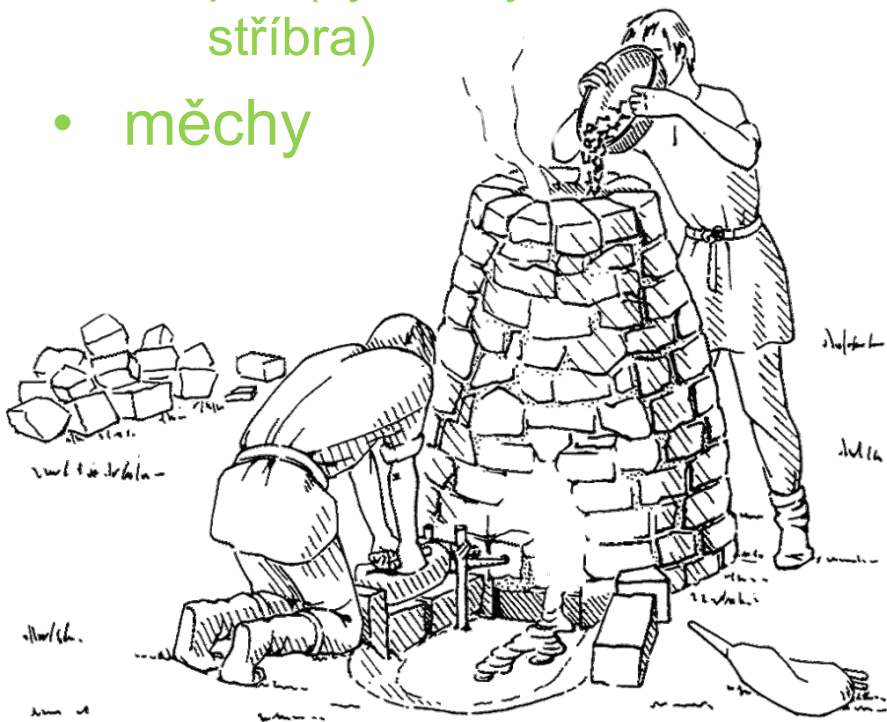



# mincovna

- příprava suroviny
- prubiřský test
- cány – pruty mincovního kovu
- mincovní střížky
- ražba

## • **lus regale montanorum**

- Václav II., 1300, pražský groš
- Kutná Hora, Vlašský dvůr, šmitny
- sjednocení 17 mincoven

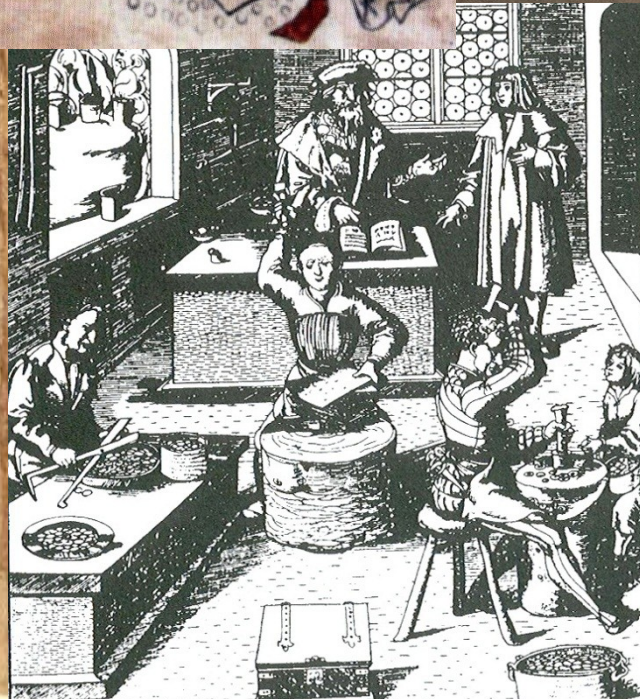





křivule



tyglíky

skřipec





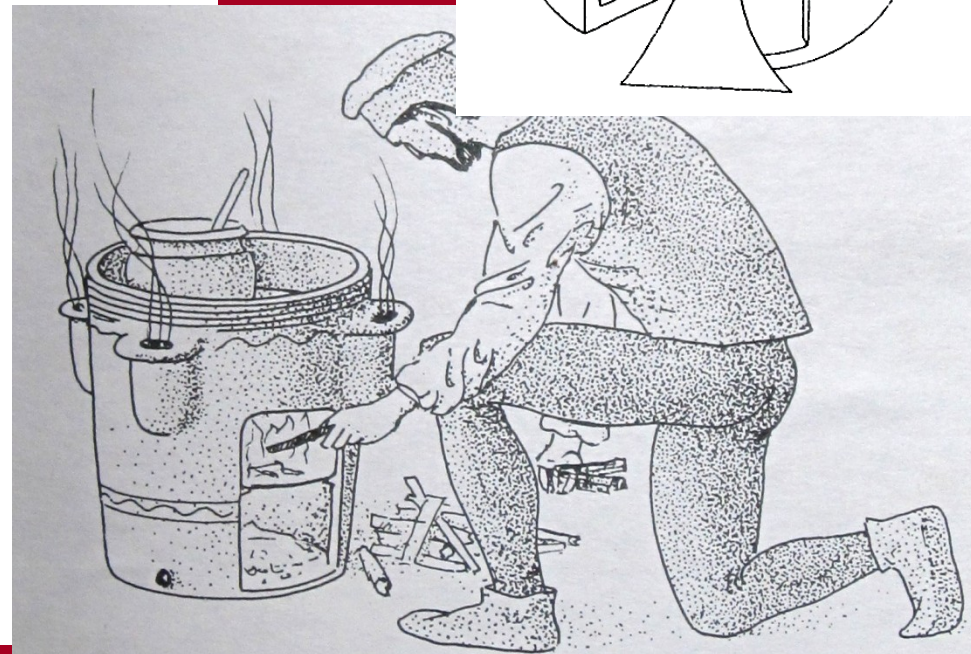
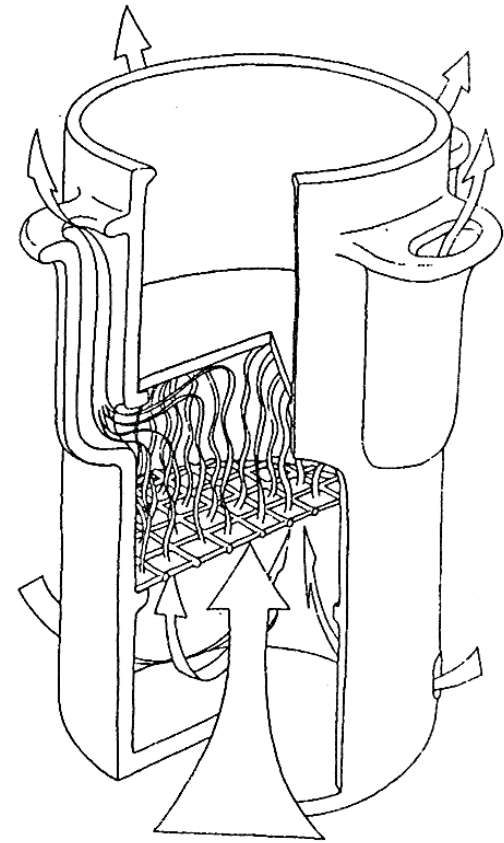



# ražba mincí

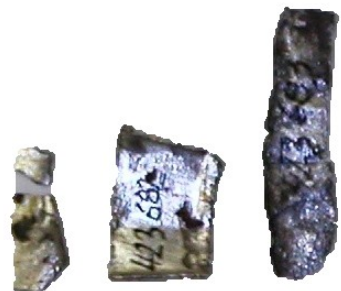

stříbrné plíšky



razidla



pokladničky





# železářská huť

- přímá tavba
- šachtová pec (kusová)
- železná houba
- hamr

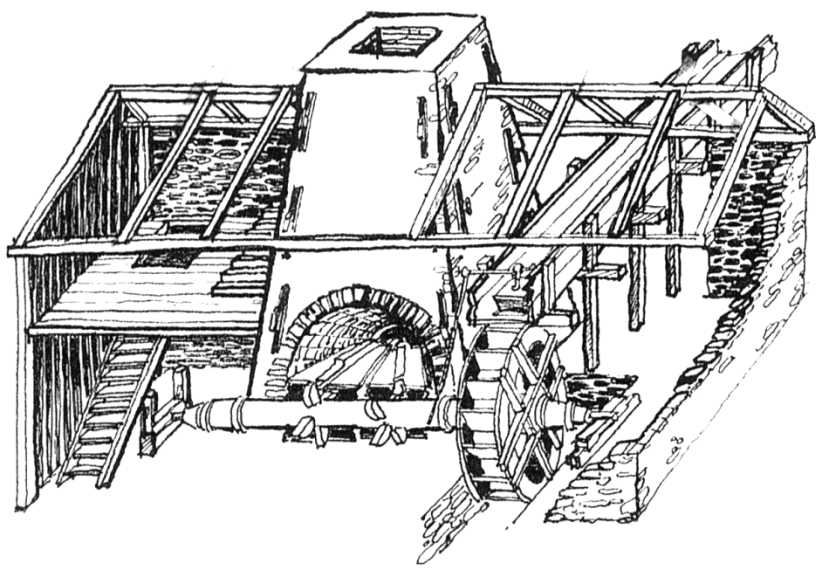



# vyhříváčka

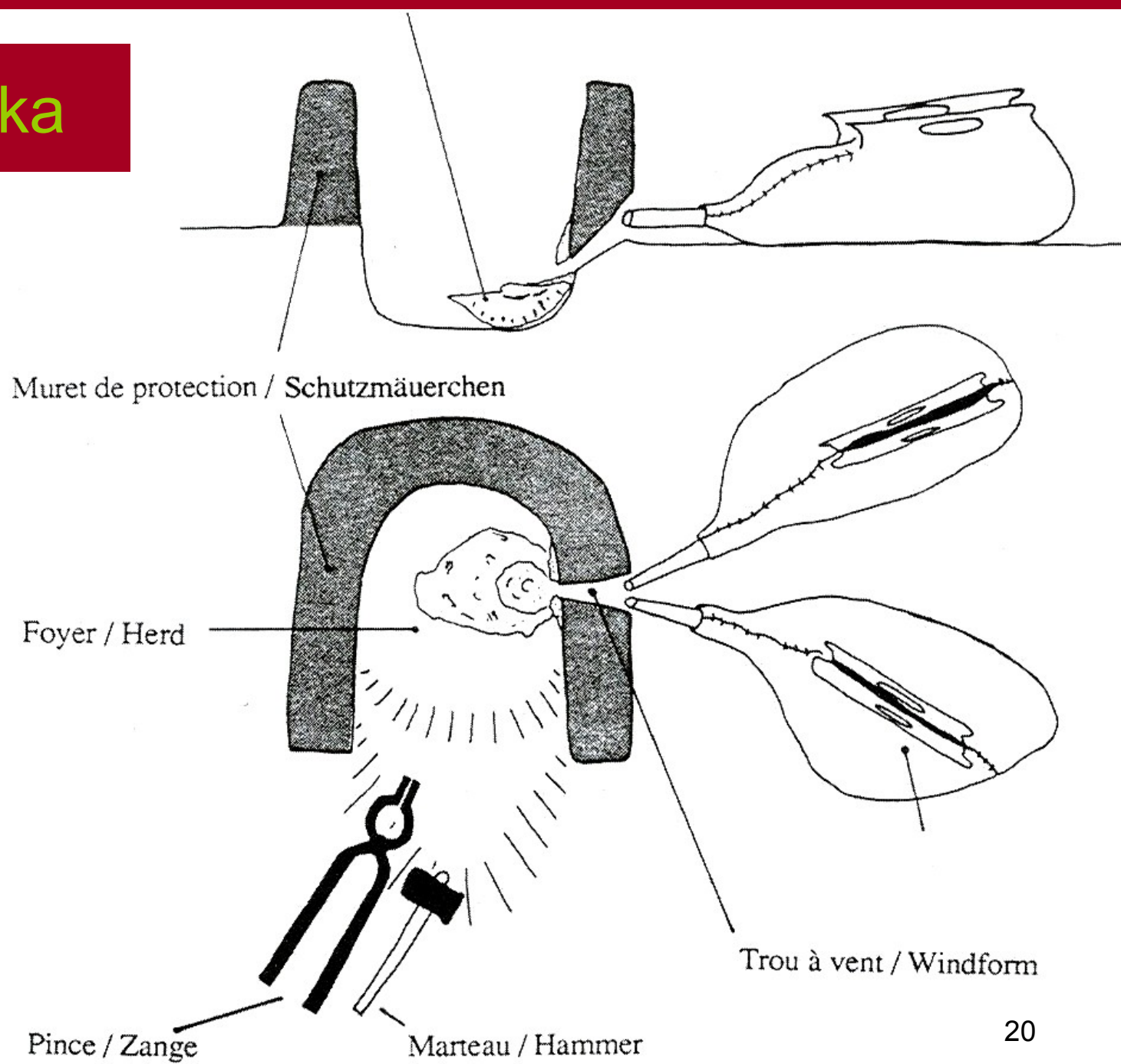



ruční zpracování  
železné houby





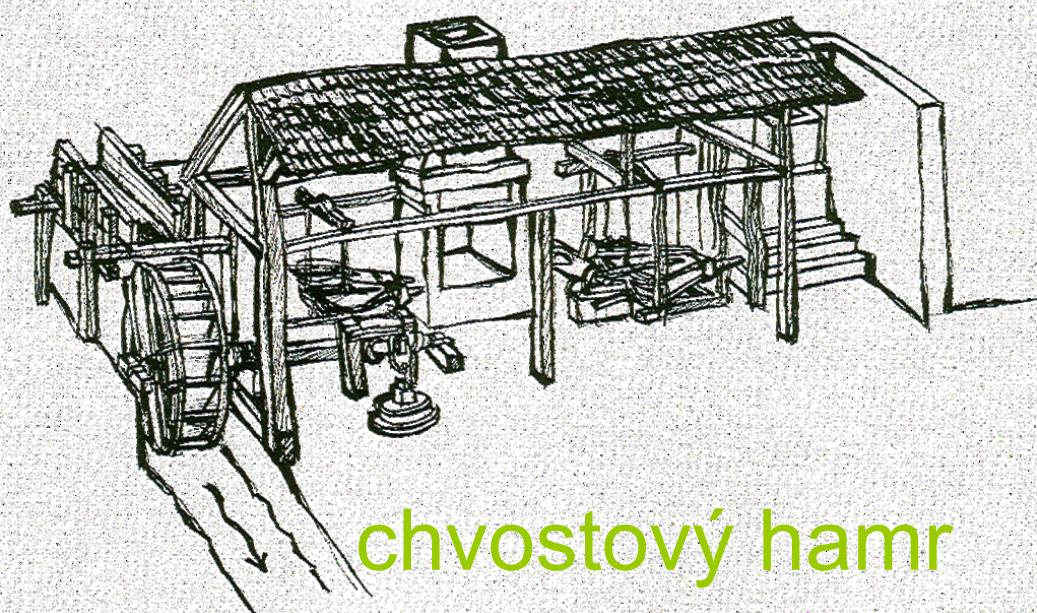
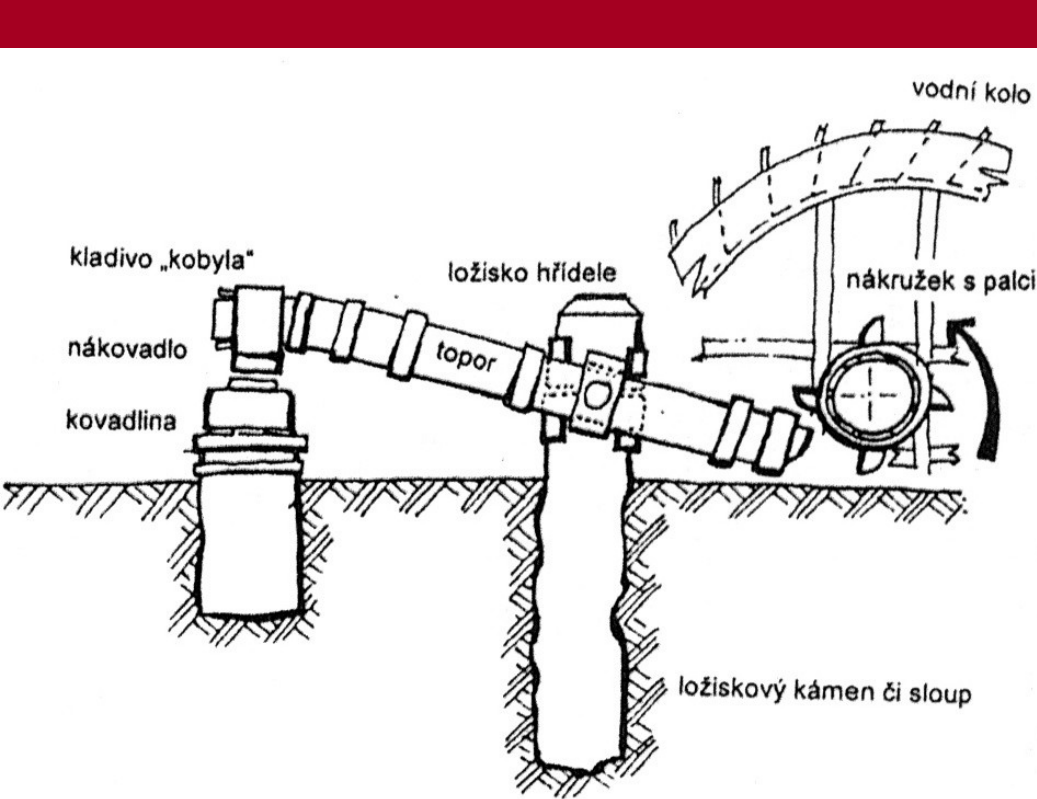

chvostový hamr





dřevěné uhlí

milř

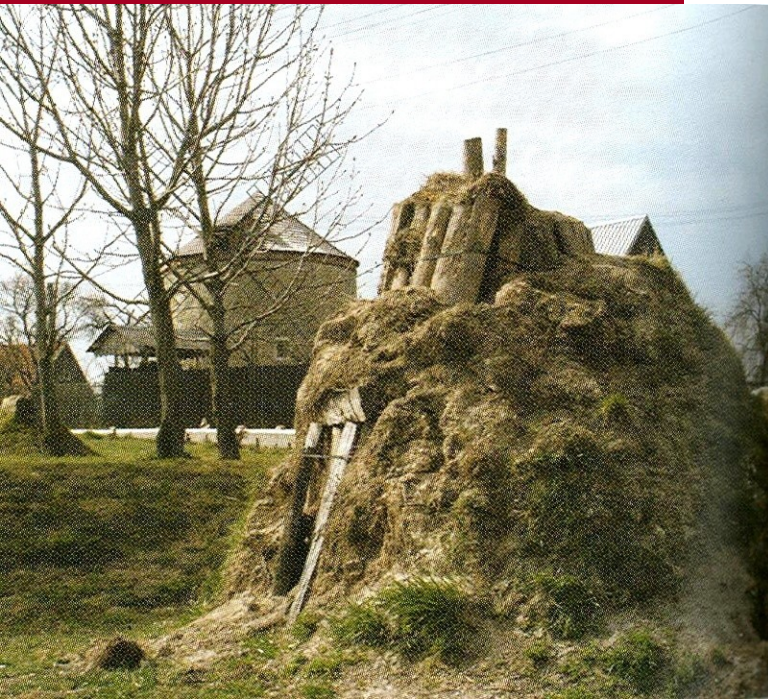
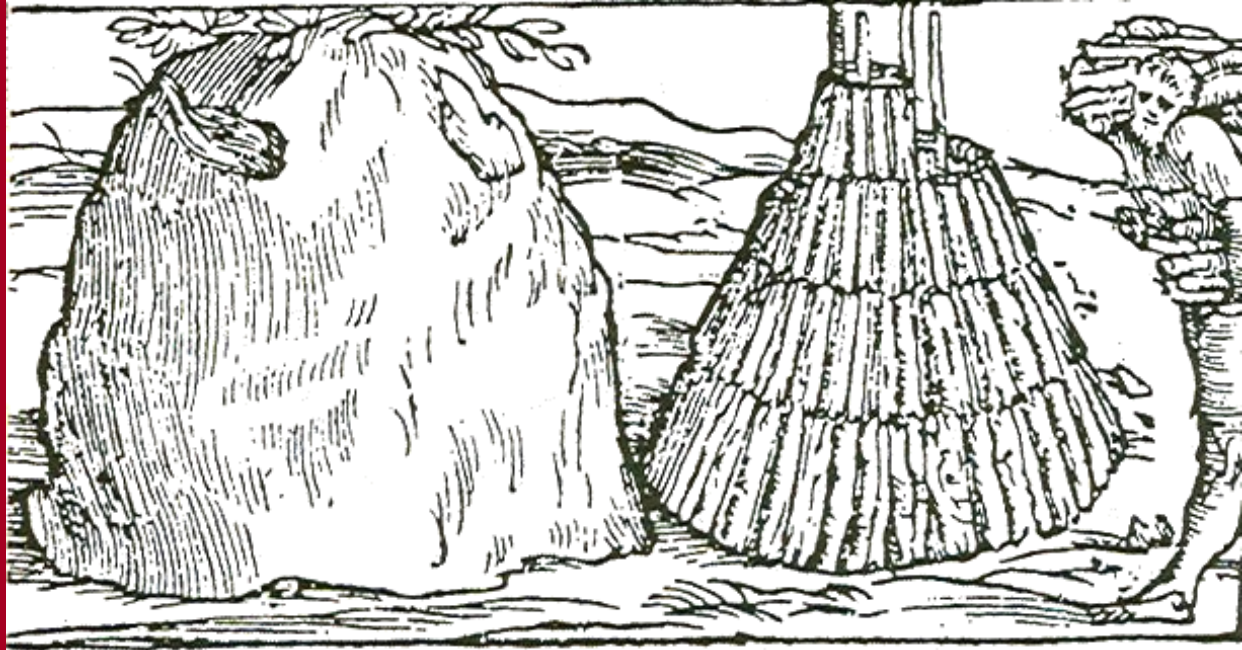



# kovářství

ТЪДА ГЪ МѠУ СЕЮ :





# kovolitectví



# kadluby





# odlévání metodou ztraceného vosku

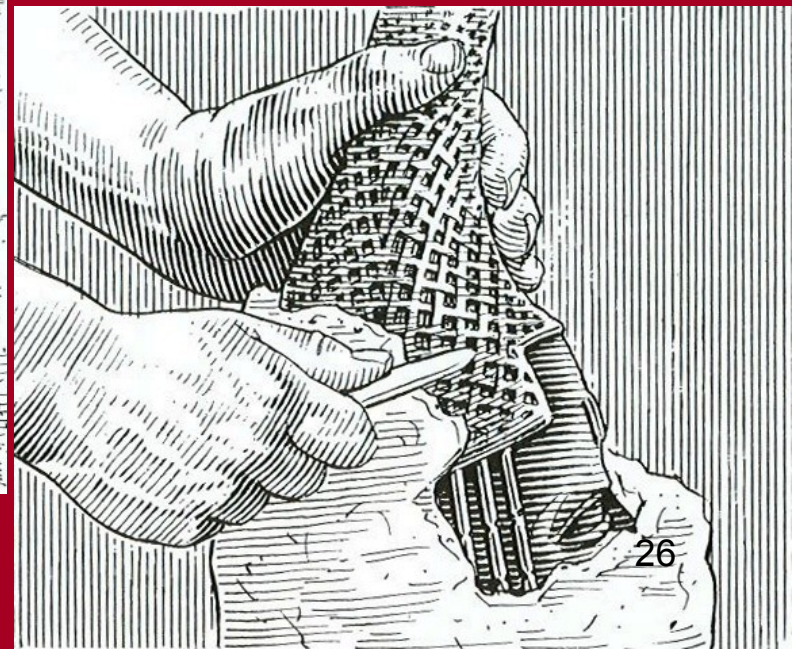
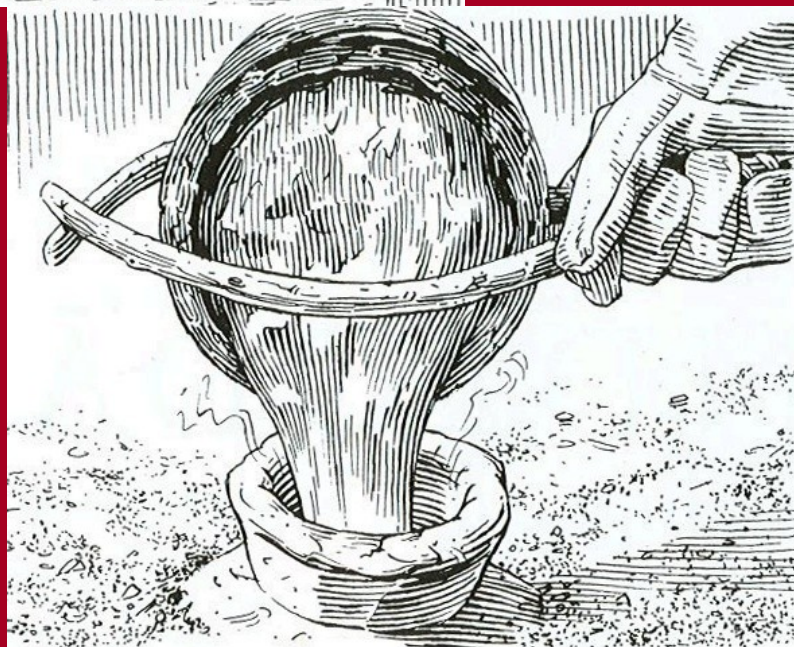
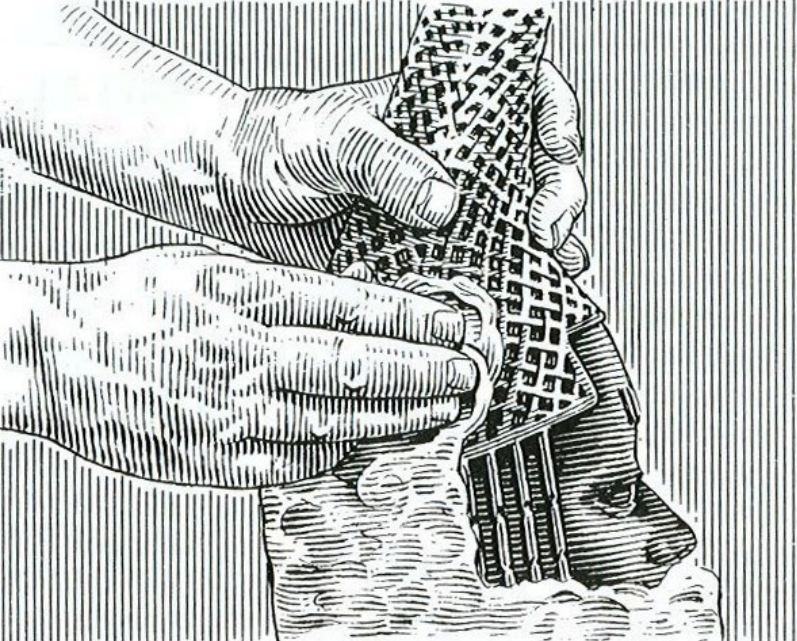



# kovotepectví

kovotepecká podložka

