

# Hmotná kultura a každodenní život III

## vesnice

# literatura

- Belcredi, L. 2006: Bystřec. O založení, životě a zániku středověké vsi. Brno.
- Dějiny hmotné kultury I(1), 1985.
- Le Goff, Jacques, 1999: Středověký člověk a jeho svět. Praha.
- Měchurová, Z. 1997: Konůvky – zaniklá středověká tvrz ve Ždánickém lese. Studie AÚ AV ČR v Brně 17/1.
- Nekuda, V. 1975: Pfaffenschlag. Zaniklá středověká ves u Slavonic. Brno.
- Nekuda, R. – Nekuda, V. 1997: Mstěnice 2, zaniklá středověká ves. Brno.
- Nový, L. a kol., 1974: Dějiny techniky v Československu do konce 18. st. Praha, 63–146.
- Vařeka, P. 2004: Archeologie středověkého domu I. Proměny vesnického obydlí v Evropě v průběhu staletí, 6.–15. století. Praha.

# kolonizace

■ vnitřní

■ vnější

- Staré sídelní území do 12. stol.
- Oblasti lesní
- Kolonizované území ve 14. stol.
- Kolonizované území ve 13. stol.

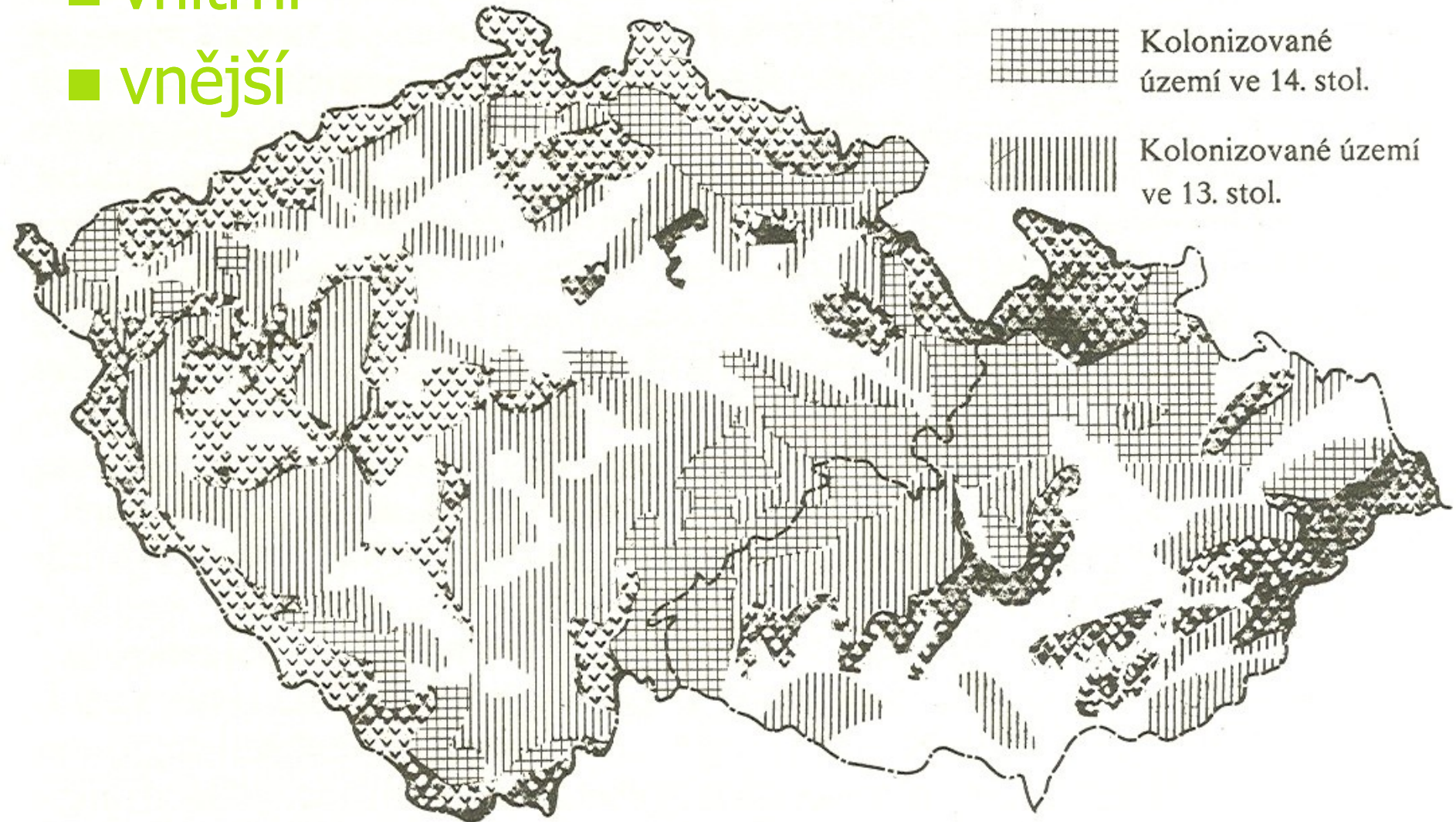

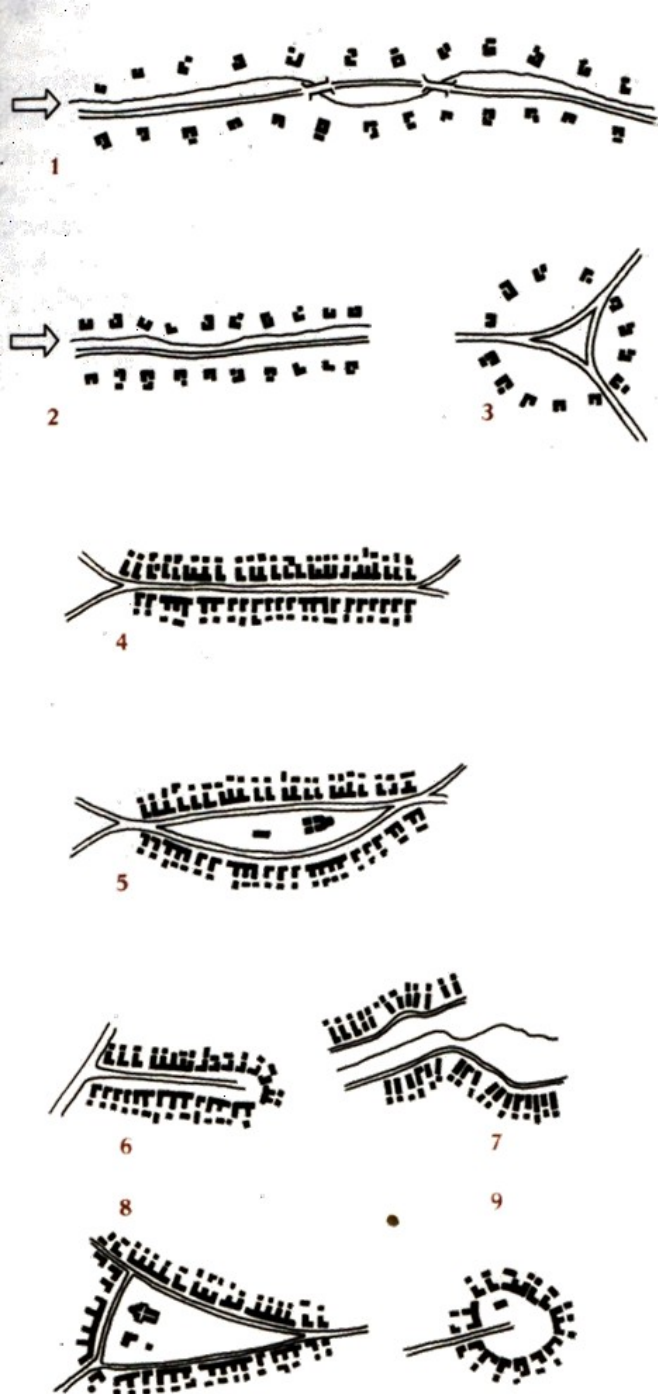

## ■ Půdorysy vesnic:

■ volně roztroušené vsi

■ lesní lánové vsi:

– dlouhé, po obou březích potoka (1)

– krátké dvojřadé (2)

■ lesní návesní (3)

■ silniční vsi:

– dvě řady domů v těsném sousedství (4)

– silniční návesovka (5)

– ulicovka (6)

■ řádkový půdorys (7)

■ návesní vsi:

– návesovka (8)

– okrouhlice (9)



# Plužiny

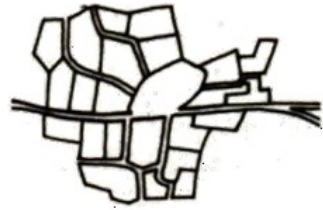

1



2



3



4

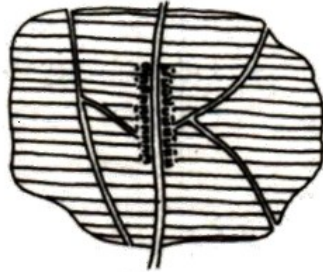

5

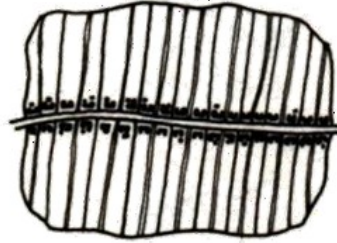

6

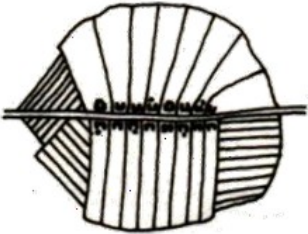

7



8

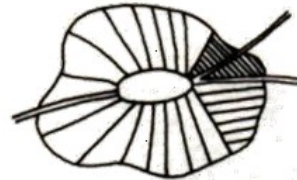

9



10



11

1. úseková
2. dělených úseků
3. traťová
4. nepravá traťová
5. délková
6. záhumenicová – lesní lánová
7. záhumenicová klínová a pásová
8. záhumenicová paprscitá
9. kompaktní
10. rozštěpená
11. rozptýlená

# Pfaffenschlag (Slavonice)

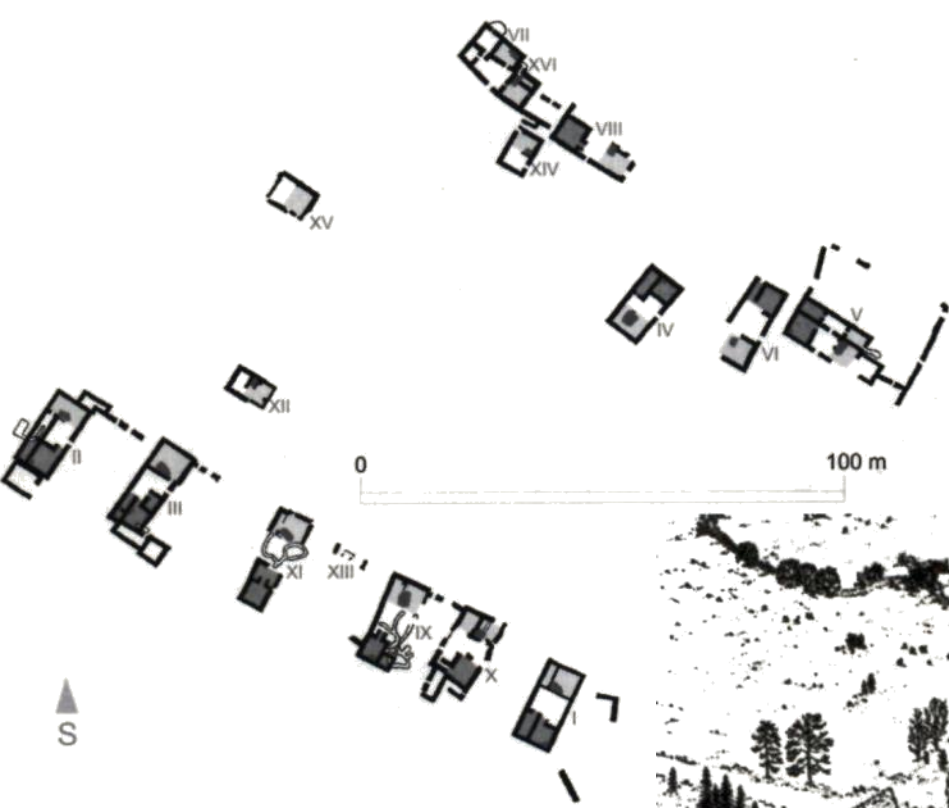

# Bystřec (Jedovnice)

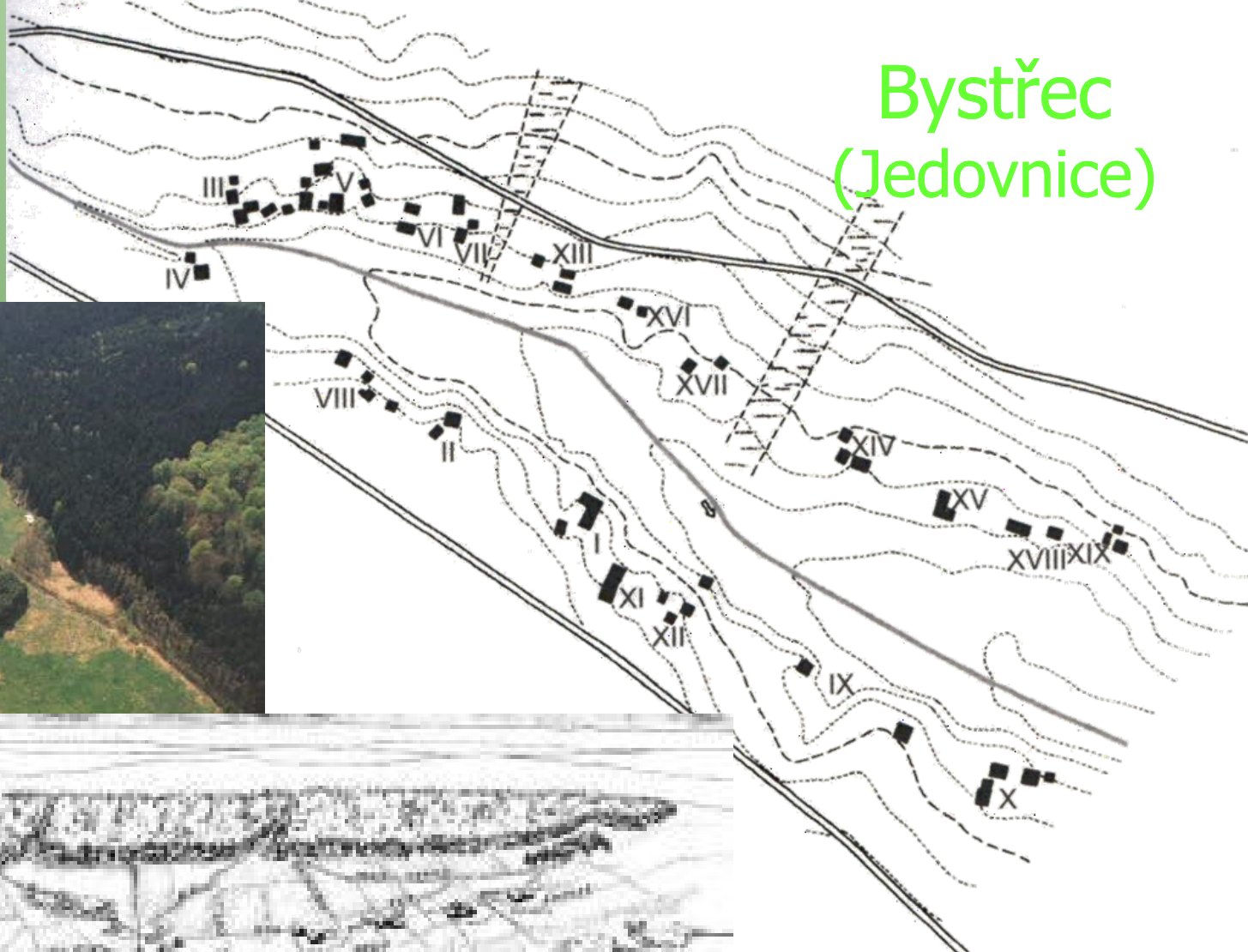



# Konůvky (Ždánický les)

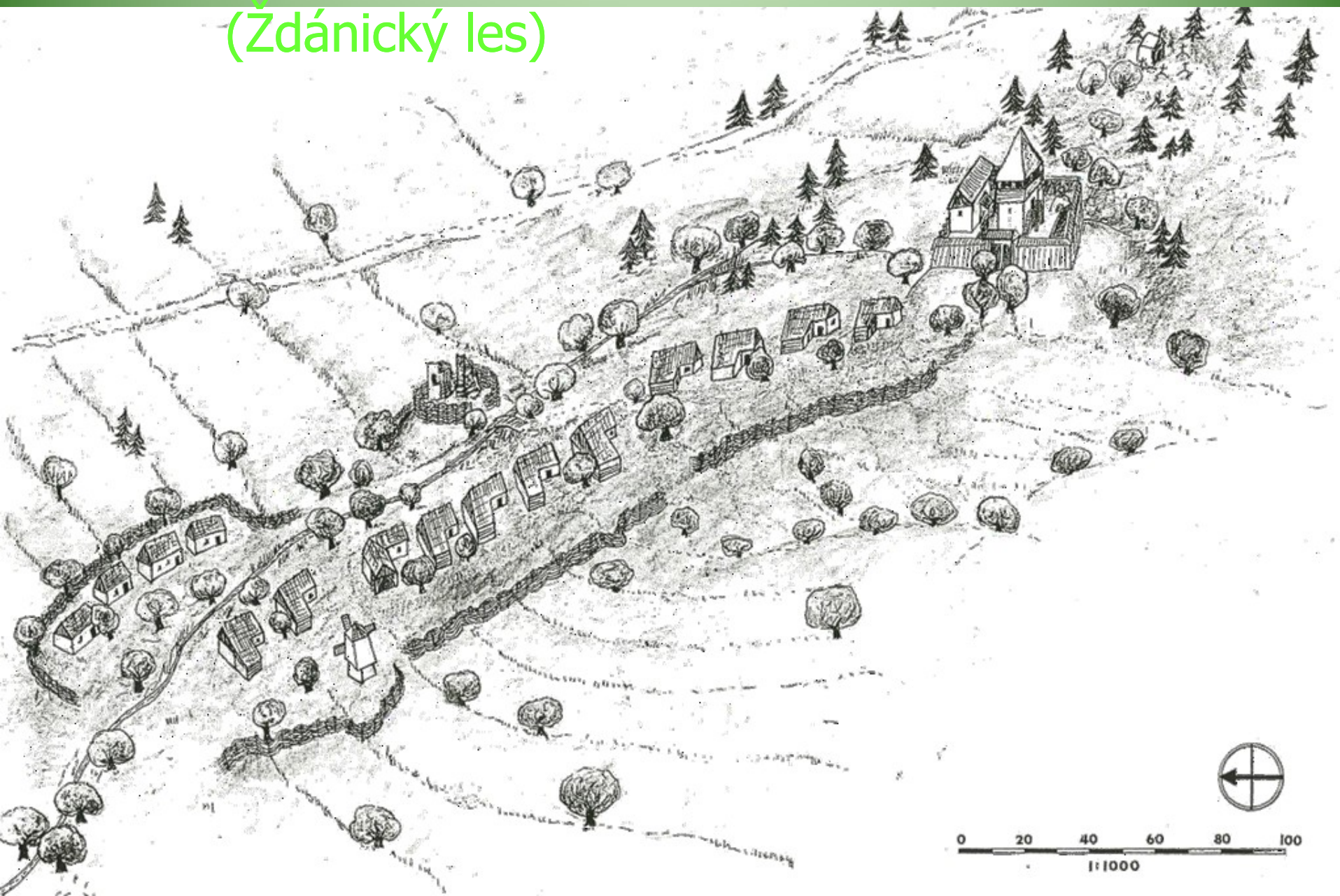





Mstěnice

2. polovina 11. – 1. polovina 12. století

vesnice

- rychta
- farní kostel

- fara
- hřbitov
- krčma
- kovárna
- mlýn
- trvz

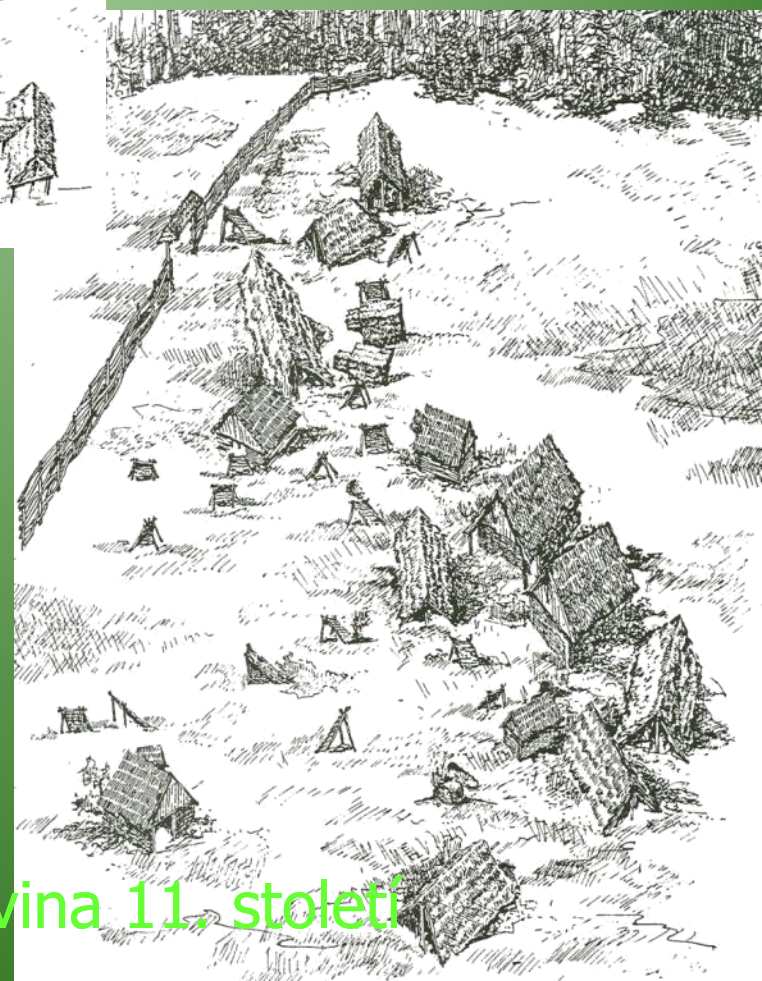

Mstěnice

10. – 1. polovina 11. století

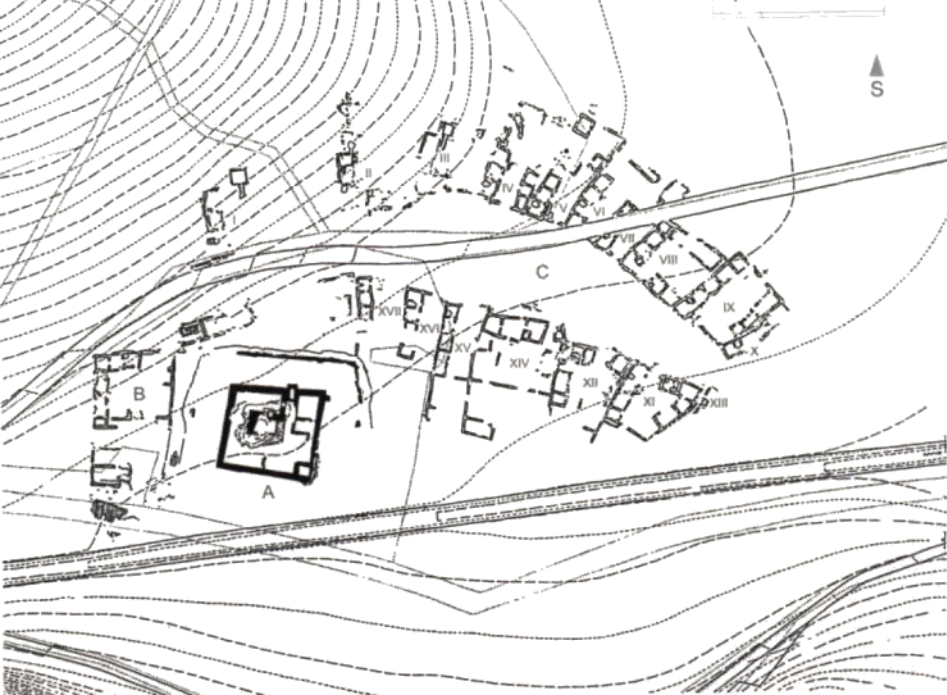

# Mstěnice (Rouchovany)





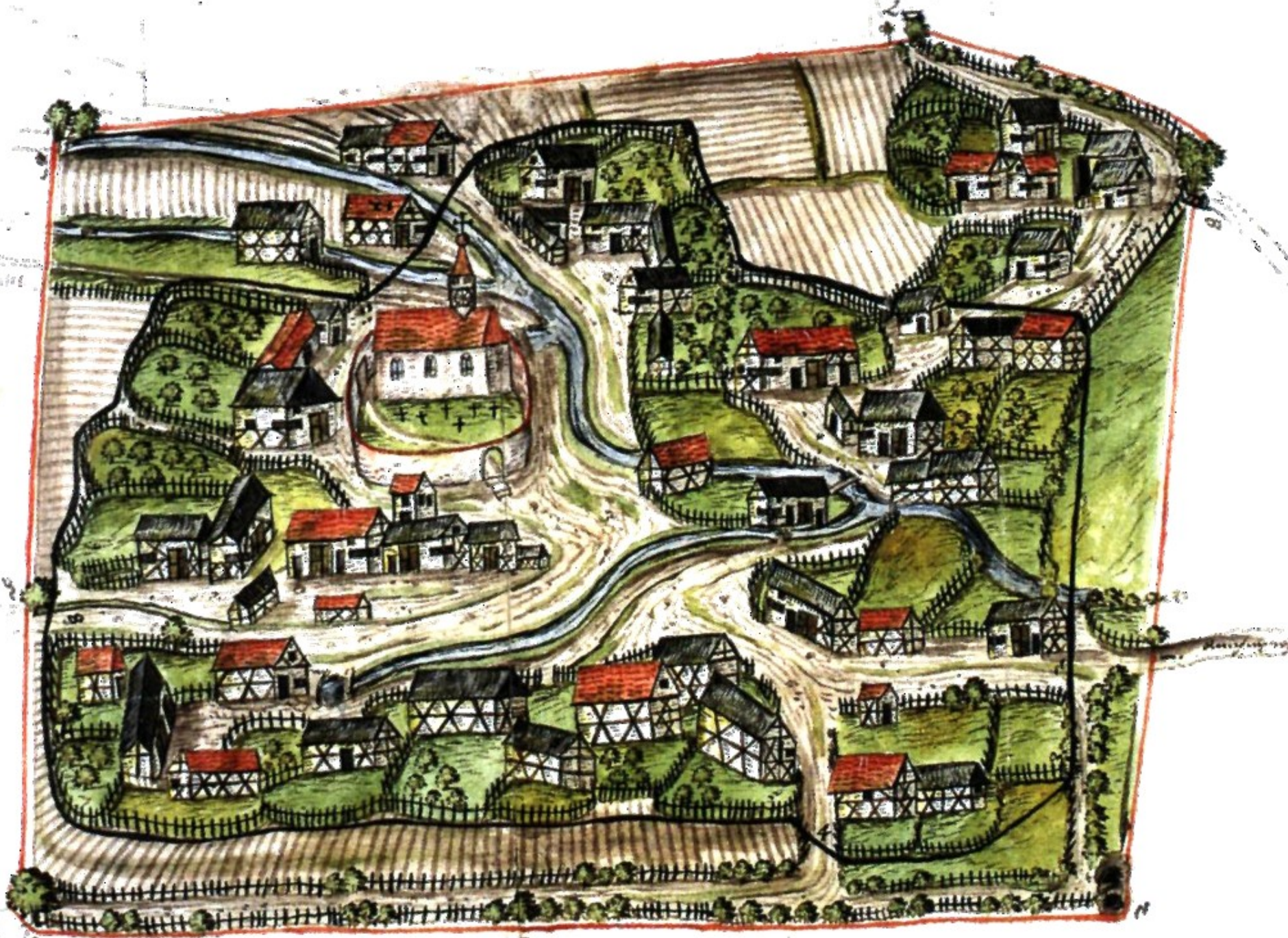

# sociální struktura

- pán
- poddaný (poplatky, naturálie, roboty, rekvizice)
  - rolníci
  - podsedci
  - chudina
  - řemeslníci
  - rychtář (šafář, mlynář, krčmář)
- svobodník
- nápravník
- farář



# půda

- v přímém užívání pána
- v pronájmu rolníků
- ve společném užívání
- lesy
- vodní toky

## výměra

- lán (přes 18 ha)
- strych, korec
  - zásevek
- jitro
  - záhon (od 15.st.)
  - brázda

# zemědělská půda

- klučení
- trojpolní hospodaření
  - ozim
  - jař
  - úhor





# polní práce

- orba
- vláčení
- setí
- sklizeň

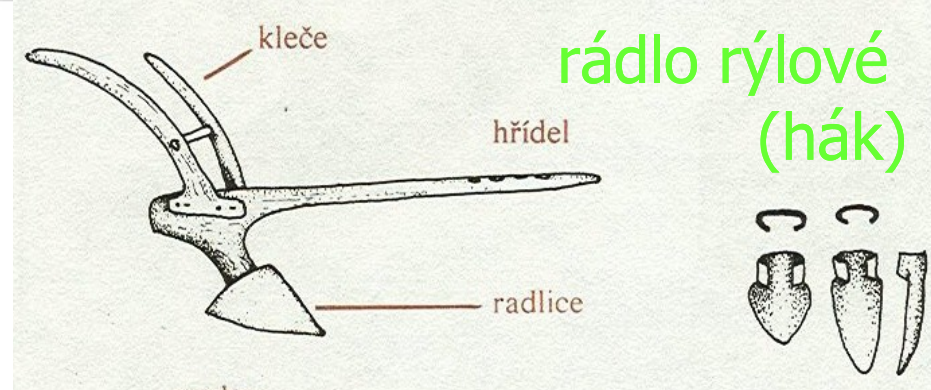

## radlice

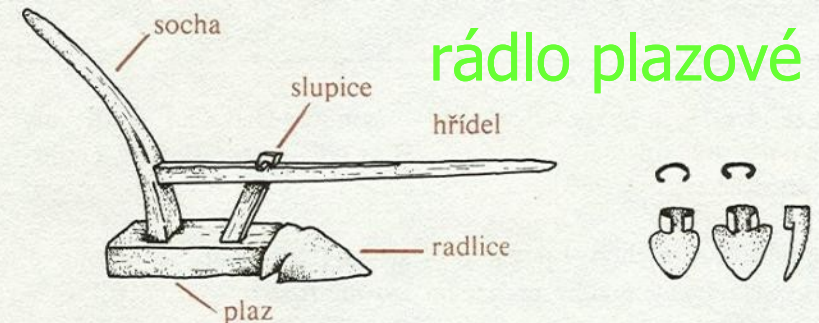
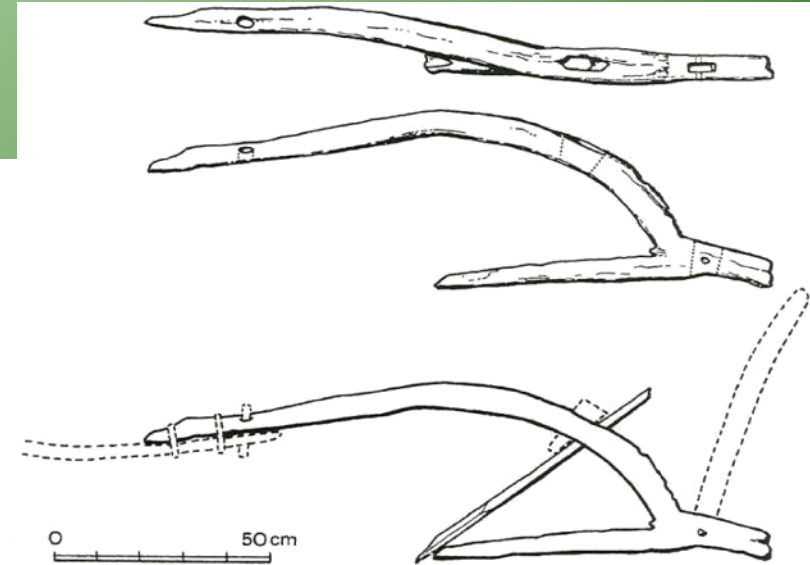



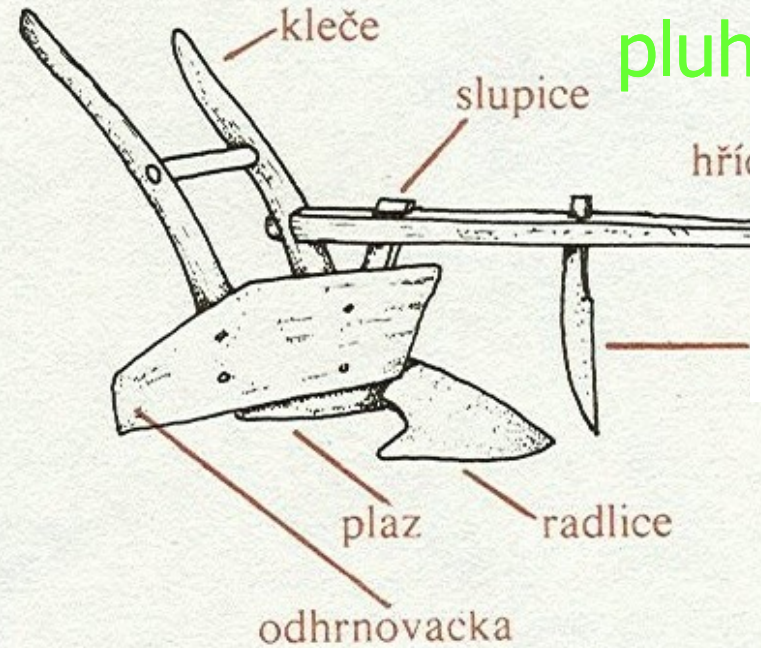

pluh



asymetrická radlice

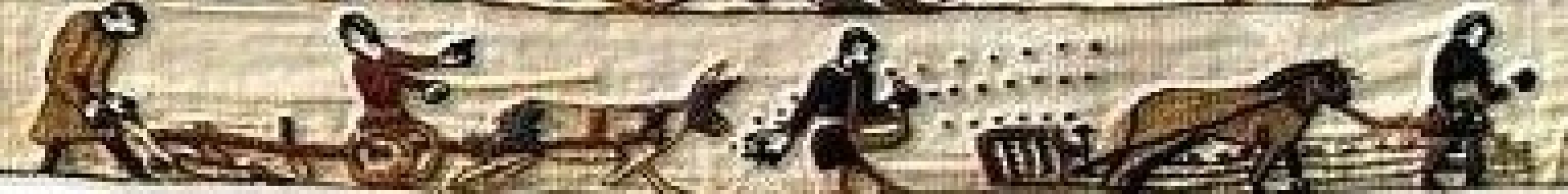





- krojidlo
- asymetrická radlice
- kopinatá radlička
- otky





orba

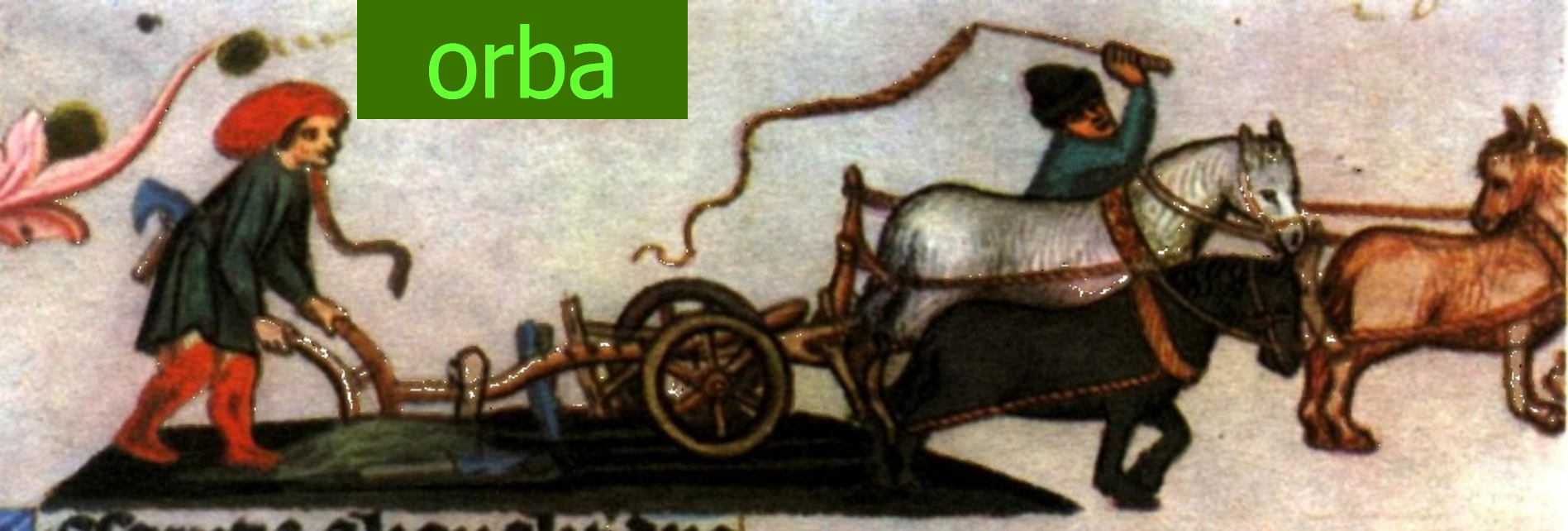

kolový pluh





zápřah

jho

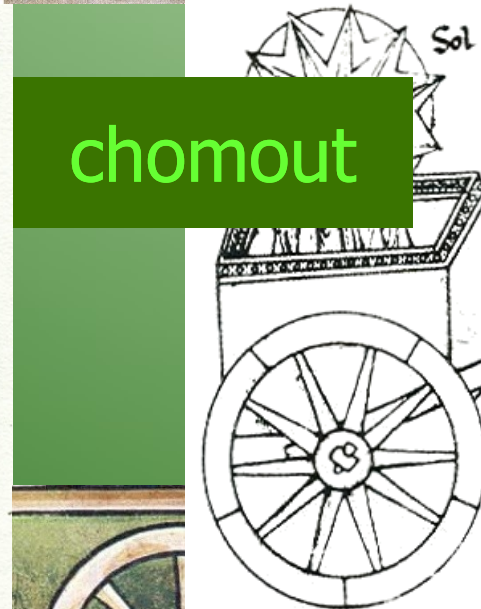
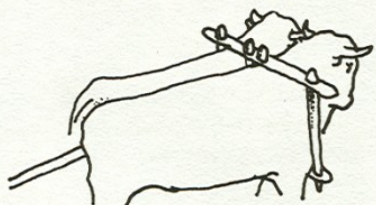
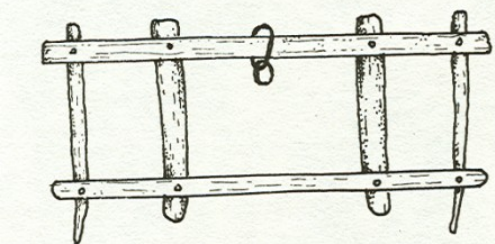
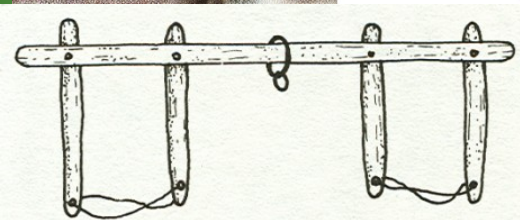
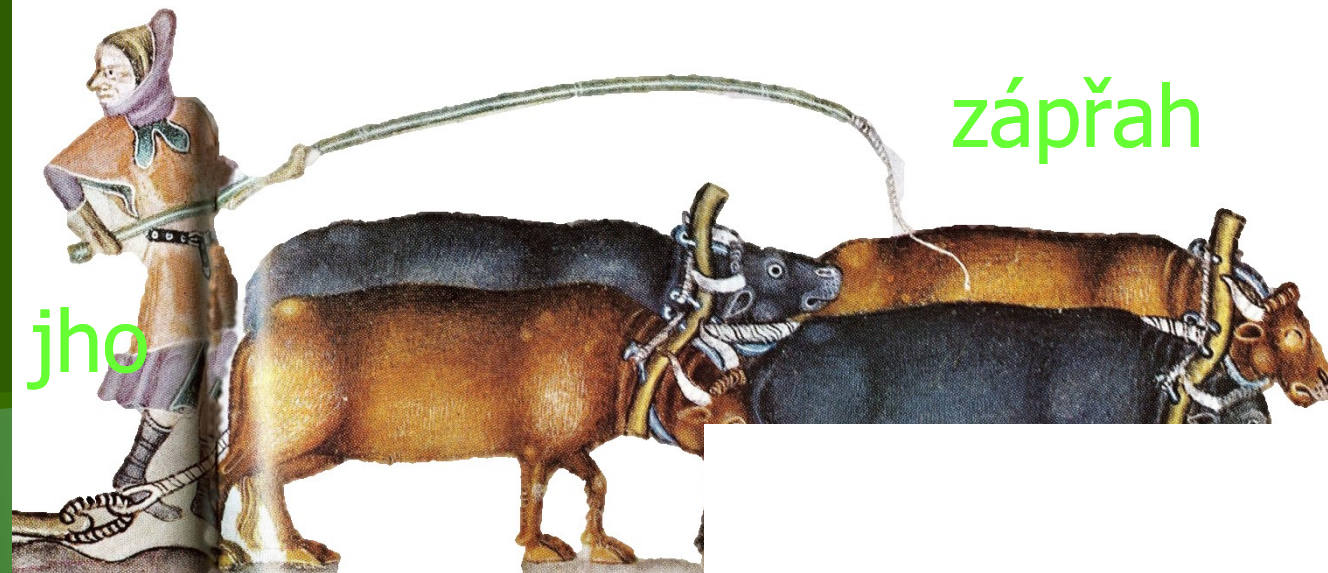

chomout

Equi solis

Acteon i rui  
Critus i sp  
Lampol i ardent  
p hylageut i amant i m

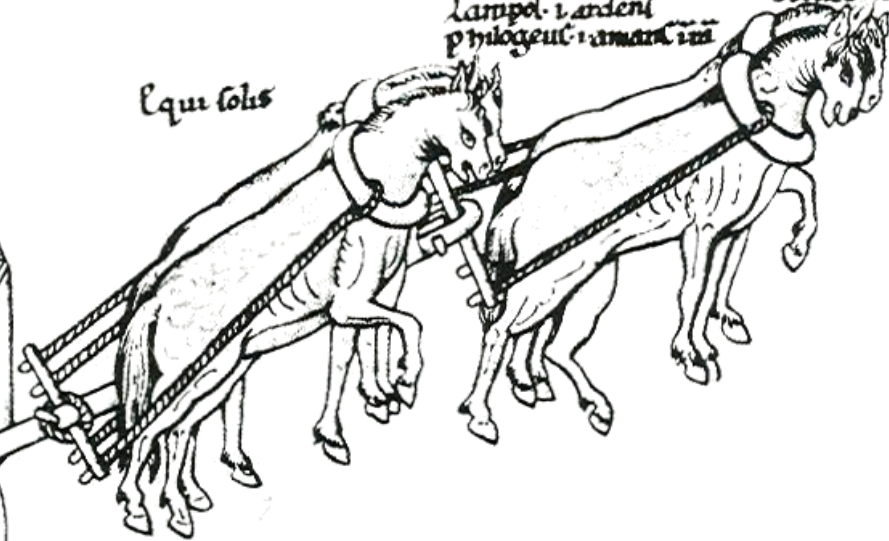



Sicut in irritacione: secundum diē



vláčení - brány





setba



men humi iacto



<b>T</b>	<b>R</b>	<b>B</b>	<b>E</b>
xvi	a		a
v	b	vi	H
xiii	c	v	H
ii	d	iiii	H

se sang  
Barbye  
oye.





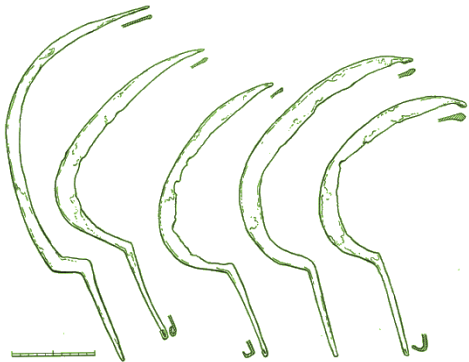

srpy

žně







senné vidle



mláčení

cepy

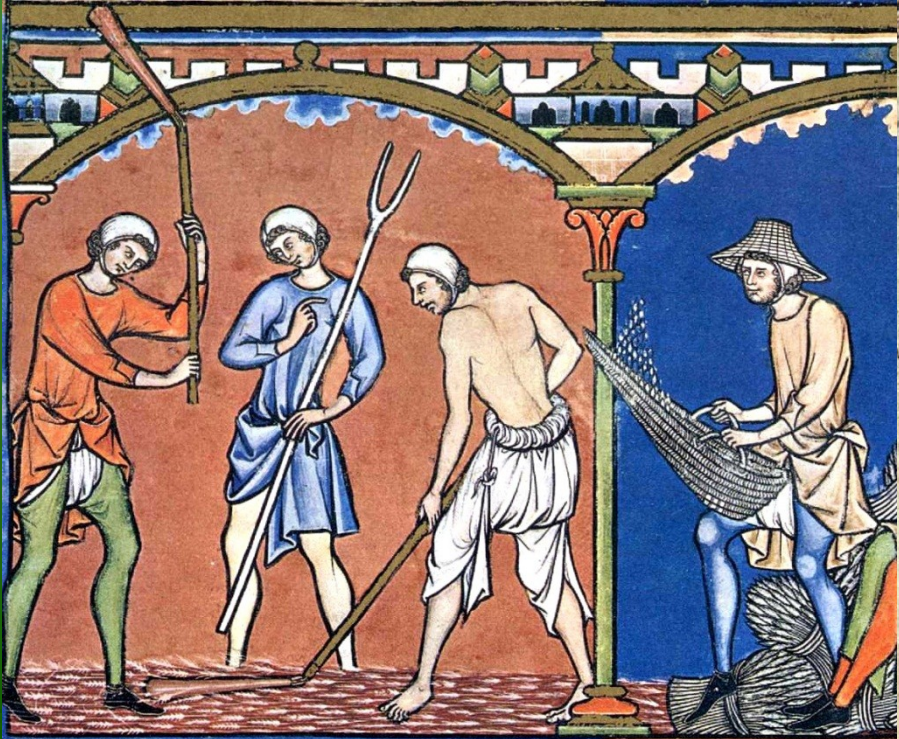



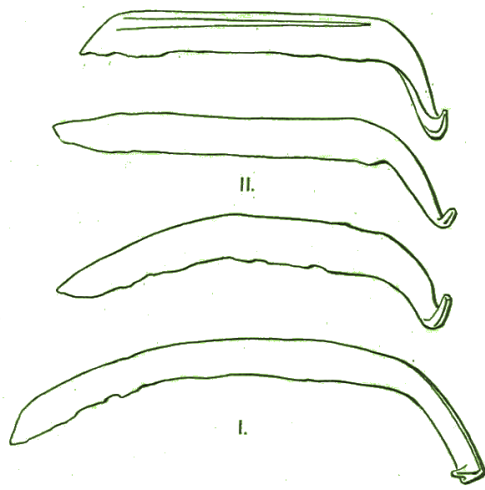



hrábě



lopata





# vesnický dům

- zahloubený
  - zemnice
  - polozemnice
- nadzemní
  - roubený
  - kůlový

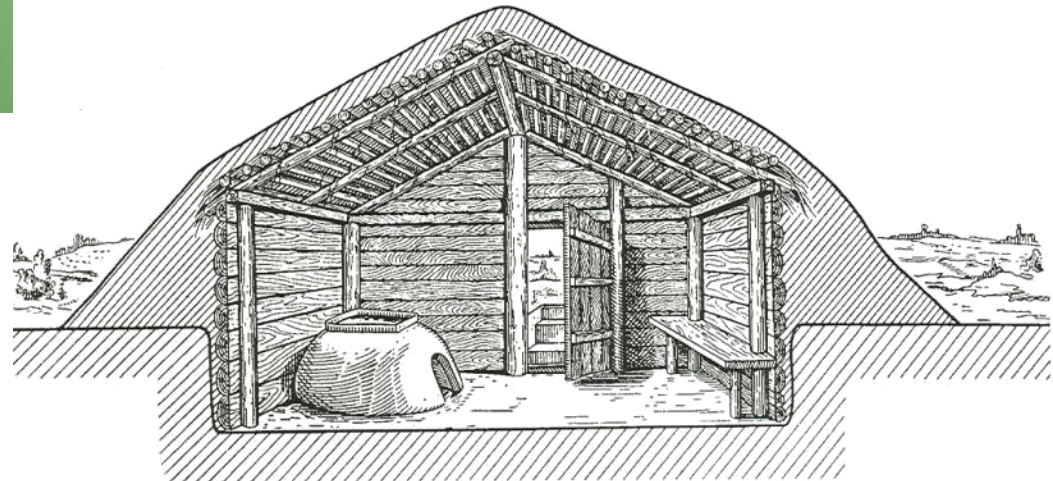
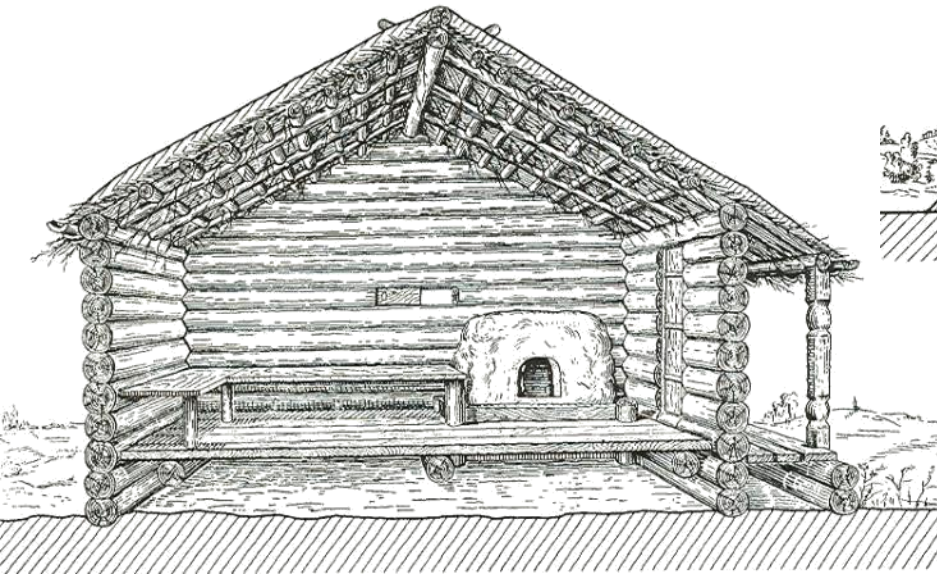



# trojdílný dům

- jizba (světnice)
- síň
- komora (špýchar) nebo chlév

- vstup ve štítové stěně jizby (A)
- vstup v okapové stěně jizby (B)

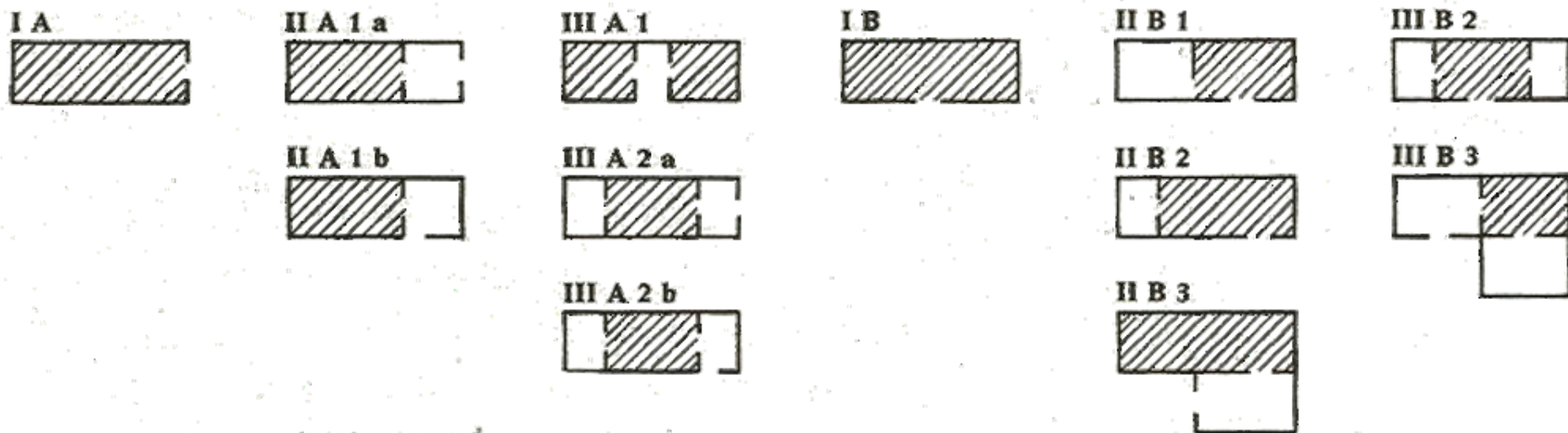

I-III JEDNOTLIVÁ VÝVOJOVÁ STADIA

▨ VYTÁPĚNÁ MÍSTNOST

# dům komorový

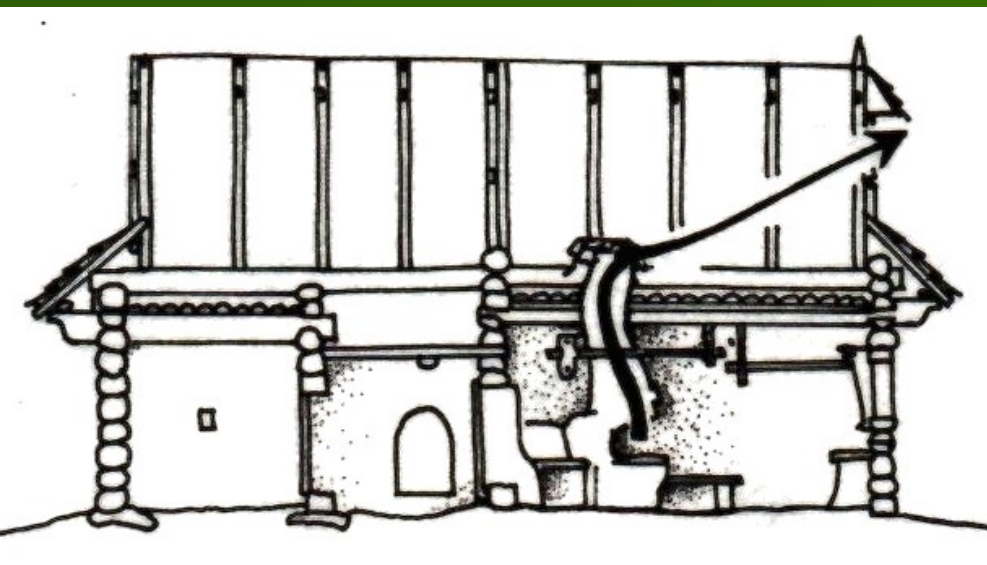

# dům špýcharový

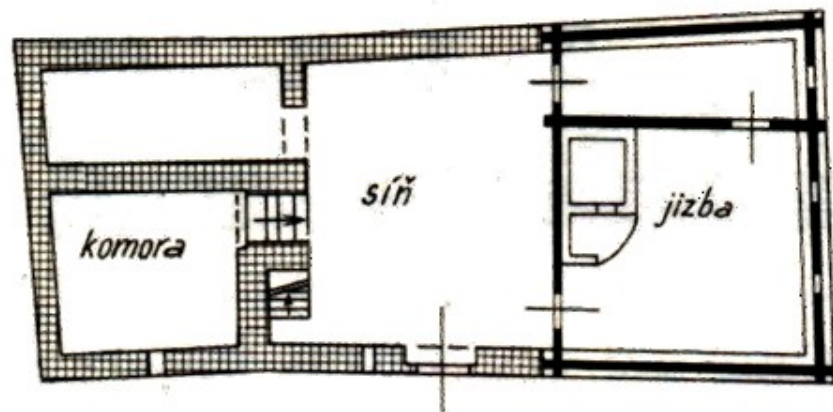
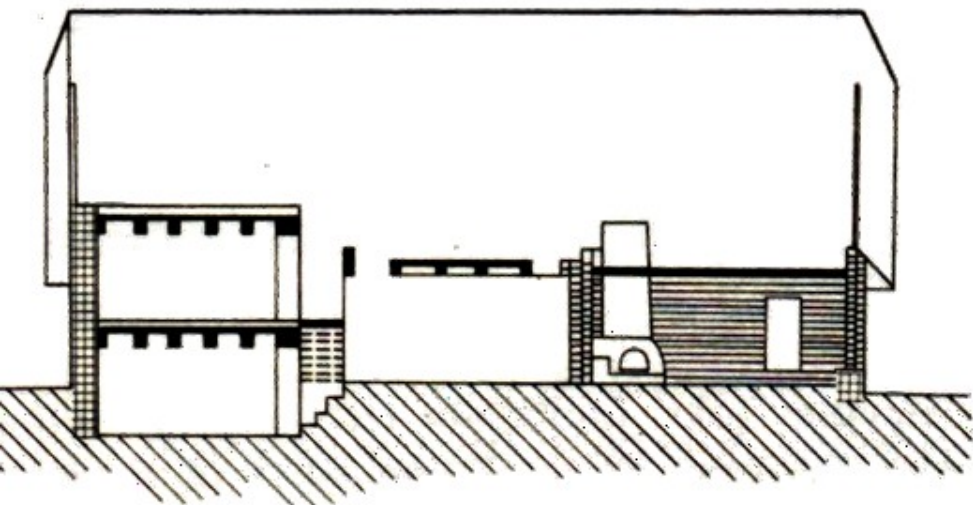
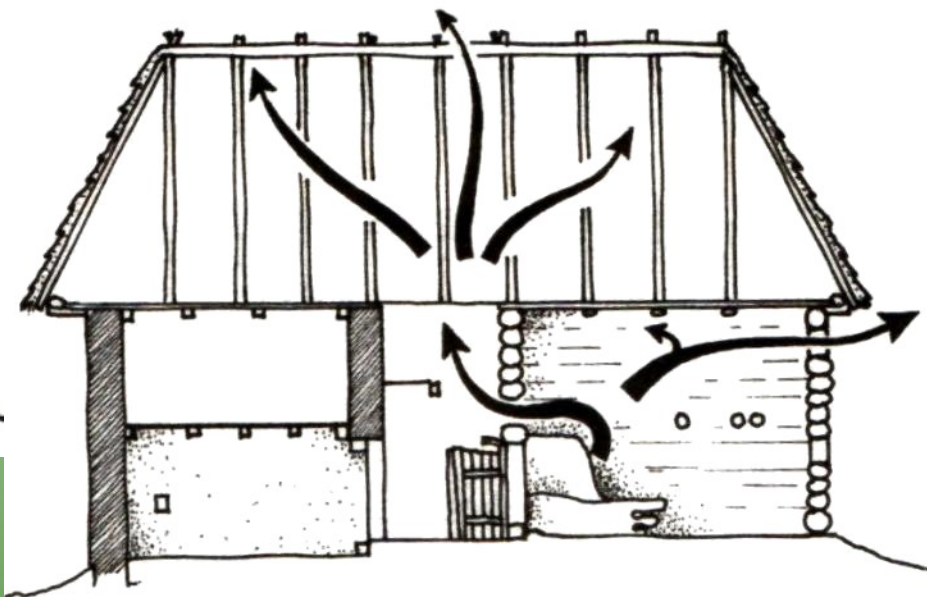



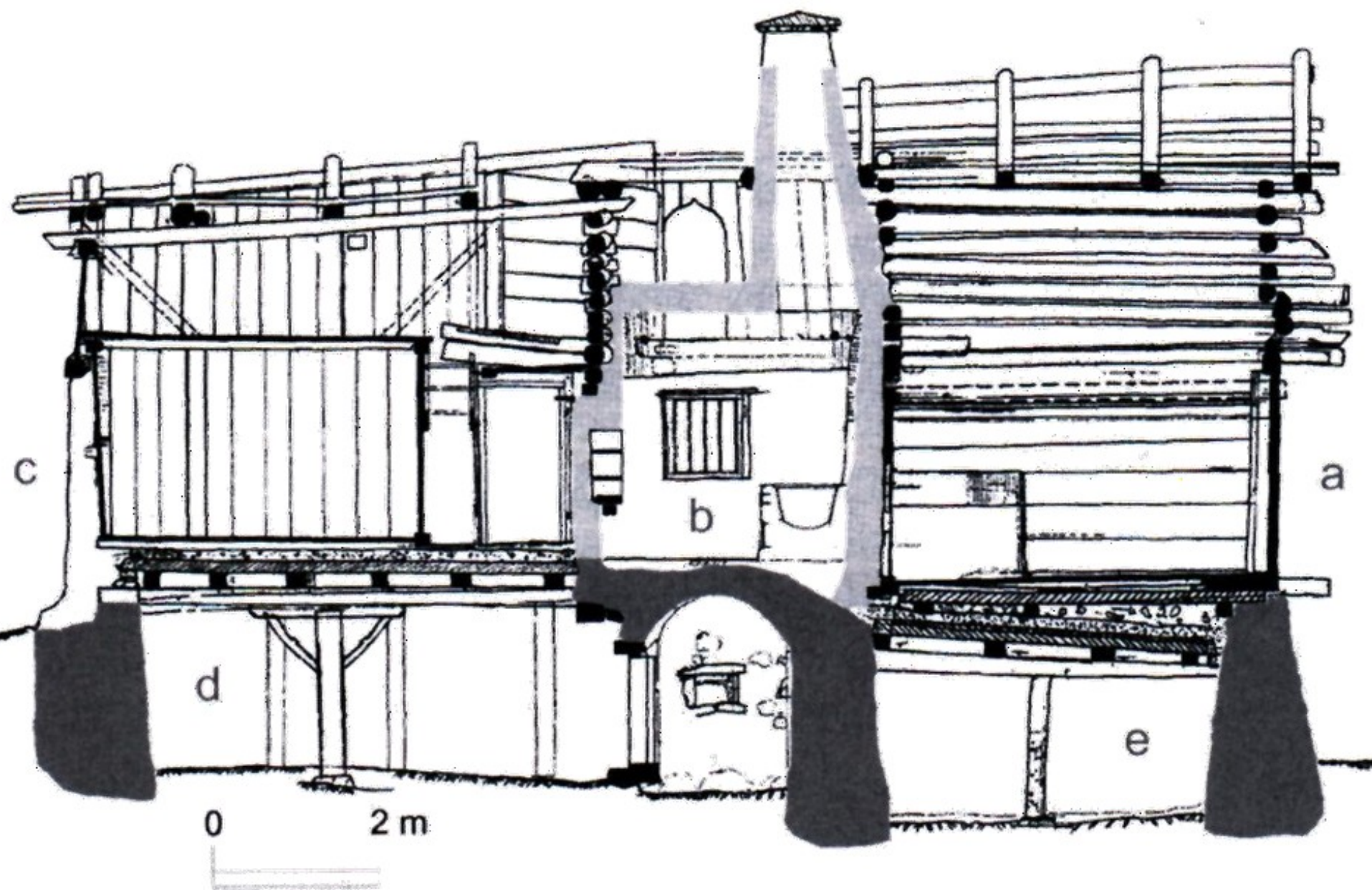



2

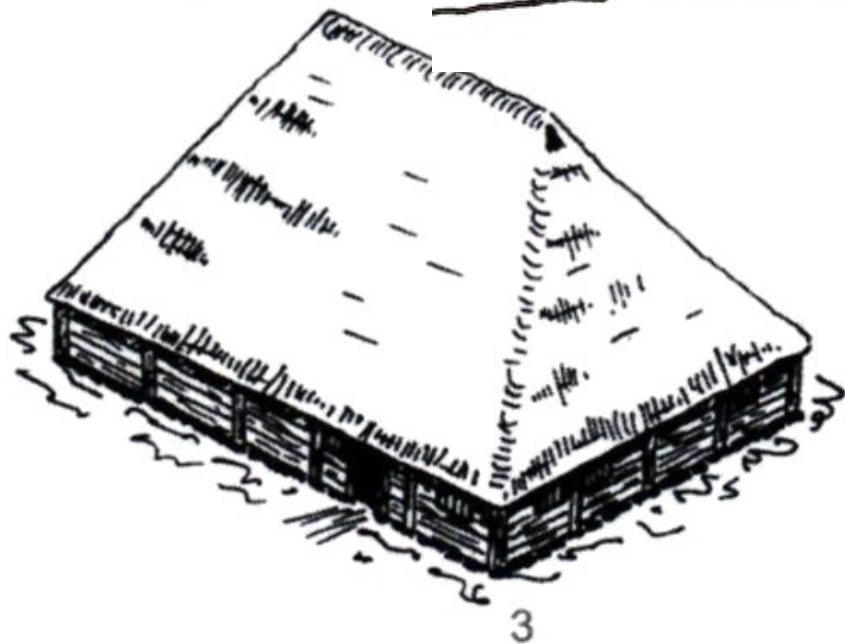
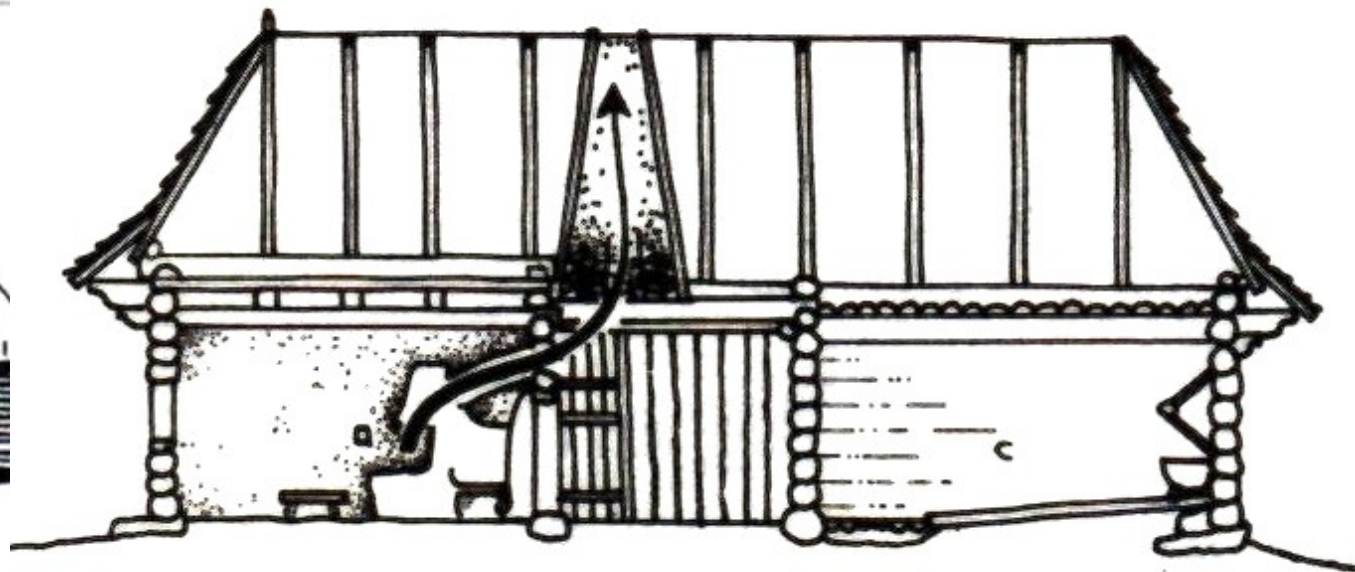

3

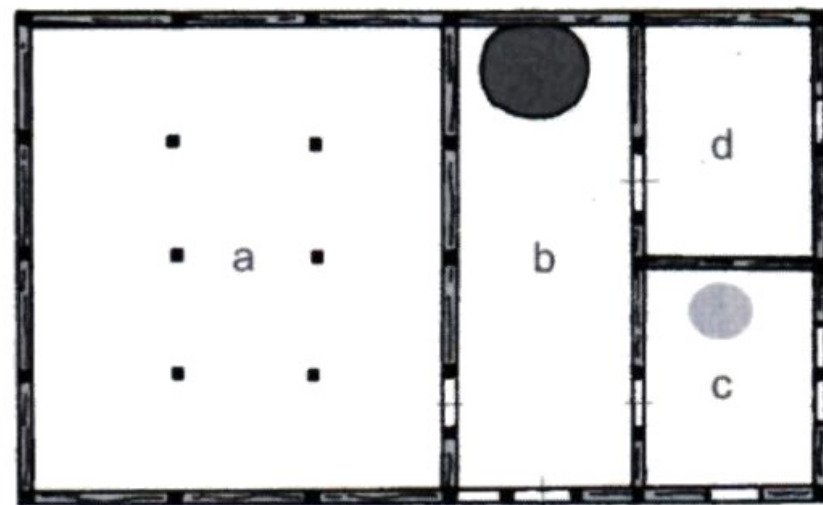

1

0

5 m



dům chlěvní



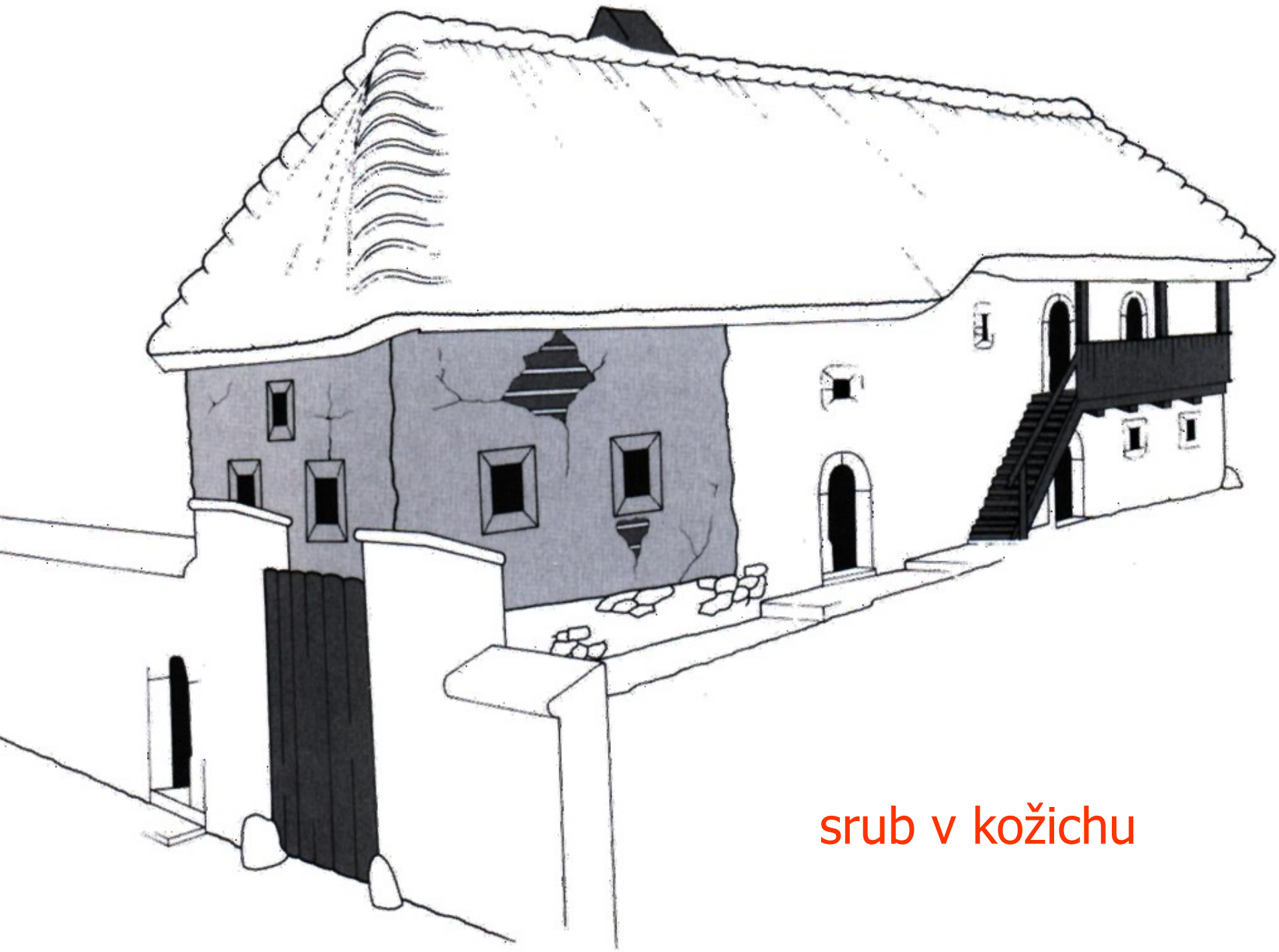

srub v kožichu







# otevřené ohniště

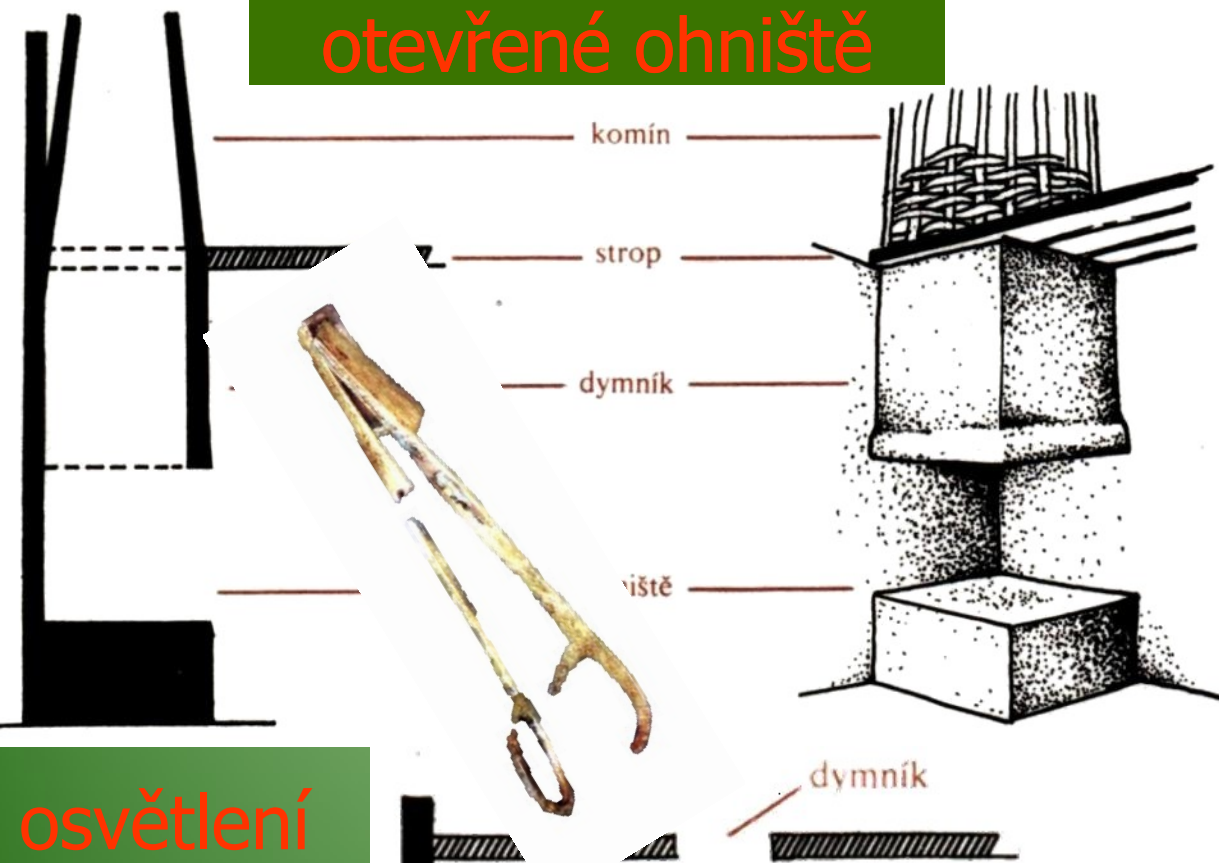

# oheň

- křesadlo (ocílka)
- křesací kámen
- troud (hubka)
- sirný knot

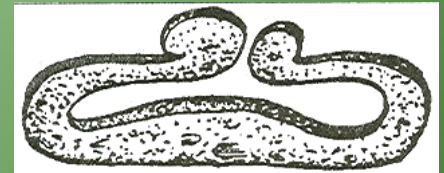

# osvětlení

- louč
- svíce
- kratiknot

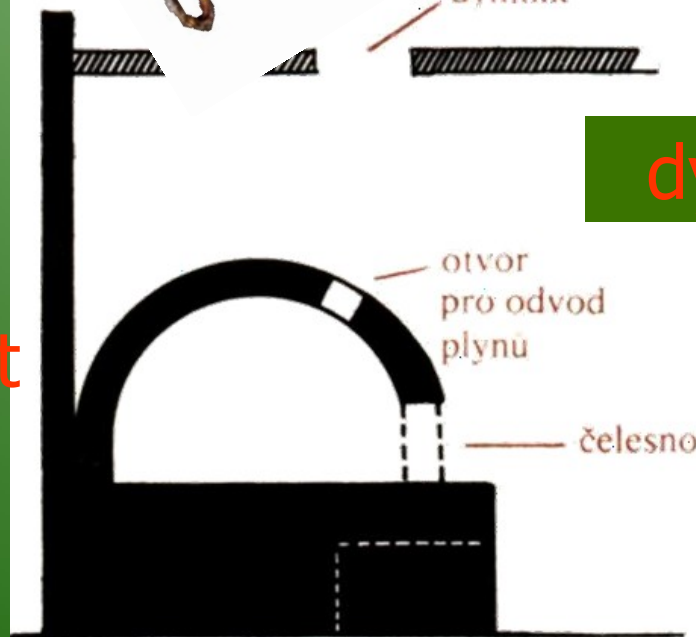

# dýmná pec

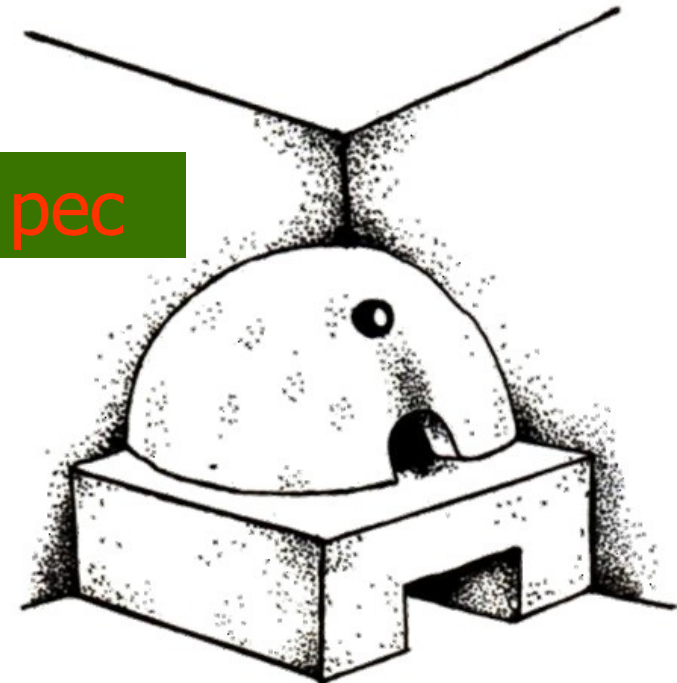

**hřebenová vaznice**

**sedlová střecha**

**došky – žitná sláma,  
rákos**

**kleštiny**

**krokve**

**socha**

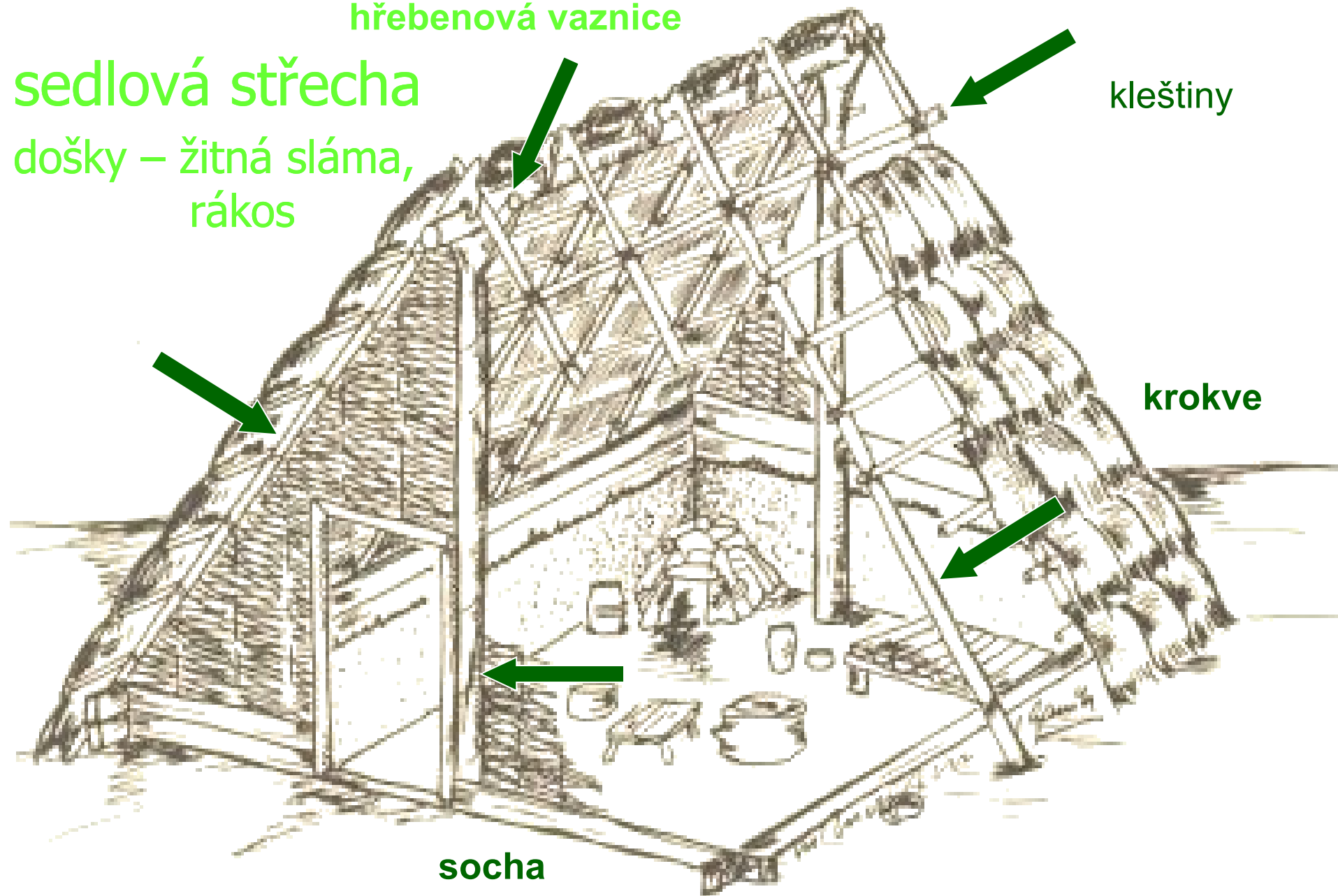



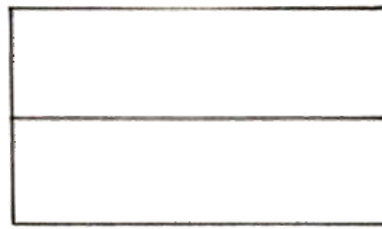
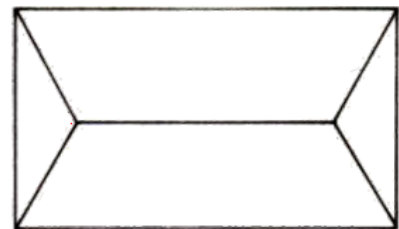
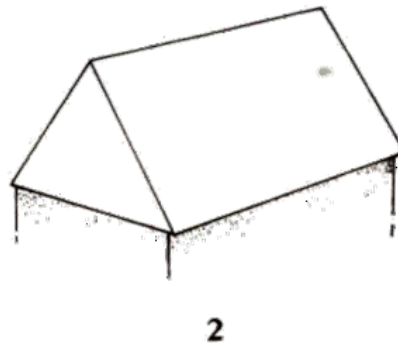
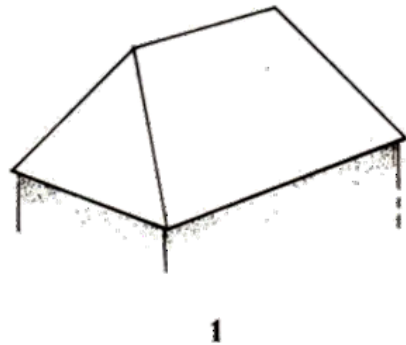
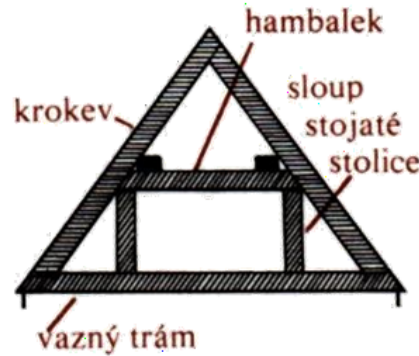
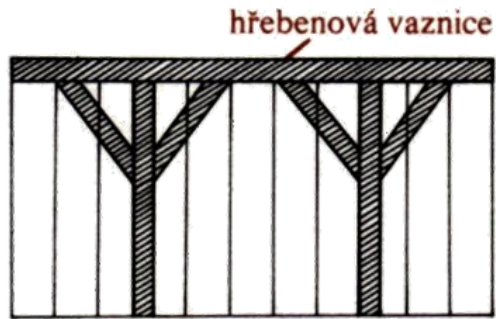
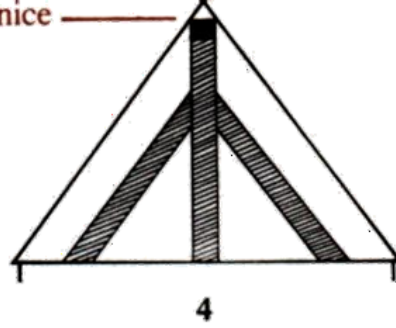
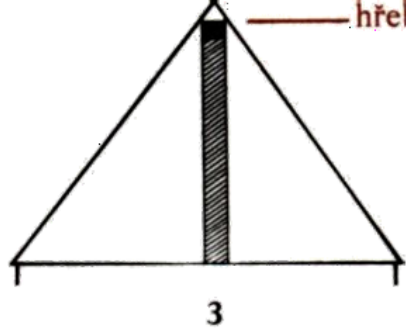

# střecha

- vazný trám
- krokev
- hřebenová vaznice
- hambalek

1. valbová
2. sedlová
3. pultová



# hospodářské stavby

- obilní jámy (zásobnice)
- sýpky
- stodoly
- kůlny
- chlévny
- sklepy
- studny
- pece

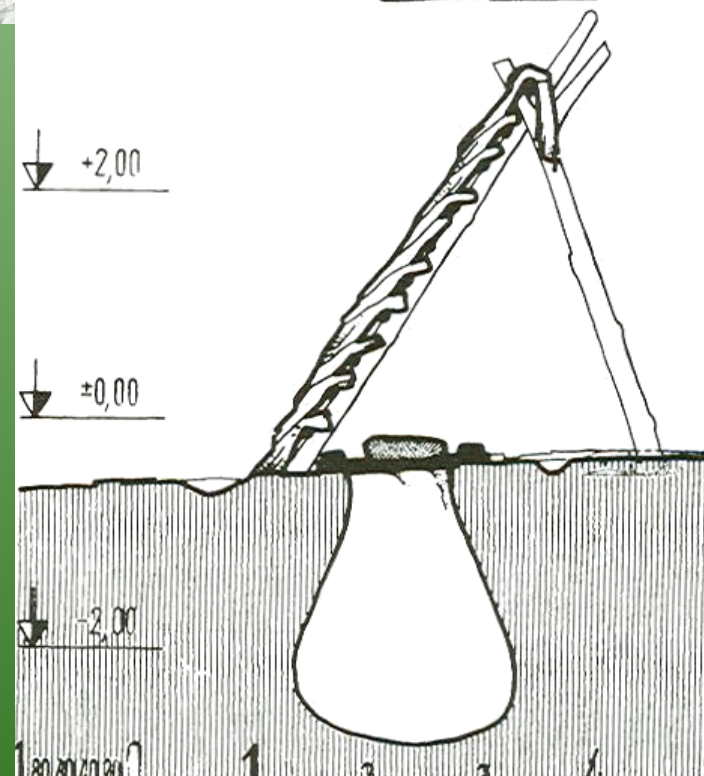
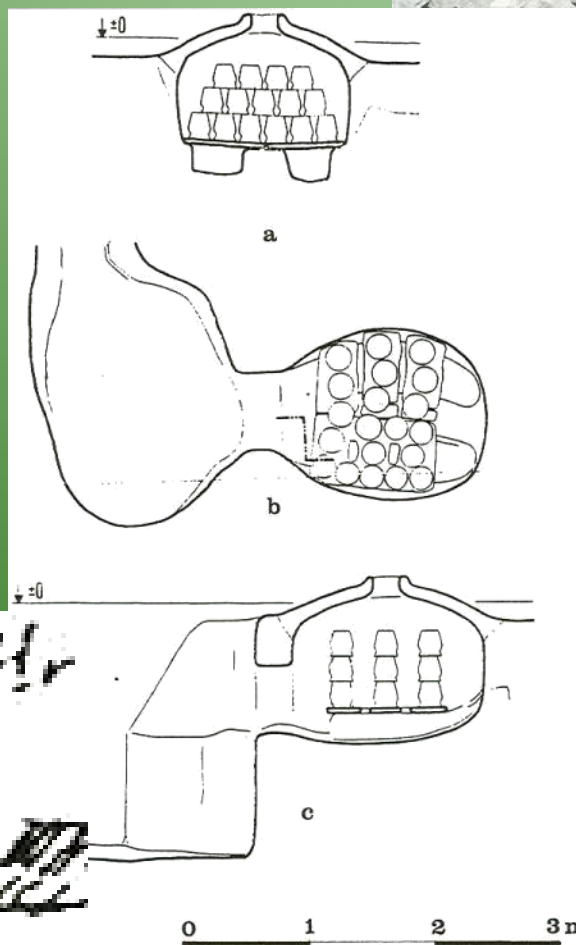
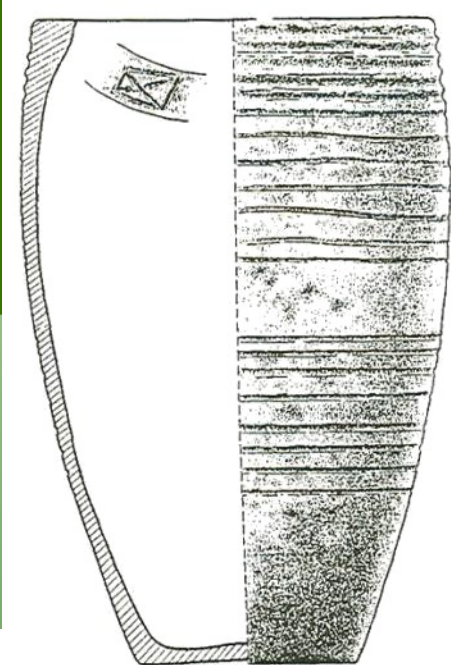
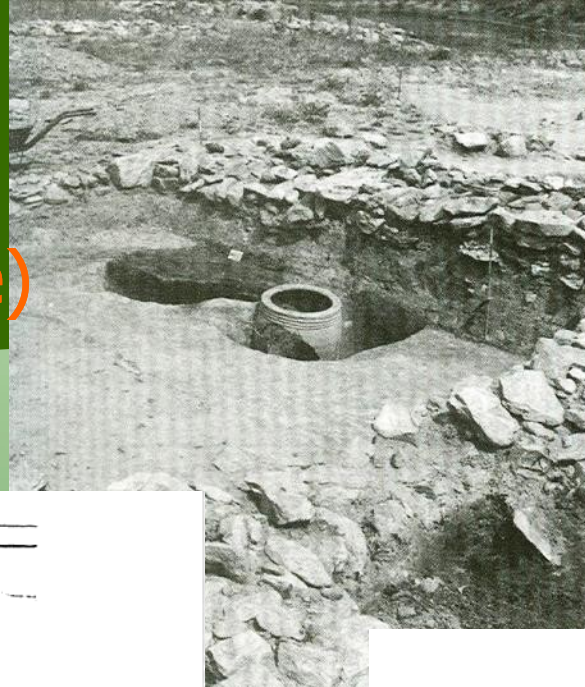



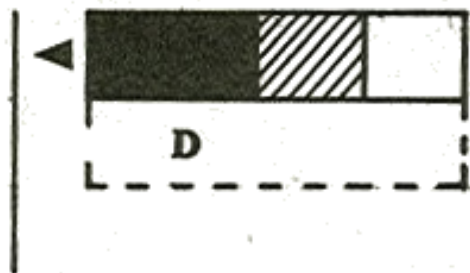

USEDLOST  
JEDNOTRAKTOVÁ -  
RADOVÁ

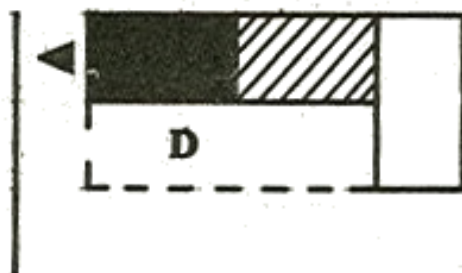

USEDLOST  
DVOUSTRANNÁ  
(HÁKOVÁ)

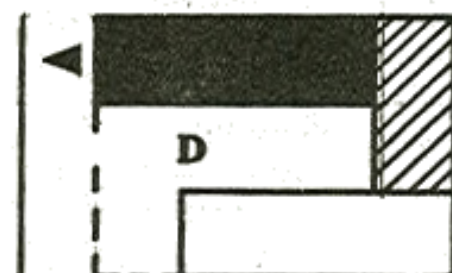

USEDLOST  
TROJSTRANNÁ  
(PODKOVOVITÁ)

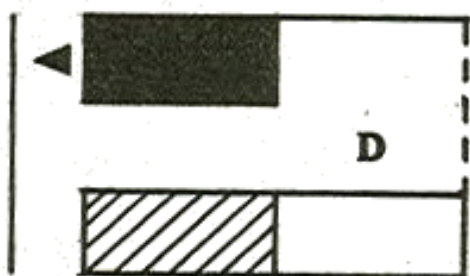

USEDLOST  
PÁROVA

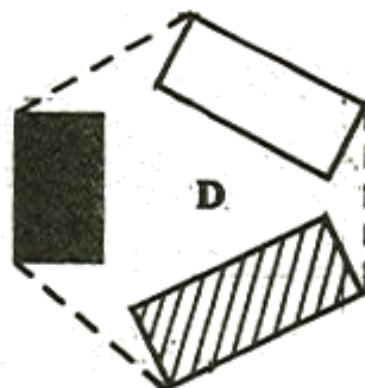

USEDLOST  
ROZPTÝLENÁ  
(HROMADNÁ)

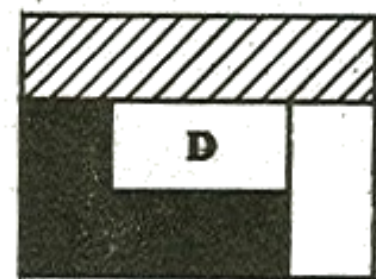

USEDLOST  
ČTYŘSTRANNÁ

 OBYTNÉ STAVENÍ

 CHLÉV

 STODOLA (KÚLNA)

**D**  
DVŮR

ŠIPKOU VYZNAČENA ORIENTACE  
(KE KOMUNIKACI NEBO K NÁVSI)



usedlost





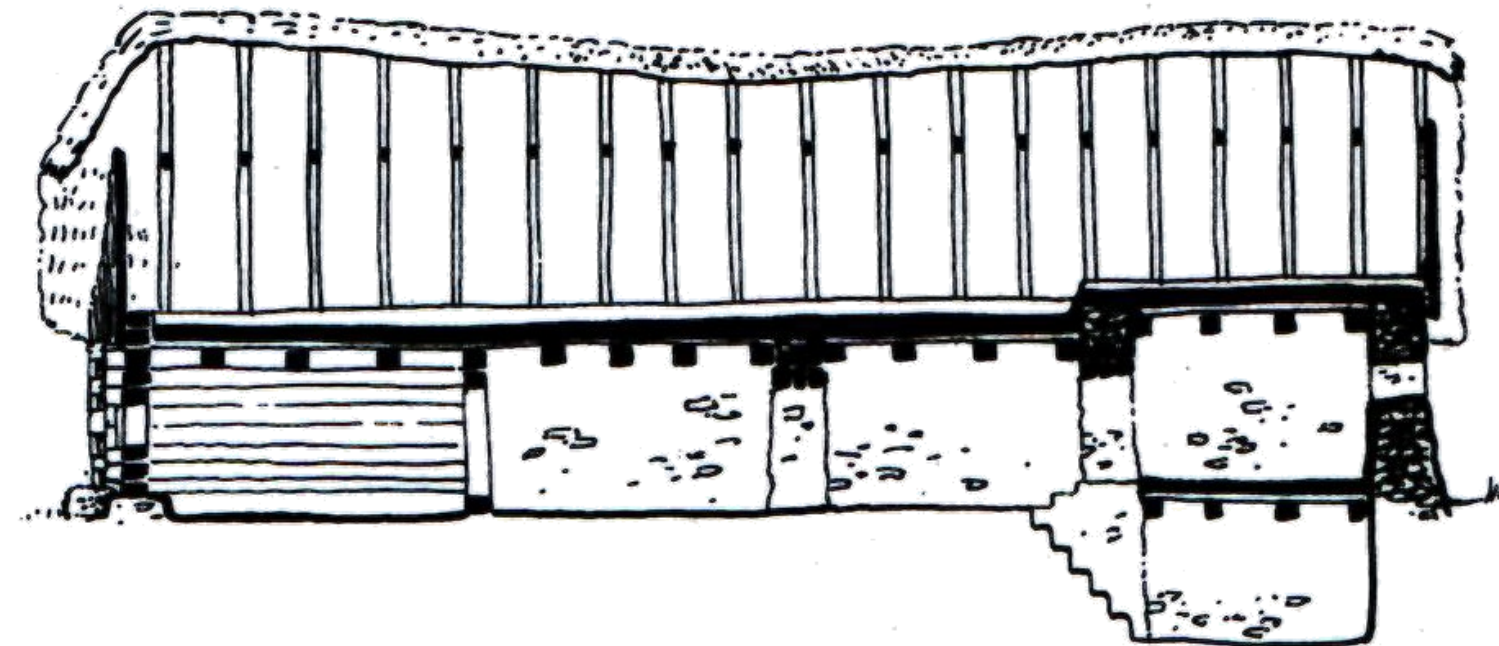
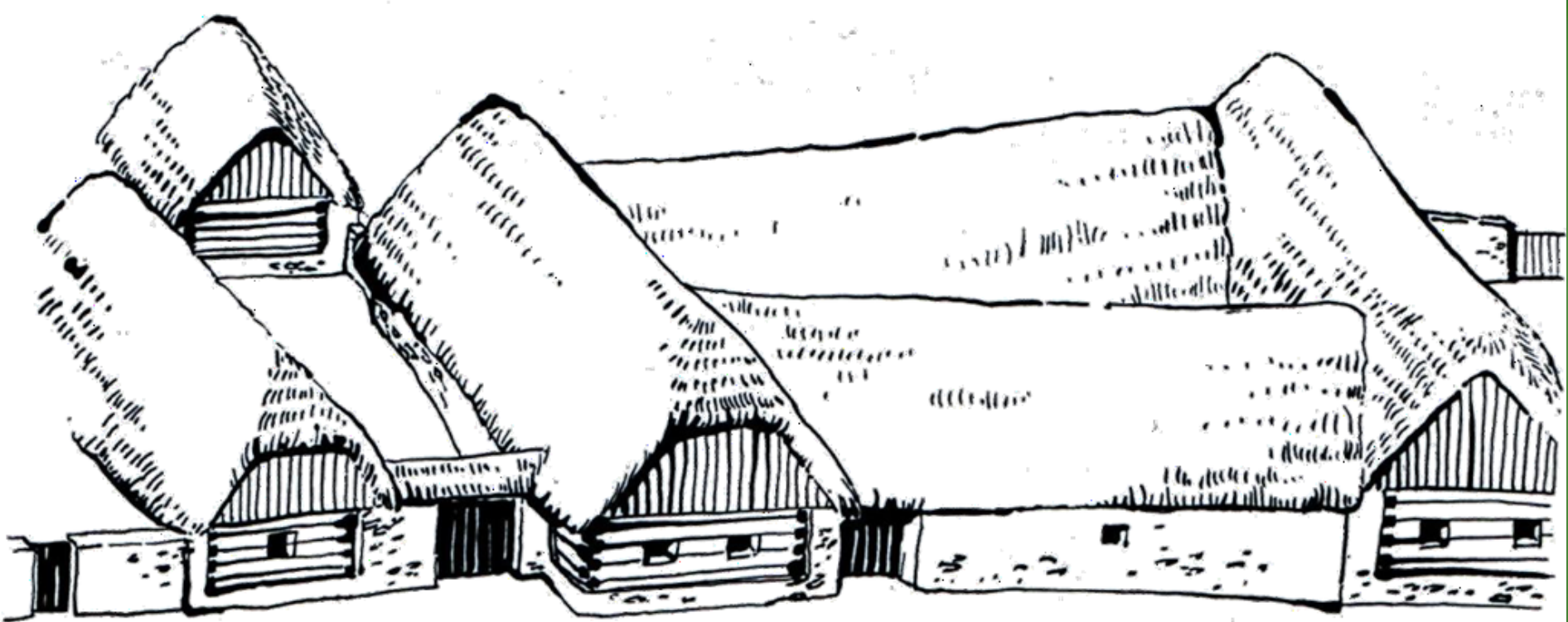

usedlost



# kovárna

- kovadlina
- výheň
- měch
- kladivo
- kleště







stoupa

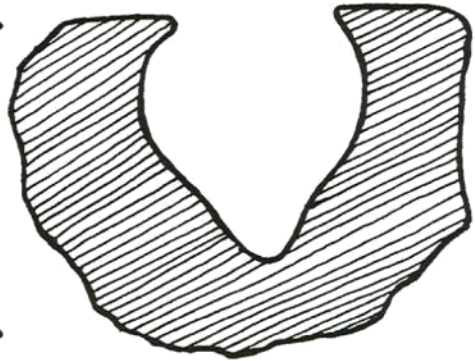
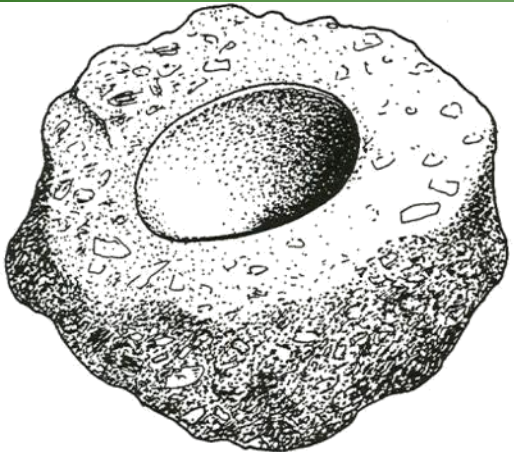

0 cm 50

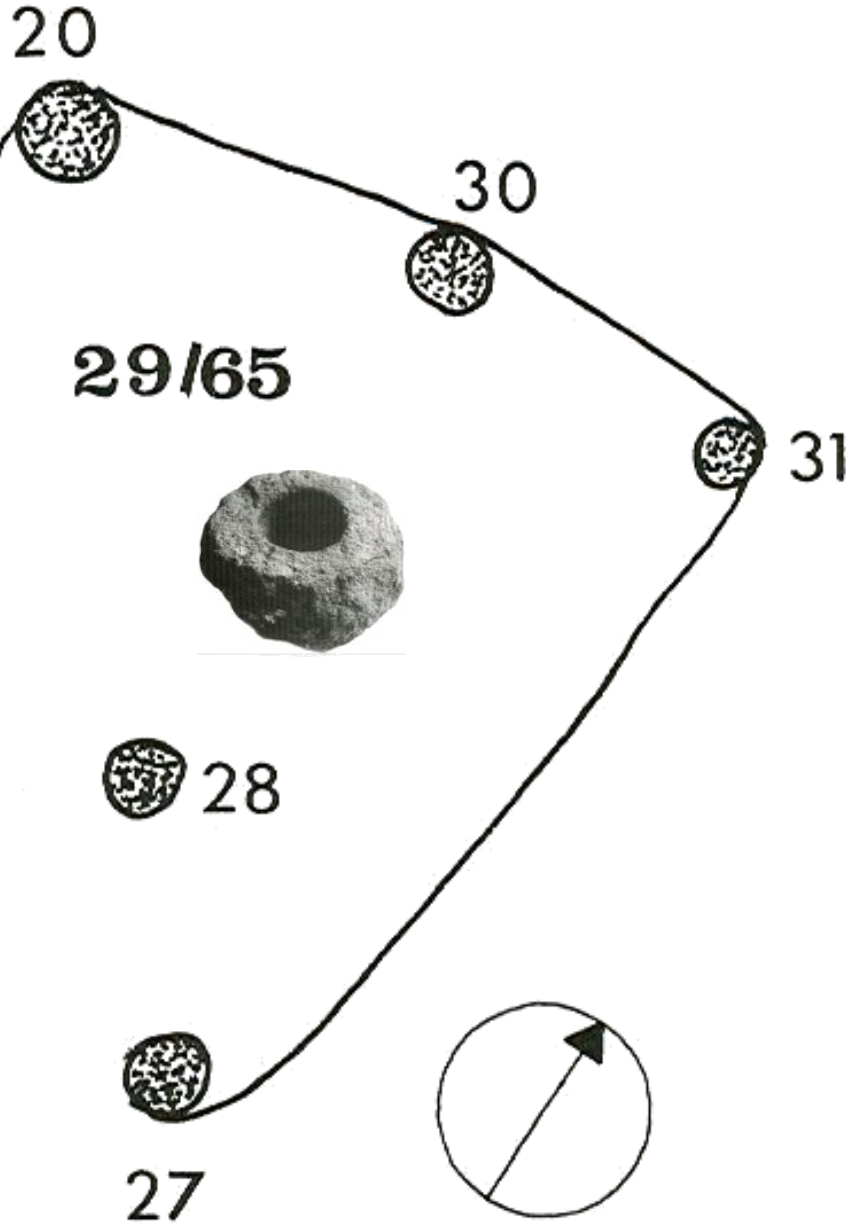

1 2 3 m

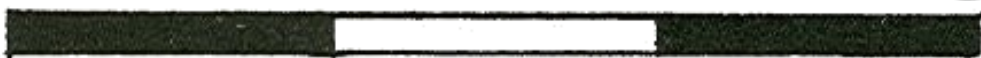



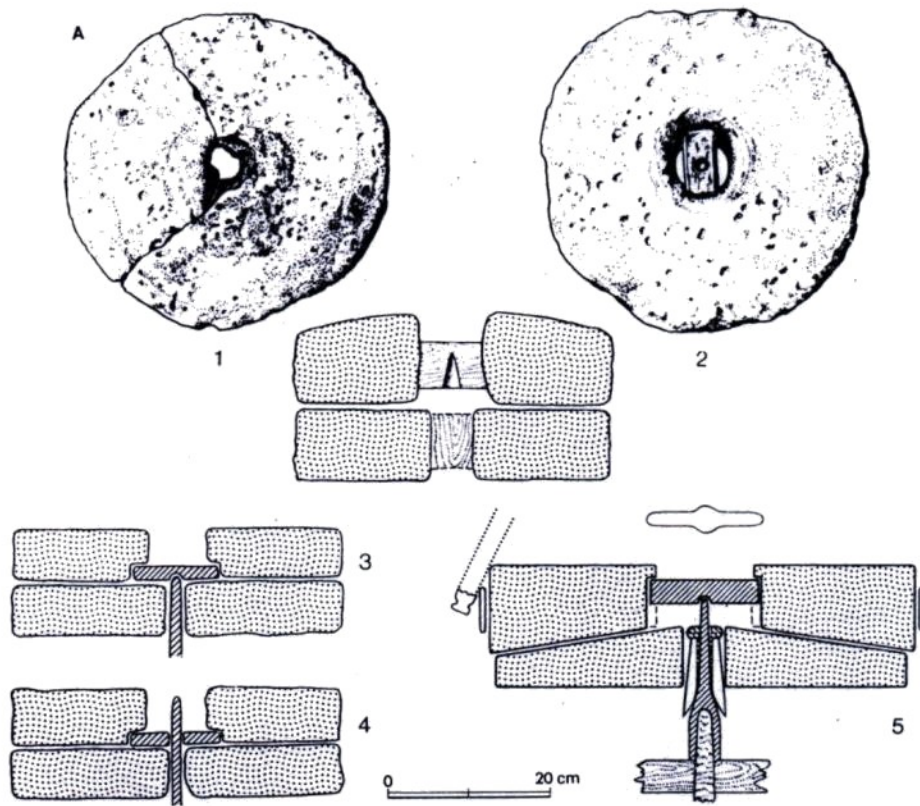

# ruční rotační mlýn

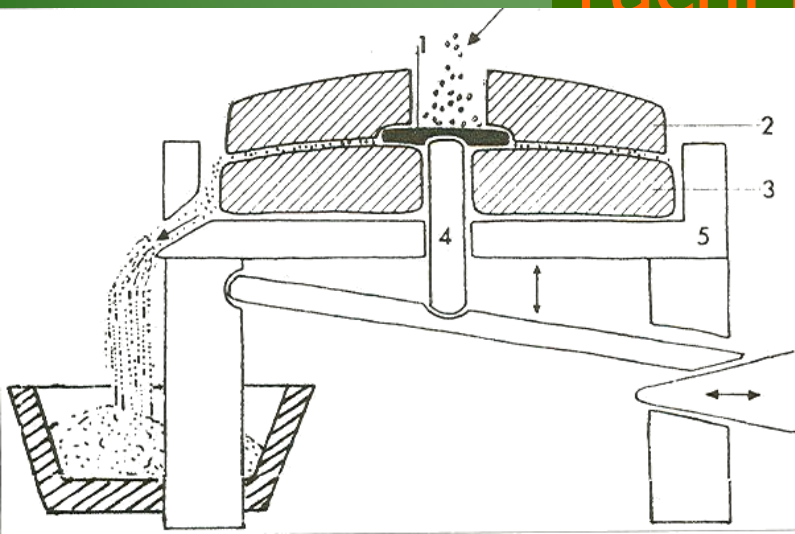



# vodní mlýn

- na spodní vodu (lopatkový)
- na svrchní vodu



nasýpací koš

běhoun

spodní kámen

paleční převod

paleční kolo

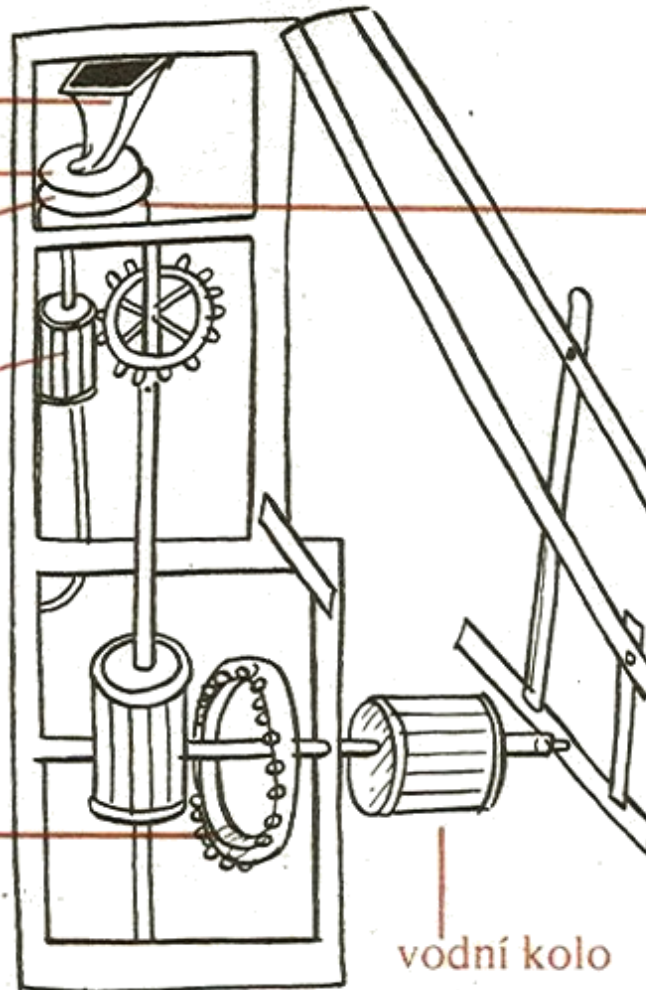

mlýnská stolice

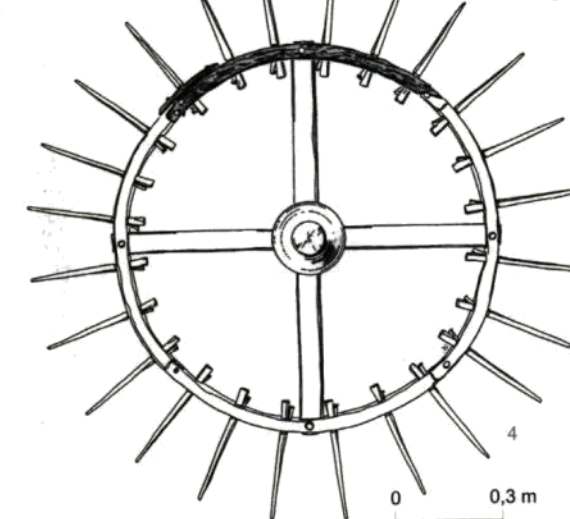

vodní kolo

0 0,3 m



# Conrad Kyeser: Belfortis, kolem 1440

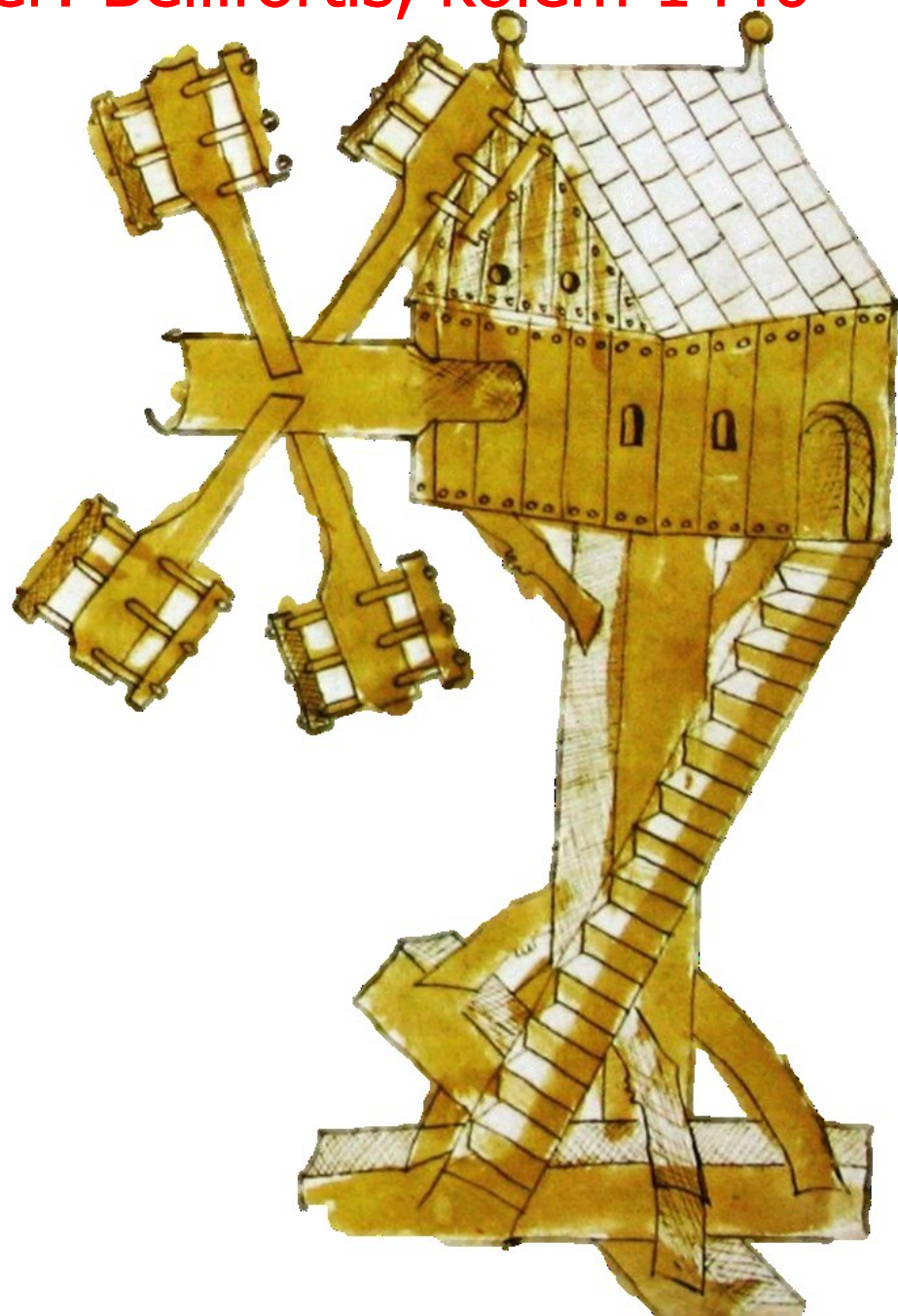
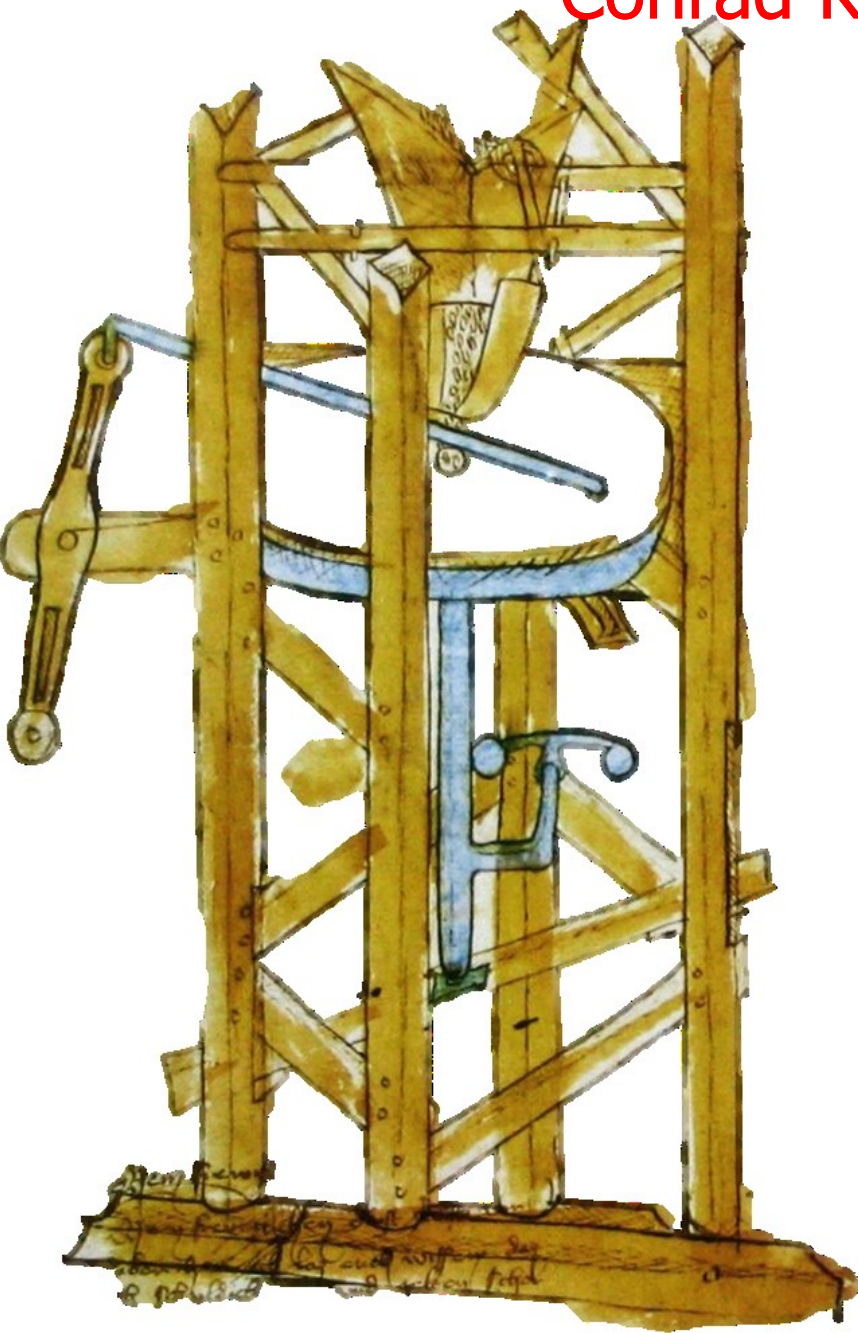



# větrný mlýn

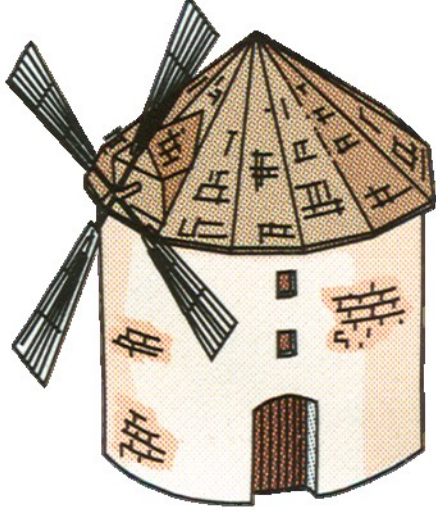
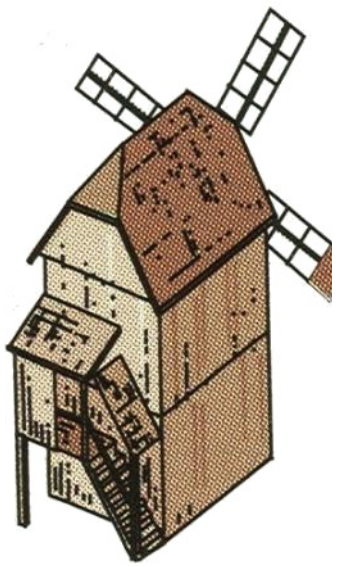

křídla (lopaty)

hřídel

lub (kryt mlýnských kamenů)

kláda k natáčení mlýna

kříž z trámů

paleční kolo

céví (kladnice)

násypka na obilí

apoštolé

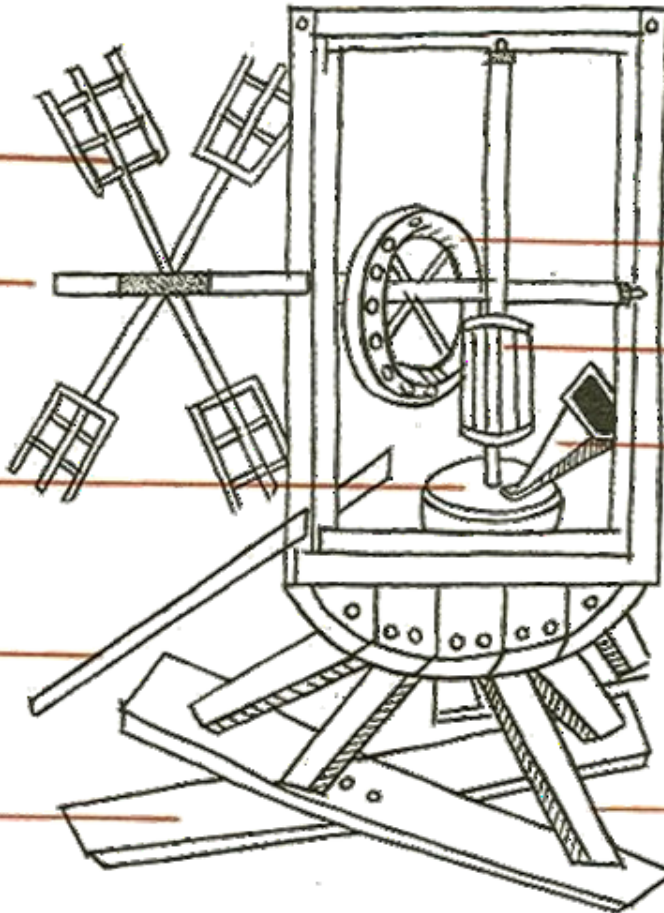





kalendáře – polní práce











sadařství



vinařství



vinařský nůž





vinařský lis

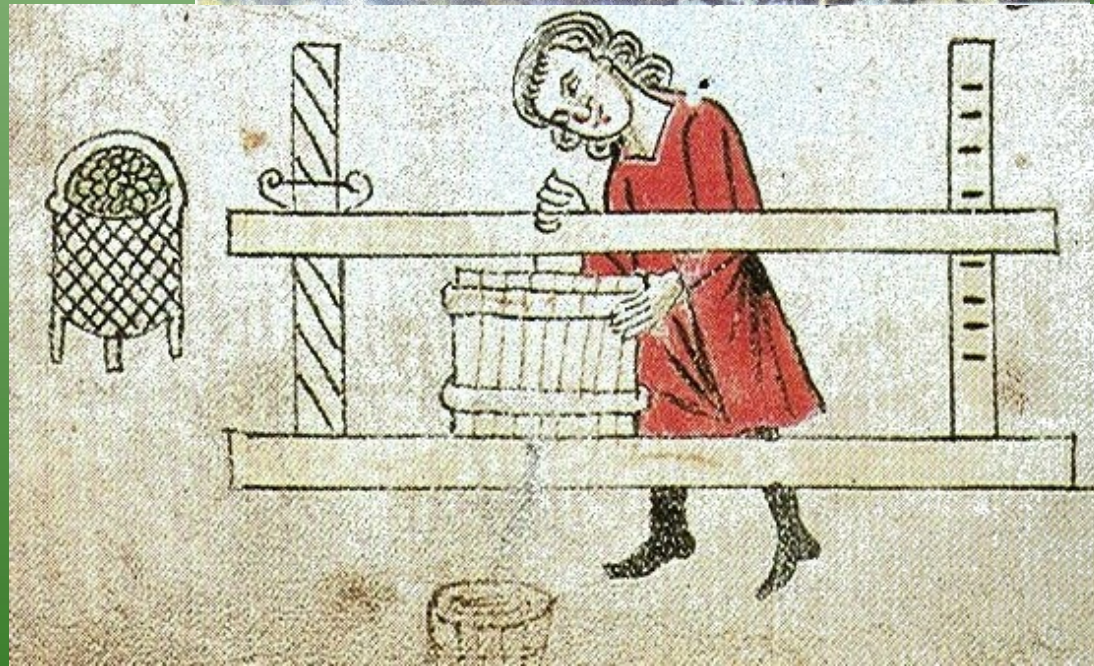





motyky





ryc



# drůbež







chov ovčí







šérové nůžky







hnojné vidle



# chov vepřů

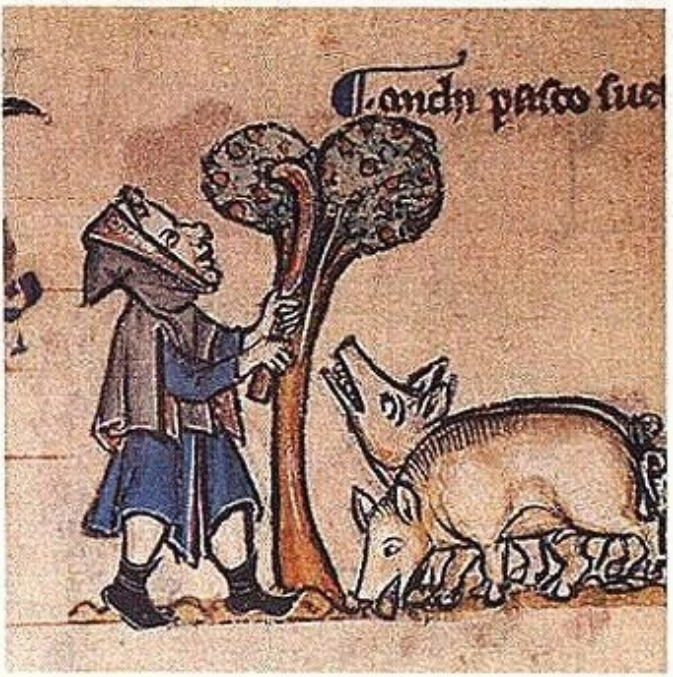



včelařství

brtr

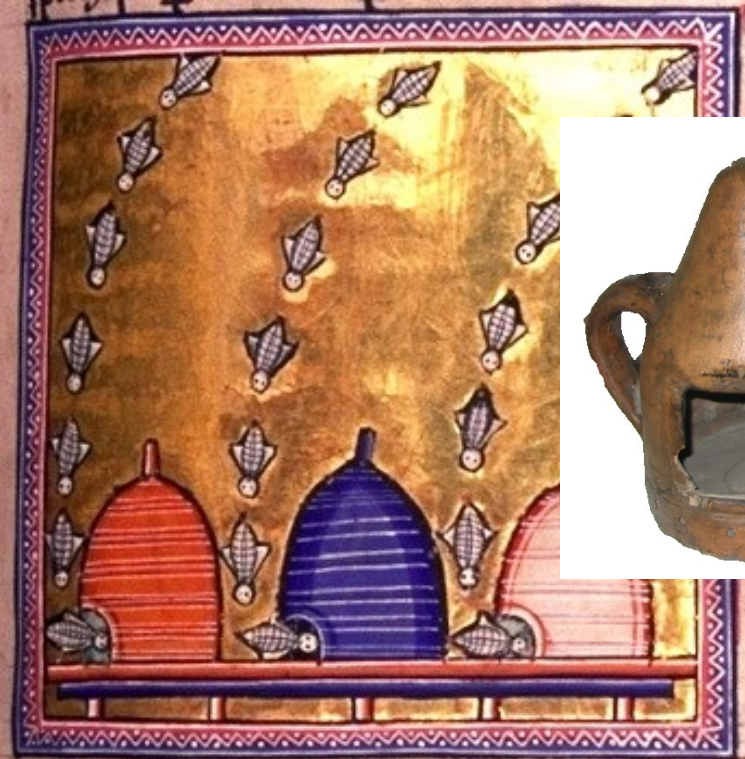
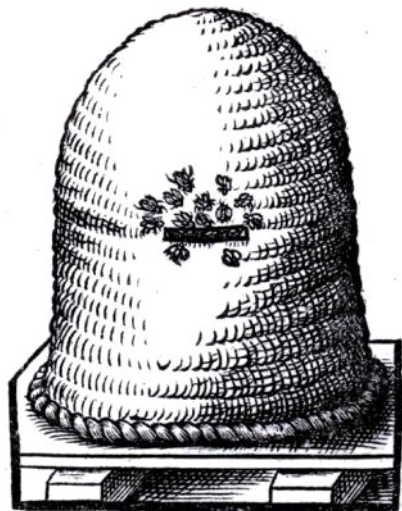



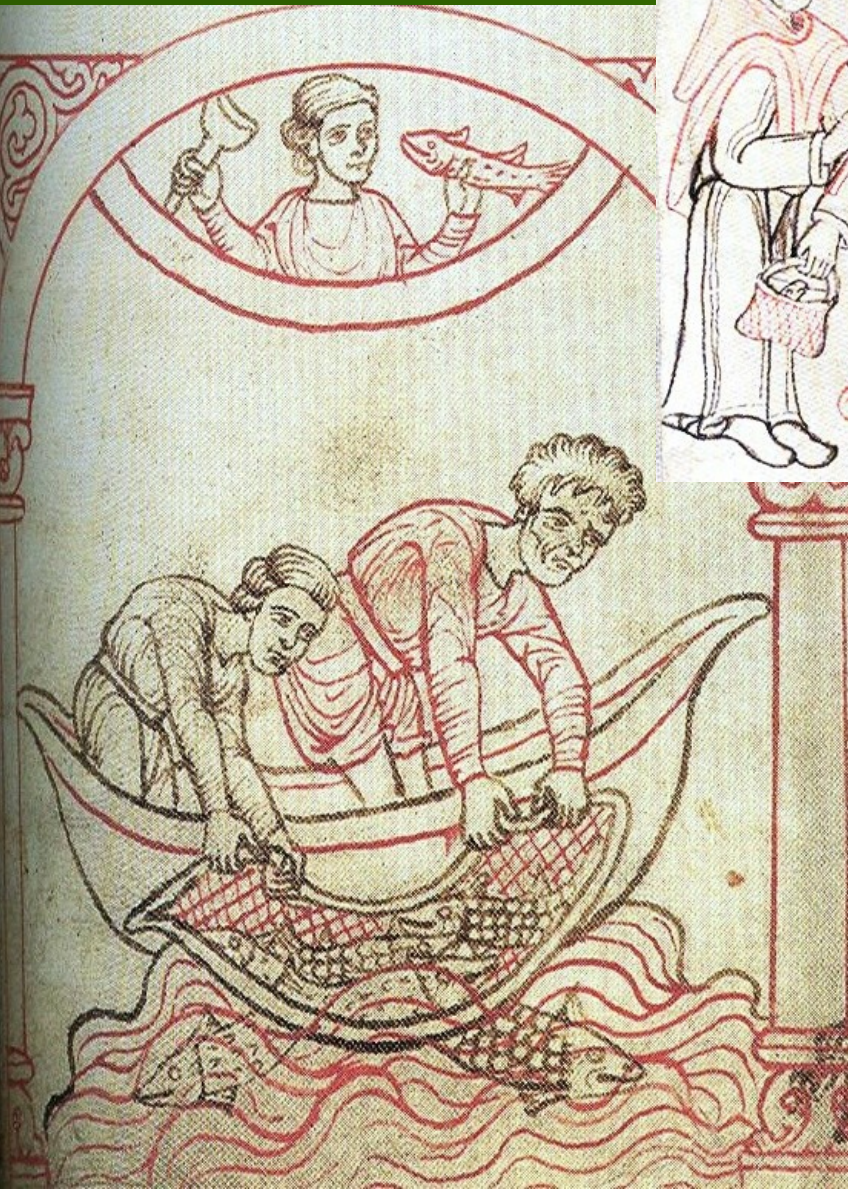

rybolov

- síť
- vrše
- udice



# zásobování dřevem

- lesy
- odlesňování
  - zemědělská půda
  - těžba rud
  - dřevěné uhlí
  - palivové dříví
  - stavební dřevo
- porosty
  - smrk
  - jedle, buk
  - jedle, dub, borovice
  - dub, habr, topol, jilm, jasan





magie, pověry

hromový  
kámen

