

Syntax

Pavel Caha

8 Nov 2021

Recap

Choosing between head-movement and affix hopping

Expletive insertion in more detail

Using an existing host

Sub-Strategy I: Affix Hopping

Using an existing host

Sub-Strategy I: Affix Hopping

Czech

Selecting the host

Question formation

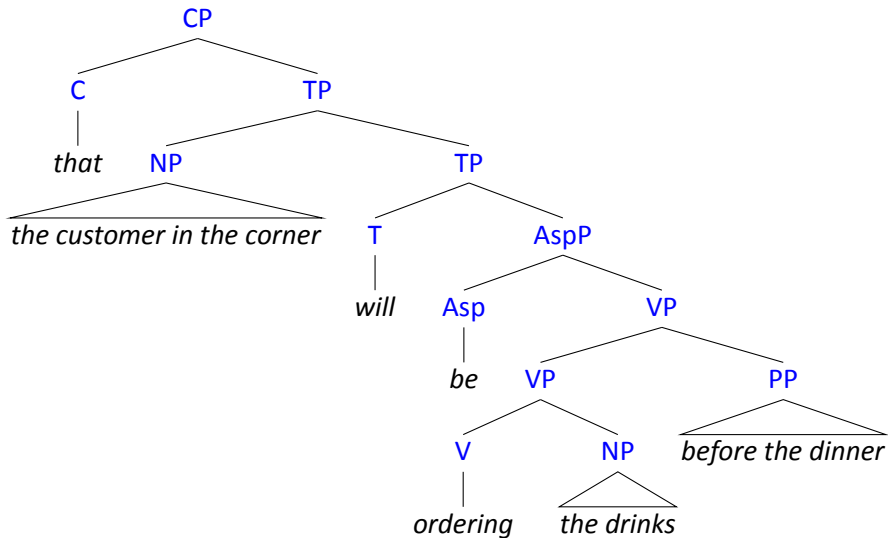

- (1)
- VP → describe an event
 - AspP → perspective: event seen from inside/outside
 - TP → anchor it in time with respect to the speech time
 - CP → the anchored event is a fact/wish/query/condition

ellipsis

- (2) A: The customer in the corner will order the drinks before the meal.
- (3) B: Actually, I wouldn't be so sure that he will —.

ellipsis

- (2) A: The customer in the corner will order the drinks before the meal.
- (3) B: Actually, I wouldn't be so sure that he will —.

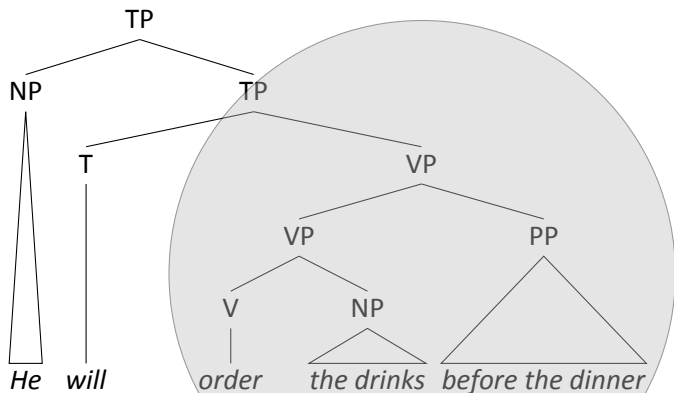

(4) A: The customer in the corner order-ed the drinks.

(4) A: The customer in the corner order-ed the drinks.

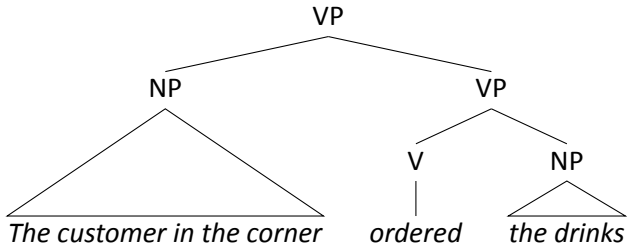

(4) A: The customer in the corner order-ed the drinks.

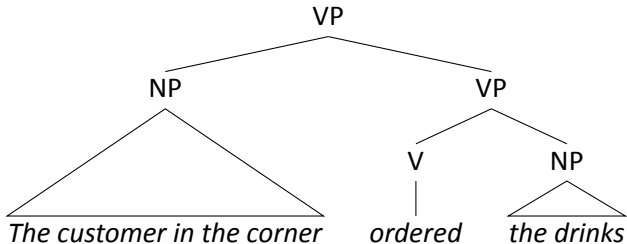

(5) B: *Actually, I wouldn't be so sure that he —.

(4) A: The customer in the corner order-**ed** the drinks.

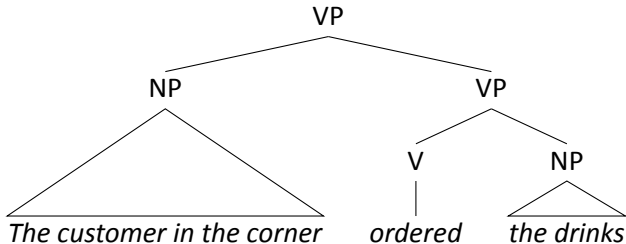

(5) B: *Actually, I wouldn't be so sure that he —.

(6) B: Actually, I wouldn't be so sure that he **did** —.

The sentence always has V and T

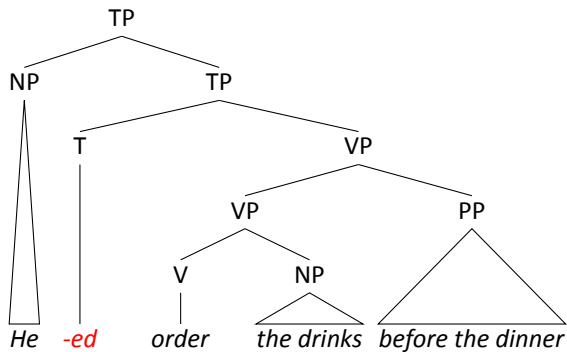

The sentence always has V and T

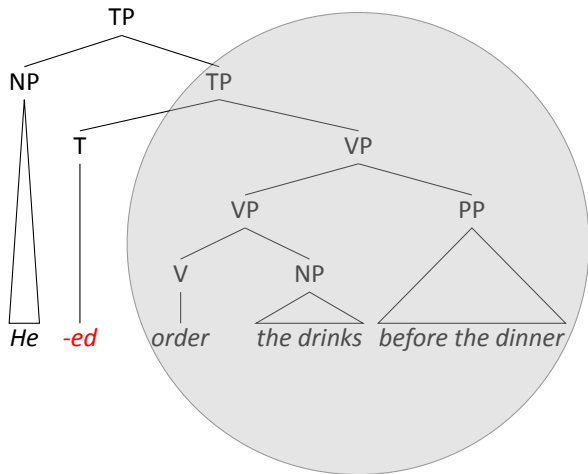

How are affixes treated by the grammar?

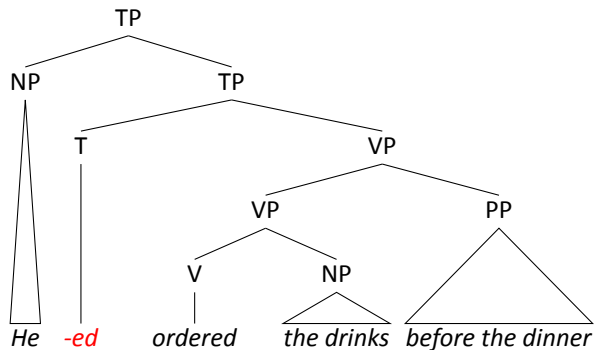

How are affixes treated by the grammar?

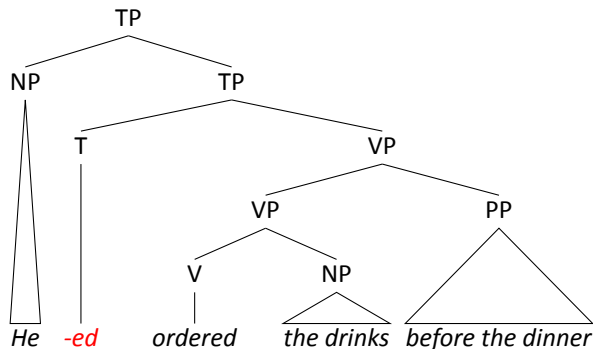

- (7) When a head is expressed by an affix, syntax must provide a host for that affix.

How are affixes treated by the grammar?

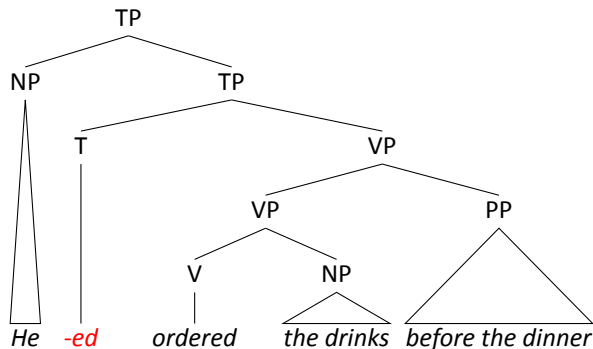

- (7) When a head is expressed by an affix, syntax must provide a host for that affix.
- Strategy 1: insert an expletive

How are affixes treated by the grammar?

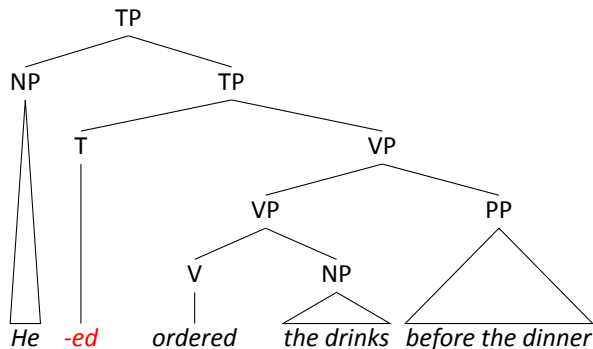

- (7) When a head is expressed by an affix, syntax must provide a host for that affix.
- Strategy 1: insert an expletive
He **d**-**ed** order the drinks.

How are affixes treated by the grammar?

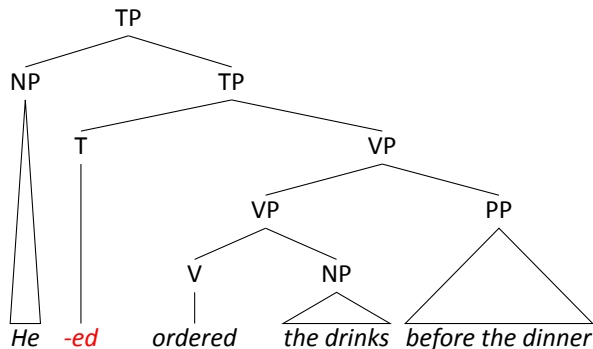

- (7) When a head is expressed by an affix, syntax must provide a host for that affix.
- Strategy 1: insert an expletive
He **d**-**ed** order the drinks.
 - Strategy 2: use an existing host

How are affixes treated by the grammar?

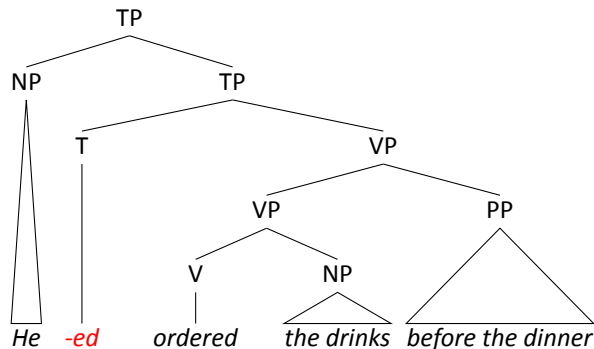

- (7) When a head is expressed by an affix, syntax must provide a host for that affix.
- Strategy 1: insert an expletive
He **d**-**ed** order the drinks.
 - Strategy 2: use an existing host
He **order**-**ed** the drinks.

Rescue 1: Expletive insertion

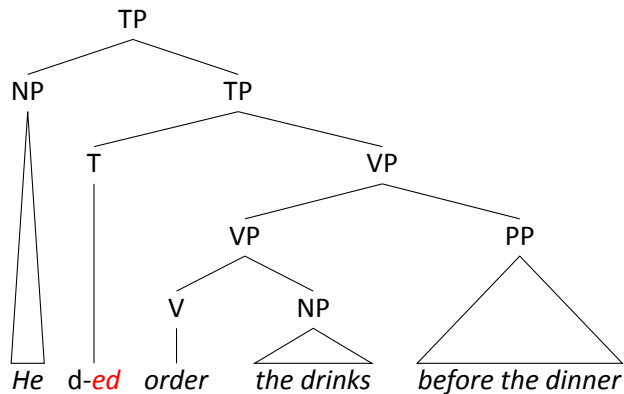

Rescue 2a: Affix Hopping

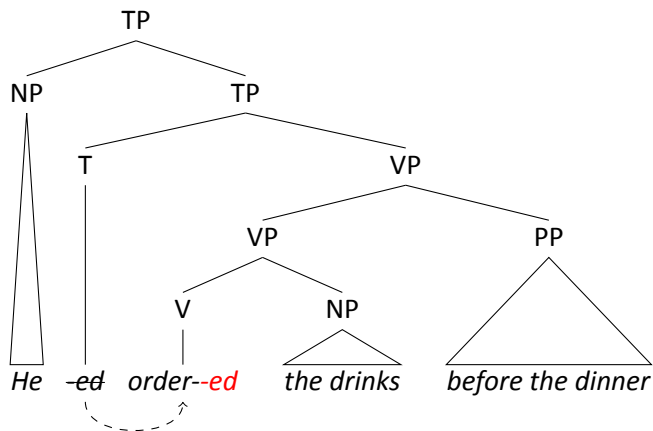

Rescue 2b: Head movement

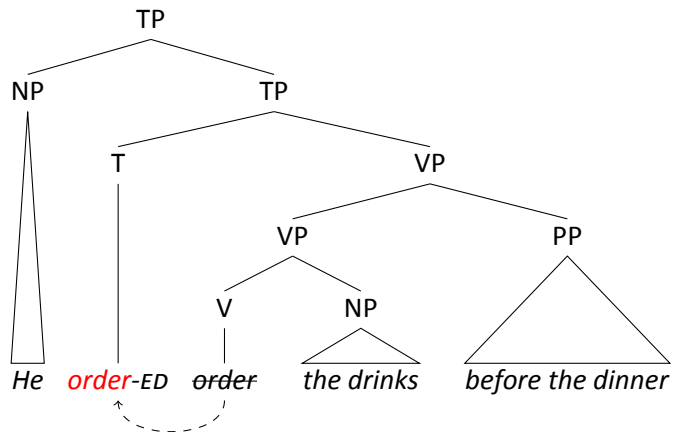

Recap

Choosing between head-movement and affix hopping

Expletive insertion in more detail

Using an existing host

Sub-Strategy I: Affix Hopping

Using an existing host

Sub-Strategy I: Affix Hopping

Czech

Selecting the host

Question formation

Introducing an adverb

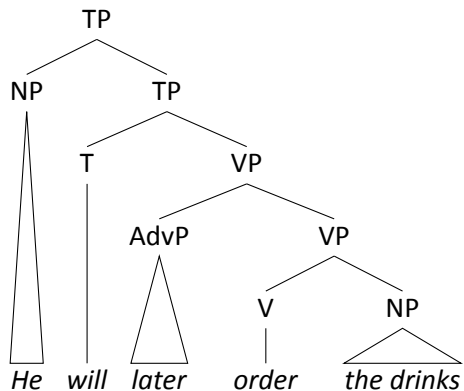

Adverb and lowering

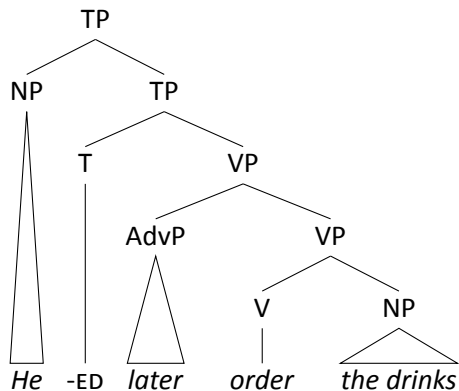

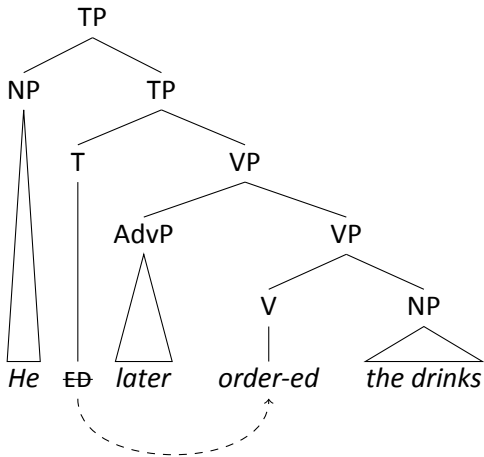

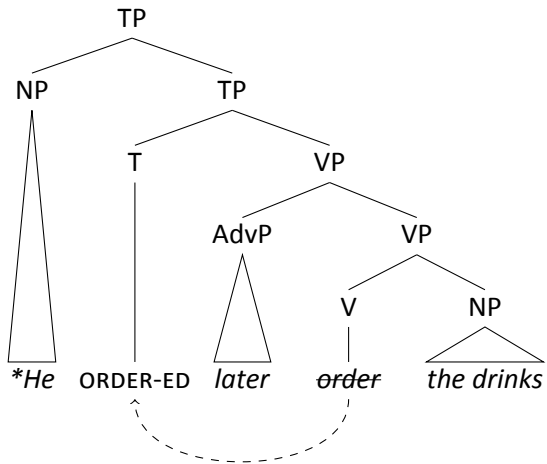

French

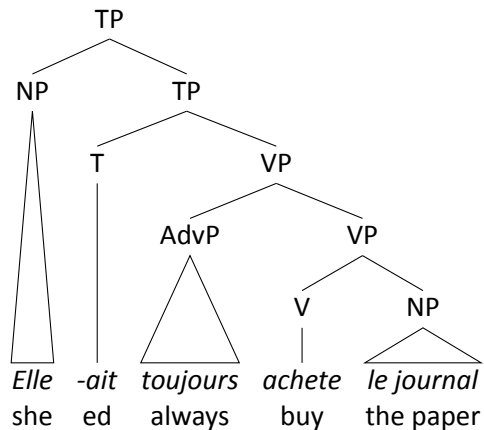

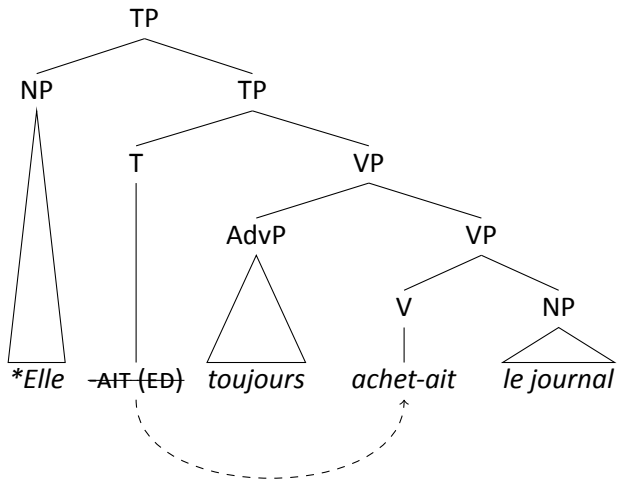

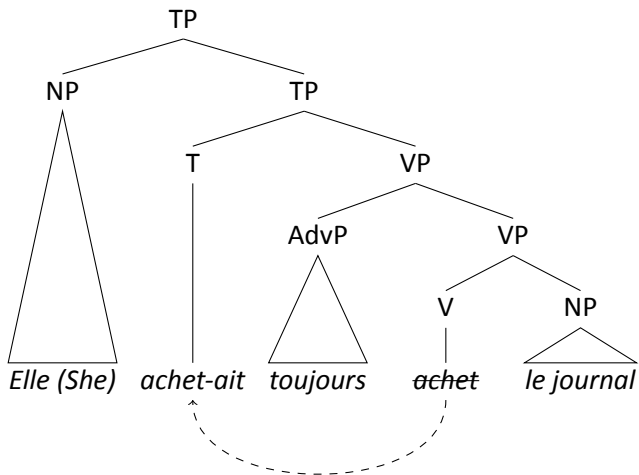

Summary

(8) When a head is an affix...

Summary

- (8) When a head is an affix...
 - a. Rescue 1: insert an expletive

Summary

- (8) When a head is an affix...
 - a. Rescue 1: insert an expletive
 - b. Rescue 2: move something

Summary

- (8) When a head is an affix...
 - a. Rescue 1: insert an expletive
 - b. Rescue 2: move something
 - (i) move the affix = affix hopping

Summary

- (8) When a head is an affix...
 - a. Rescue 1: insert an expletive
 - b. Rescue 2: move something
 - (i) move the affix = affix hopping
 - (ii) move the host = head movement

Recap

Choosing between head-movement and affix hopping

Expletive insertion in more detail

Using an existing host

Sub-Strategy I: Affix Hopping

Using an existing host

Sub-Strategy I: Affix Hopping

Czech

Selecting the host

Question formation

Do-support

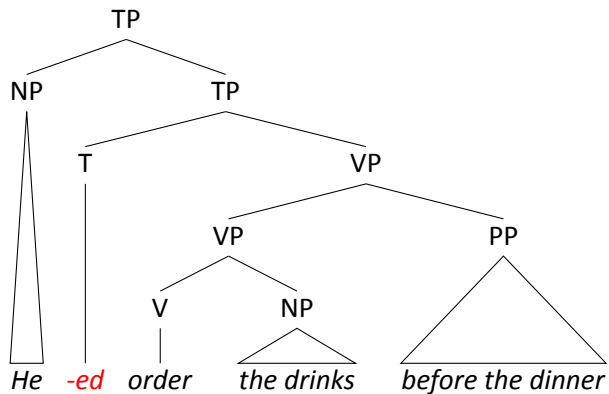

Do-support

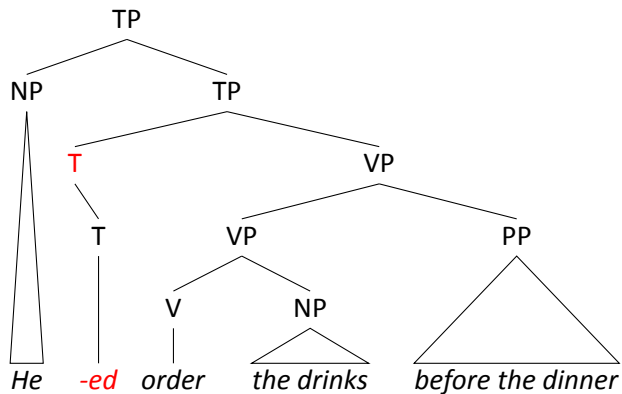

Do-support

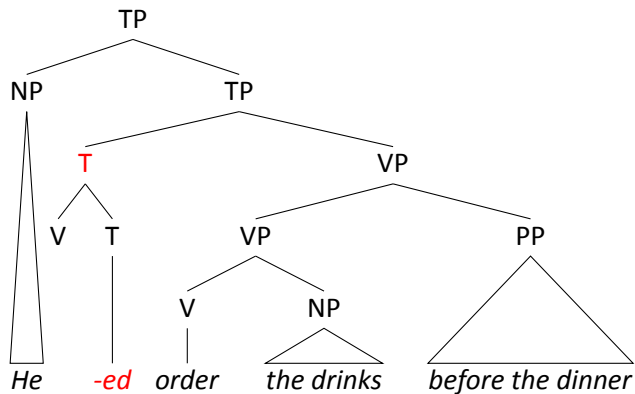

Do-support

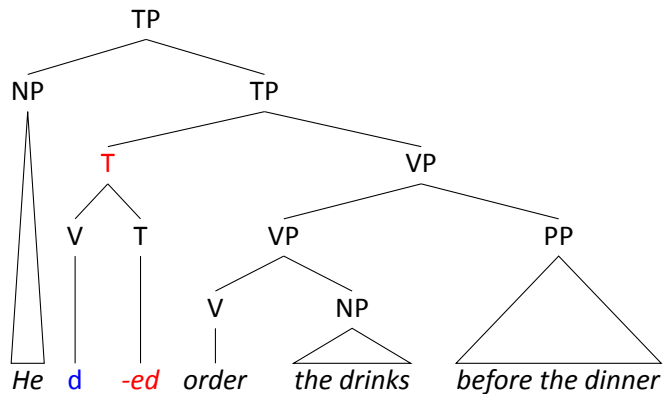

Do-support

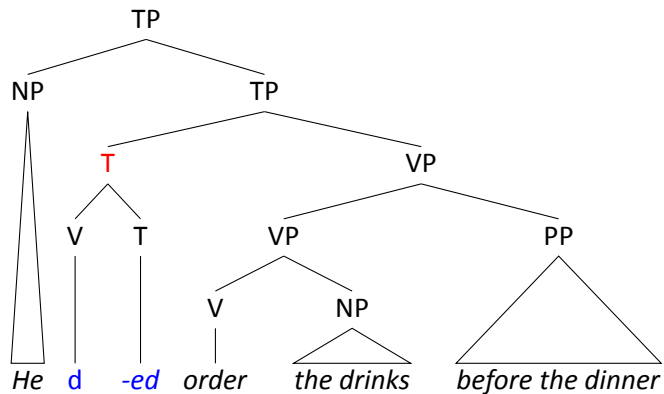

Recap

Choosing between head-movement and affix hopping

Expletive insertion in more detail

Using an existing host

Sub-Strategy I: Affix Hopping

Using an existing host

Sub-Strategy I: Affix Hopping

Czech

Selecting the host

Question formation

Sub-Strategy I: Affix Hopping

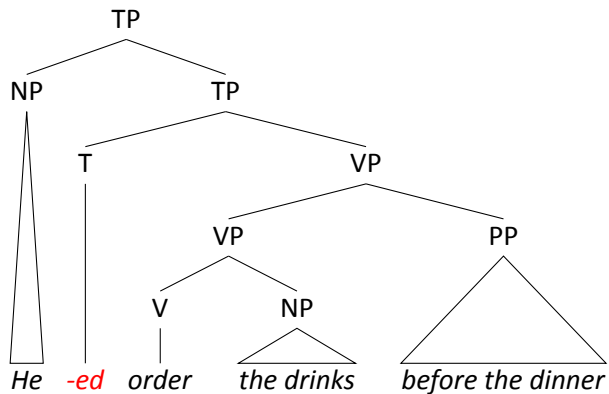

Sub-Strategy I: Affix Hopping

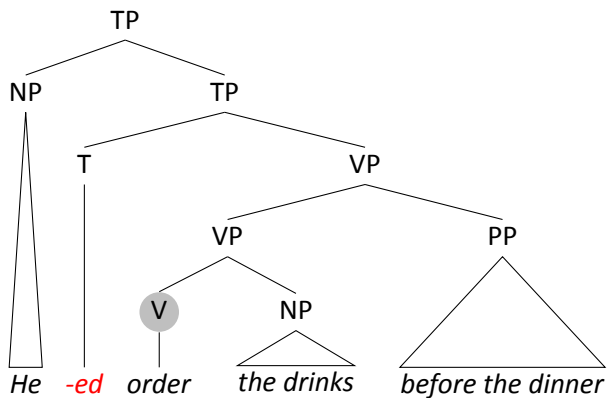

Sub-Strategy I: Affix Hopping

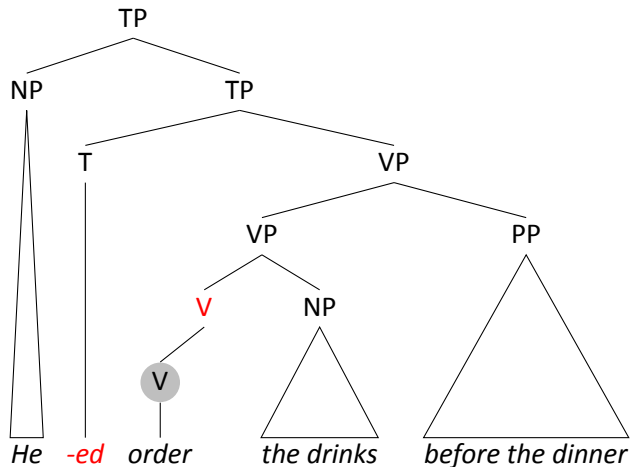

Sub-Strategy I: Affix Hopping

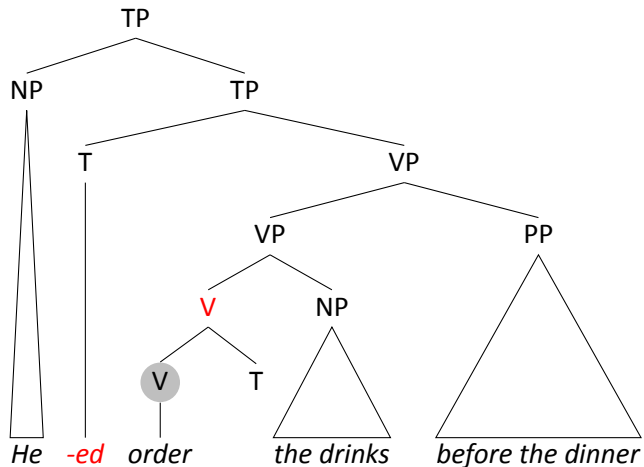

Sub-Strategy I: Affix Hopping

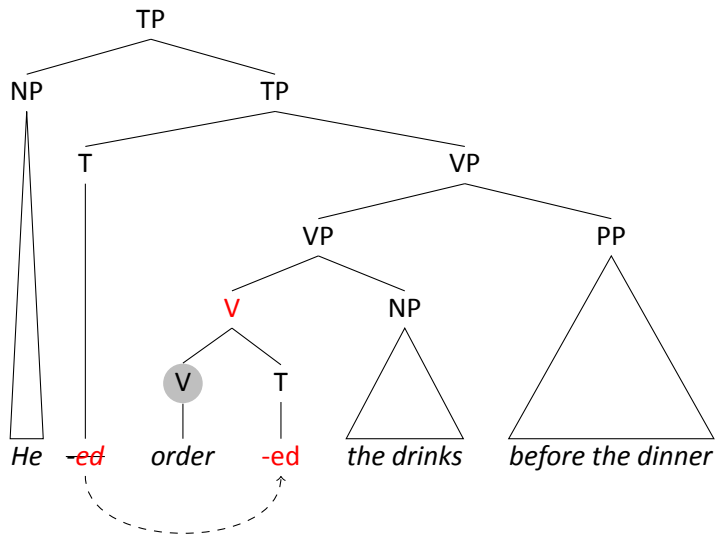

Sub-Strategy I: Affix Hopping

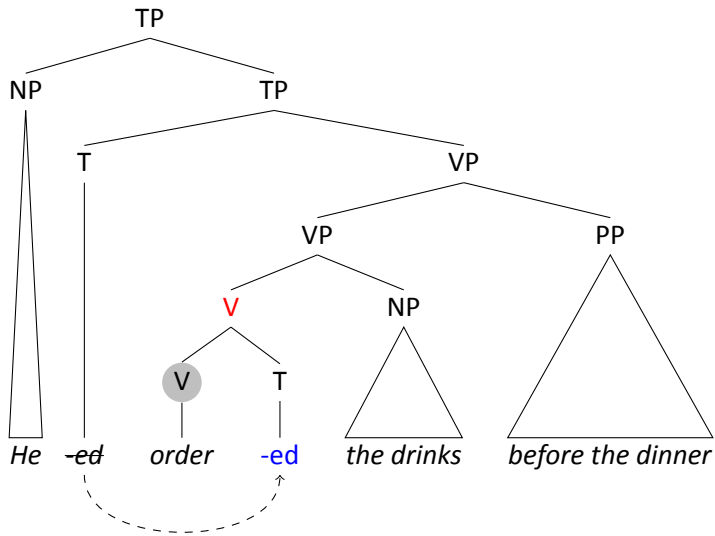

Introducing an adverb

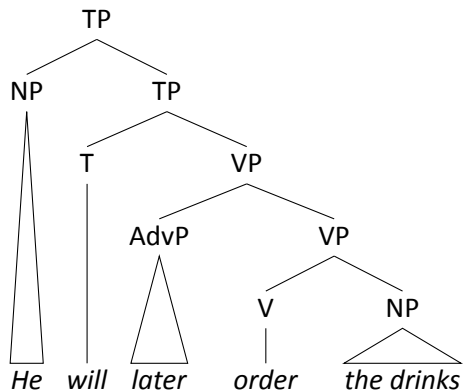

Adverb and lowering

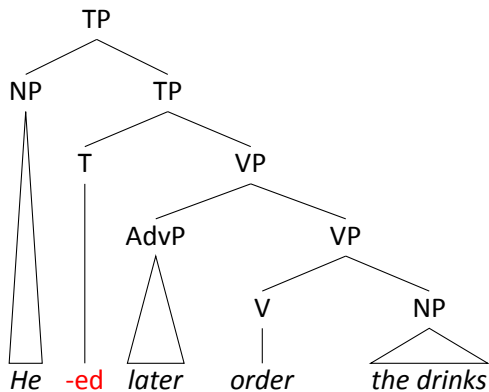

Adverb and lowering

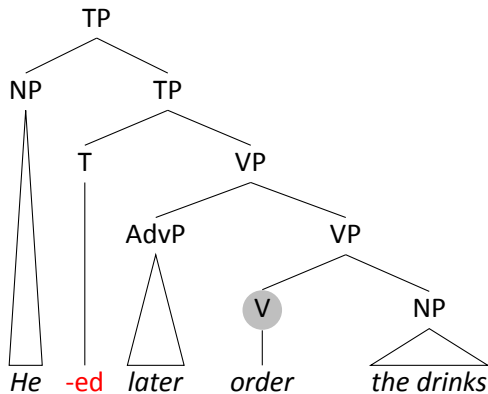

Adverb and affix hopping

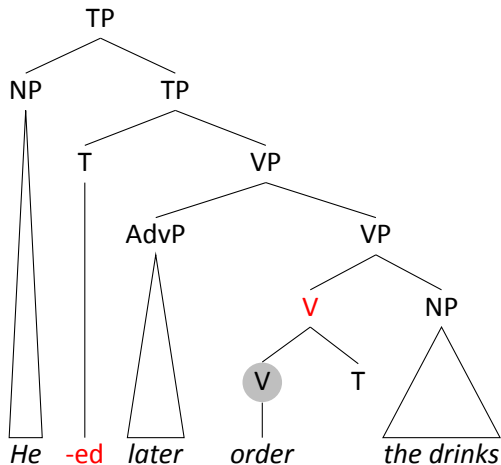

Adverb and affix hopping

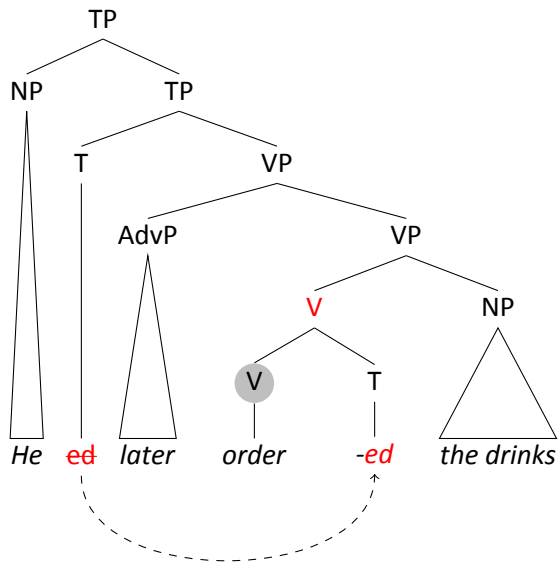

Adverb and affix hopping

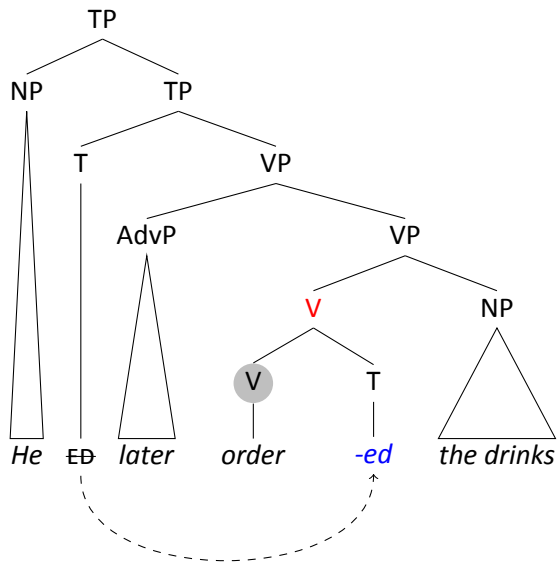

Recap

Choosing between head-movement and affix hopping

Expletive insertion in more detail

Using an existing host

Sub-Strategy I: Affix Hopping

Using an existing host

Sub-Strategy I: Affix Hopping

Czech

Selecting the host

Question formation

Sub-strategy II: Head movement

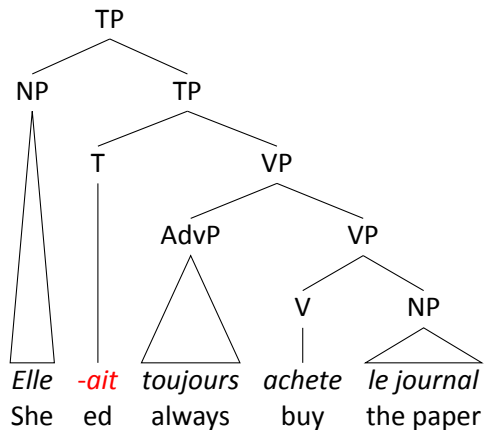

Sub-strategy II: Head movement

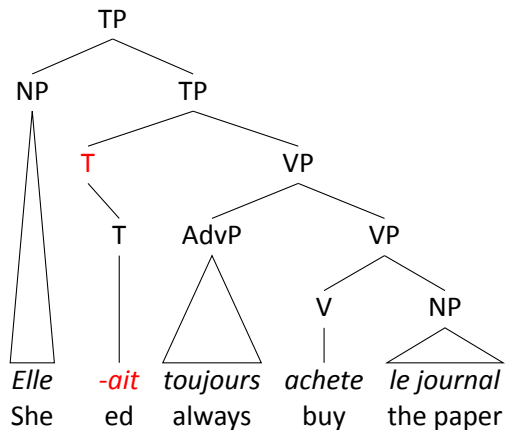

Sub-strategy II: Head movement

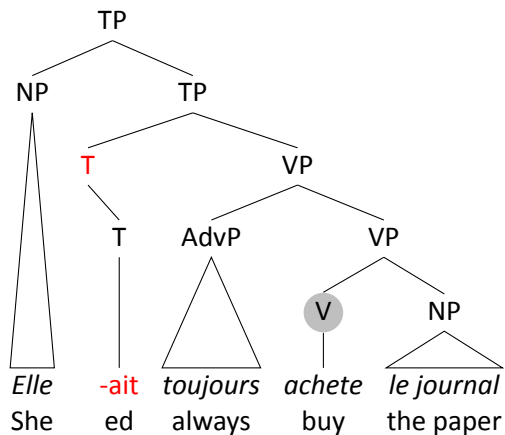

Sub-strategy II: Head movement

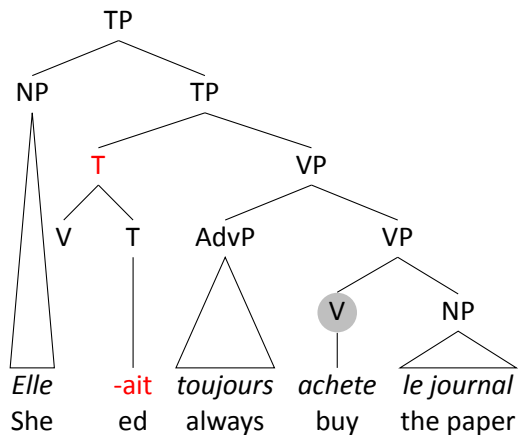

Sub-strategy II: Head movement

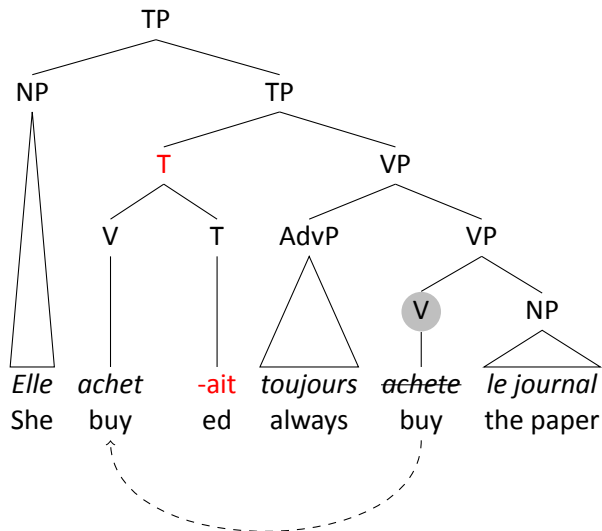

Sub-strategy II: Head movement

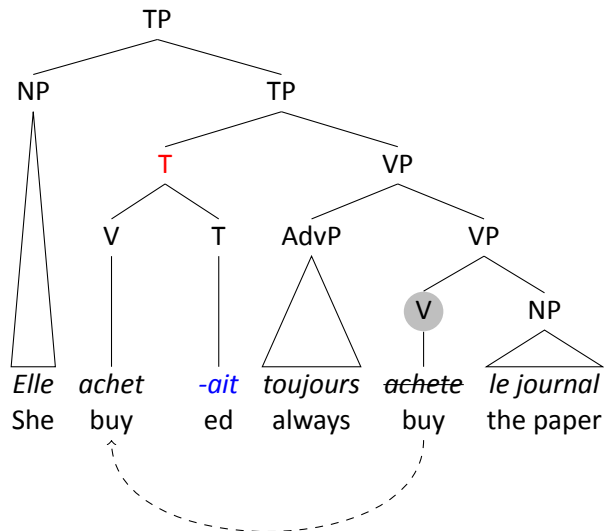

Recap

Choosing between head-movement and affix hopping

Expletive insertion in more detail

Using an existing host

Sub-Strategy I: Affix Hopping

Using an existing host

Sub-Strategy I: Affix Hopping

Czech

Selecting the host

Question formation

Future tense

- (9) Petr bude muset číst knihy.
Petr will have.to read books

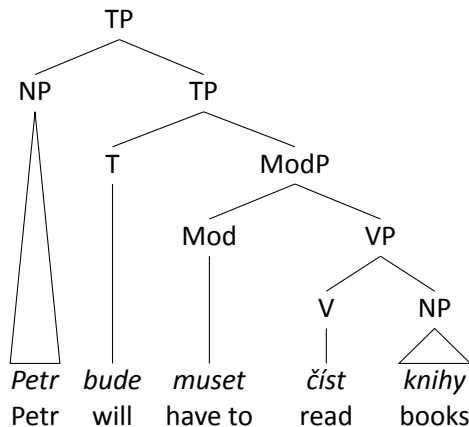

(10) Conditional

- a. **Jest -li** Petr **bude** muset číst knih-y
be -IF Petr have.to-INF read-INF books
'if Petr reads books, ...'

(10) Conditional

- a. **Jest -li** Petr **bude** muset číst knih-y
be -IF Petr have.to-INF read-INF books
'if Petr reads books, ...'
- b. **Bude -li** Petr muset číst knihy, ...
will -IF Petr have.to read books

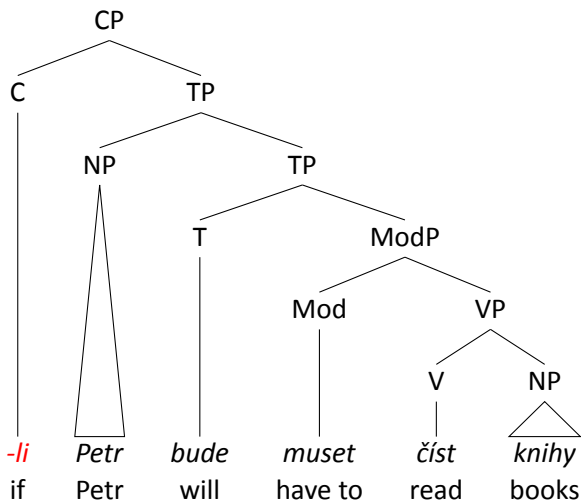

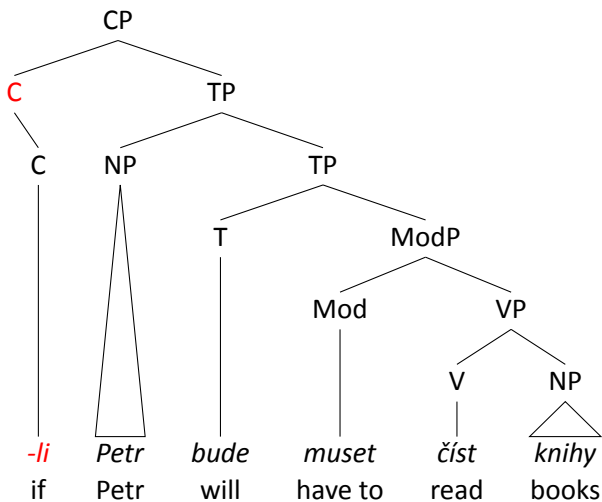

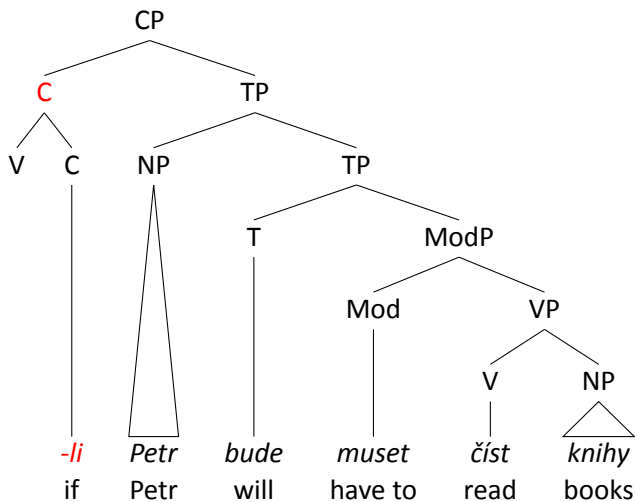

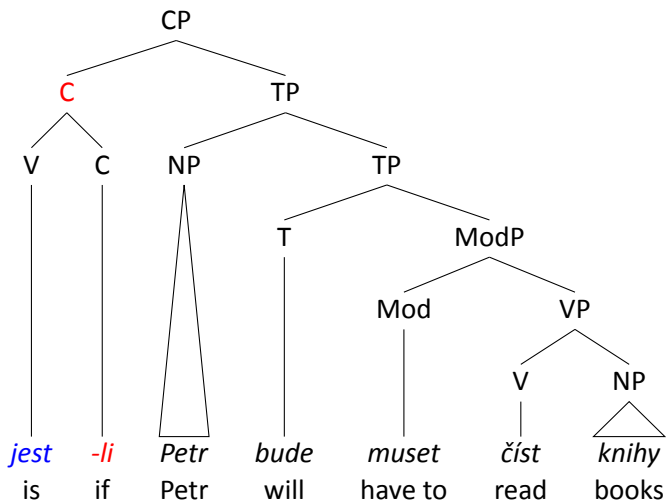

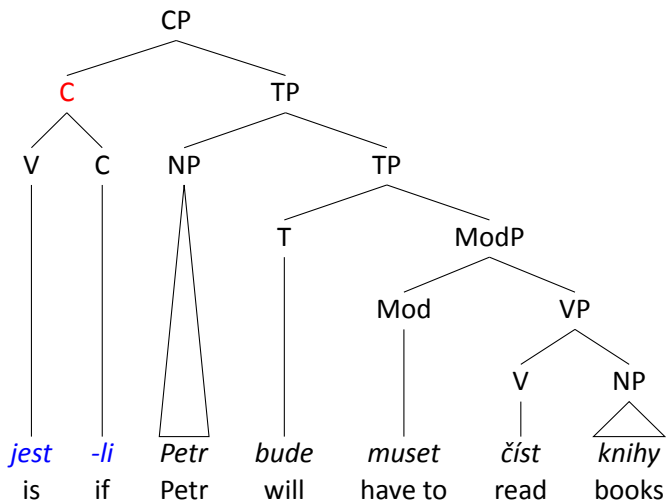

Recap

Choosing between head-movement and affix hopping

Expletive insertion in more detail

Using an existing host

Sub-Strategy I: Affix Hopping

Using an existing host

Sub-Strategy I: Affix Hopping

Czech

Selecting the host

Question formation

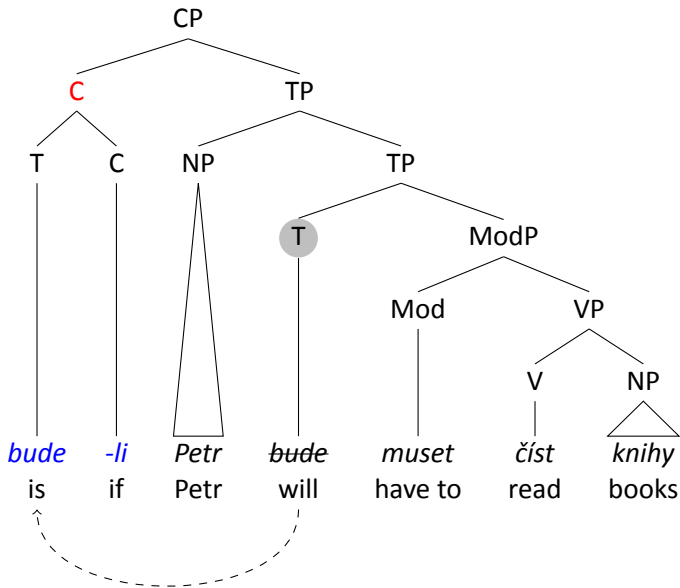

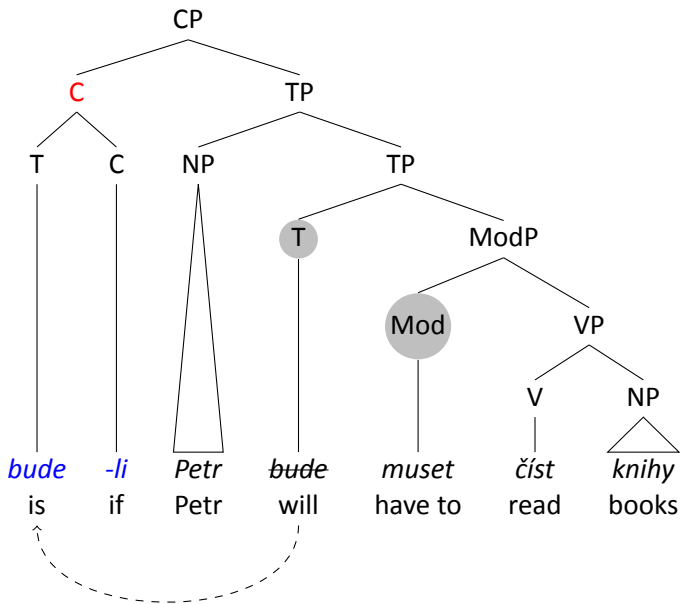

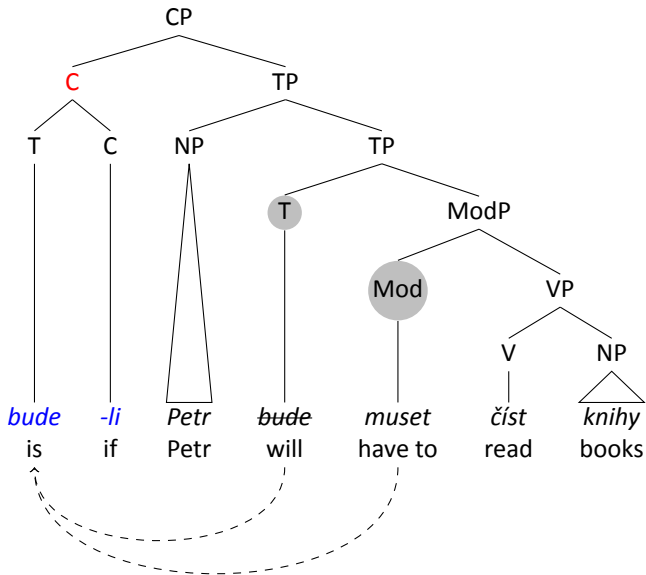

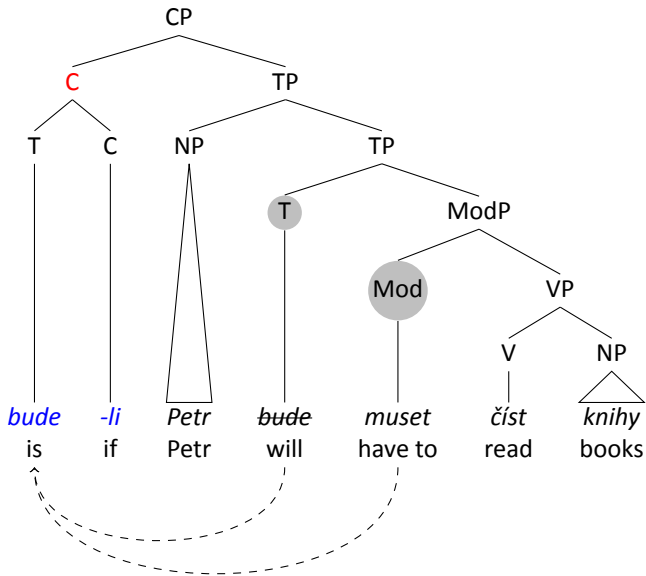

- (11) a. *Muset- li Petr bude číst knihy, ...
 read -if Petr will books, ...

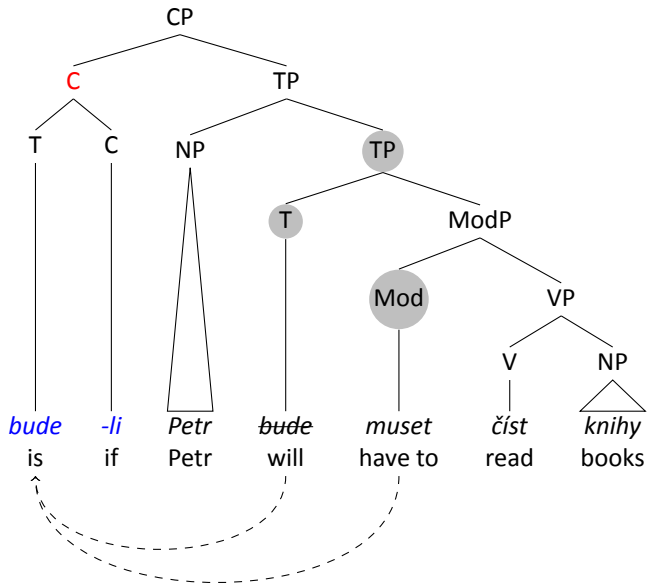

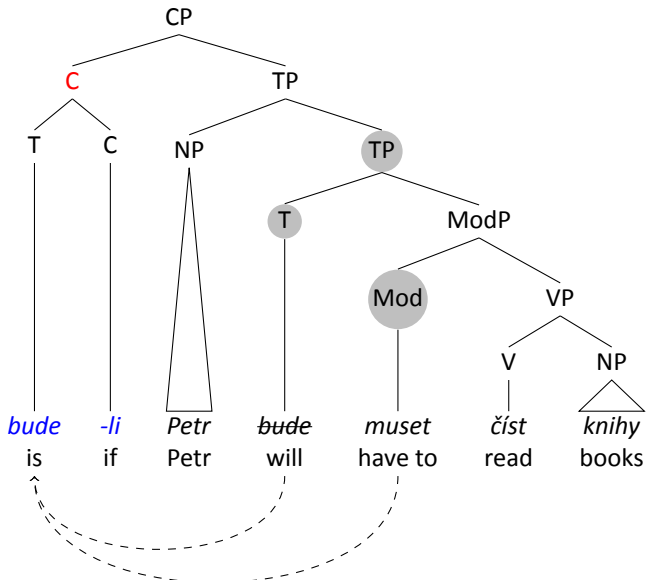

- (12) a. *Muset-li Petr bude číst knihy, ...
 read -if Petr will books, ...

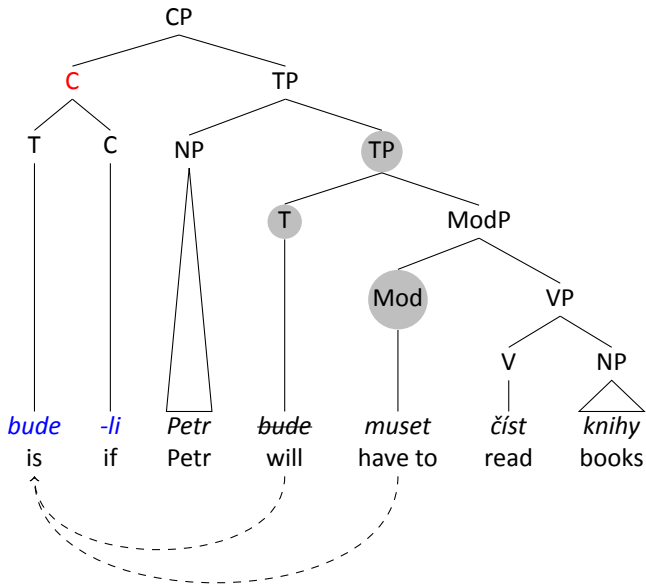

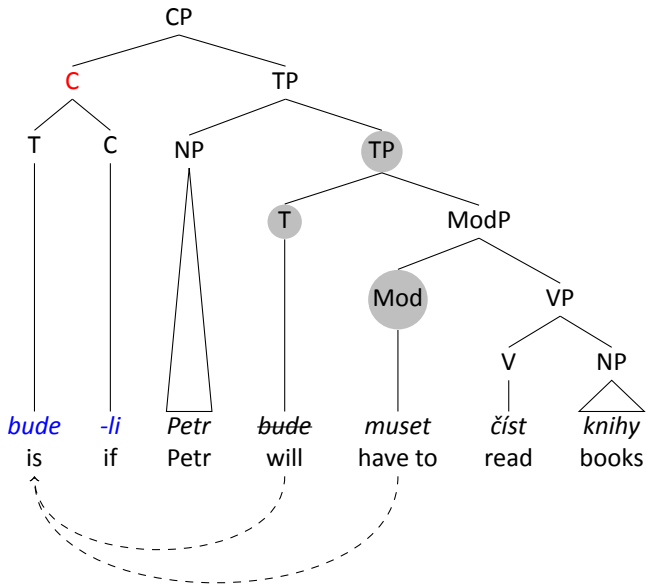

- (13) a. *Muset-li Petr bude číst knihy, ...
 read -if Petr will books, ...
- b. *Bude muset číst knihy-li Petr, ...
 will read -if Petr books

The economy of movement

(14) When we move a host to the suffix:

The economy of movement

- (14) When we move a host to the suffix:
- a. Move as short as possible

The economy of movement

- (14) When we move a host to the suffix:
- Move as short as possible
 - Move as little possible

The economy of movement

- (14) When we move a host to the suffix:
- a. Move as short as possible
 - b. Move as little possible
- ▶ Specific to each language / universal?

The economy of movement

- (14) When we move a host to the suffix:
- a. Move as short as possible
 - b. Move as little possible
-
- ▶ Specific to each language / universal?
 - ▶ If universal, are these specific to language?

Recap

Choosing between head-movement and affix hopping

Expletive insertion in more detail

Using an existing host

Sub-Strategy I: Affix Hopping

Using an existing host

Sub-Strategy I: Affix Hopping

Czech

Selecting the host

Question formation

(15) a. The inspector will be staying at the pub.

- (15)
- a. The inspector will be staying at the pub.
 - b. I wonder **whether** the inspector will be staying at the pub.

- (15)
- a. The inspector will be staying at the pub.
 - b. I wonder **whether** the inspector will be staying at the pub.
 - c. **Will** the inspector **will** be staying at the pub?

- (15)
- a. The inspector will be staying at the pub.
 - b. I wonder **whether** the inspector will be staying at the pub.
 - c. **Will** the inspector **will** be staying at the pub?
- (16) Will -Q the inspector be staying at the pub?

- (15) a. The inspector will be staying at the pub.
b. I wonder **whether** the inspector will be staying at the pub.
c. **Will** the inspector **will** be staying at the pub?
- (16) Will -Q the inspector be staying at the pub?
- (17) Blagoj čete kniga
Blagoj reads book
'Blagoj is reading a book.'

- (15) a. The inspector will be staying at the pub.
b. I wonder **whether** the inspector will be staying at the pub.
c. **Will** the inspector **will** be staying at the pub?
- (16) Will -Q the inspector be staying at the pub?
- (17) Blagoj čete kniga
Blagoj reads book
'Blagoj is reading a book.'
- (18) Čete-li Blagoj čete kniga?
Reads-Q Blagoj book?
'Is Blagoj reading a book?'

(19) The inspector will be staying at the pub.

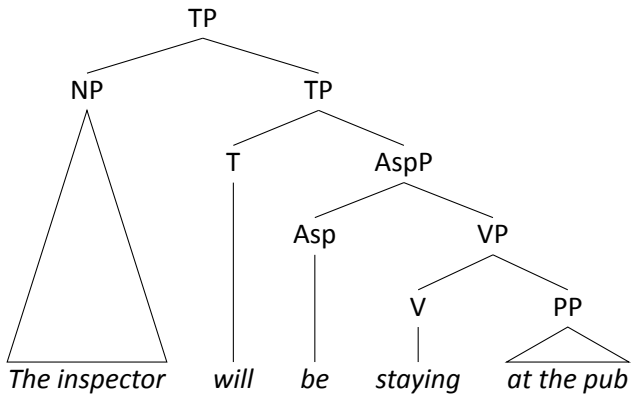

(20) ... whether the inspector be staying at the pub.

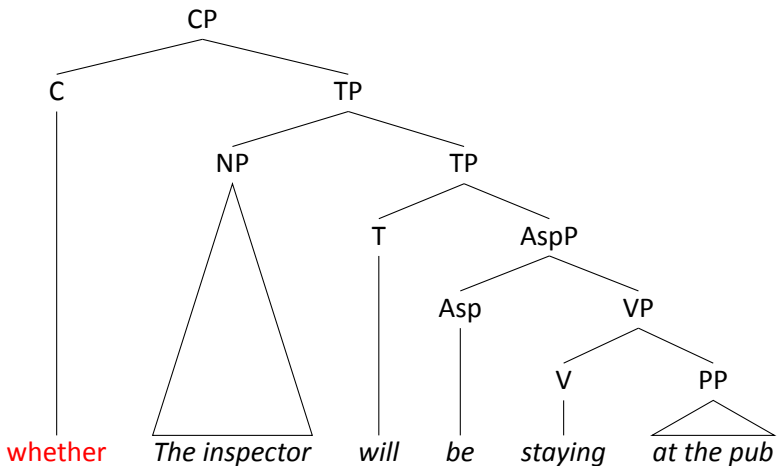

(21) Will the inspector be staying at the pub.

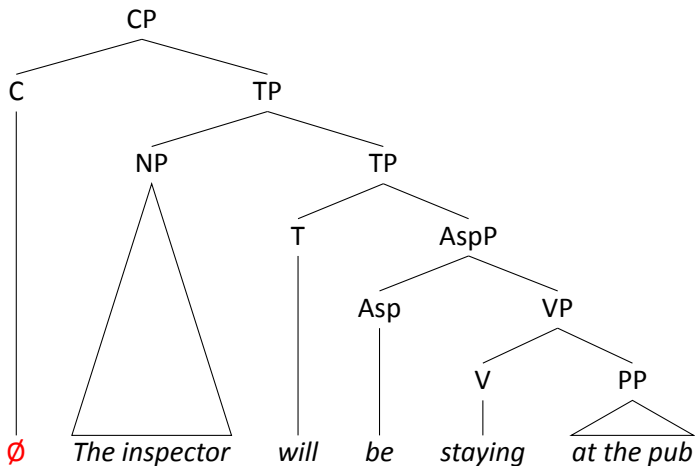

(22) Will the inspector be staying at the pub.

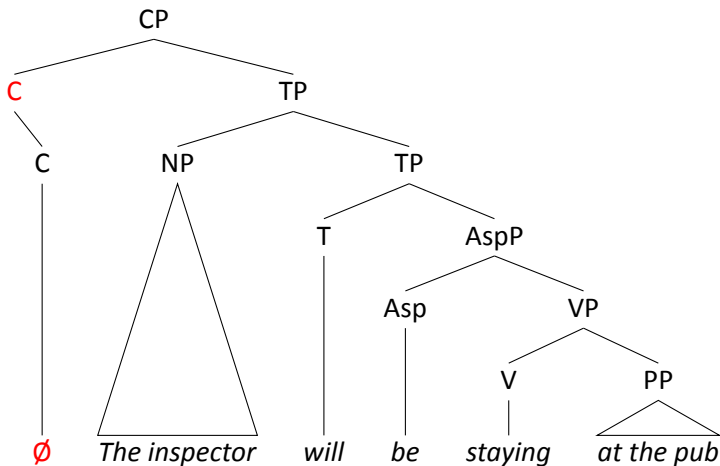

(23) Will the inspector be staying at the pub.

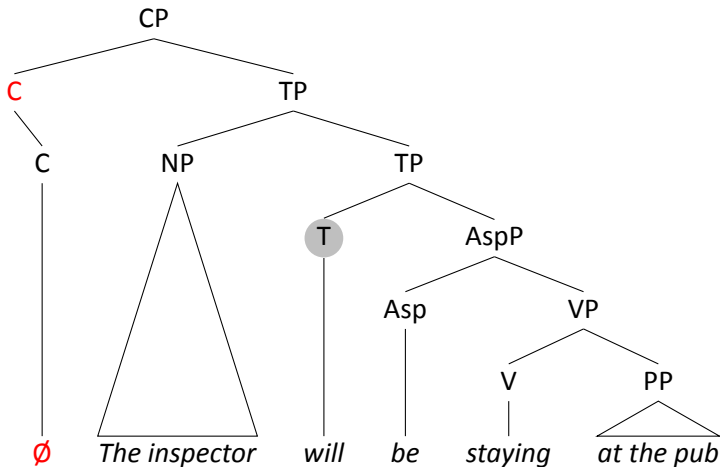

(24) Will the inspector be staying at the pub.

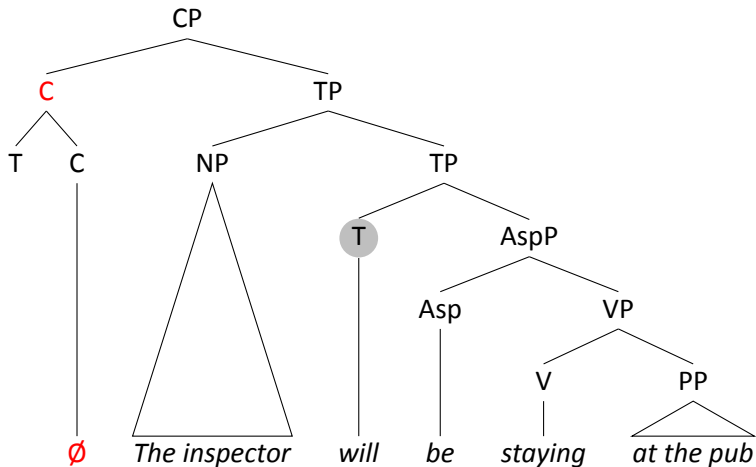

(25) Will the inspector be staying at the pub.

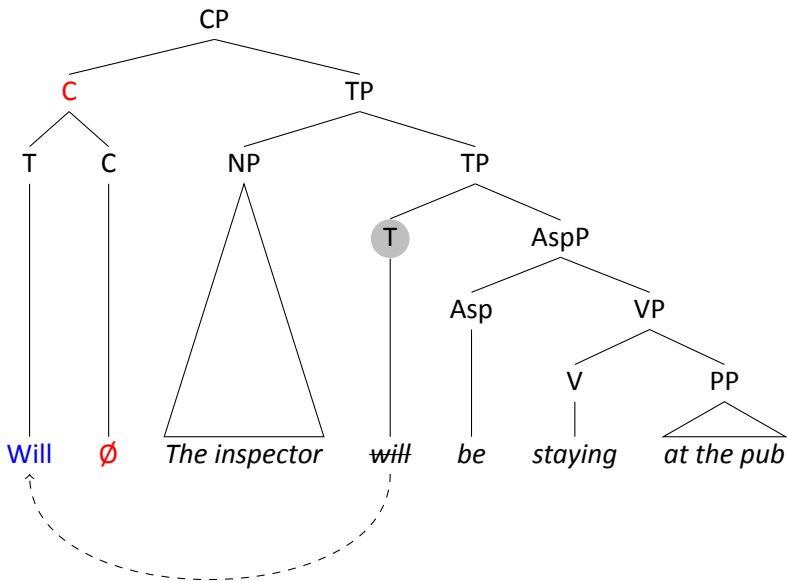

(26) Will the inspector be staying at the pub.

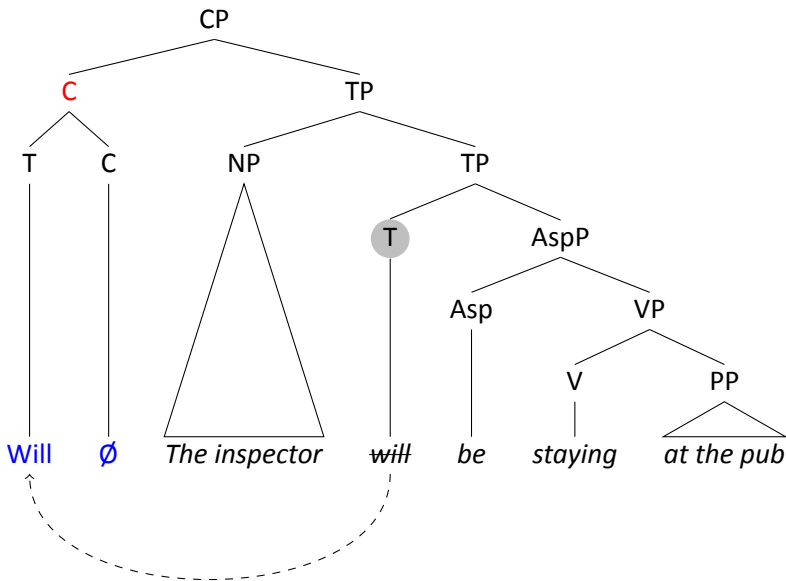

(27) Will the inspector be staying at the pub.

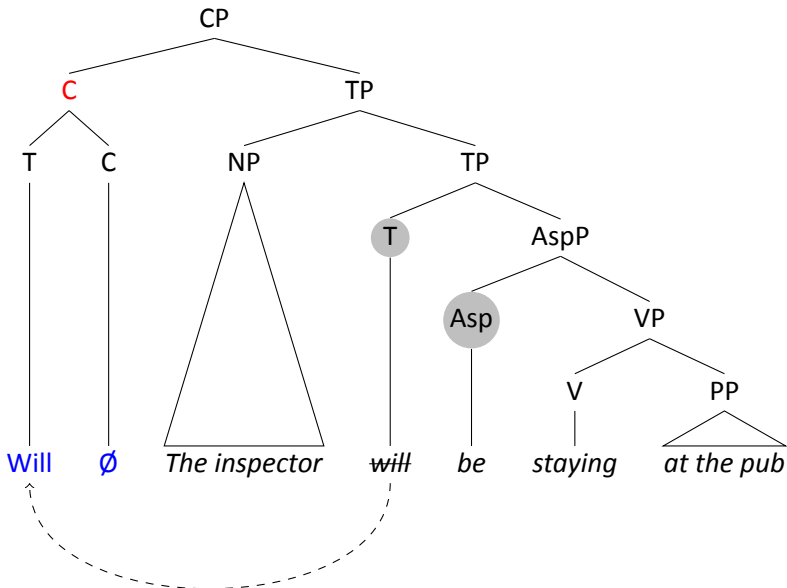

(28) Will the inspector be staying at the pub.

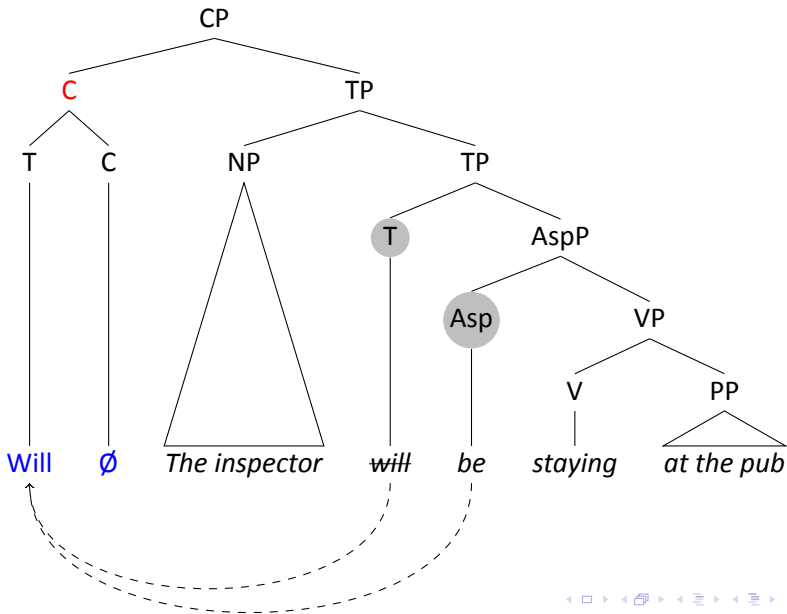

The economy of movement

(29) When we move a host to the suffix:

The economy of movement

- (29) When we move a host to the suffix:
- Move as short as possible

The economy of movement

- (29) When we move a host to the suffix:
- Move as short as possible
 - Move as little possible

The economy of movement

(29) When we move a host to the suffix:

- a. Move as short as possible
- b. Move as little possible

▶ This does not seem specific to individual languages

The economy of movement

(29) When we move a host to the suffix:

- a. Move as short as possible
- b. Move as little possible

▶ This does not seem specific to individual languages

Recap

Choosing between head-movement and affix hopping

Expletive insertion in more detail

Using an existing host

Sub-Strategy I: Affix Hopping

Using an existing host

Sub-Strategy I: Affix Hopping

Czech

Selecting the host

Question formation

Recall

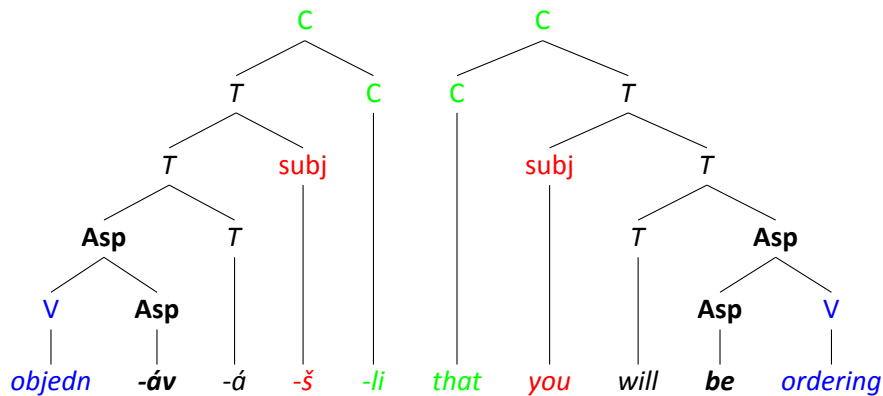

Recall

(30) The Mirror Principle

Recall

- (30) The Mirror Principle
- a. The order of morphemes inside words is the mirror image of the order of words in syntax

Recall

- (30) The Mirror Principle
- a. The order of morphemes inside words is the mirror image of the order of words in syntax
 - b. The order of morphemes mirrors the syntactic derivation

Deriving the Mirror Principle

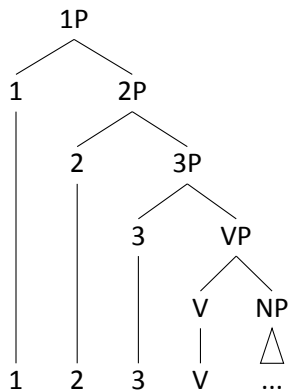

Deriving the Mirror Principle

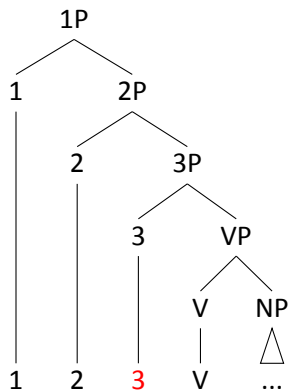

Deriving the Mirror Principle

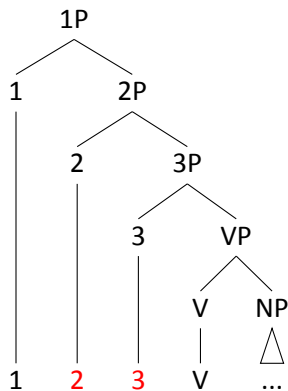

Deriving the Mirror Principle

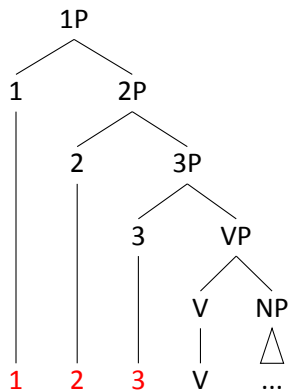

Deriving the Mirror Principle

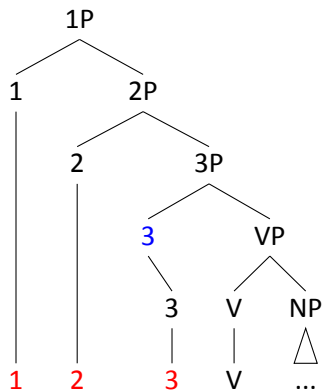

Deriving the Mirror Principle

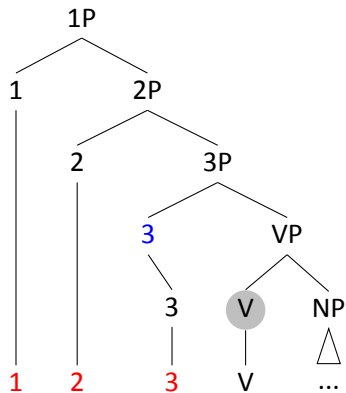

Deriving the Mirror Principle

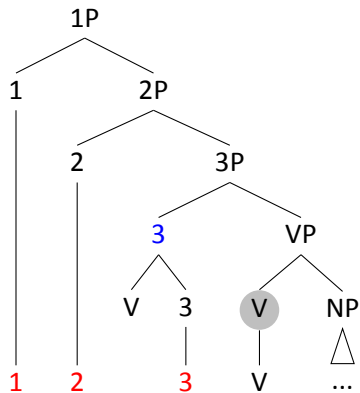

Deriving the Mirror Principle

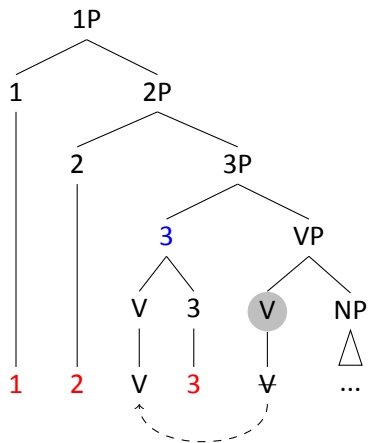

Deriving the Mirror Principle

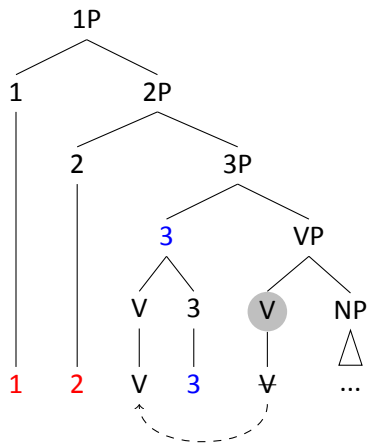

Deriving the Mirror Principle

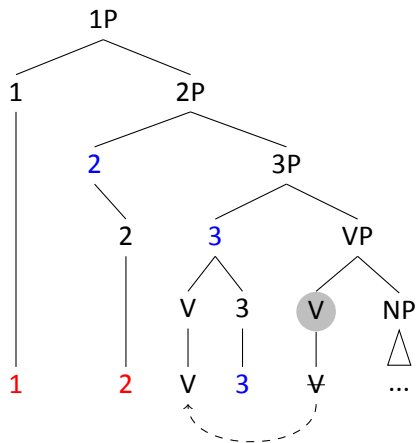

Deriving the Mirror Principle

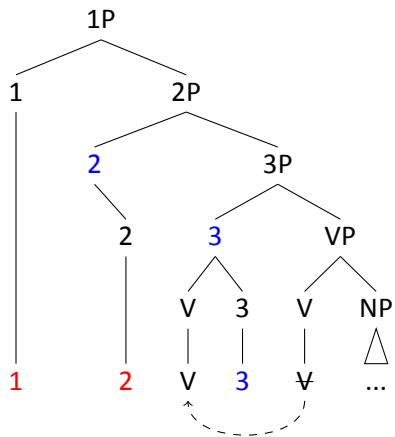

Deriving the Mirror Principle

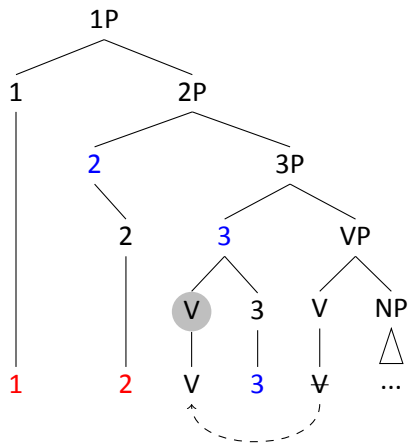

Deriving the Mirror Principle

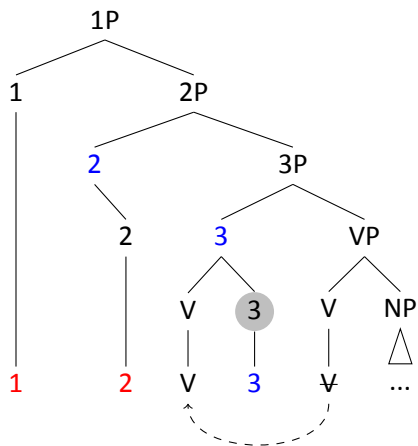

Deriving the Mirror Principle

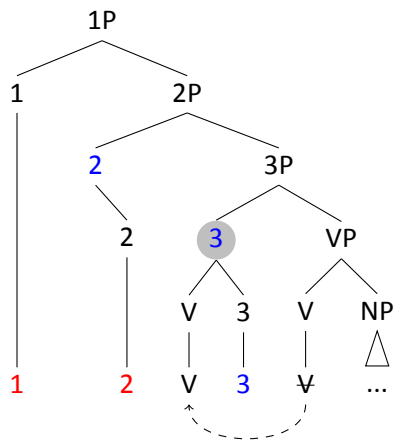

Deriving the Mirror Principle

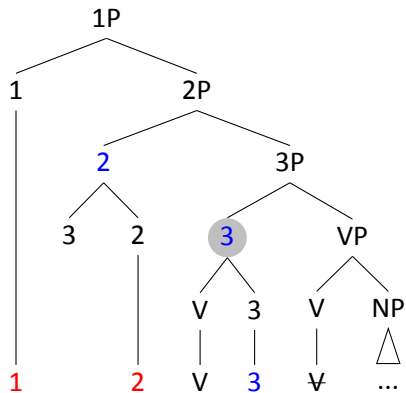

Deriving the Mirror Principle

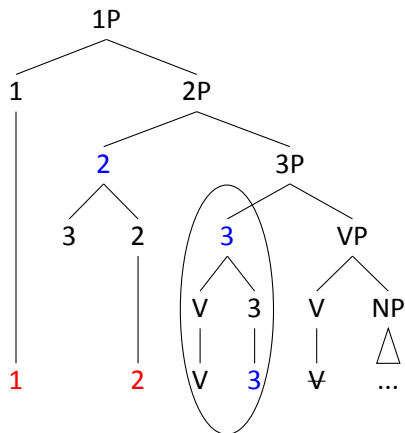

Deriving the Mirror Principle

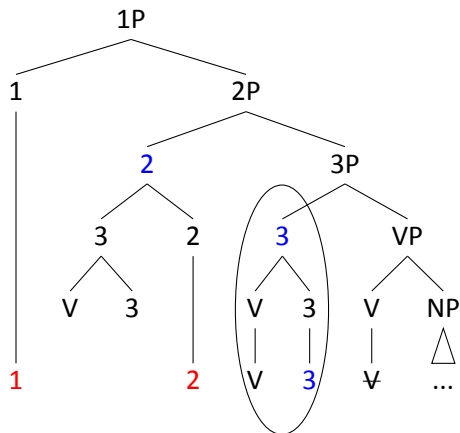

Deriving the Mirror Principle

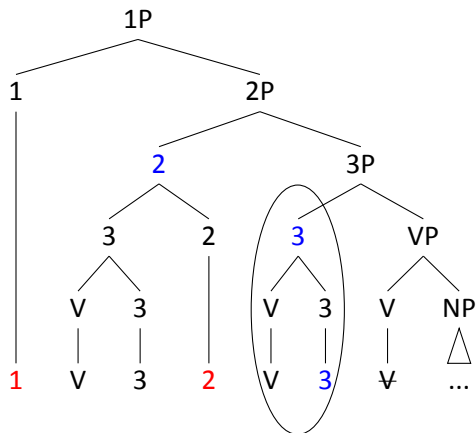

Deriving the Mirror Principle

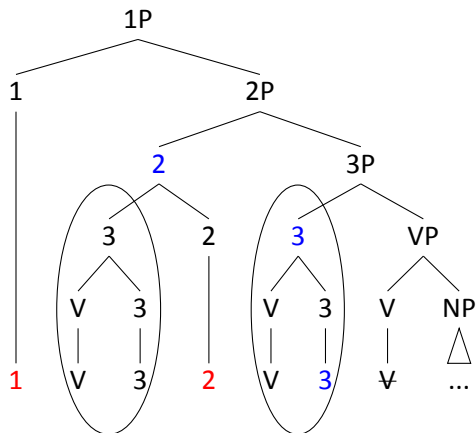

Deriving the Mirror Principle

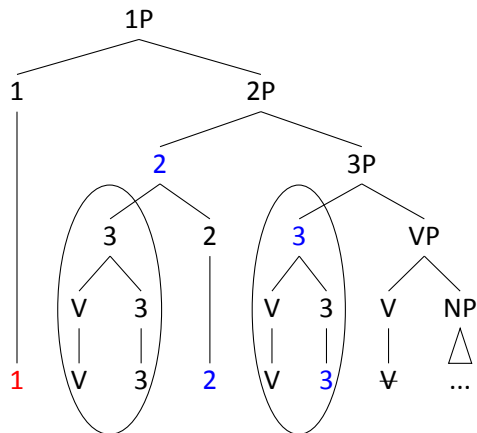

Deriving the Mirror Principle

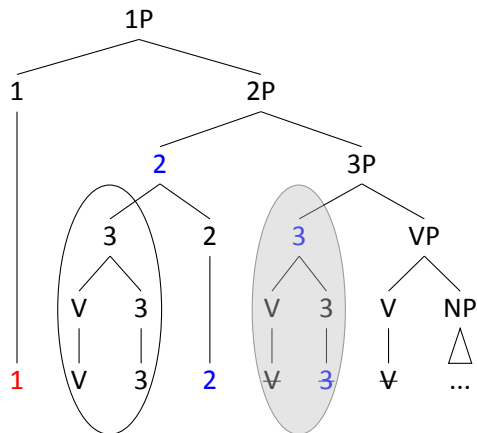

Deriving the Mirror Principle

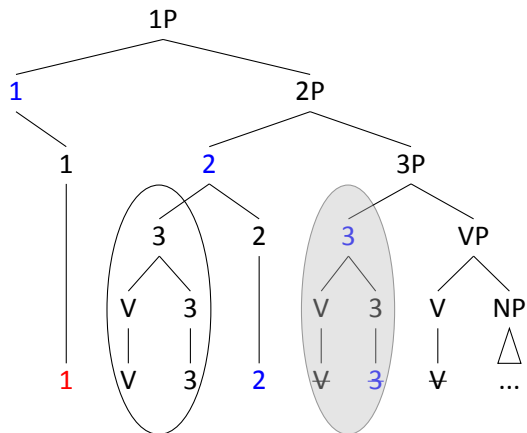

Deriving the Mirror Principle

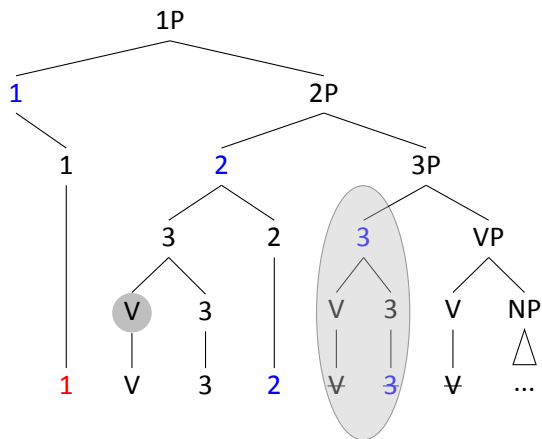

Deriving the Mirror Principle

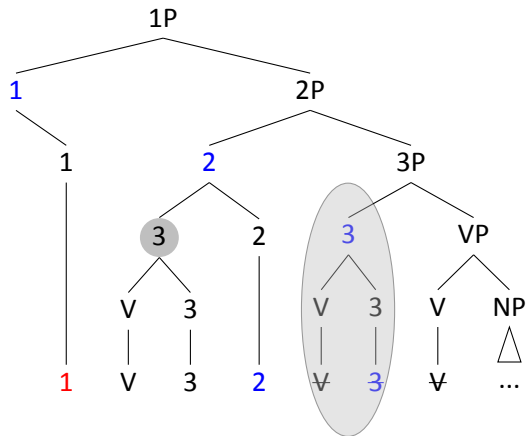

Deriving the Mirror Principle

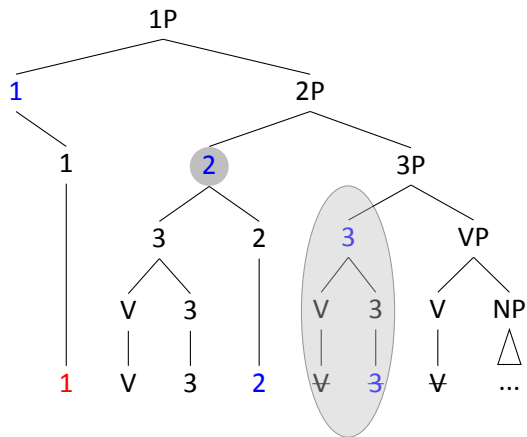

Deriving the Mirror Principle

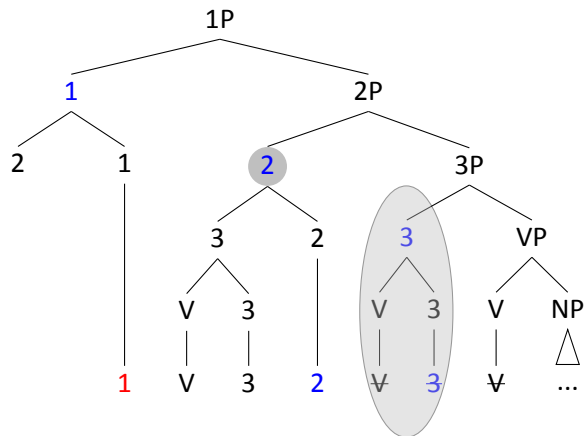

Deriving the Mirror Principle

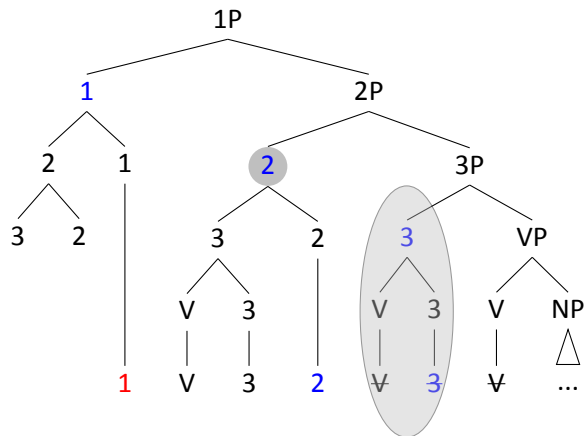

Deriving the Mirror Principle

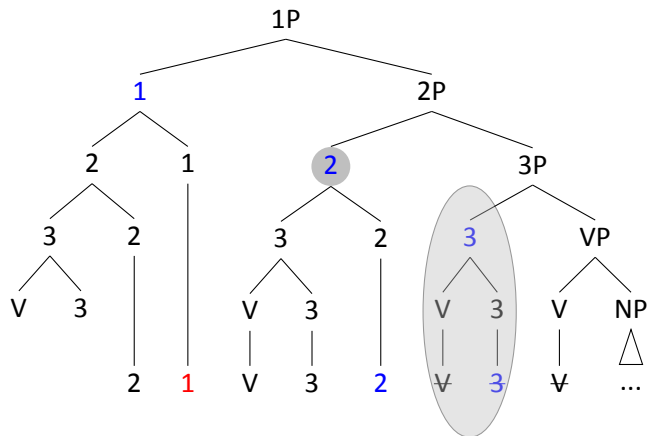

Deriving the Mirror Principle

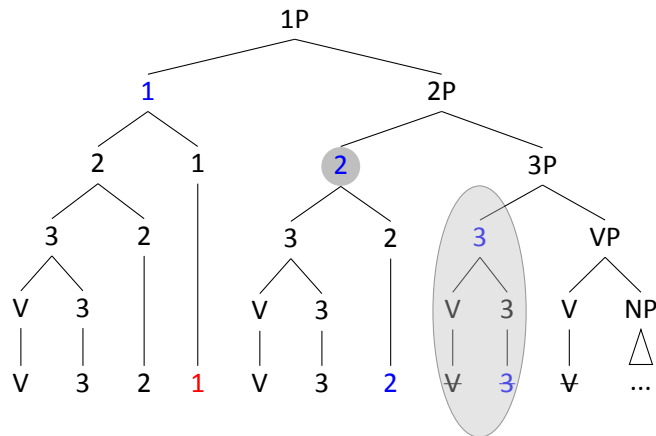

Deriving the Mirror Principle

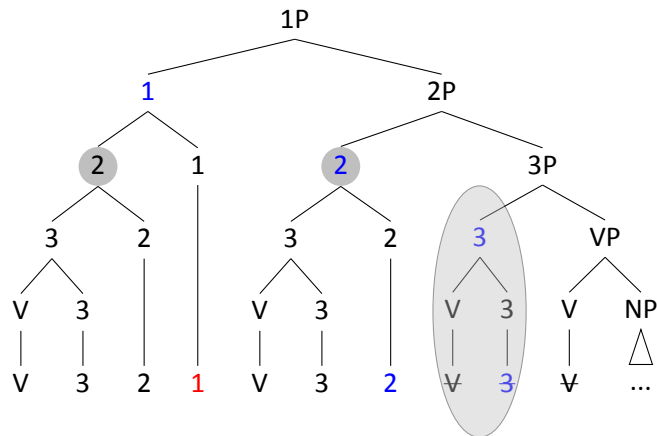

Deriving the Mirror Principle

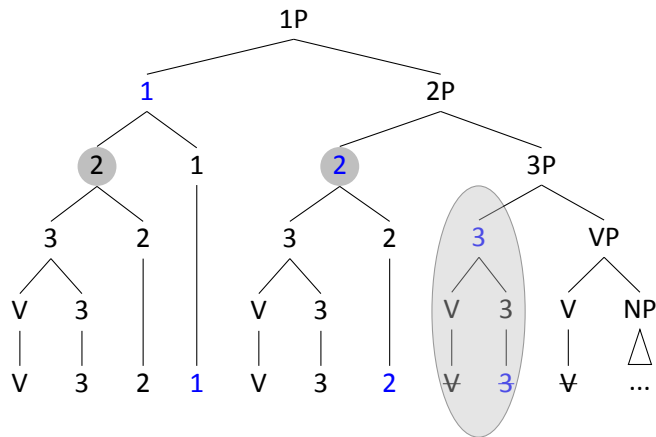

Deriving the Mirror Principle

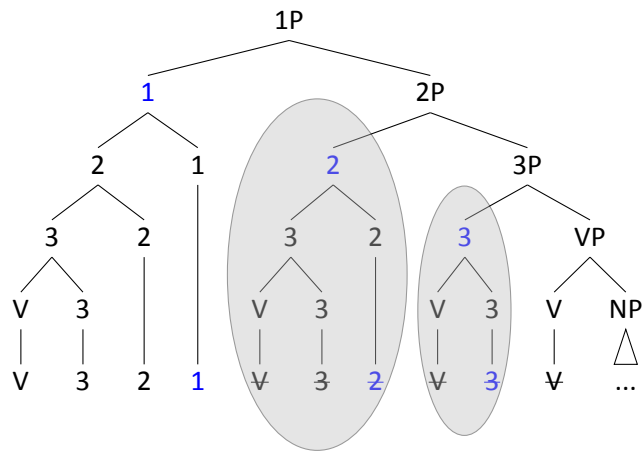

Deriving the Mirror Principle

- ▶ Head movement derives mirror derivations

Deriving the Mirror Principle

- ▶ Head movement derives mirror derivations

Recap

Choosing between head-movement and affix hopping

Expletive insertion in more detail

Using an existing host

Sub-Strategy I: Affix Hopping

Using an existing host

Sub-Strategy I: Affix Hopping

Czech

Selecting the host

Question formation

- (31) When a head is expressed by an affix, syntax must provide a host for that affix.

- (31) When a head is expressed by an affix, syntax must provide a host for that affix.
- a. Strategy 1: insert an expletive

- (31) When a head is expressed by an affix, syntax must provide a host for that affix.
- a. Strategy 1: insert an expletive
He d-ed order the drinks.

(31) When a head is expressed by an affix, syntax must provide a host for that affix.

a. Strategy 1: insert an expletive

He **d-ed** order the drinks.

Jest -li Petr bude číst knihy

- (31) When a head is expressed by an affix, syntax must provide a host for that affix.
- a. Strategy 1: insert an expletive
He **d-ed** order the drinks.
Jest -li Petr bude číst knihy
 - b. Strategy 2: use an existing host

- (31) When a head is expressed by an affix, syntax must provide a host for that affix.
- a. Strategy 1: insert an expletive
He **d-ed** order the drinks.
Jest -li Petr bude číst knihy
 - b. Strategy 2: use an existing host
He **order-ed** the drinks.

- (31) When a head is expressed by an affix, syntax must provide a host for that affix.
- a. Strategy 1: insert an expletive
He **d-ed** order the drinks.
Jest -li Petr bude číst knihy
 - b. Strategy 2: use an existing host
He **order-ed** the drinks.
Bude -li Petr číst knihy, ...

- (31) When a head is expressed by an affix, syntax must provide a host for that affix.
- a. Strategy 1: insert an expletive
He **d-ed** order the drinks.
Jest -li Petr bude číst knihy
 - b. Strategy 2: use an existing host
He **order-ed** the drinks.
Bude -li Petr číst knihy, ...
- (32) Strategy 2 comes in two types

- (31) When a head is expressed by an affix, syntax must provide a host for that affix.
- a. Strategy 1: insert an expletive
He **d-ed** order the drinks.
Jest -li Petr bude číst knihy
 - b. Strategy 2: use an existing host
He **order-ed** the drinks.
Bude -li Petr číst knihy, ...
- (32) Strategy 2 comes in two types
- a. Affix hopping (lowering)

- (31) When a head is expressed by an affix, syntax must provide a host for that affix.
- a. Strategy 1: insert an expletive
He **d-ed** order the drinks.
Jest -li Petr bude číst knihy
 - b. Strategy 2: use an existing host
He **order-ed** the drinks.
Bude -li Petr číst knihy, ...
- (32) Strategy 2 comes in two types
- a. Affix hopping (lowering)
 - b. Head movement

- (31) When a head is expressed by an affix, syntax must provide a host for that affix.
- a. Strategy 1: insert an expletive
He **d-ed** order the drinks.
Jest -li Petr bude číst knihy
 - b. Strategy 2: use an existing host
He **order-ed** the drinks.
Bude -li Petr číst knihy, ...
- (32) Strategy 2 comes in two types
- a. Affix hopping (lowering)
 - b. Head movement
- (33) When we move a host to the suffix:

- (31) When a head is expressed by an affix, syntax must provide a host for that affix.
- a. Strategy 1: insert an expletive
He **d-ed** order the drinks.
Jest -li Petr bude číst knihy
 - b. Strategy 2: use an existing host
He **order-ed** the drinks.
Bude -li Petr číst knihy, ...
- (32) Strategy 2 comes in two types
- a. Affix hopping (lowering)
 - b. Head movement
- (33) When we move a host to the suffix:
- a. Move as short as possible

- (31) When a head is expressed by an affix, syntax must provide a host for that affix.
- a. Strategy 1: insert an expletive
He **d-ed** order the drinks.
Jest -li Petr bude číst knihy
 - b. Strategy 2: use an existing host
He **order-ed** the drinks.
Bude -li Petr číst knihy, ...
- (32) Strategy 2 comes in two types
- a. Affix hopping (lowering)
 - b. Head movement
- (33) When we move a host to the suffix:
- a. Move as short as possible
 - b. Move as little possible

- (31) When a head is expressed by an affix, syntax must provide a host for that affix.
- a. Strategy 1: insert an expletive
He **d-ed** order the drinks.
Jest -li Petr bude číst knihy
 - b. Strategy 2: use an existing host
He **order-ed** the drinks.
Bude -li Petr číst knihy, ...
- (32) Strategy 2 comes in two types
- a. Affix hopping (lowering)
 - b. Head movement
- (33) When we move a host to the suffix:
- a. Move as short as possible
 - b. Move as little possible

► Derives the Mirror Effect in morphology