

# zemědělství



# ZEMĚDĚLSKÉ NÁŘADÍ

- srp
- kosa
  - objímka kosa
- nůžky – ovčácké
- nůž – vinařský
- radlice
- krojidlo
- otka
- polní brány
  - hřeb



- motyka
- kování rýče
- závěs cepu
- vidle
  - hroty
- hřebla
- hák

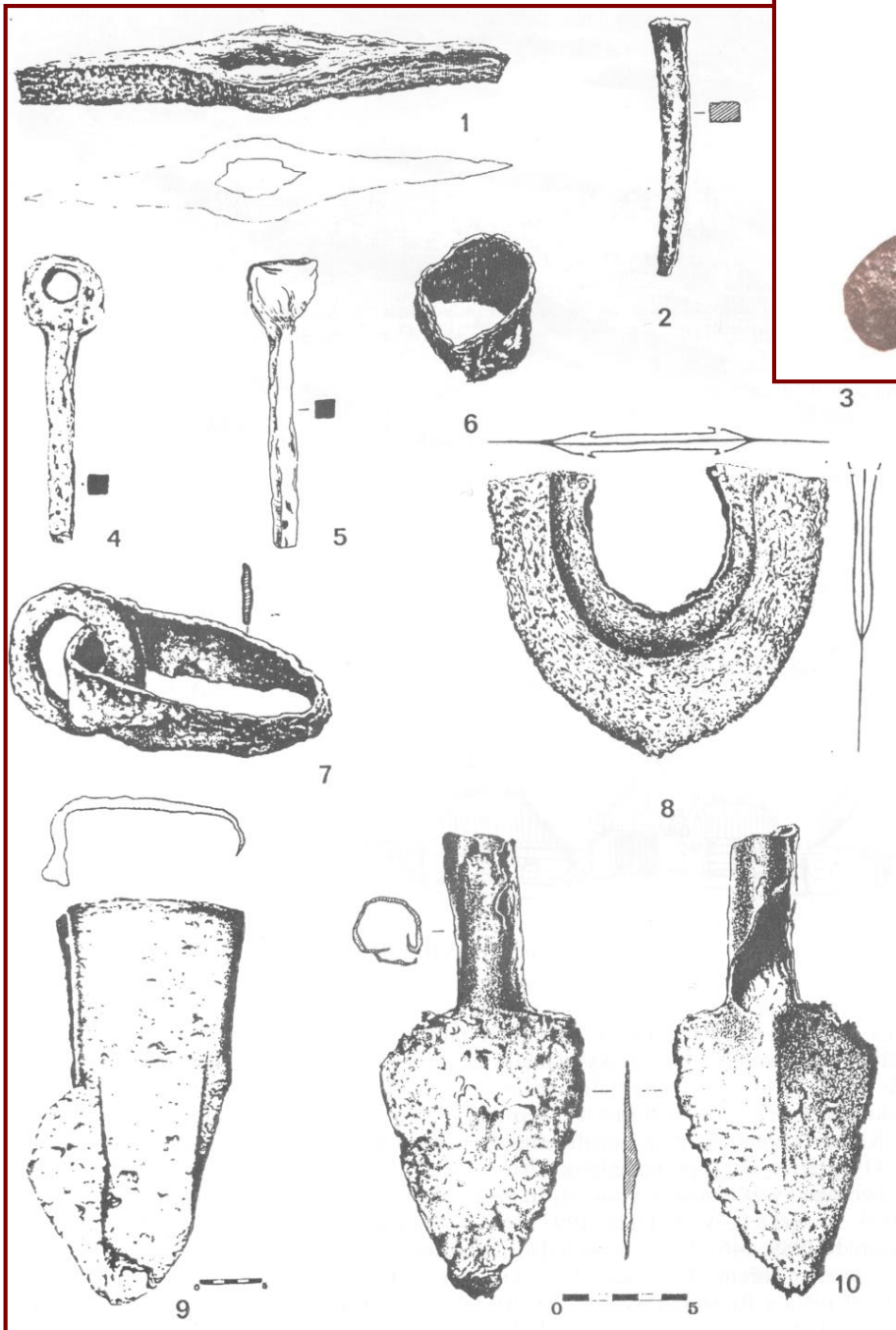

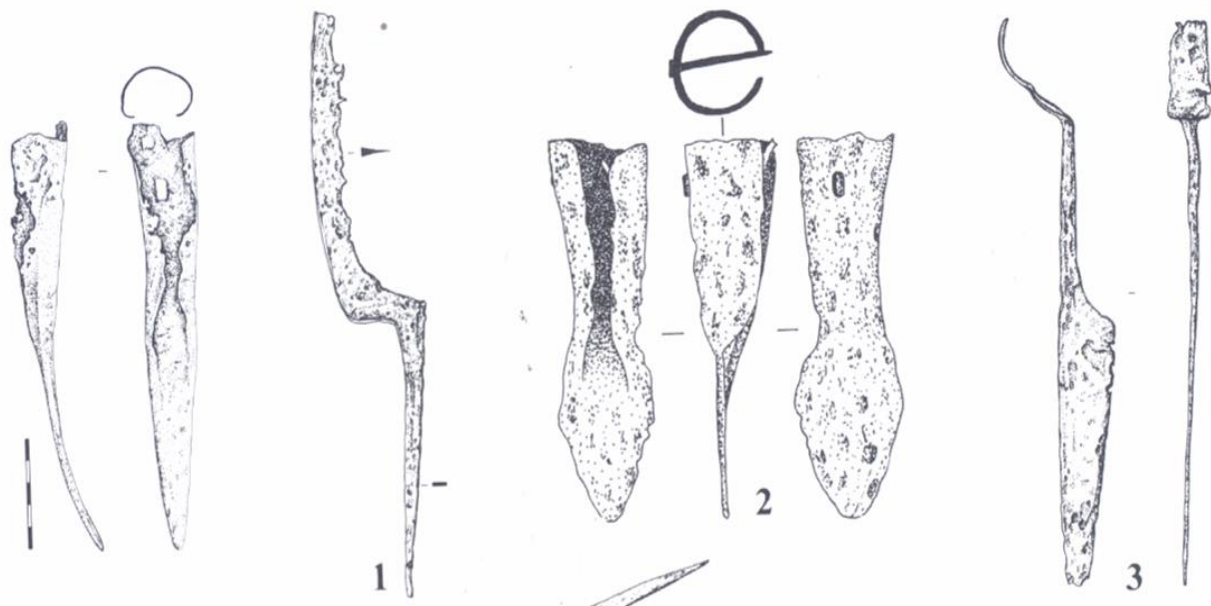

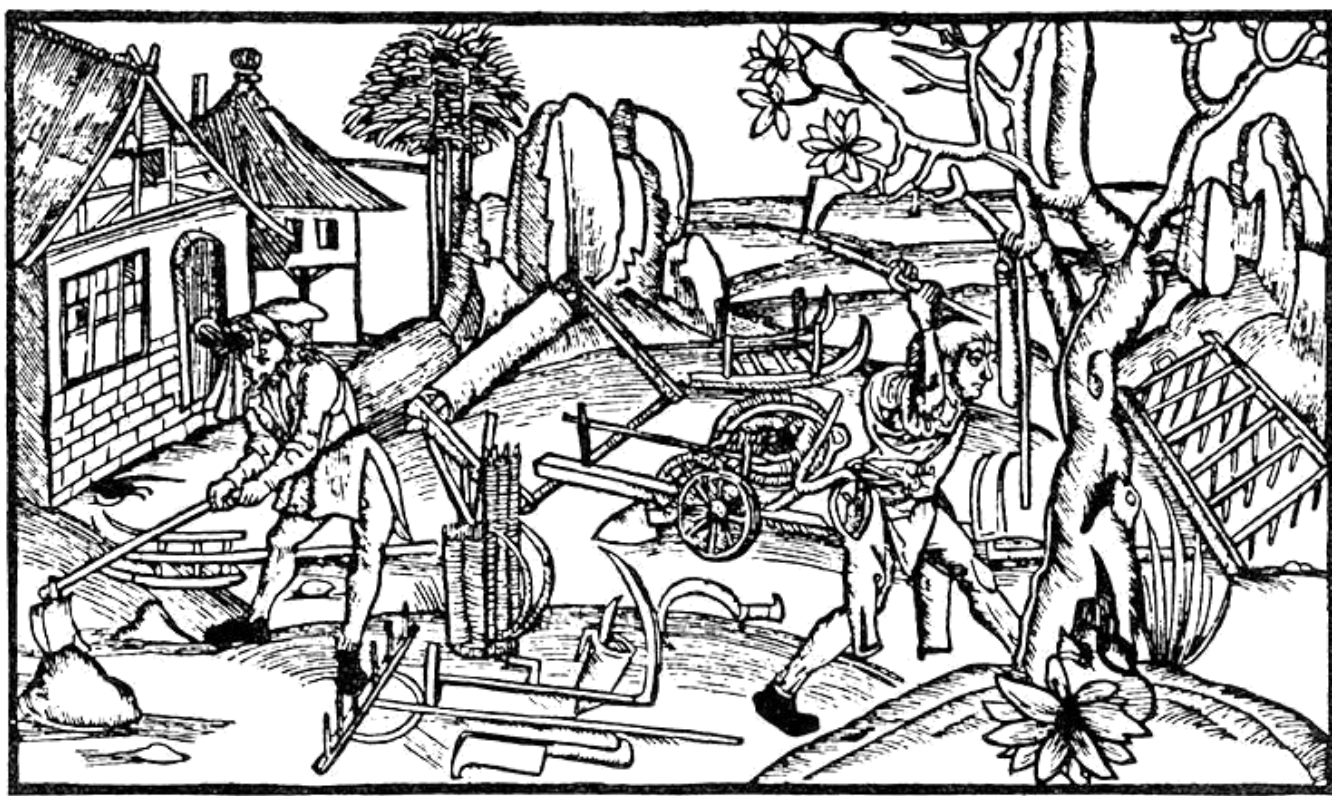

Ikongrafické prameny  
Písemné prameny  
Archeologické prameny  
Etnografické paralely





- doklady orby
- plužiny
- zemědělské nářadí – orba, sklizeň, skladování, chov dobytka, aj.



křížová orba, Praha-Klárov

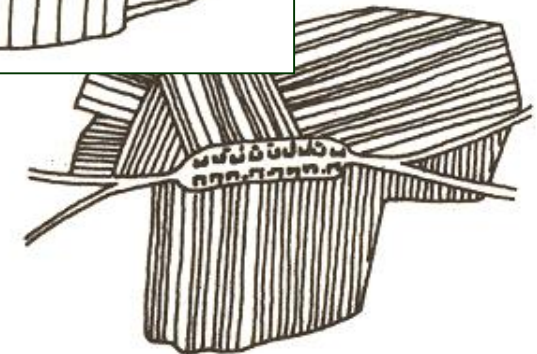
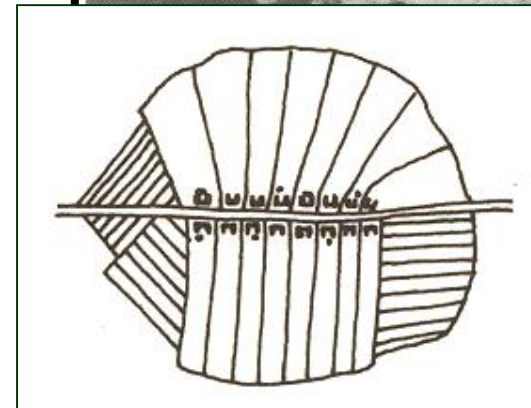
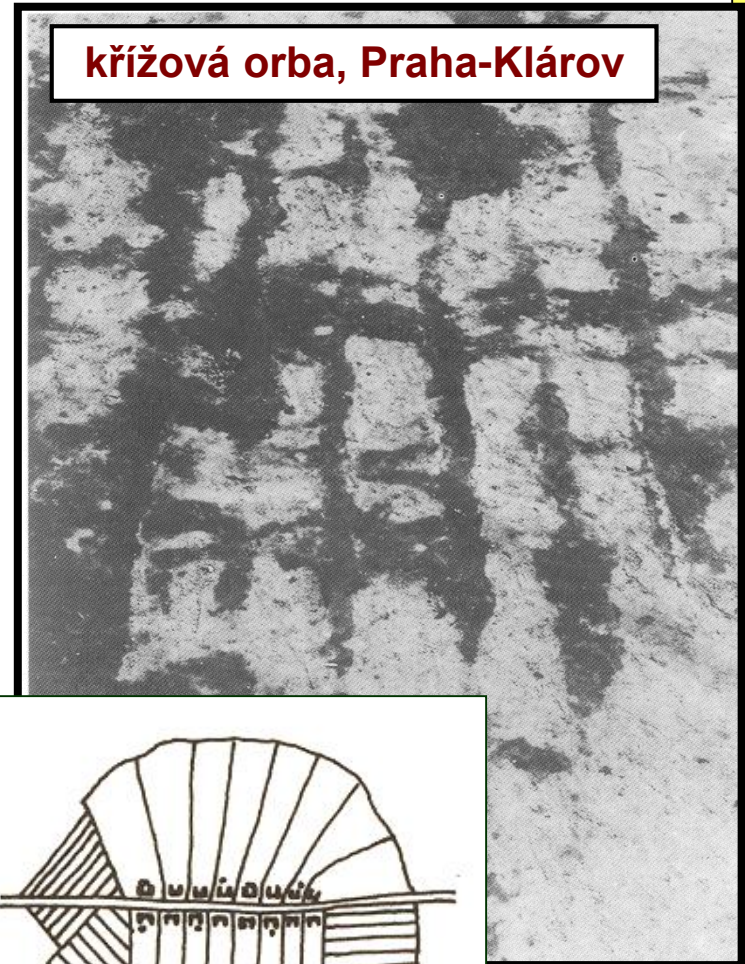

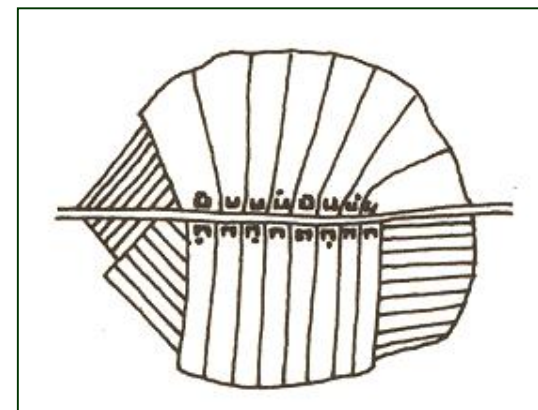

parcela - délka:

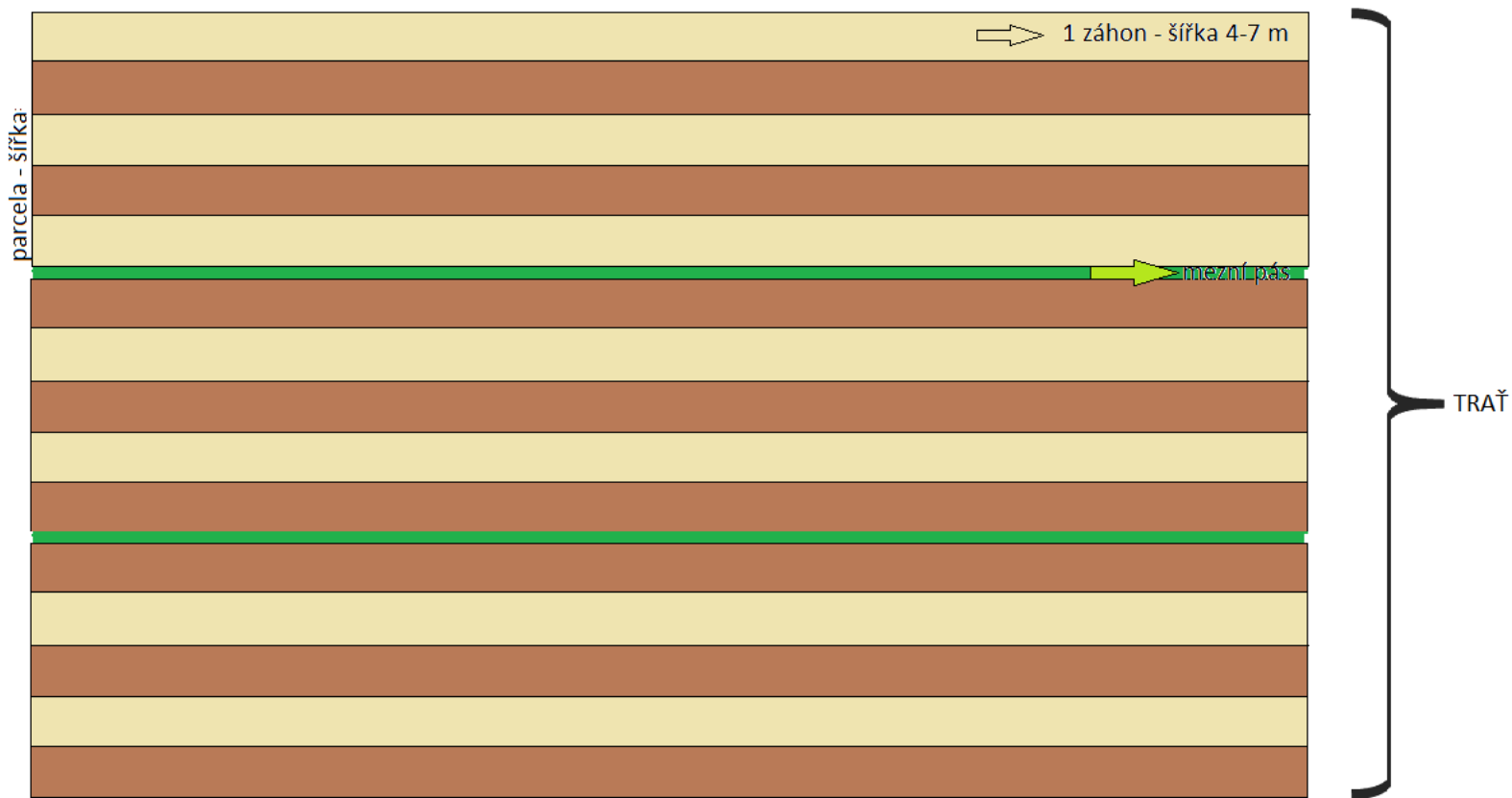



## Trojpolní systém

ÚHOR	JAŘ	OZIM
JAŘ	OZIM	ÚHOR
OZIM	ÚHOR	JAŘ





## způsob obdělávání - orby pole

- rozhodující - tvar a velikost pozemku a svažitost
- **ZÁHONOVÁ ORBA**
  - do rozoru
  - do skladu

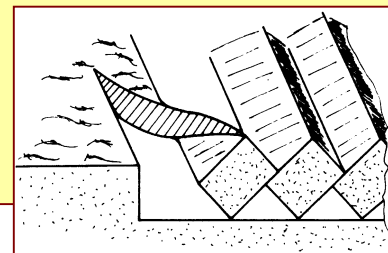

křížová orba  
(pravěk – 10. st.)

orba do podélných brázd  
10.-11.st.

orba do záhonu  
13.-14.st.

mechanický pluh  
20. st.

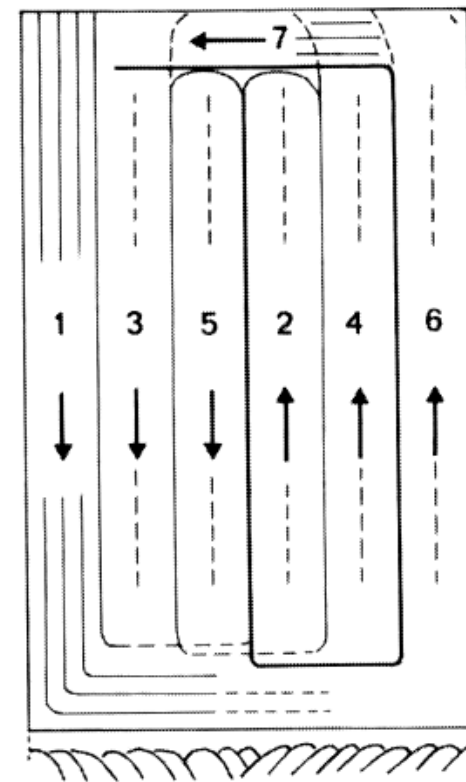
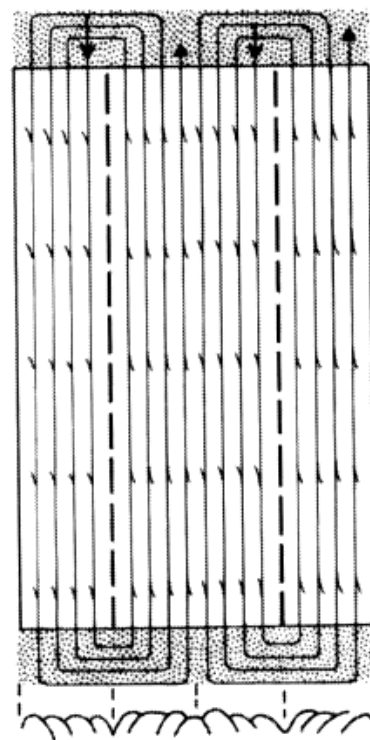
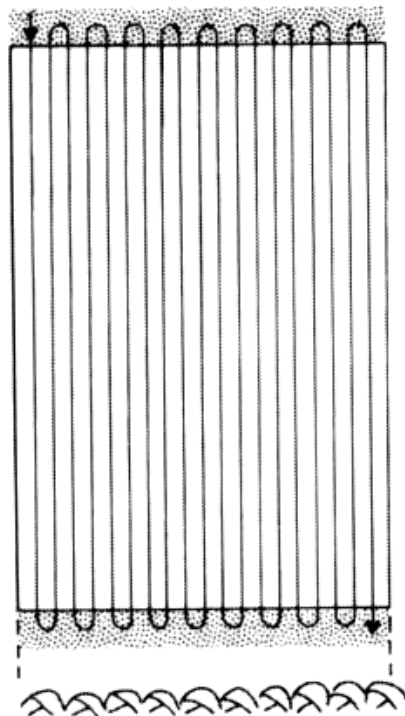
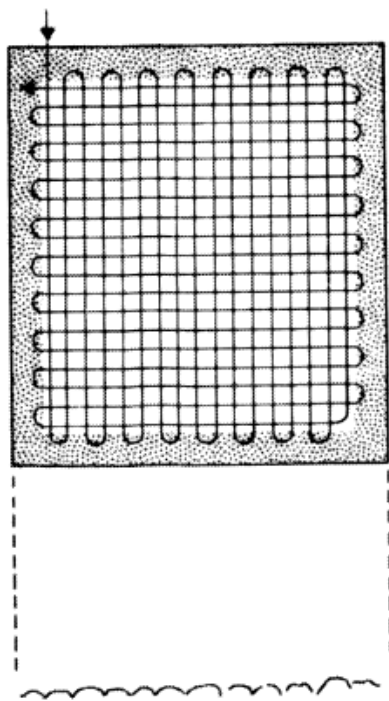



## ZÁHONOVÁ ORBA

pole/trat'/úsek: dělení do záhonu orba do skladu a nebo do rozoru – tzv. záhonový pluh

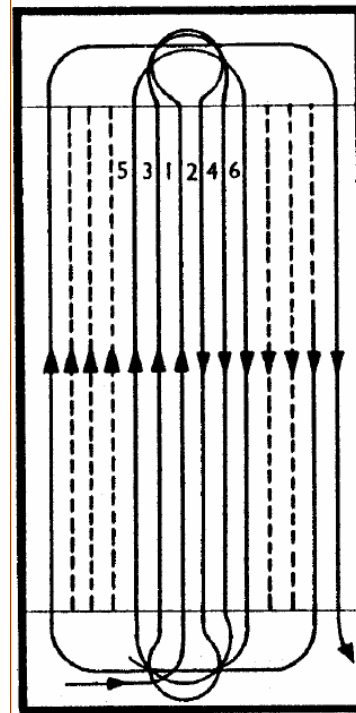
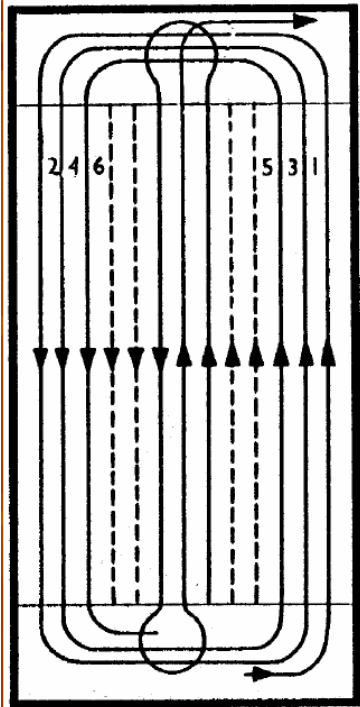

### 1) Do rozoru

začíná se orat od okraje záhonů  
postupuje se do středu,  
kde vzniká tzv. rozor

### 2) Do skladu

od středu končí se u krajů  
u středu pozemku tzv. rozpich –  
sklad - další – příkládání půdy  
směrem ke středu pozemku



# ORBNÍ NÁŘADÍ



- RÁDLA BEZ PLAZU
  - rádla rýlová-háky
- RÁDLA S PLAZEM
- SOCHY
- PLUHY

- Beranová
- Stará
- Šach

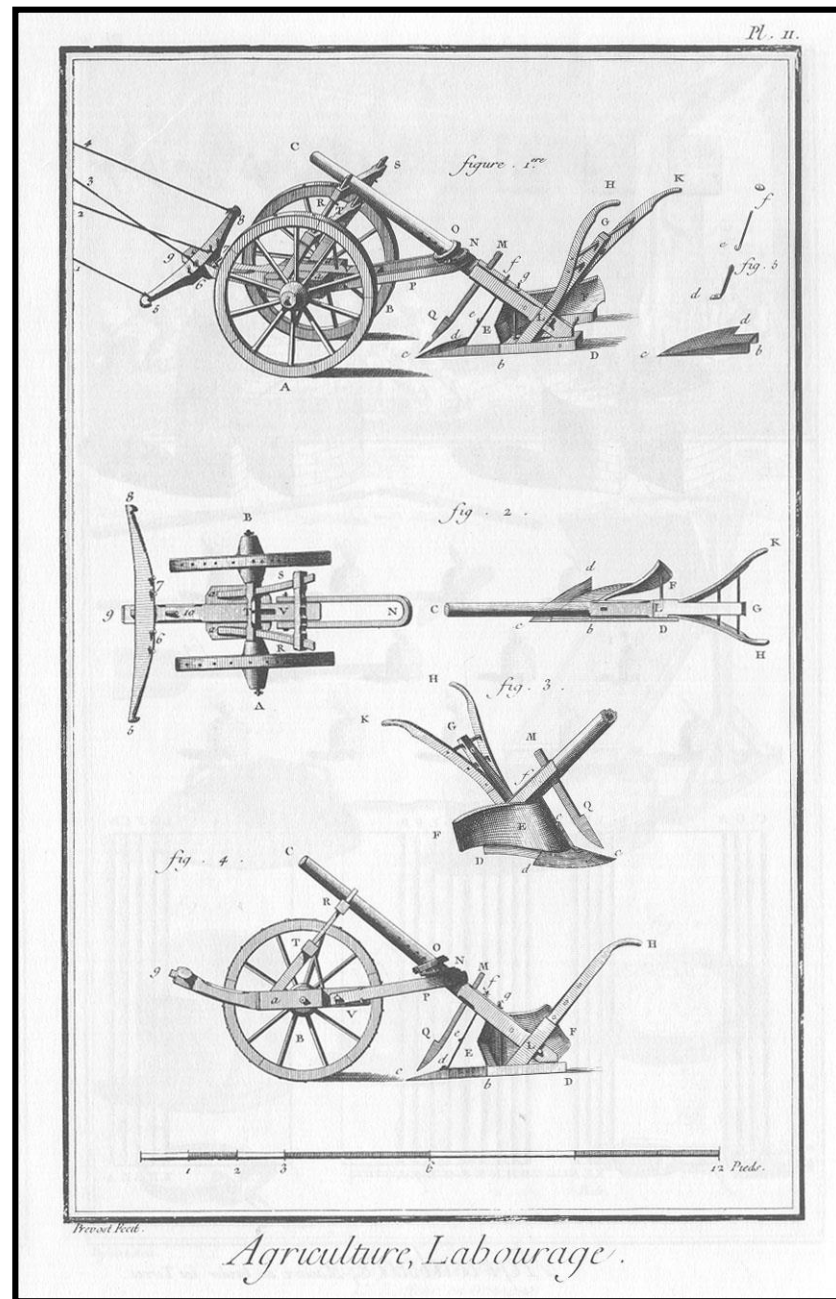

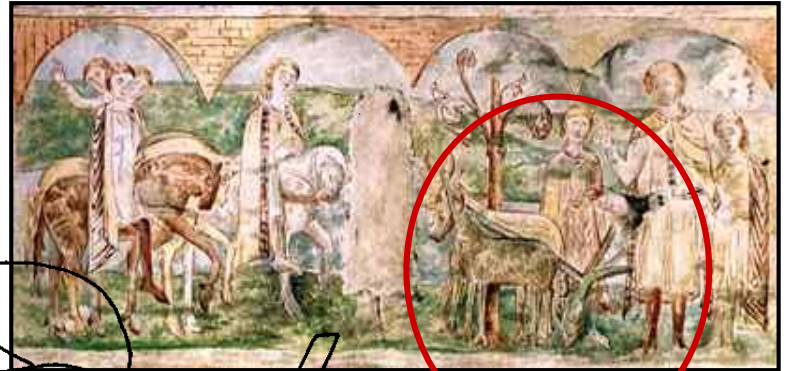
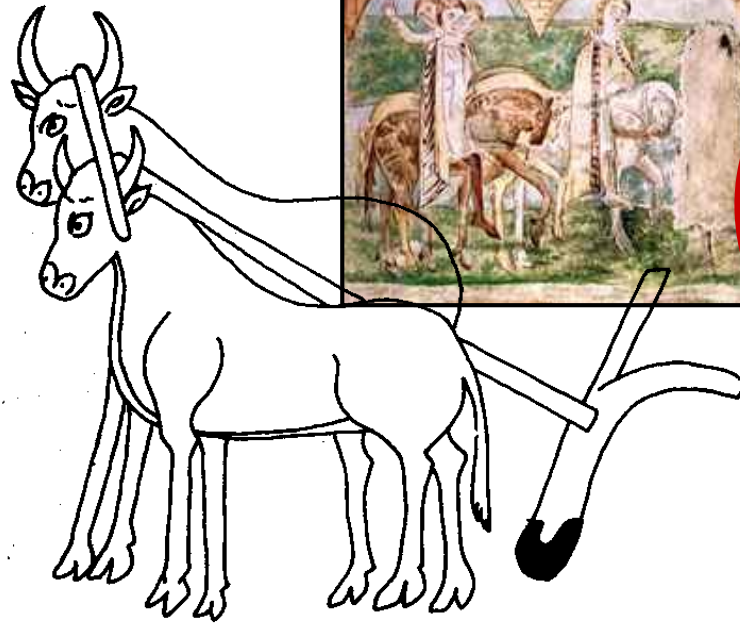

Captabunt in animam iusti: et san-  
guinem innocentem condemnabunt.

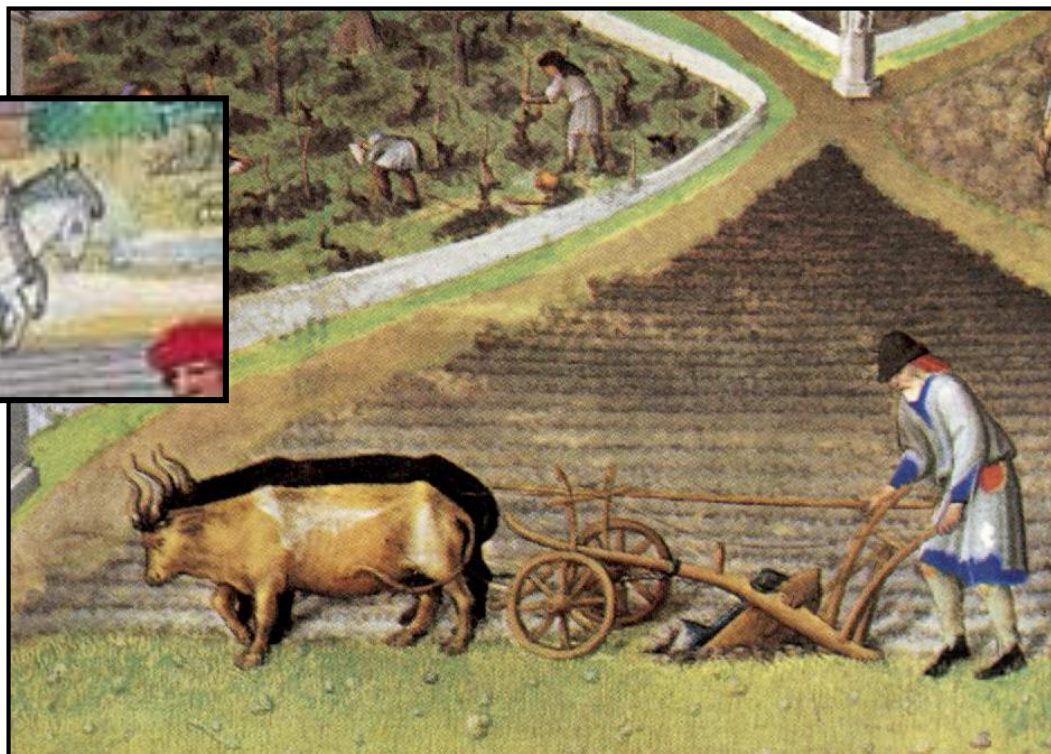

# ORBNÍ NÁŘADÍ

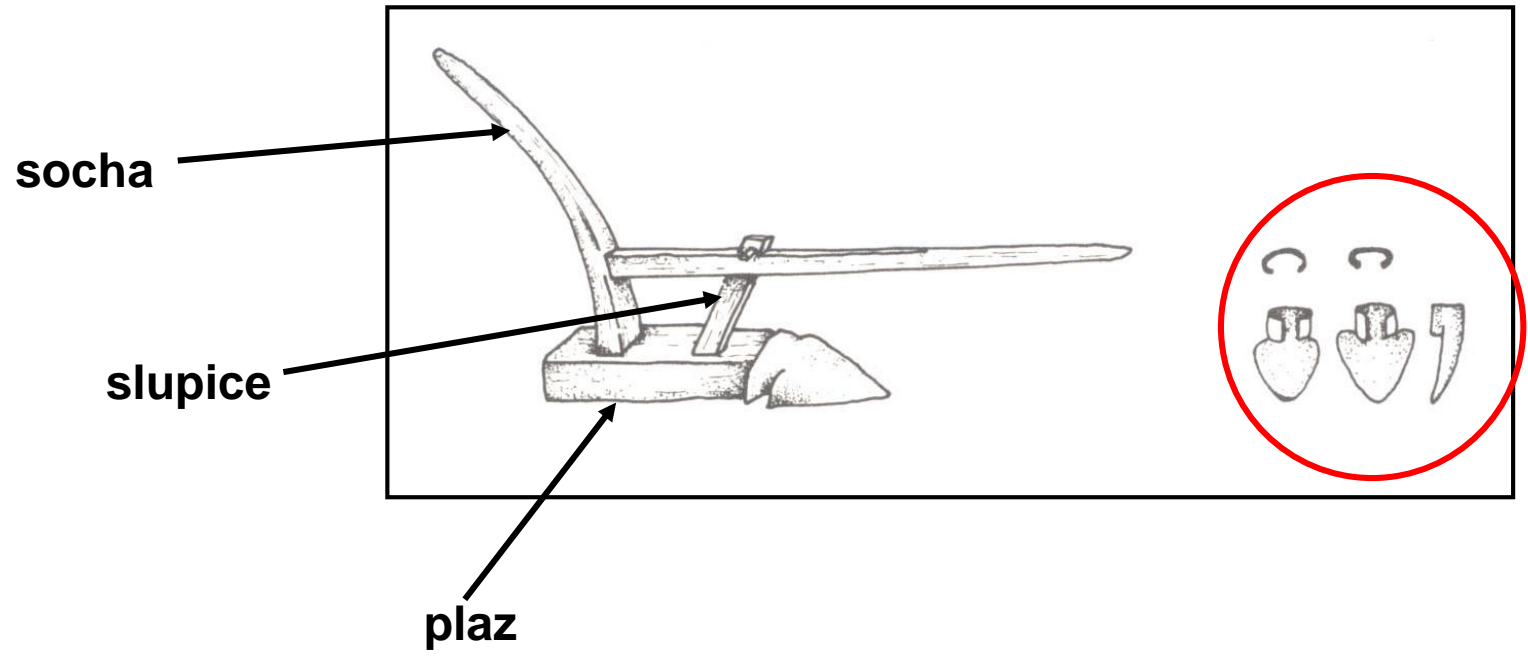
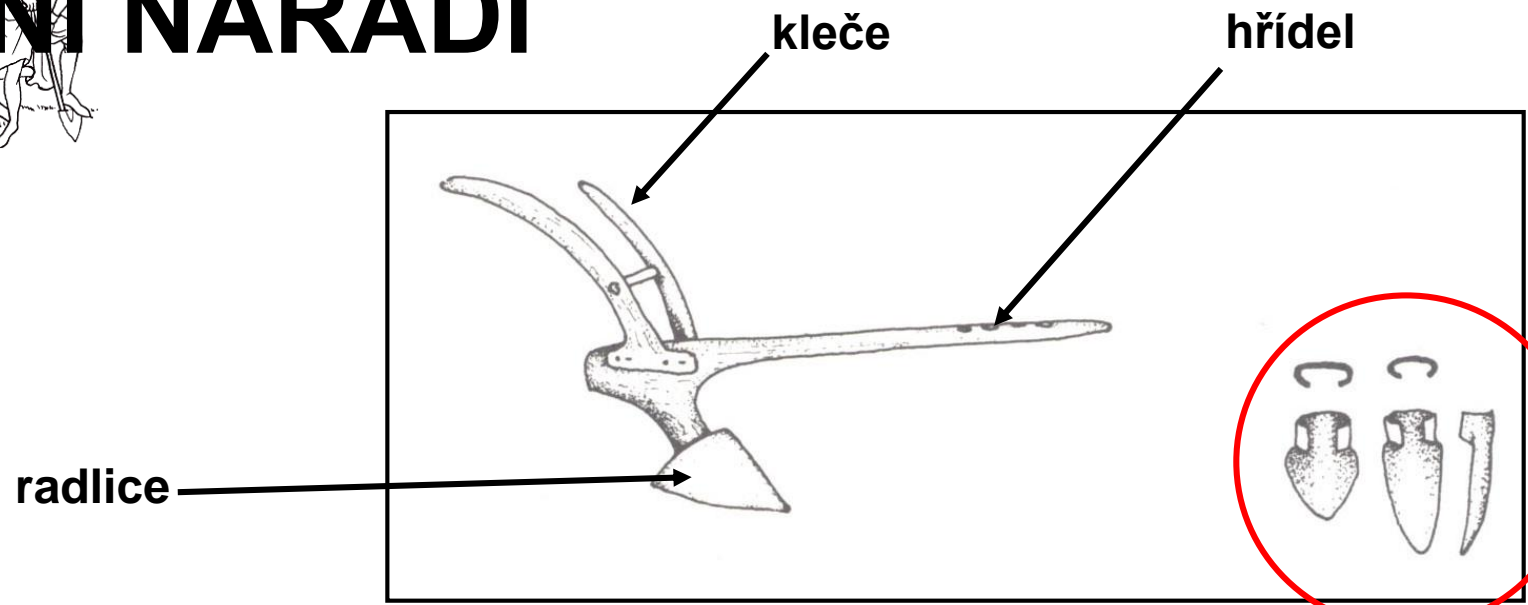
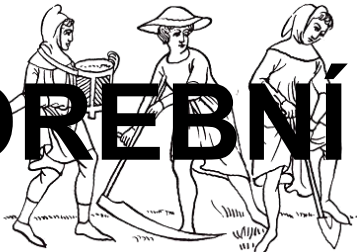



# OREBNÍ NÁŘADÍ

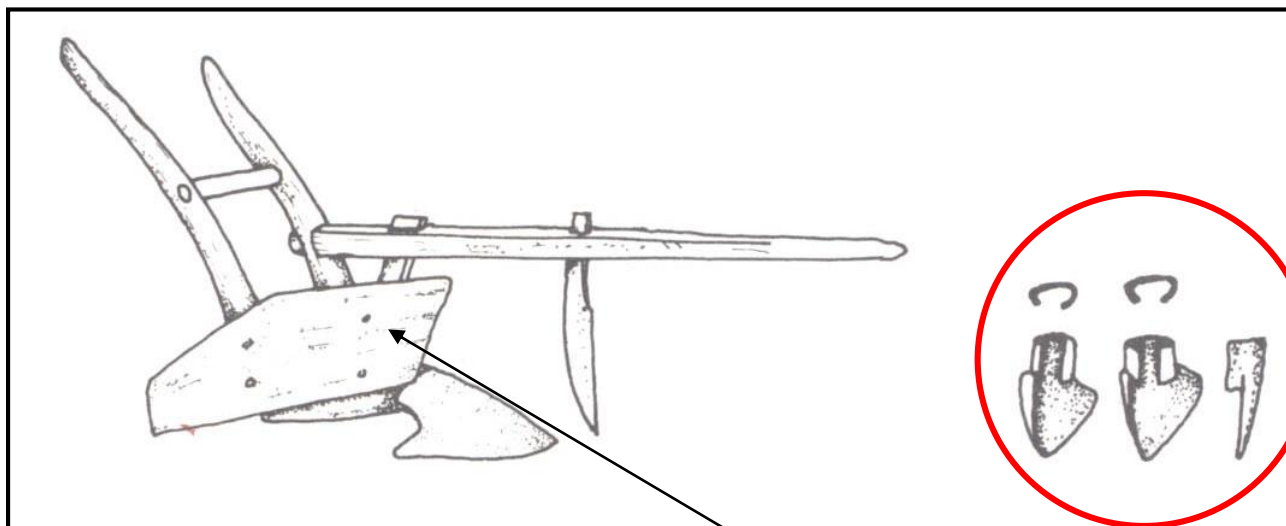
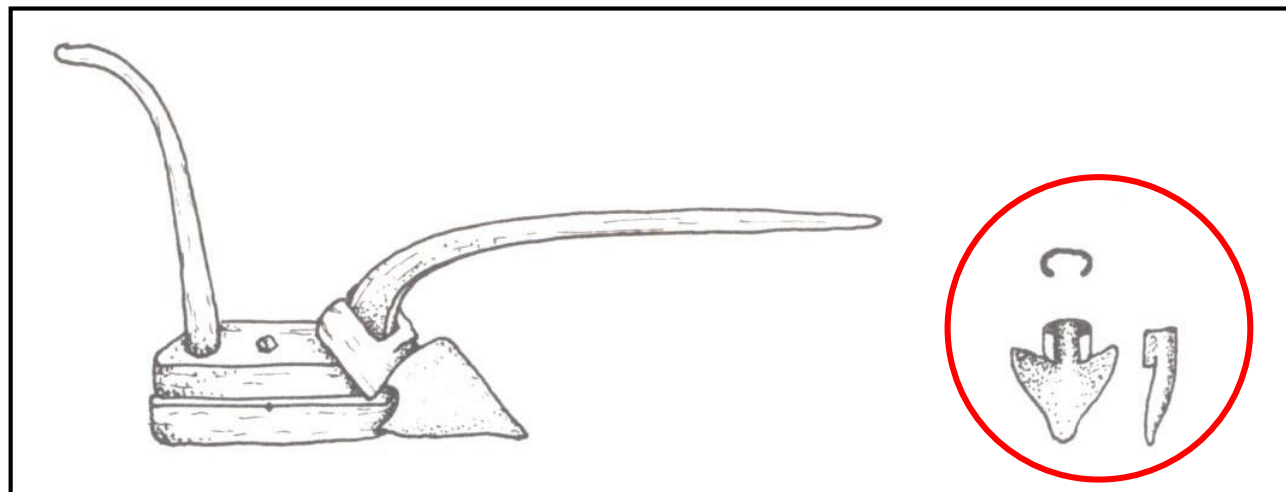

PLUH

odvalová plocha, odhrnovačka



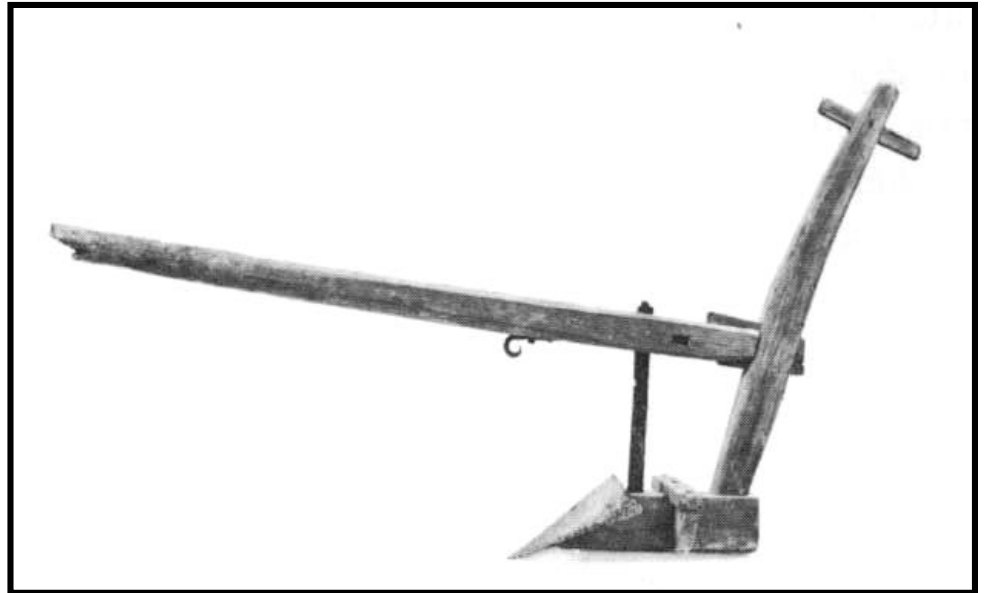

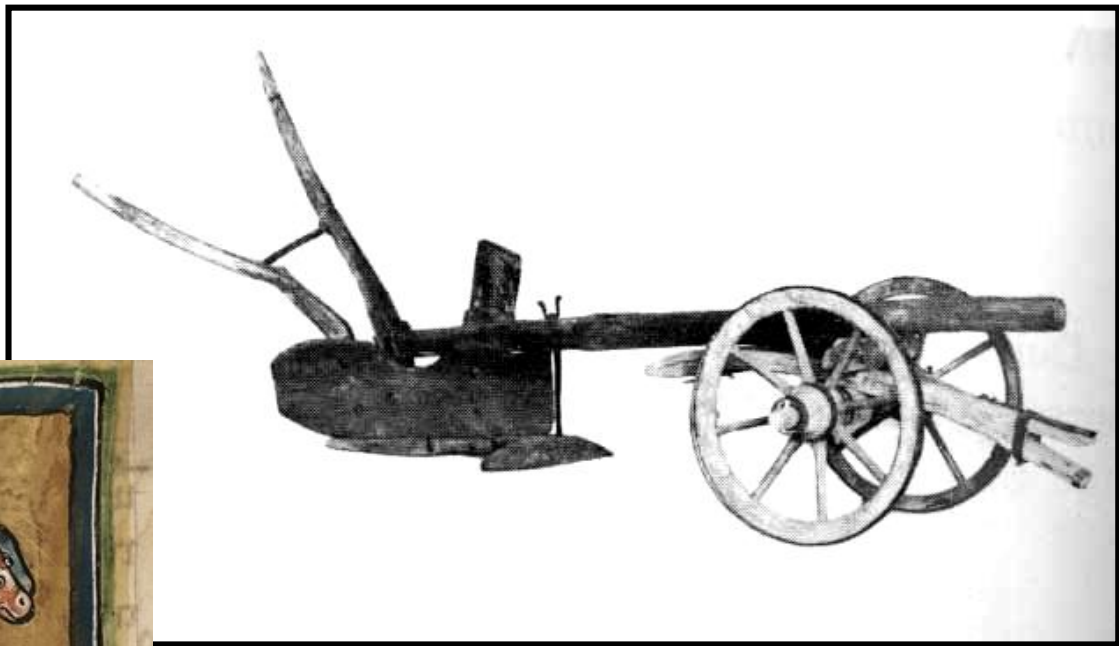



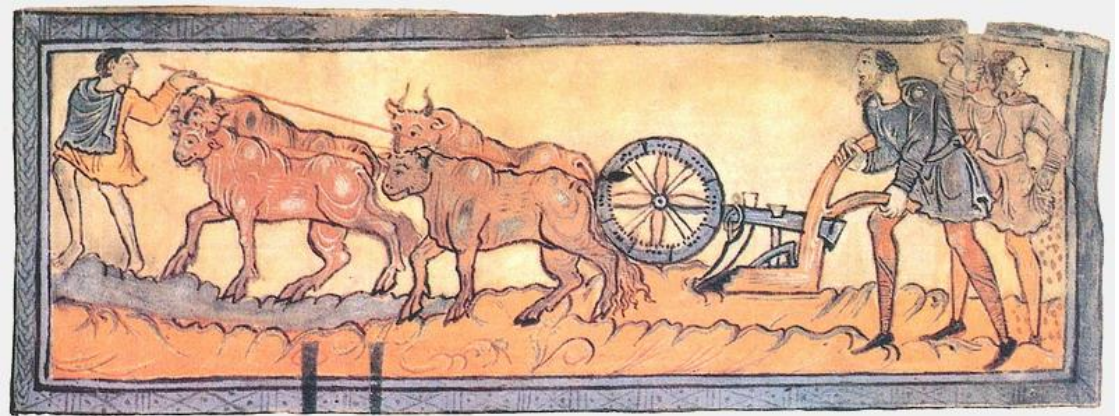

**C**amelus inde nomi accepit. fuit quia qu  
tur. ut breuior et humilior fiat. accul



RADLICE			
I	A 	B 	C 
II			

### Typ I – symetrická radlice

Bartošková 1984

**A** – radlice pětiúhelníková, menších rozměrů

**B** – radlice dýkovitá (pojmenovaná tak pro svoji délku a štíhlost)

**C** – radlice listovitá, čepel přibližně ve tvaru rovnoramenného trojúhelníku s dobře vyvinutými raménky

**D** – radlice veslovitá (dle Beranová 1980)

První symetrické radlice os LT (úzké, štíhlé)

DŘ: převaha listovité radlice převzaté z ilyrské oblasti

### Typ II – asymetrická radlice

- velmi málo

- jediným bezpečným dokladem pluhu

- M. Beranová - podle radlice v Gajary-Stoličce do 8. – počátku 9. století X A. Bartošková: problematický

celek → dle dalších nálezů od 9., případně 9.-10. století



# RADLICE

- symetrická
- asymetrická
- kopinatá
- veslovitá

čepel

ostří

hrot

tulej

laloky

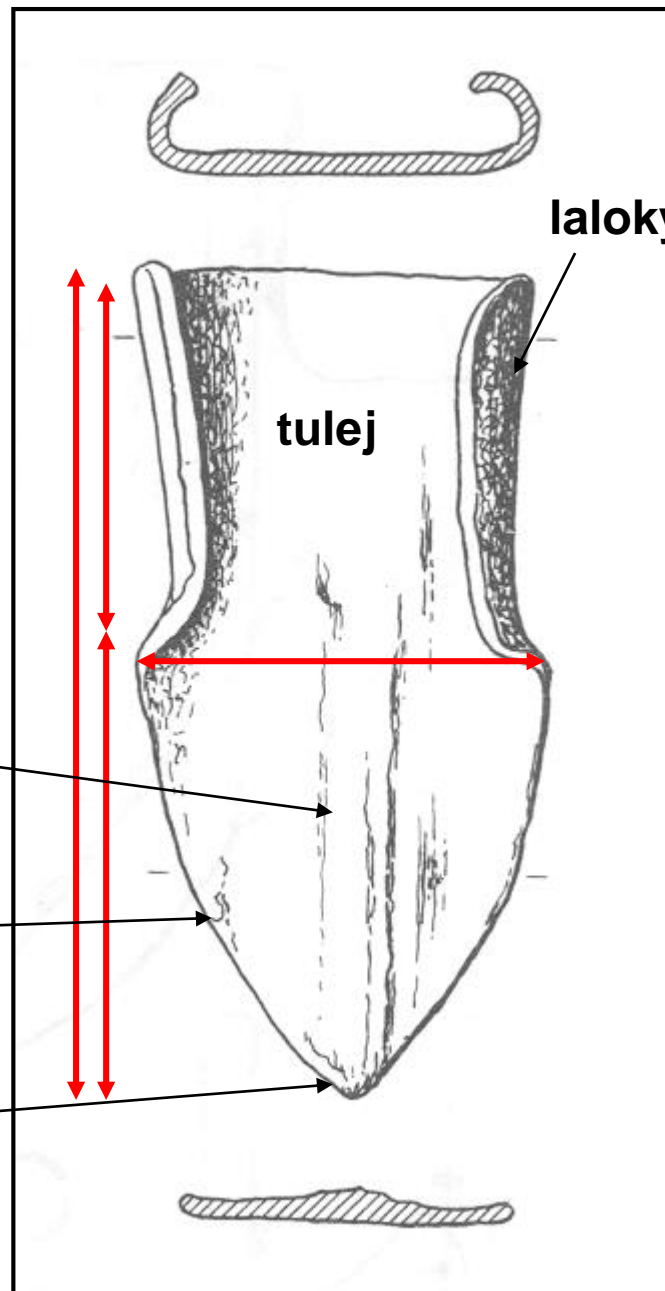

radlice symetrická



## radlice asymetrická

od **RS**

## **VS** - uplatněním trojpolního systému

Praha-Vysočany (12.-13. století), Sezimovo Ústí (před 1420), Batňovice (poč. 14. století), Sovadina, Litoměřice, Pfaffenschlag (13./14. století), Semonice (poč. 14. století), Tisová

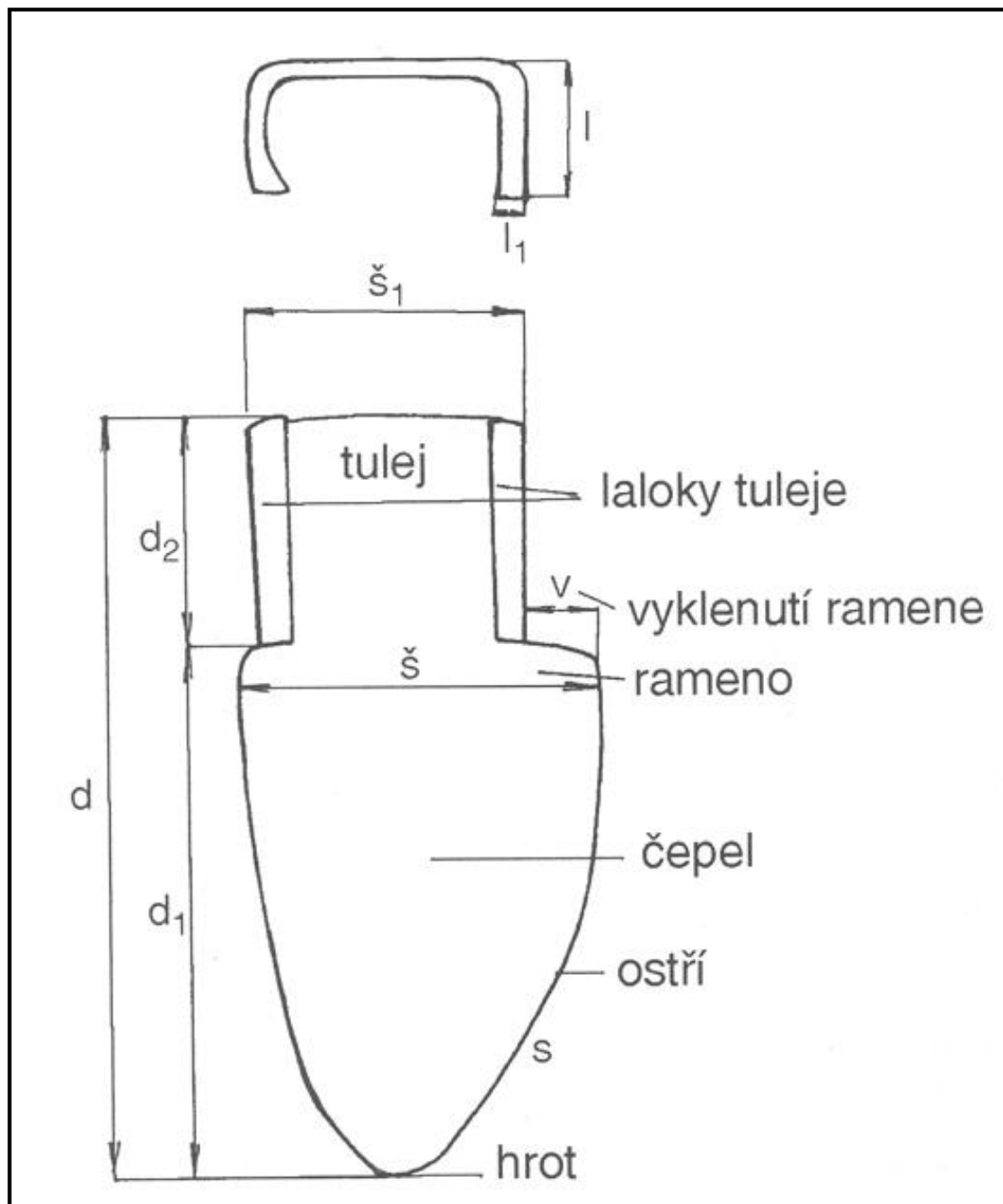

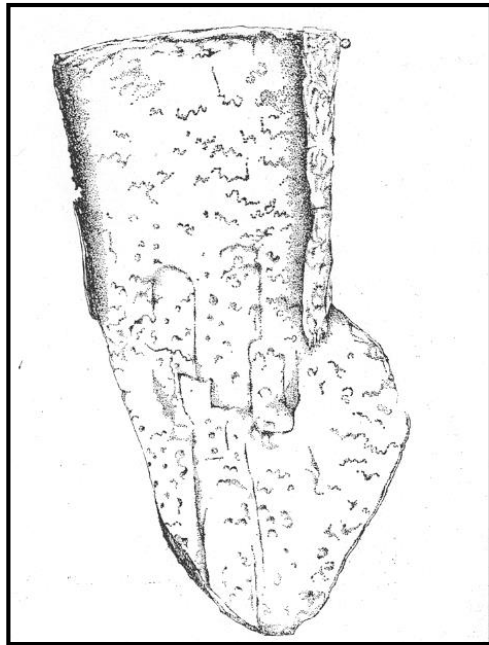
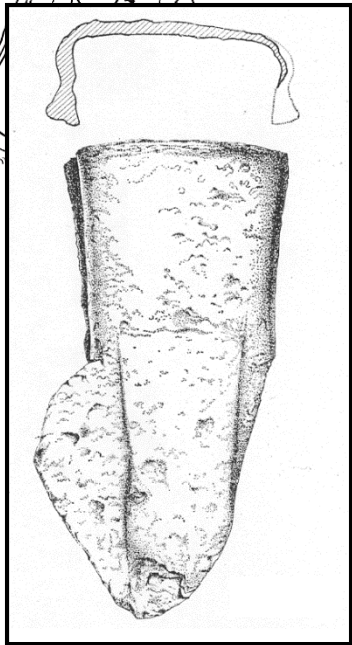

**Semonice**

**Pfaffenschlag**



**Sovadina**

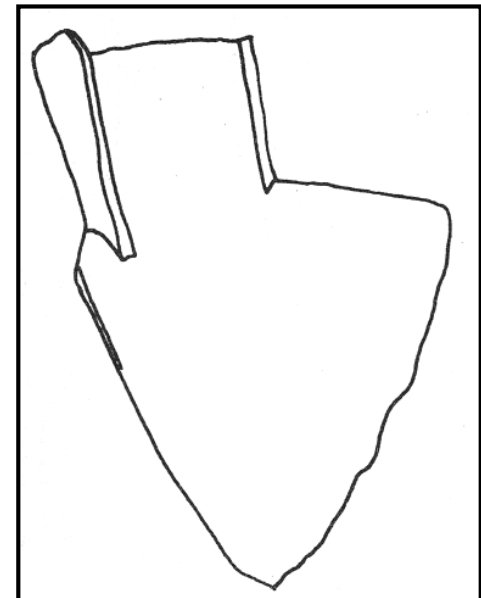
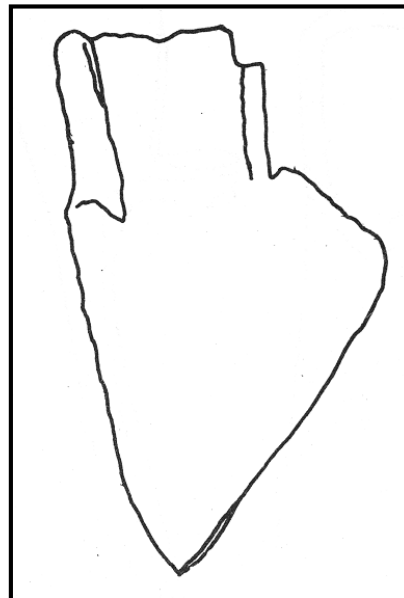

# radlice kopinatá



Pfaffenschlag (5 ks),  
Kravín (3 ks)  
Lelekovice  
Templštejn (3 ks)  
Mstěnice  
Sezimovo Ústí (9 ks)

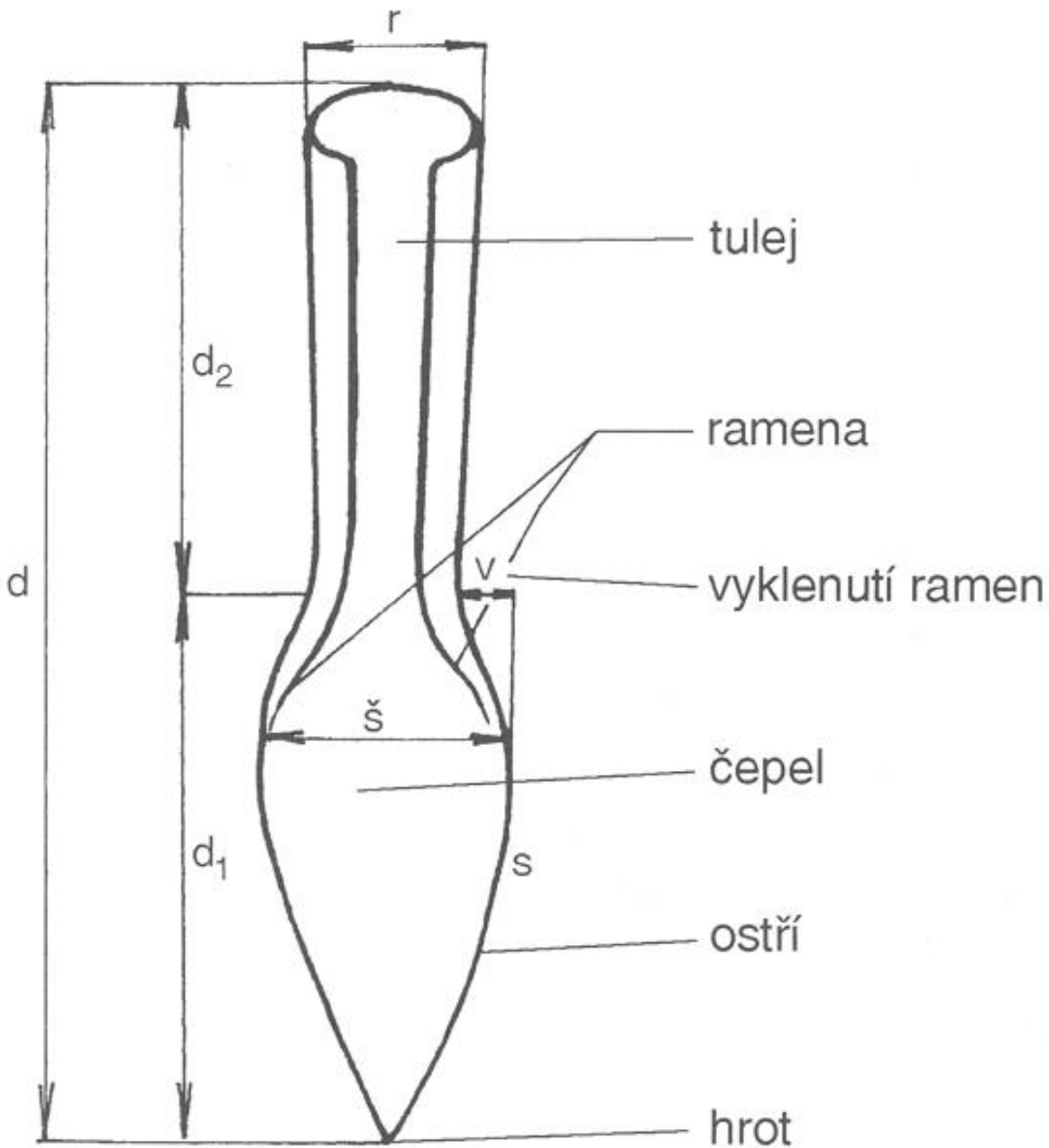



# Mstěnice



# Pfaffenschlag

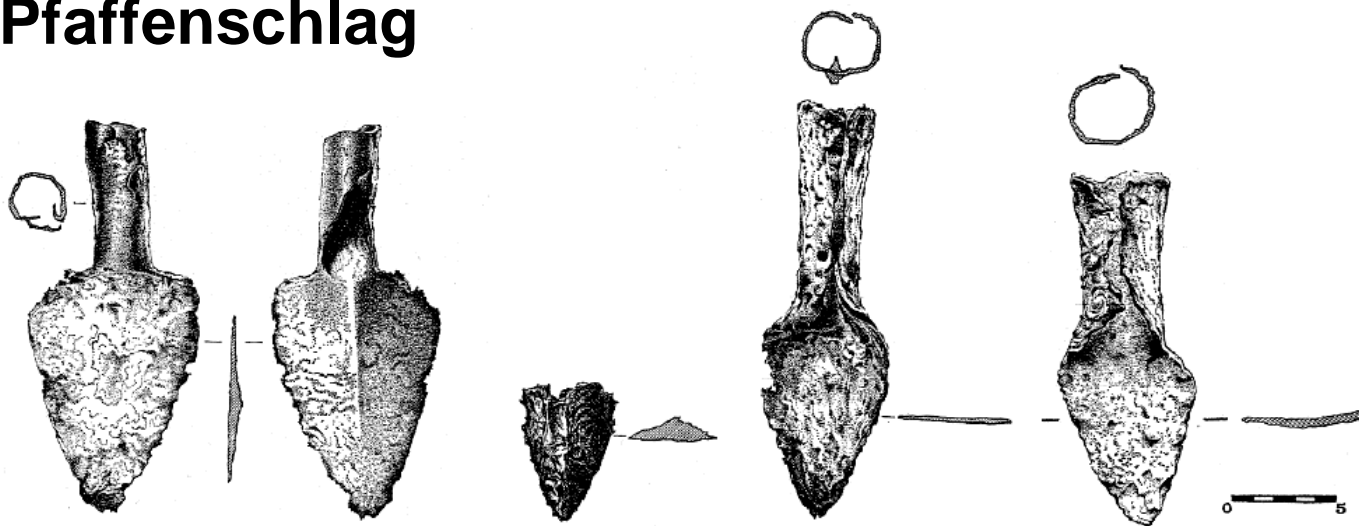



# radlice veslovitá



násada

čepel

hrot

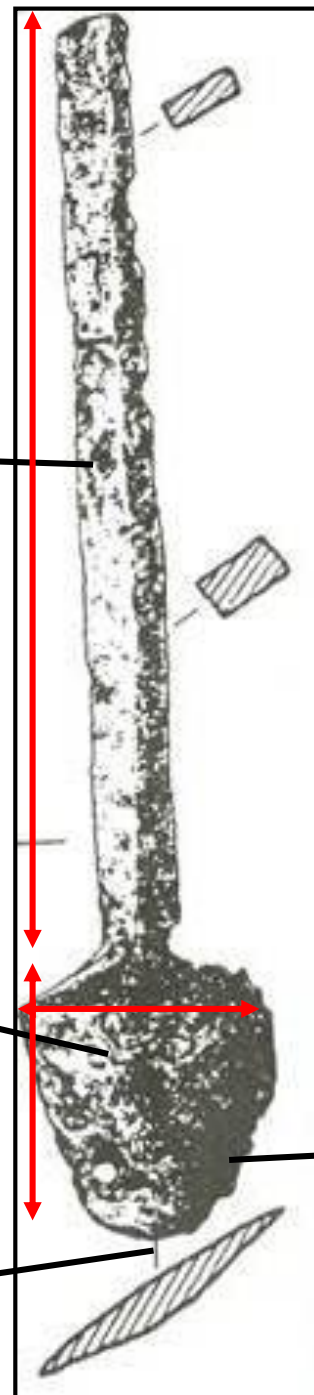

Gajary - Stolička

1

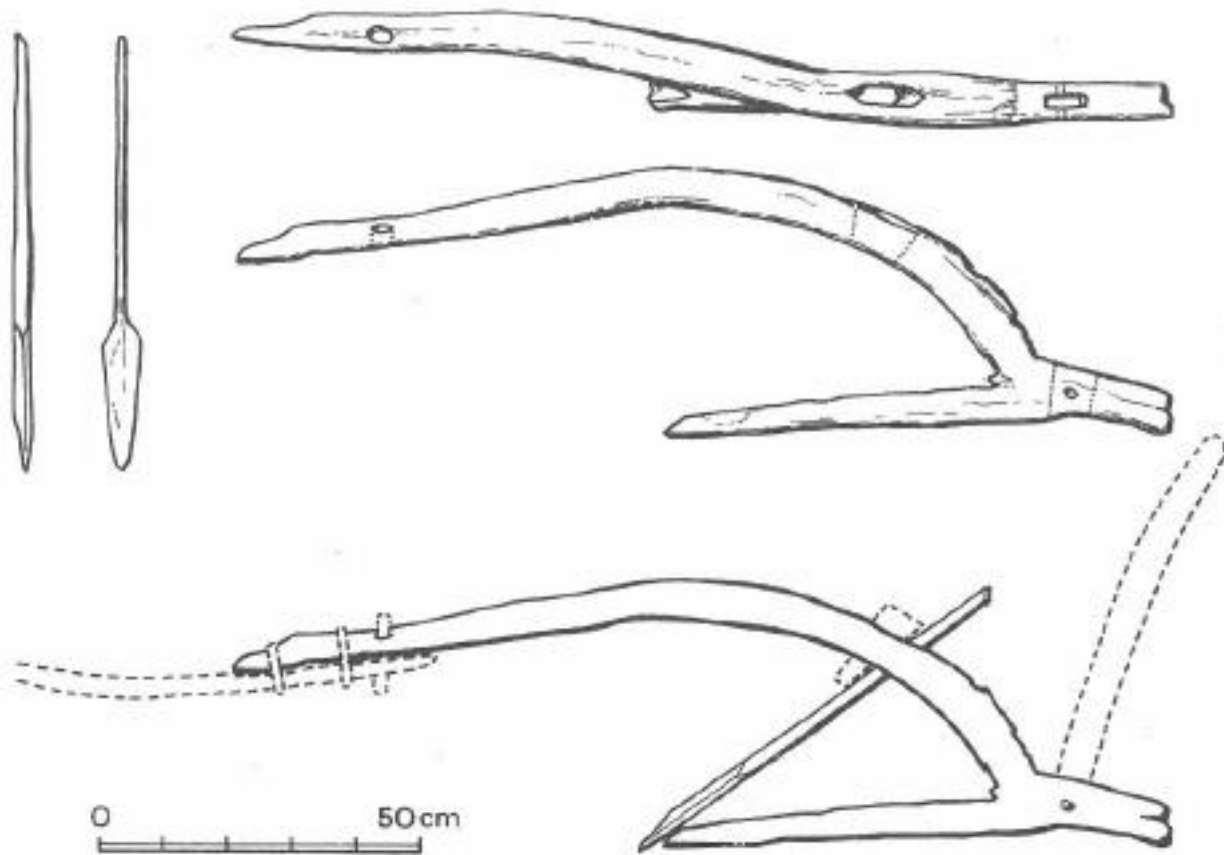

Dřevěné rádlo + dřevěná veslovitá radlice (Německo: Dabergotz)



# KROJIDLO

- Mstěnice
- Sezimovo Ústí
- Záblacany
- Batňovice
- Semonice
- Konůvky



násada

$a \times b$

$d_2$

$d$

$\check{s}$

nůž - čepel

hřbet

$s$

ostří

$d_1$

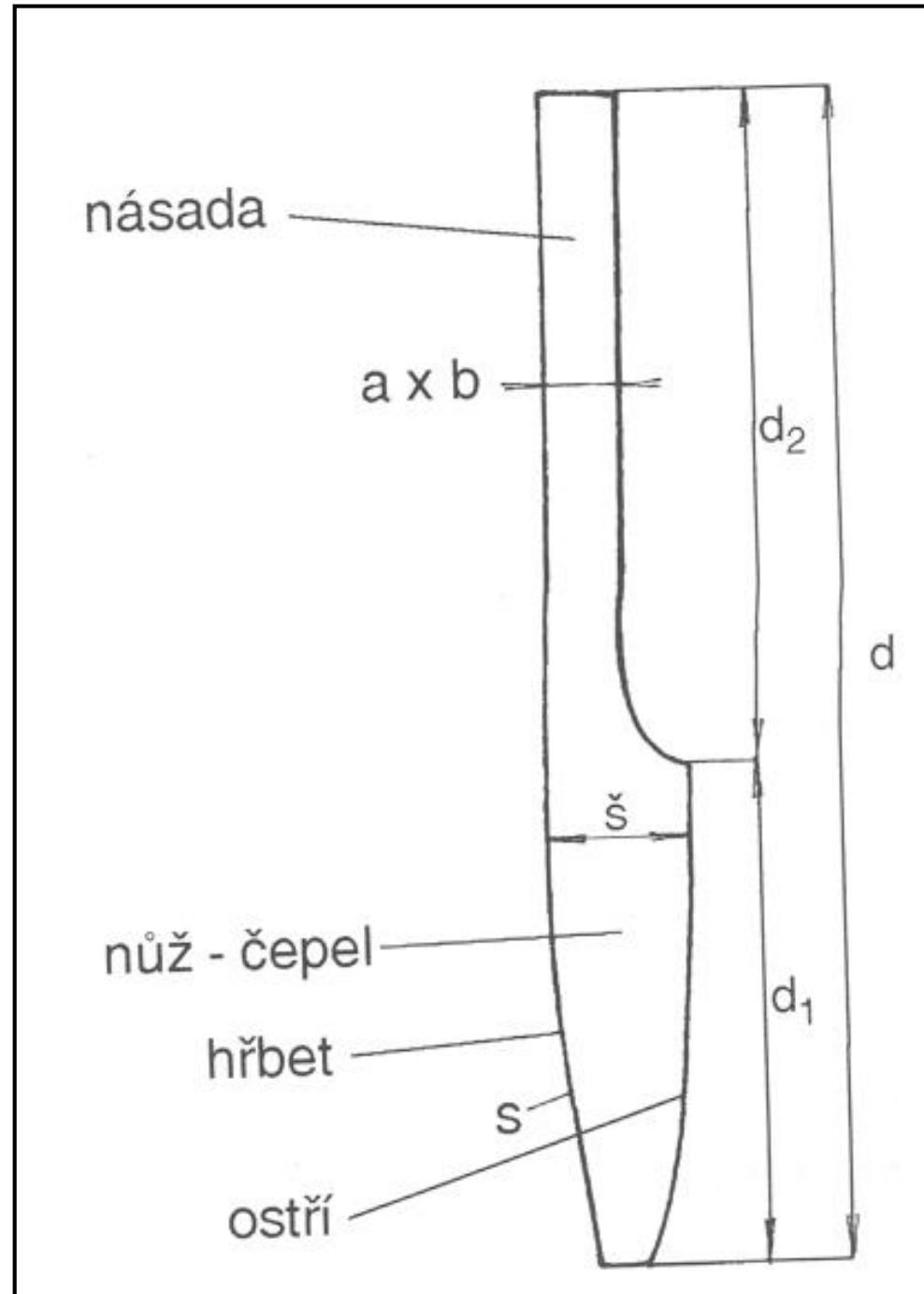



# KROJIDLO

- Semonice (2 ks)
- Svídna
- Bystřec
- Pfaffenschlag
- Mstěnice

Semonice

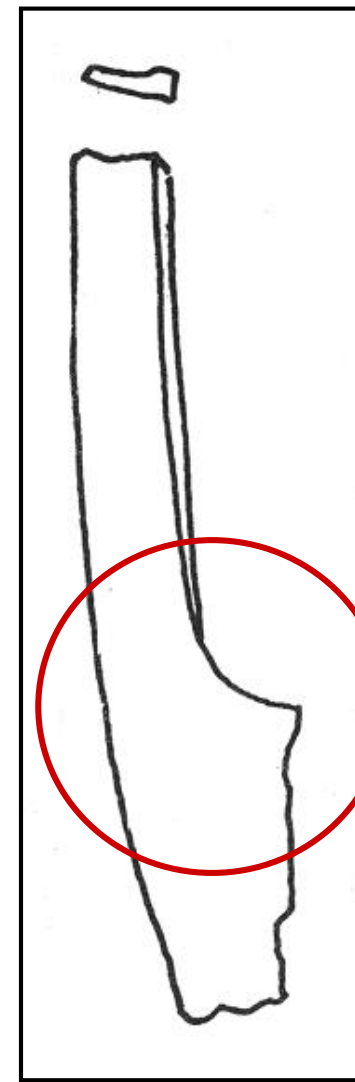
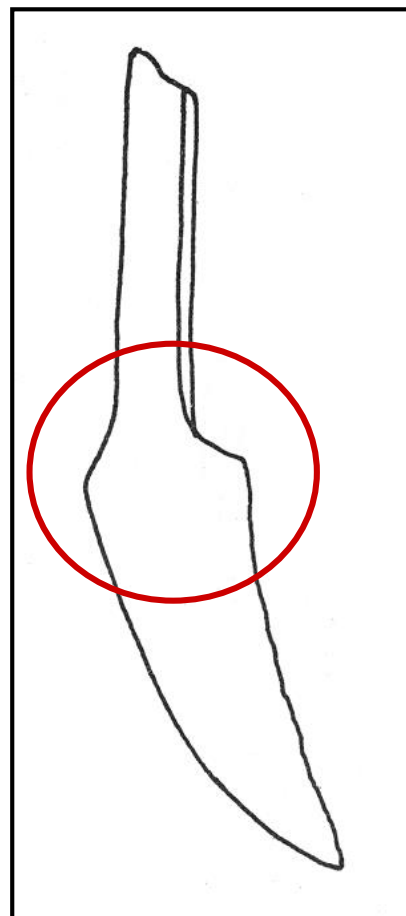
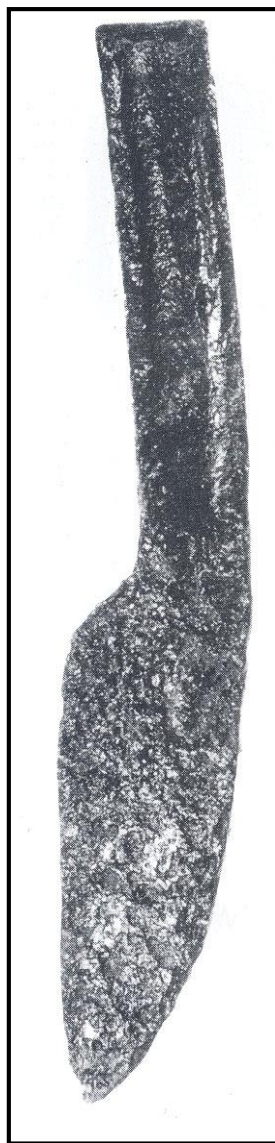

Mstěnice

M. Beranová 1980:

**Typ I – krojidlo s dopředu vystupujícím, ostře odsazeným břitem čepel**

Délka čepel krojidla a její poměr k násadě se různí - *běžný tvar*

**Typ II – krojidlo s málo nebo vůbec vystupující čepelí**

Pokud čepel vystupuje, je přechod mezi břitem a násadou pozvolný, zaoblený a čepel není ostře odsazená



## Semonice

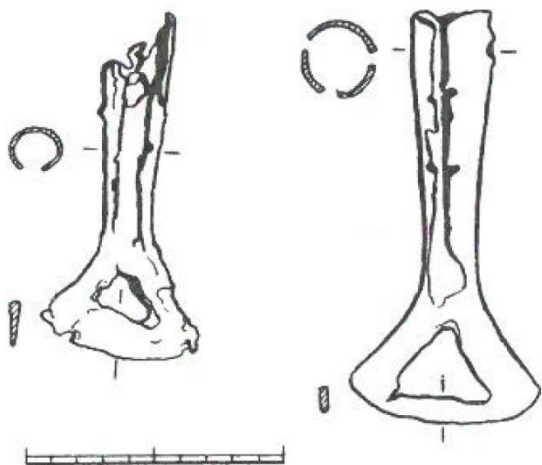

# OTKA

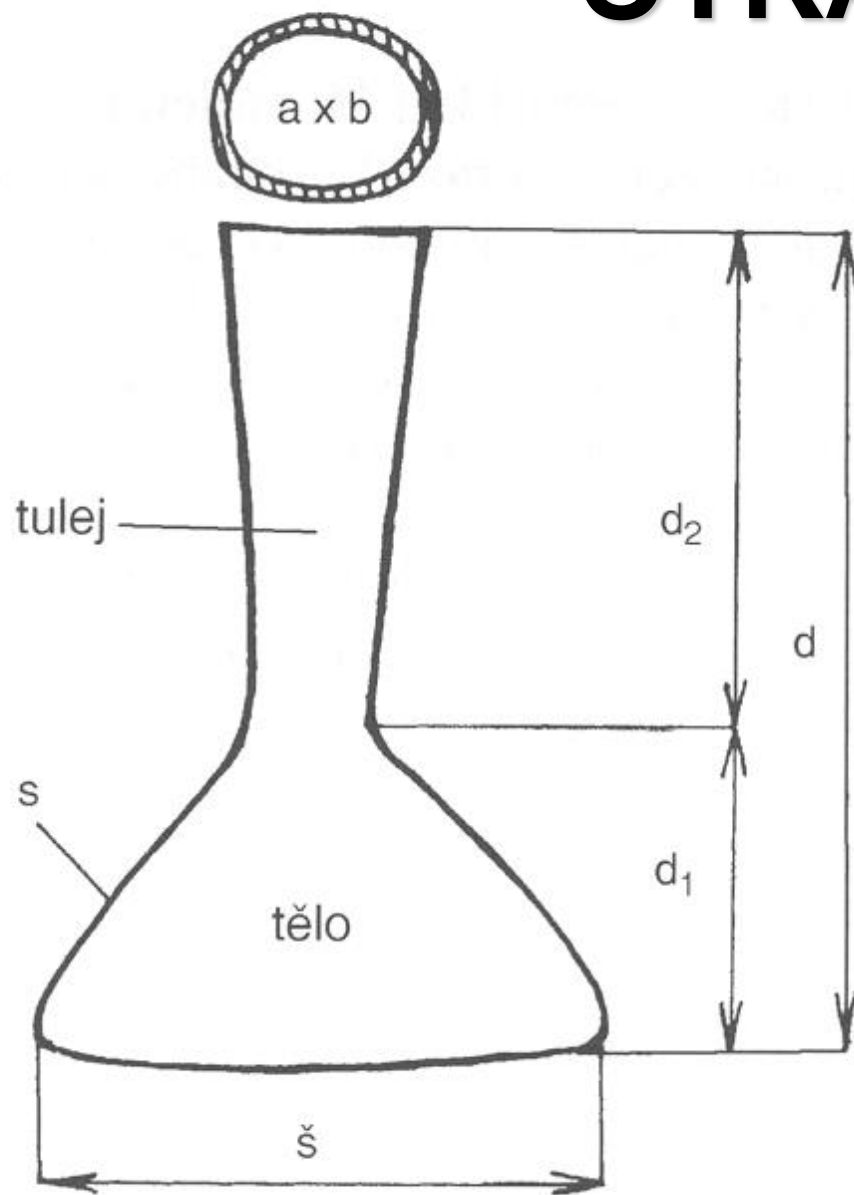



# OTKA

## Semonice

počátek 14. století

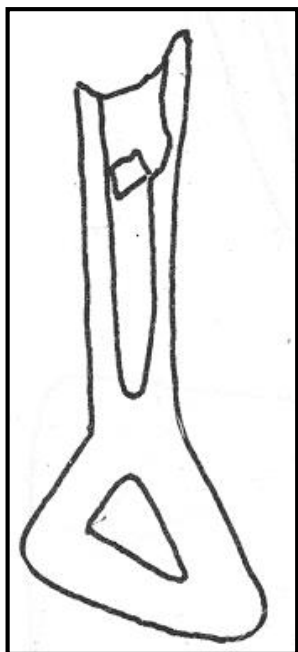

## Martinice

15./16. století

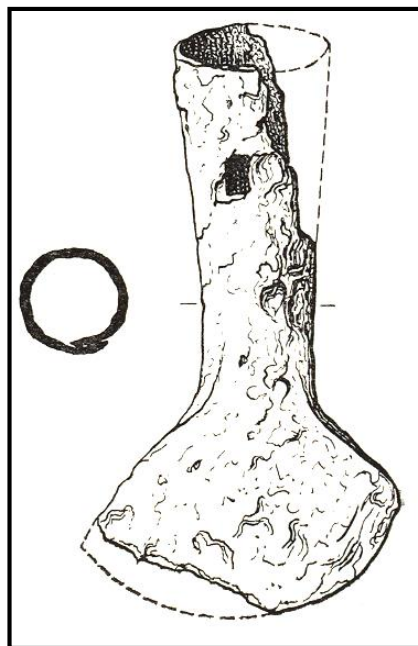



# BRÁNY

zub brány

$d = 10 - 30 \text{ cm}$

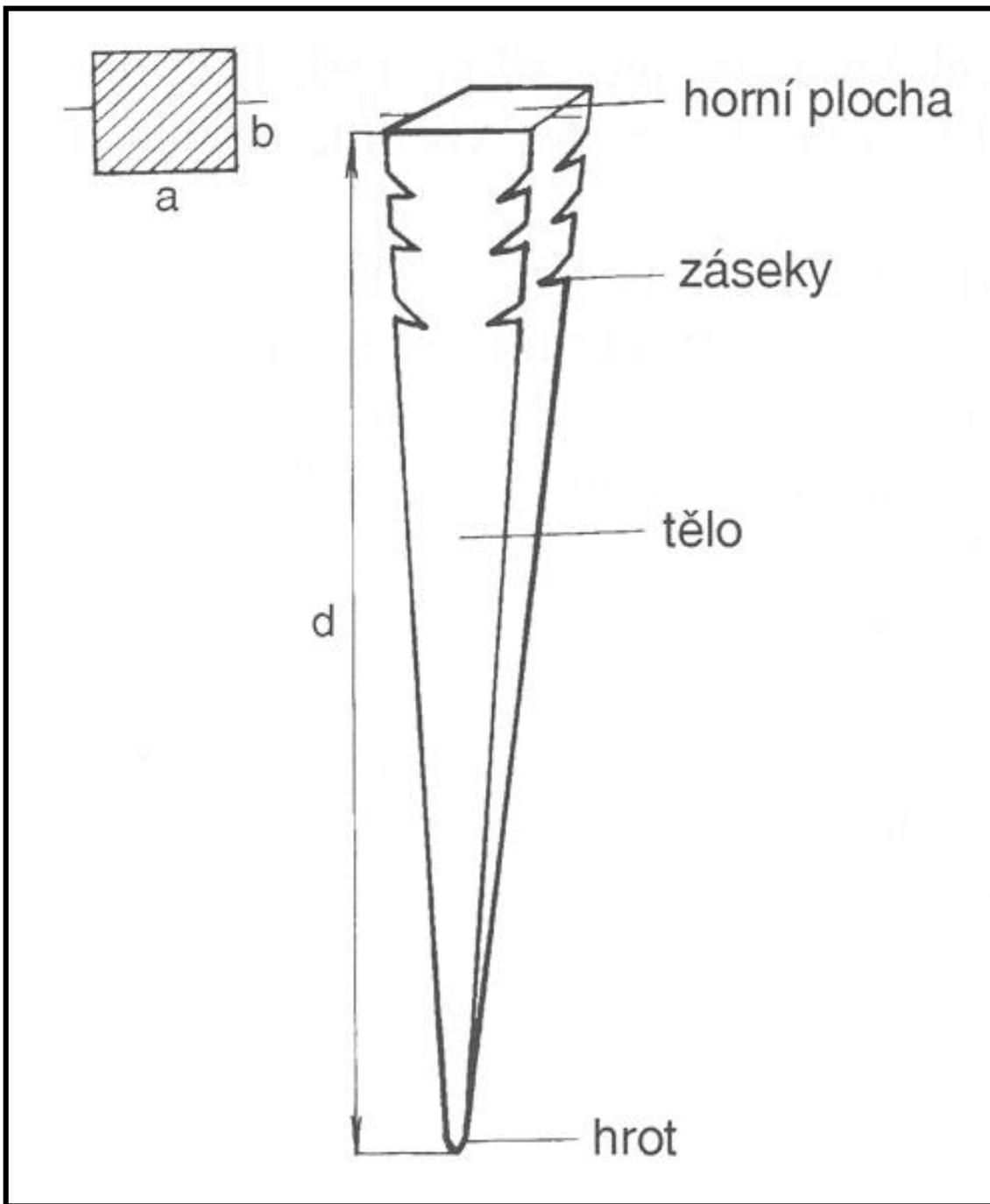



# BRÁNY

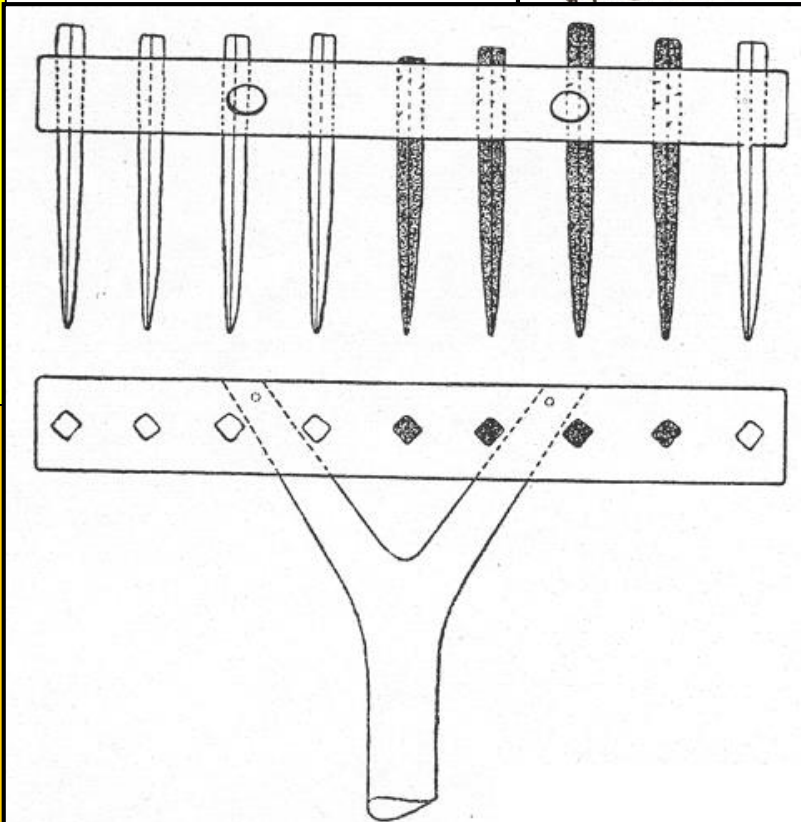
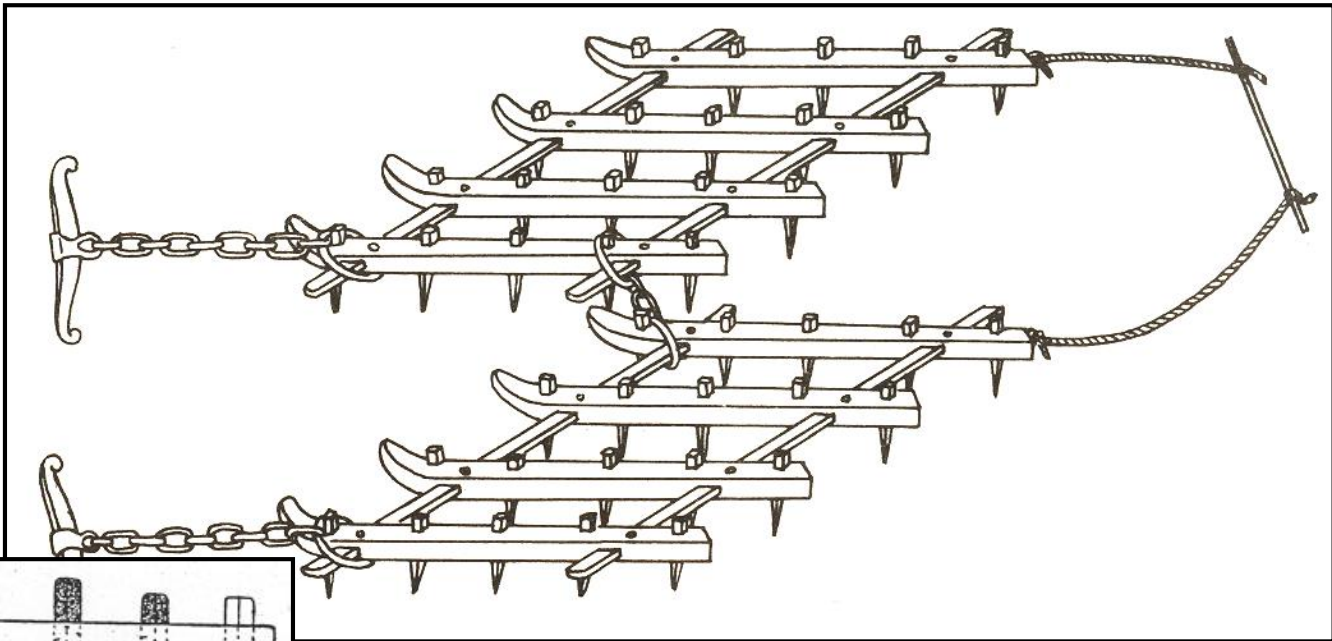

Smetánka, 1956



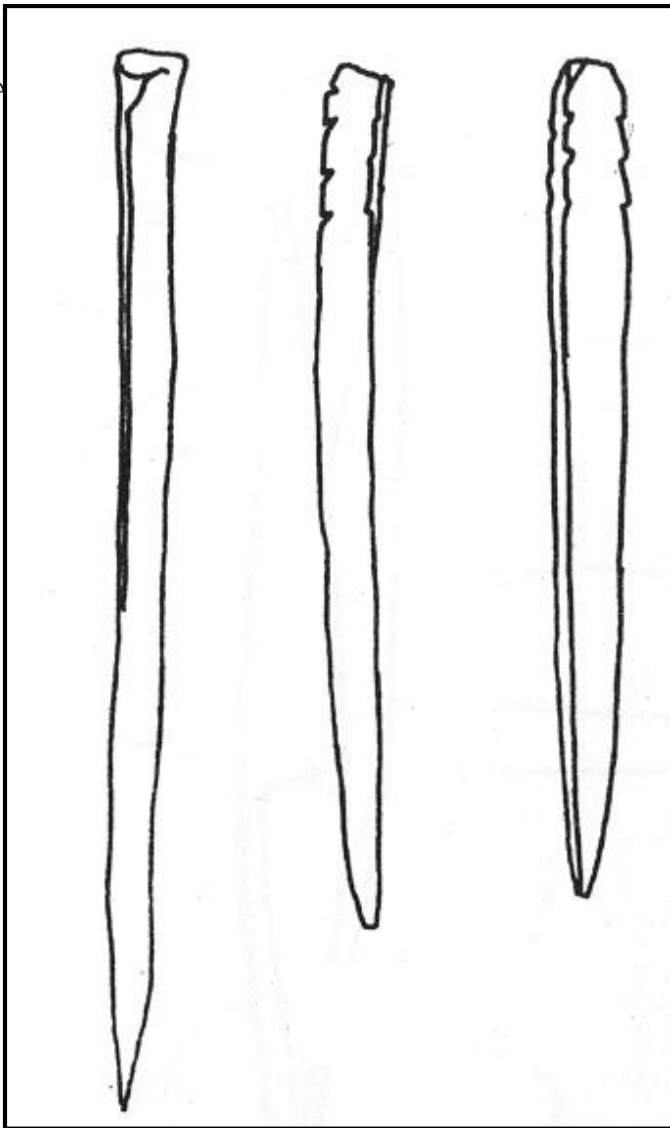

**Semonice**

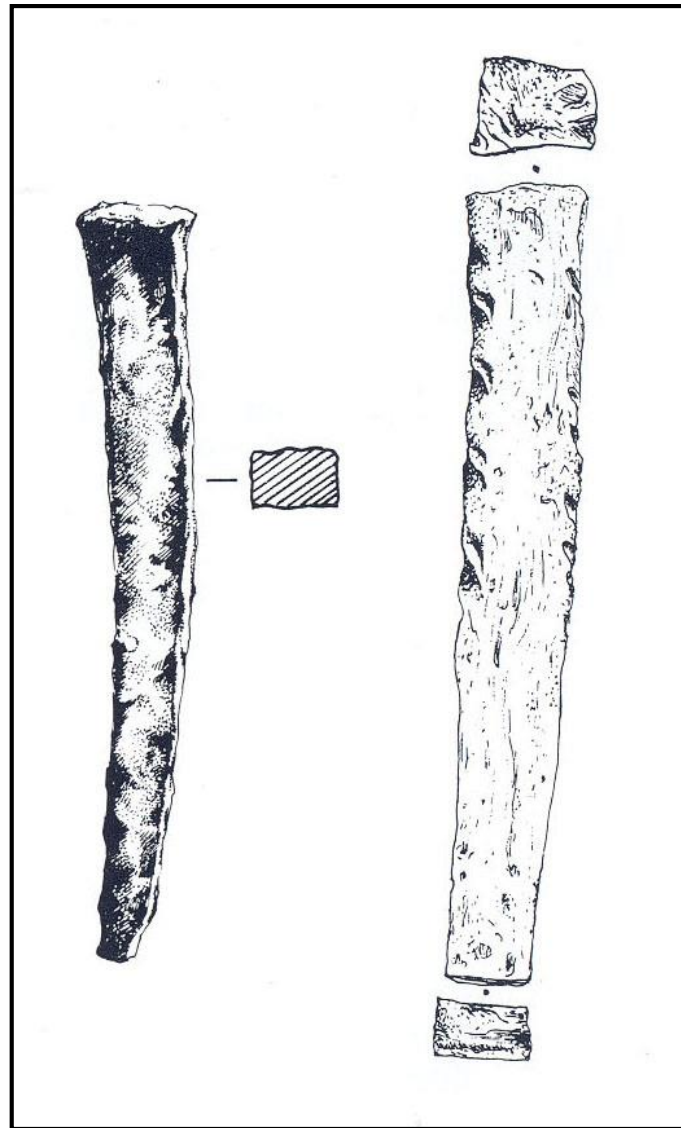

**Mstěnice**



# MOTYKA



**breviř kláštera sv. Jiří**  
kolem 1400

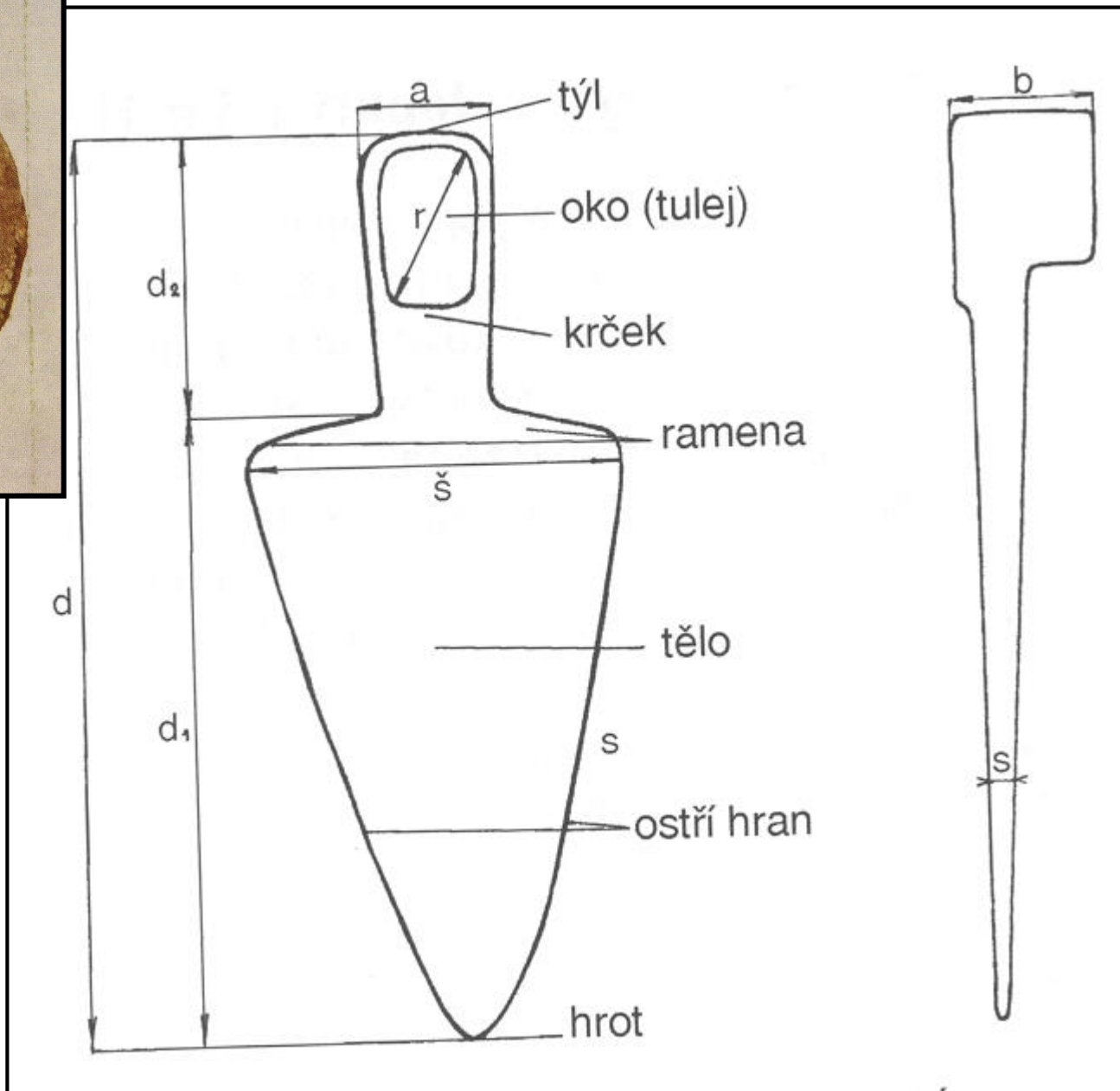

**Typ I – motyka s prodlouženým, poměrně štíhlým týlem a s krátkými trojúhelníkovitými ostny při násadním otvoru**

**Typ II – motyka s krátkým, tupě zakončeným týlem a trojúhelníkovitými ostny při násadním otvoru**

**Typ III – motyka s oboustranným štitkovým týlem a trojúhelníkovitými zaoblenými ostny při násadním otvoru**

**Typ IV – motyka bez týlu a ostnů**



# MOTYKA

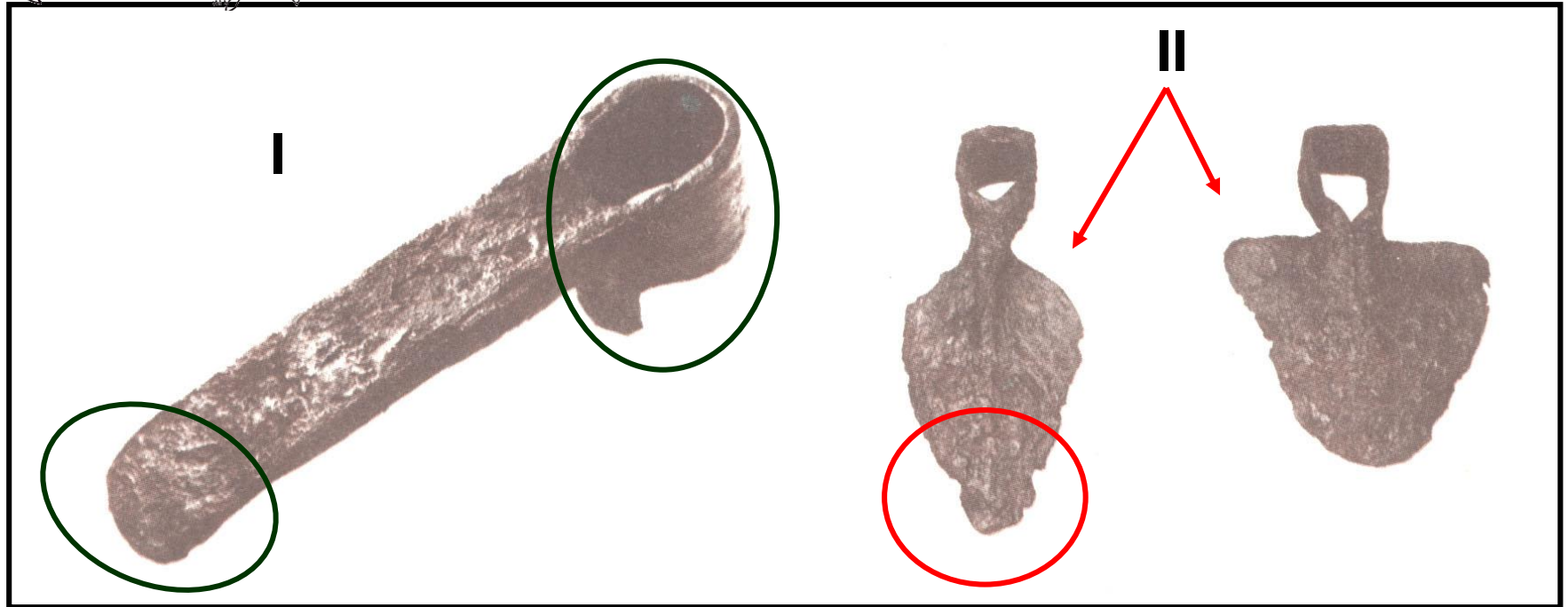

I. **KLUČOVNICE** (dlouhé motyky, Krajíc 2003: **typ I a – c**)

II. **KRATEC** (široké motyky, Krajíc 2003: **typ II a – b**)



# TYP I

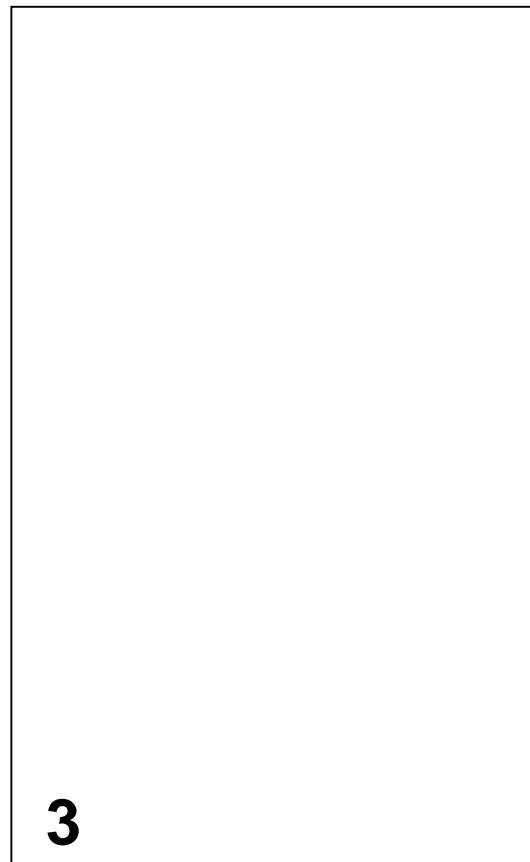
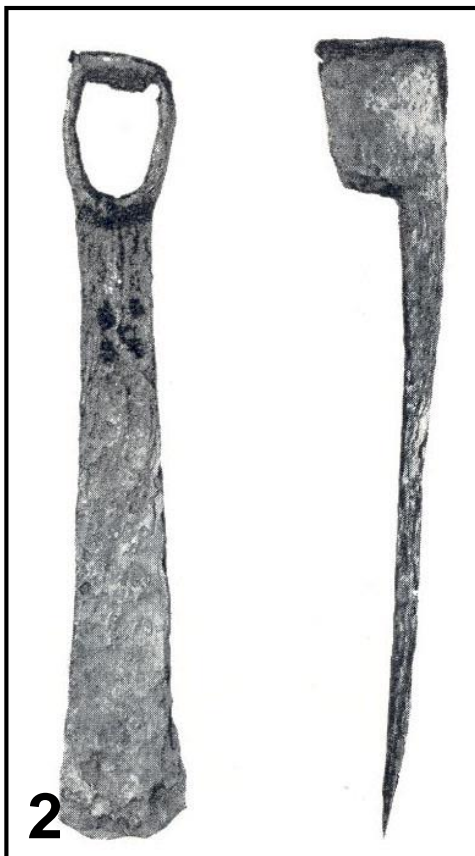

1. Semonice

2. Semonice



## Mohelnice

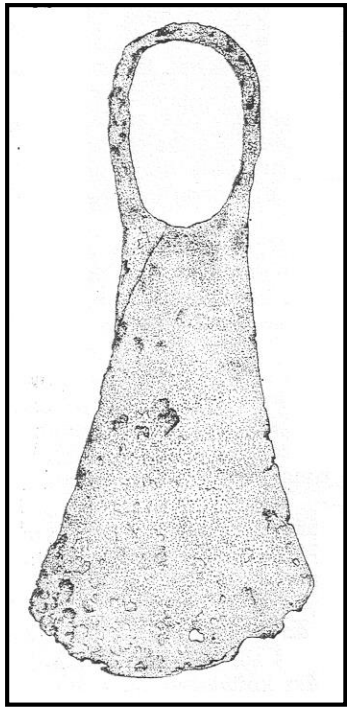

Typ Ia

## Semonice

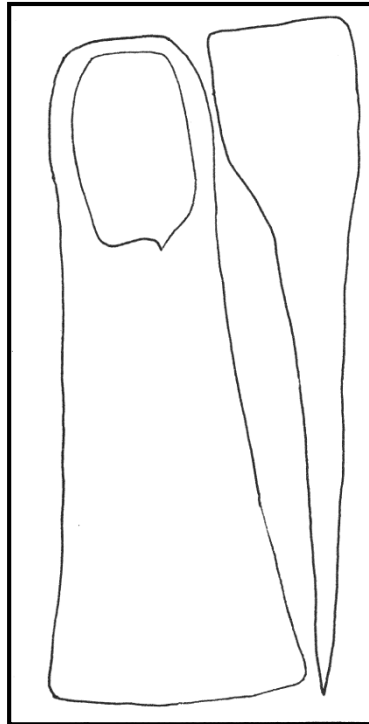

Typ Ib

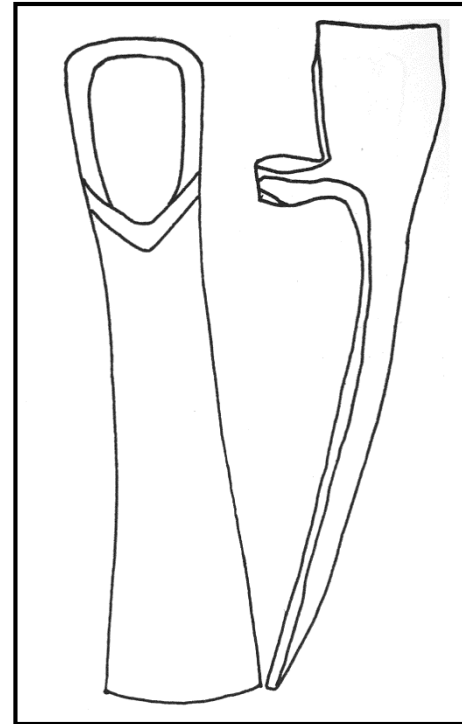

Typ Ic





## TYP II

### Hradištko u Davle

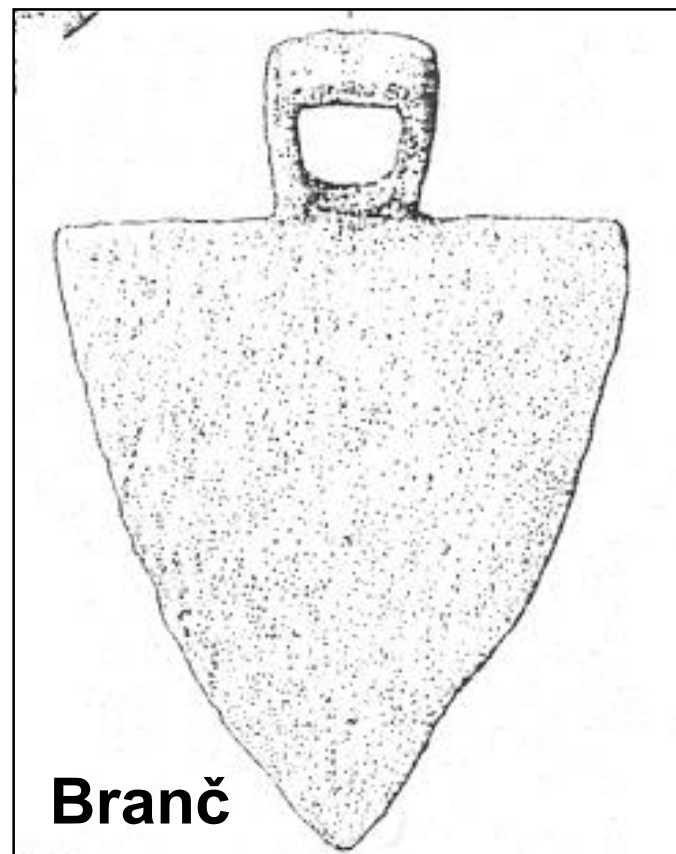
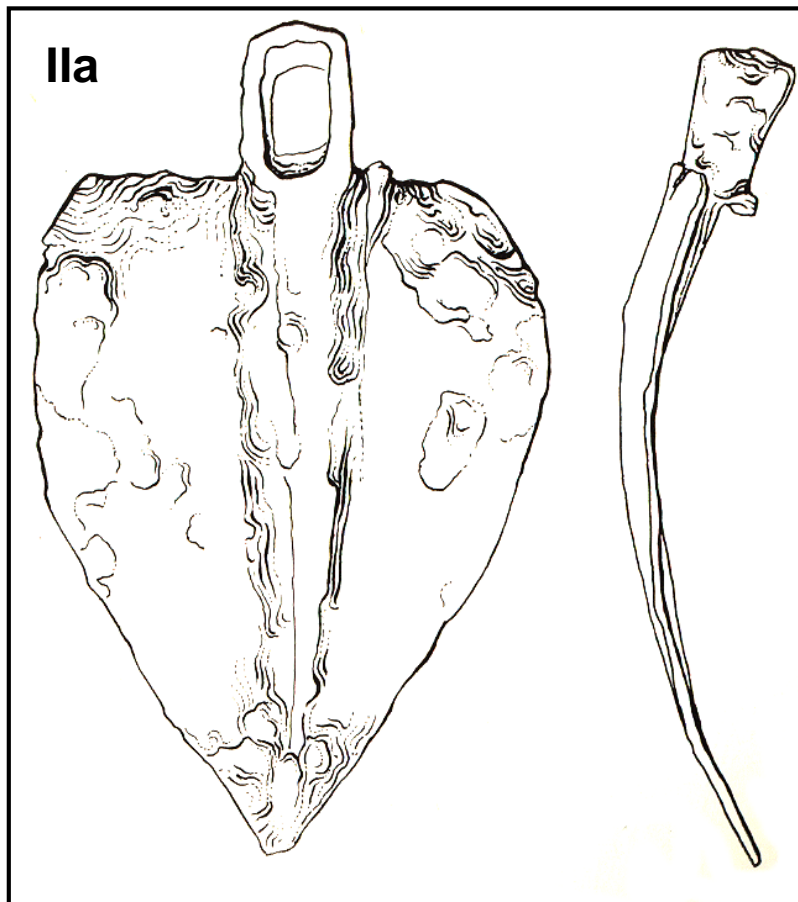

Branč



**SRP**





Queen Mary's Psalter (c. 1320)



Velislavova bible





# třídění srpů podle Beranové 1957

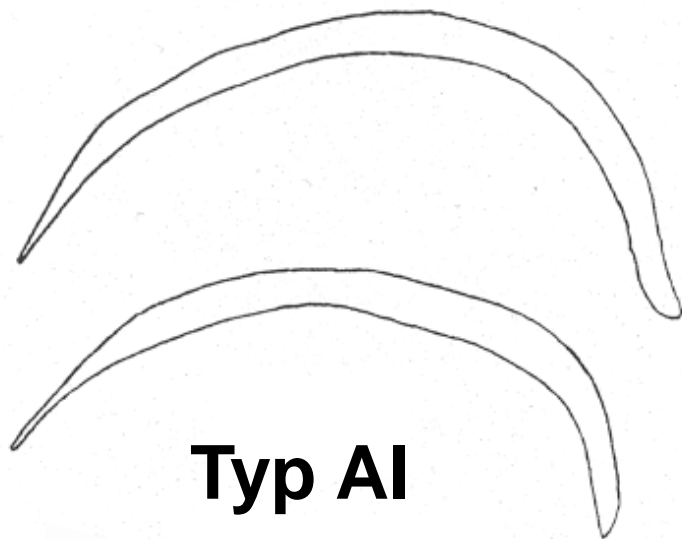

**Typ AI**

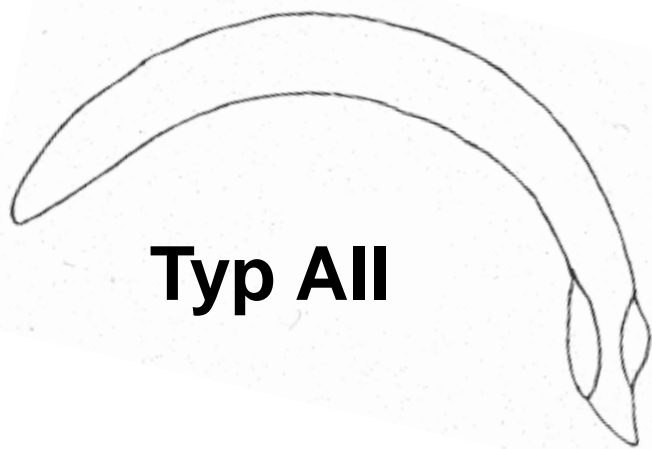

**Typ AII**

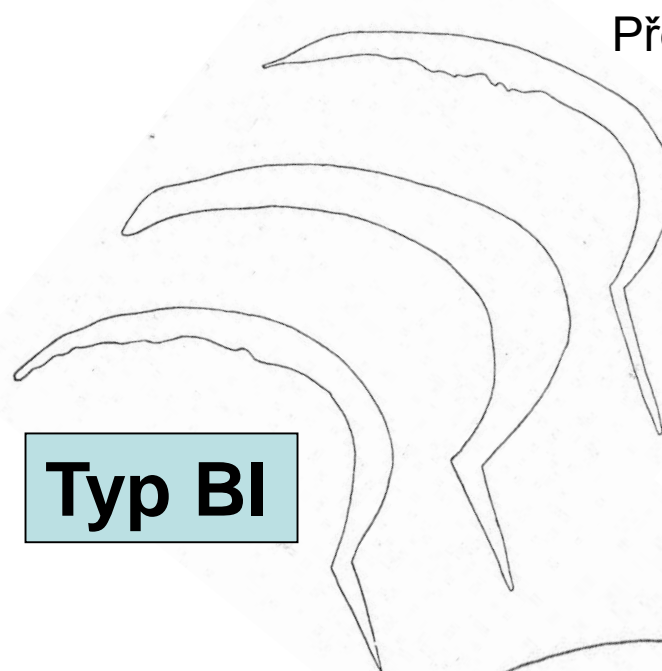

**Typ BI**

Převládající tvar RS

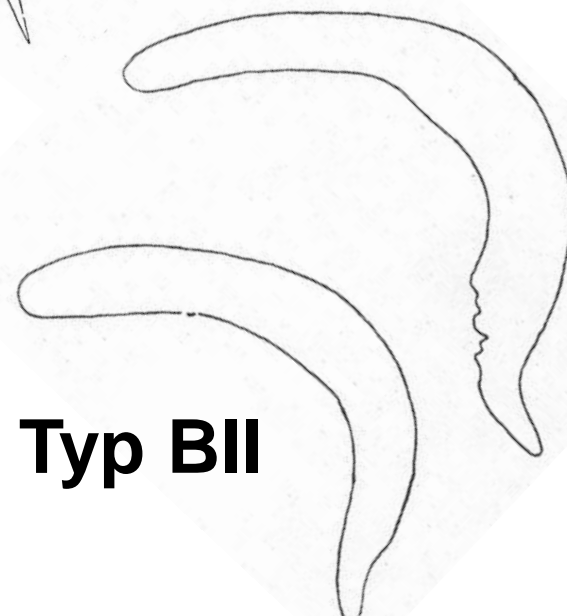

**Typ BII**



# Mikulčice

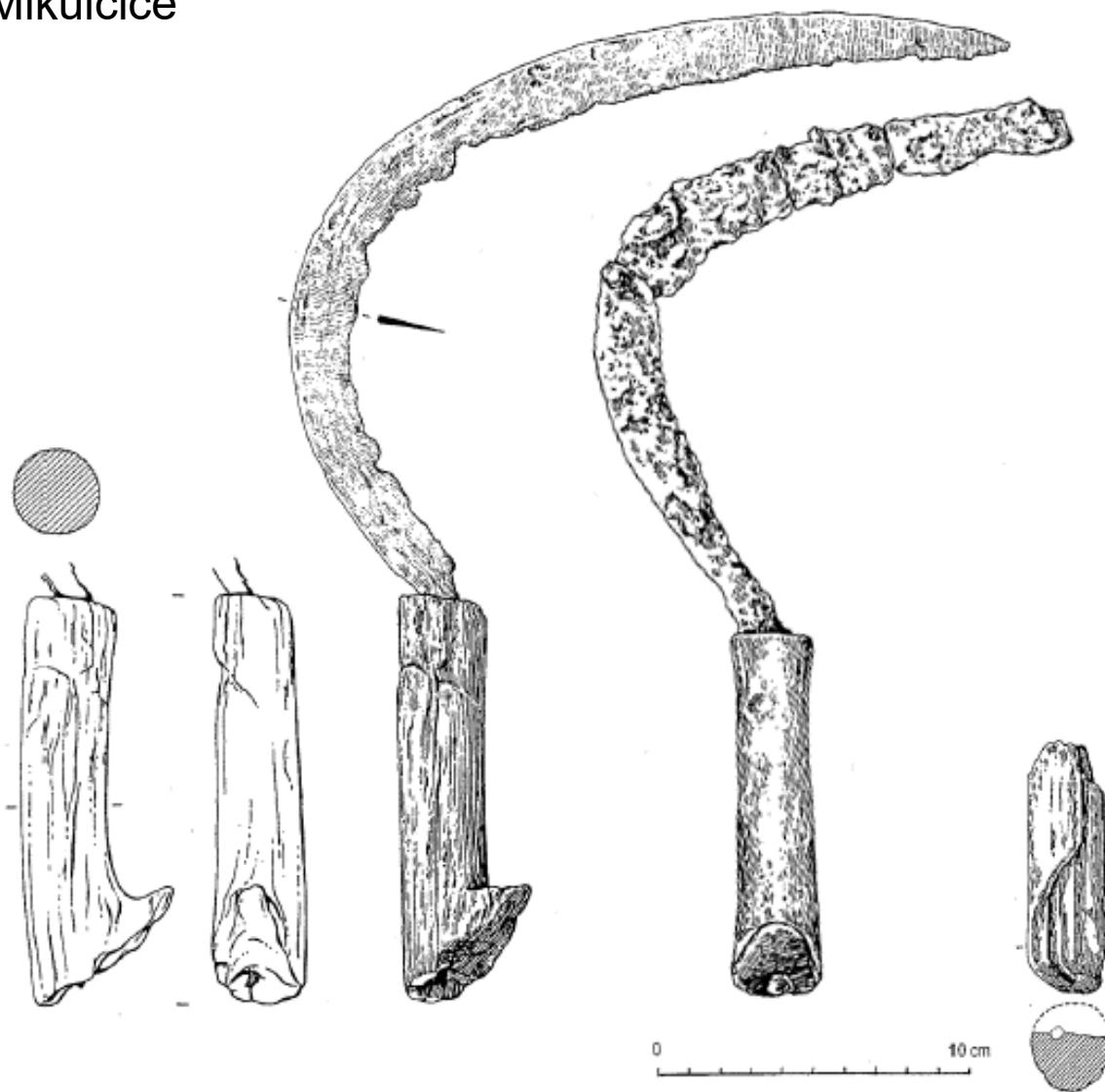



# třídění srpů podle Beranové 1957

## Typ C1

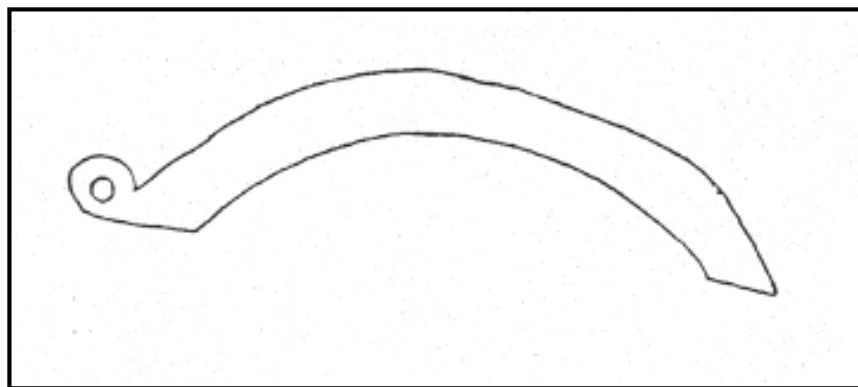

## Typ C2

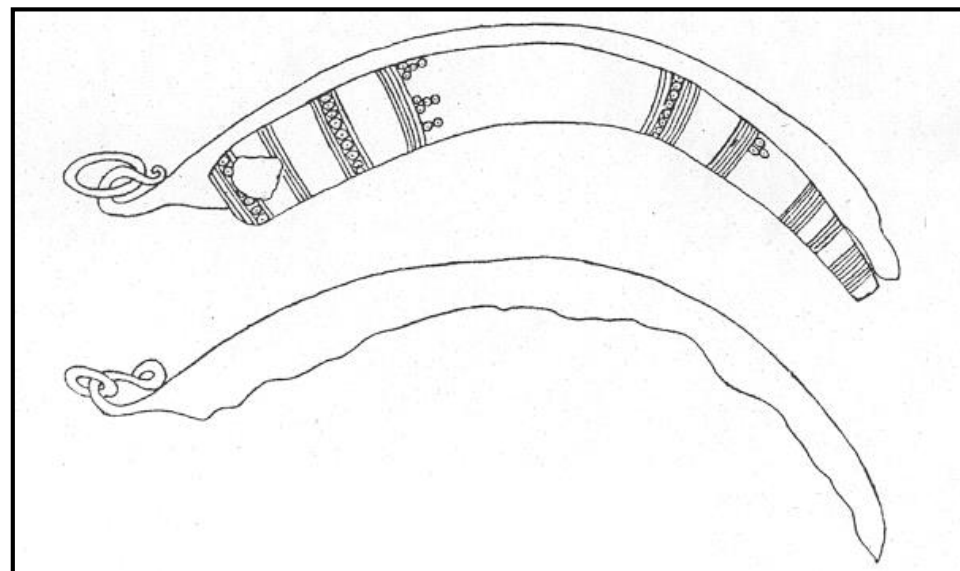

období 6. – 12. století



# srpy v západní Evropě

**Typ BI**



Franský srp RS



**Typ c**

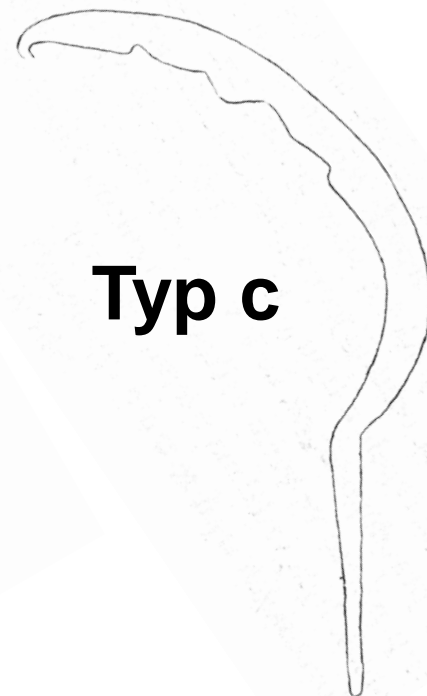





d I Oblouk čepel málo ale rovnoměrně zakřivený

d II Oblouk čepel málo ale rovnoměrně zakřivený + hranatý

**Typ d III**

**Typ d II**

**Typ d I**

d III Zalomení a výrazný oblouk čepel

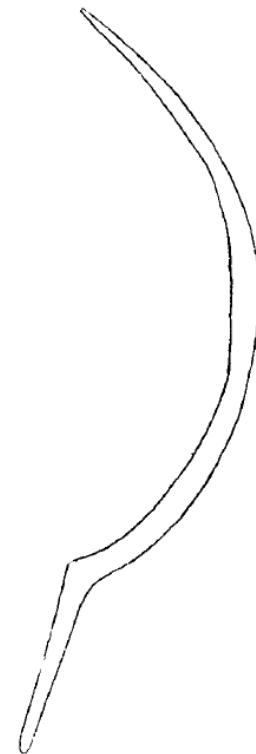
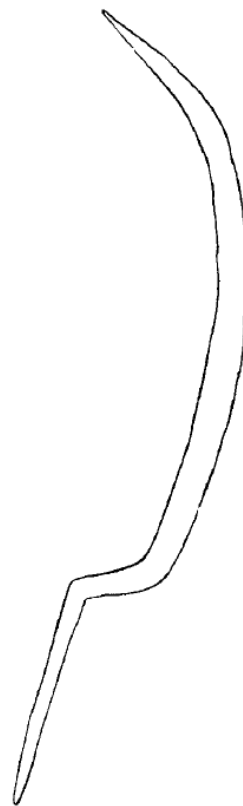
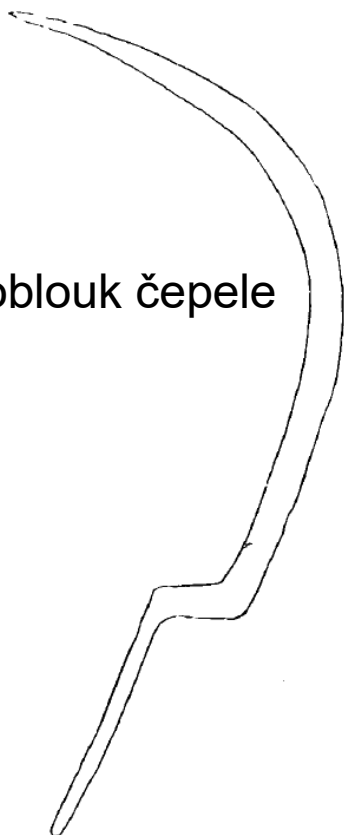

Úzké čepel



# SRP



**Mstěnice**

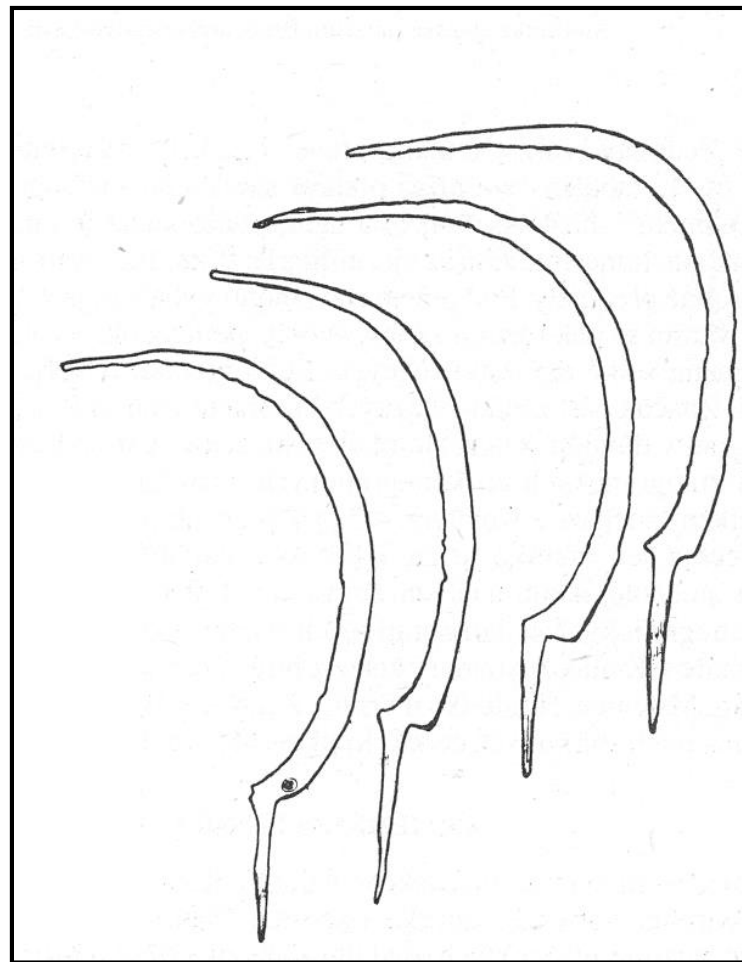

**Konůvky**

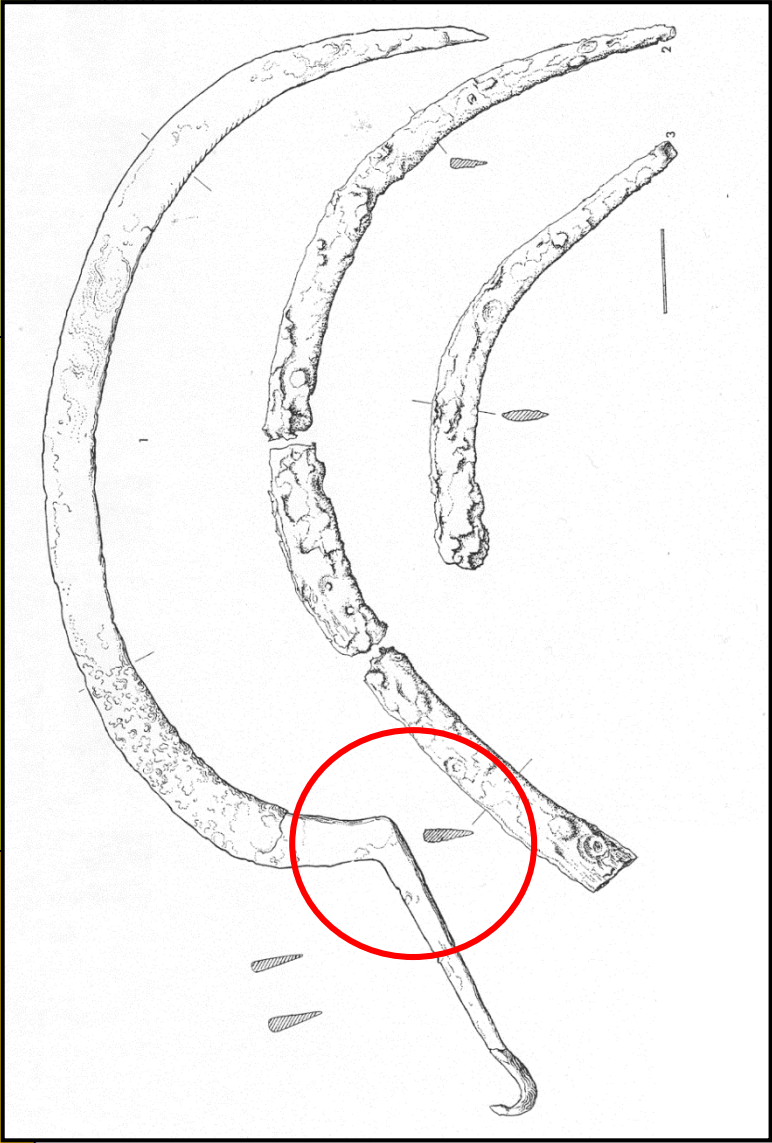

**Hradištko u Davle**

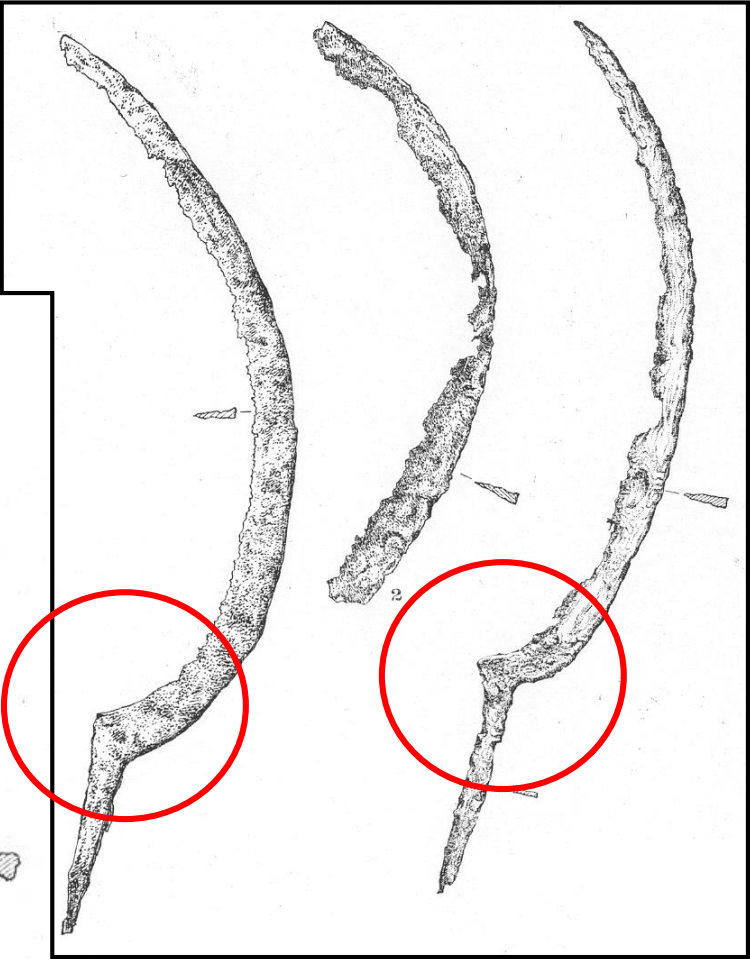
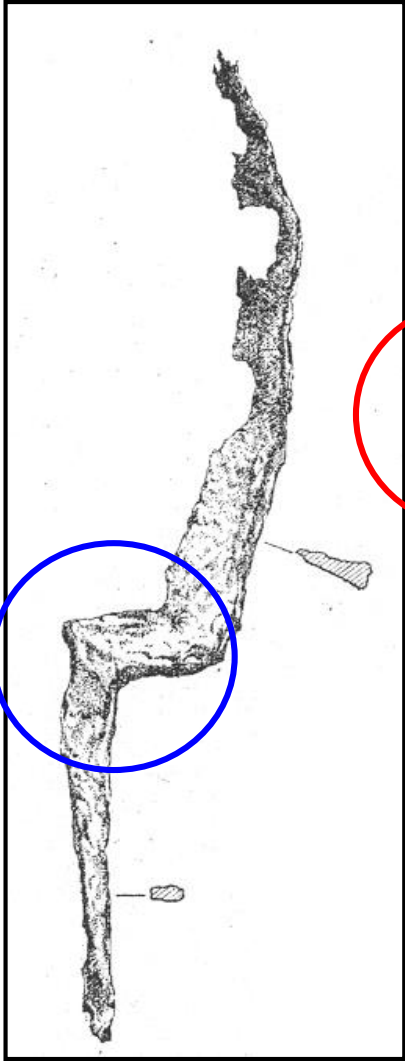

**Pfaffenschlag**



## Svídna

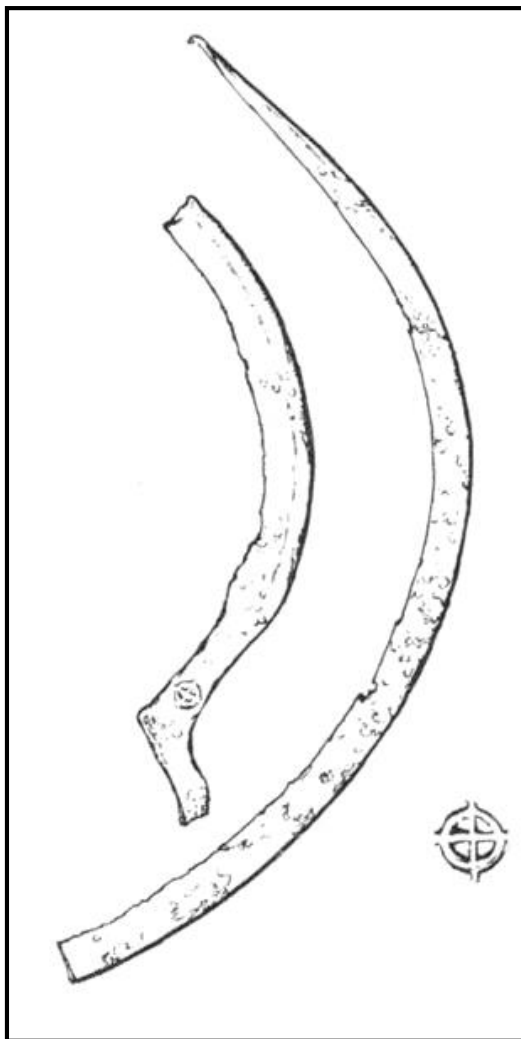

## Pfaffenschlag

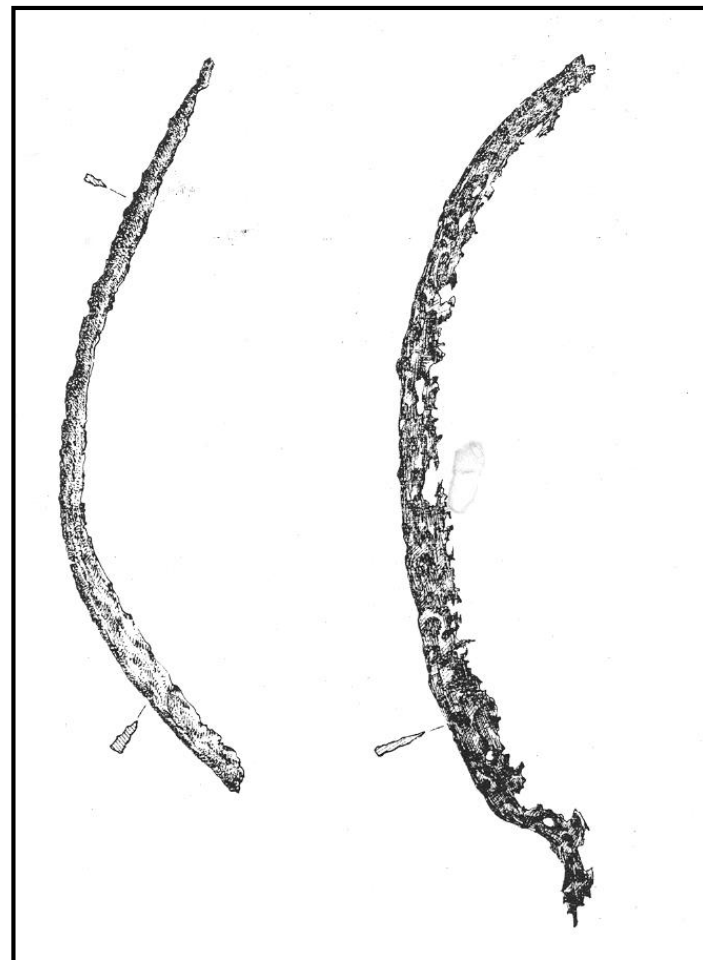

## Rychleby

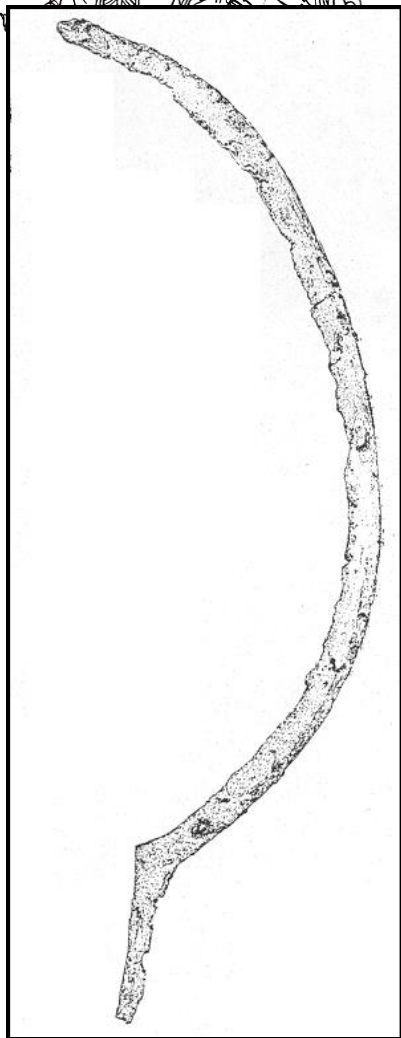

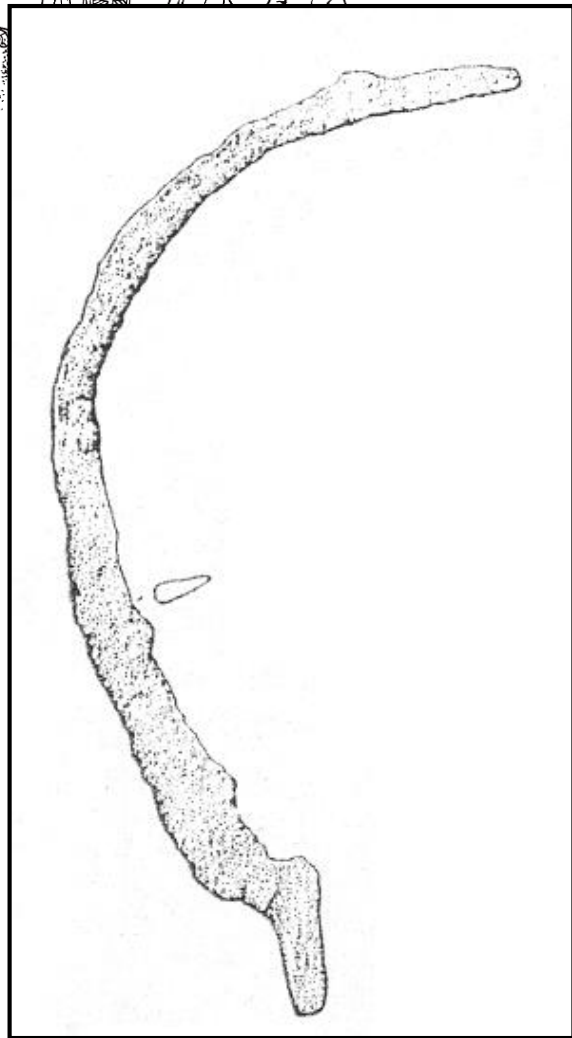

**Branč**

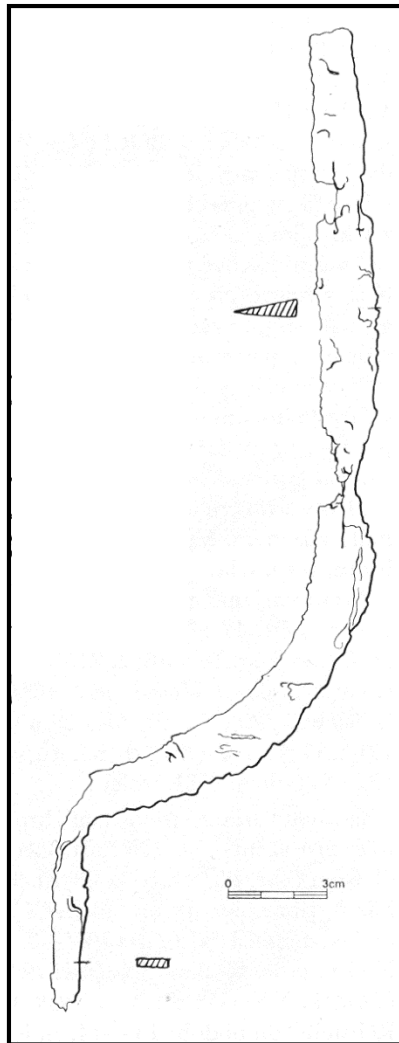

**Bradlo**

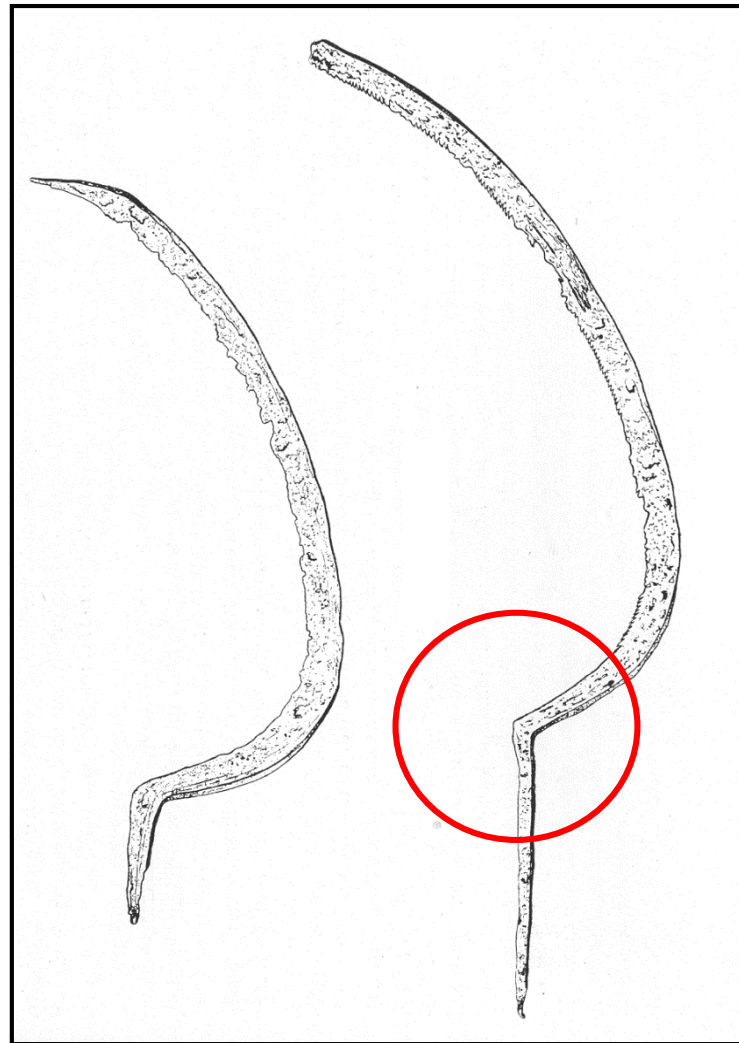

**Bolkov**



# Semonice

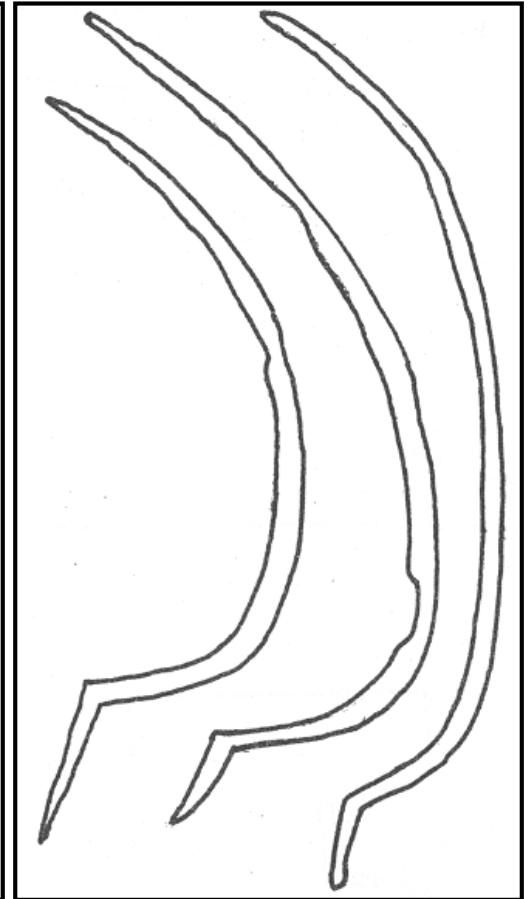
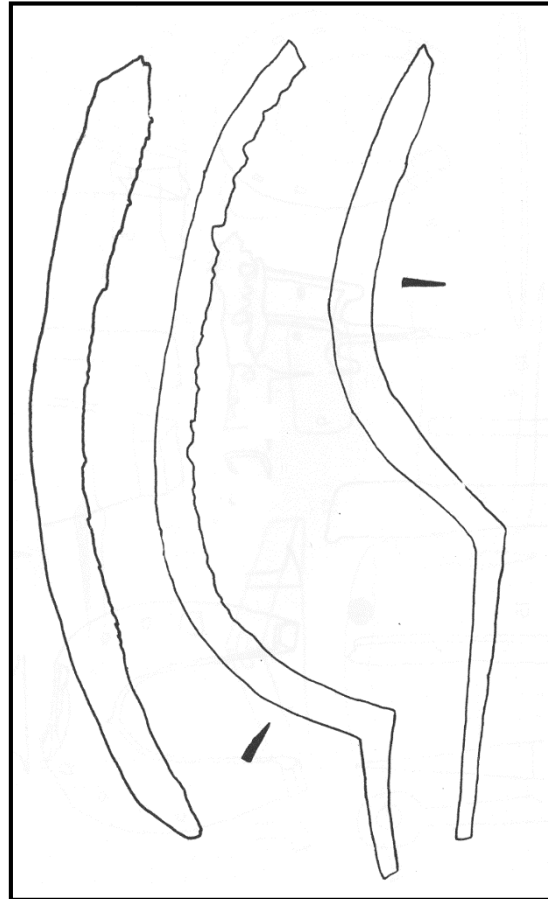
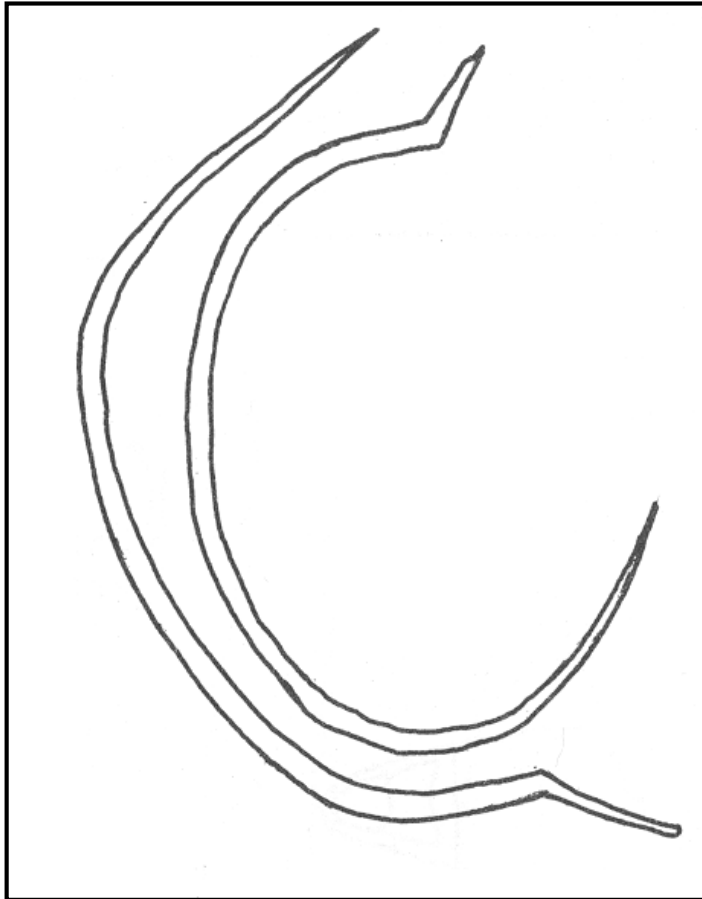



## Martinice u Votic

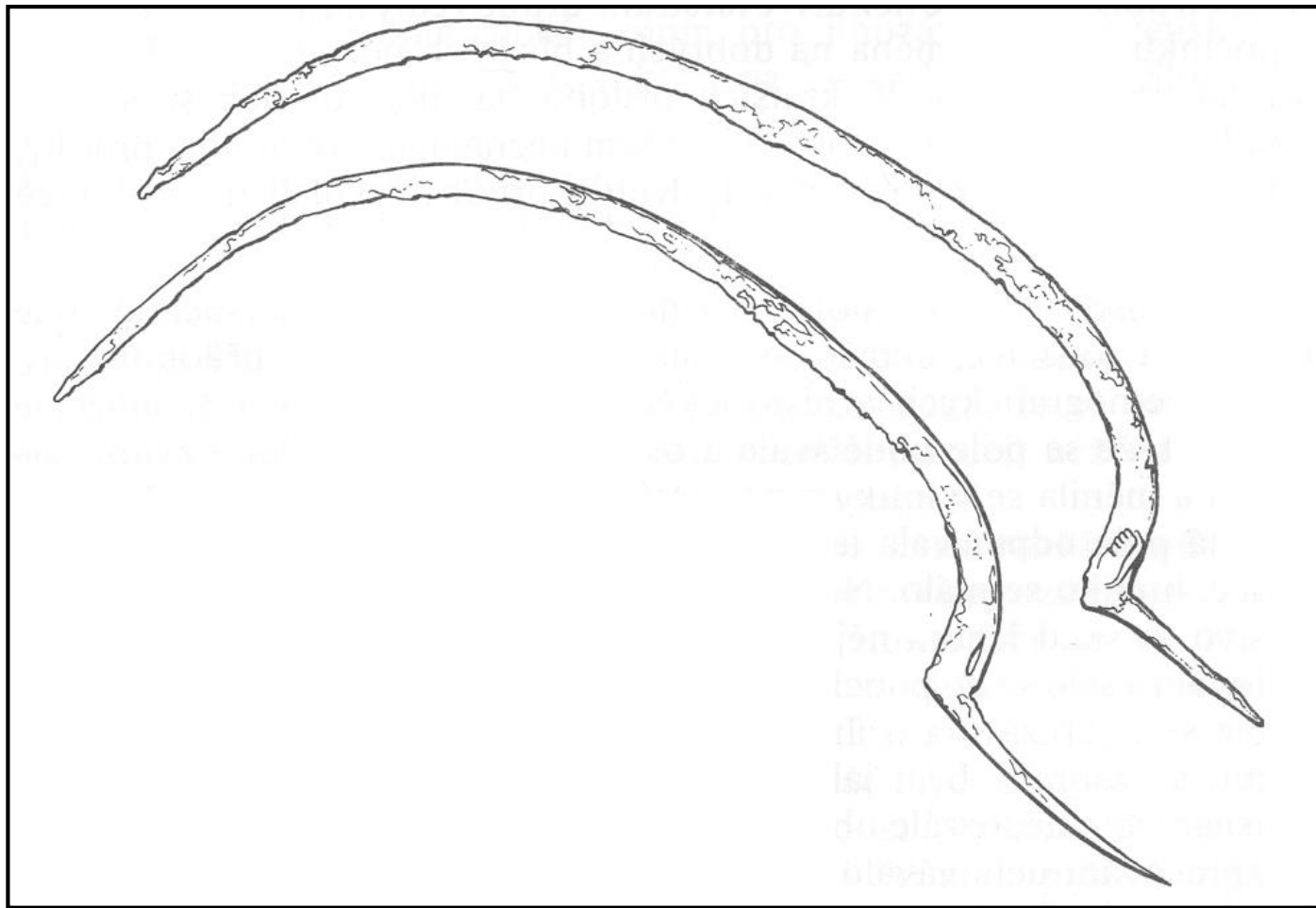

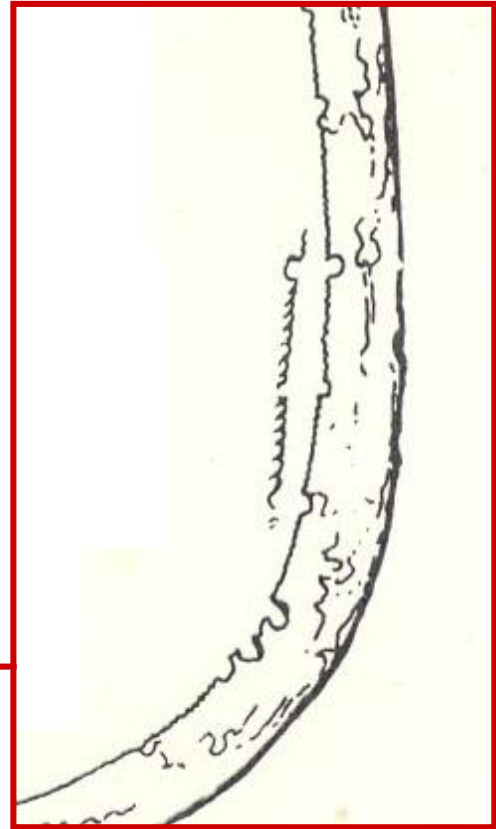
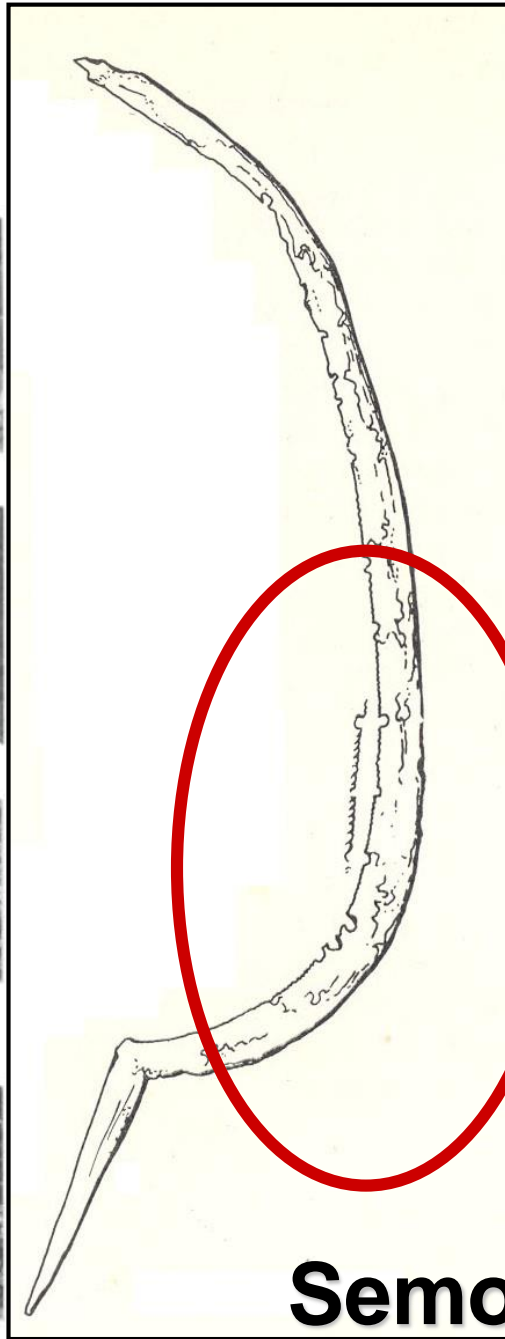

**Semonice**





Semonice: 1, 2, 5-7,9

Bolkov: 3, 4, 8

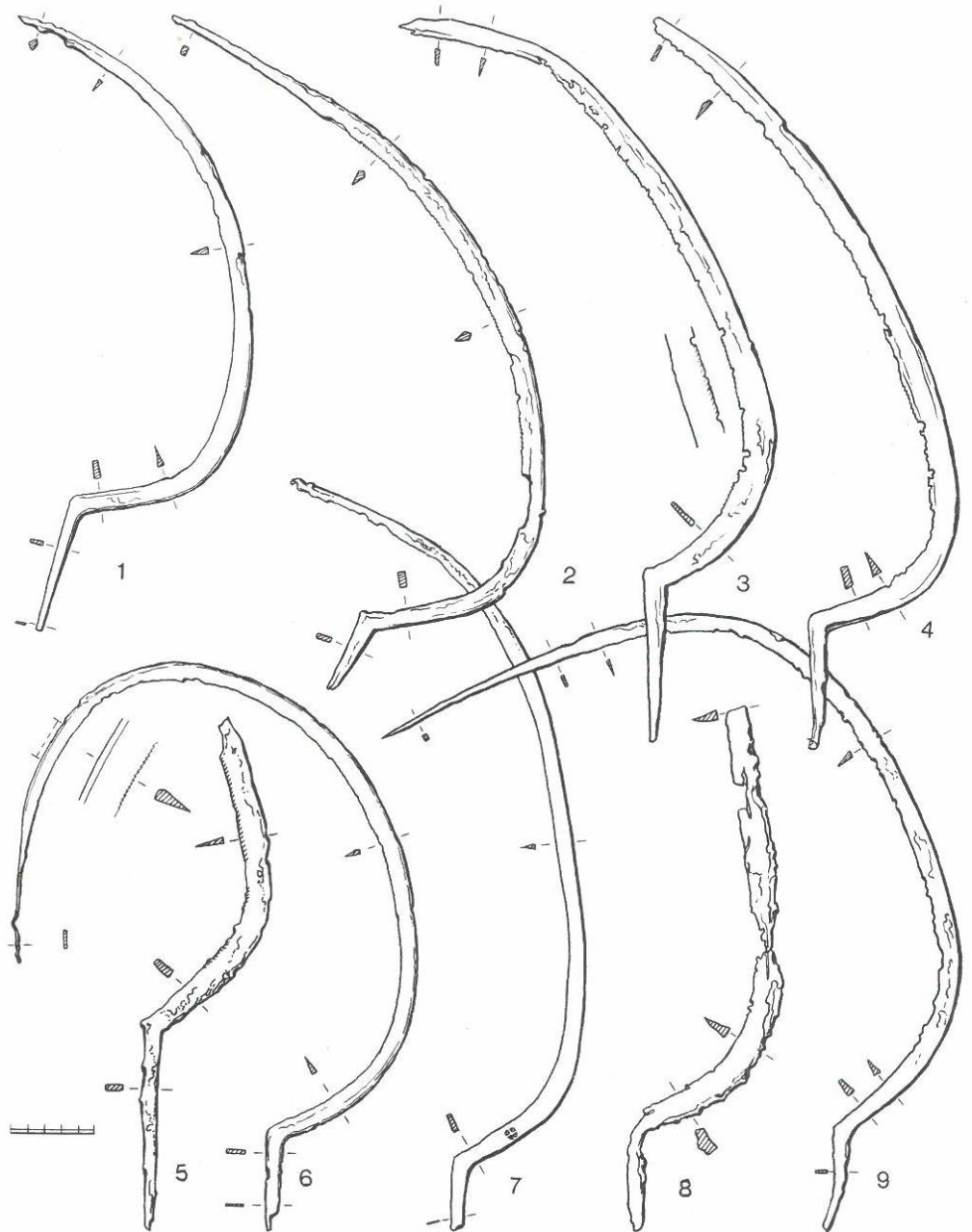



# KOSA

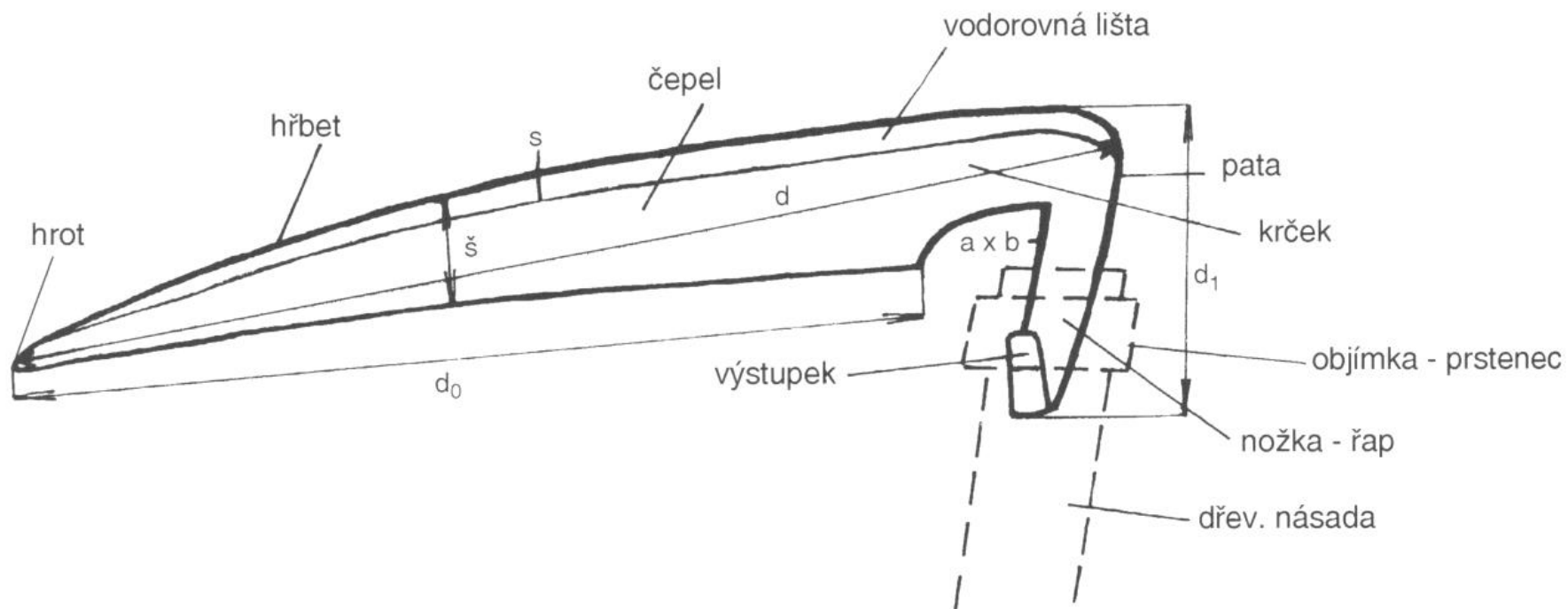



# KOSA

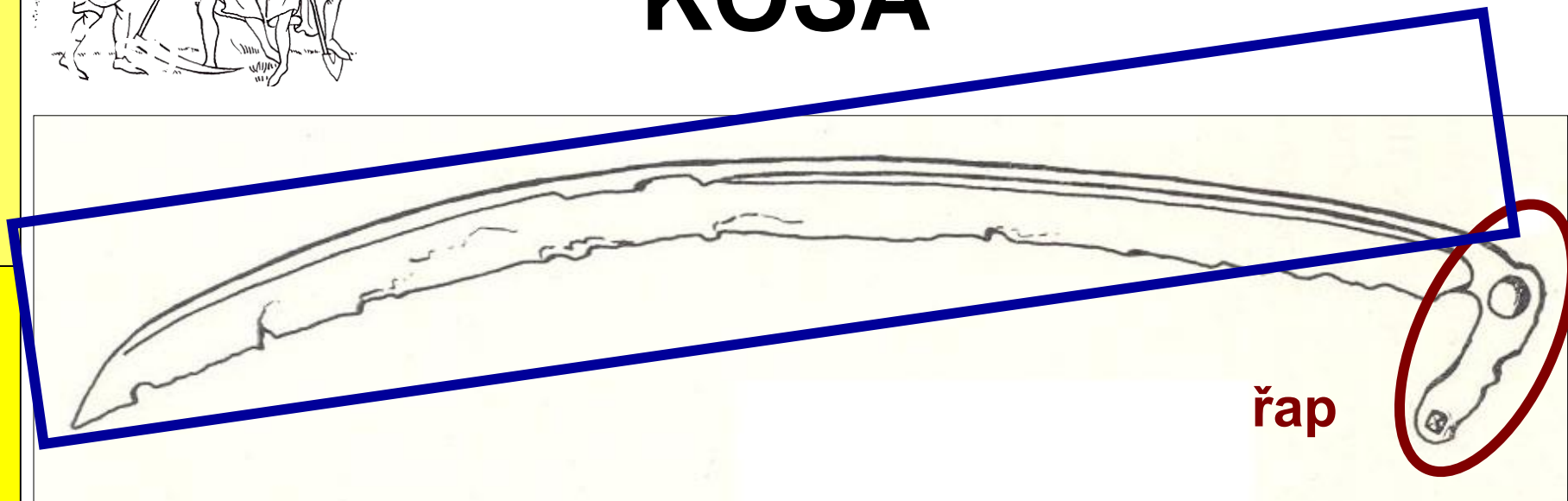

**hřbet**

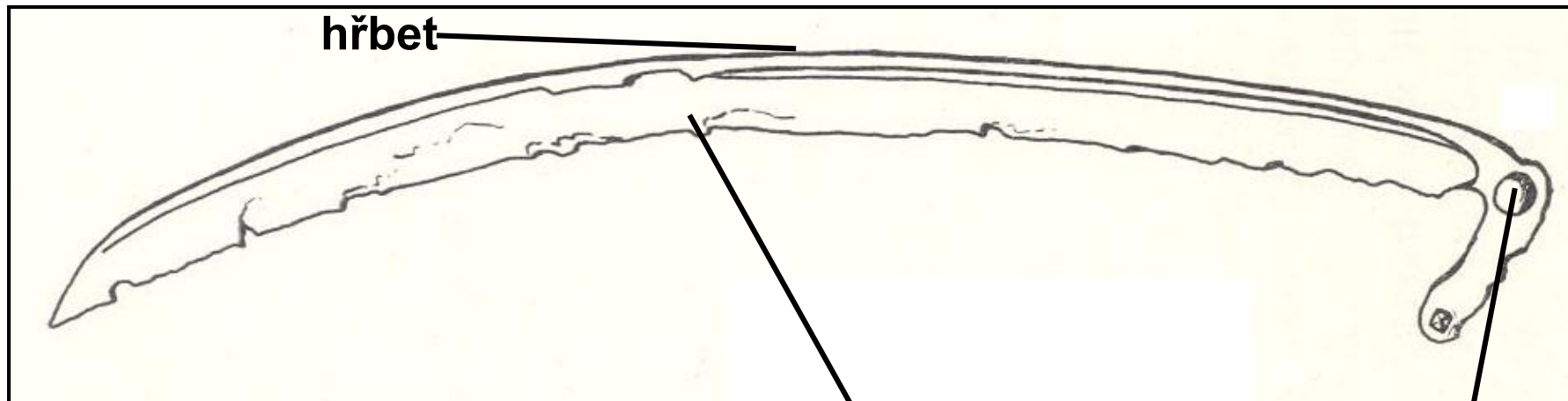

**ostří**

**trn**

- **krátká**
- **dlouhá**



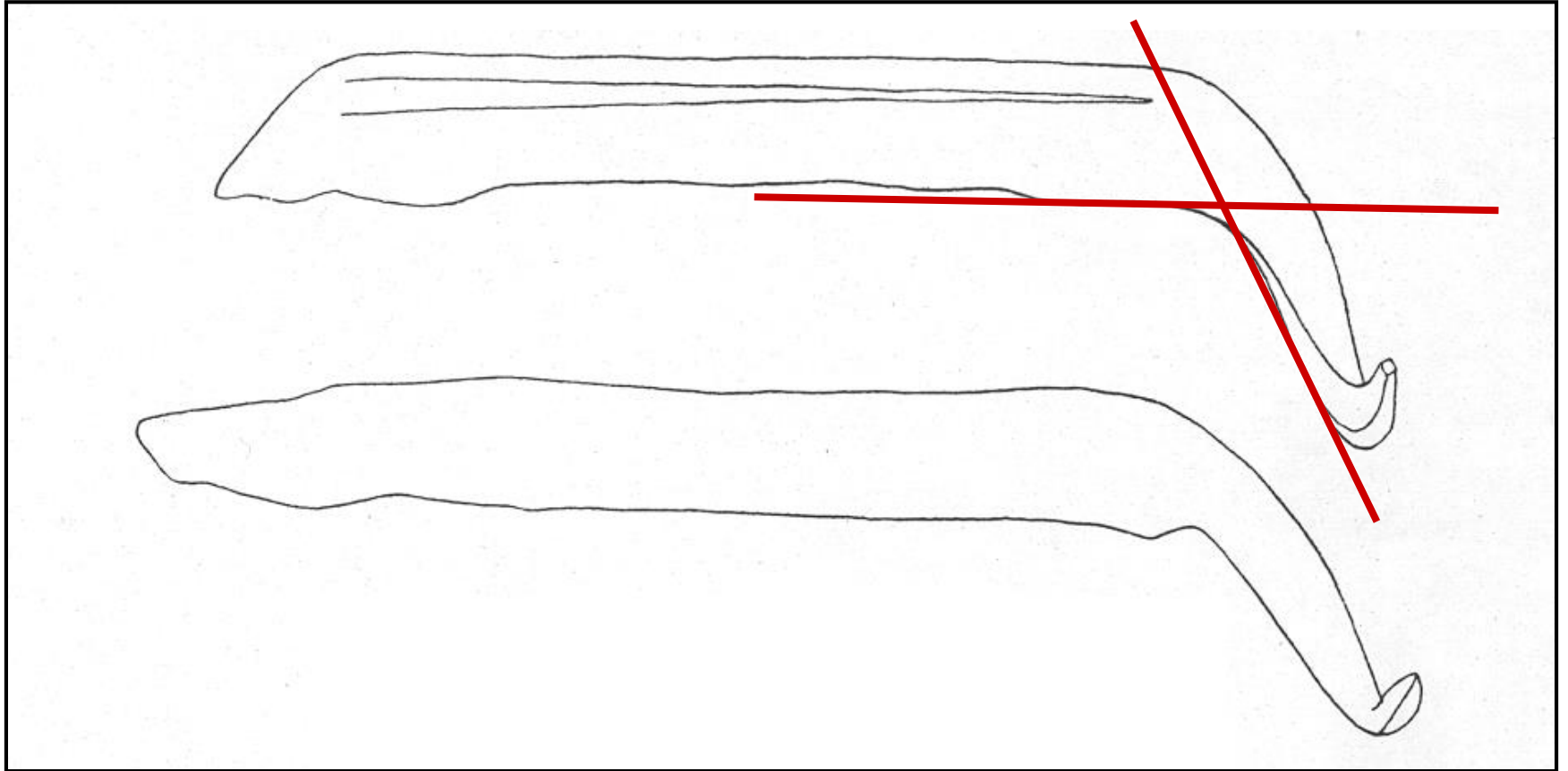

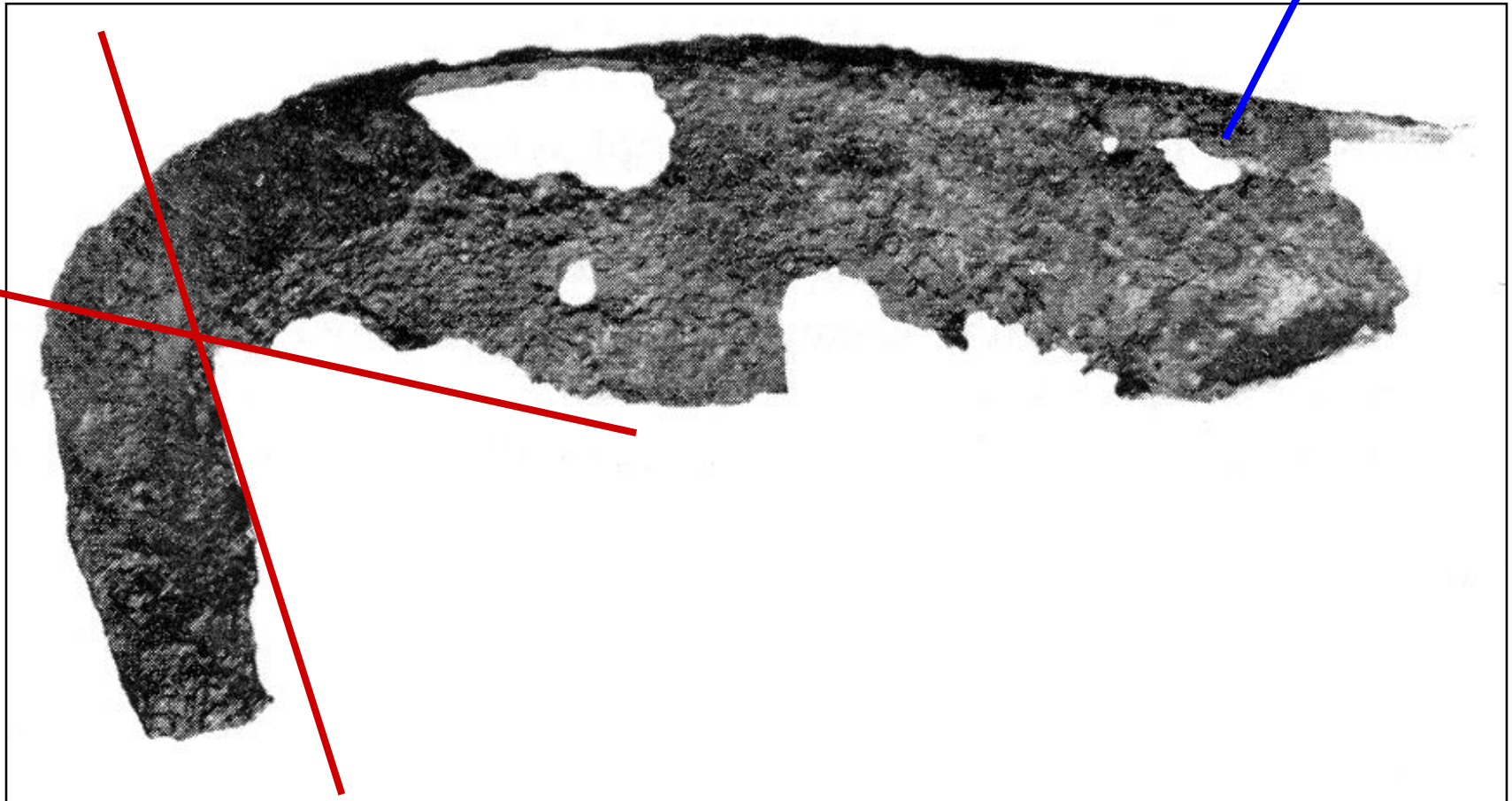
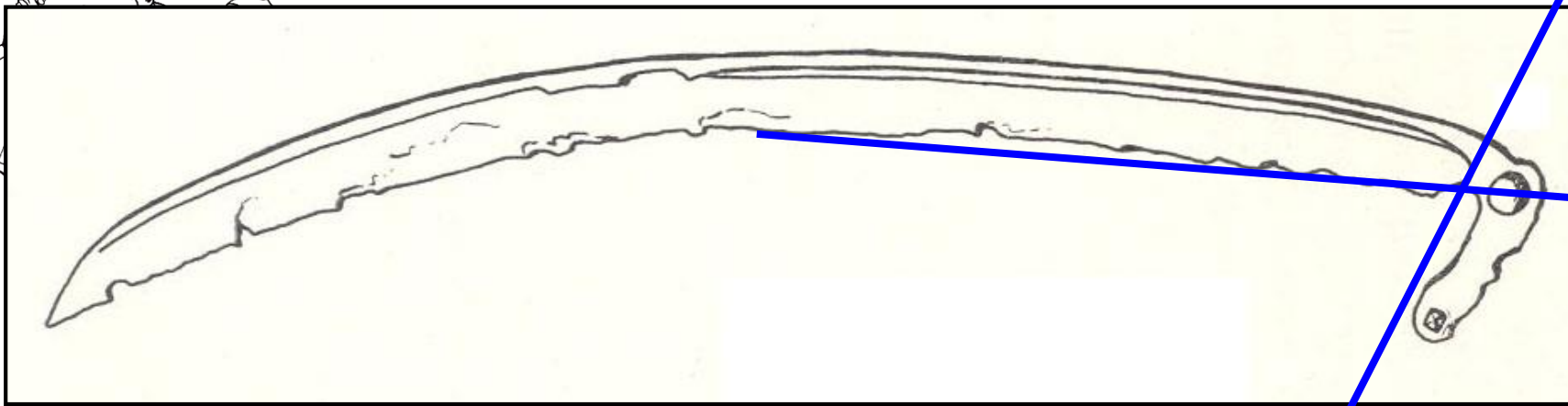

- **krátká kosa**

**čepel**

**objímka**

**řap**

**dřevěné kosiště**

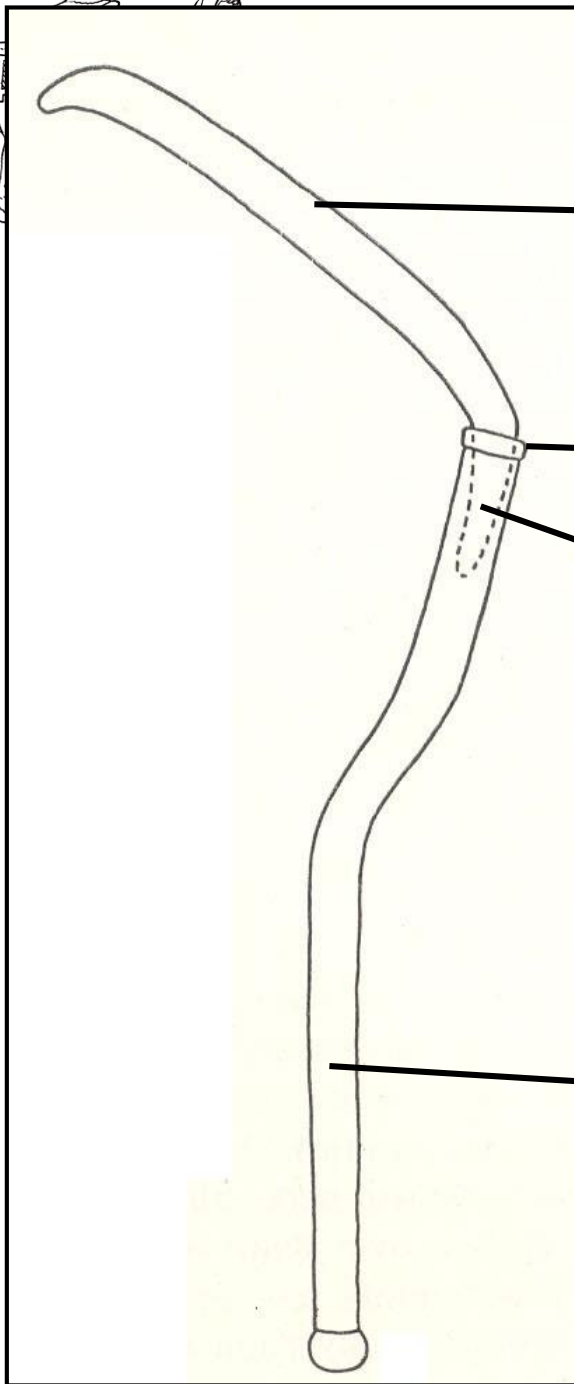

# upevnění kosa

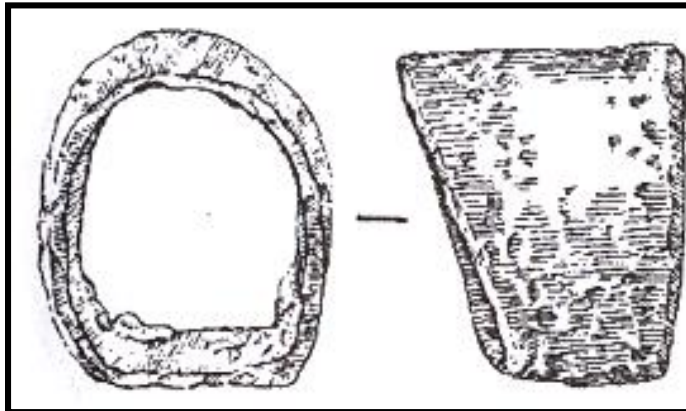
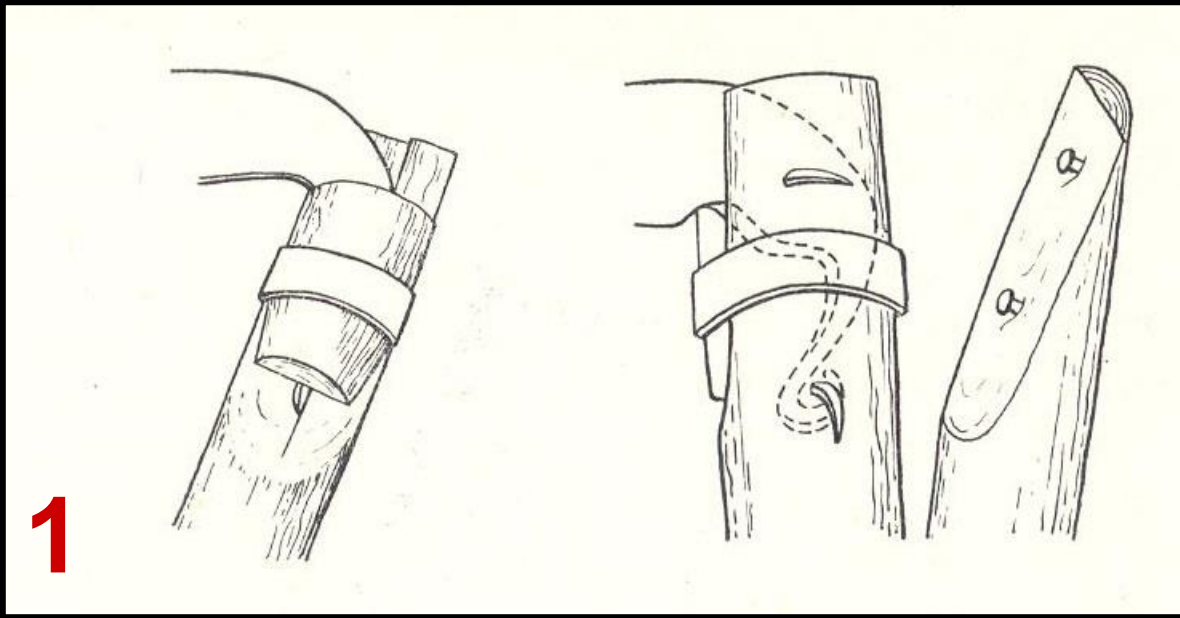

objímka





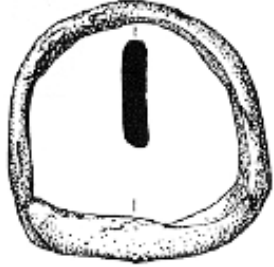
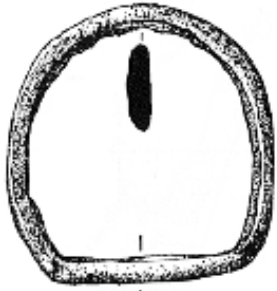



# třídění kos podle Beranové (1957)

I.

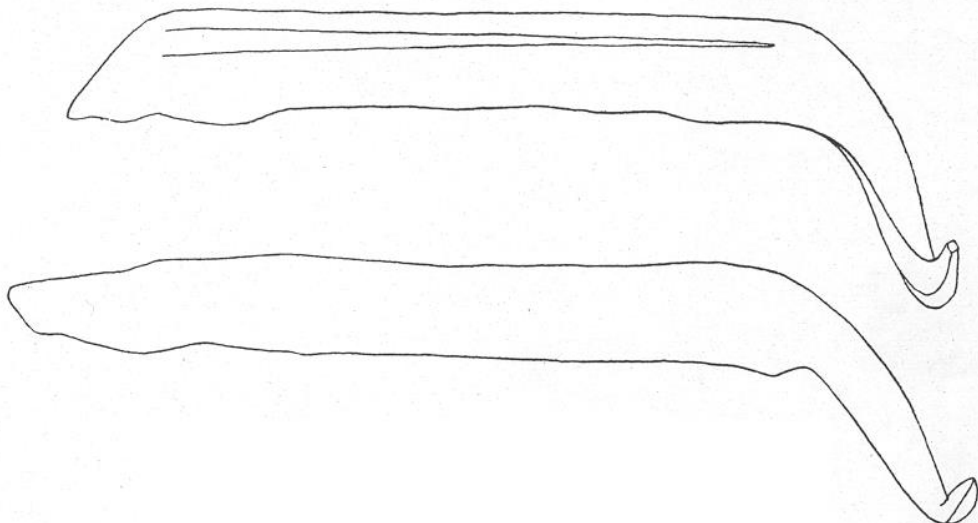

II.

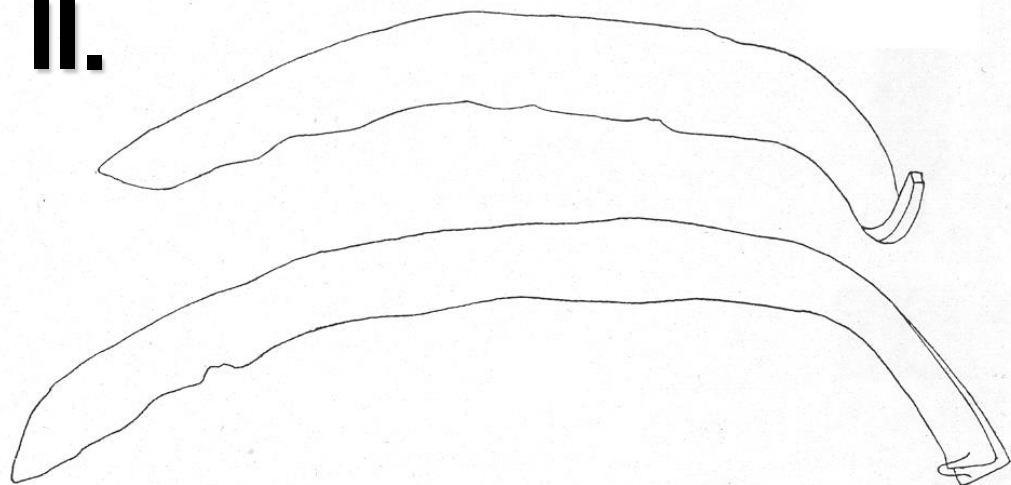

9. století



- **KRÁTKÁ KOSA**

- kosení – na obě strany
- kosiště prohnuté
- od LT
- **řap – čepel** – tupý úhel

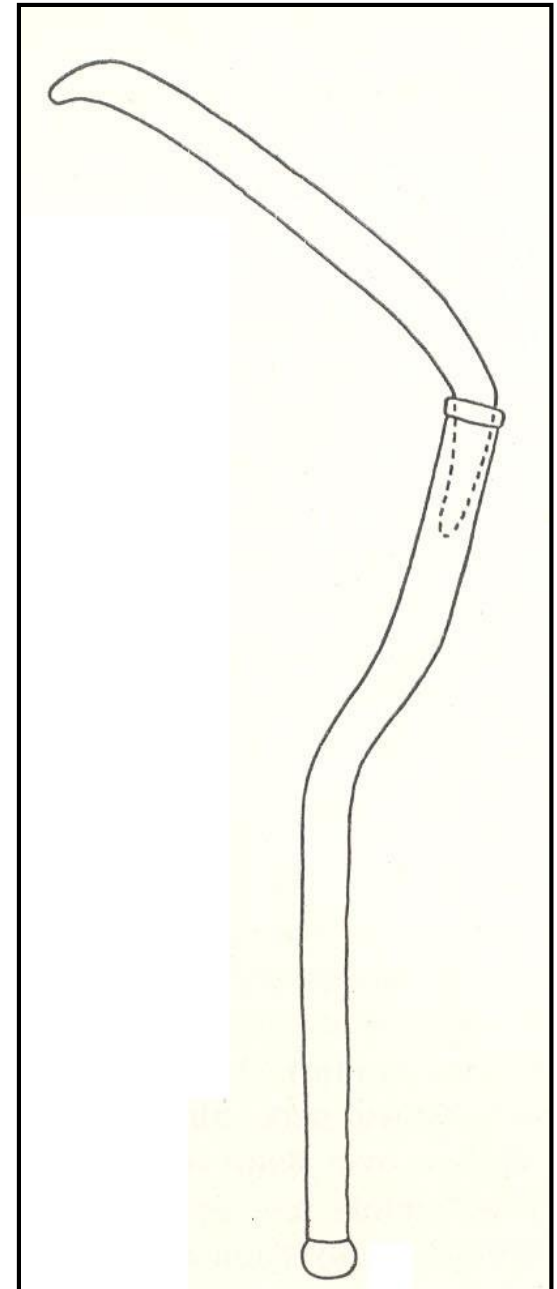

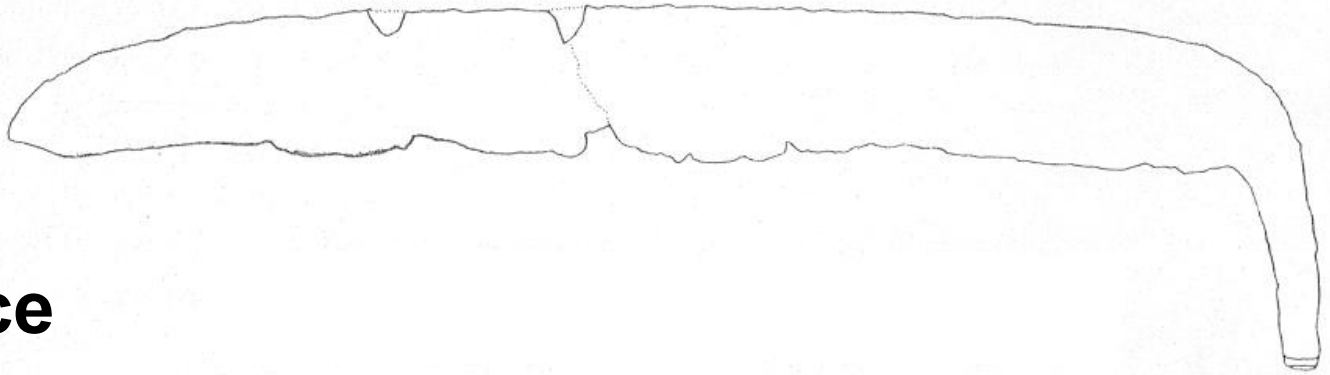

- **Církvice**

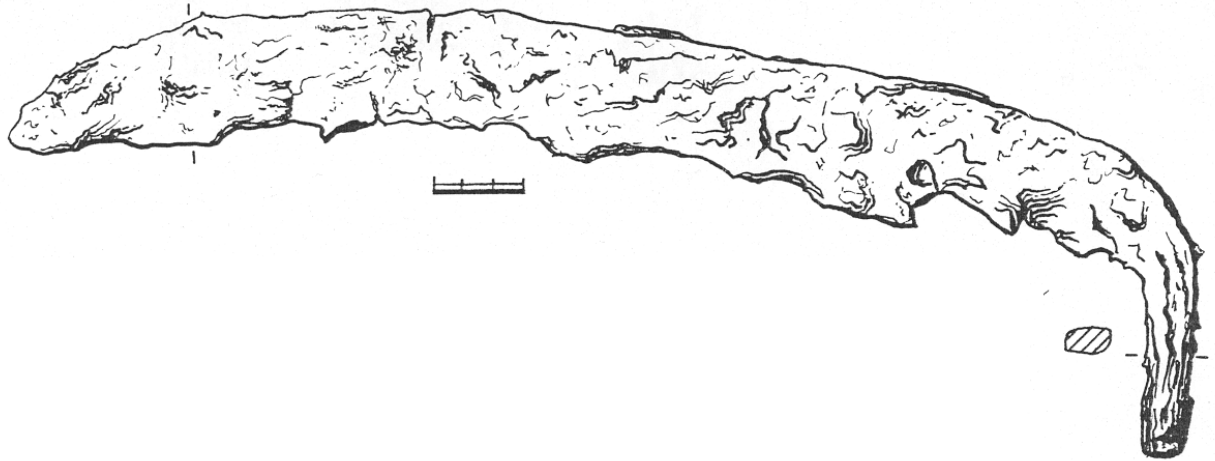

- **Malín**



# • DLOUHÁ KOSA

– širší list, hřbet vytažen do dlouhé lišty

– Bolkov

– Bradlo

- polovina 14. století
- 2 ks (1s řapem, )

– Konůvky

- 15. století
- d = 940 mm

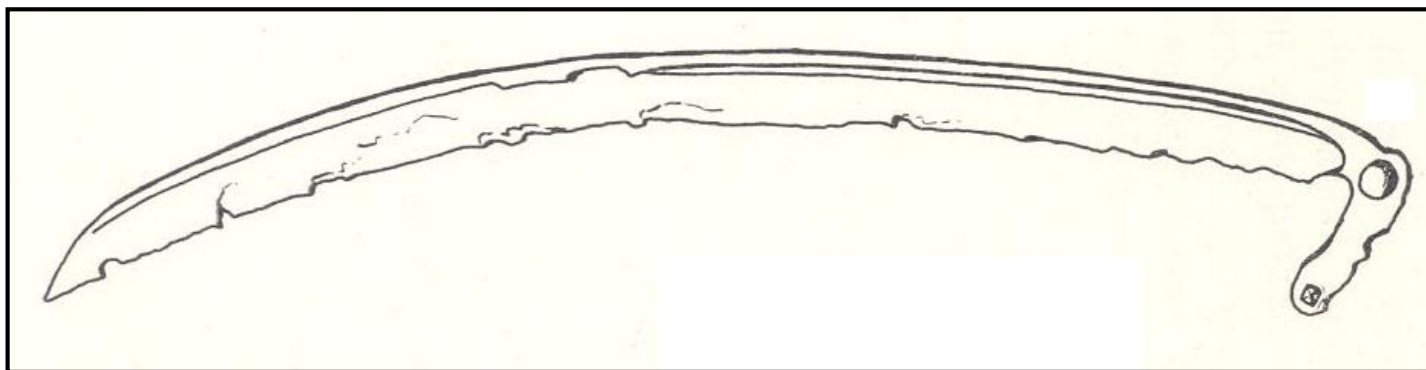
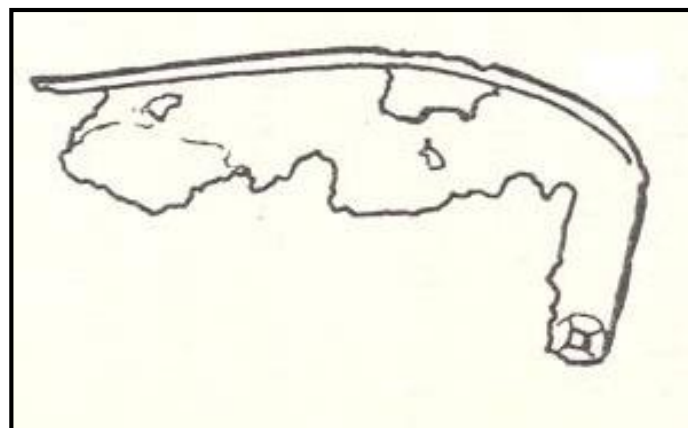
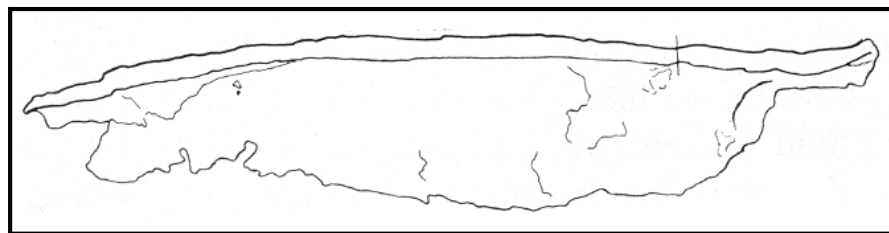



**Bystřec**

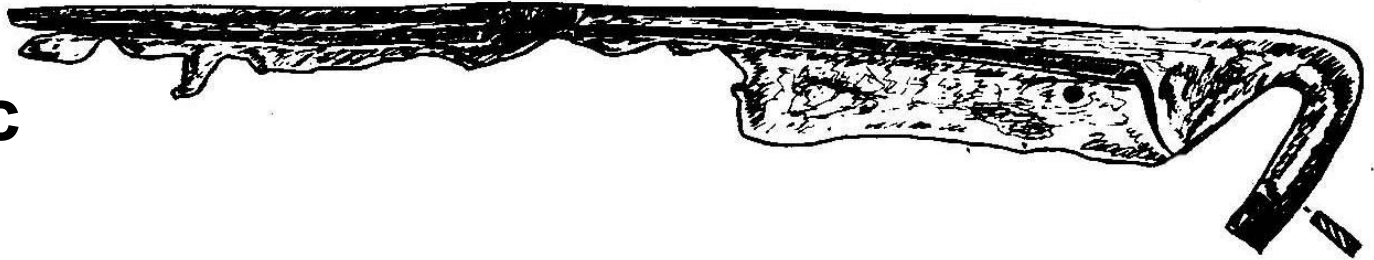

**Pfaffenschlag**

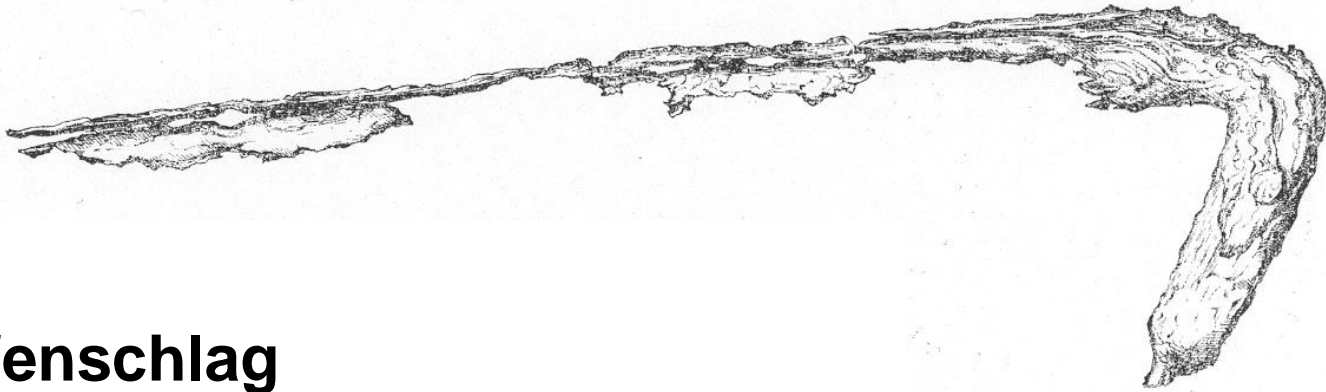



# **kosť řezací stolice**

(Martinice u Votic, poč. 16. století)

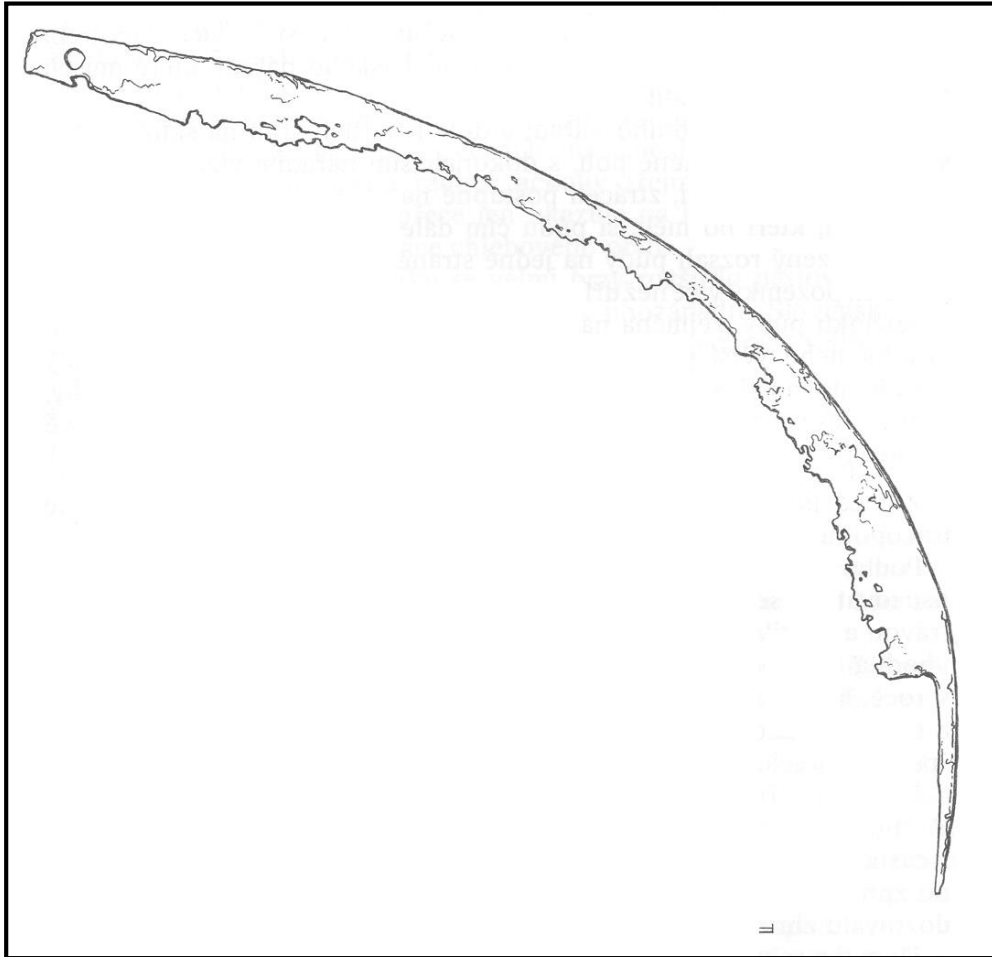



**CEP**



breviř kláštera sv. Jiří  
kolem 1400





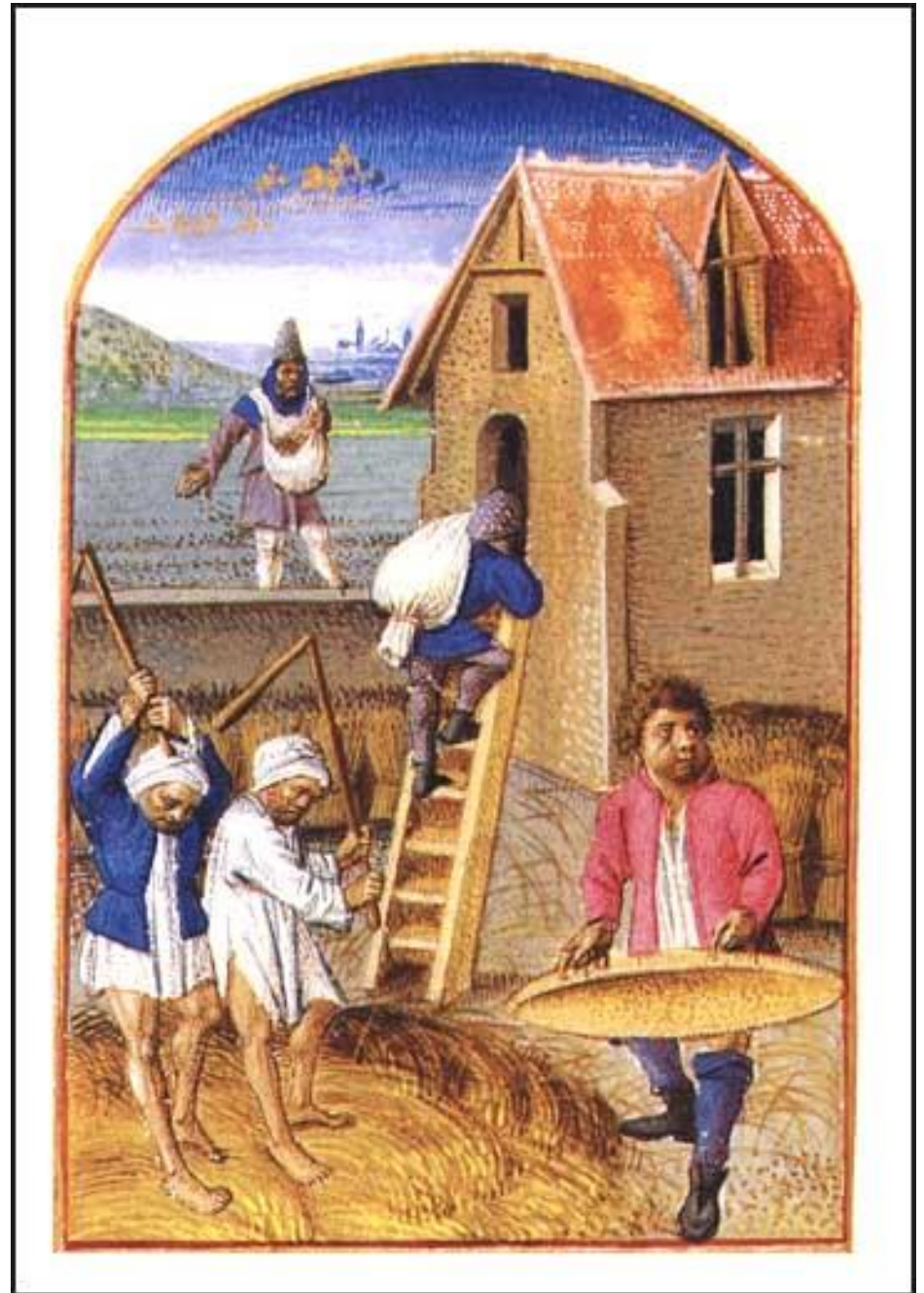

**Chaff (c. 1460)**



## Tvar bijáku cepu

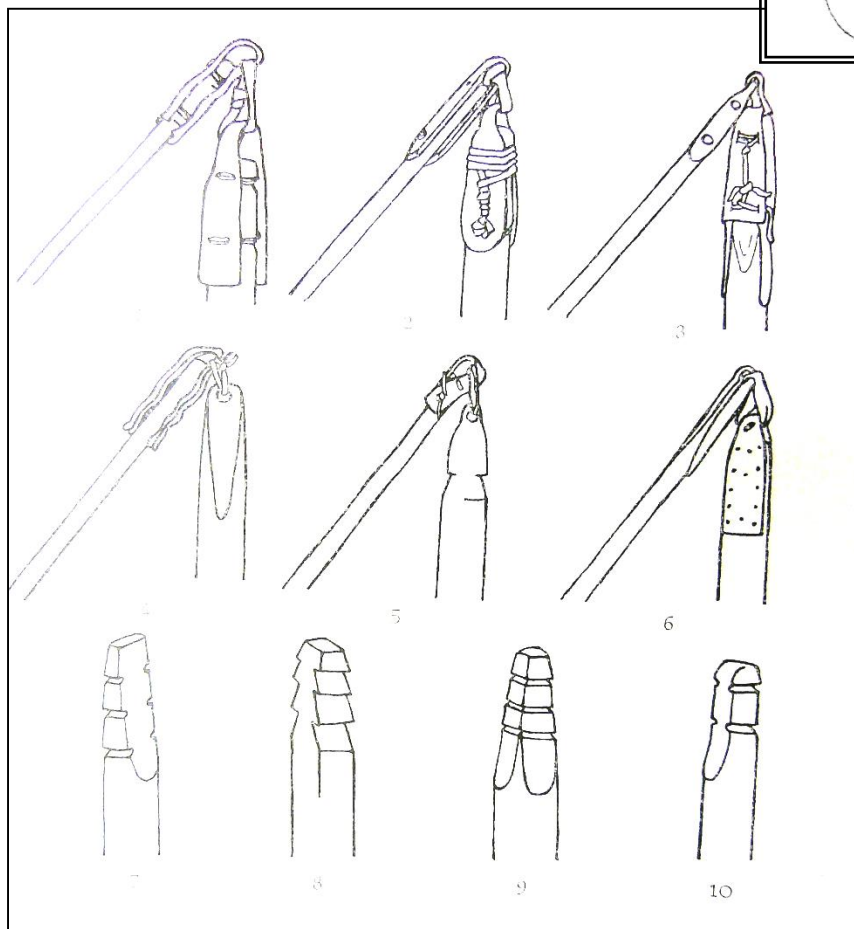
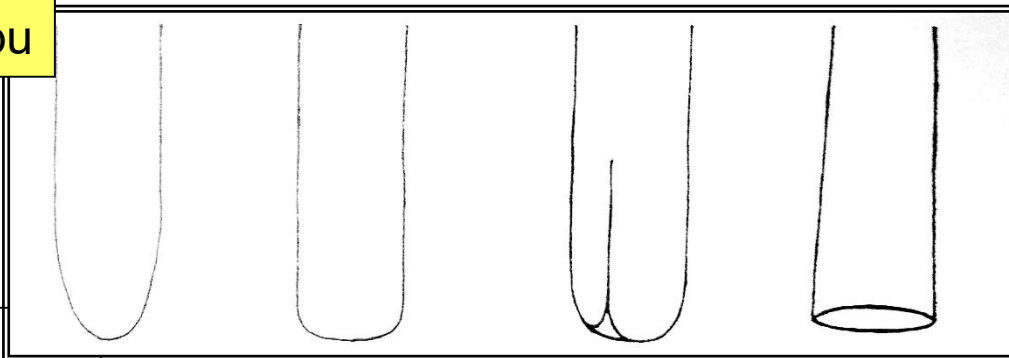

Kulovitě se zužující

válcovitý

Čtverhranný

Konicky se rozšiřující



# KOVÁNÍ ČEPU

Pfaffenschlag

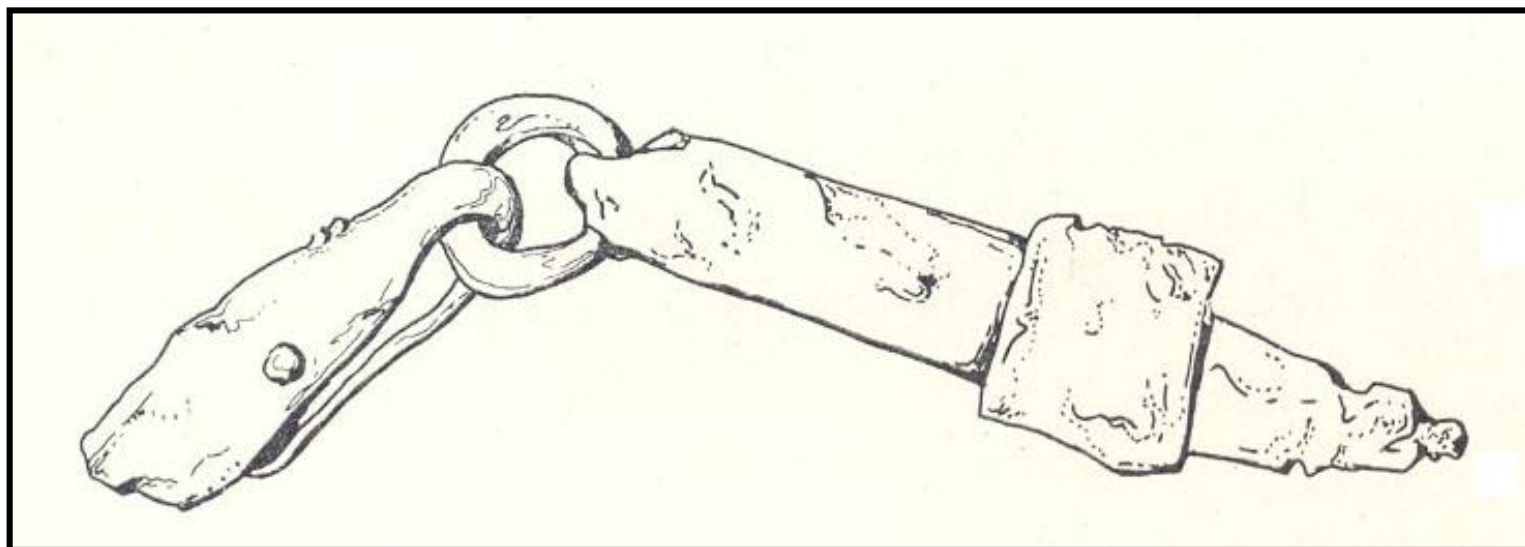
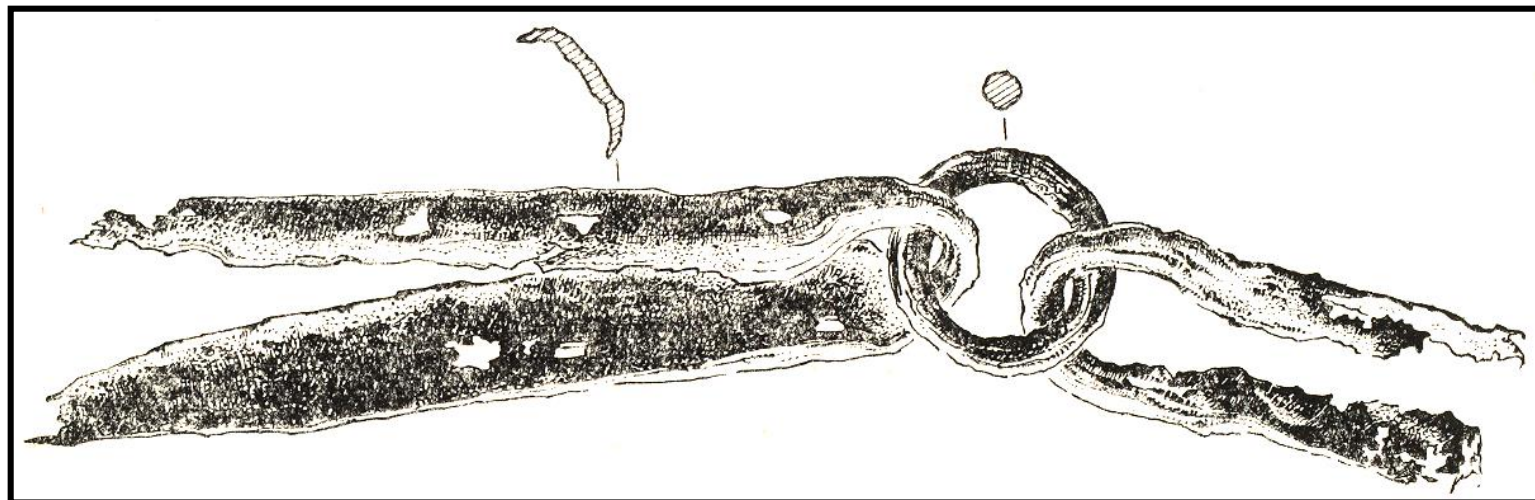

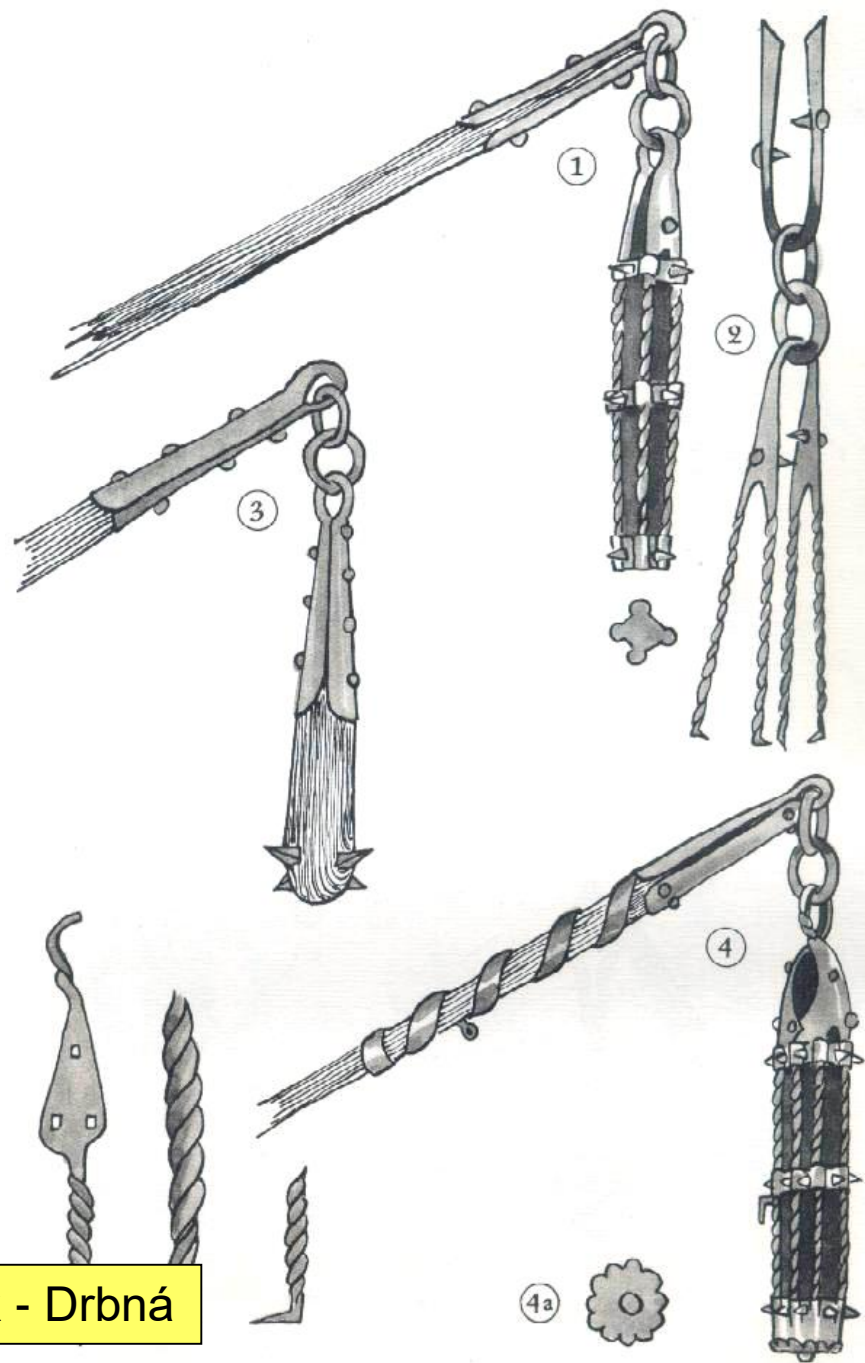

Tzv. bojové cepy – podle Wagner – Durdik - Drbná

# RÝČ - LOPATA

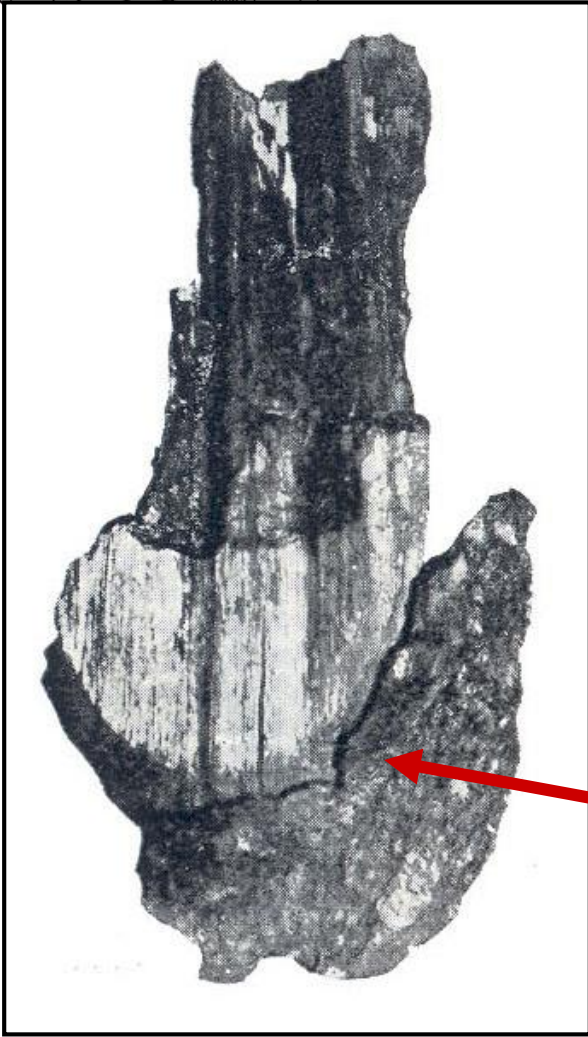
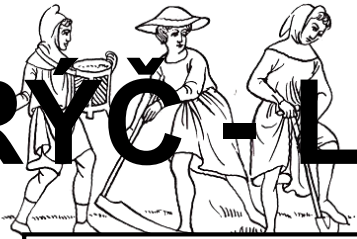

Náchod – Staré Město



Velislavova bible

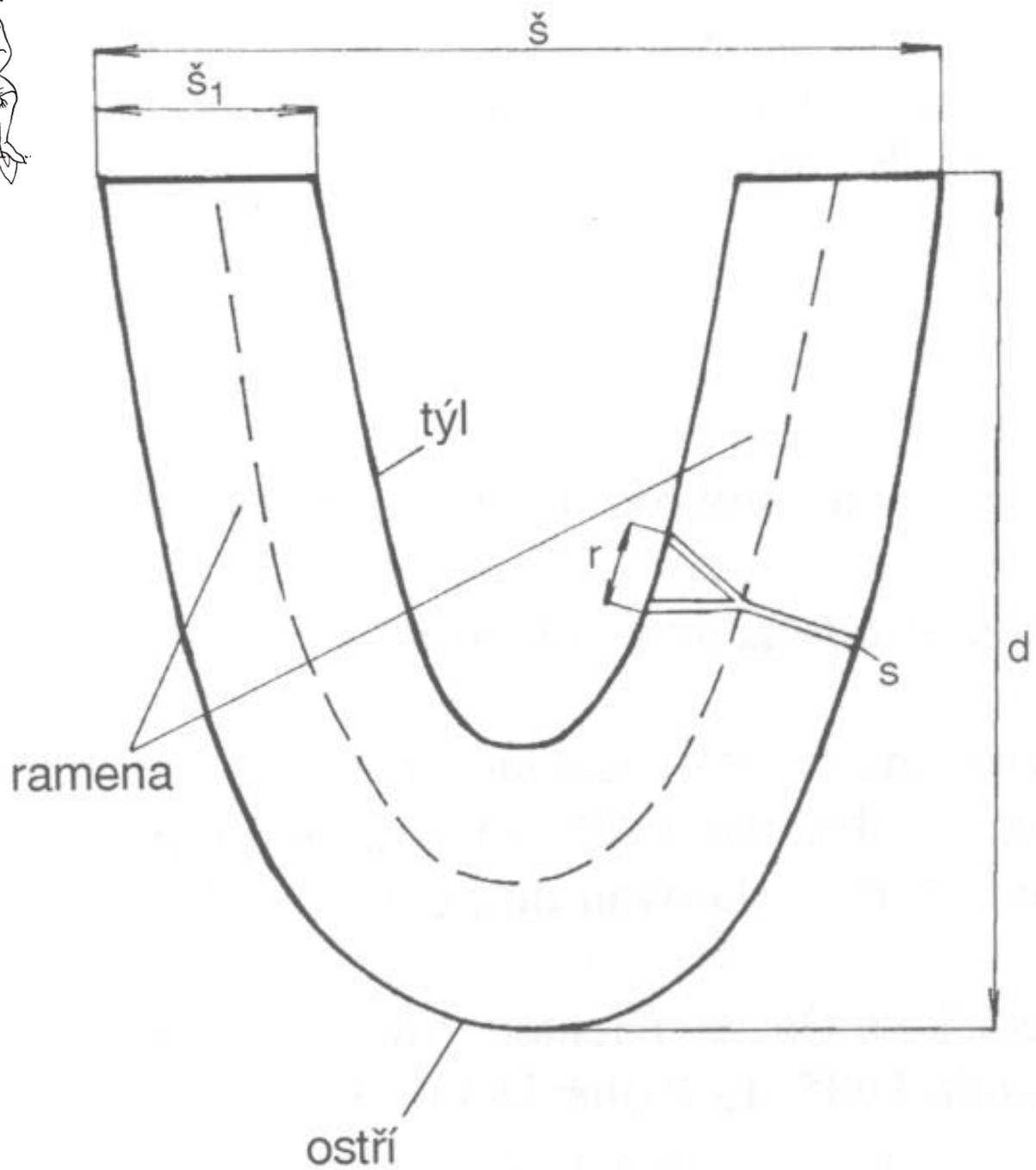



# Velislavova bible



**Petr de Crescentis**

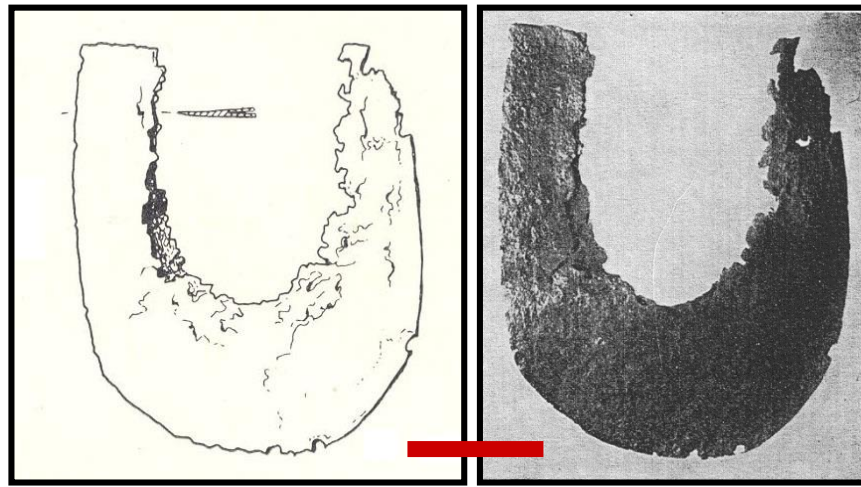

**Semonice**

**Zalužany**

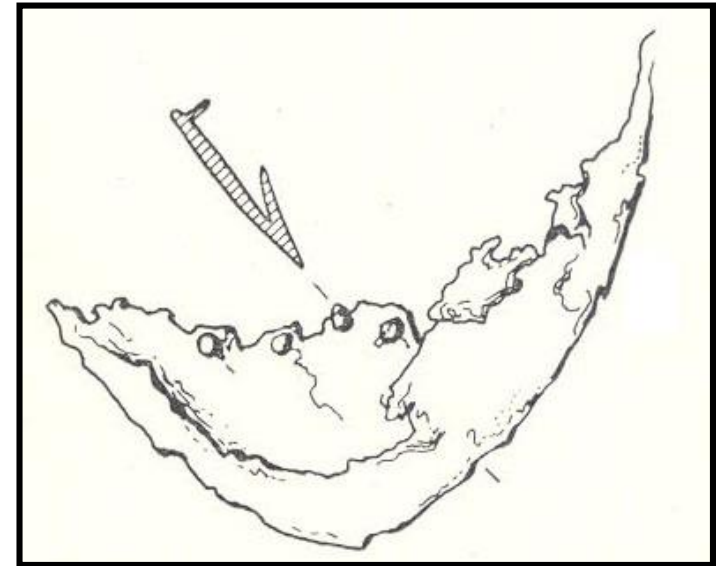
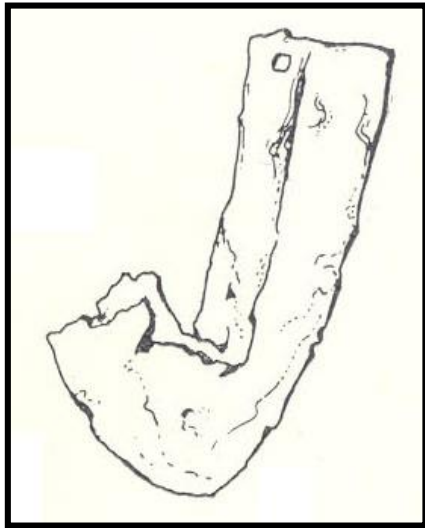

**Spy**





# Typologie rýčů podle Musila (2002, SP)

Typ	Varianta			
	a	b	c	d
A I				
A II				
A III				
A IV				
B I				
B II				
C				

Typ	Varianta			
	a	b	c	d
D I				
D II				
E I				
E II				
F				

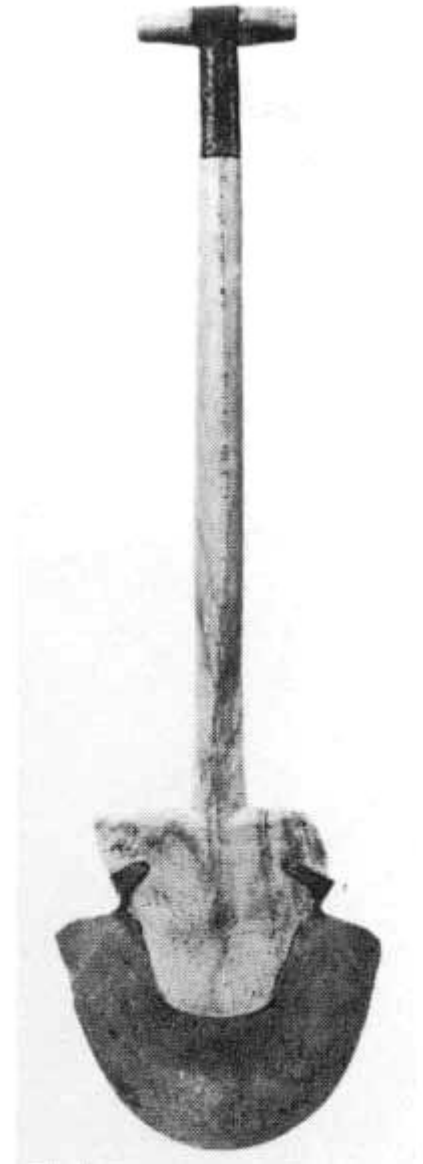
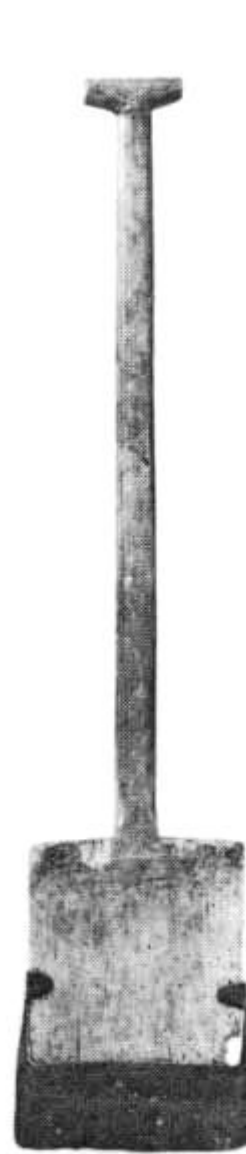

# VIDLE



- celokovové vidle

- trojzubé

- dvojzubé

- dřevěné vidle s kovanými hroty

tulej

hrot

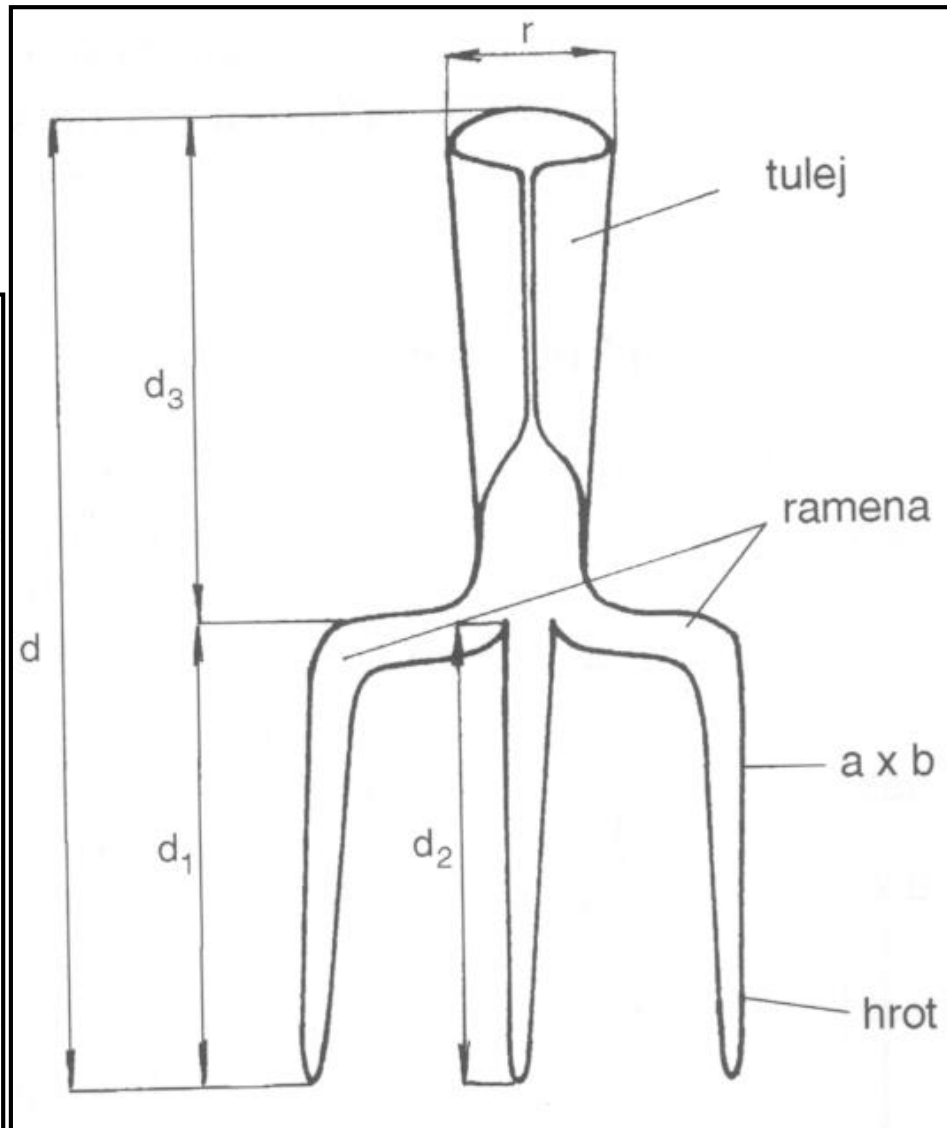
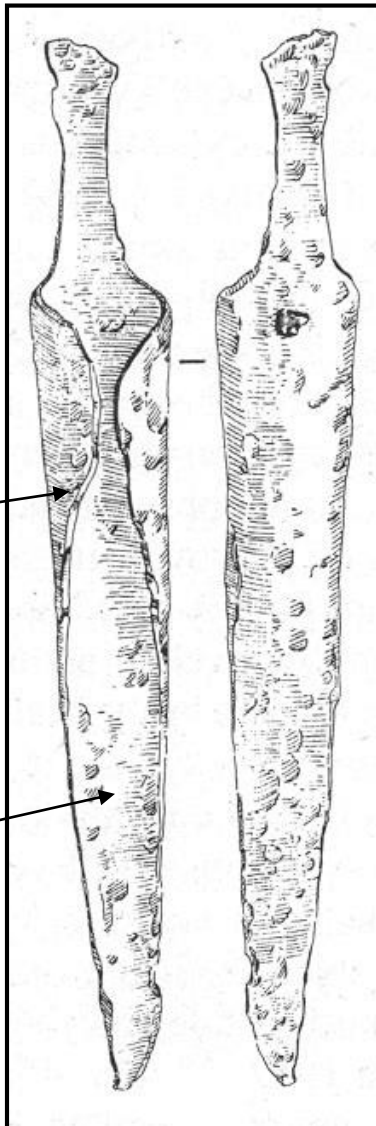

# VIDLE

- HNOJNÉ
- SENNÉ



## Semonice

počátek 14. století

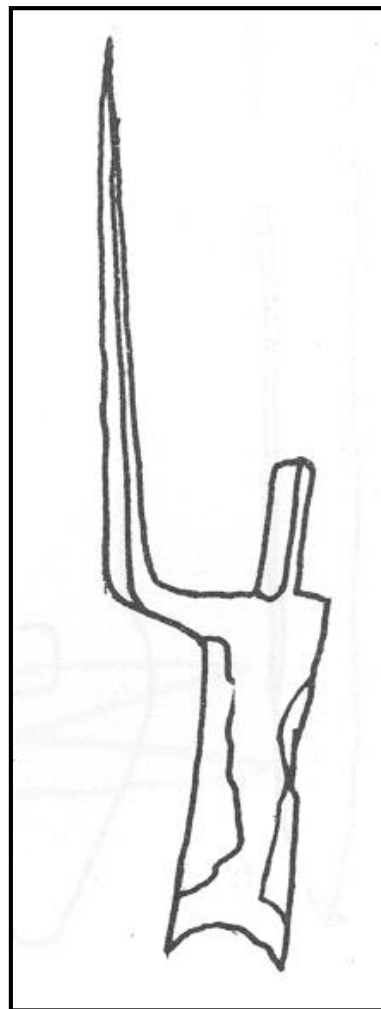



**SENNÉ VIDLE**

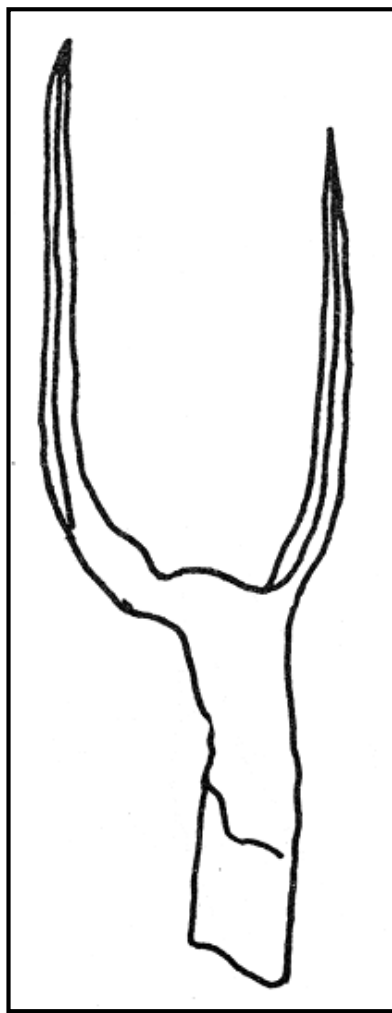

**Velislavova bible**



**Bystřec**

15. století

**Semonice**

počátek 14. století



# VIDLE – 15. století

Koválov

Pfaffenschlag

Bystřec

Kování hrotů vidlí

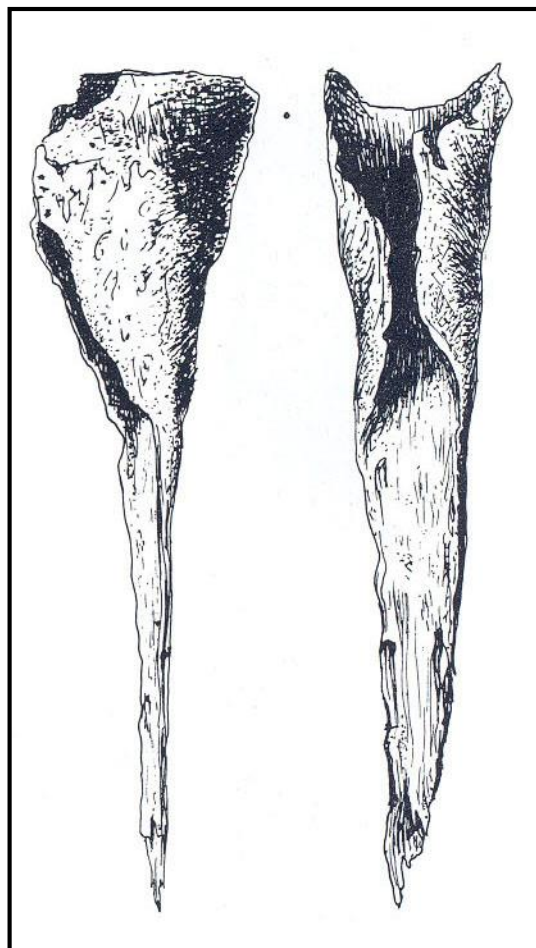

Mstěnice

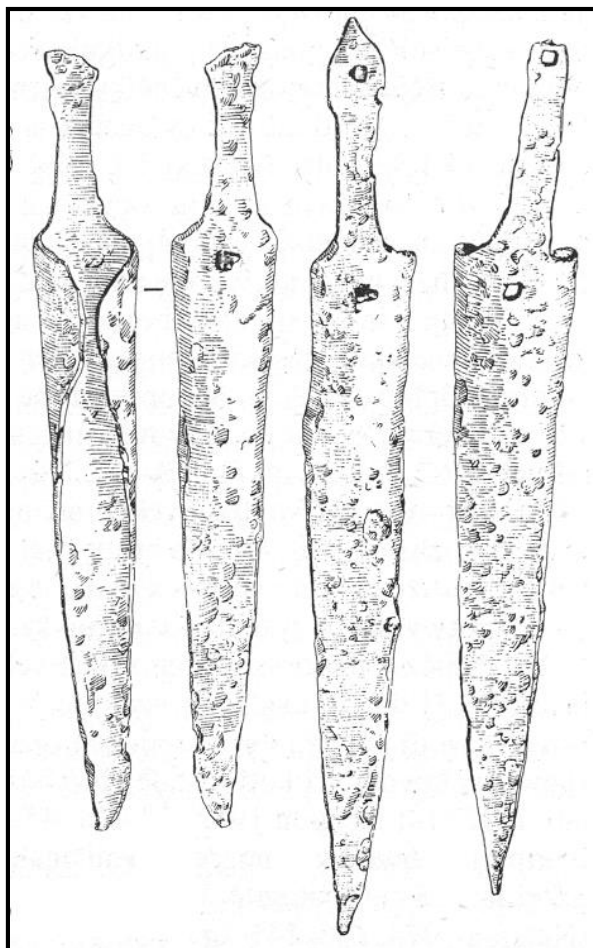

Konůvky

# OVČÁCKÉ NŮŽKY

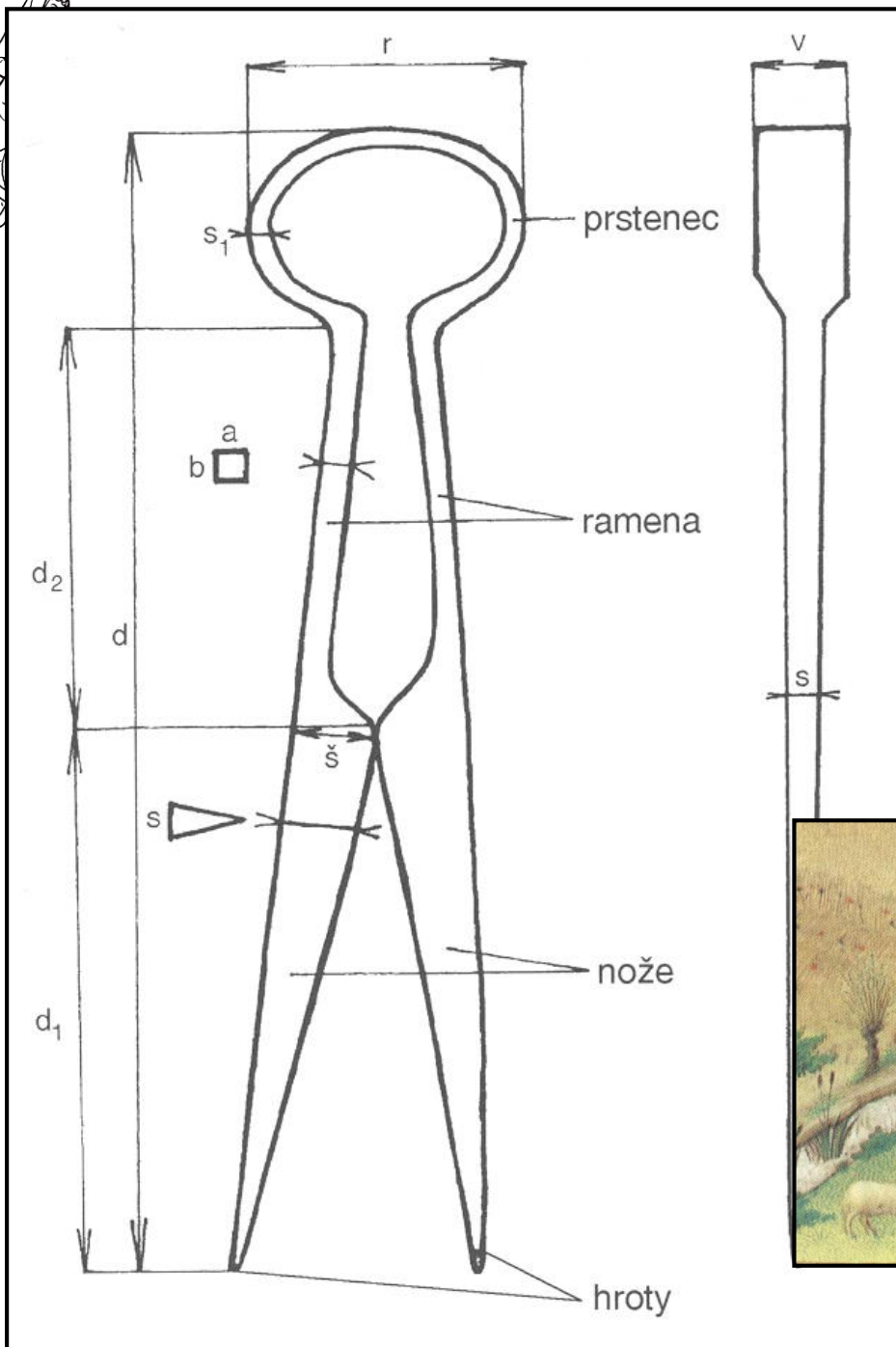







Semonice

# OVČÁCKÉ NŮŽKY

Pfaffenschlag



Typ II – pásková  
ramena

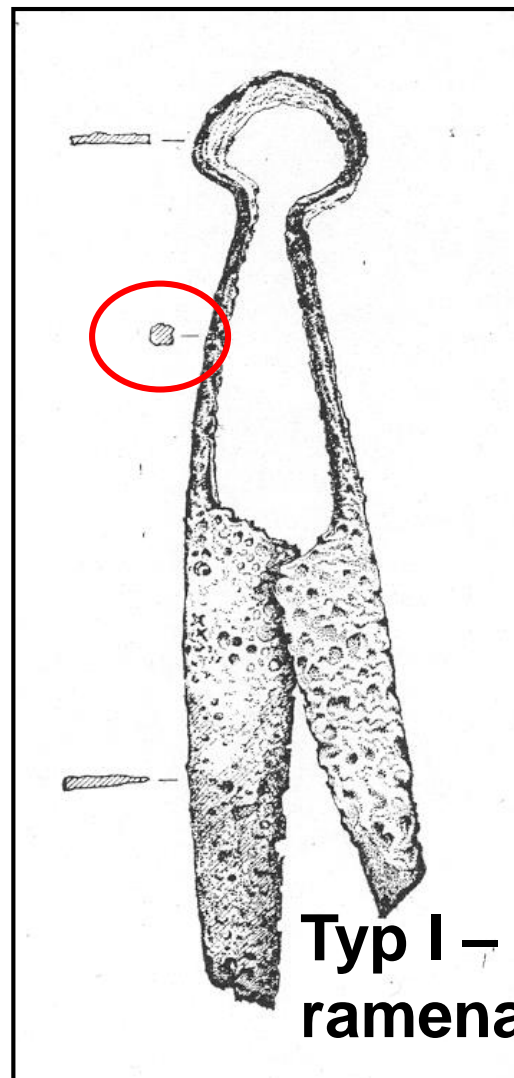

Typ I – tyčinkovité  
ramena



# HŘEBLO

- Bolkov
- Bradlo
- Sezimovo Ústí

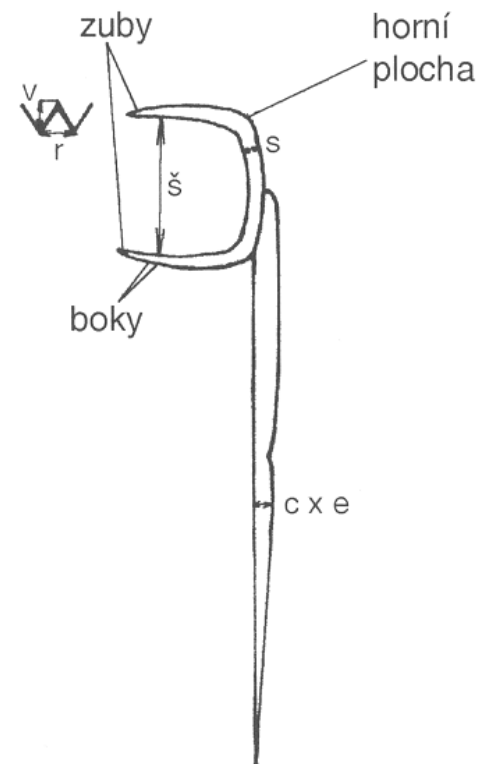
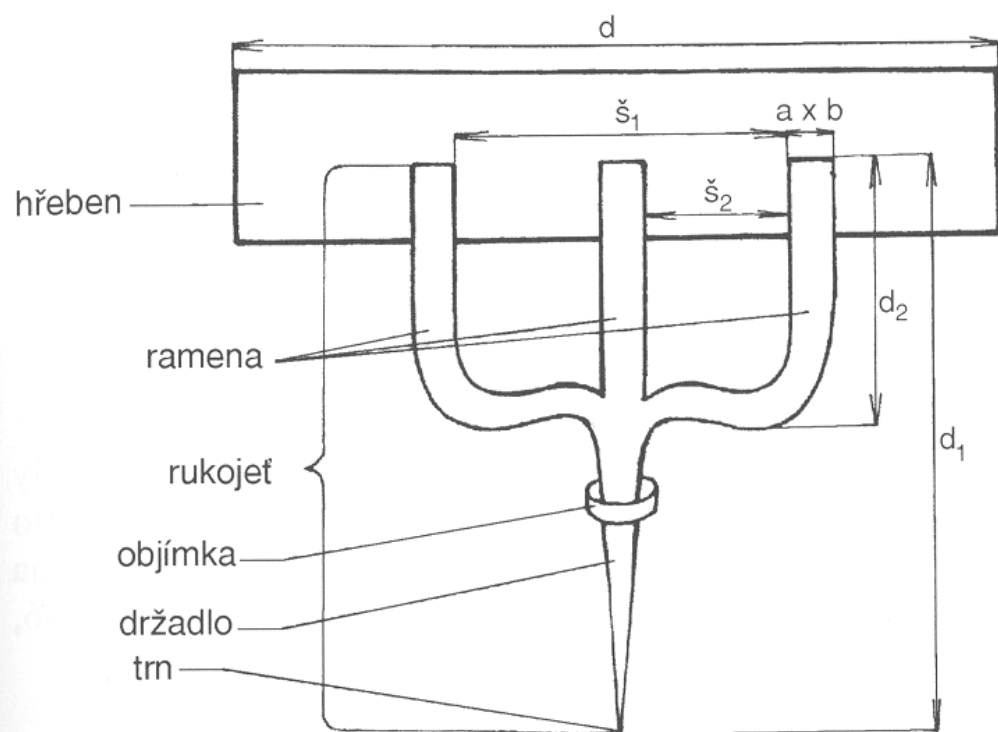



**jedna řada zubů**

**dvě řady zubů**

– připojení k rukojeti

1. rukojeť: tyčinka nebo trn

- Kepkov, Krásná nad Hornádem, Zalužany

2. rukojeť: vidlice

- 2 paralelní ramena
  - Rychleby
- 3 ramena
  - Bolkov, Hradištko, Semonice, Újezd u Tišnova
  - Mstěnice

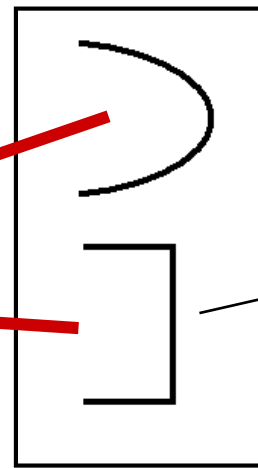

Mstěnice

Sezimovo Ústí

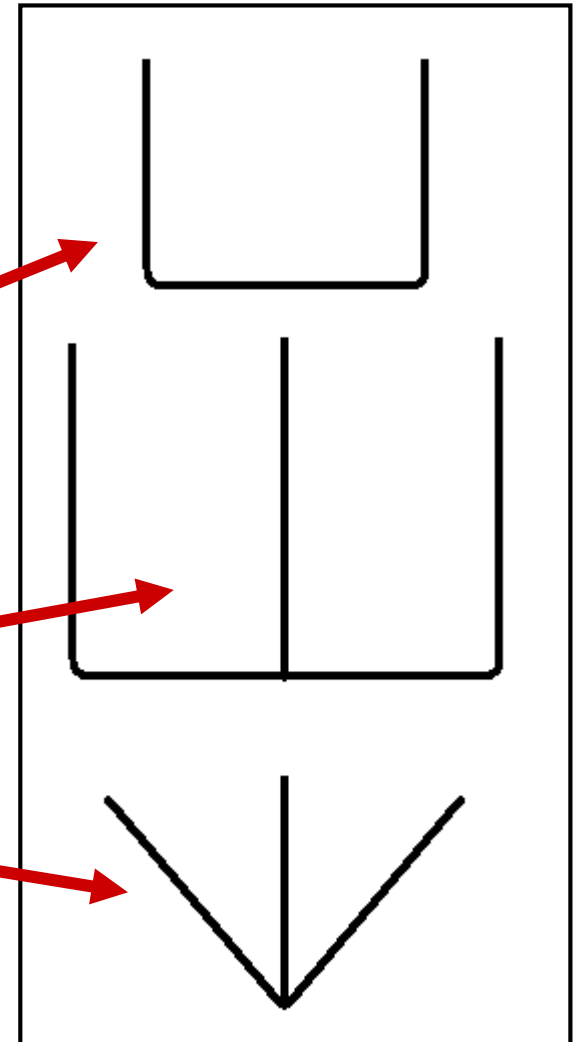

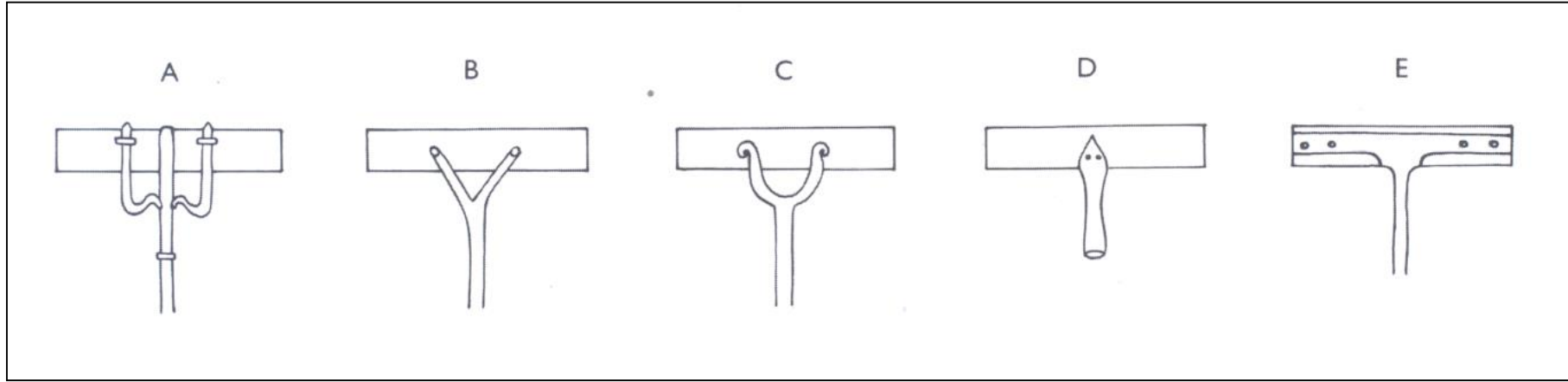

A 4458



A 7809



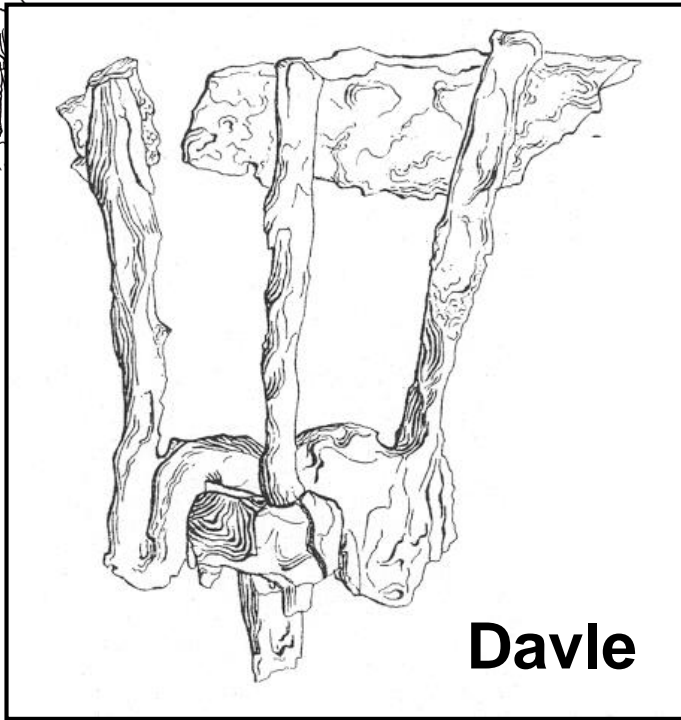

**Davle**

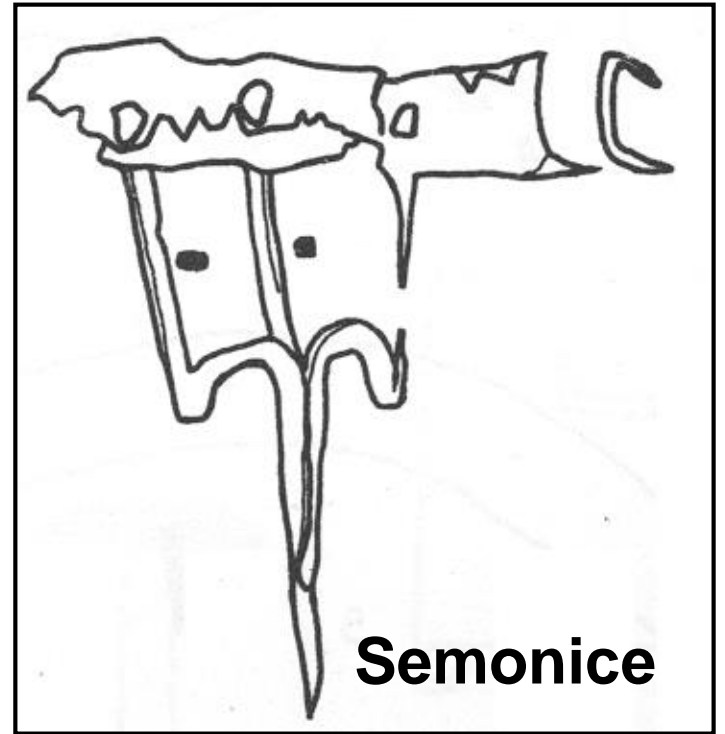

**Semonice**

## **Pfaffenschlag**

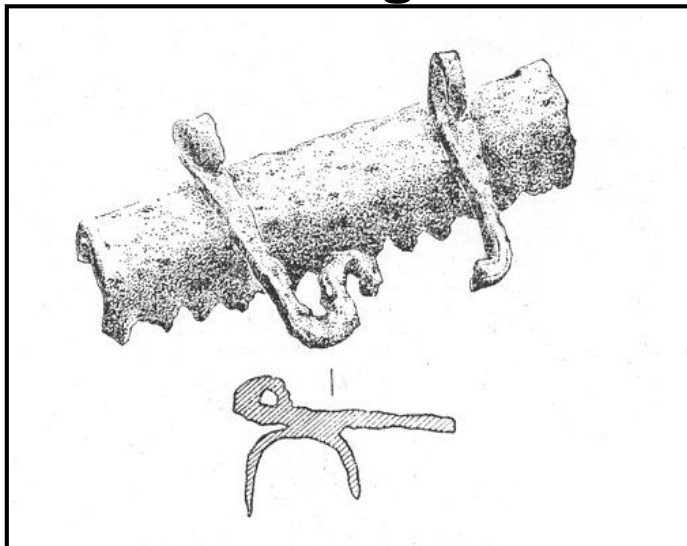

# VINAŘSKÝ NŮŽ

Velislavova bible

breviář křížovnického  
velmistra Lva, 1356

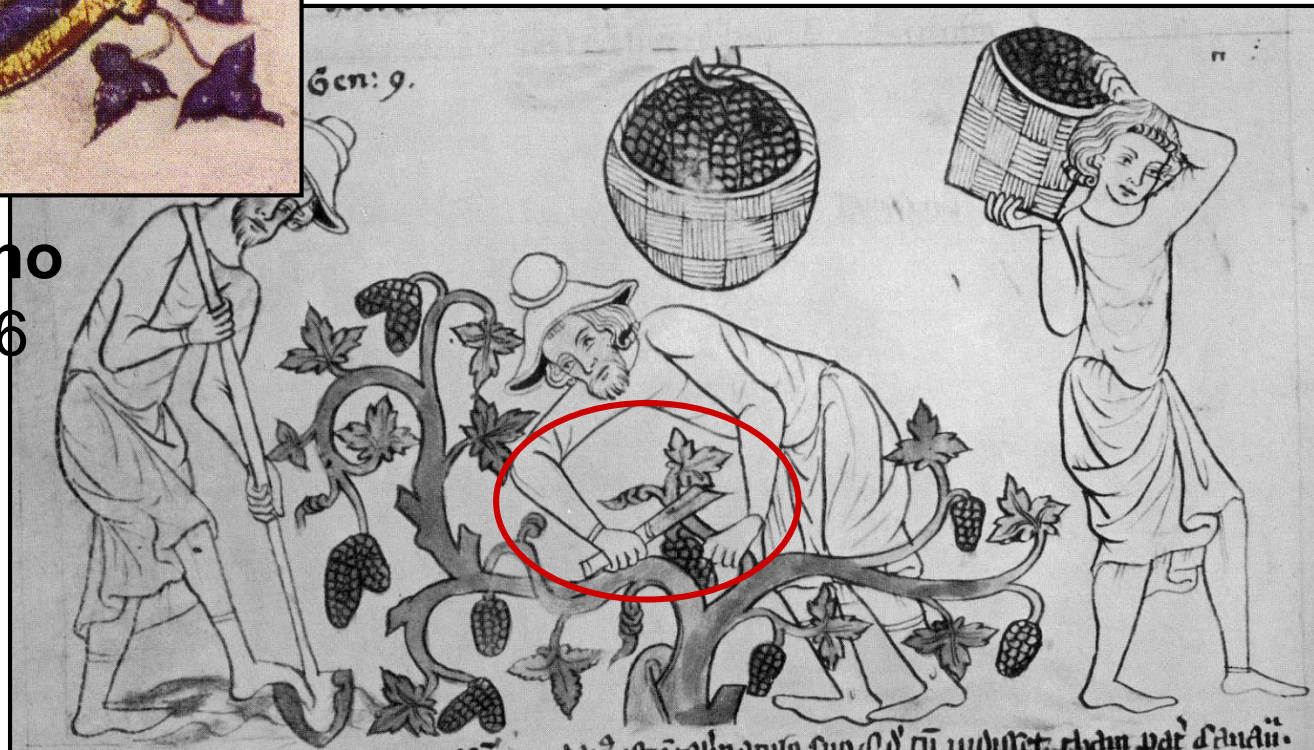



# VINAŘSKÝ NŮŽ

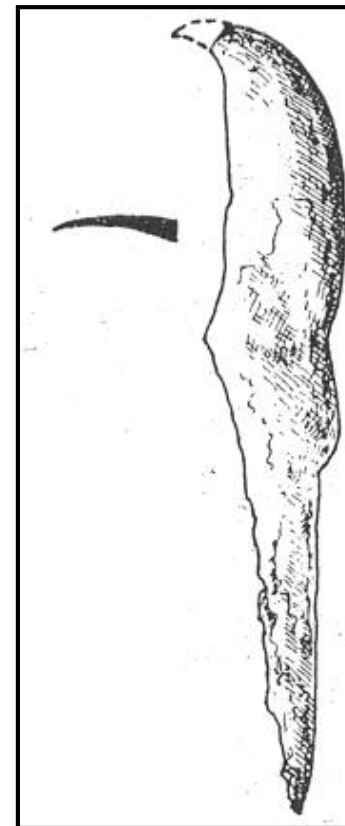
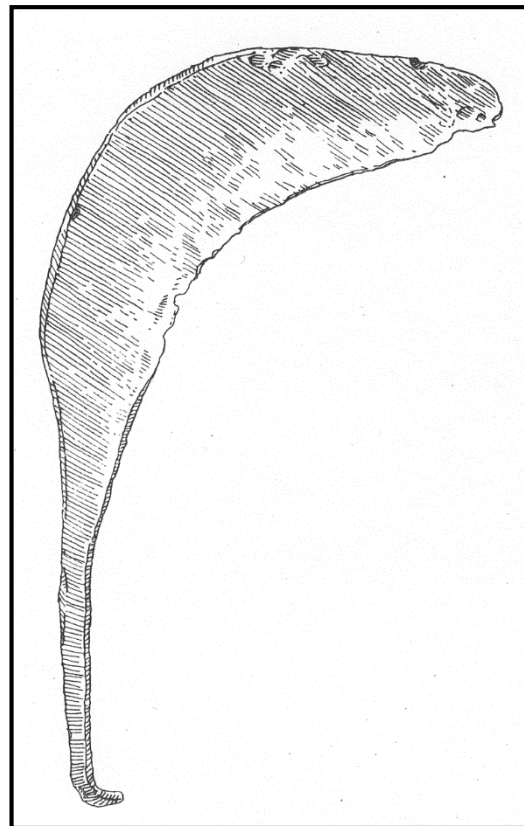
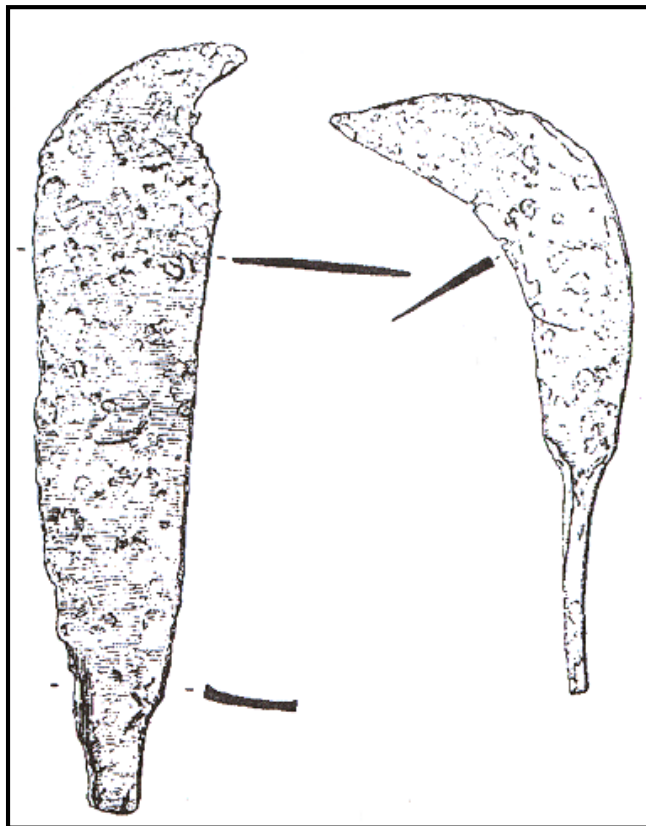

**Koválov**

**Kocanov**

Nálezy:

Reduta Uh. Hradiště



# zemědělské plodiny

- archeobotanické analýzy doložení pěstování

žito  
pšenice  
oves  
ječmen  
pohanka  
proso  
hrách  
čočka  
len  
konopí







**chov**





**OVCE**

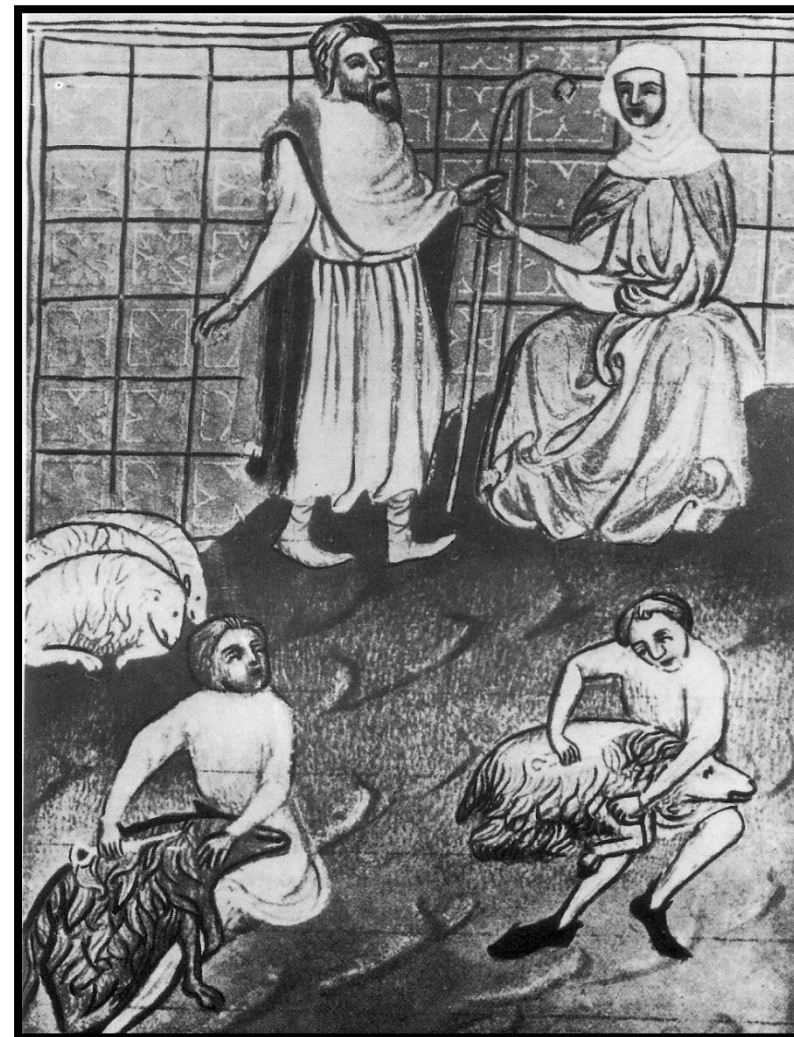

**Bible krále Václava, 1389 - 1400**



- vlna
- mléko (sýr, tvaroh)
- maso
- kůže
- rohy
- kopyta
- střívka



**KOZA**



**liber viaticus**



# PES

	pes - kosti	pes - jedinci
Bílina (62 – 63)	1	
Bílina 63 – 64)	45	7
Kouřim u sv. Jiří (61 – 62)	3	2
Hradištko u Davle	7	
Bylany u Kutné Hory		
Sezimovo Ústí (62)	1	
Sezimovo Ústí (65)		
Sezimovo Ústí (67)		
Budměřice	232	11
Mstěnice (77 – 81)	251	10



# rozbor osteologického materiálu

## Mstěnice (1977 – 1981)

- minimální počet jedinců
- **DOMÁCÍ**
  - tur domácí – 27 ks
  - ovce/koza domácí – 20 ks
  - prase domácí – 34 ks
  - kůň domácí – 26 ks
  - kočka domácí – 4 ks
  - pes domácí – 10 ks
  - kur domácí – 9 ks
  - husa domácí – 1 ks
- **DIVOKÁ**
  - srnec – 3 ks
  - vlk – 1 ks
  - liška – 1 ks
  - jelen – 2 ks
  - prase divoké – 1 ks
  - zajíc – 2 ks