

Malovaná keramika doby bronzové na řecké pevnině, přilehlých ostrovech a na Kypru.

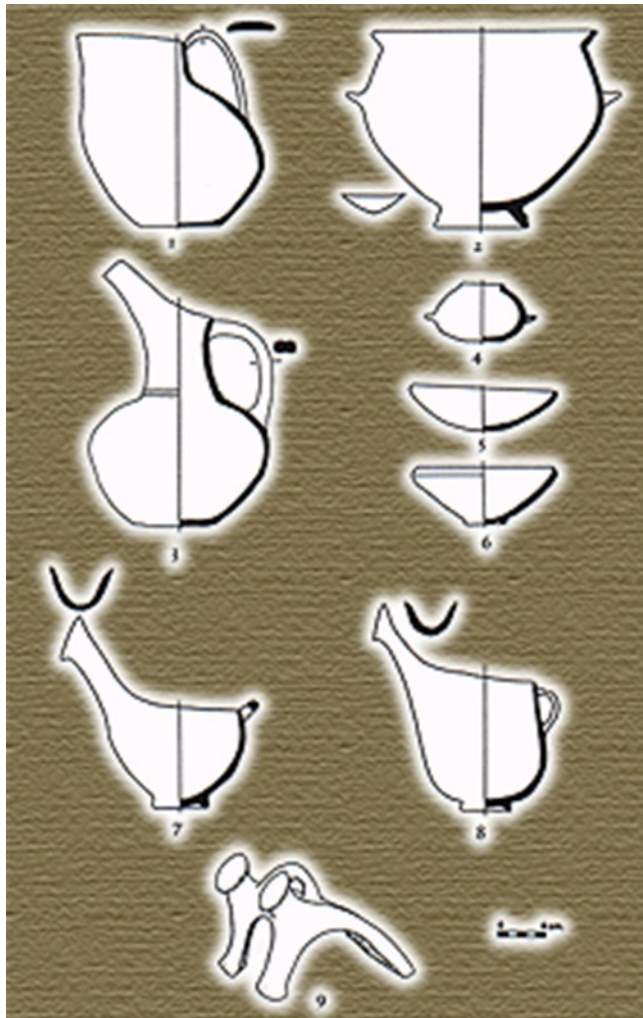

Early Helladic I



- **Euthresis** culture
- Podobně jako na Krétě: tradice kykladské ryté a vypíchané keramiky, „burnished“ ware, výjimečně tmavá jednoduchá malba na světlém povrchu
- Odlišné od neolitu spíše tvarem nádob





Sauceboat





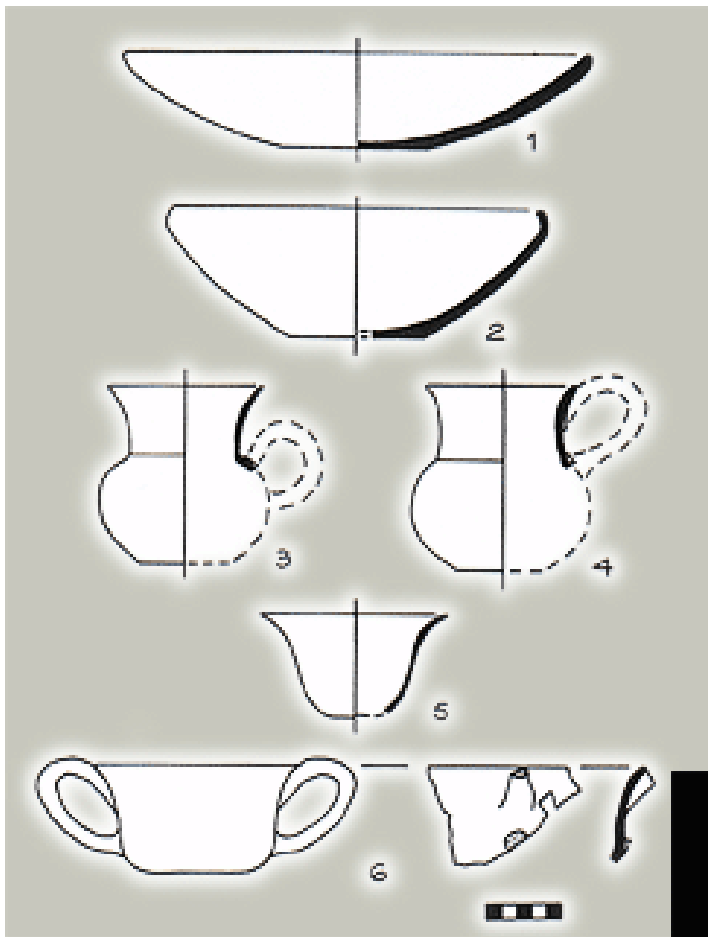

Depas amphikypellon

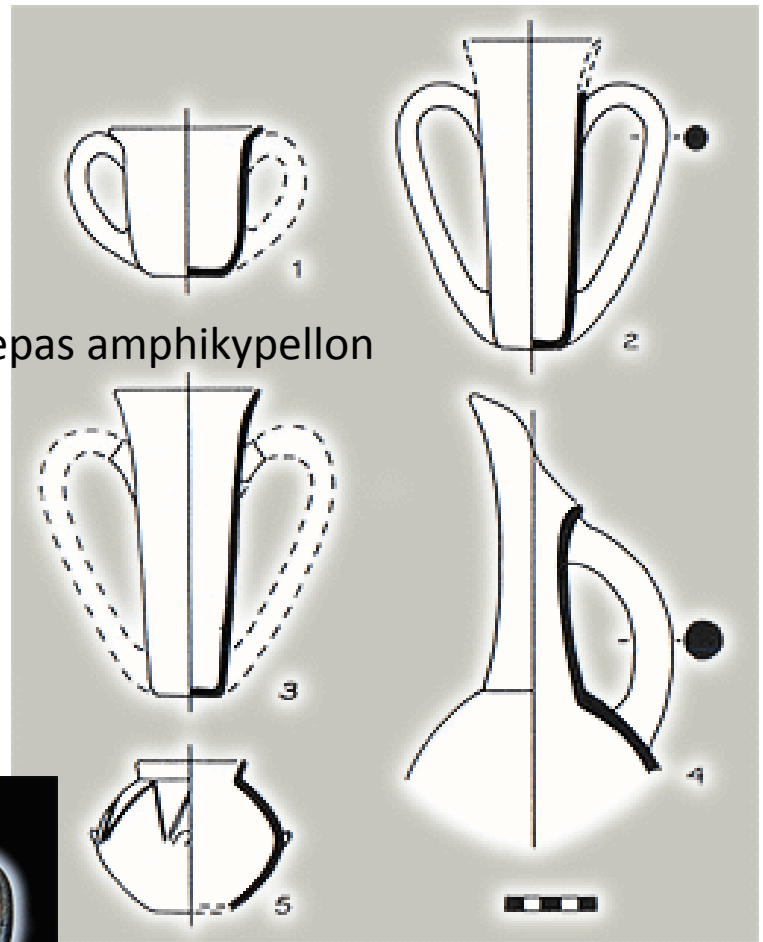

Early Helladic II

- Pokračuje tradice „omáčníků“
- Typický **urfirnis**
- Malba „dar-on-light“





Aegina



Early Helladic III

- Malovaná keramika častější
- Typologie hlavně podle stratigrafií v Lerně
- Hrnčířský kruh
- Typická picí nádoba: **tankard**
- Velké zásobnice
- První importy z Kréty









Ac



1

2

8

Tiryns





Berbati



Aegina



Anavysos







Middle Helladic

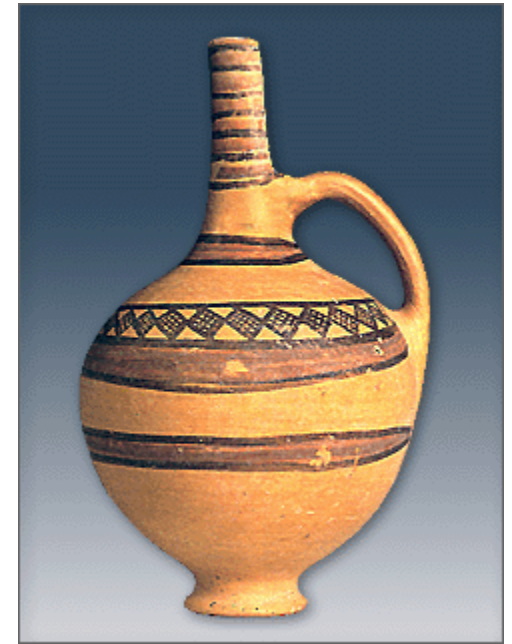

Minyan (ve 3 fázích)



Pojmenováno Schliemannem
podle mytologického krále
Orchomenu Minya



Matt painted wares





Experimentation with
geometric symbols

Appearance of some
leadership groups

Euthresis, MM II





Aegina



Mykény, MM III







Importy palácové keramiky z Kréty



Mycenaean – Early and Middle

- MMIII – LH IIA
- Dark-on-light
- Jakoby minojská, ale více kykladské a místní tradice
- Méně „naturalistická“ mlaba



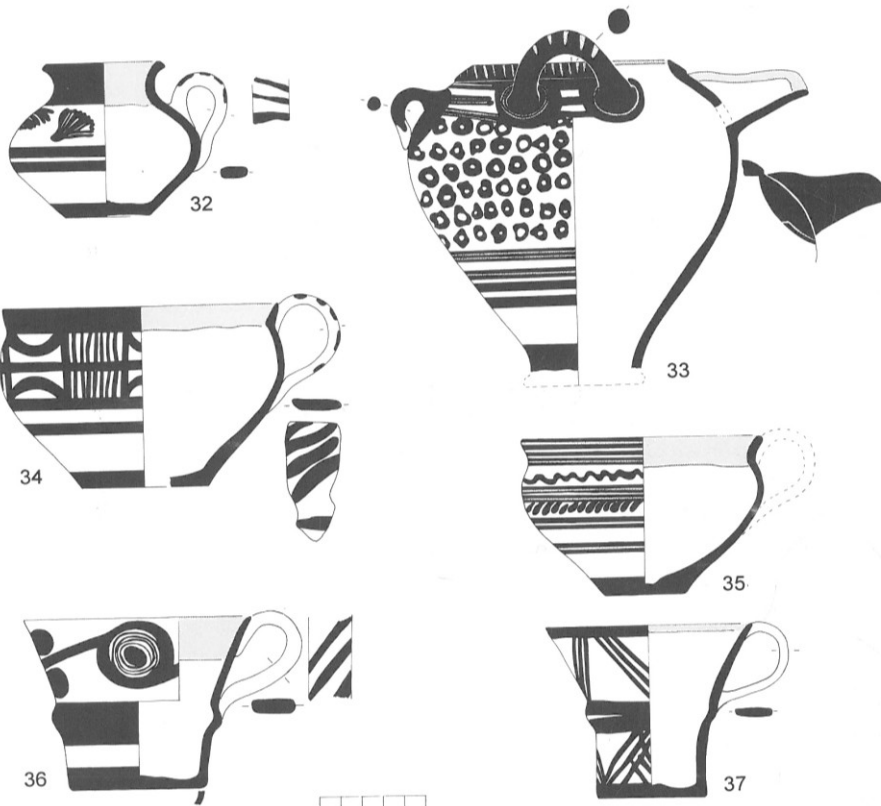
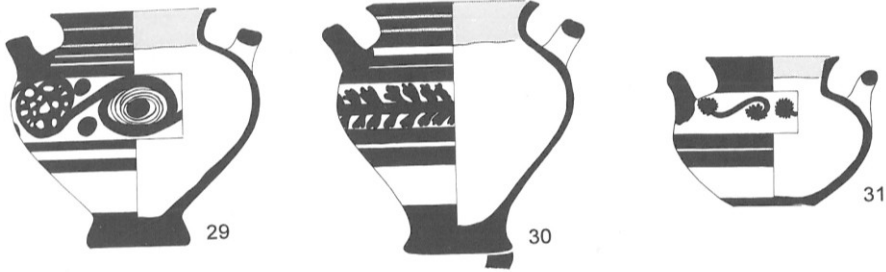

4

LH I pottery: 29 piriform jar: tangent spiral with blobs; 30 piriform jar: foliate band; 31 alabastron: urchins; 32 squat jug: crocus; 33 hole-mouthed jar: circles; 34 cup: vertical bars; 35 cup: foliate band; 36 Vapheio cup: tangent spiral with blobs; 37 Vapheio cup: diagonal bars.



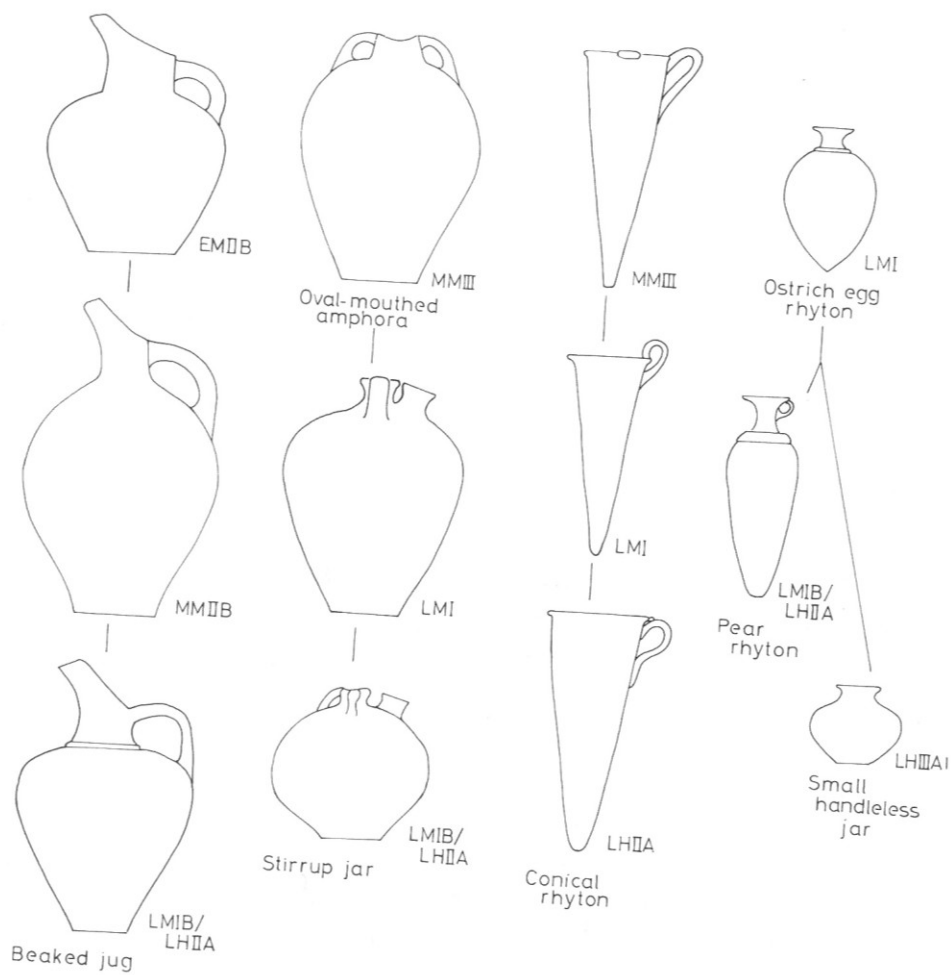

49 LH IIA: palatial shapes (not to scale).

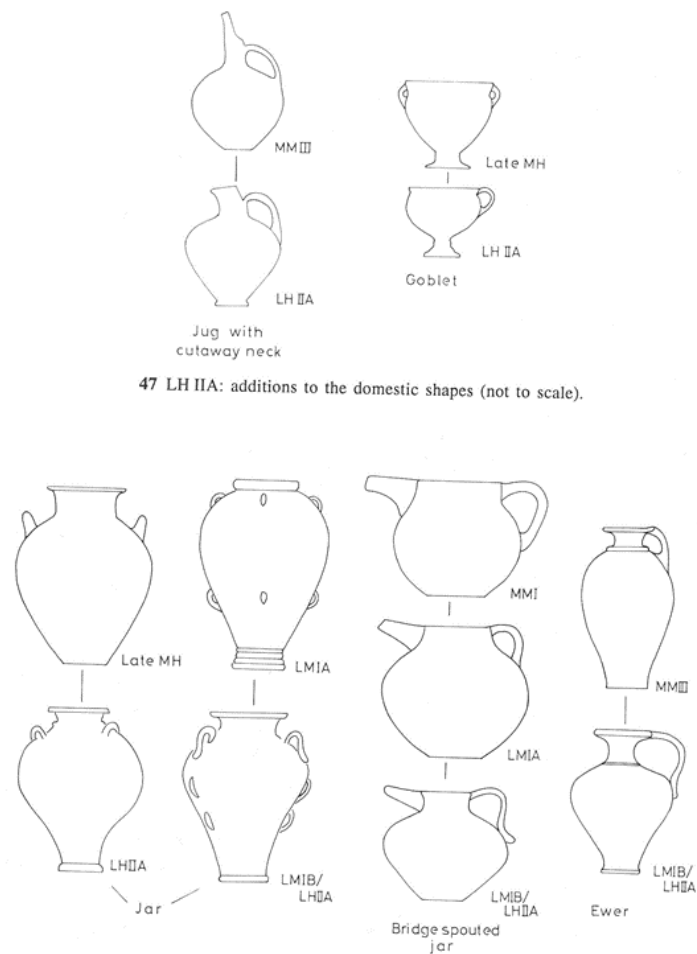

48 LH IIA: palatial shapes (not to scale).



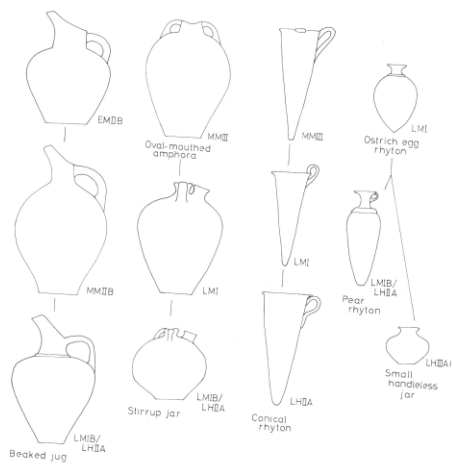

49 LH IIA: palatial shapes (not to scale).

SHAPES

Domestic Class (71-83)

The domestic shapes are those which continue from LHI. They comprise the piriform jar and alabastron (both generally with three handles instead of the two commonly found in LH I), the squat and jug, hole-mouthed jar, semi-globular and shallow cup (the latter a shallower version of the former) and the Vapheio cup, which is now generally tall with flaring sides and a very shallow midrib. There are two additions to this corpus: the **jug with cutaway neck (78)**, a standard Middle Helladic form (47),¹⁴⁵ which now became popular in the Mycenaean repertory, and the **goblet (82-83)**, which now became extremely common. It developed from the rounded version of the Middle Helladic goblet

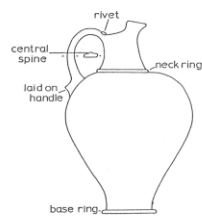

50 Metallic features found on clay vases



51 Silver ewer from Mycenae, Grave Circle A Shaft Grave V.

(47),¹⁴⁴ but was not part of the LH I Mycenaean corpus, probably because goblets in the Grey and Yellow Minyan tradition continued to be made. It has a wide metallic handle, sometimes with a clay rivet at the top.

The other domestic shapes may also take on metallic attributes. The piriform jar is found with a groove down the centre of the handle (71); the wide flat rim is also a metallic feature. The hole-mouthed jar and rounded and straight-sided alabastra may also sometimes have a grooved handle. The cup, like the goblet, may have a wide ribbon handle with a clay rivet at the top.

Palatial Class (84-90)

The palatial shapes are those copied from the Cretan repertory. Their development is illustrated (48-49):

Large jar (84). The jar has a mixed Mainland and Minoan origin deriving from the MM III/LM I form and from the MH III/LH I type. The fusion may have come about from the presence of Cretan jars in Messenia and Laconia, either imported or made locally by immigrant Cretan potters. The features of these jars were copied and blended with those of the Mainland jar. The latter had a globular body with two or three horizontal handles set diagonally on the shoulder.¹⁴⁵ In LH IIA one version of the form is found with three handles which are now set upright instead of diagonally. As a result of Cretan influence in this phase another version became more pear shaped and a type with three rows of three vertical handles in imitation of LM IB types became popular (54, 69). Metallic features can be seen in the neck ring and the groove or spine along the centre of the handles.

Bridge-spouted jug (85). Ceramic versions are known from MM I onwards,¹⁴⁶ but the LM I examples and their Mainland counterparts differ from the earlier ones in that they have metallic features, such as a neck ring and a laid-on handle with a central groove.

Ewer (86). The early version of the shape, found on Crete in MM I,¹⁴⁷ is not close to the later one. The LM IB and LH IIA palatial shape may derive ultimately from a stone type which was found



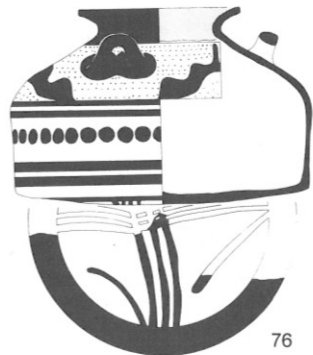
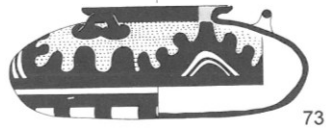
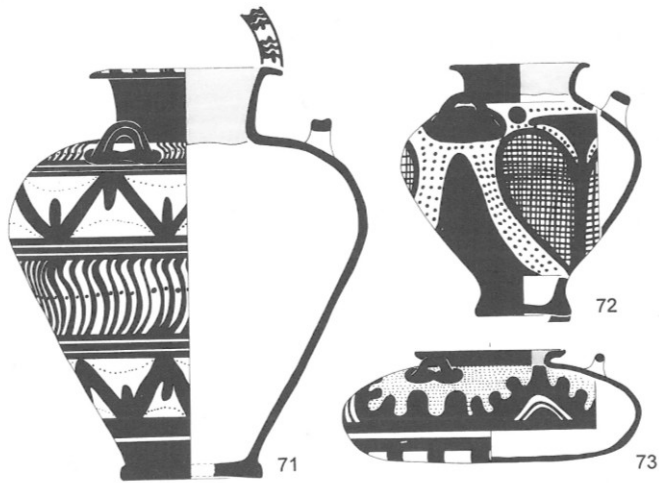

LH IIA pottery, domestic: 71 piriform jar: zones of zigzag and of curved stripes; 72 piriform jar: papyrus; 73 alabastron: rock pattern; 74 alabastron: ivy; 75 squat jug: hatched loop; 76 straight-sided alabastron: rock pattern with blobs.

LH IIA pottery, palatial: 87 beaked jug: elaborated ivy; 88 stirrup jar: shield; 89 conical rhyton: palm; 90 pear rhyton: double-axe.



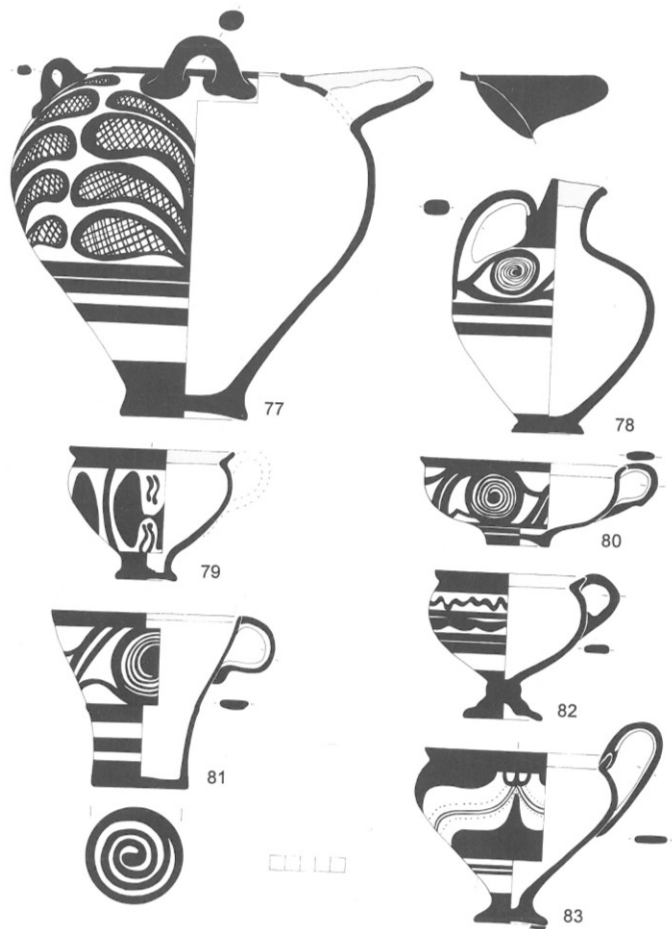

LH IIA pottery, domestic: 77 hole-mouthed jar: hatched loop; 78 jug with cutaway neck: stemmed spiral; 79 cup: double-axe; 80 cup, shallow: framed spiral; 81 Vapheio cup: framed spiral; 82 goblet: wavy line above rock pattern; 83 goblet with high handle: ogival canopy.

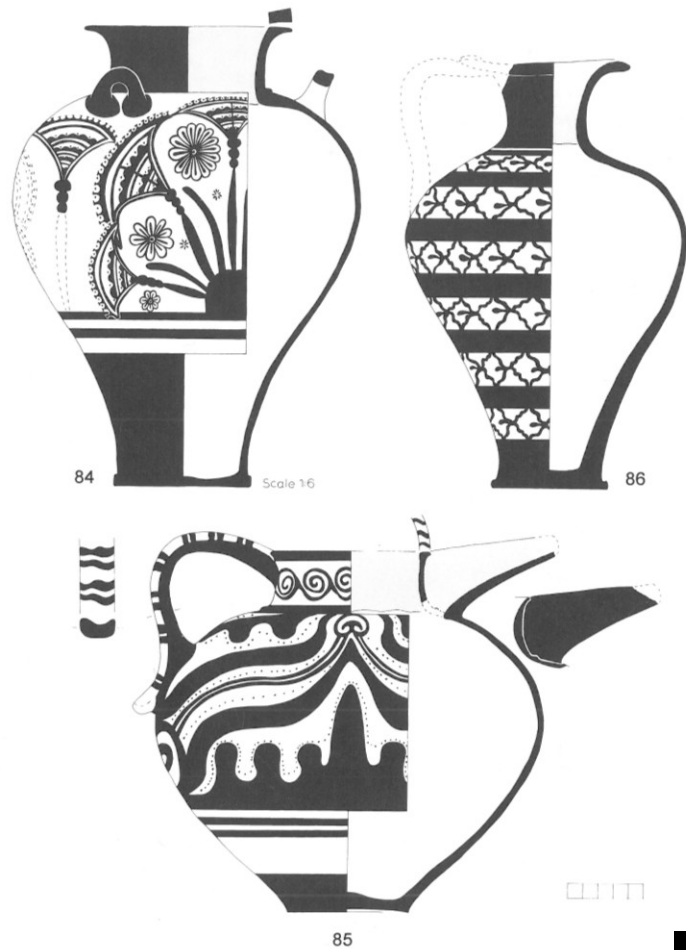

LH IIA pottery, palatial: 84 jar: papyrus; 85 bridge-spouted jug: ogival canopy; 86 ewer: rock





6725



64

Late Mycenaean

- LH IIB – LH III





92 LH IIB piriform jar with scale pattern from the Agora, Athens.



93 LH IIB Ephyraean goblet with lily from Korakou.

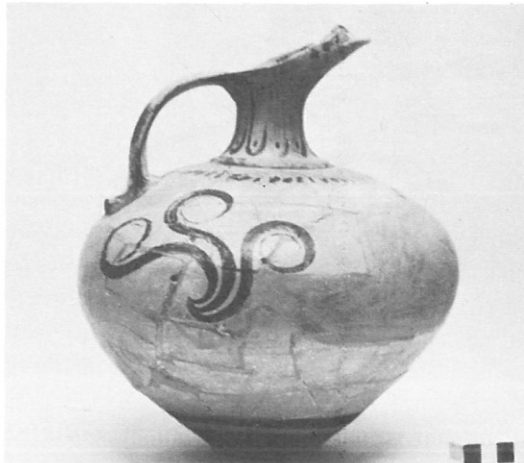

94 LH IIB beaked jug with argonaut from Iolkos.



95 LH IIB goblet with pendent rock pattern and wavy line from Iolkos.





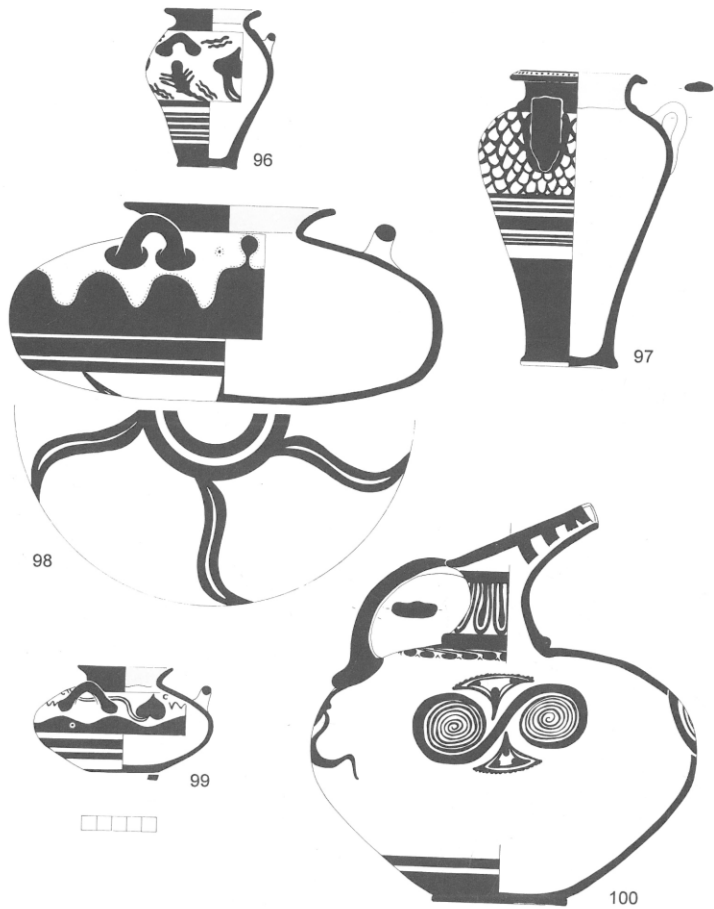

LH IIB pottery: **96** piriform jar: ivy with palm; **97** piriform jar: scale pattern; **98** alabastron: rock pattern; **99** alabastron: ivy with rock pattern; **100** beaked jug: group spiral.

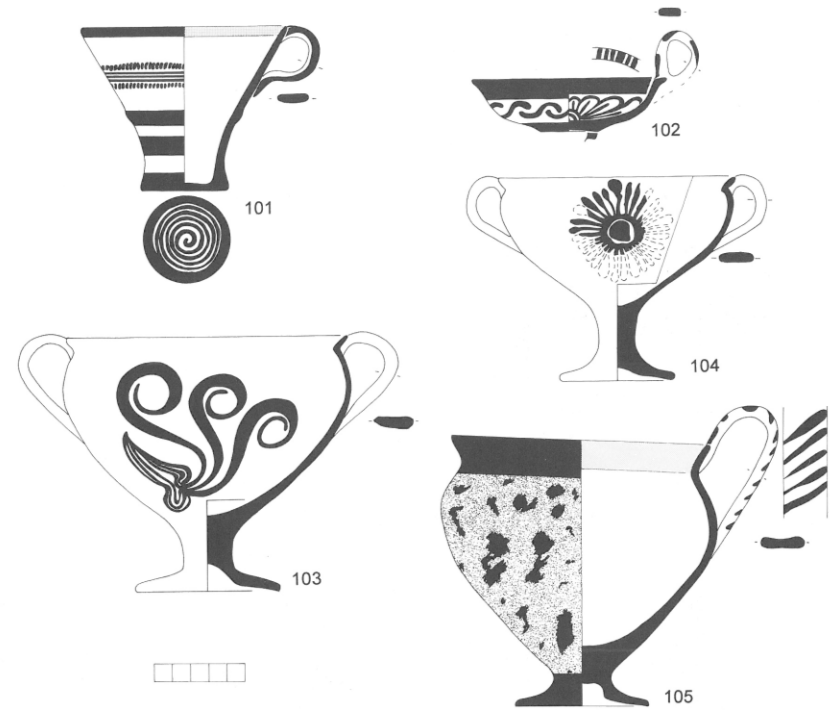

LH IIB pottery: **101** Vapheio cup: foliate band; **102** ring-handled cup: quirk out, rosette in; **103** Ephyraean goblet: argonaut; **104** Ephyraean goblet: rosette; **105** goblet: stipple.



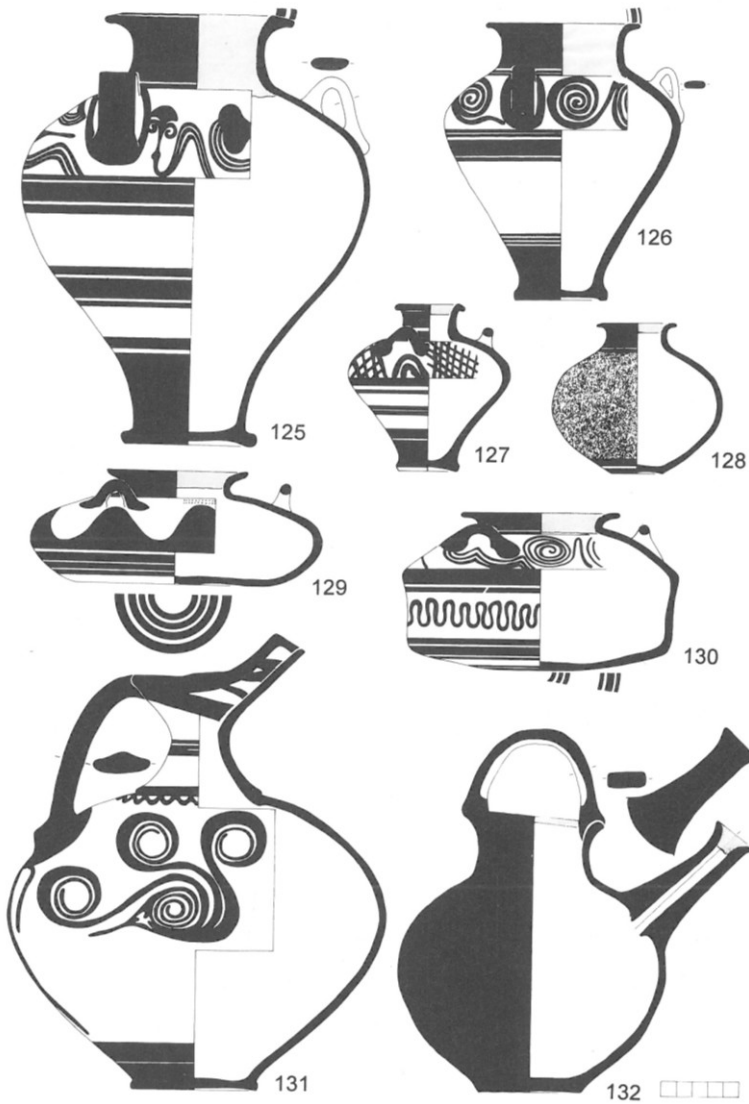

LH IIIA1 pottery: **125** piriform jar: ivy with papyrus; **126** piriform jar: running spiral; **127** piriform jar: net pattern with semi-circles under handle; **128** small handleless jar: stipple; **129** alabastron: rock pattern; **130** straight-sided alabastron: curve-stemmed spiral on shoulder, wavy band on sides; **131** beaked jug: argonaut; **132** feeding bottle: monochrome.



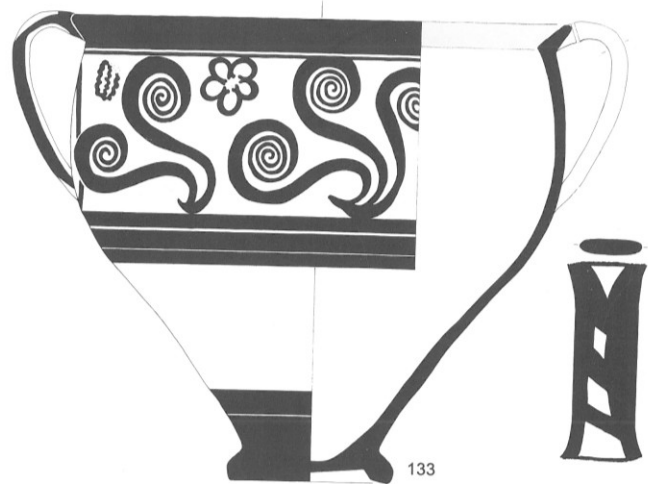

133

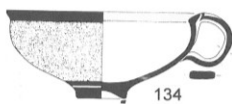

134



137



135

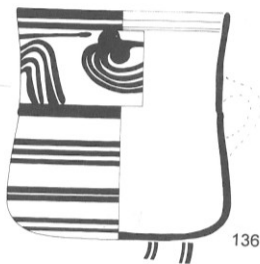

136

LH IIIA1 pottery: 133 krater: argonaut; 134 cup: stipple; 135 mug: scale pattern; 136 mug: ivy; 137 carinated conical cup: papyrus.

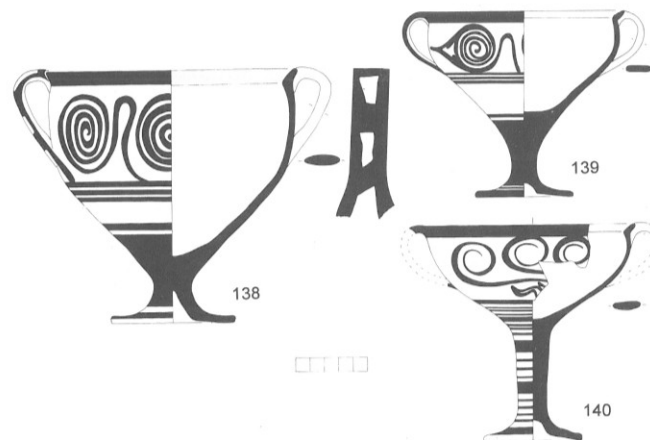

138

139

140

LH IIIA1 pottery: 138 goblet: curve-stemmed spiral; 139 goblet: curve-stemmed spiral; 140 kylix: argonaut.

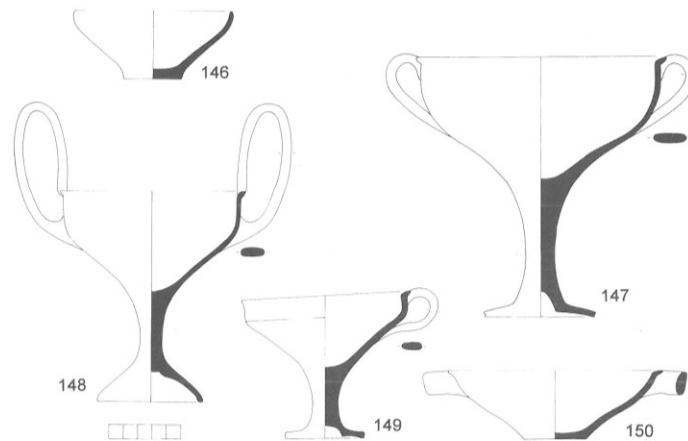

146

147

148

149

150

LH IIIA1 unpainted pottery: 146 lipless bowl; 147–149 kylix; 150 shallow bowl.







LH IIIA2

- Začíná piktorální styl
- Hlavně kratéry

Mycenaean Pottery: An Introduction



191 Jug with cow from Deiras.



191



189 Ring-based krater with stags from Enkomi.



190 Ring-based krater with cows from Berbati.





Ταφικές τελετουργίες και συμβολισμοί

Η τυπική τριμερής μορφή των μυκηναϊκών θολών και θαλαμικών τάφων, που αποτελούνται από δρόμο, στόμιο και θάλαμο, είναι η αρχιτεκτονική έκφραση της τριμερούς δομής των τελετουργιών που ακολουθούσαν με τη μετάβαση από τη ζωή στο θάνατο. Το στόμιο του τάφου, το όριο μεταξύ των δύο κόσμων, αποτελεί επίκεντρο των τελετουργικών πρακτικών. Οι πρακτικές αυτές έχουν έναν ιδιαίτερο ρόλο στη δημιουργία και τη διατήρηση της σωματικής και αλληλογικής ταυτότητας του νεκρού καθώς η ελευσία και το κοινωνικό γόητρο είναι ανάσχευα συνυφασμένα με την τελετουργική δράση. Η μυκηναϊκή ταφική εικονογραφία διασώζει παραστάσεις τελετουργικών πράξεων, όπως τυποποιημένες χρονομένες θρήνησις, μουσική και χορούς προς τιμήν των νεκρών. Στις σφραγίδες παρατηρούμε υλοποιήσεις με ανθρώπινα και ζωικά, που περιλαμβάνει ανθρώπινα μορφάκια και ζωόμορφα είδη όπως καβέλες και παραστάσεις πουλιών, βιτρόνων, κουνιάρων, ταύρων αλλά και μυθολογικές μορφές όπως σφίγγες ή γρίφους. Τα συμβόλα αυτά έχουν κενό χαρακτήρα και συνδέονται με το γόητρο του νεκρού, την «επιφάνεια» της θέλησής ή τη γενεότητα και την αναγέννηση.



Funerary ritual and symbolism

The typical tripartite plan of Mycenaean tholoi and chamber tombs comprising a passageway (stomia), an entrance (stomia) and chamber (thamosis) is the architectural expression of the tripartite structure of rituals associated with the transition from life to death. The stomaion, the boundary between this world and the next, is the focus of ritual practices. These practices play a special role in constructing and reconstructing of individual and communal identity, as political power, social prestige and ritual action are bound together. Mycenaean funerary iconography has preserved illustrations of ritual acts such as formalized gestures of mourning, music, and processions in honour of the dead. Mortuary practices adopted a common symbolic language which includes human and animal figures and depictions of birds, frogs, lions, bulls as well as mythological depictions such as sphinxes and griffins. These symbols which bear sacred character are associated with the status of the dead, the epithany of a divinity or fertility and rebirth.



1. Αγγείο με κρηνοειδή διακόσμηση. Μυκηναϊκό θολό, περί το 1500-1450 π.Χ. Μουσείο Μπενάκη, Αθήνα, αρ. καταλόγου 1000.001.01
2. Αγγείο με κρηνοειδή διακόσμηση. Μυκηναϊκό θολό, περί το 1500-1450 π.Χ. Μουσείο Μπενάκη, Αθήνα, αρ. καταλόγου 1000.001.02
3. Αγγείο με κρηνοειδή διακόσμηση. Μυκηναϊκό θολό, περί το 1500-1450 π.Χ. Μουσείο Μπενάκη, Αθήνα, αρ. καταλόγου 1000.001.03
4. Αγγείο με κρηνοειδή διακόσμηση. Μυκηναϊκό θολό, περί το 1500-1450 π.Χ. Μουσείο Μπενάκη, Αθήνα, αρ. καταλόγου 1000.001.04
5. Αγγείο με κρηνοειδή διακόσμηση. Μυκηναϊκό θολό, περί το 1500-1450 π.Χ. Μουσείο Μπενάκη, Αθήνα, αρ. καταλόγου 1000.001.05
6. Αγγείο με κρηνοειδή διακόσμηση. Μυκηναϊκό θολό, περί το 1500-1450 π.Χ. Μουσείο Μπενάκη, Αθήνα, αρ. καταλόγου 1000.001.06
7. Αγγείο με κρηνοειδή διακόσμηση. Μυκηναϊκό θολό, περί το 1500-1450 π.Χ. Μουσείο Μπενάκη, Αθήνα, αρ. καταλόγου 1000.001.07
8. Αγγείο με κρηνοειδή διακόσμηση. Μυκηναϊκό θολό, περί το 1500-1450 π.Χ. Μουσείο Μπενάκη, Αθήνα, αρ. καταλόγου 1000.001.08
9. Αγγείο με κρηνοειδή διακόσμηση. Μυκηναϊκό θολό, περί το 1500-1450 π.Χ. Μουσείο Μπενάκη, Αθήνα, αρ. καταλόγου 1000.001.09
10. Αγγείο με κρηνοειδή διακόσμηση. Μυκηναϊκό θολό, περί το 1500-1450 π.Χ. Μουσείο Μπενάκη, Αθήνα, αρ. καταλόγου 1000.001.10
11. Μικρή αγγειομορφή με κρηνοειδή διακόσμηση. Μυκηναϊκό θολό, περί το 1500-1450 π.Χ. Μουσείο Μπενάκη, Αθήνα, αρ. καταλόγου 1000.001.11
12. Μικρή αγγειομορφή με κρηνοειδή διακόσμηση. Μυκηναϊκό θολό, περί το 1500-1450 π.Χ. Μουσείο Μπενάκη, Αθήνα, αρ. καταλόγου 1000.001.12
13. Μικρή αγγειομορφή με κρηνοειδή διακόσμηση. Μυκηναϊκό θολό, περί το 1500-1450 π.Χ. Μουσείο Μπενάκη, Αθήνα, αρ. καταλόγου 1000.001.13
14. Μικρή αγγειομορφή με κρηνοειδή διακόσμηση. Μυκηναϊκό θολό, περί το 1500-1450 π.Χ. Μουσείο Μπενάκη, Αθήνα, αρ. καταλόγου 1000.001.14
15. Μικρή αγγειομορφή με κρηνοειδή διακόσμηση. Μυκηναϊκό θολό, περί το 1500-1450 π.Χ. Μουσείο Μπενάκη, Αθήνα, αρ. καταλόγου 1000.001.15
16. Μικρή αγγειομορφή με κρηνοειδή διακόσμηση. Μυκηναϊκό θολό, περί το 1500-1450 π.Χ. Μουσείο Μπενάκη, Αθήνα, αρ. καταλόγου 1000.001.16
17. Μικρή αγγειομορφή με κρηνοειδή διακόσμηση. Μυκηναϊκό θολό, περί το 1500-1450 π.Χ. Μουσείο Μπενάκη, Αθήνα, αρ. καταλόγου 1000.001.17
18. Μικρή αγγειομορφή με κρηνοειδή διακόσμηση. Μυκηναϊκό θολό, περί το 1500-1450 π.Χ. Μουσείο Μπενάκη, Αθήνα, αρ. καταλόγου 1000.001.18
19. Μικρή αγγειομορφή με κρηνοειδή διακόσμηση. Μυκηναϊκό θολό, περί το 1500-1450 π.Χ. Μουσείο Μπενάκη, Αθήνα, αρ. καταλόγου 1000.001.19
20. Μικρή αγγειομορφή με κρηνοειδή διακόσμηση. Μυκηναϊκό θολό, περί το 1500-1450 π.Χ. Μουσείο Μπενάκη, Αθήνα, αρ. καταλόγου 1000.001.20
21. Μικρή αγγειομορφή με κρηνοειδή διακόσμηση. Μυκηναϊκό θολό, περί το 1500-1450 π.Χ. Μουσείο Μπενάκη, Αθήνα, αρ. καταλόγου 1000.001.21
22. Μικρή αγγειομορφή με κρηνοειδή διακόσμηση. Μυκηναϊκό θολό, περί το 1500-1450 π.Χ. Μουσείο Μπενάκη, Αθήνα, αρ. καταλόγου 1000.001.22
23. Μικρή αγγειομορφή με κρηνοειδή διακόσμηση. Μυκηναϊκό θολό, περί το 1500-1450 π.Χ. Μουσείο Μπενάκη, Αθήνα, αρ. καταλόγου 1000.001.23
24. Μικρή αγγειομορφή με κρηνοειδή διακόσμηση. Μυκηναϊκό θολό, περί το 1500-1450 π.Χ. Μουσείο Μπενάκη, Αθήνα, αρ. καταλόγου 1000.001.24
25. Μικρή αγγειομορφή με κρηνοειδή διακόσμηση. Μυκηναϊκό θολό, περί το 1500-1450 π.Χ. Μουσείο Μπενάκη, Αθήνα, αρ. καταλόγου 1000.001.25
26. Μικρή αγγειομορφή με κρηνοειδή διακόσμηση. Μυκηναϊκό θολό, περί το 1500-1450 π.Χ. Μουσείο Μπενάκη, Αθήνα, αρ. καταλόγου 1000.001.26
27. Μικρή αγγειομορφή με κρηνοειδή διακόσμηση. Μυκηναϊκό θολό, περί το 1500-1450 π.Χ. Μουσείο Μπενάκη, Αθήνα, αρ. καταλόγου 1000.001.27
28. Μικρή αγγειομορφή με κρηνοειδή διακόσμηση. Μυκηναϊκό θολό, περί το 1500-1450 π.Χ. Μουσείο Μπενάκη, Αθήνα, αρ. καταλόγου 1000.001.28
29. Μικρή αγγειομορφή με κρηνοειδή διακόσμηση. Μυκηναϊκό θολό, περί το 1500-1450 π.Χ. Μουσείο Μπενάκη, Αθήνα, αρ. καταλόγου 1000.001.29
30. Μικρή αγγειομορφή με κρηνοειδή διακόσμηση. Μυκηναϊκό θολό, περί το 1500-1450 π.Χ. Μουσείο Μπενάκη, Αθήνα, αρ. καταλόγου 1000.001.30
31. Μικρή αγγειομορφή με κρηνοειδή διακόσμηση. Μυκηναϊκό θολό, περί το 1500-1450 π.Χ. Μουσείο Μπενάκη, Αθήνα, αρ. καταλόγου 1000.001.31
32. Μικρή αγγειομορφή με κρηνοειδή διακόσμηση. Μυκηναϊκό θολό, περί το 1500-1450 π.Χ. Μουσείο Μπενάκη, Αθήνα, αρ. καταλόγου 1000.001.32
33. Μικρή αγγειομορφή με κρηνοειδή διακόσμηση. Μυκηναϊκό θολό, περί το 1500-1450 π.Χ. Μουσείο Μπενάκη, Αθήνα, αρ. καταλόγου 1000.001.33
34. Μικρή αγγειομορφή με κρηνοειδή διακόσμηση. Μυκηναϊκό θολό, περί το 1500-1450 π.Χ. Μουσείο Μπενάκη, Αθήνα, αρ. καταλόγου 1000.001.34
35. Μικρή αγγειομορφή με κρηνοειδή διακόσμηση. Μυκηναϊκό θολό, περί το 1500-1450 π.Χ. Μουσείο Μπενάκη, Αθήνα, αρ. καταλόγου 1000.001.35
36. Μικρή αγγειομορφή με κρηνοειδή διακόσμηση. Μυκηναϊκό θολό, περί το 1500-1450 π.Χ. Μουσείο Μπενάκη, Αθήνα, αρ. καταλόγου 1000.001.36
37. Μικρή αγγειομορφή με κρηνοειδή διακόσμηση. Μυκηναϊκό θολό, περί το 1500-1450 π.Χ. Μουσείο Μπενάκη, Αθήνα, αρ. καταλόγου 1000.001.37
38. Μικρή αγγειομορφή με κρηνοειδή διακόσμηση. Μυκηναϊκό θολό, περί το 1500-1450 π.Χ. Μουσείο Μπενάκη, Αθήνα, αρ. καταλόγου 1000.001.38
39. Μικρή αγγειομορφή με κρηνοειδή διακόσμηση. Μυκηναϊκό θολό, περί το 1500-1450 π.Χ. Μουσείο Μπενάκη, Αθήνα, αρ. καταλόγου 1000.001.39
40. Μικρή αγγειομορφή με κρηνοειδή διακόσμηση. Μυκηναϊκό θολό, περί το 1500-1450 π.Χ. Μουσείο Μπενάκη, Αθήνα, αρ. καταλόγου 1000.001.40
41. Μικρή αγγειομορφή με κρηνοειδή διακόσμηση. Μυκηναϊκό θολό, περί το 1500-1450 π.Χ. Μουσείο Μπενάκη, Αθήνα, αρ. καταλόγου 1000.001.41
42. Μικρή αγγειομορφή με κρηνοειδή διακόσμηση. Μυκηναϊκό θολό, περί το 1500-1450 π.Χ. Μουσείο Μπενάκη, Αθήνα, αρ. καταλόγου 1000.001.42
43. Μικρή αγγειομορφή με κρηνοειδή διακόσμηση. Μυκηναϊκό θολό, περί το 1500-1450 π.Χ. Μουσείο Μπενάκη, Αθήνα, αρ. καταλόγου 1000.001.43
44. Μικρή αγγειομορφή με κρηνοειδή διακόσμηση. Μυκηναϊκό θολό, περί το 1500-1450 π.Χ. Μουσείο Μπενάκη, Αθήνα, αρ. καταλόγου 1000.001.44
45. Μικρή αγγειομορφή με κρηνοειδή διακόσμηση. Μυκηναϊκό θολό, περί το 1500-1450 π.Χ. Μουσείο Μπενάκη, Αθήνα, αρ. καταλόγου 1000.001.45
46. Μικρή αγγειομορφή με κρηνοειδή διακόσμηση. Μυκηναϊκό θολό, περί το 1500-1450 π.Χ. Μουσείο Μπενάκη, Αθήνα, αρ. καταλόγου 1000.001.46
47. Μικρή αγγειομορφή με κρηνοειδή διακόσμηση. Μυκηναϊκό θολό, περί το 1500-1450 π.Χ. Μουσείο Μπενάκη, Αθήνα, αρ. καταλόγου 1000.001.47
48. Μικρή αγγειομορφή με κρηνοειδή διακόσμηση. Μυκηναϊκό θολό, περί το 1500-1450 π.Χ. Μουσείο Μπενάκη, Αθήνα, αρ. καταλόγου 1000.001.48
49. Μικρή αγγειομορφή με κρηνοειδή διακόσμηση. Μυκηναϊκό θολό, περί το 1500-1450 π.Χ. Μουσείο Μπενάκη, Αθήνα, αρ. καταλόγου 1000.001.49
50. Μικρή αγγειομορφή με κρηνοειδή διακόσμηση. Μυκηναϊκό θολό, περί το 1500-1450 π.Χ. Μουσείο Μπενάκη, Αθήνα, αρ. καταλόγου 1000.001.50



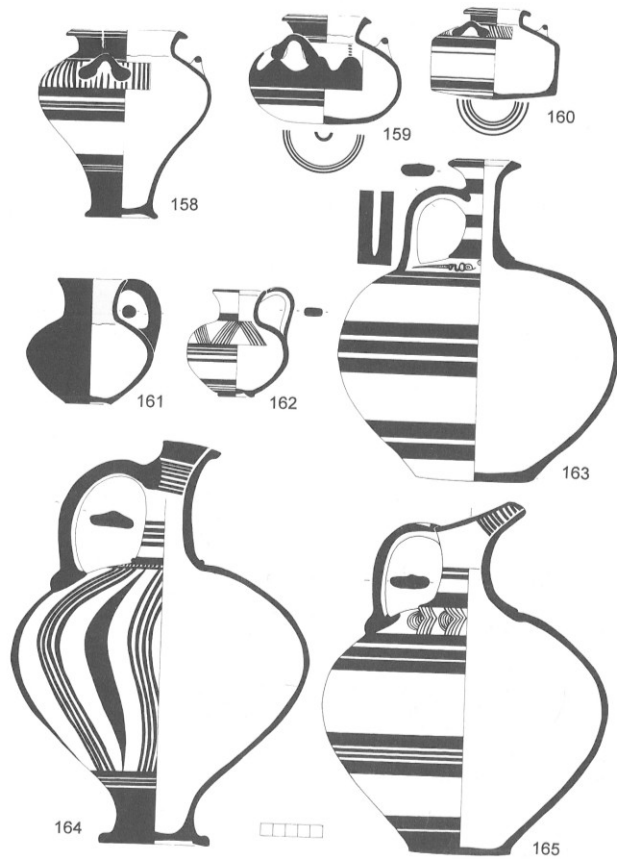

LHIIIA2: **158** piriform jar: foliate band; **159** alabastron: rock pattern; **160** straight-sided alabastron: foliate band; **161** small globular jug: monochrome; **162** small globular jug: zigzag; **163** narrow-necked jug: whorl-shell; **164** jug with cutaway neck: curved stripes; **165** beaked jug: multiple stem with bivalve.

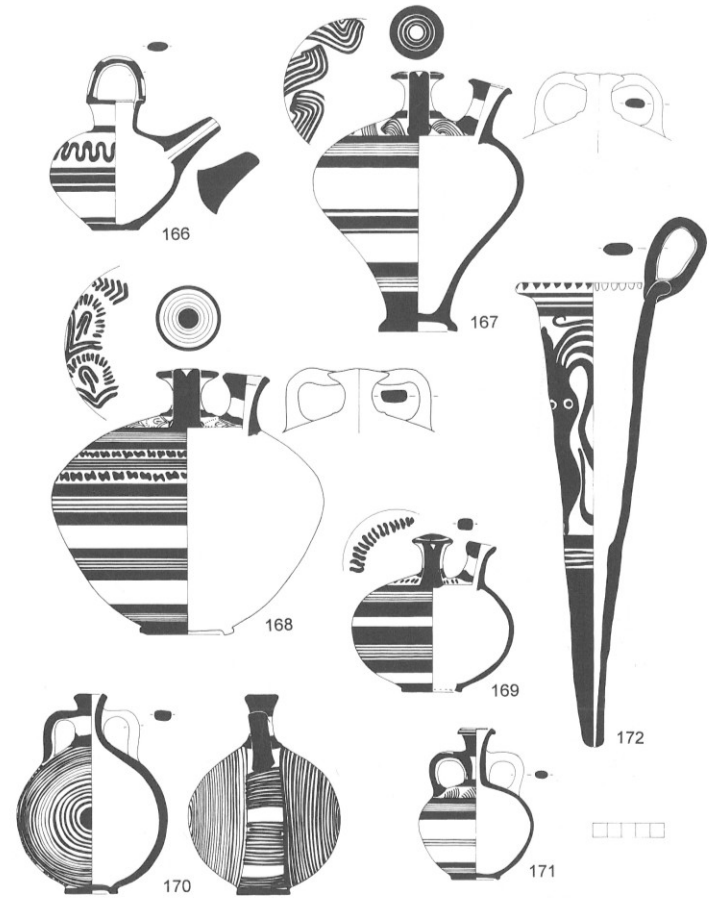

LHIIIA2 pottery: **166** feeding bottle: wavy band; **167** stirrup jar, piriform: multiple stem, hooked; **168** stirrup jar, rounded: flower; **169** stirrup jar, rounded: foliate band; **170** flask: vertical concentric circles with horizontal bars in side panel; **171** flask: multiple stem, curved; **172** conical rhyton: octopus.





LH IIIA2

78

Mycenaean Pottery: An Introduction

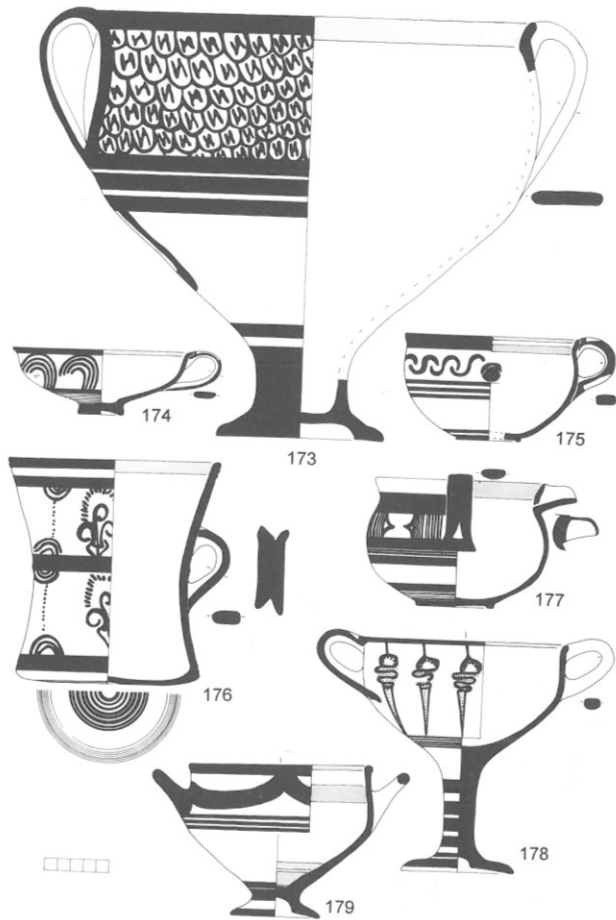

LH IIIA2 pottery: 173 stemmed krater: scale pattern with N fill; 174 cup: multiple stem, hooked; 175 cup with side handles: quirk; 176 mug: flower; 177 spouted cup: wavy border; 178 kylix: whorl-shell; 179 stemmed bowl: wavy band.

LH IIIB

85

The Pottery: LH IIIB

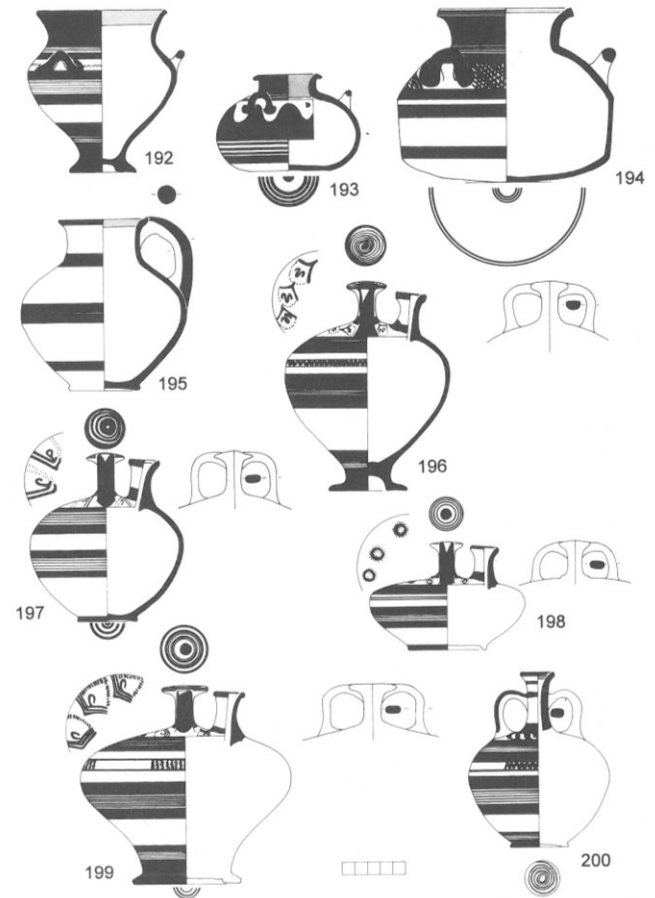

LH IIIB pottery: 192 piriform jar: V pattern; 193 alabastron: rock pattern; 194 straight-sided alabastron: net; 195 jug: linear; 196 stirrup jar, piriform: flower; 197 stirrup jar, rounded: flower; 198 stirrup jar, squat: dot rosette; 199 stirrup jar, conical: flower; 200 flask: joined quirk.



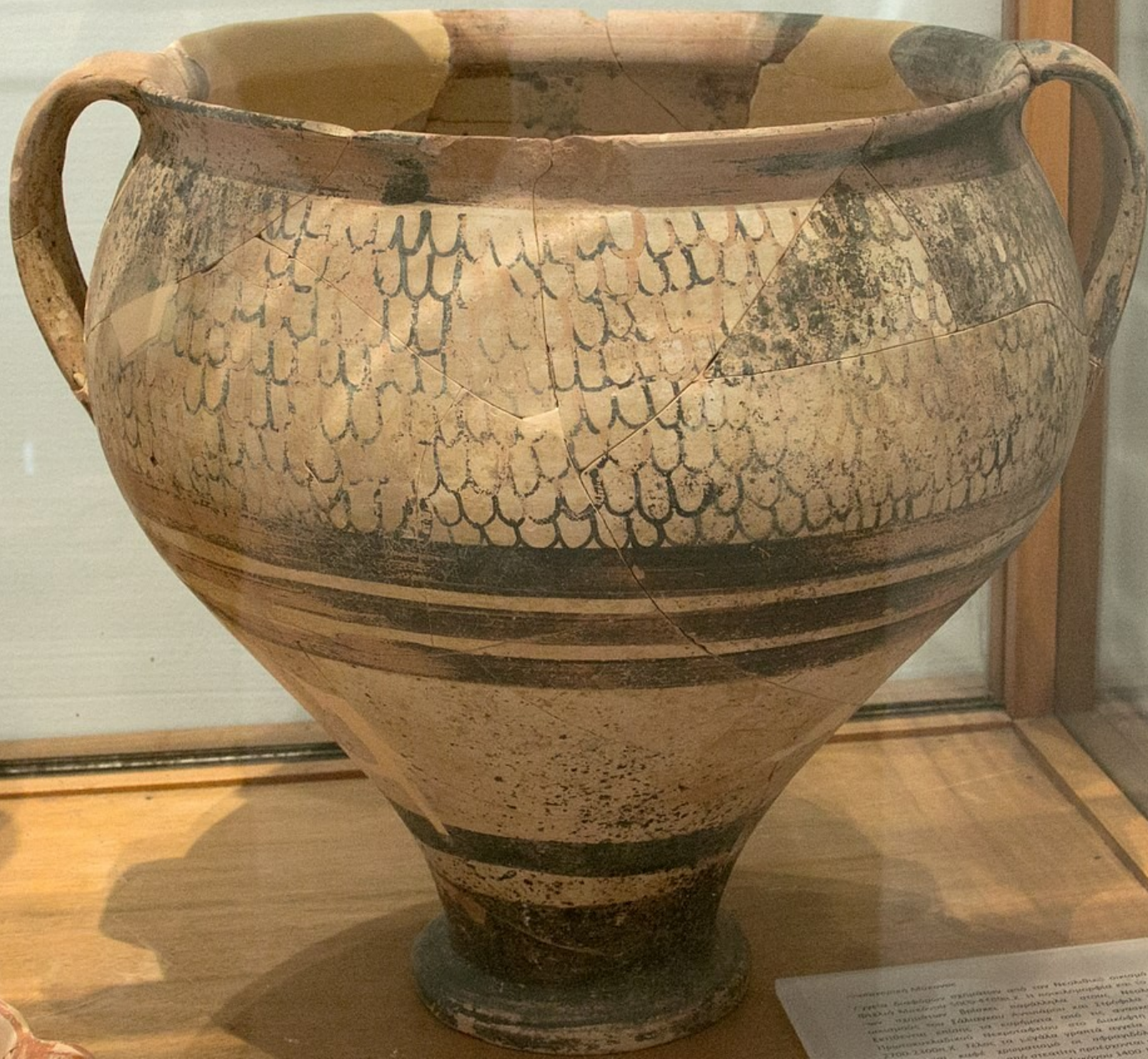

—*reconstruction of the original appearance of the vessel*—
The vessel is a kylix, a type of shallow drinking cup used in ancient Greece. It is decorated with a pattern of dark, overlapping scales, which is characteristic of the style of the Late Archaic period. The vessel is made of reddish-brown clay and has two handles. The scale pattern is a common motif in Greek pottery, often used to represent fish scales or a decorative border. The vessel is shown here with a reconstruction of the original appearance, which would have been more complete and possibly more decorated. The scale pattern is a common motif in Greek pottery, often used to represent fish scales or a decorative border. The vessel is shown here with a reconstruction of the original appearance, which would have been more complete and possibly more decorated.



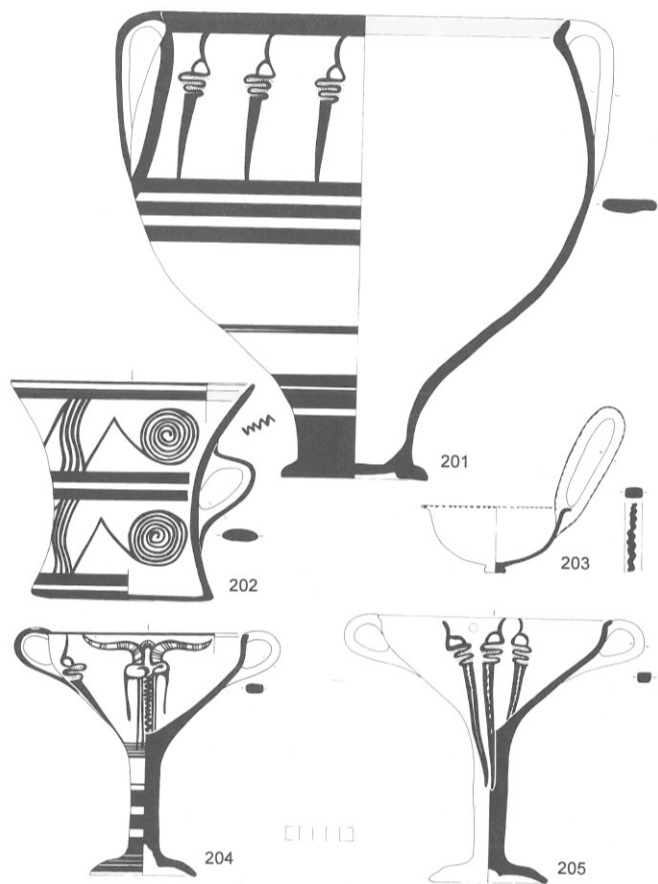

LH III B pottery: 201 stemmed krater: whorl-shell; 202 mug: curve-stemmed spiral; 203 dipper: linear; 204 kylix: whorl-shell with flower; 205 Zygouries kylix: whorl-shell.

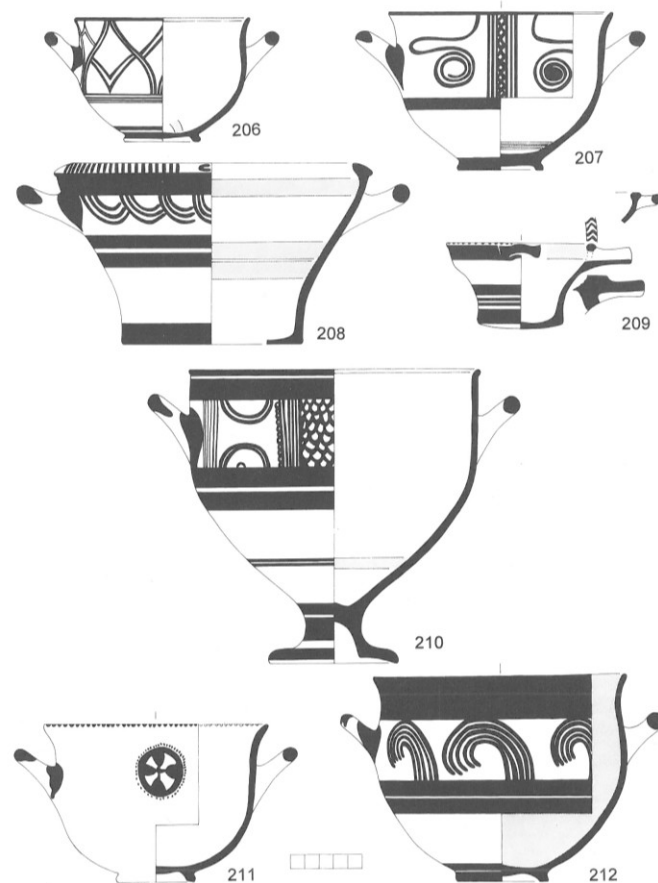

LH III B pottery: 206 deep bowl: tricurved arch; 207 deep bowl: panelled; 208 deep conical bowl: concentric arcs; 209 spouted conical bowl: linear; 210 stemmed bowl: panelled with semi-circles. LH III B2: 211 Rosette deep bowl; 212 Group B deep bowl: multiple stem, hooked.













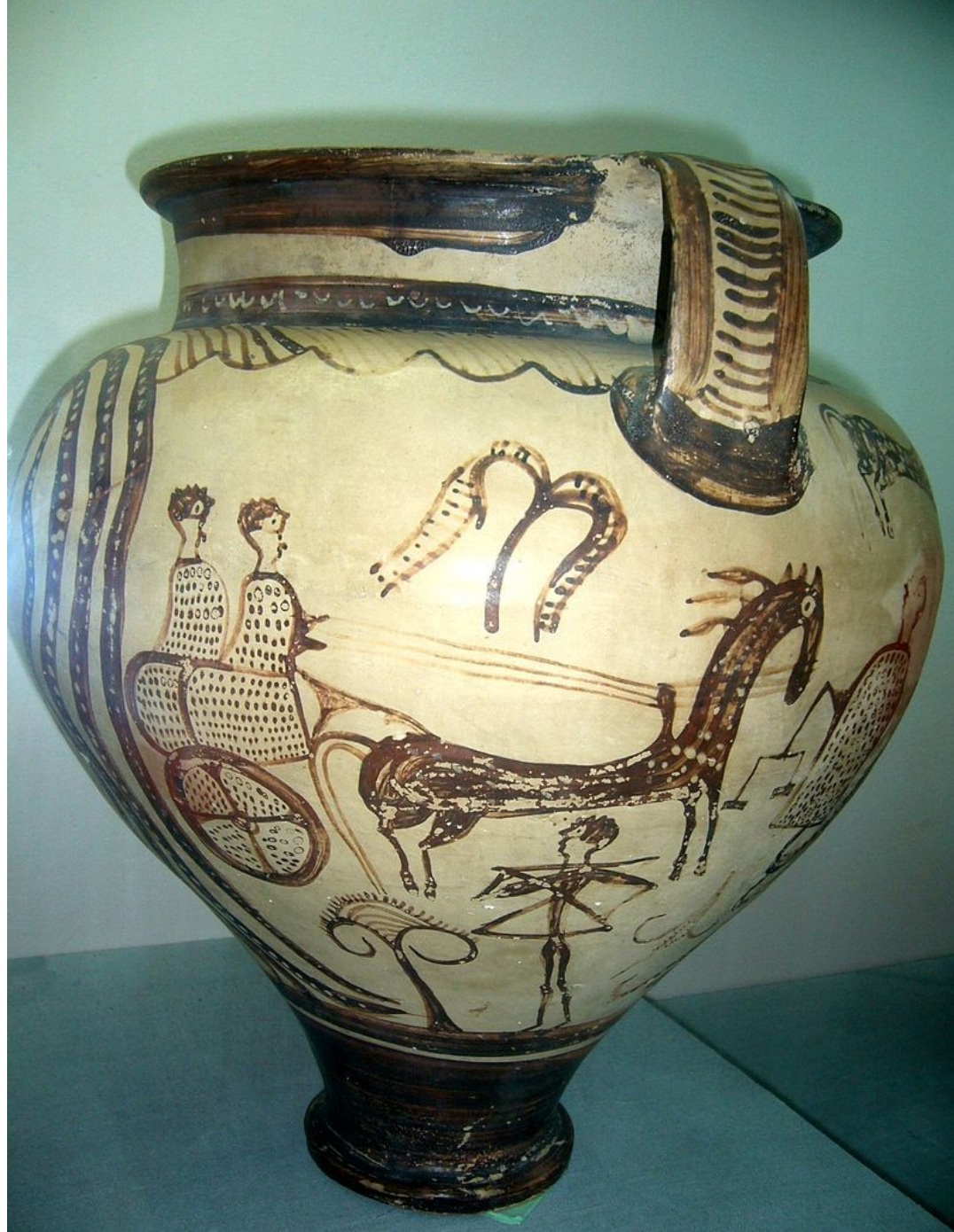





5



6



LH IIIC

The Pottery: LH IIIC Early

93

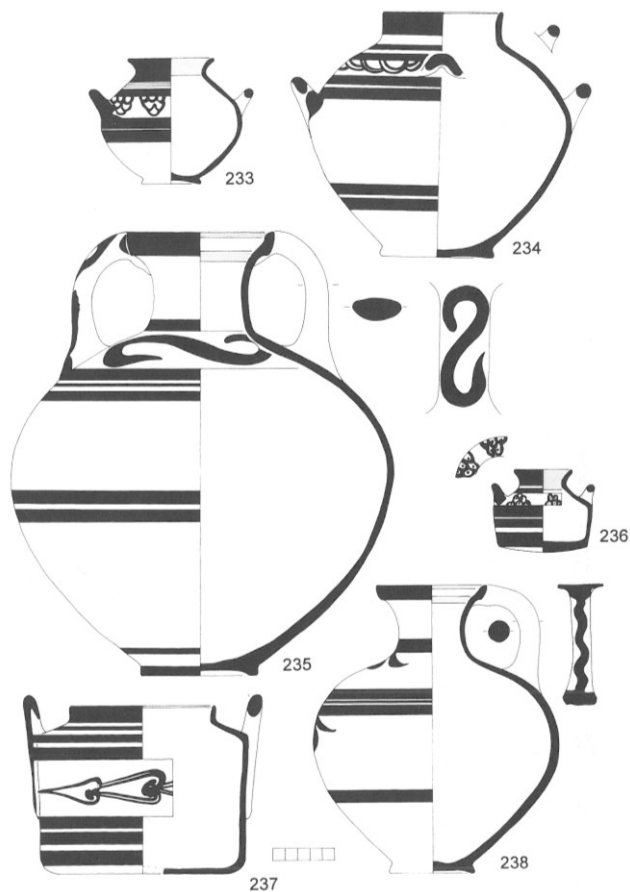

LH IIIC Early pottery: 233 amphoriskos: triangular patch; 234 collar-necked jar: concentric arcs; 235 amphora: scroll; 236 straight-sided alabastron: triangular patch; 237 straight-sided alabastron: ivy chain; 238 jug: tassel.



98
DECORA
Motifs in LH IIIC are especially as rows of entirely of antithetic to and antithetic a row of the antithetic motif. Some elaborate to and belly-b

Close Style
This is a ne decorate the shapes, such they are ear patch (234), adorn the of in each pair patch possi wings are fill and reserve. Asine (287) the floor the Ducked on t

Granary St

The Granary Style is the antithesis of the Close Style. It is a very simple style with few decorative motifs. These consist of wavy lines (292), scroll and tassel. Many vases are linear, the jugs and amphorae sometimes with a large hook painted below the handle (281), and many of the smaller shapes are monochrome, often with one or two reserved lines or with a reserved lower body (295). The style took its name from the vases found on the floor of the East Basement in the Granary at Mycenae.⁷⁰

Pictorial Style

The main centres producing the Pictorial Style were Mycenae, Tiryns, Lefkandi, Volos, Naxos and Kos. It was also produced in Athens and is found sporadically at other sites. The commoner shape on which it appears is the krater, the large decorative field being a good size to accommodate the scenes portrayed. It is also found on the collar-necked jar, straight-sided alabastron and on the



264 LH IIIC Middle collar-necked jar with horses and birds from Mycenae.



265 LH IIIC Middle ring-headed krater with hunting scene from Pylos.



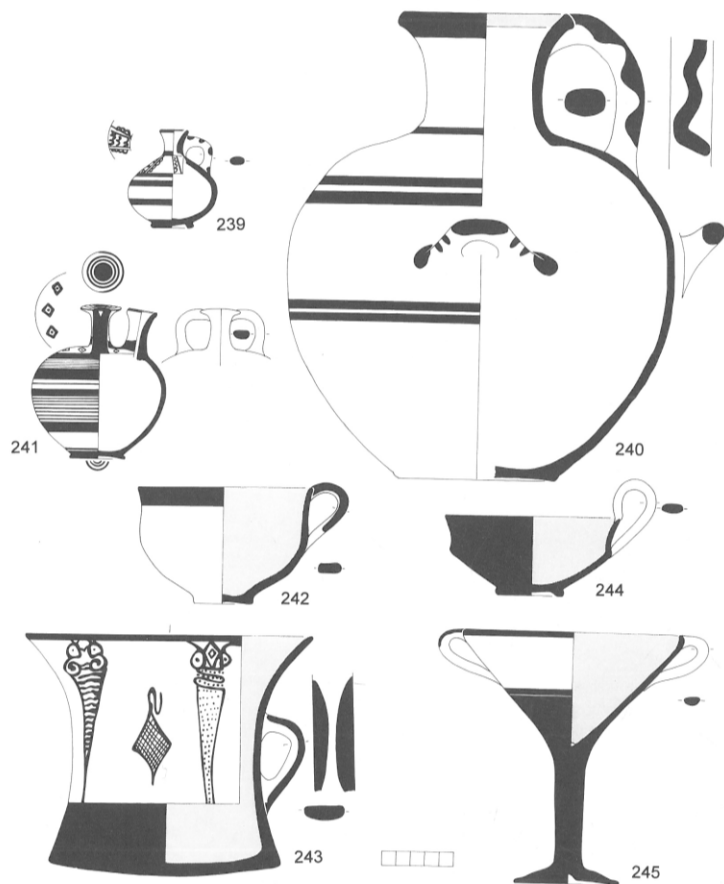

LH IIC Early pottery: 239 lekythos: panelled; 240 hydria: linear; 241 stirrup jar: lozenge; 242 cup: medium band; 243 mug: whorl-shell; 244 carinated cup: monochrome; 245 kylix: linear.

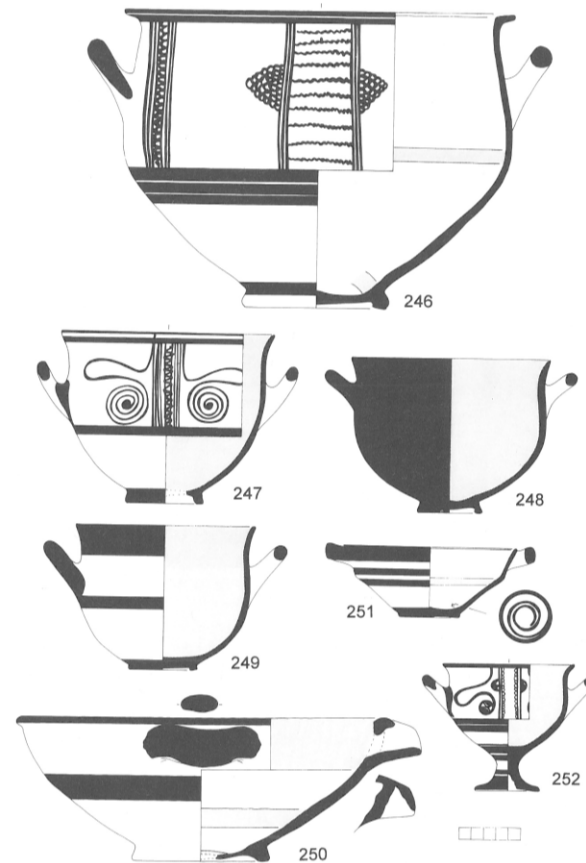

LH IIC Early pottery: 246 ring-based krater: panelled; 247 deep bowl: panelled with antithetic spiral; 248 deep bowl: monochrome; 249 deep bowl: linear; 250 spouted basin: linear; 251 shallow angular bowl: linear; 252 stemmed bowl: panelled with antithetic spiral.





267 LH IIIC Middle stirrup jar: Octopus Style from Rhodes, Ialysos.



268 LH IIIC Middle stirrup jar: Octopus Style from Naxos, Aplomata.



269 LH IIIC Middle stirrup jar: Octopus Style from Kos, Langada.

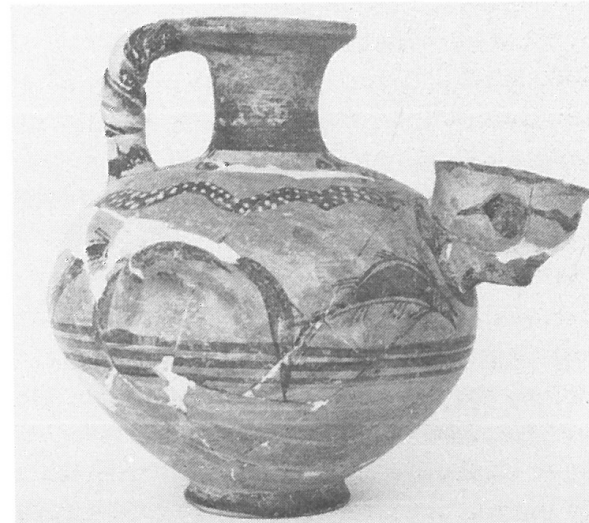

270 LH IIIC Middle strainer jug with snakes from Kos, Langada.





274 LH III C Middle stirrup jar with tree from Kos, Langada.

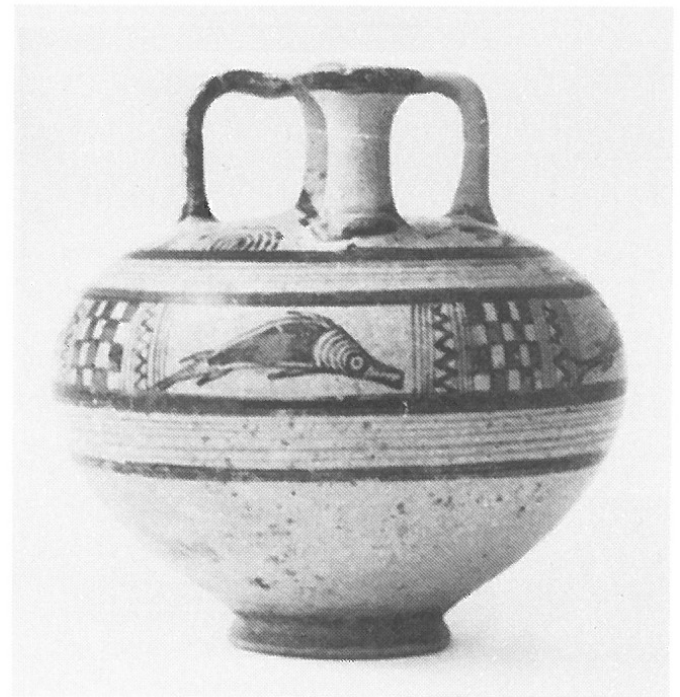

275 LH III C Middle stirrup jar with dot fringed semi-circles on the shoulder and panelled pattern on the belly with birds and fish. From Kos, Langada.



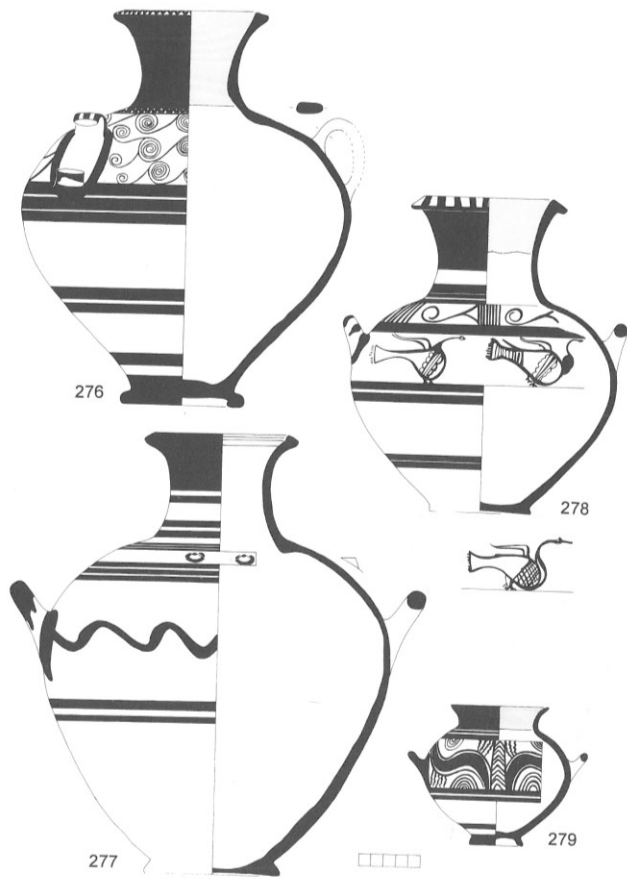

LH IIC Middle pottery: 276 piriform jar: running spiral; 277 belly-handled amphora: wavy line; 278 belly-handled amphora: panelled pattern with stemmed spiral on shoulder, birds on belly; 279 amphoriskos: streamers.

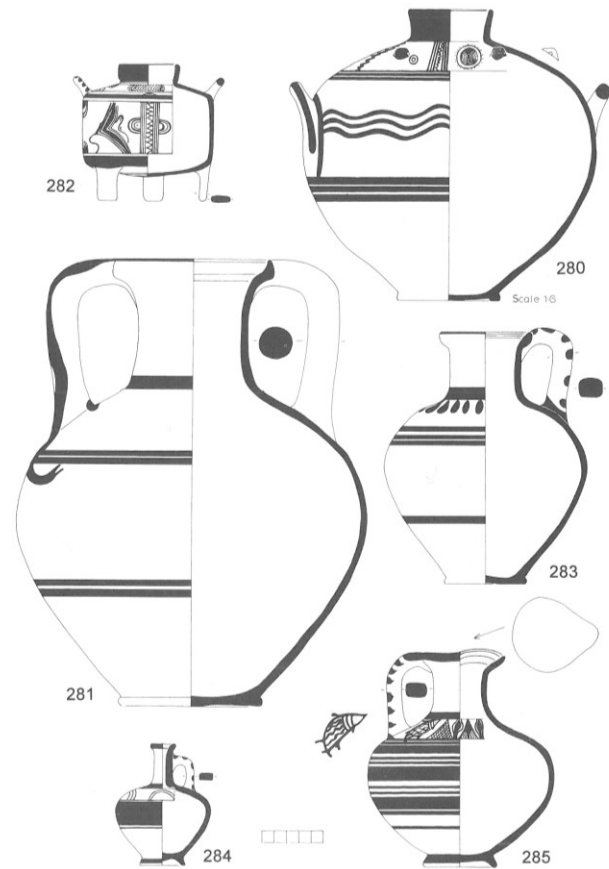

LH IIC Middle pottery: 280 collar-necked jar: panelled pattern on shoulder, triple wavy line on belly; 281 amphora: linear; 282 straight-sided alabastron: panelled pattern with flower; 283 jug: necklaces; 284 lekythos: semi-circles; 285 trefoil-mouthed jug: elaborate triangle with fish by handle.



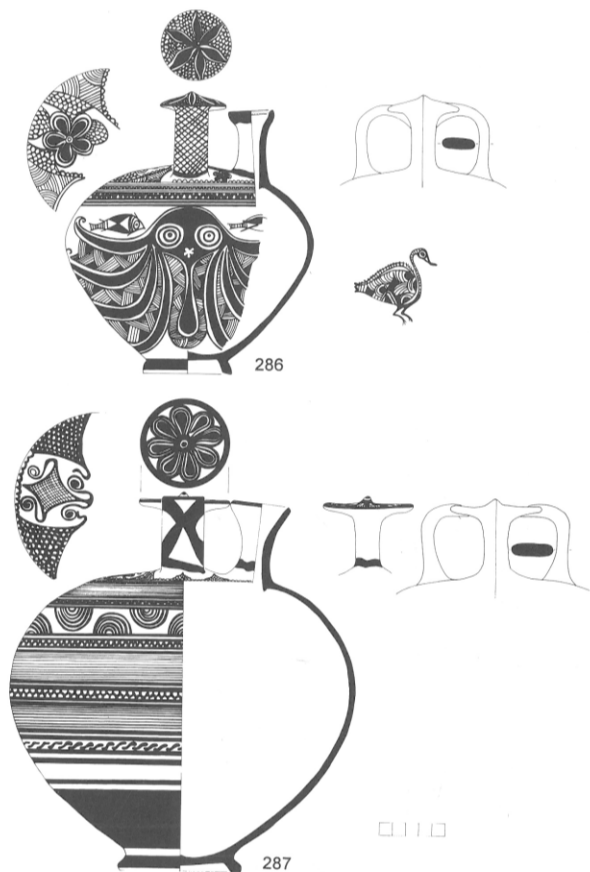

LH IIC Middle pottery: 286 stirrup jar: Octopus Style; 287 stirrup jar: Close Style.

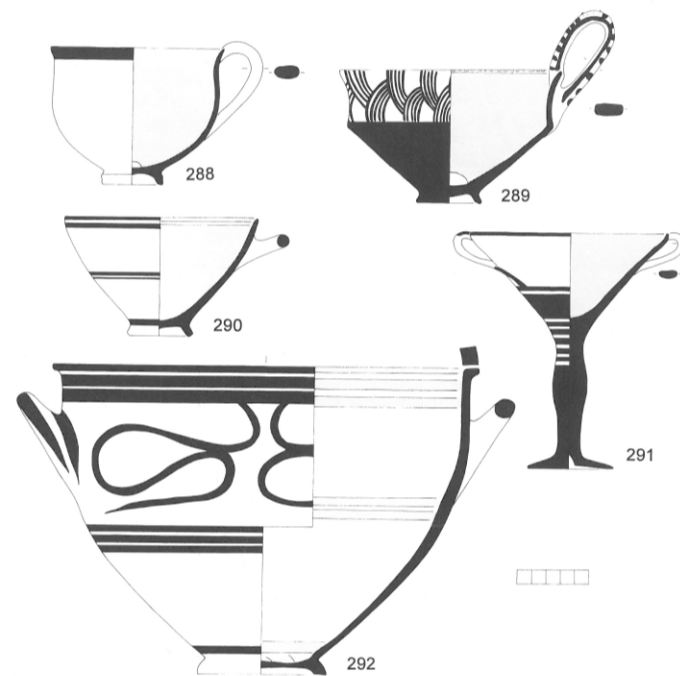

LH IIC Middle pottery: 288 cup: medium band; 289 carinated cup: concentric arcs; 290 one-handed conical bowl: linear; 291 kylix: linear; 292 ring-based krater: antithetic loops.



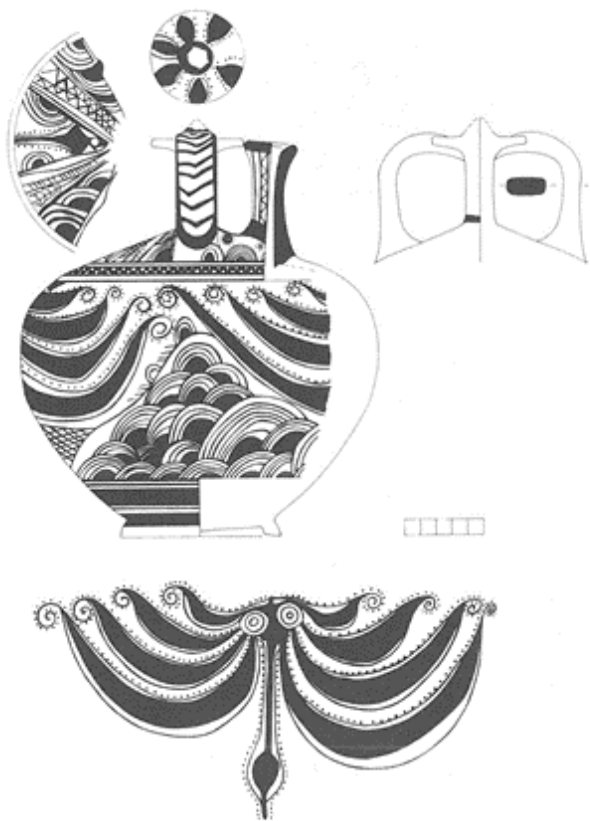

299 LH IIIC Late stirrup jar decorated in Octopus Style from the Dipylon.



300 LH IIIC Late ring-based krater with panellated pattern from Kephallonia, Diakata.

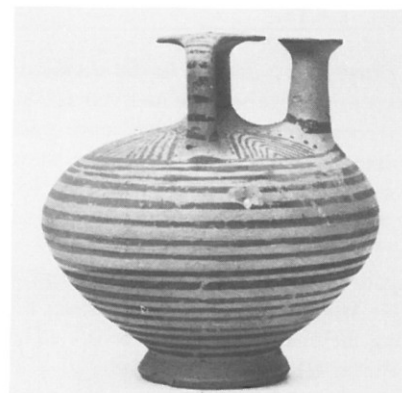

301 LH IIIC Late stirrup jar with dot fringed semi-circles from Kallithea.



302 LH IIIC Late stirrup jar with semi-circles from Klauss.



303 LH IIIC Late four-handled jar with fringed semi-circles from Klauss.





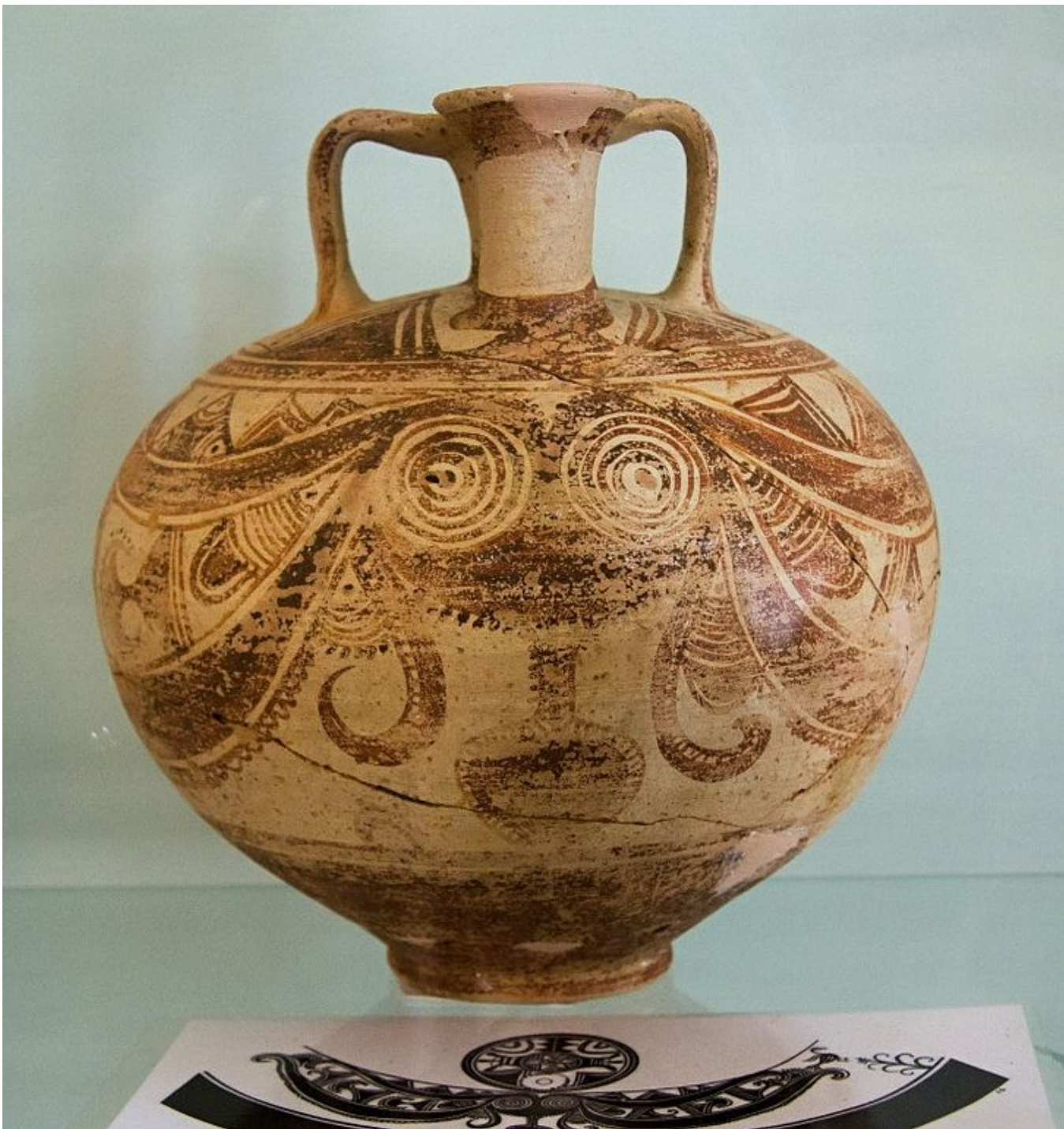







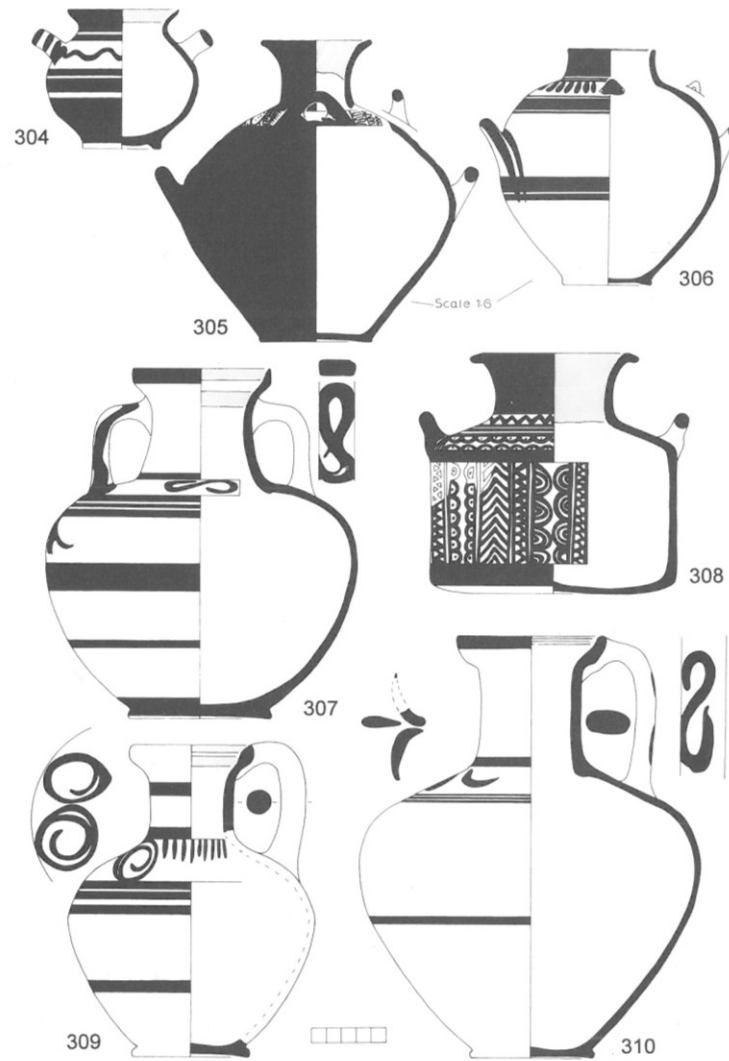

LH IIC Late pottery: **304** amphoriskos: wavy line; **305** four-handled jar: semi-circles and vertical wavy lines; **306** collar-necked jar: necklace; **307** amphora: scroll on shoulder, tassel on belly; **308** straight-sided alabastron: pannelled pattern; **309** jug: stemless spirals and necklace; **310** jug: tassel.



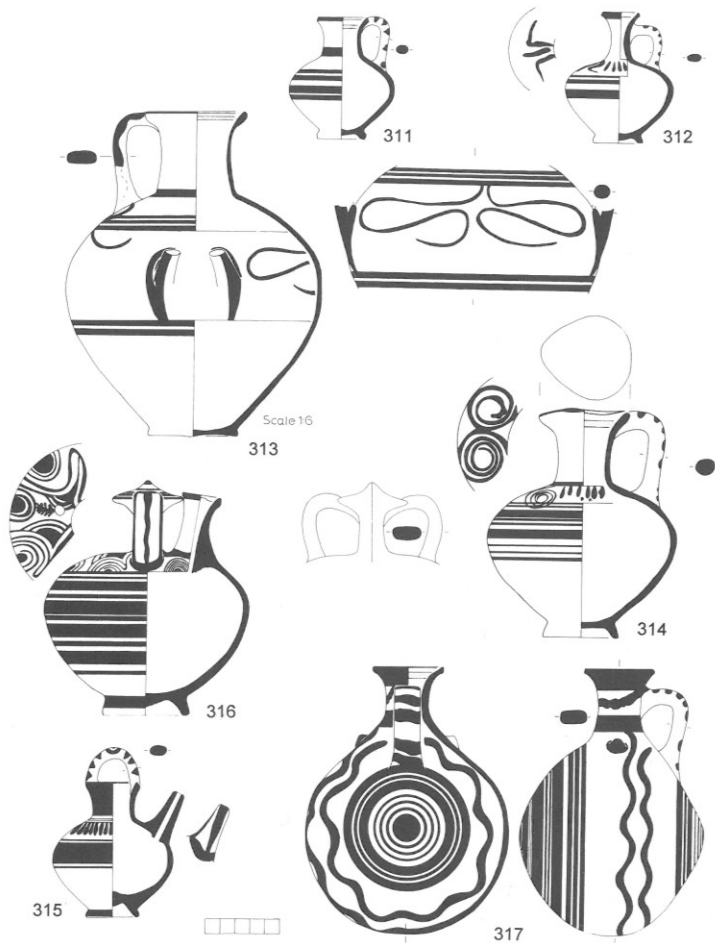

LH IIIC Late pottery: **311** jug: linear; **312** lekythos: tassel with necklace; **313** hydria: antithetic loops; **314** trefoil-mouthed jug: stemless spirals with necklace; **315** feeding bottle: necklace; **316** stirrup jar: bivalve flower with semi-circles; **317** flask: vertical concentric circles with wavy line in side panels.

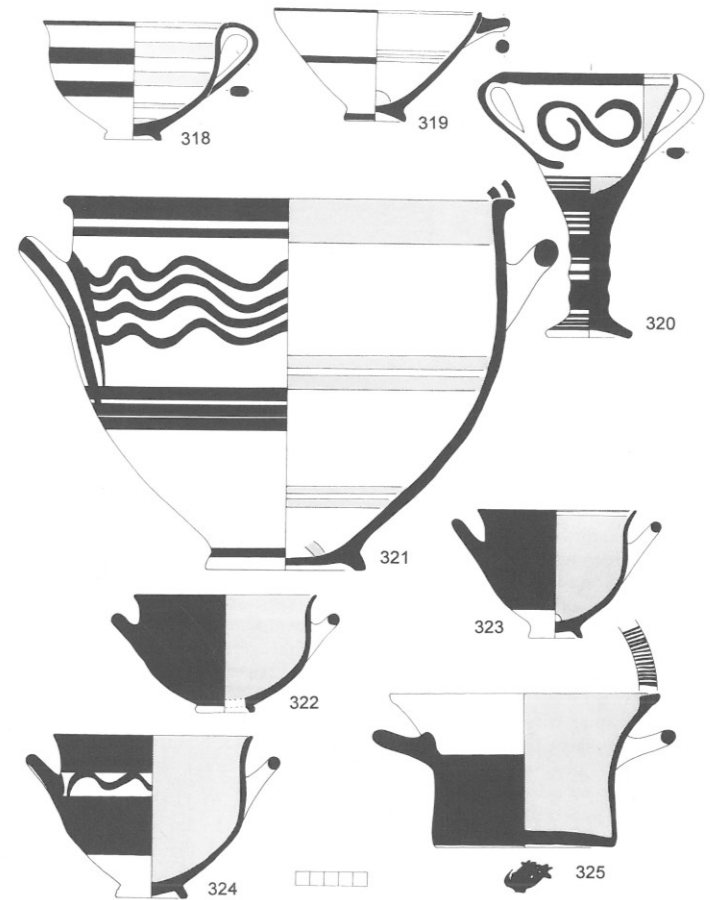

LH IIIC Late pottery: **318** cup: linear; **319** one-handed conical bowl: linear; **320** kylix: scroll; **321** ring-based krater: quadruple wavy line; **322** deep bowl: monochrome; **323** deep bowl: monochrome with reserved lower body; **324** deep bowl: wavy line; **325** kalathos: monochrome with reserved upper body.









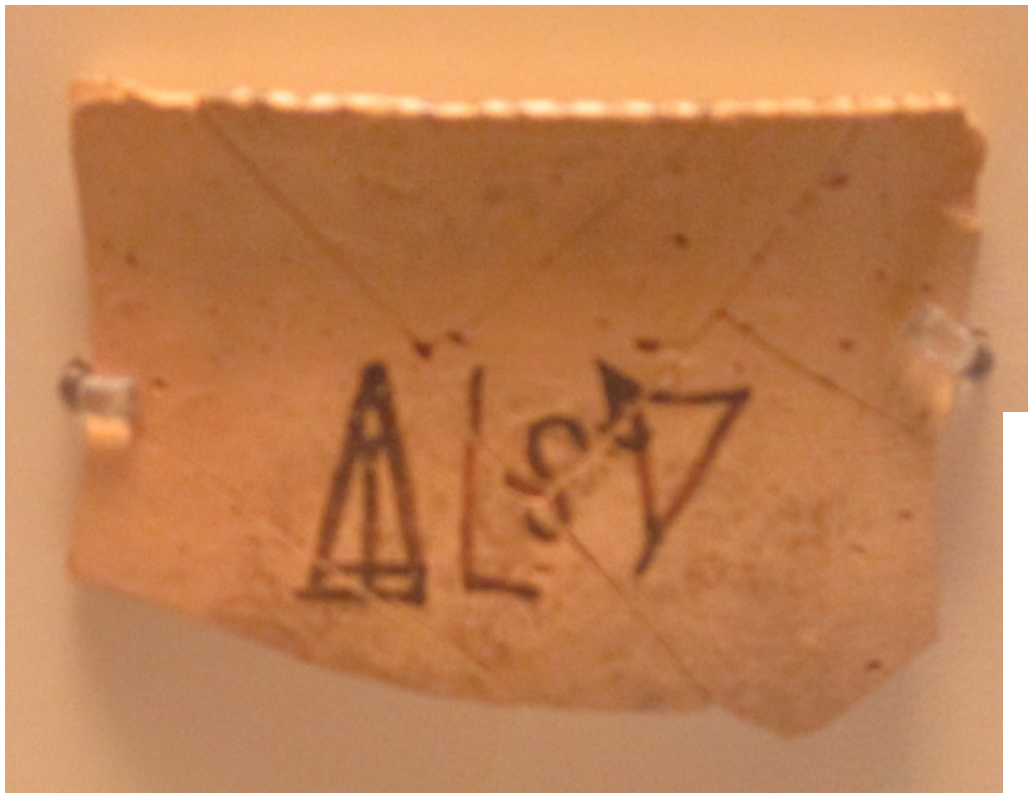

Piriform jar



Ewer



Hydria



Amphora



Stirrup jar



Tripod cooking pot



Cup



Vaphio cup

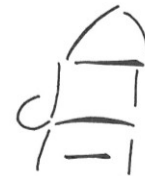

Mag



Dipper



Kylix



Chalice

187 Linear B ideograms referring to vessels.





Submycenaean

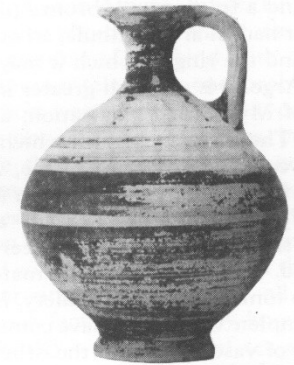
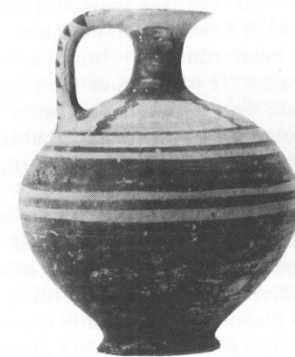
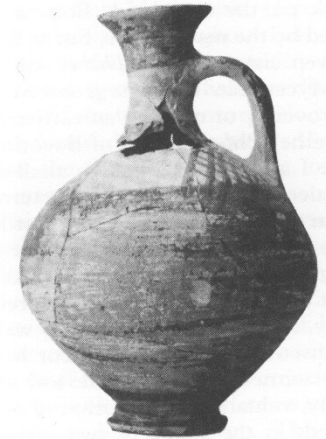

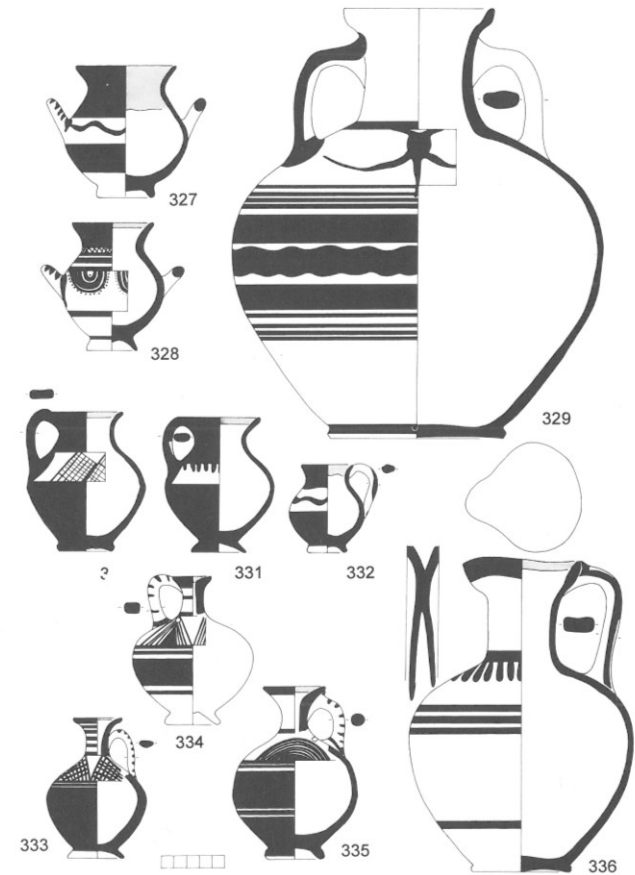

Submycenaean pottery: 327 amphoriskos: wavy line; 328 amphoriskos: dot fringed semi-circles; 329 amphora: tassel on shoulder, wavy line on belly; 330 jug: hatched triangle; 331 jug: necklace; 332 jug: wavy line; 333 lekythos: hatched triangles; 334 lekythos: stacked triangles; 335 lekythos: semi-circles; 336 trefoil-mouthed jug: necklace.









8

9

11

4

10

12

5

6

7

23



Co byste měli vědět o mykénské malované keramice?

- ✓ Kdy se začíná intenzivněji produkovat malovaná keramika?
- ✓ Jaké jsou hlavní stylové skupiny středohelladské keramiky?
- ✓ Co je charakteristické pro mykénskou keramiku stupňů LH I – IIA?
- ✓ Co je to piktorální styl?
- ✓ Jak vypadají mykénské kratéry z Kypru?
- ✓ Jak se vyvíjí mykénský pohár a třmínková váza?



Příště:

Geometrické období

