

Experimental biology

Description > Manipulation > Understanding

Money > Applications > Publishing

- Anatomy
- Physiology (spray and pray)
- Chemistry (identification of signals)
- Biochemistry (protein isolation/structure)
- Genetics (genes/mutants)
- Cell biology (subcellular structures)
- Molecular biology (gene manipulation)

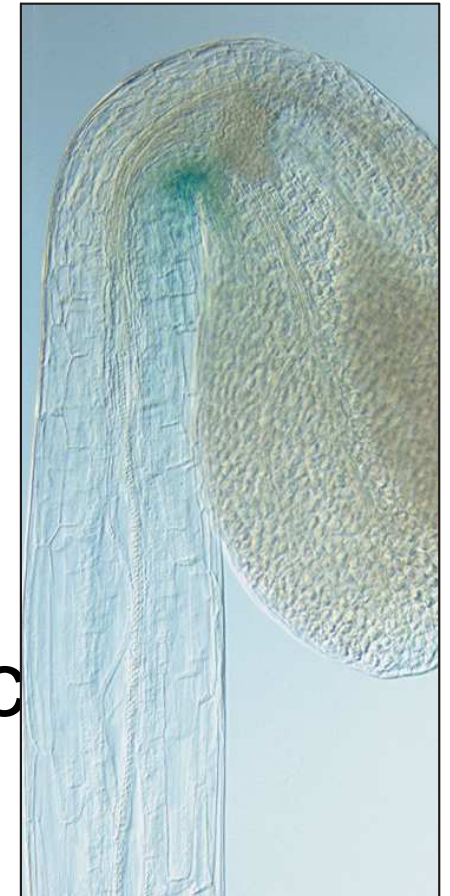

Choice of research topic?

- Gene/Gene family
- Biological process
- Signaling pathway
- Model system
- Available methods
- „Trendy topic“
- Serendipity

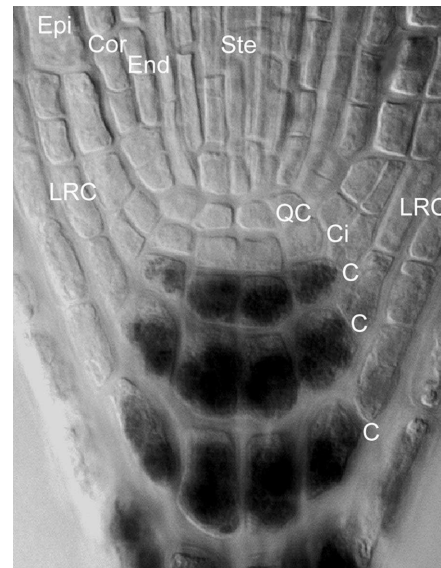
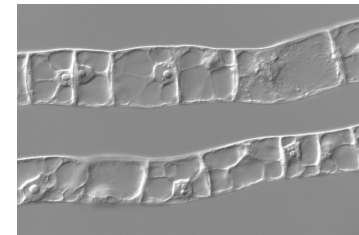
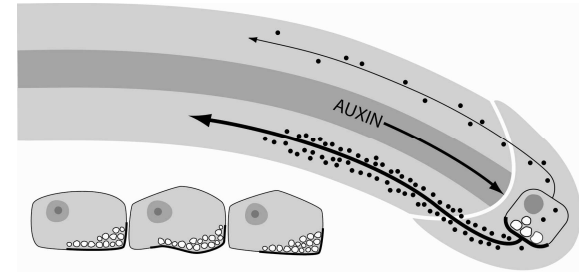

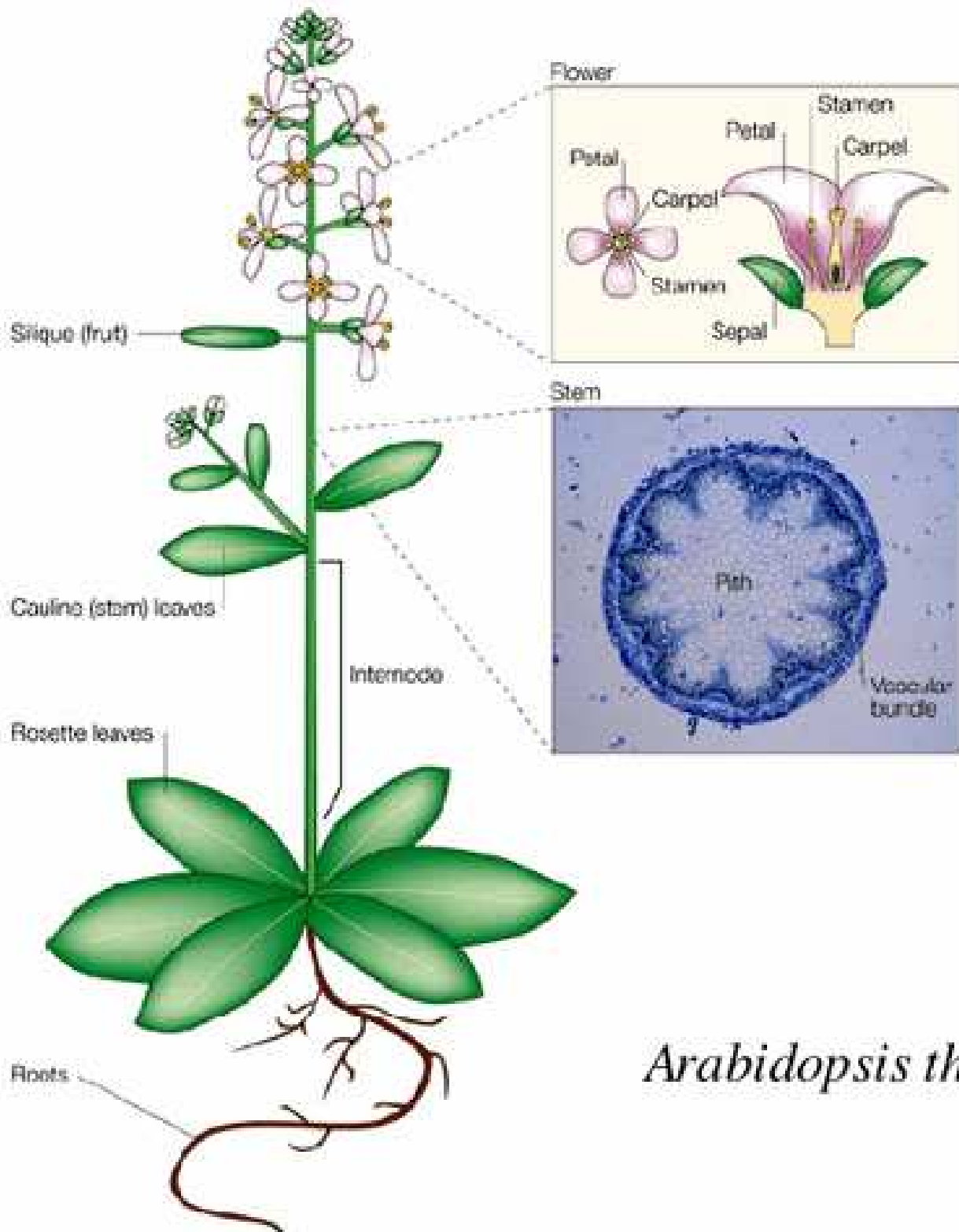

Arabidopsis thaliana

Arabidopsis thaliana

- Small, fully sequenced genome
- Easy genetics (diploid/self-pollinator)
- Short vegetation time
- No large space requirement
- Simple organ and tissue structure
- Many established tools and facilities
(transformation, libraries, databases)

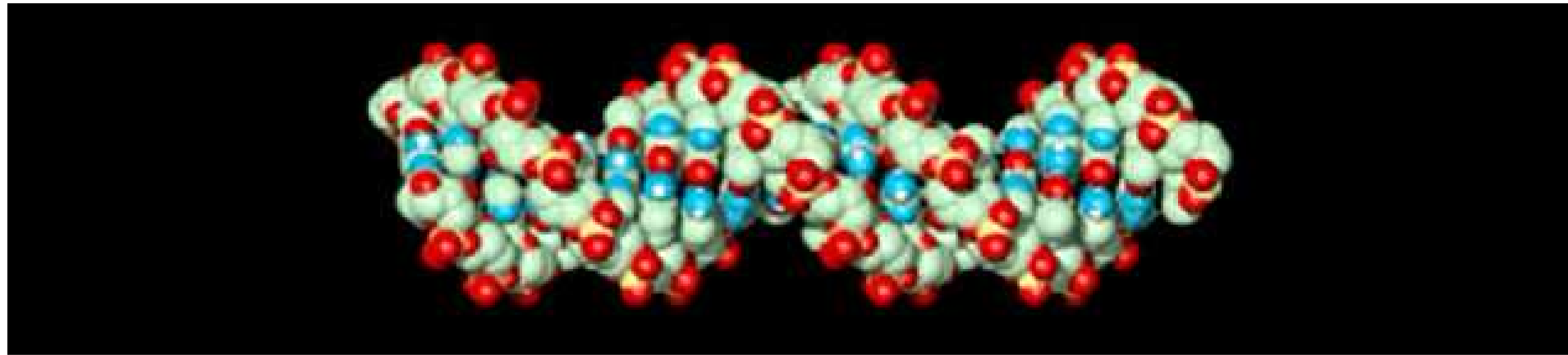
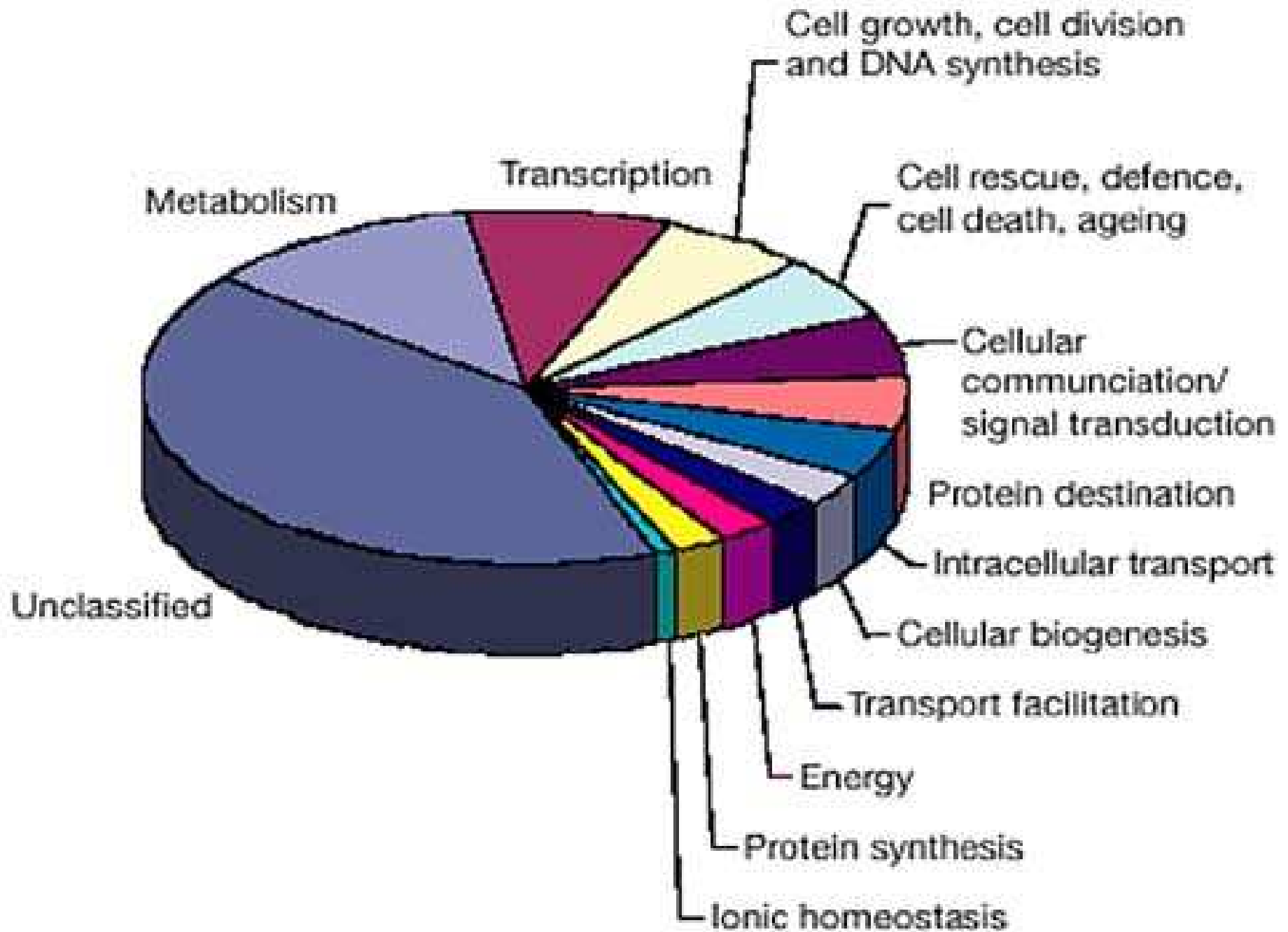

Table 4 General features of genes encoded by the three genomes in *Arabidopsis*

	Nucleus/cytoplasm	Plastid	Mitochondria
Genome size	125 Mb	154 kb	367 kb
Genome equivalent/cell	2	560	26
Duplication	60%	17%	10%
Number of protein genes	25,498	79	58
Gene order	Variable, but syntenic	Conserved	Variable
Density (kb per protein gene)	4.5	1.2	6.25
Average coding length	1,900 nt	900 nt	860 nt
Genes with introns	79%	18.4%	12%
Genes/pseudogenes	1/0.03	1/0	1/0.2–0.5
Transposons (% of total genome size)	14%	0%	4%



transcription factors



gene products

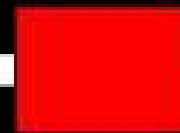
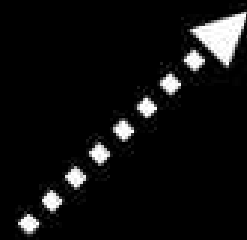

promoter

coding region

terminator

Control of gene activity

How to get your favorite gene?

- “Monte Carlo” candidate gene approach
- Functional complementation
- From the protein back to the gene
- Expression
- Forward genetics

“Monte Carlo”

- Homology to known factors
(trimeric G-proteins)
- Interesting domains
(kinases, phosphatases)
- „Other“ reasons
(serendipity)

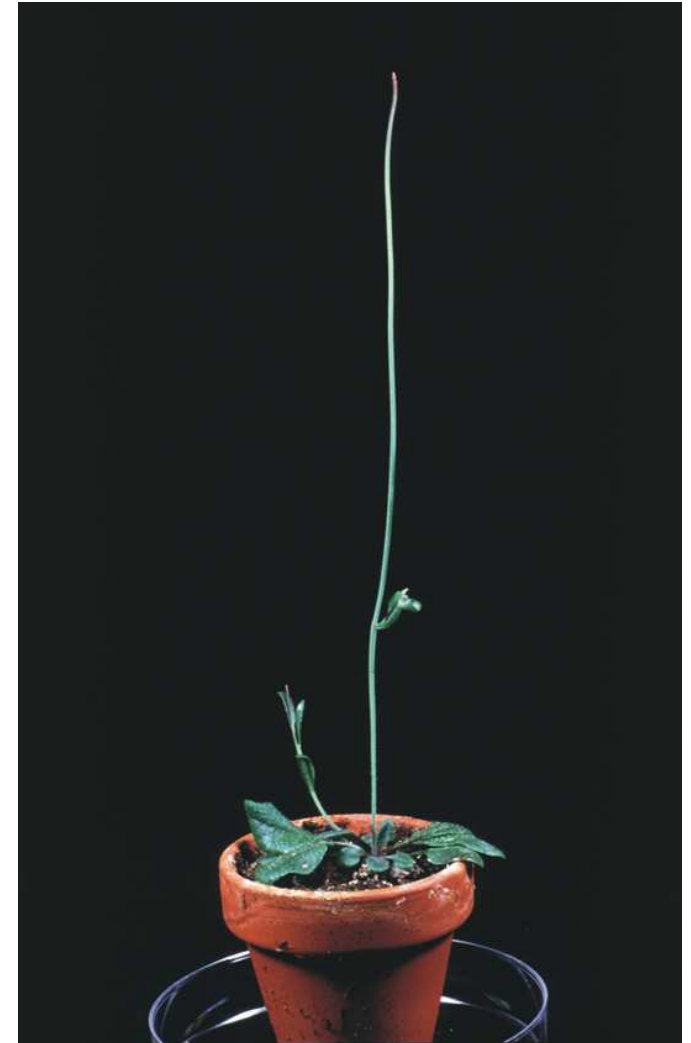

Functional complementation

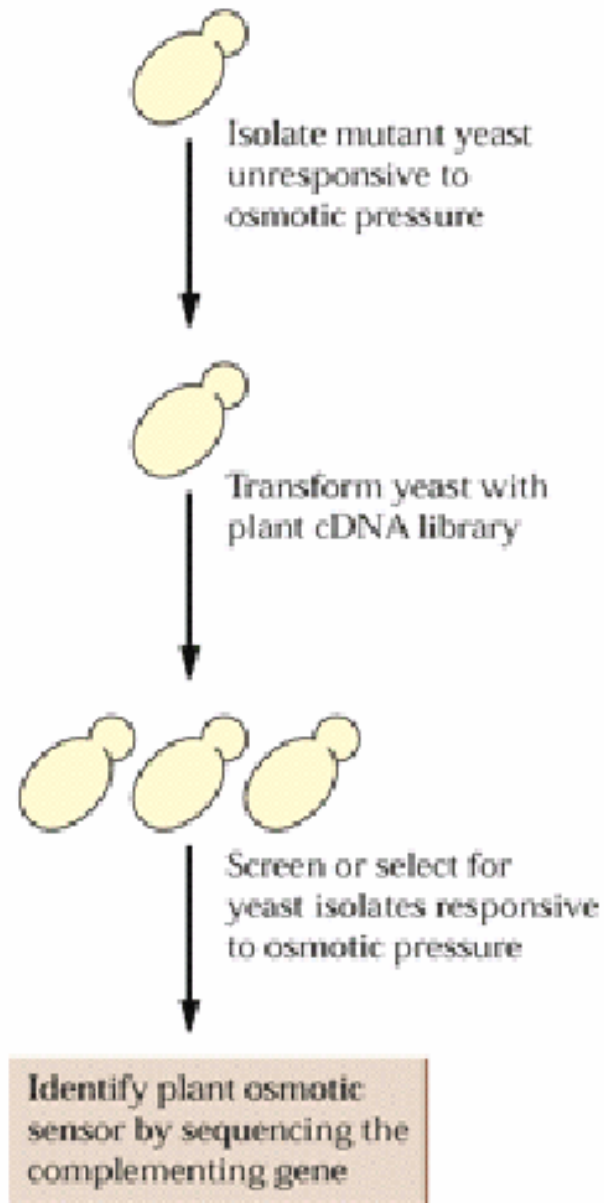

Protein > gene

- Ligand binding (affinity chromatography, azidolabeling; ABP1, NPB, Zm-p60)
- Enzyme activity (CKX, NOS)
- Complex members
- Proteomics approaches (phosphoproteomics, differential display)
 - Microsequencing
 - Blast search:
amino acid > nucleotide
 - Search for a gene

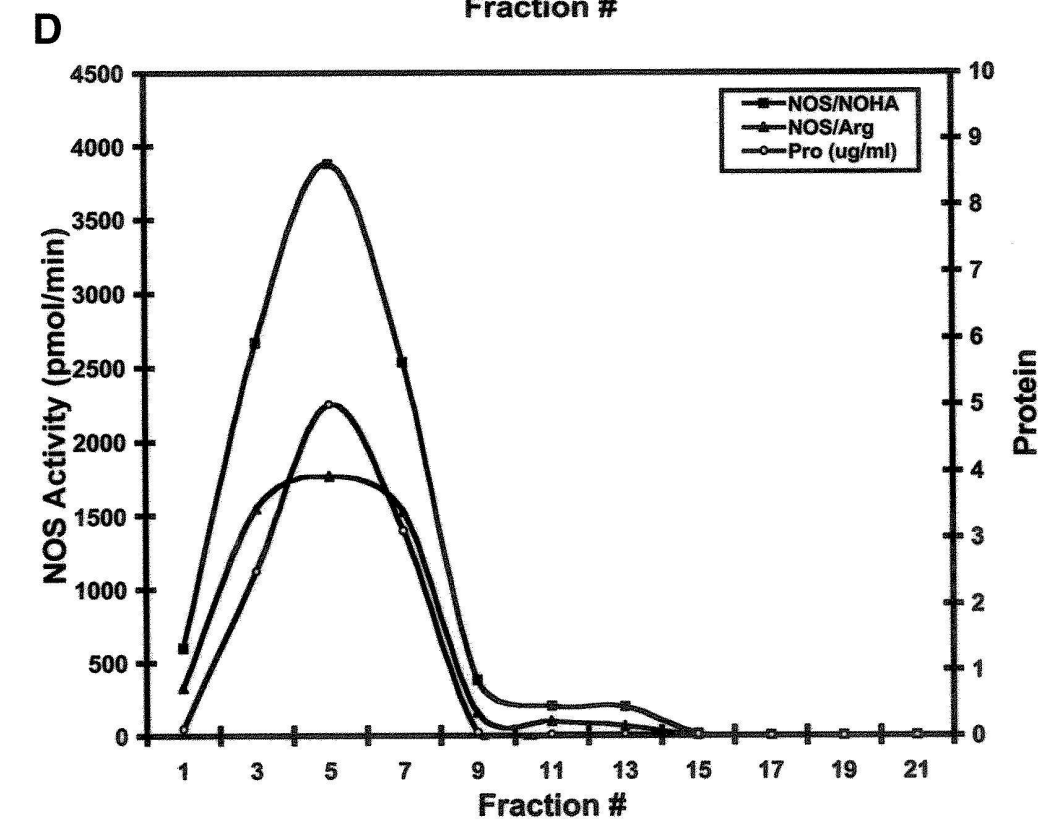
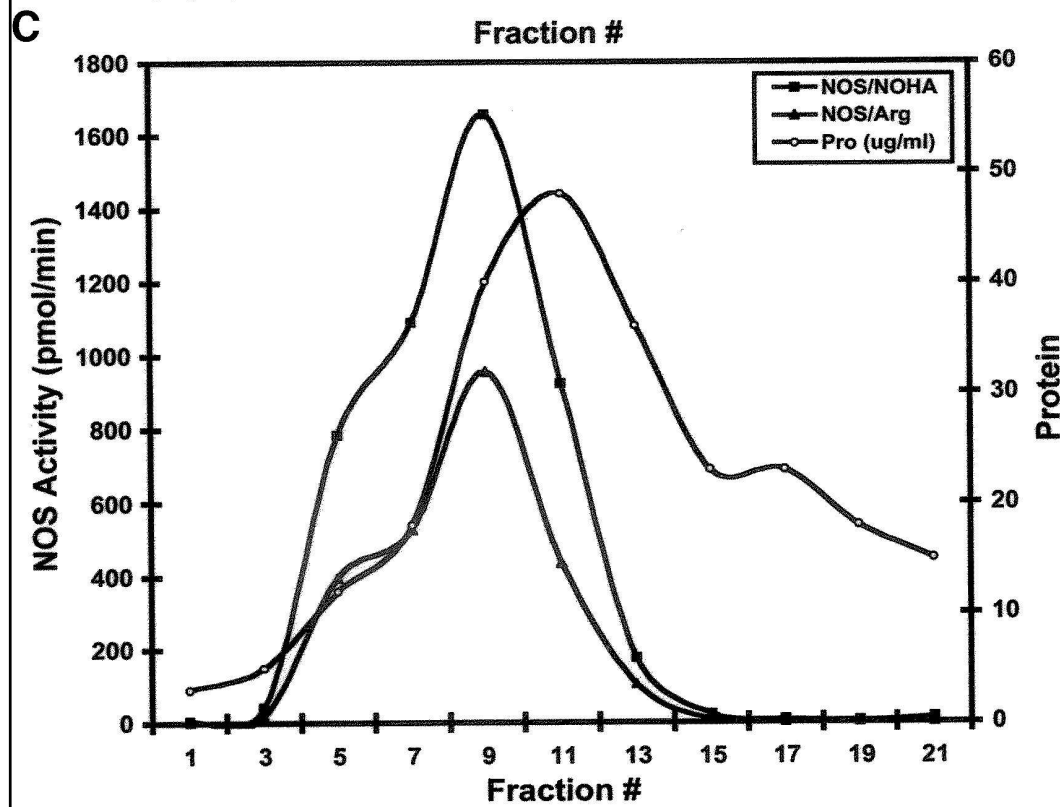
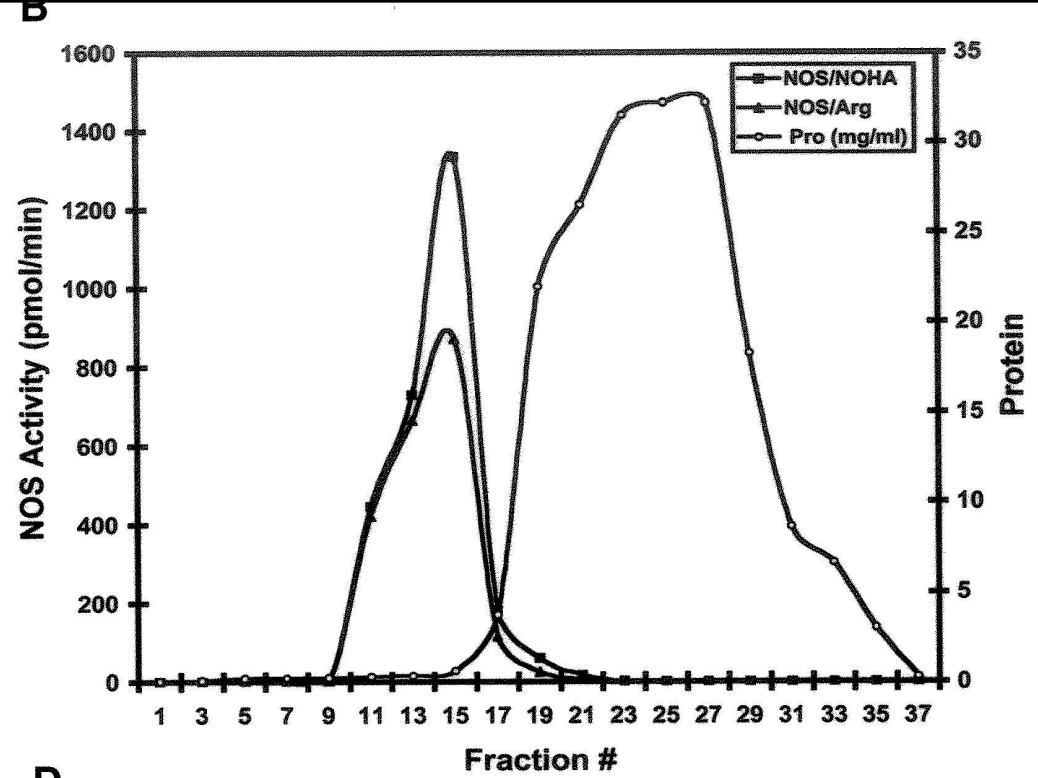
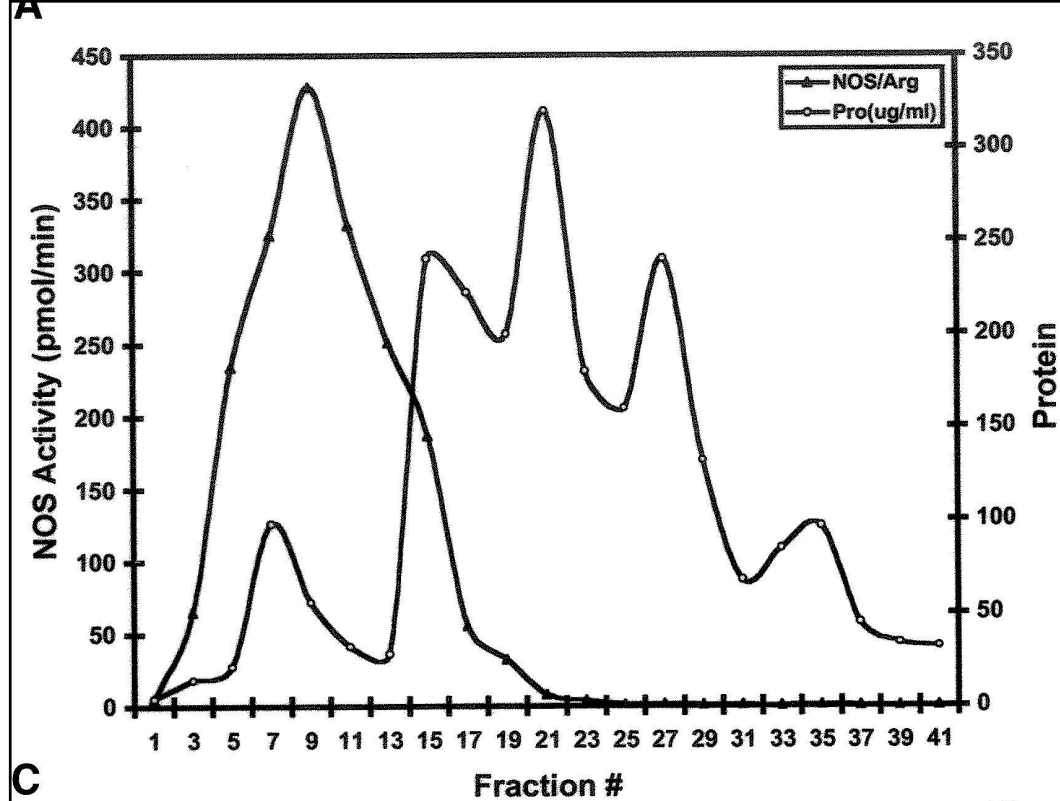

Expression pattern

- Enhancer/Gene-trap libraries
- Differential display
subtractive hybridisation
microarray

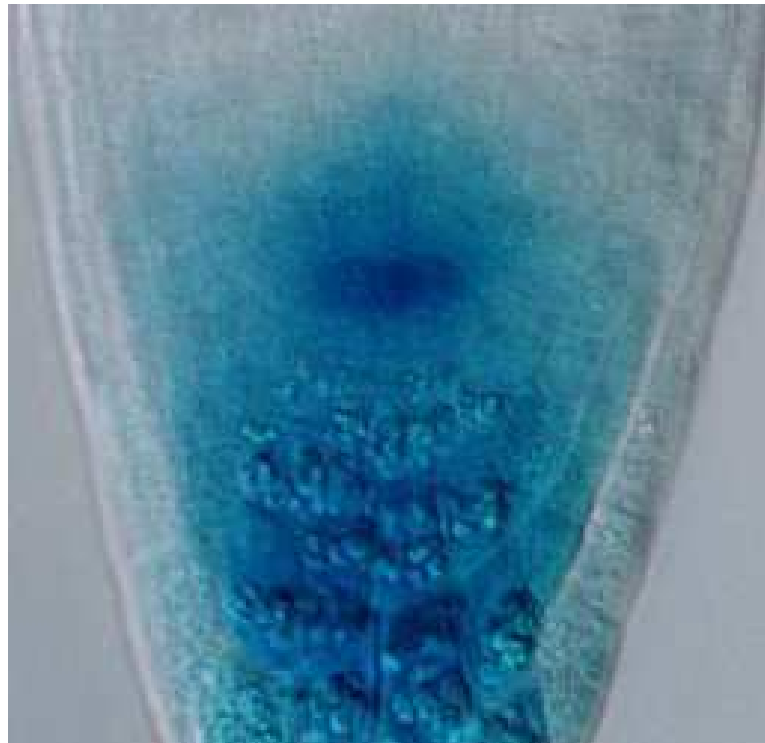

Gene and enhancer trap libraries

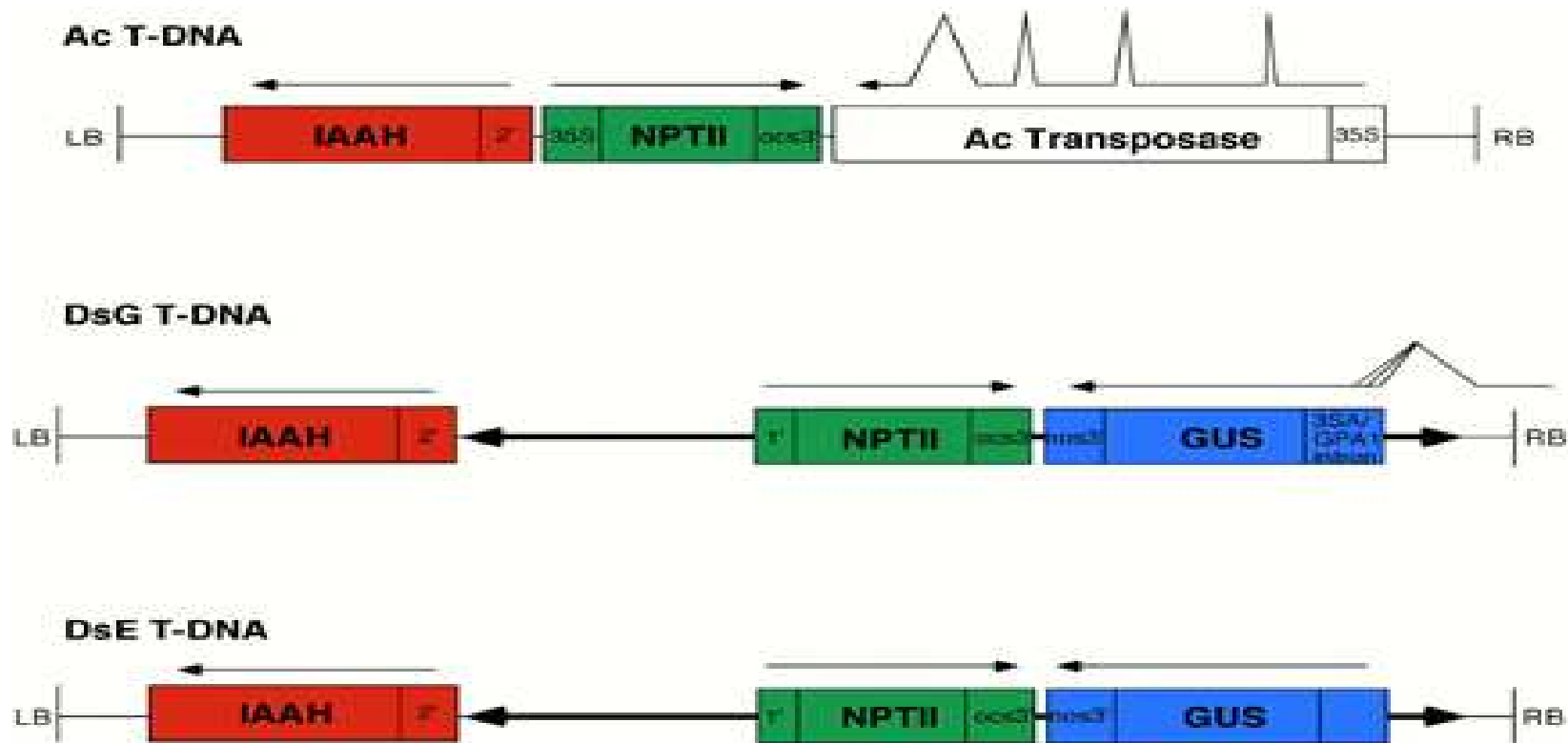

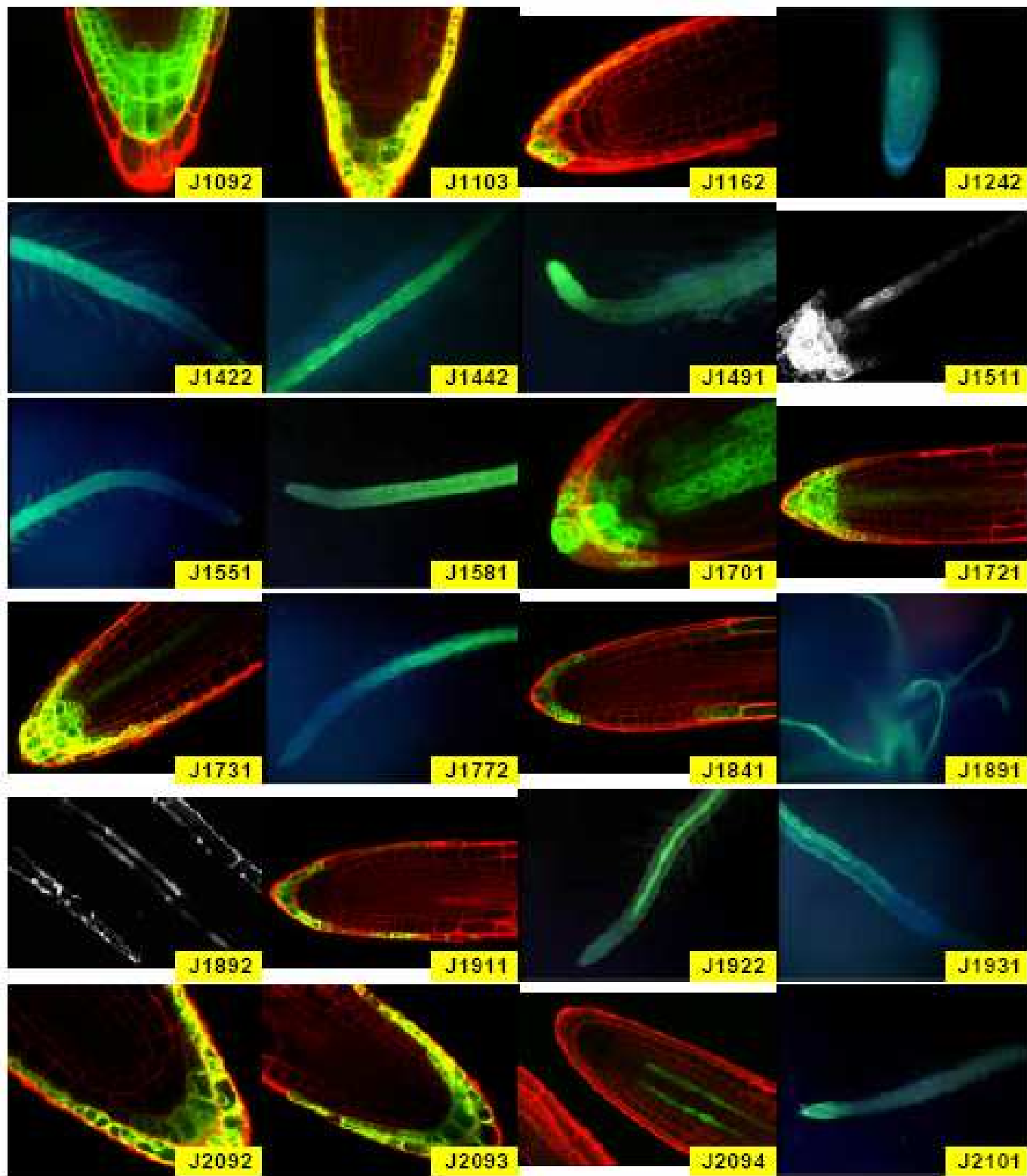

Microarray

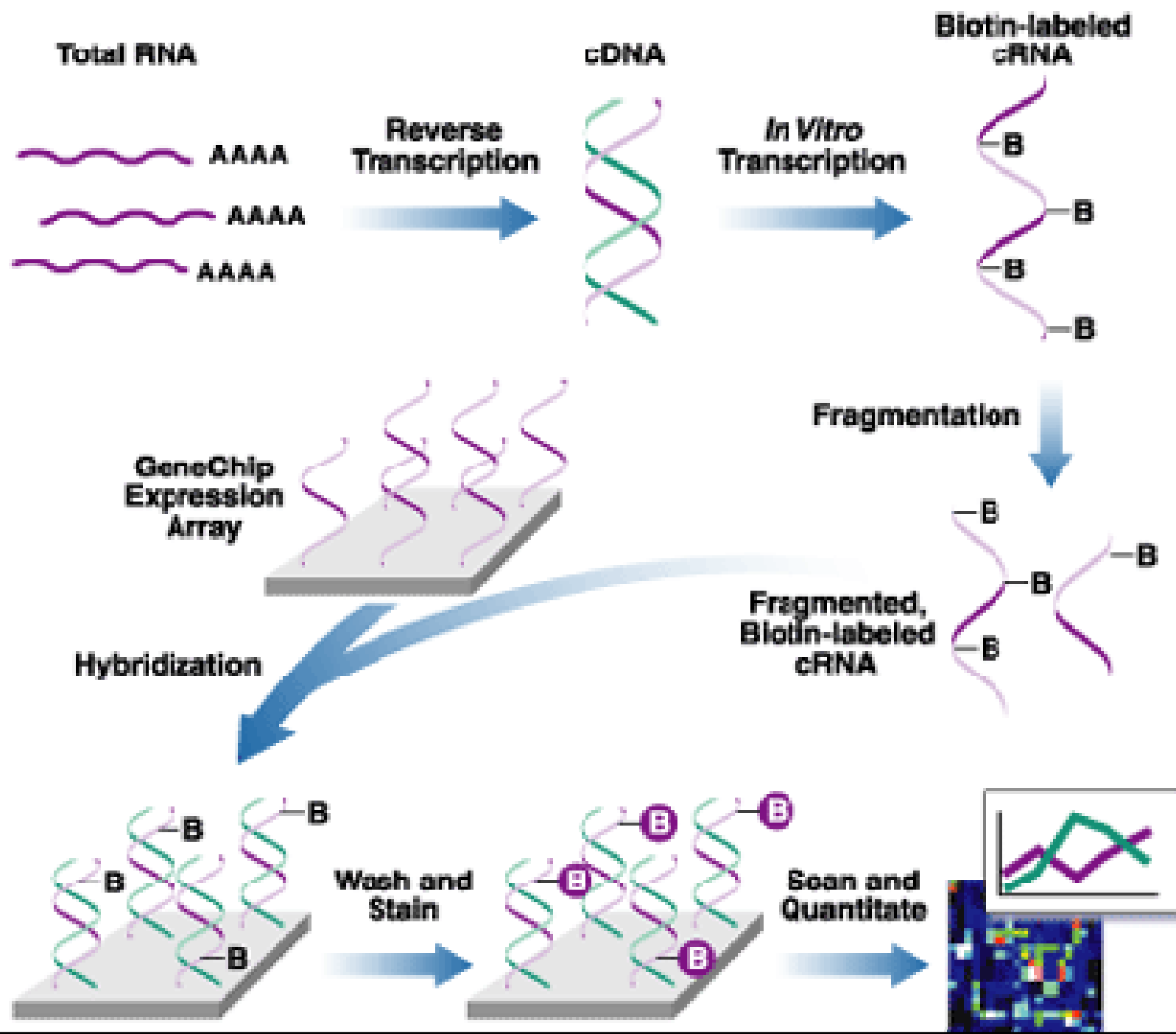

Expression map of Arabidopsis root

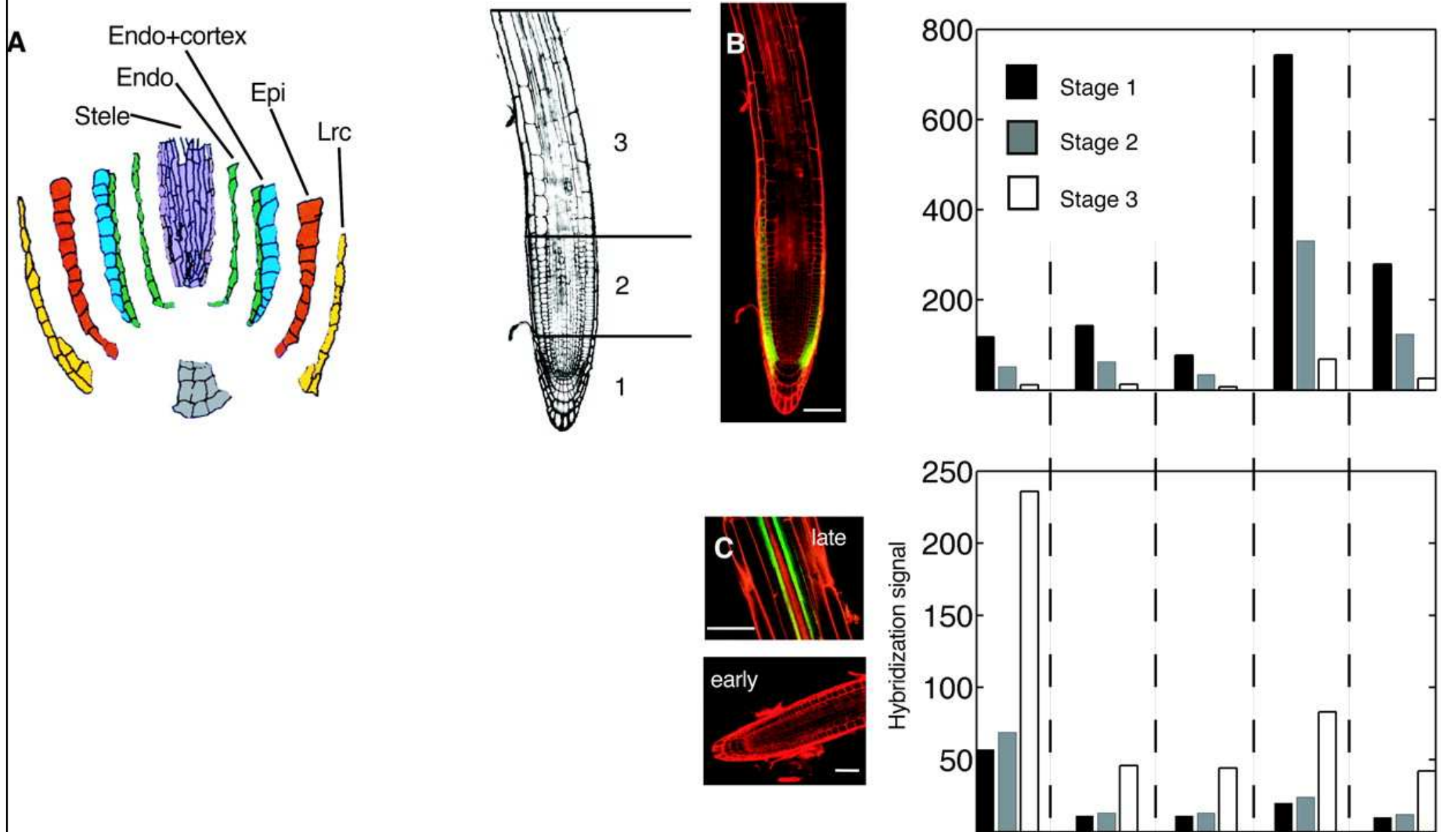

Forward genetics

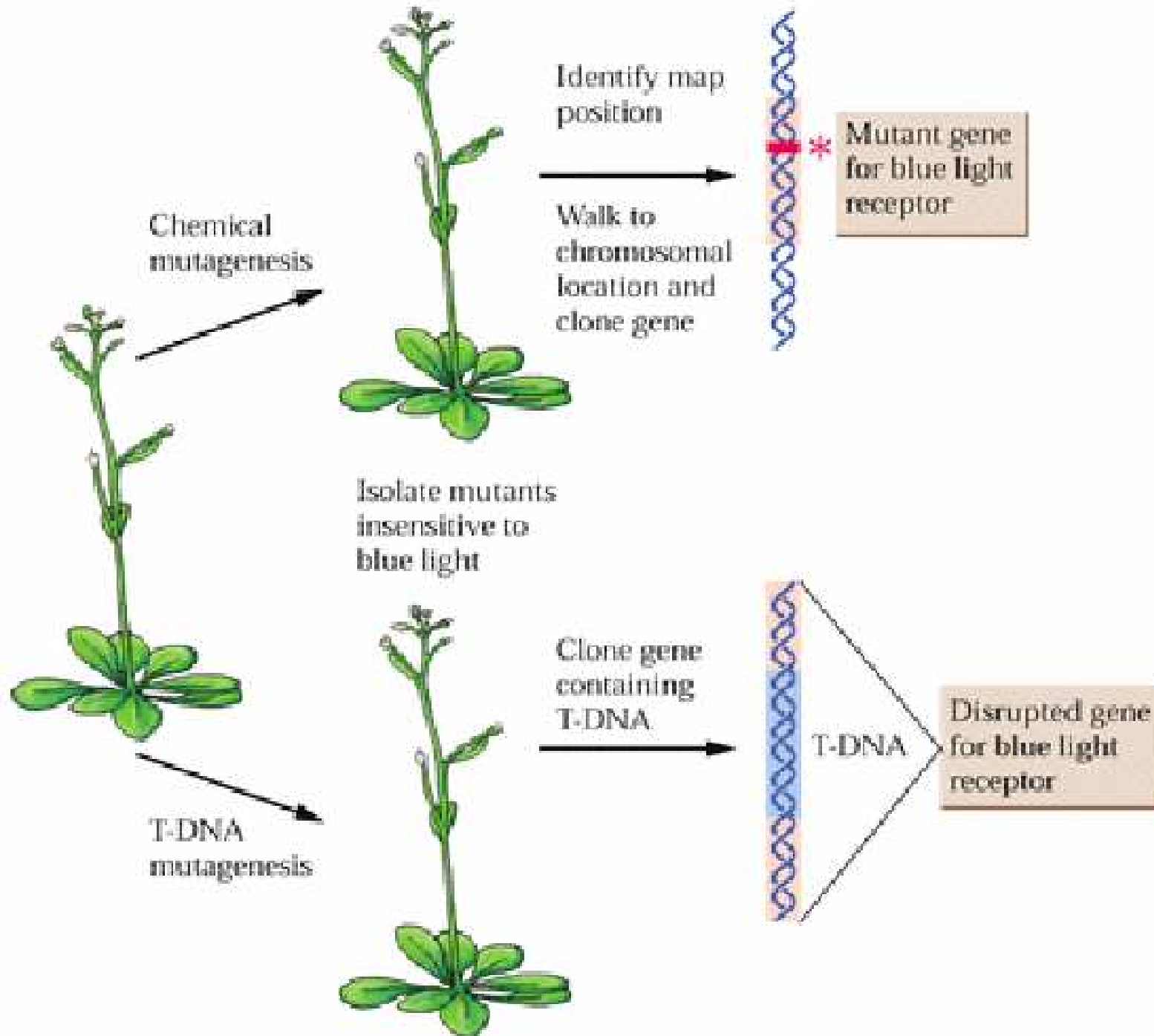

EMS mutagenesis

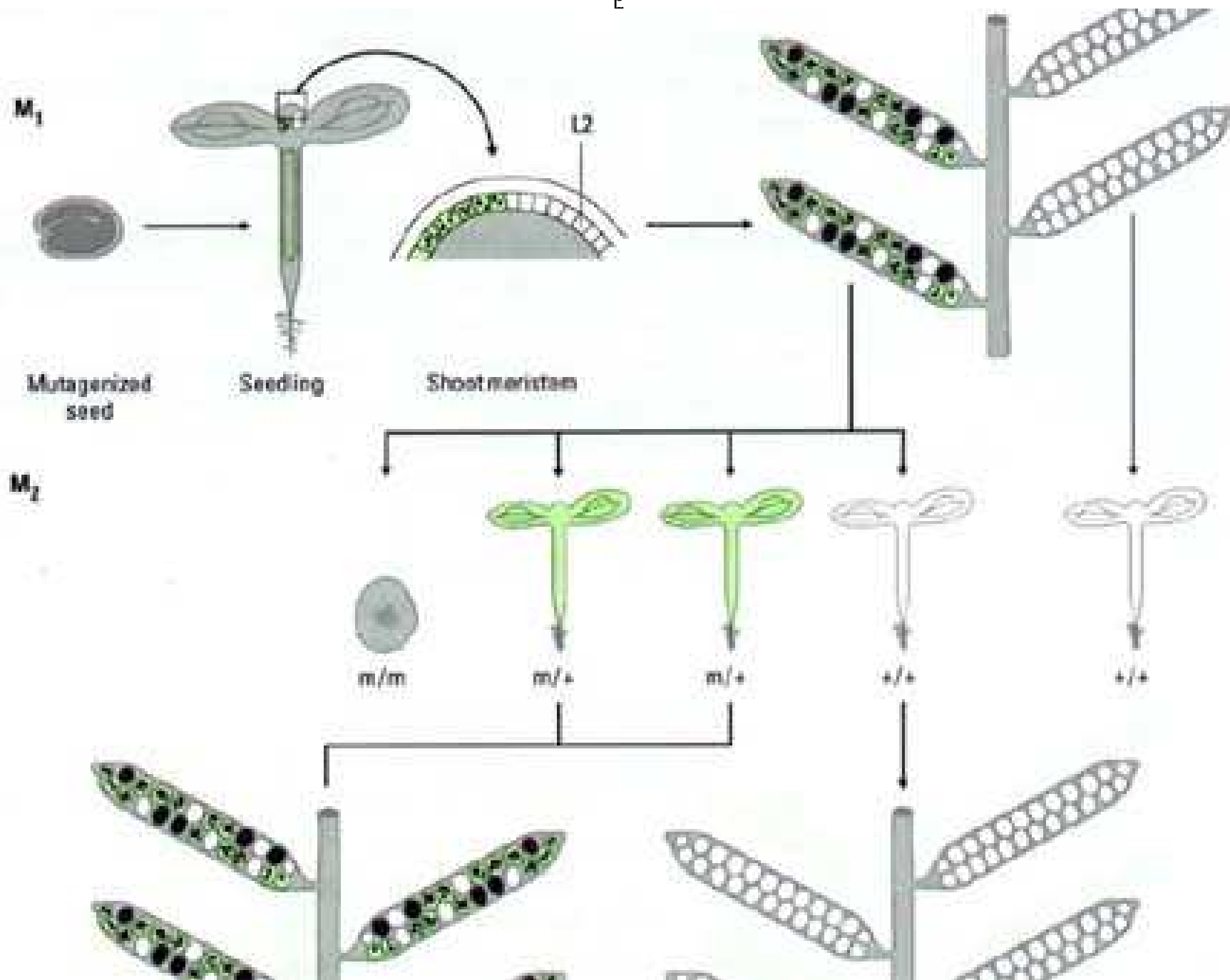

Mutant screen at seedling level

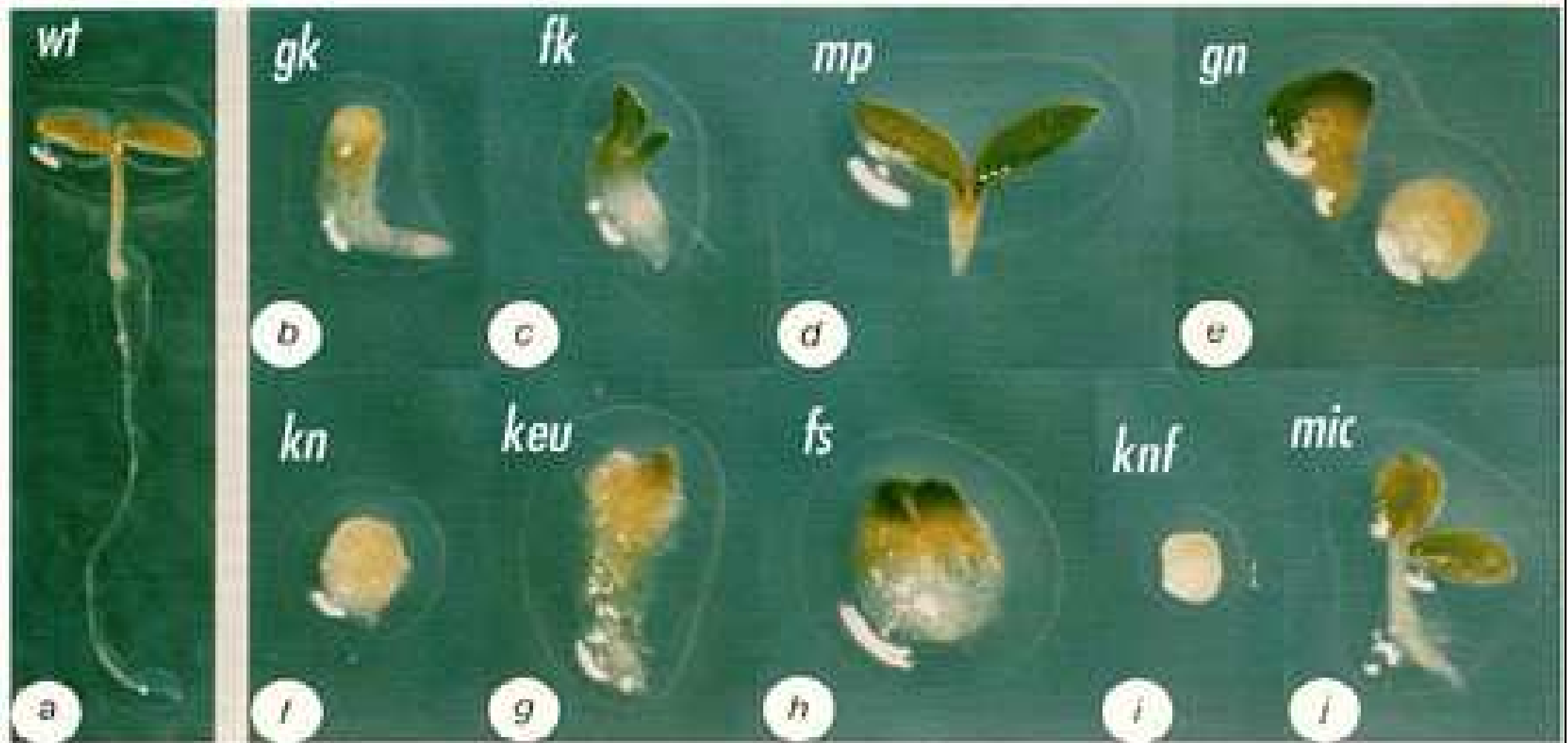

Patterning mutant types

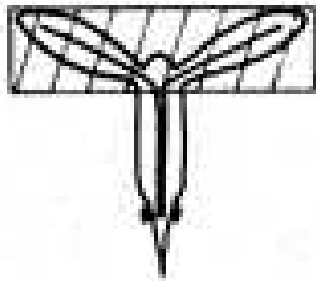

APICAL



(gurke)

Fatty acids

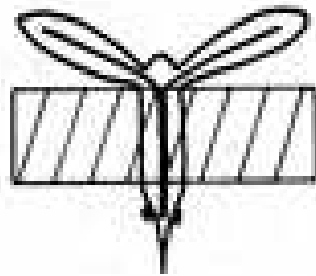

CENTRAL



(fackel)

Sterols

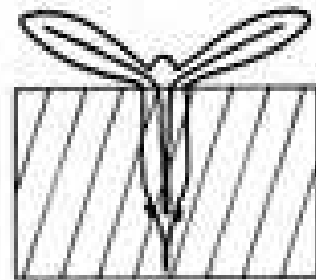

BASAL



(monopteros) Signalling

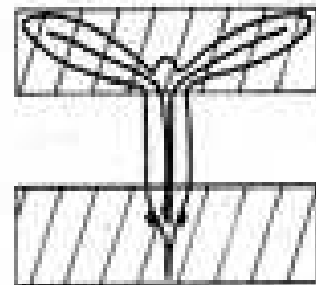

TERMINAL



(gnom)

Vesicle traffic

Activation tagging - YUCCA

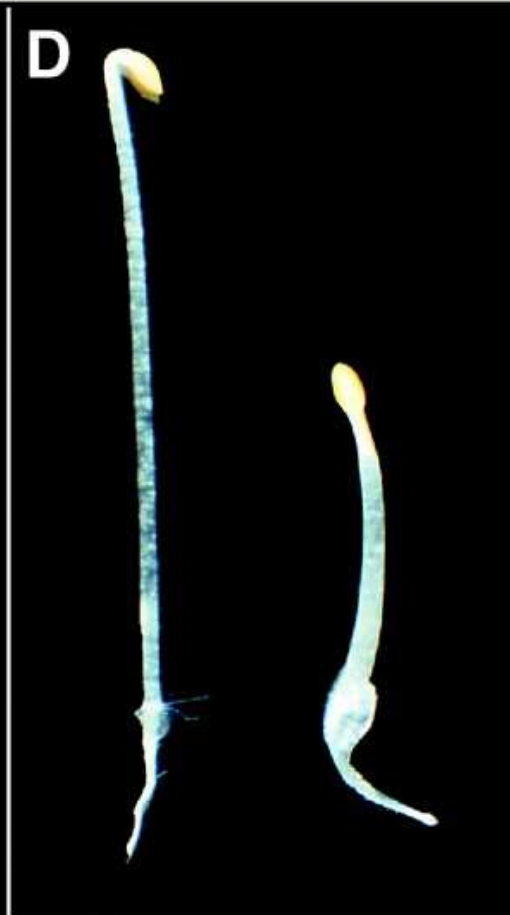
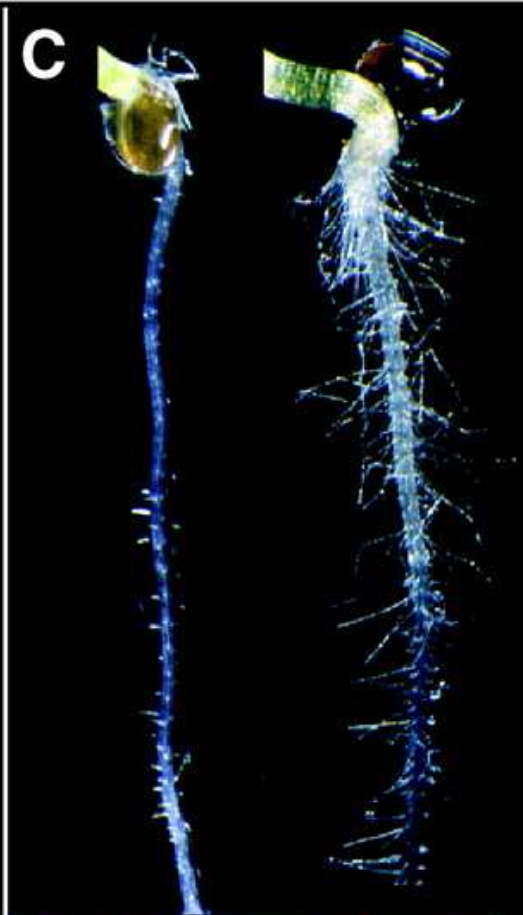
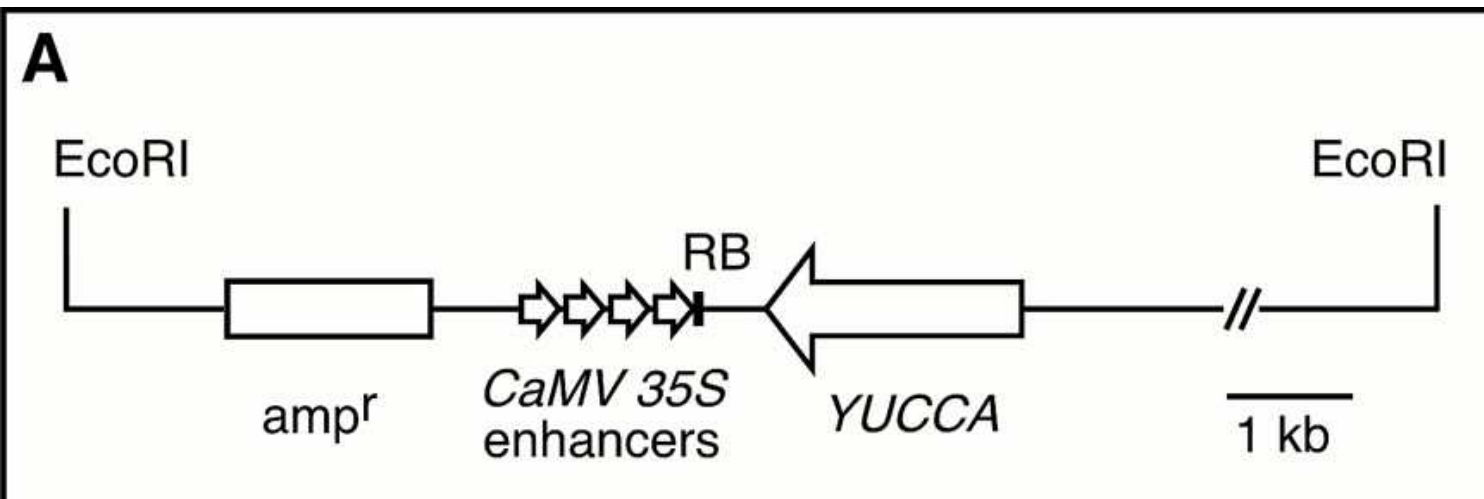

Second site mutagenesis - suppressors





Suppressors of CLV3 overexpression

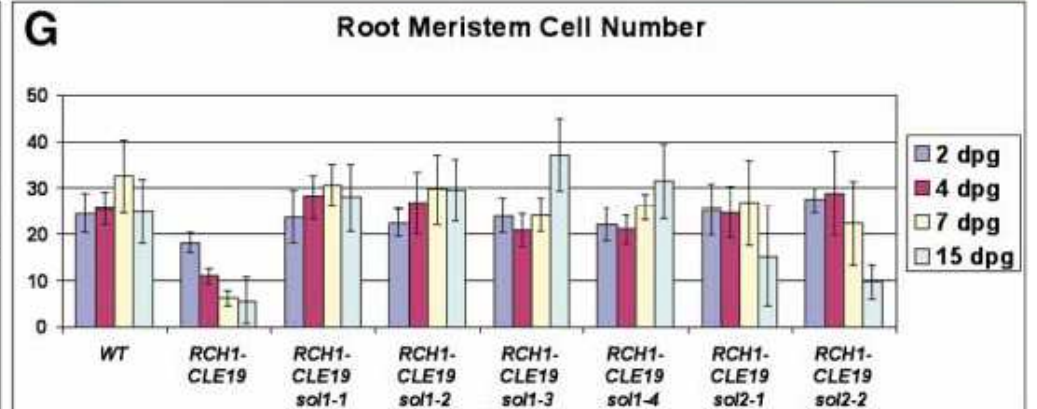
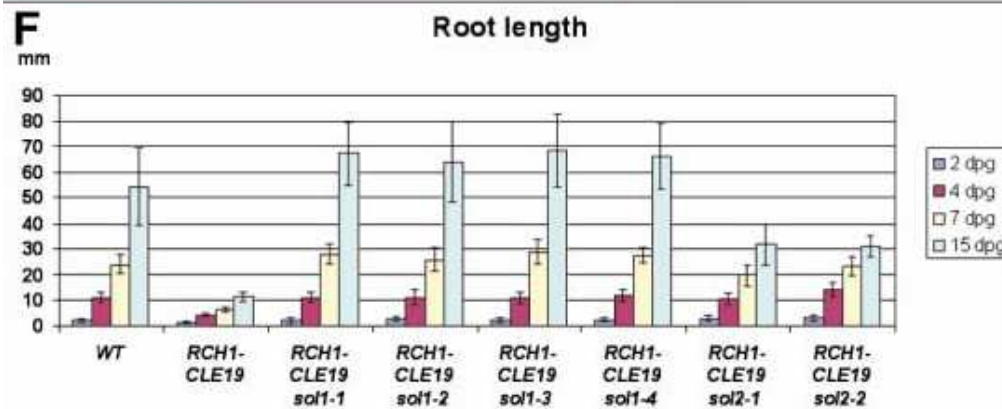
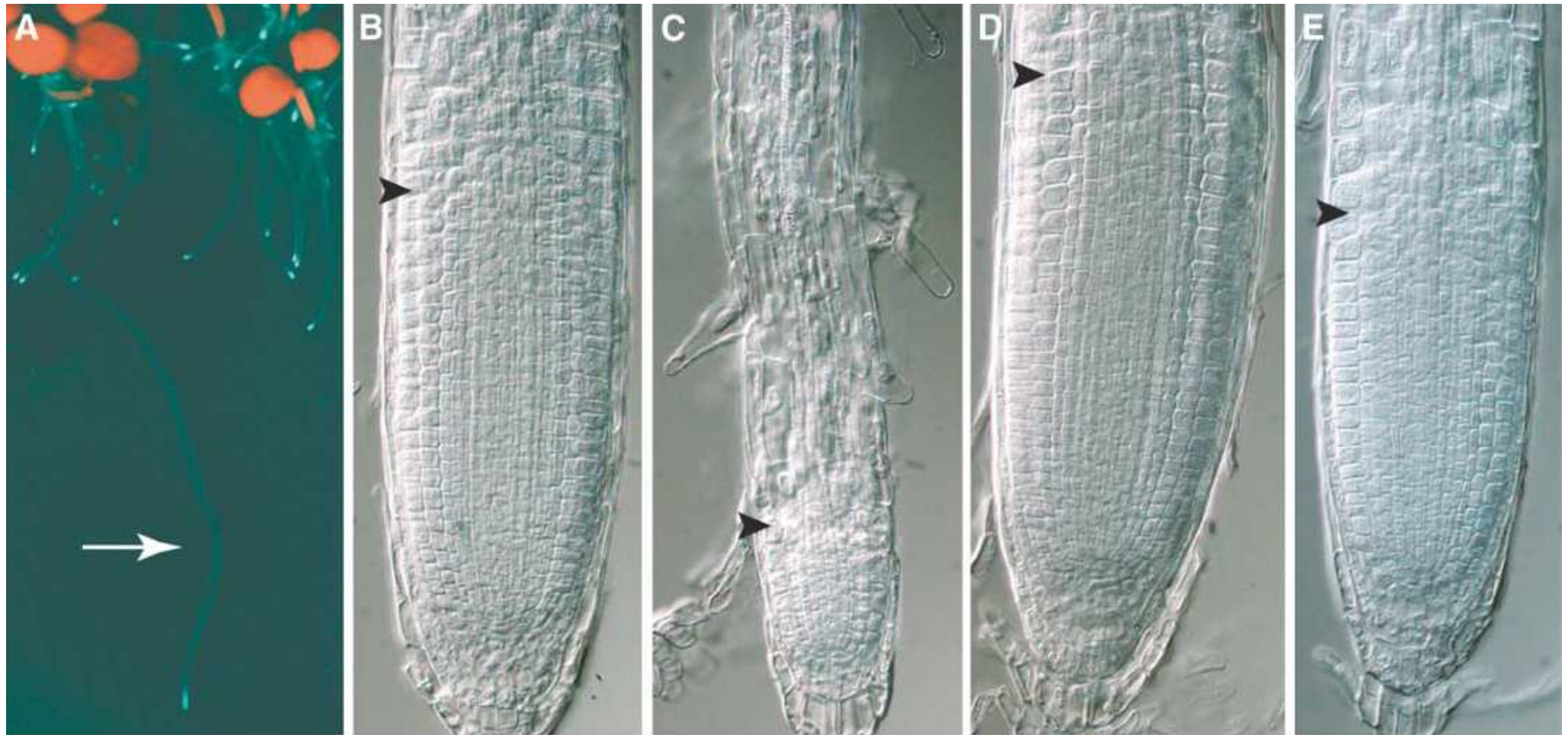

Second site mutagenesis - enhancers

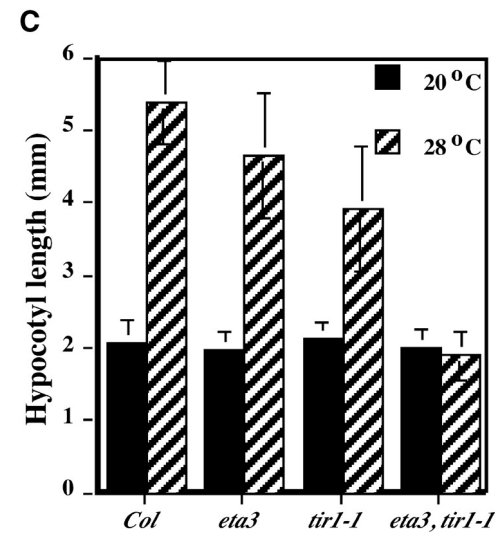
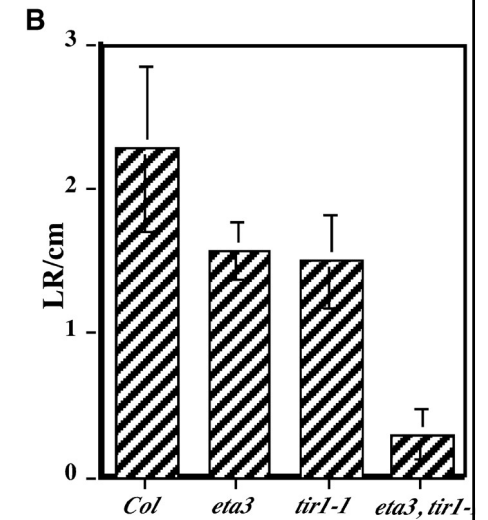
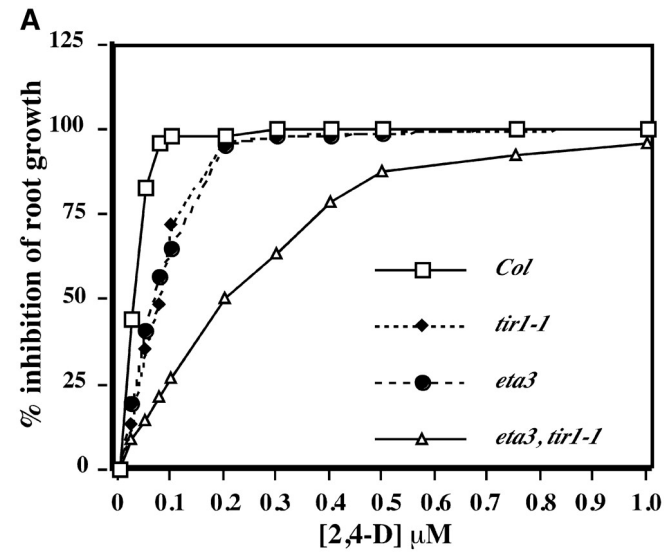

Gene verification

- Multiple alleles
- Transposone reversion
- Complementation

QTL

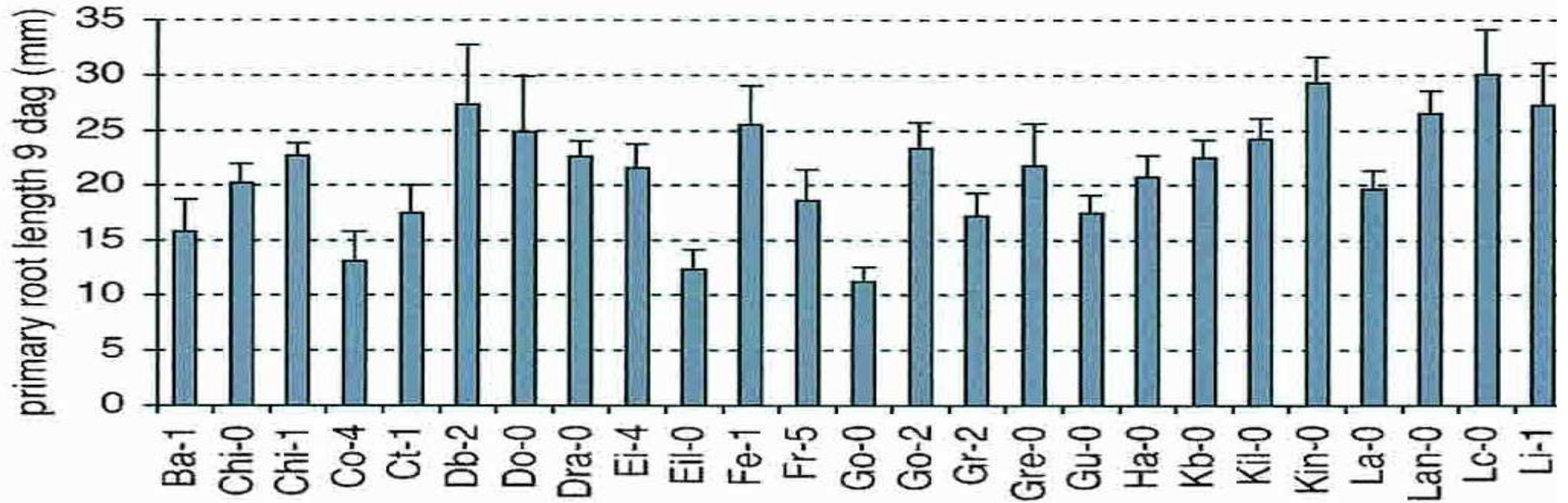

Uk-1 Sav-0 *brx^S*

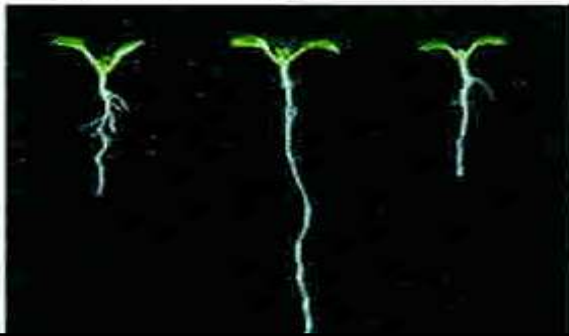

C

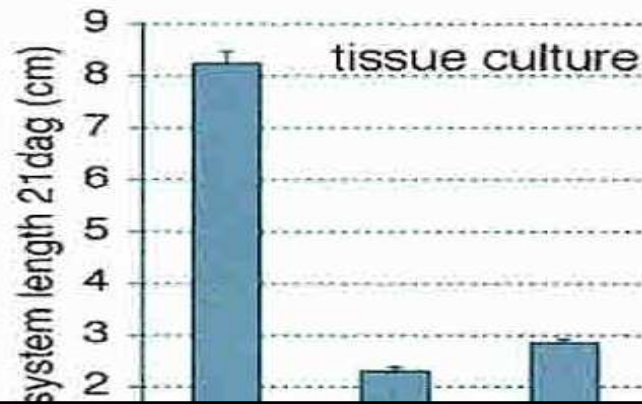

E

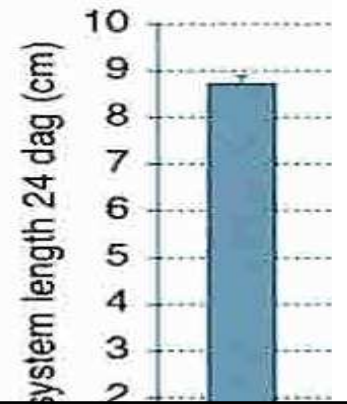

Towards a gene role

- Loss of function: Reverse genetics
- Gain of function: Ectopic expression
- Mosaics
- Sequence manipulations
- Phenotype analysis
- Biochemical function

Loss of function

- Reverse genetics/TILLING
- Antisense and RNAi approaches
- Immunomodulation
- Repression domain
- Titration

Reverse genetics

- indexed mutant libraries

Arabidopsis thaliana
Chr1 1 - 40001

out ◀◀◀◀ ◀◀◀◀ ◀◀◀◀ ◀◀◀◀ ▶▶▶▶ ▶▶▶▶ ▶▶▶▶ in

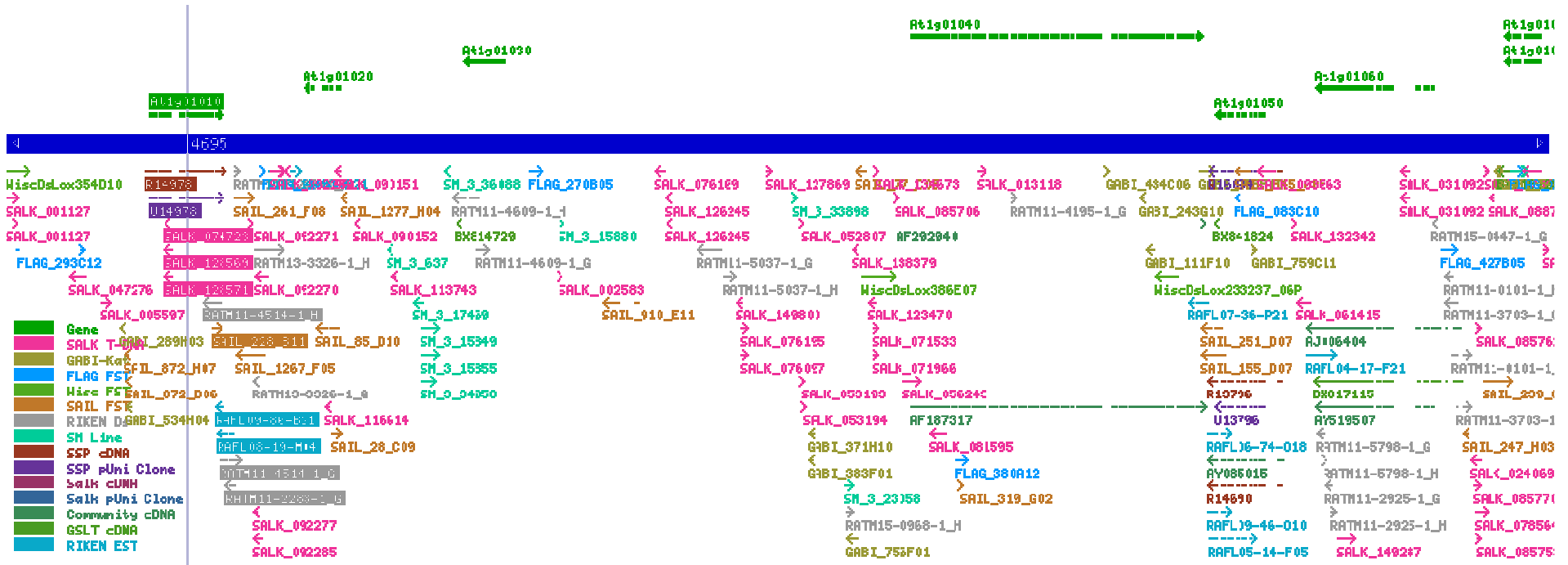

TILLING

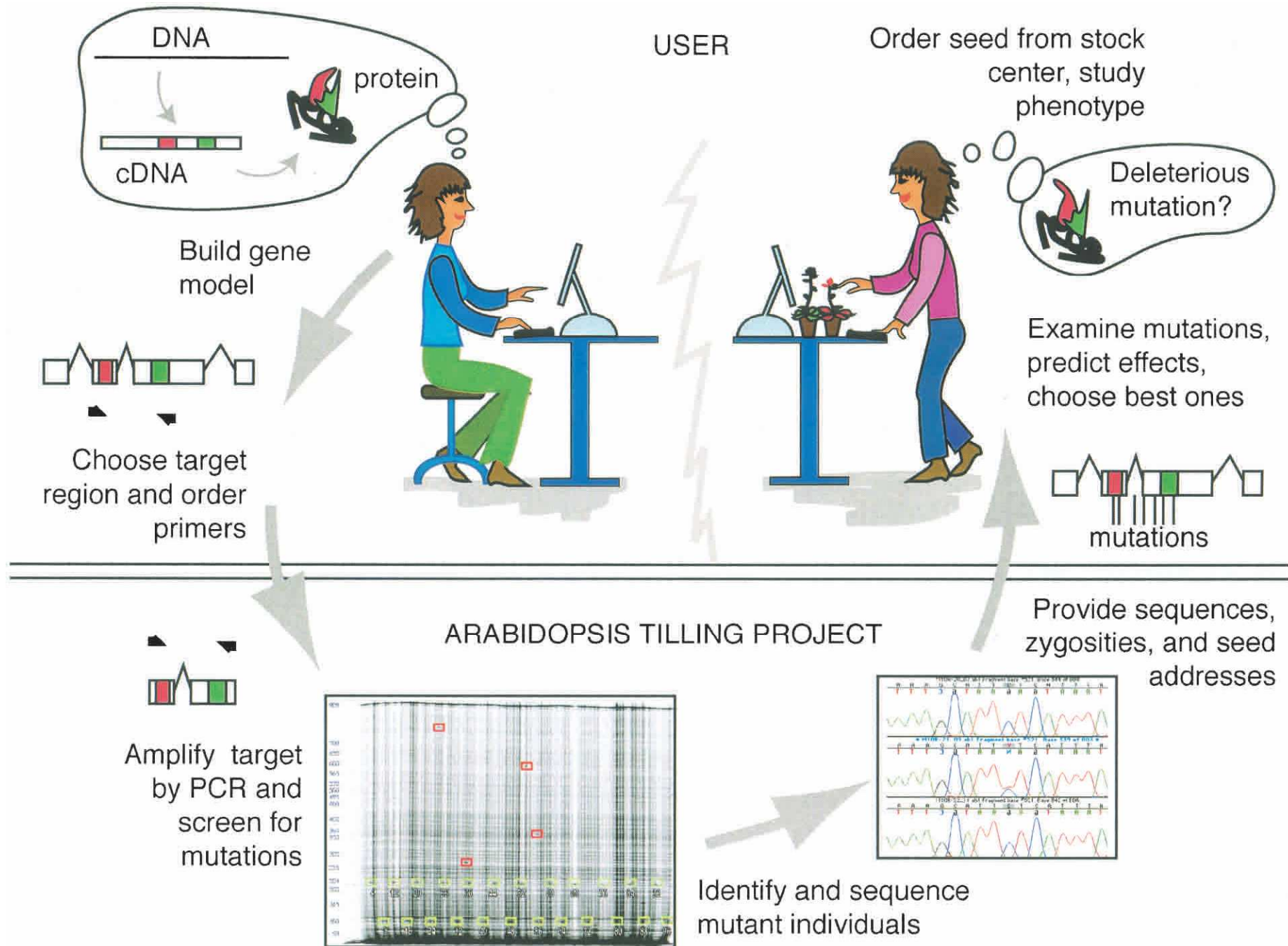

TILLING

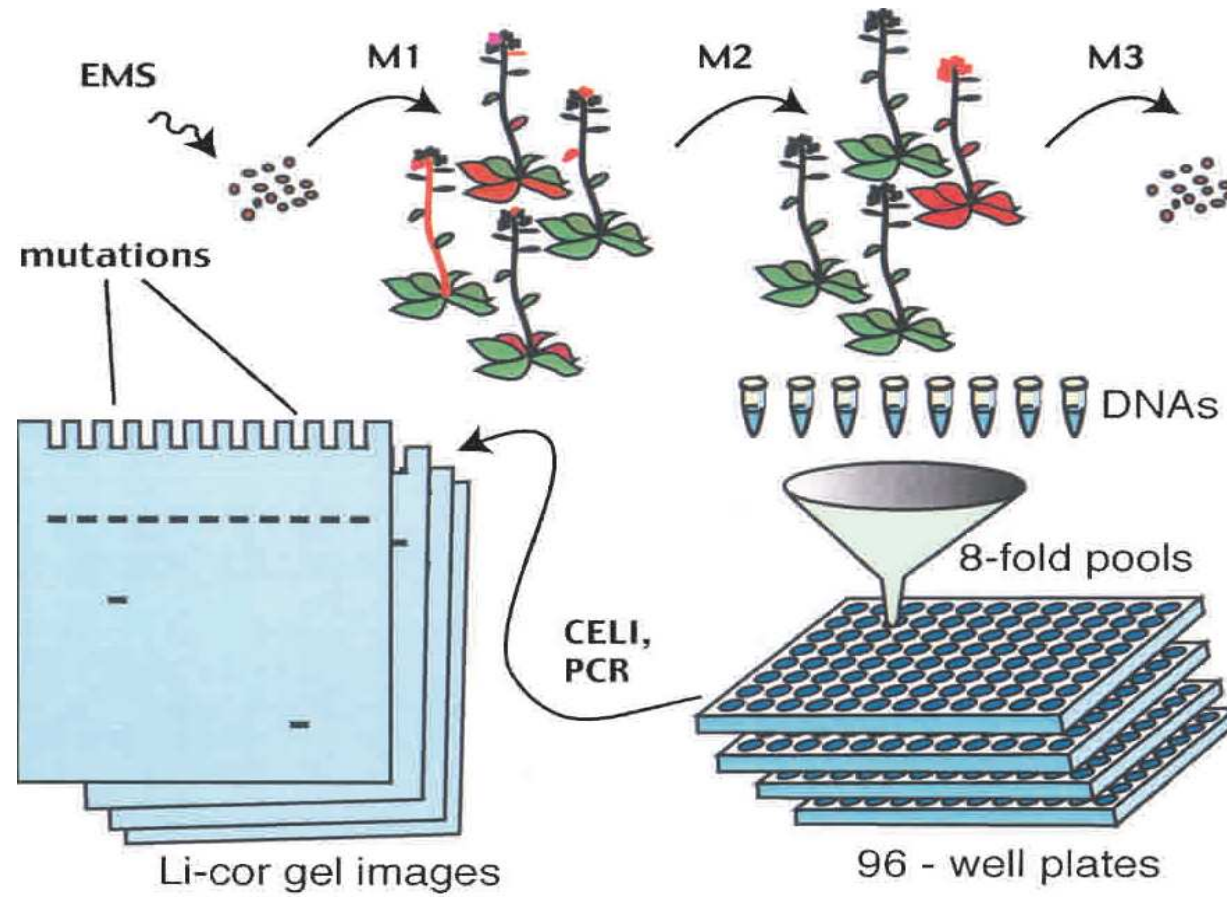

Gain of function

- Overexpression
- Tissue specific expression
- Conditional expression
- Protein stabilisation

CaMV 35S Promotor

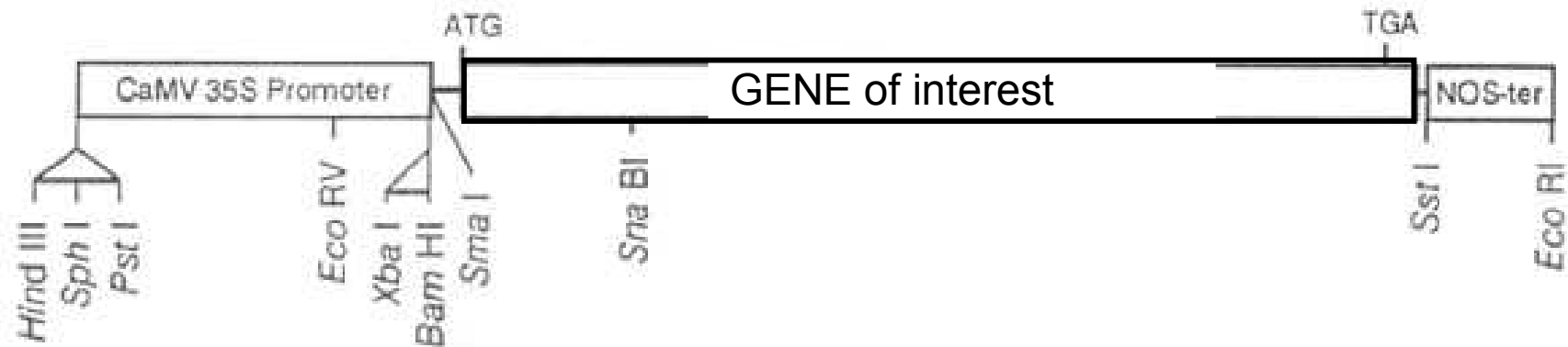

pBI221 The CaMV 35S promoter-GUS-NOS-ter portion of pBI121 was cloned into pUC19 to produce pBI221.

Two component system for gene expression

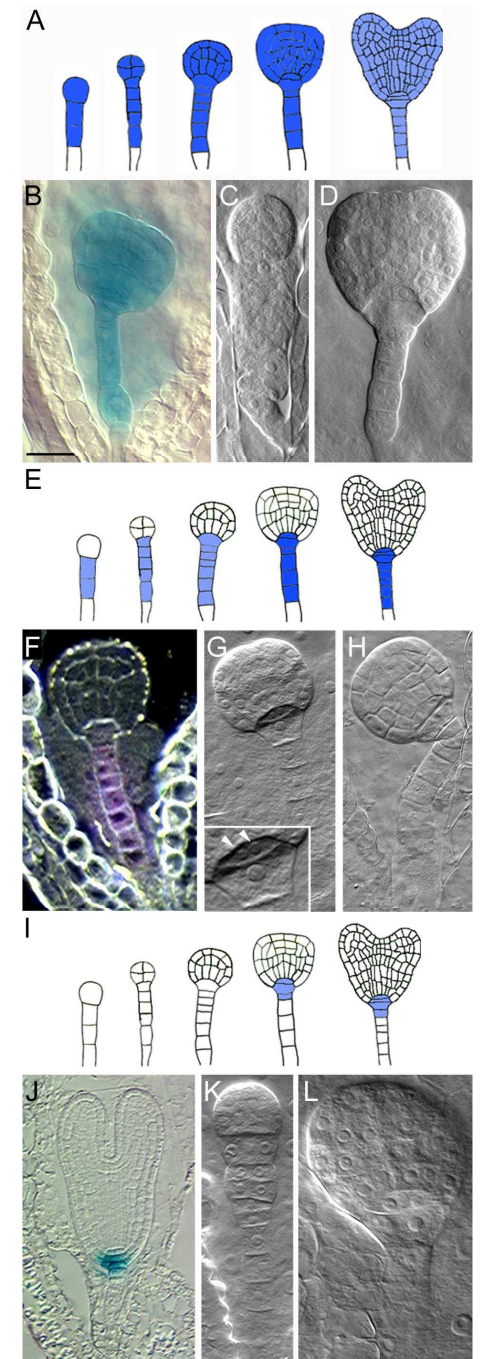
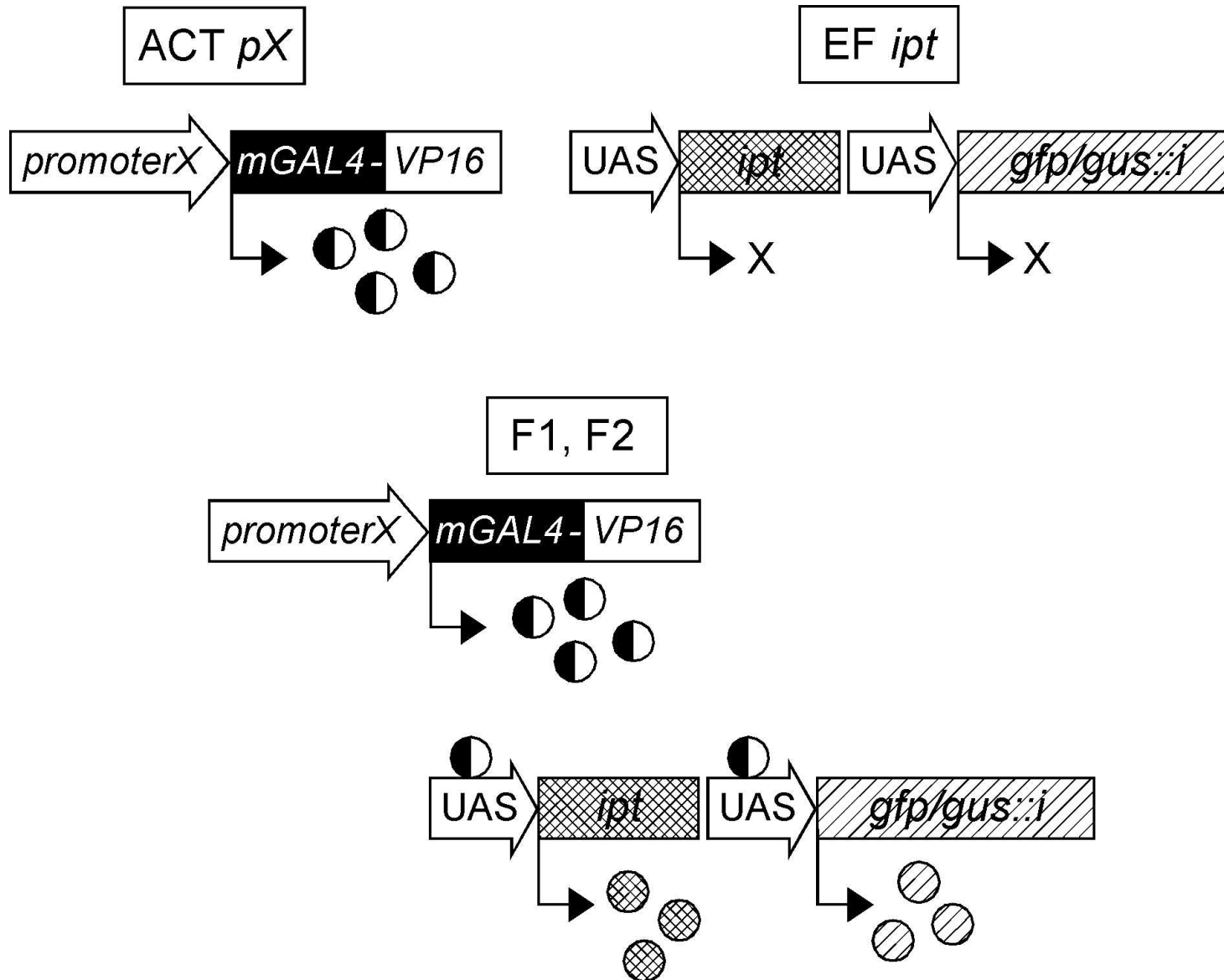

Targeted gene expression

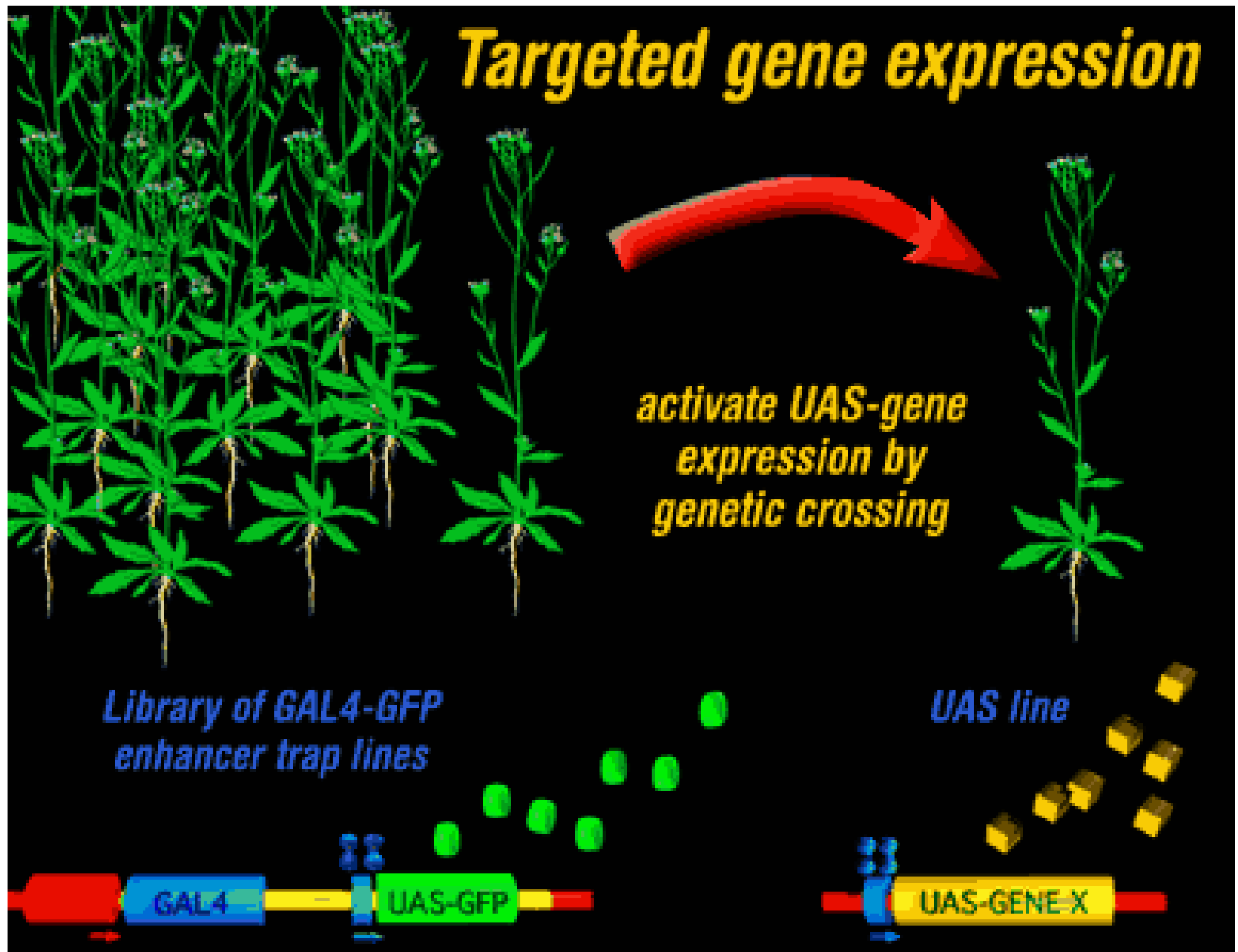

The hidden function of WUSCHEL

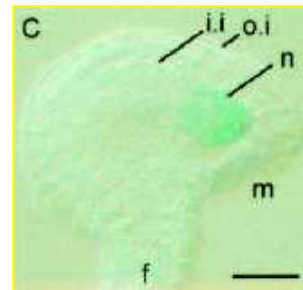
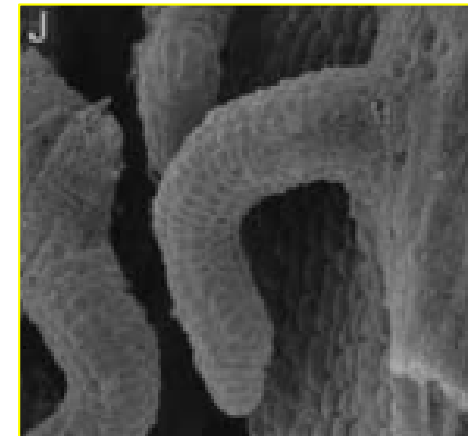
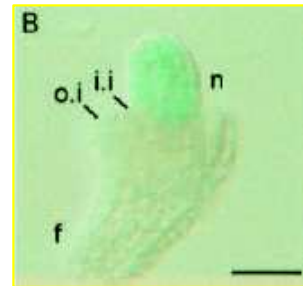
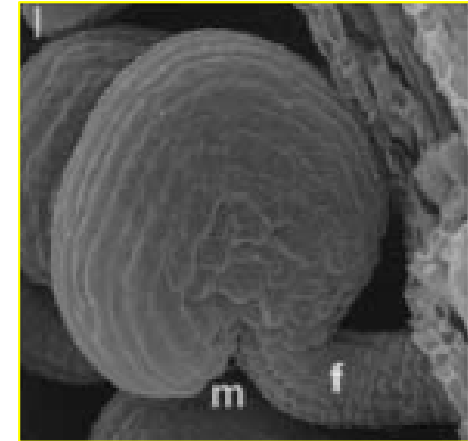
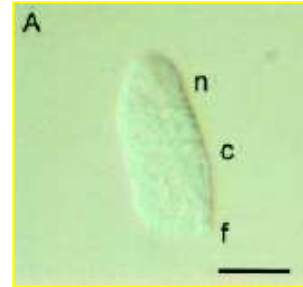

Mosaics – Cre/Lox

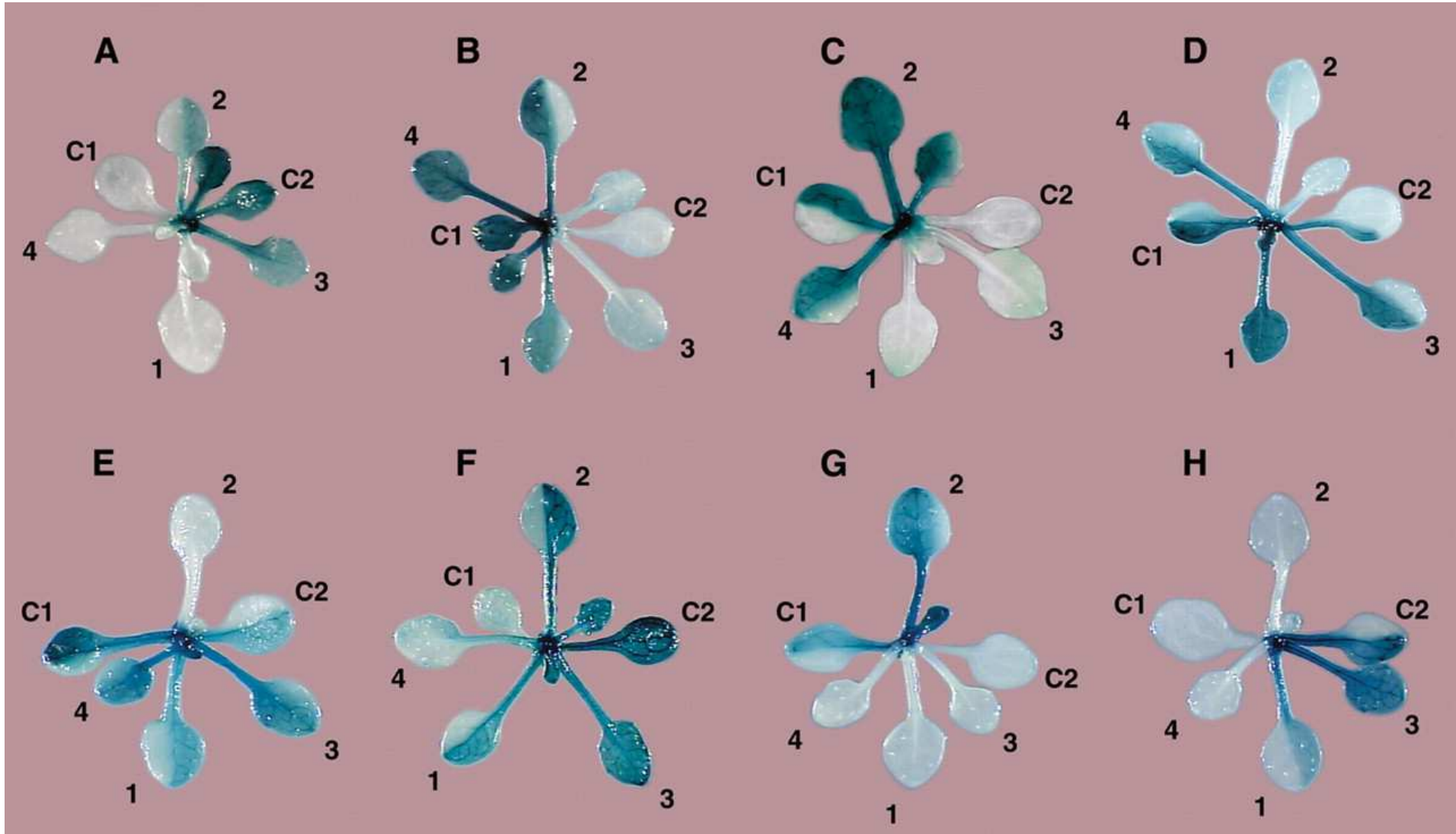

Sequence manipulation

- Site-directed mutagenesis
- Domain deletions and swaps
- Chimeric proteins

rop GTPases mutants

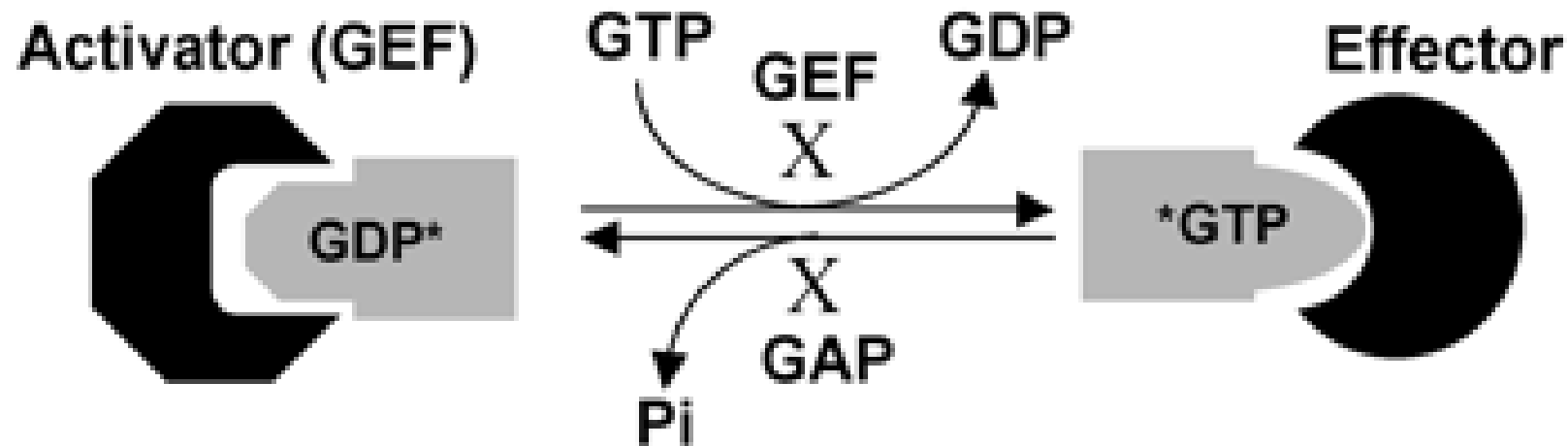

DN-rop mutants

- Permanently bind GDP or nucleotide-free
- Sequester activator (GEF) when overexpressed
- Examples:
 - ROP1/ROP2/ROP4/ROP6: T20N, A121D
 - ROP5: T20N

CA-rop mutants

- Permanently bind GTP
- Insensitive to GAP
- Constitutively activate effectors when expressed in cells
- Examples:
 - ROP1/ROP2/ROP4/ROP6: G15V or Q64L
 - ROP5: G15V or Q64E

AUX/IAA and ARF proteins

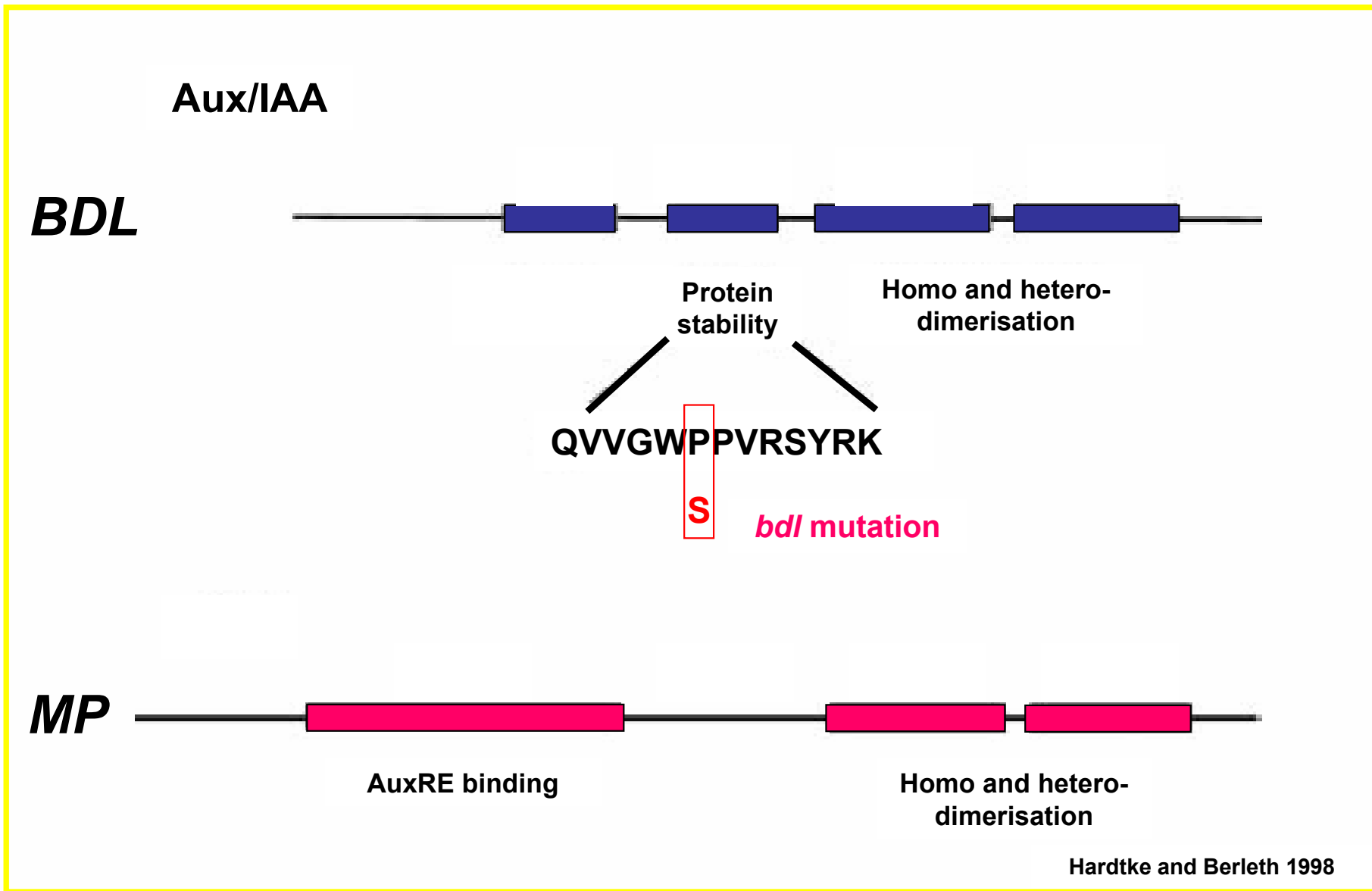

CRE1 – cytokinin receptor

a

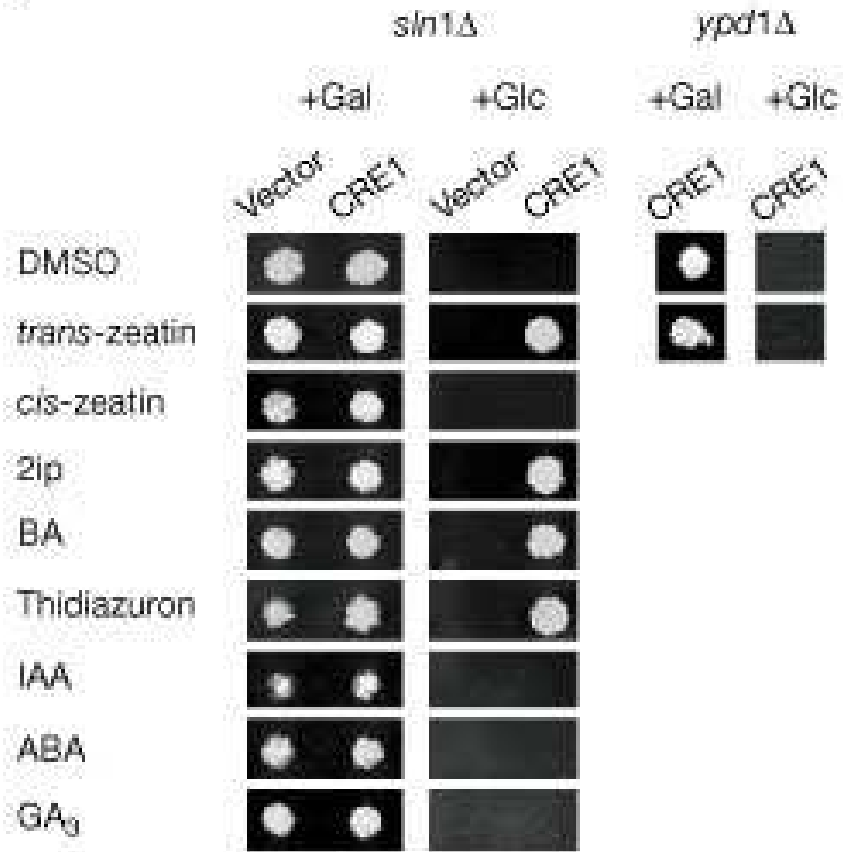

b



c

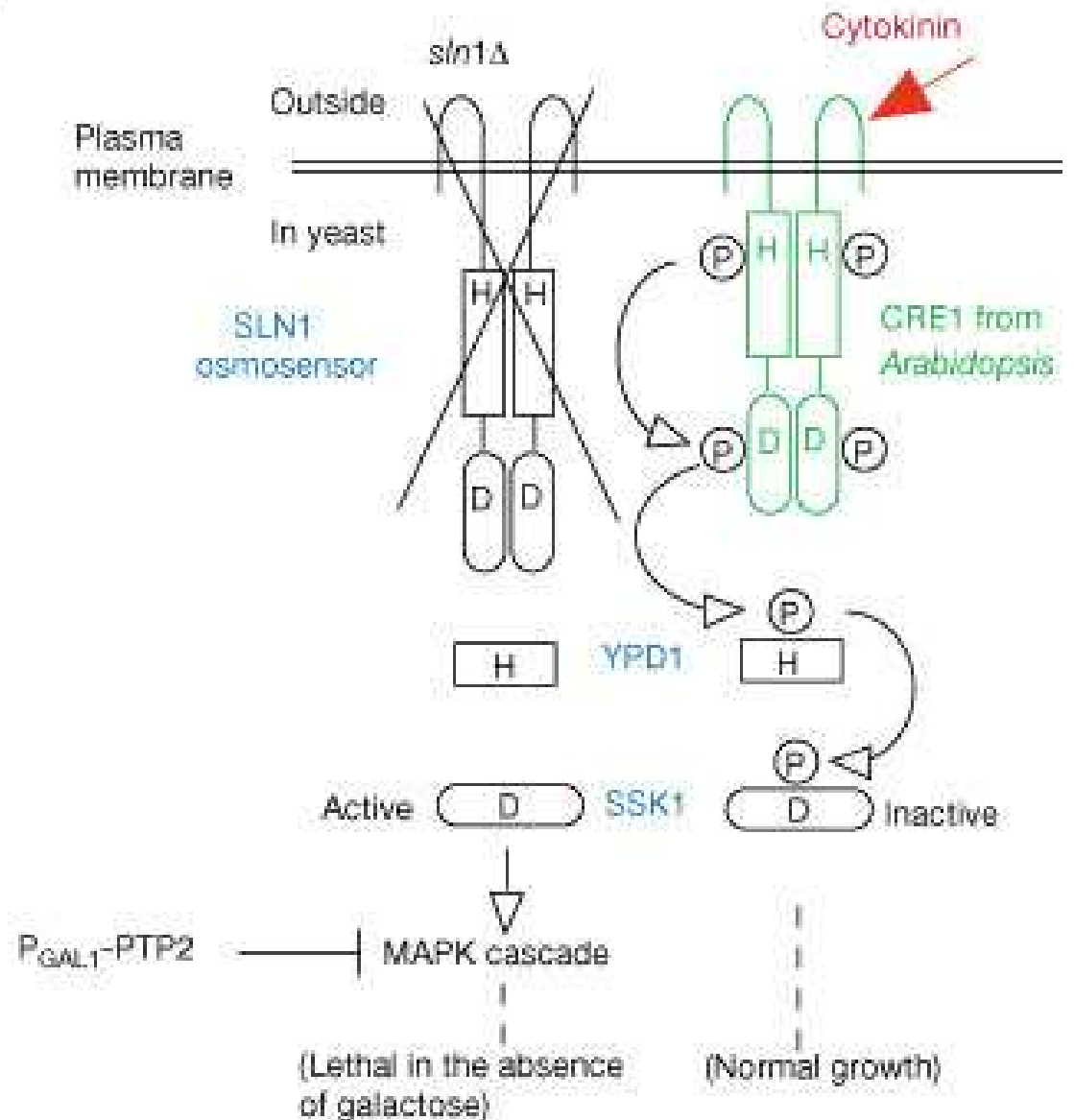

Phenotype analysis

- Visual evaluation
- Ultrastructure (EMS)
- Use of markers
- Treatments

Biochemical function

- Protein activity
- Yeast complementation
- *Xenopus* oocytes

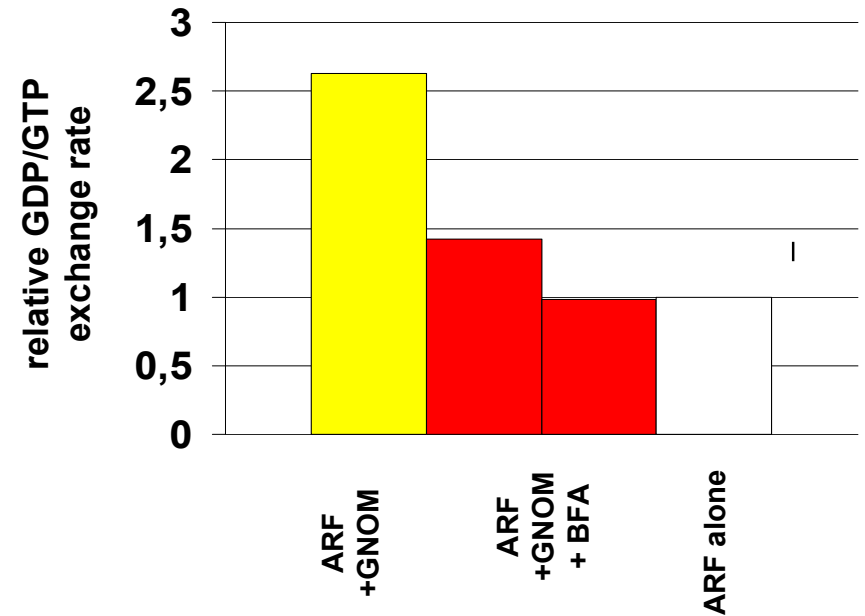

Gene Expression and Protein Localization

- Blots, RT-PCR
- Reporter genes
- In situ mRNA hybridization
- In situ protein localization
- In situ protein activity detection

Blots and RT-PCR

Northern blots

RT-PCR

Figure 8. Expression of *AtPIN* genes.
Northern blot and RT-PCR analysis of *AtPIN3* - *AtPIN8* genes. *AtPIN3* transcript was found in stem, *AtPIN4*, *AtPIN6* and *AtPIN7* in root and *AtPIN5* and *AtPIN8* in seedling. In the second line *ACTIN* signal is depicted.

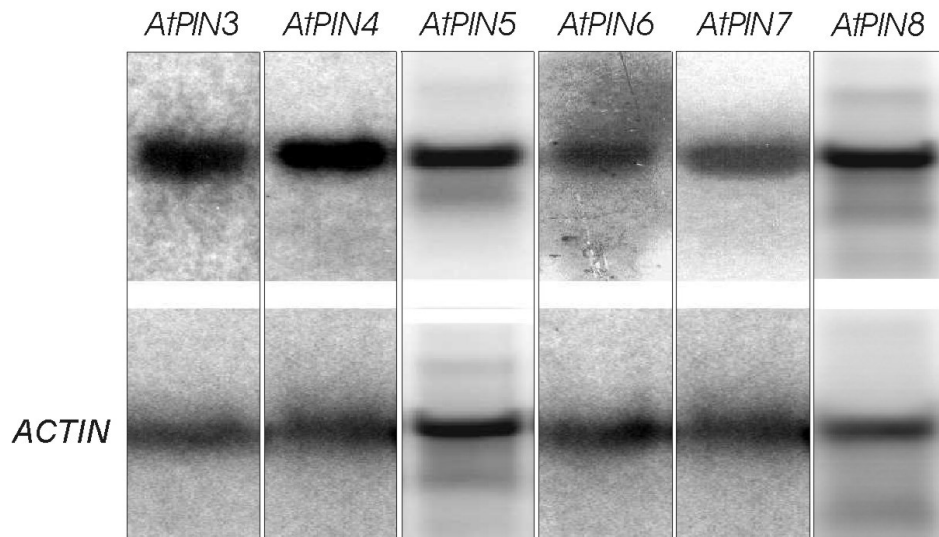

- IAA

+ IAA

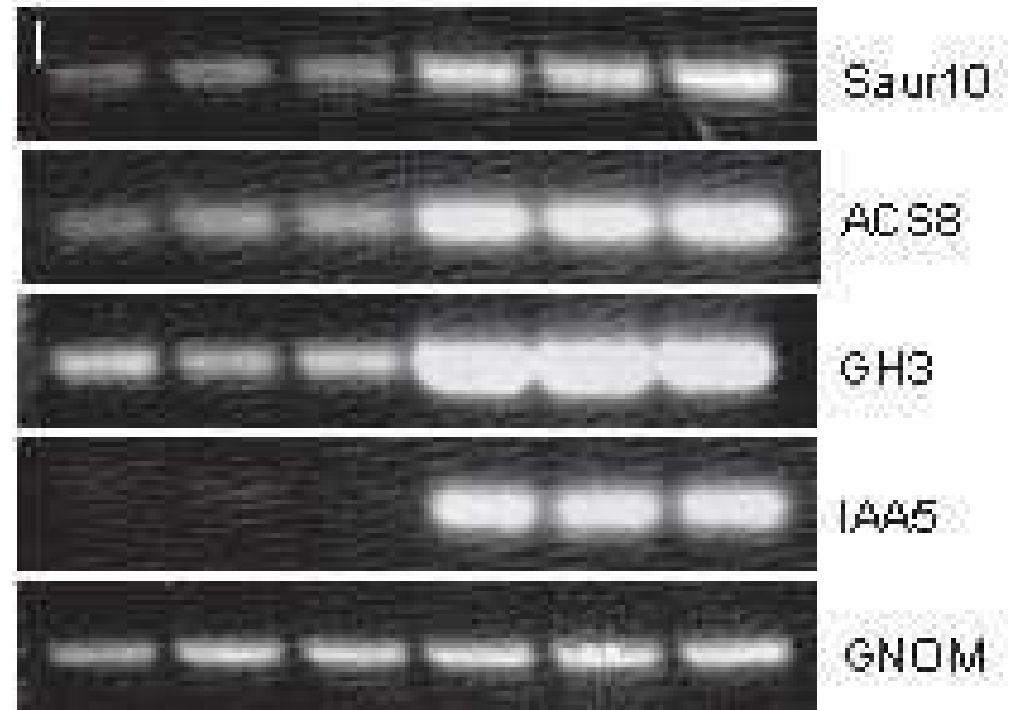

Southern and Western blots

Reporter genes

- Transcriptional fusions
- Translational fusions
- GUS, Luciferase, GFP
- Applications

Transcriptional fusion

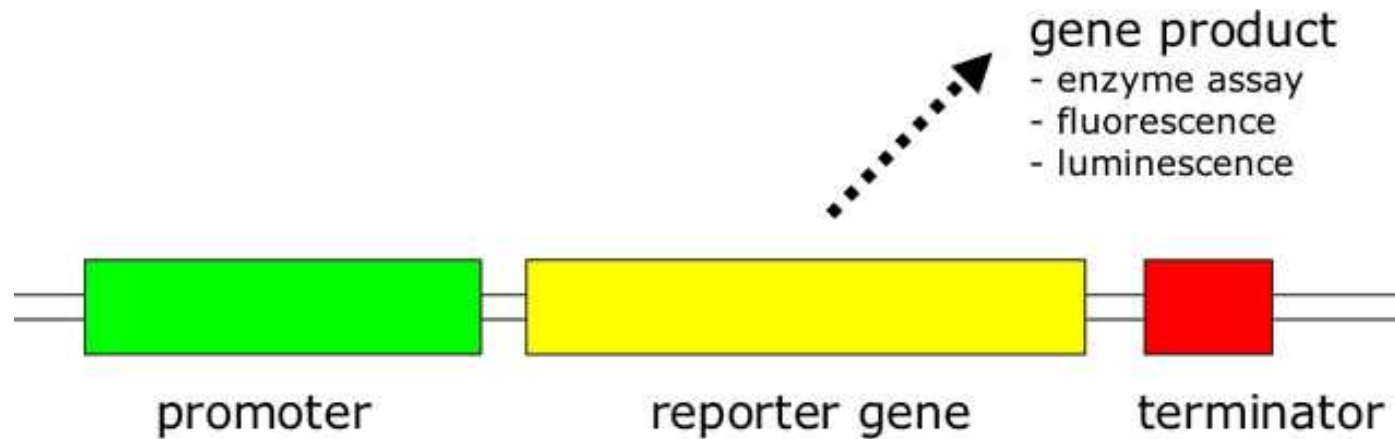

Reporter genes: markers for gene expression

***β -glucuronidase
green fluorescent protein
luciferase***

GUS – β -Glucuronidase

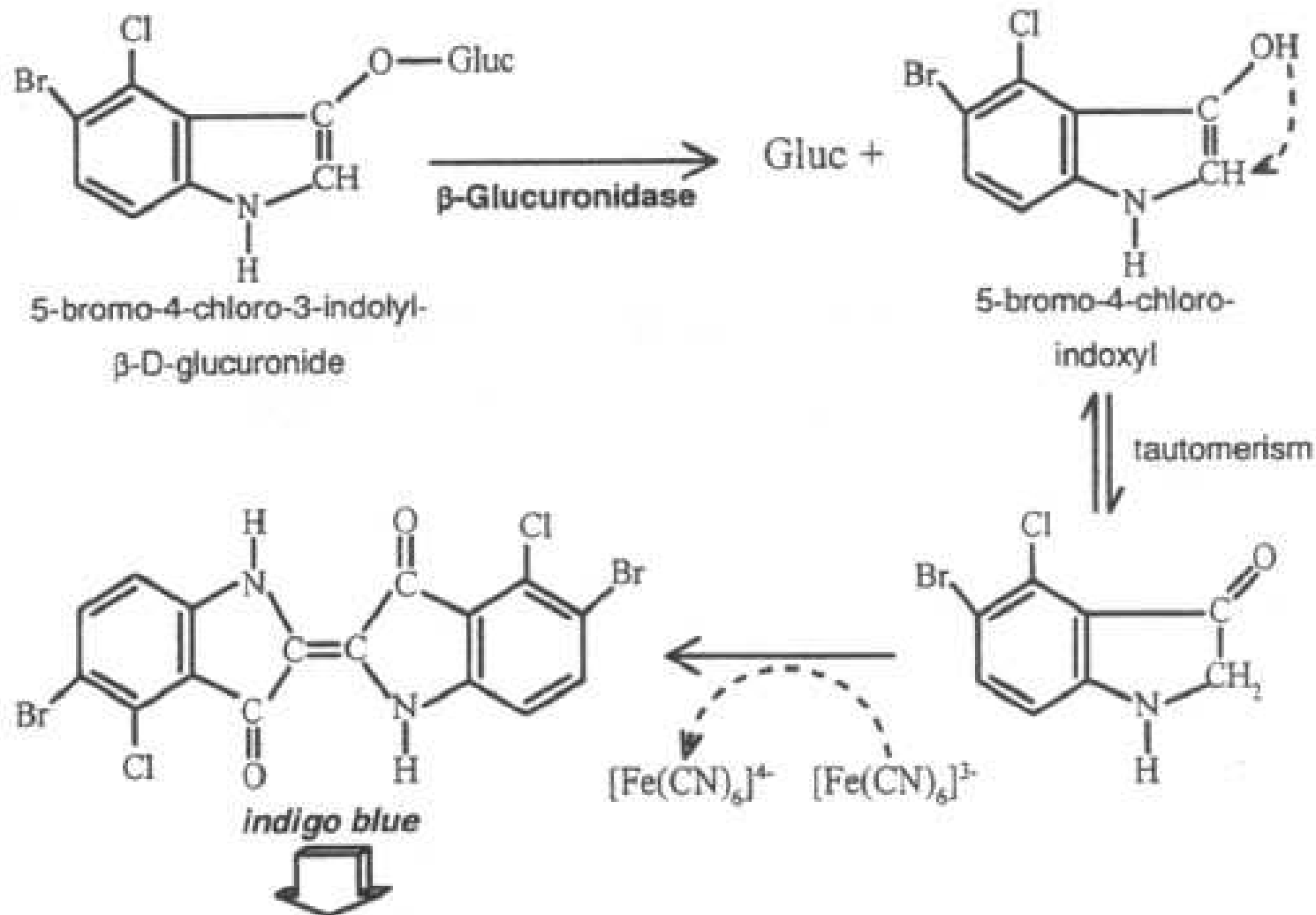
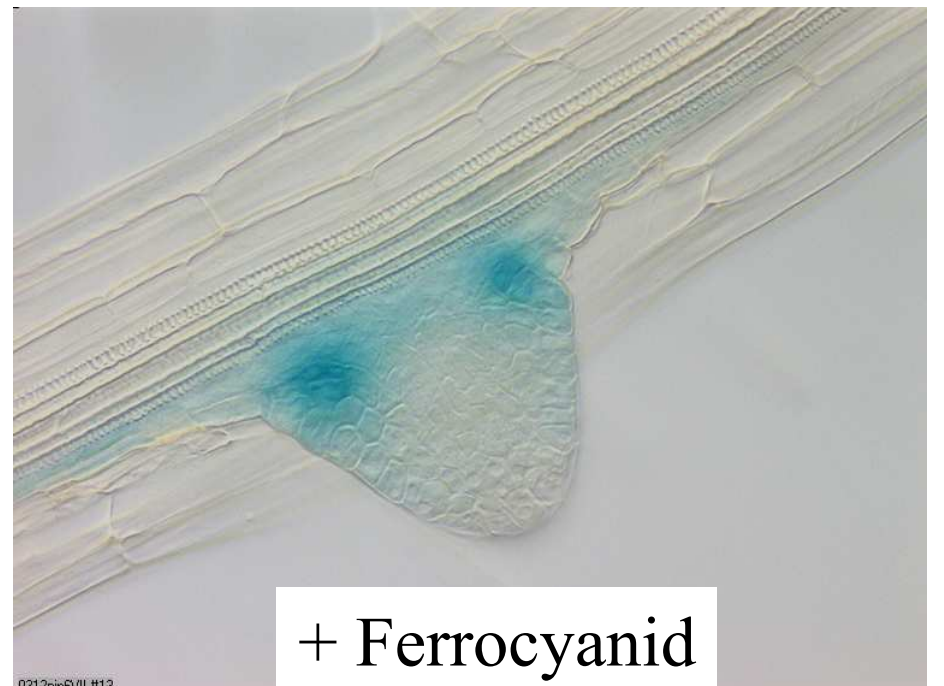
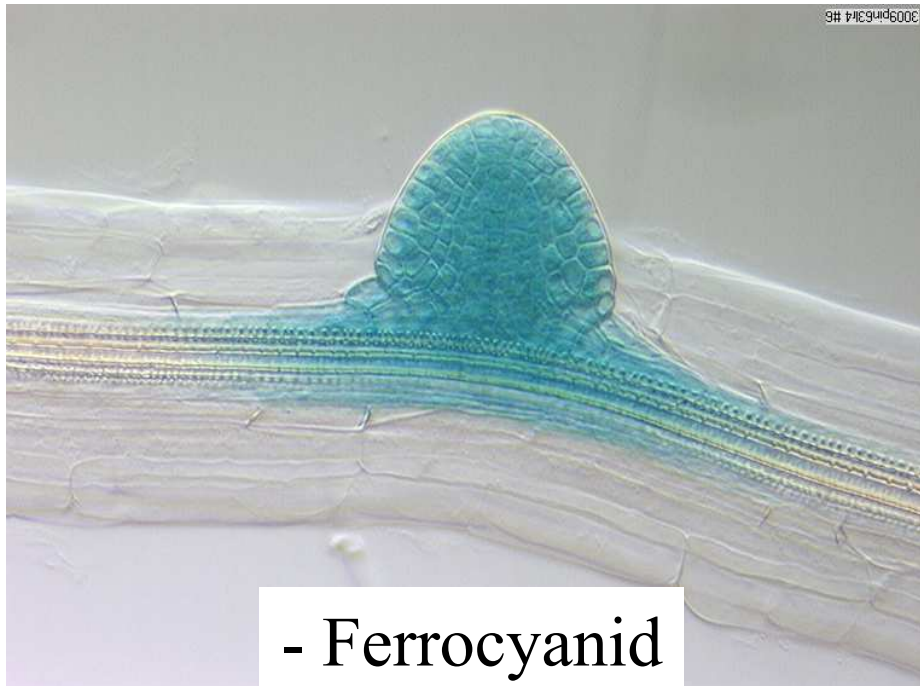
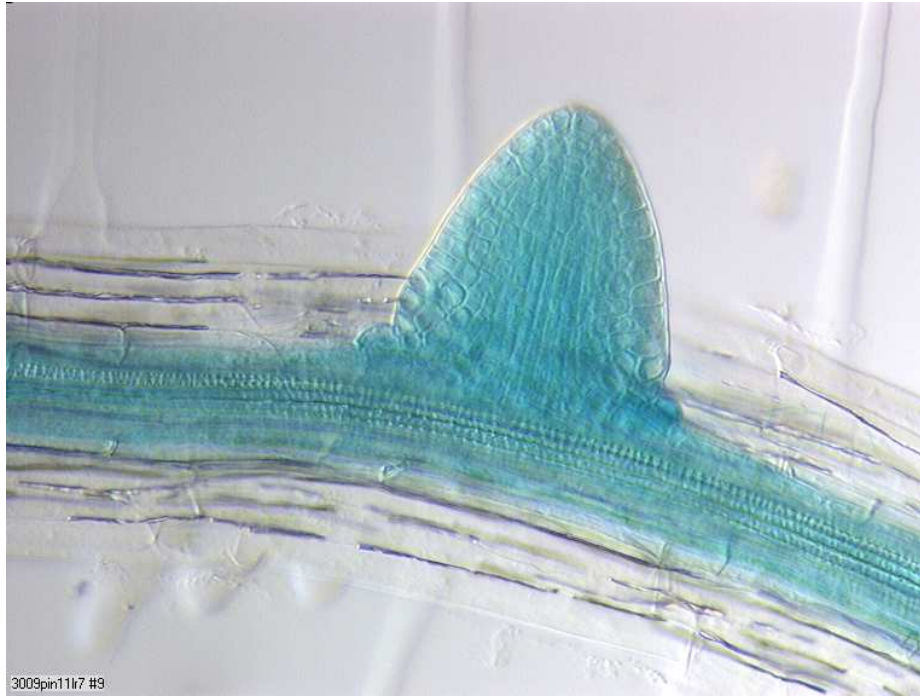
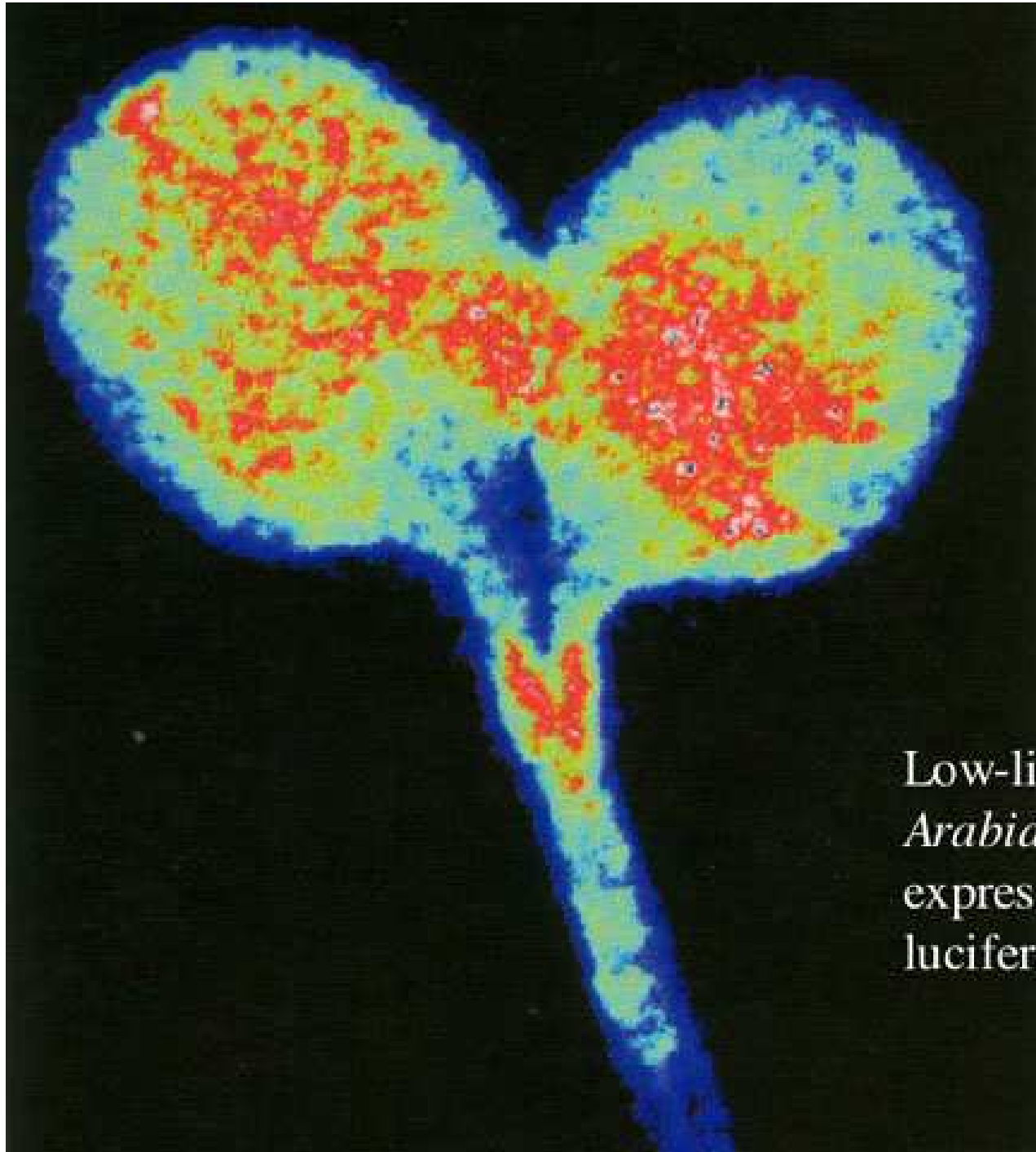

Fig. 1. Chemistry of X-Gluc reaction. Hydrolyzation of X-Gluc by the β -glucuronidase enzyme results in a reactive indoxyl molecule. Two indoxyl molecules are oxidized to indigo blue; ferri(III)cyanide enhances the dimerization.

GUS – β -Glucuronidase





Low-light imaging of an
Arabidopsis seedling
expressing a firefly
luciferase reporter gene.

(*CAB2::luc*)

Green Fluorescence Protein

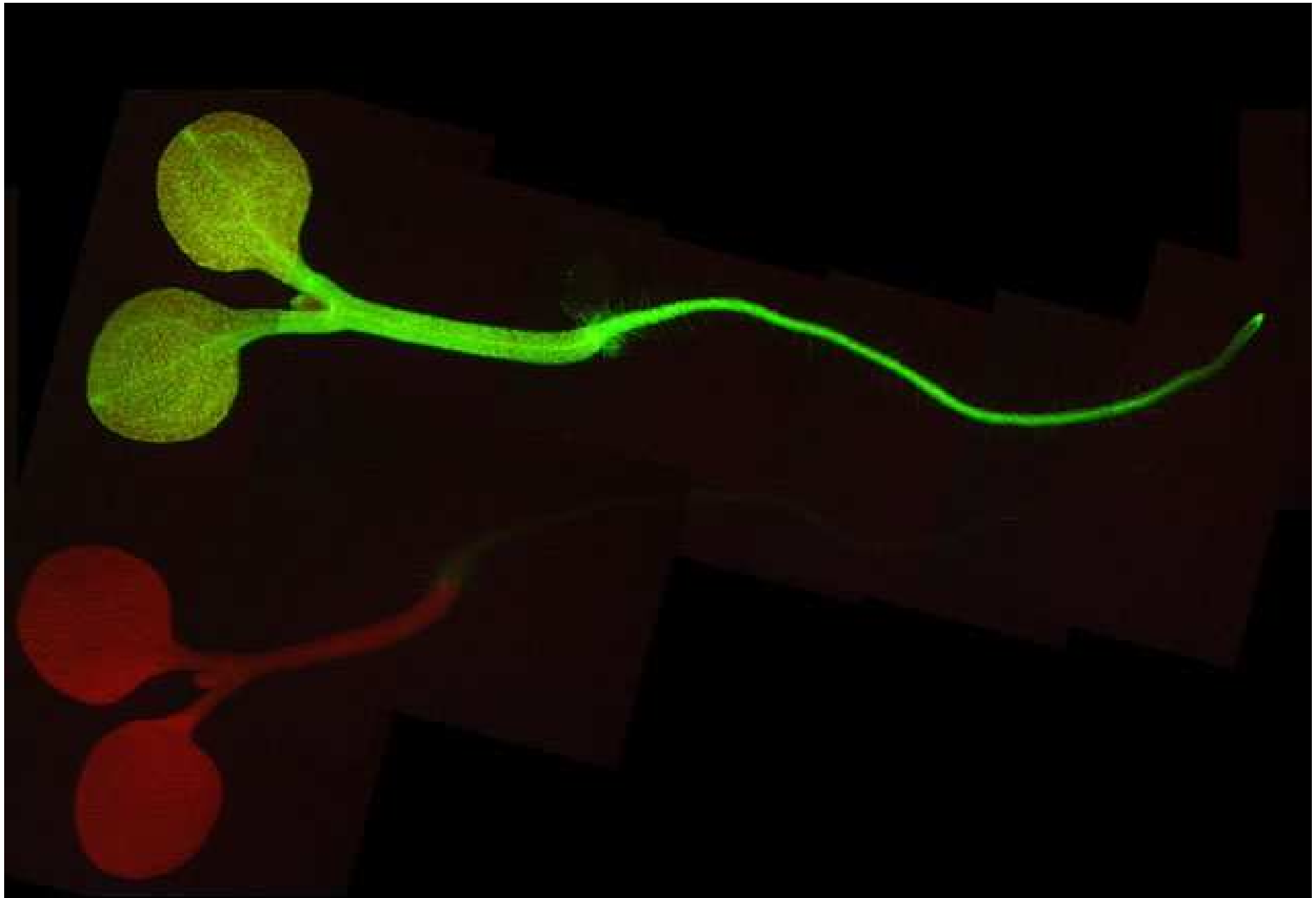



Bioluminescence in Aequoria victoria



aequorin

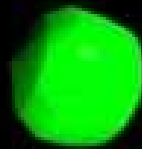

green fluorescent protein

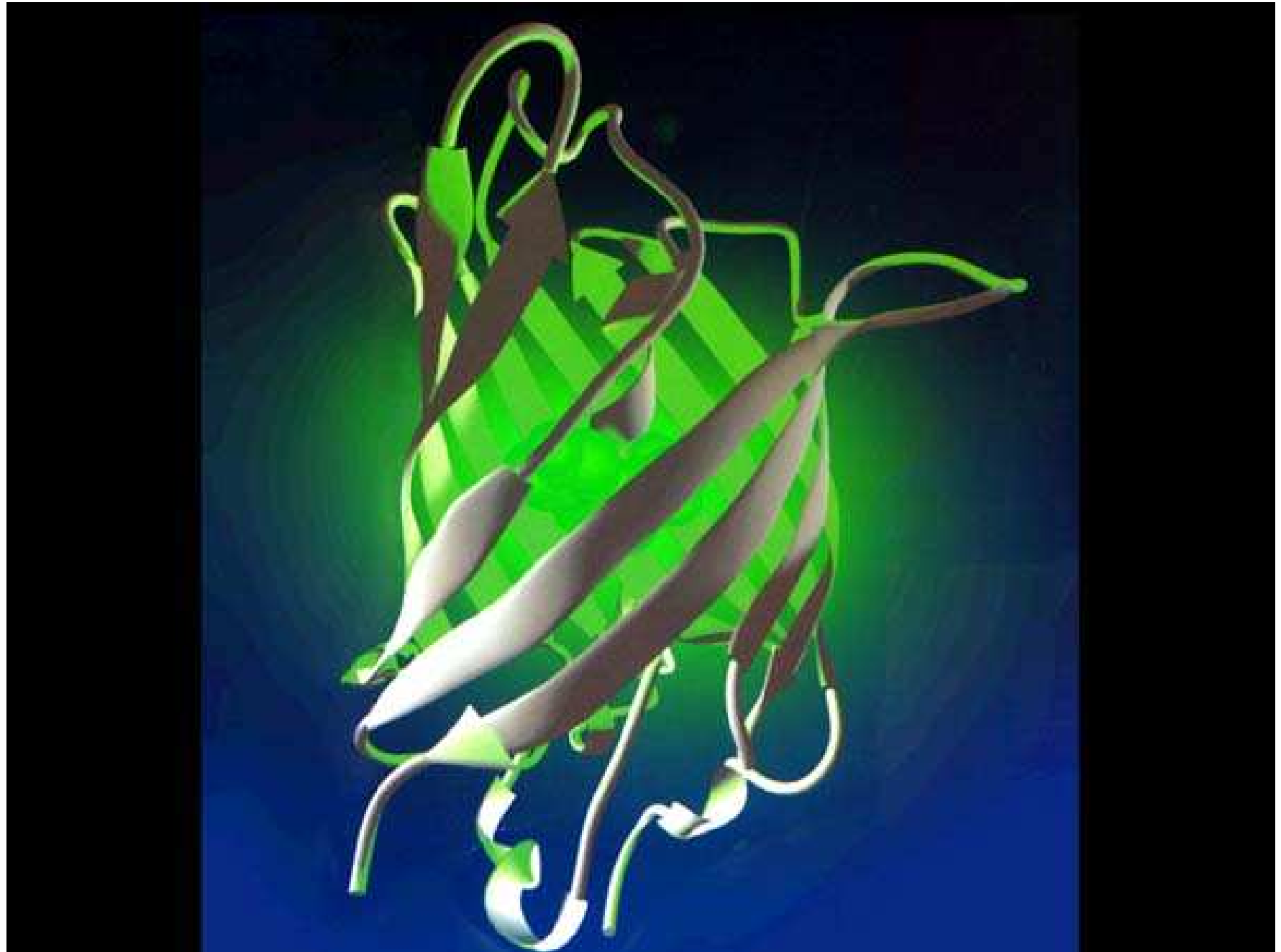

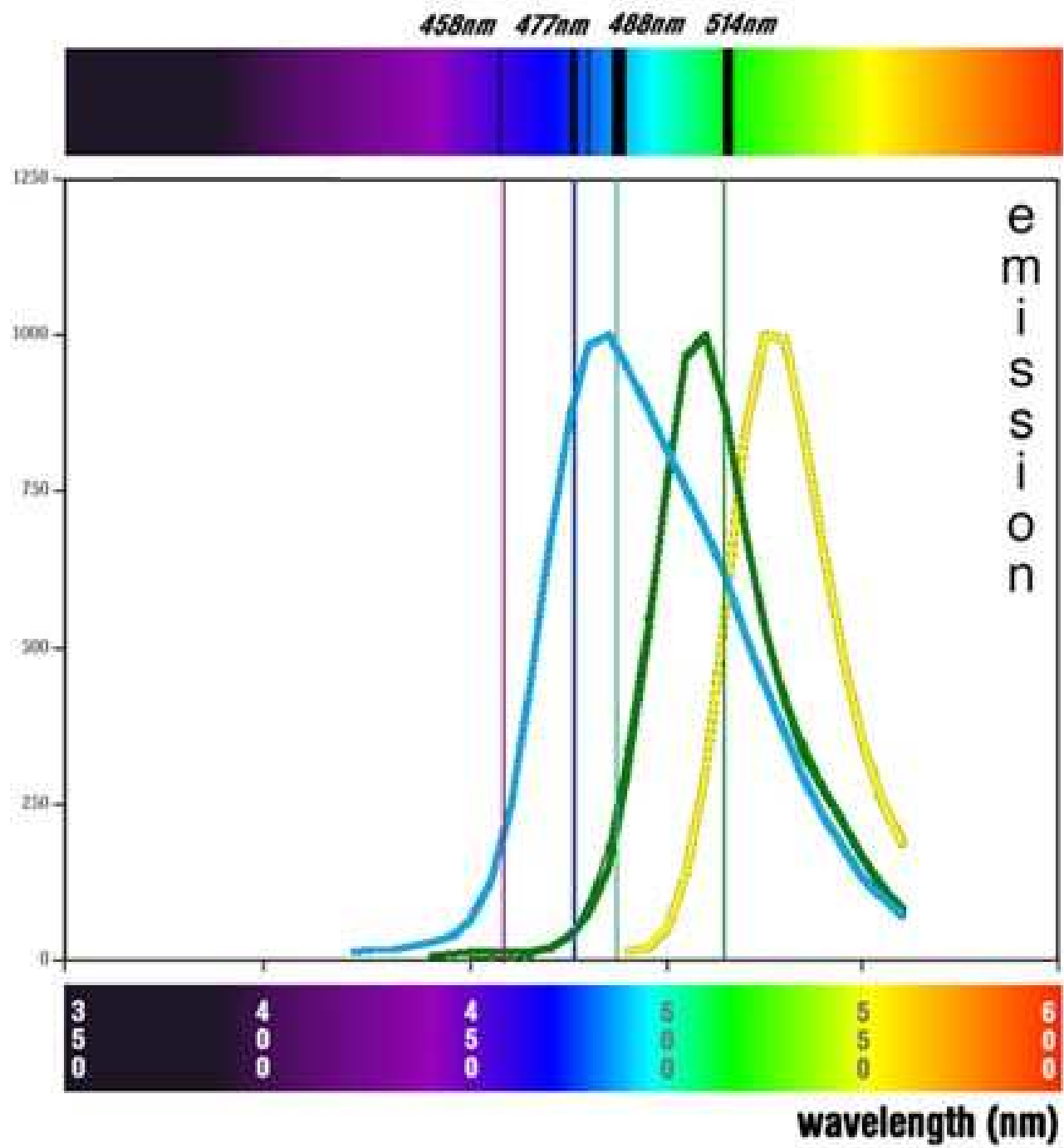

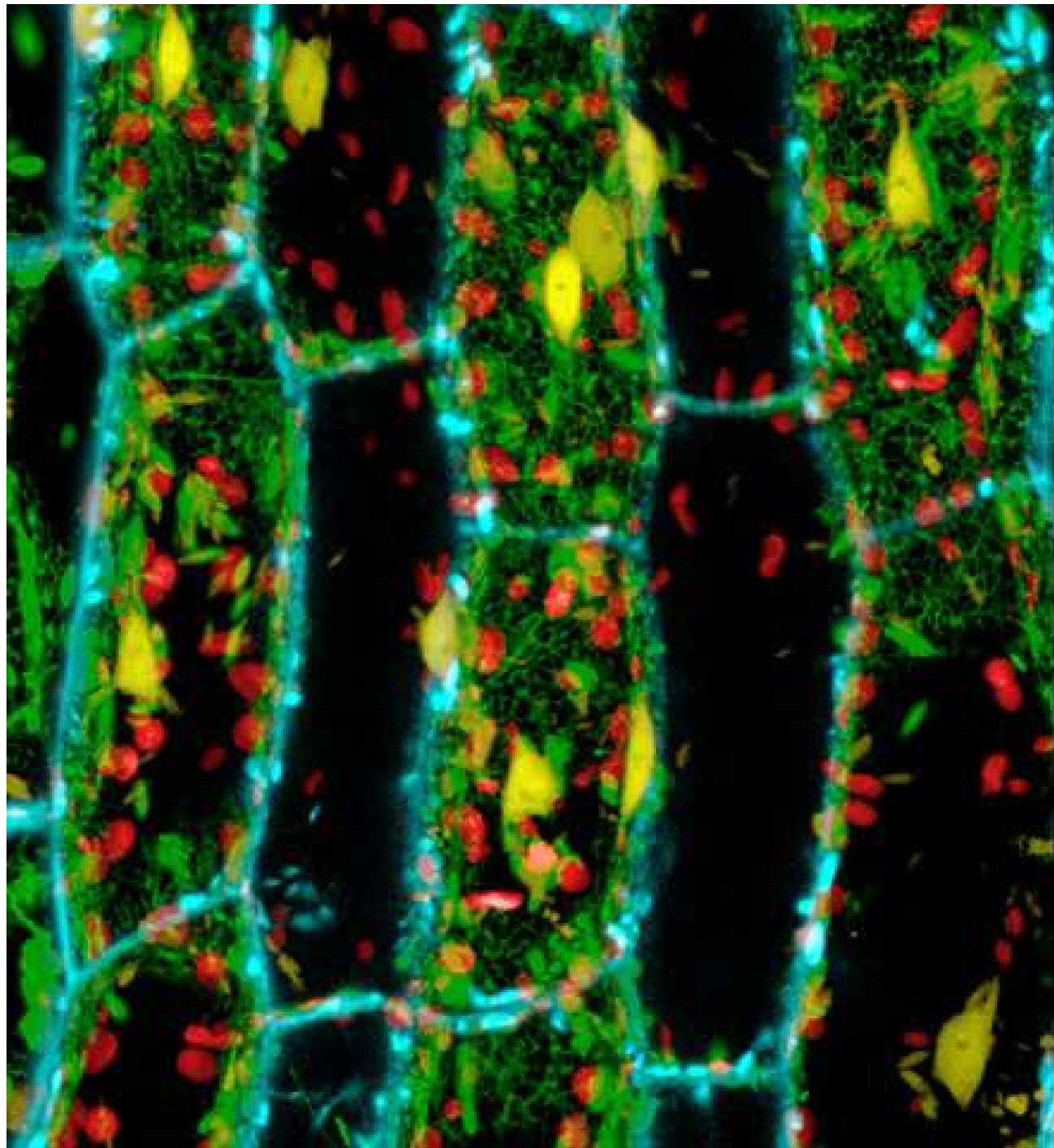

***Multi-spectral
Imaging with:***

***Extensin-CFP
GFP-ER
Histone2b-YFP
Chloroplasts***

Cell identity markers

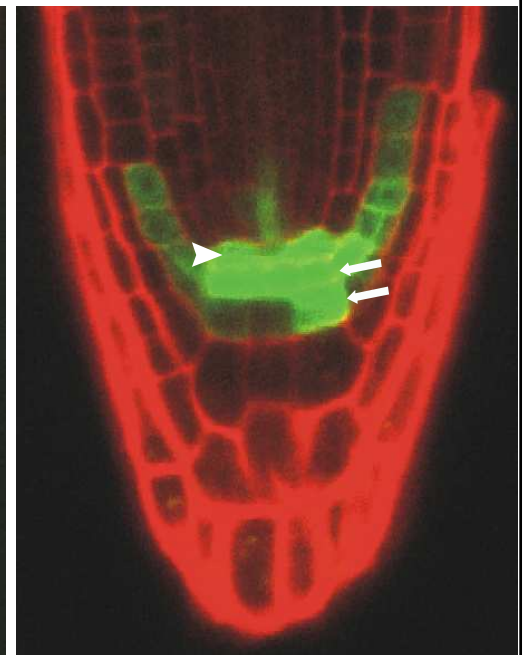
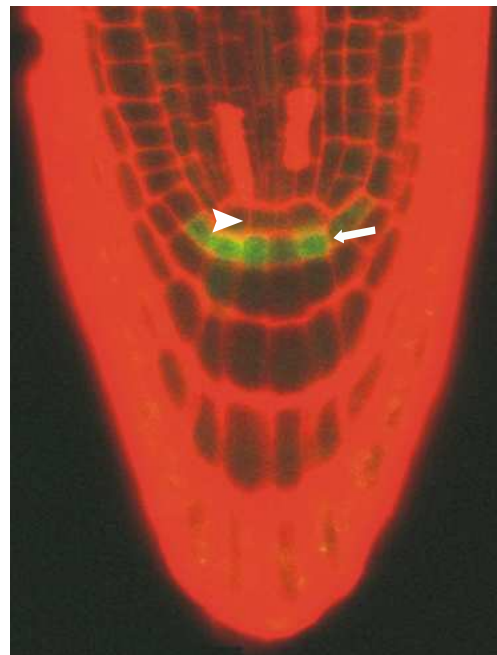
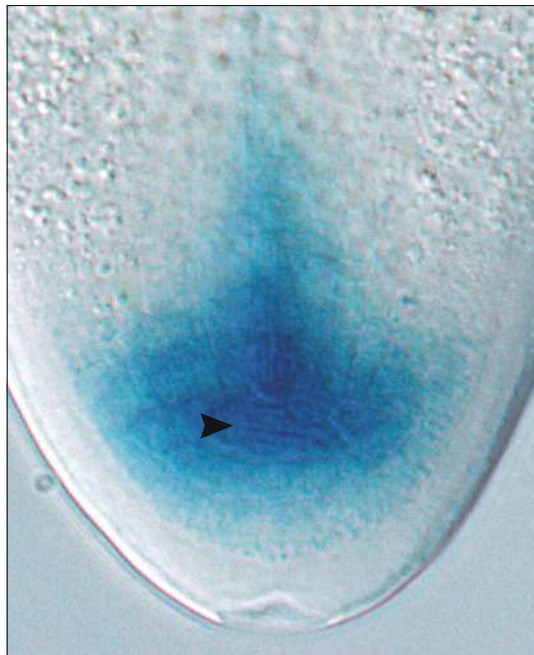
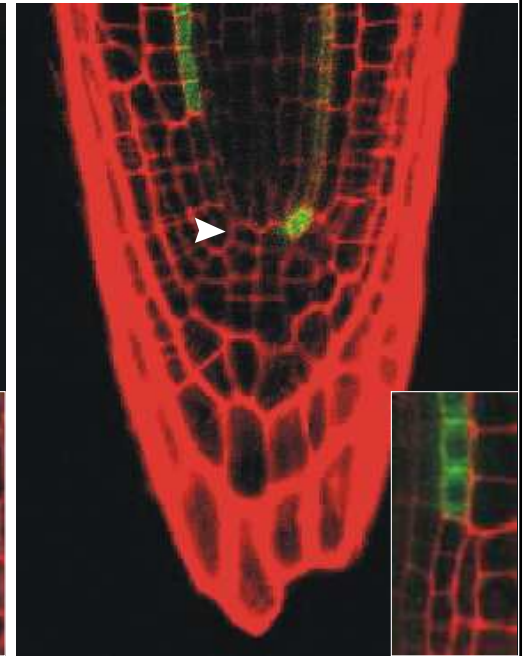
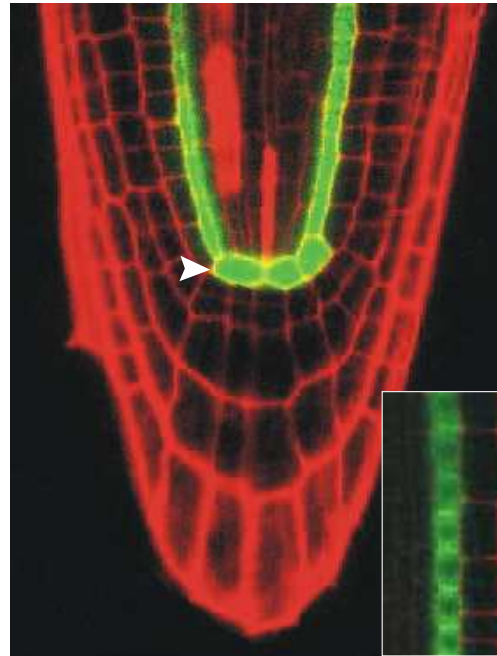
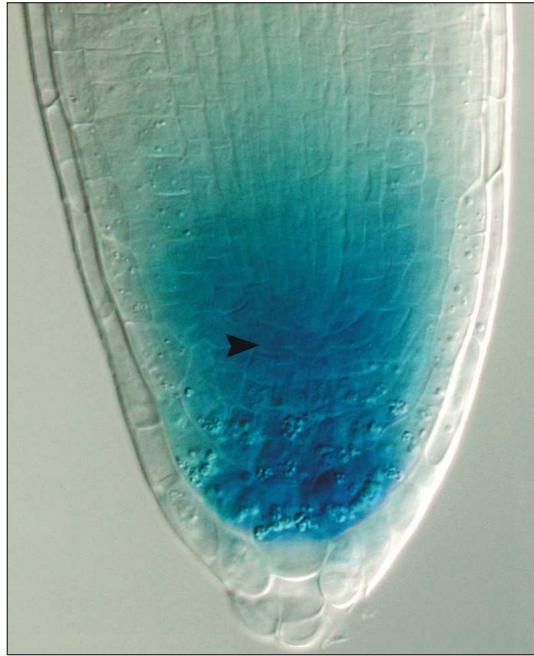
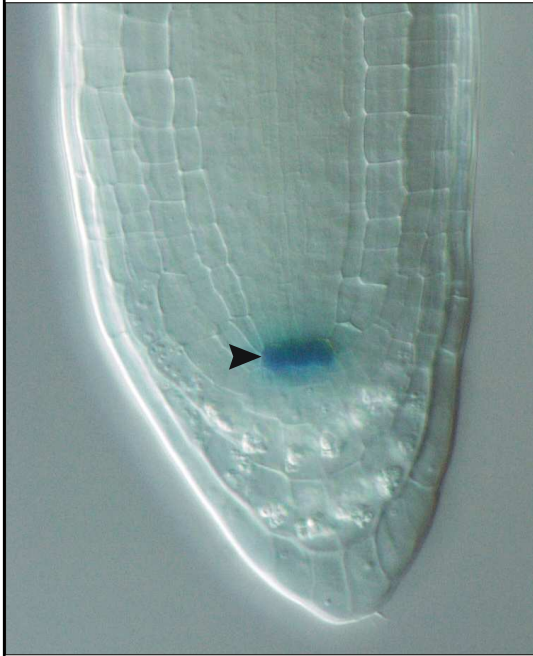

Subcellular structure markers

Actin

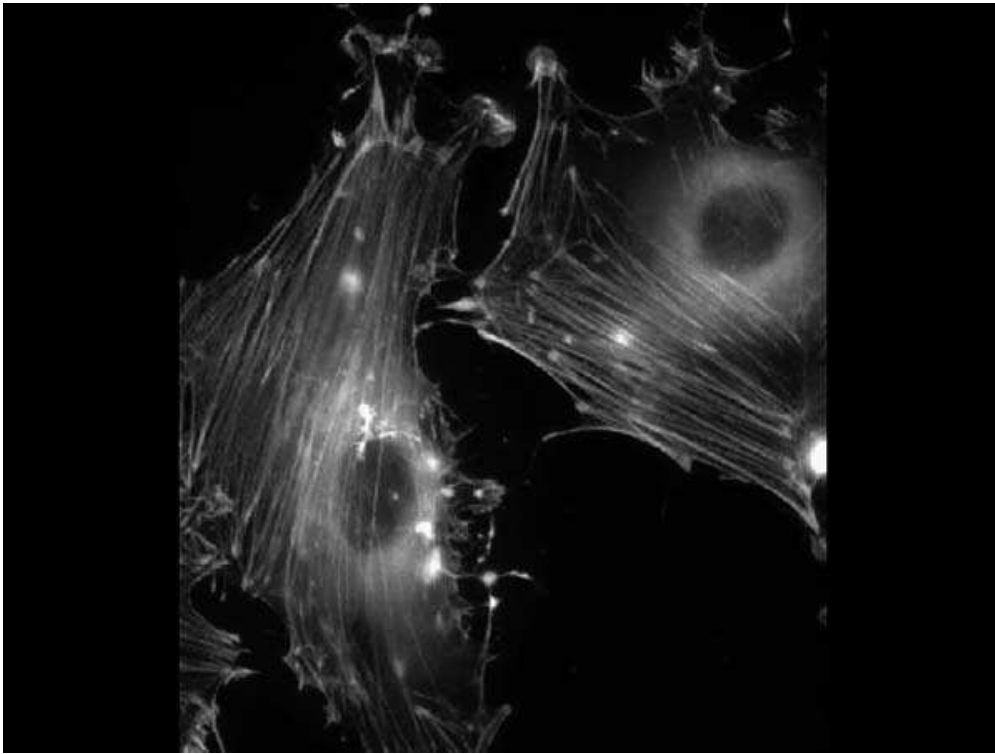

Tubulin

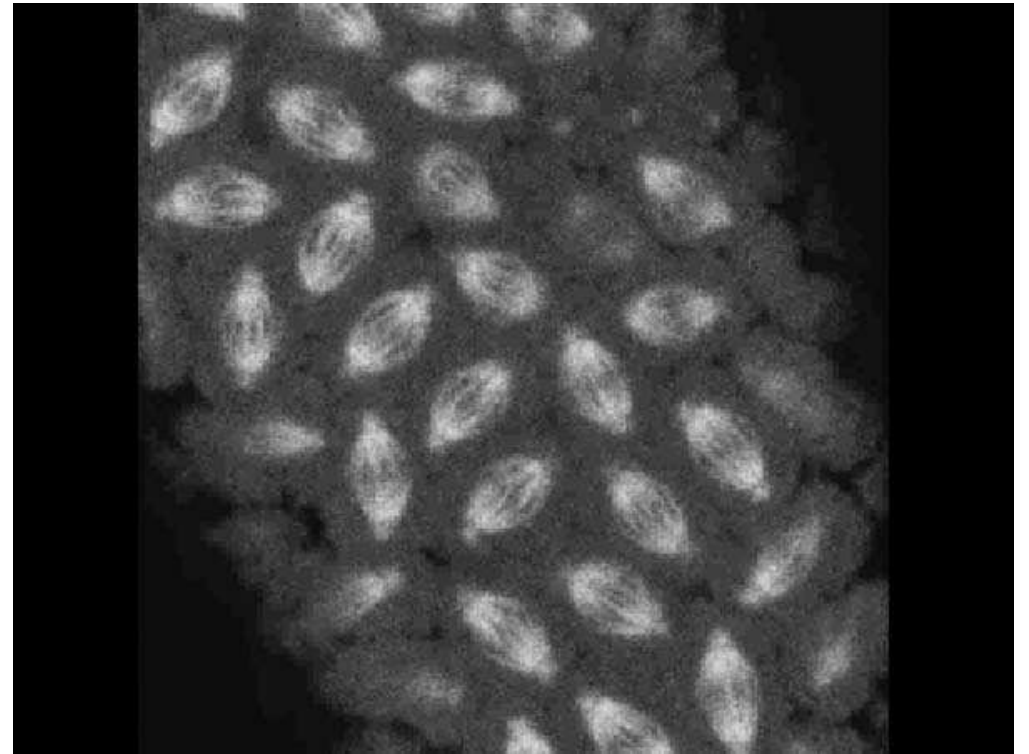

In situ mRNA/protein localisation

- Probe preparation
- Fixation
- Embedding
- Sectioning
- Deparaffinization
- Treatment with probe
- Removal of unbound probe
- Signal visualization

Analysis of gene expression

GUS

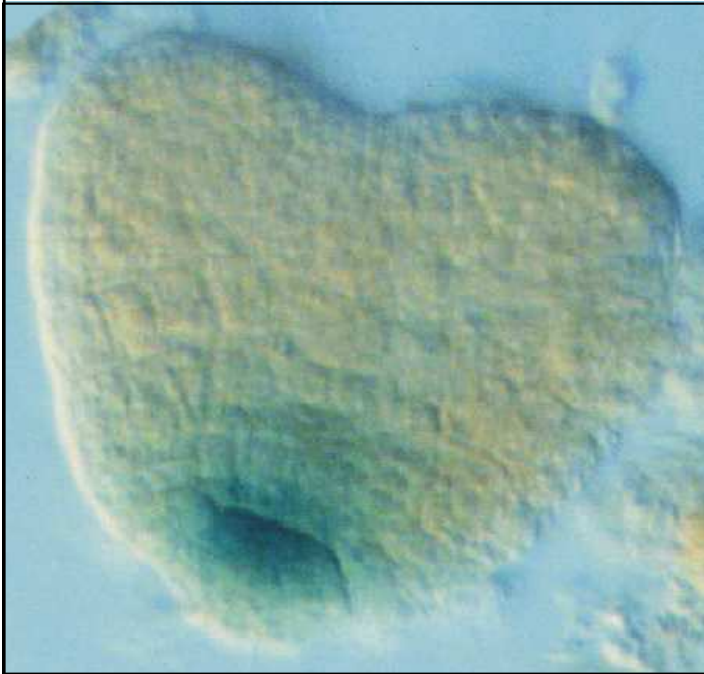

mRNA



Protein

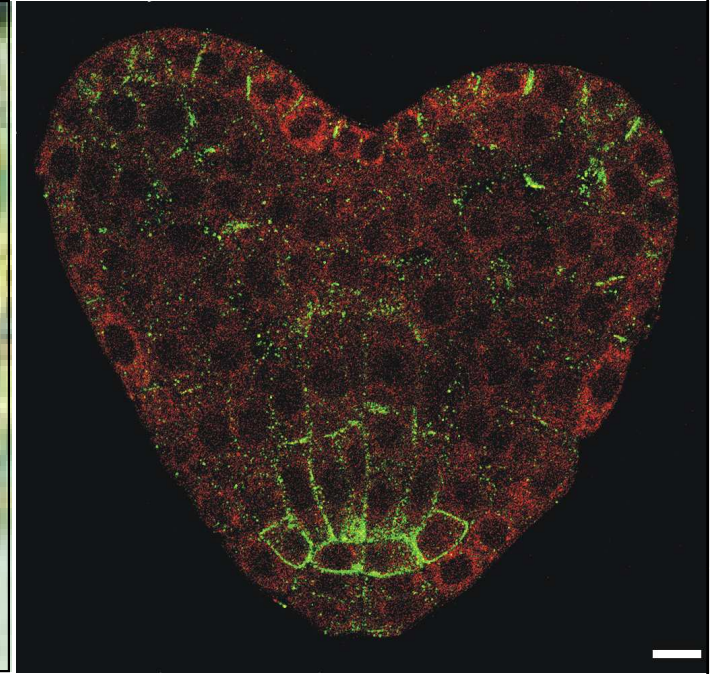

Analysis of protein localisation

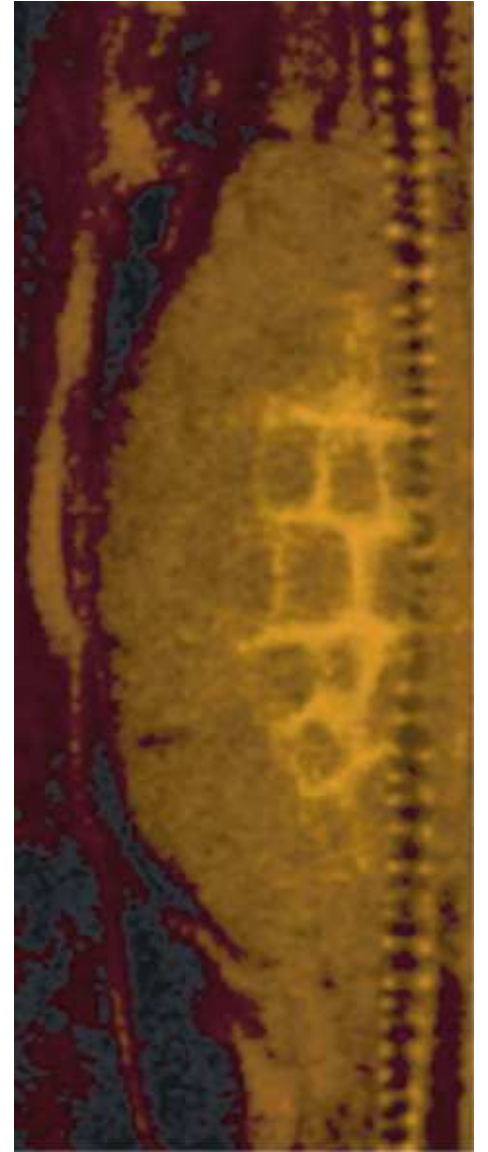
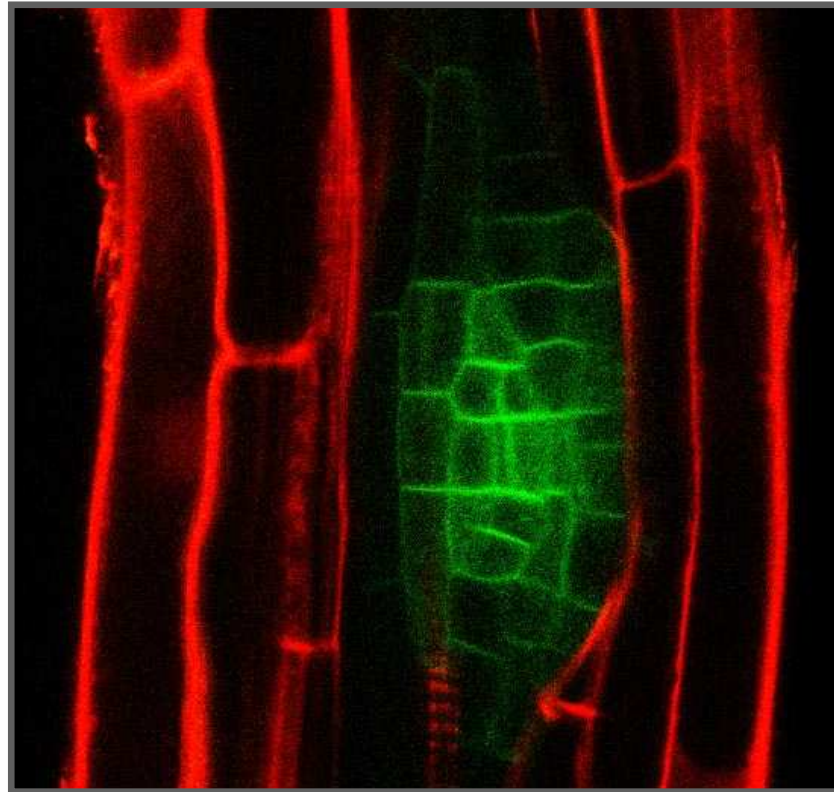
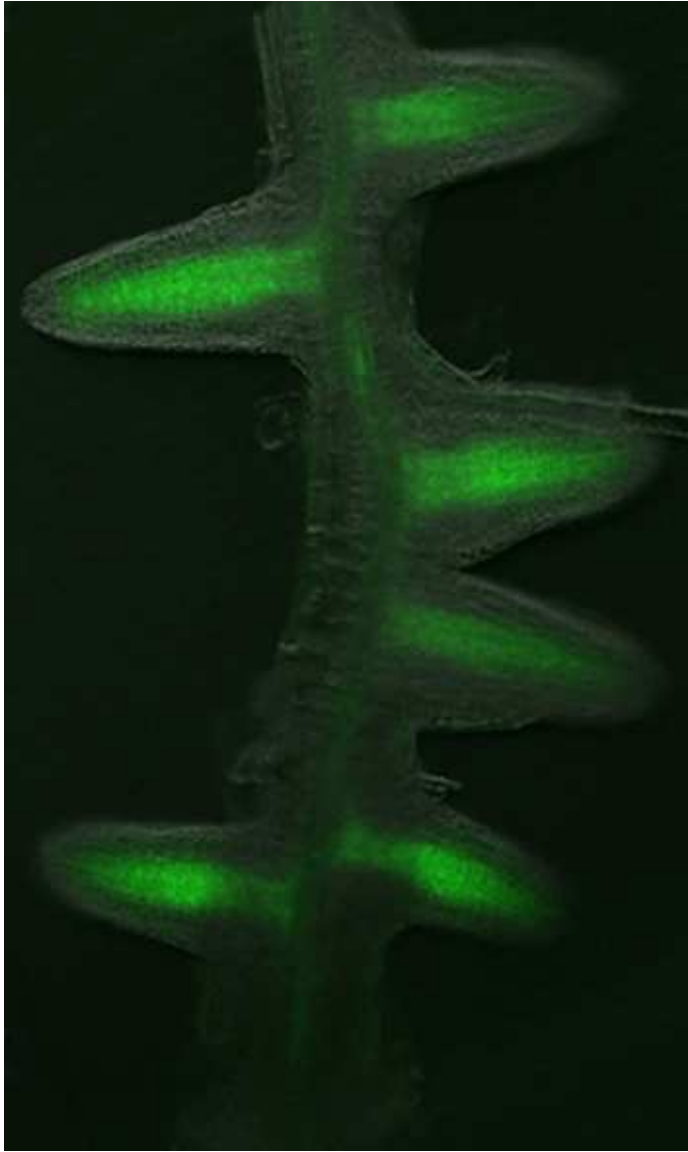

Friends and associates

- Yeast-two-hybrid
- Split ubiquitin, split YFP
- Genetic interactions
- Upstream and downstream

Yeast two hybrid

Classical transcription factor

1. DNA Binding domain
2. Activation domain

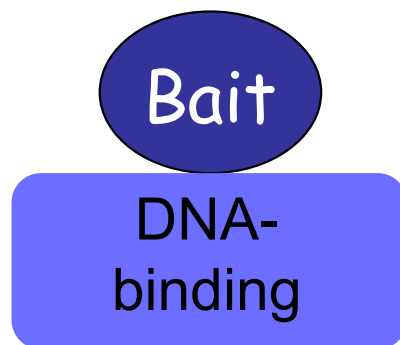

lexA Protein

+

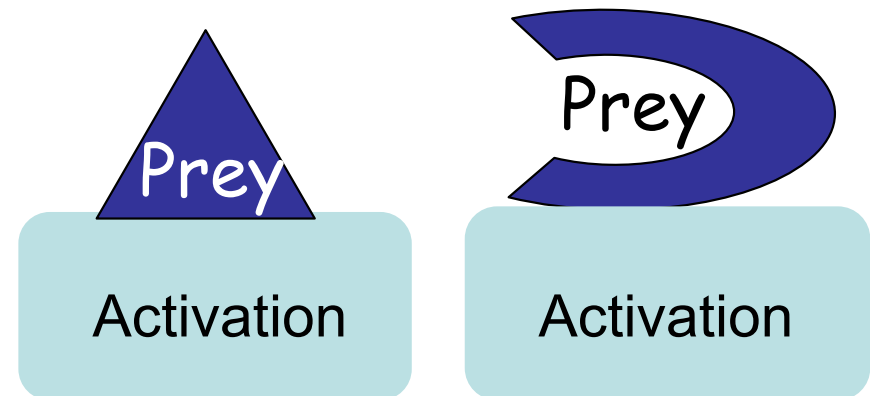

VP16 Protein

Summary for Y2H

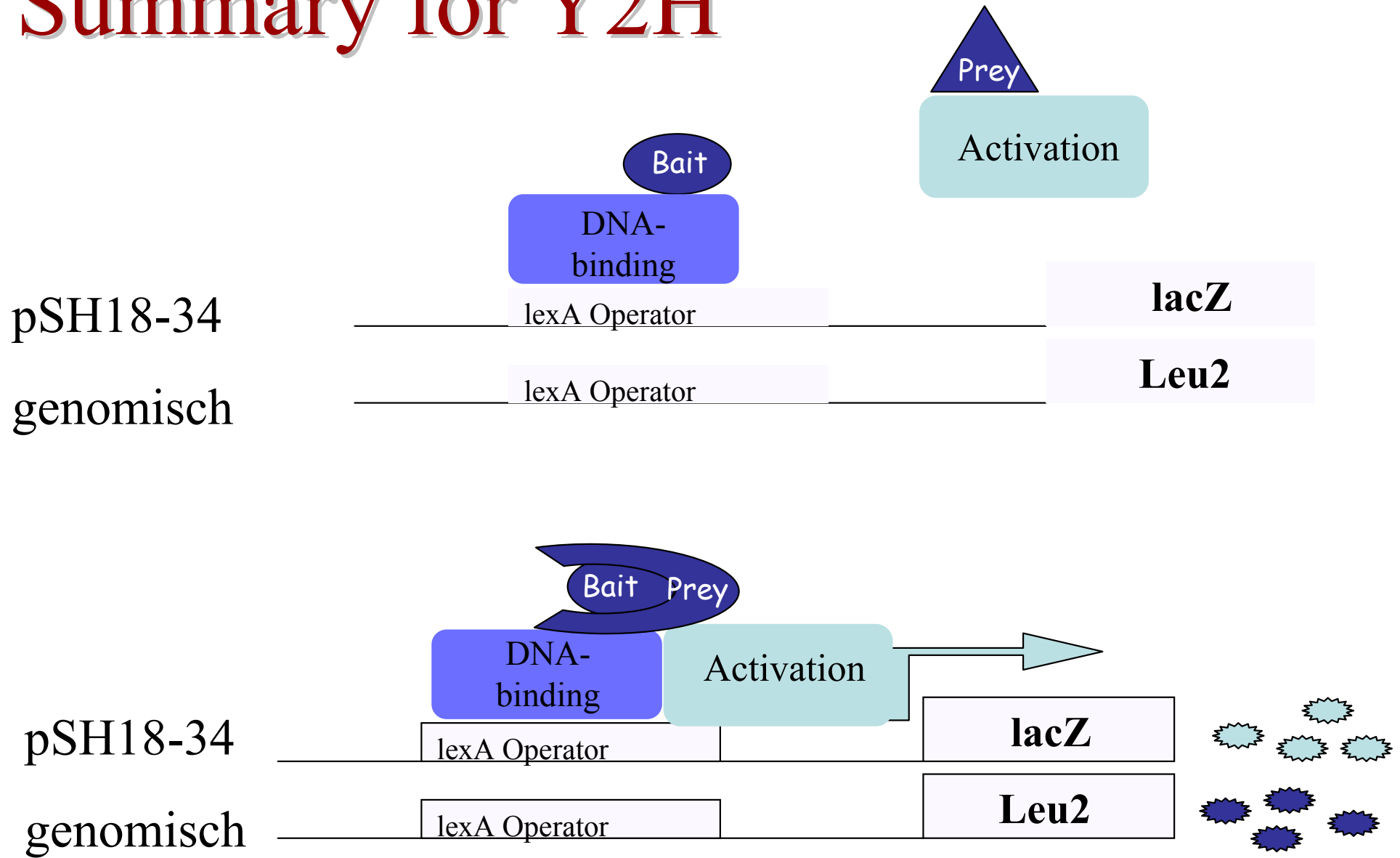

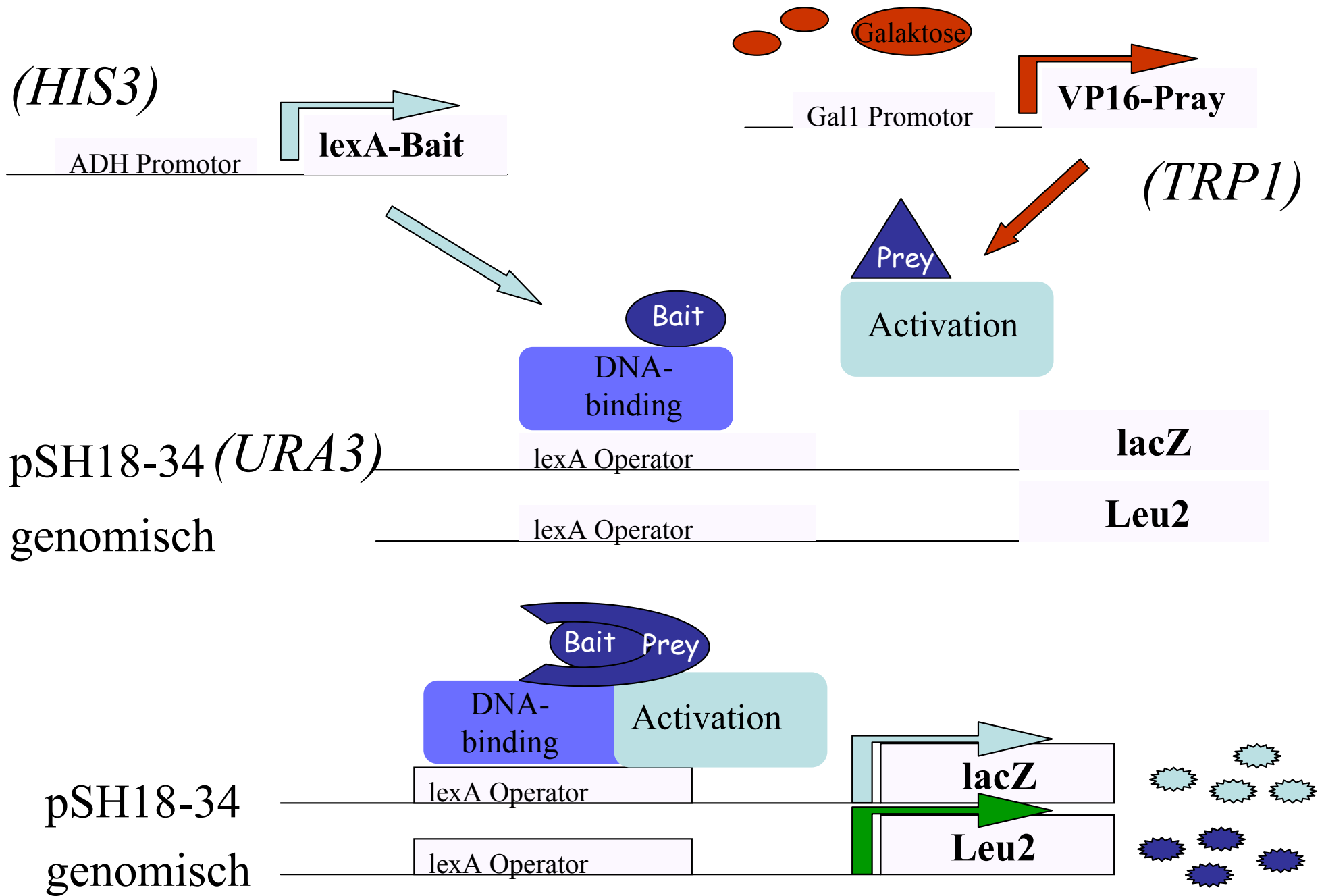

EGY48: Mutant for *HIS3*, *TRP1*, *URA3* und *LEU2*

Conditions for Y2H-System

1. Proteins must be able to localize to the nucleus
2. Bait construct must not have its own activation domain (Autoactivation)

In vitro Pulldown-Assay

GST-Cyp5 and GST-GNOM₁₋₂₄₆ bind GNOM from *Arabidopsis* protein extract

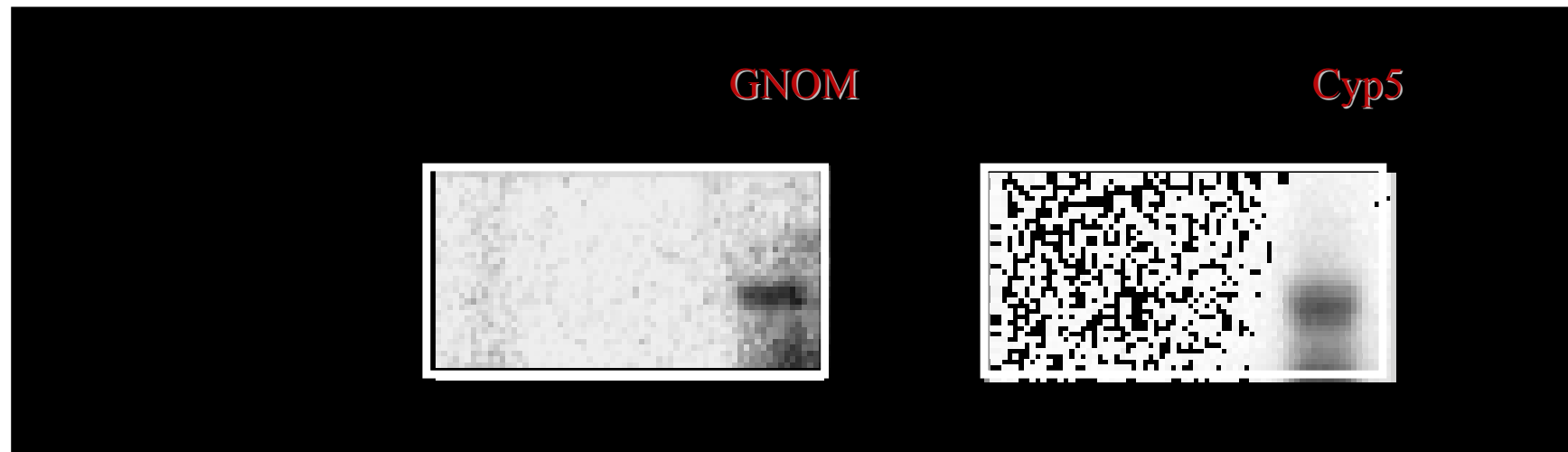

Interaction of GNOM *in vivo*

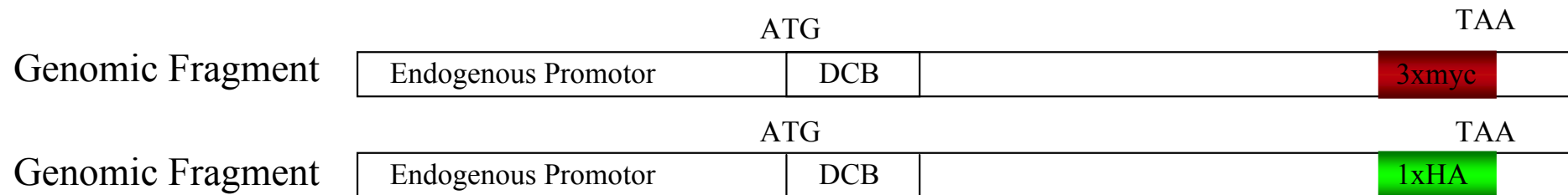

Immunoprecipitation with anti-myc beads

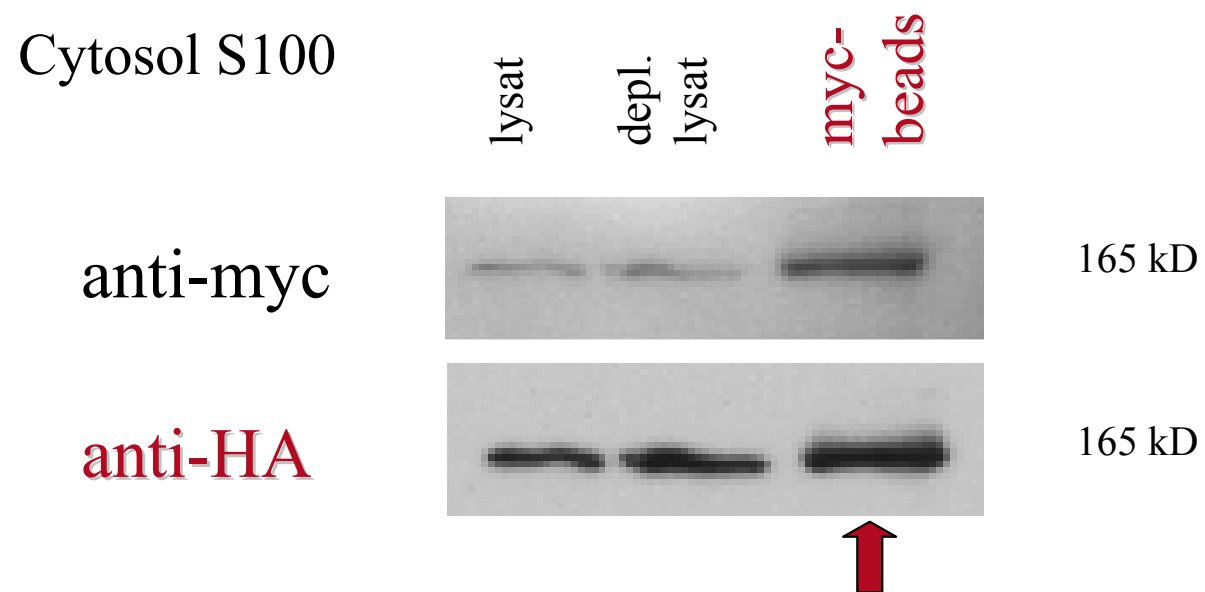

Split-Ubiquitin

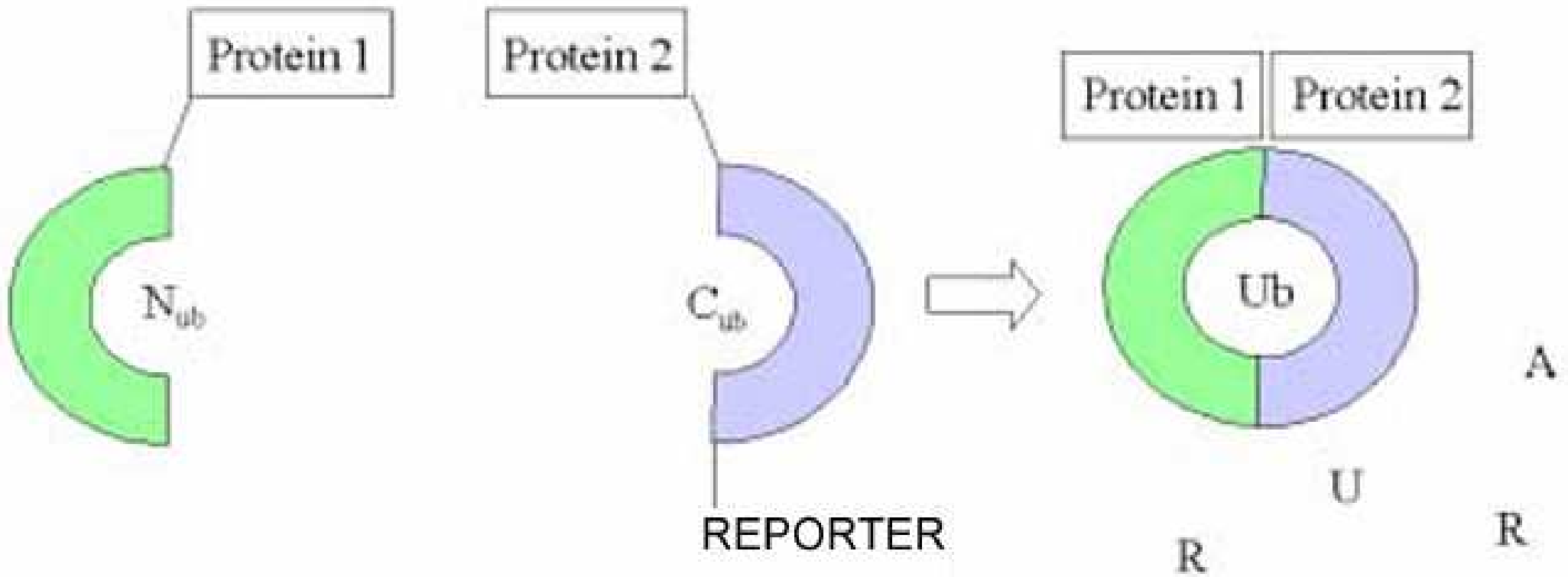

Split-YFP

- Protoplast transfection

Genetic interactions

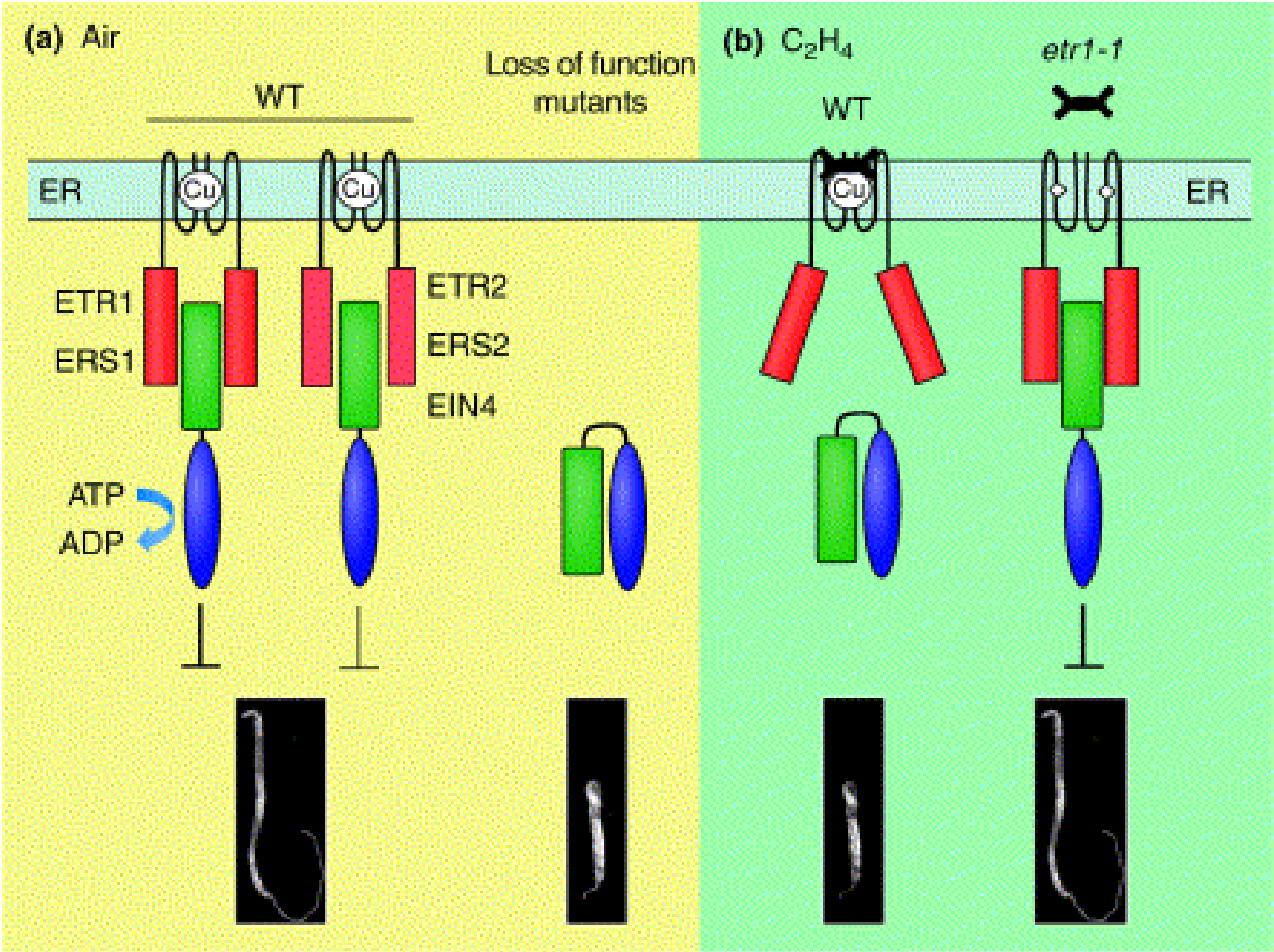

Upstream - Promotor analysis (yeast one hybrid)

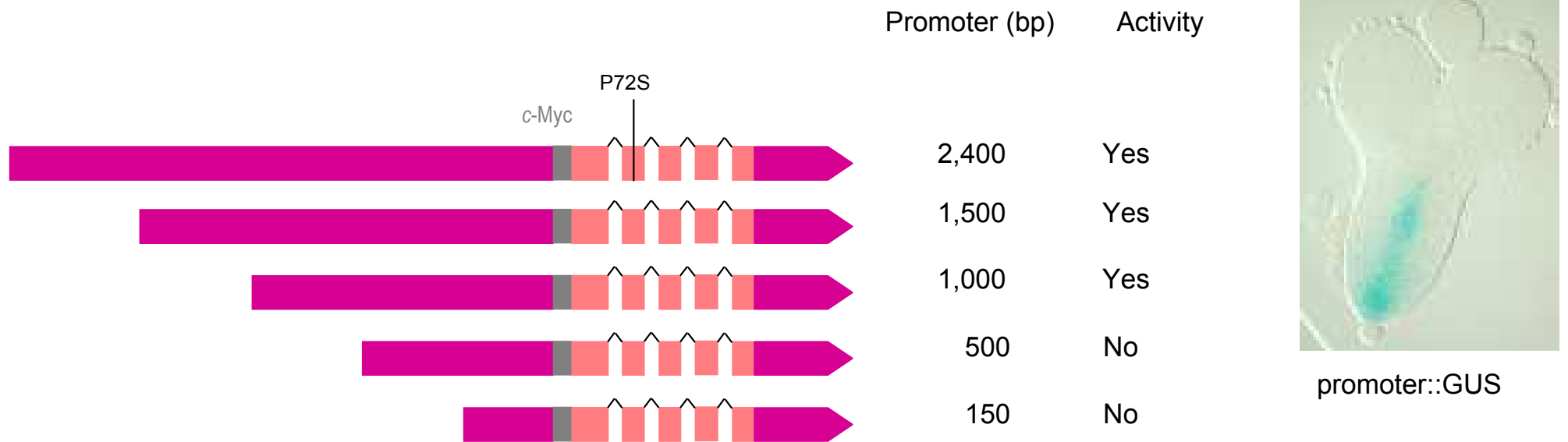

Promotor analysis

– yeast one hybrid

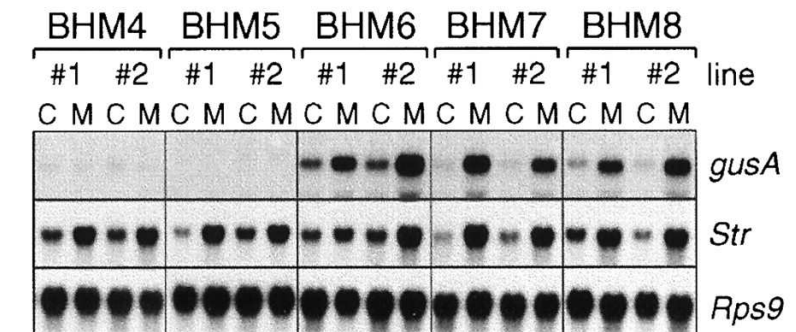
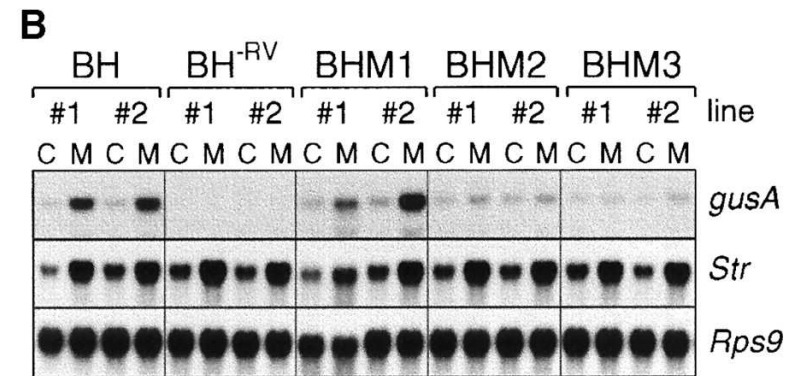
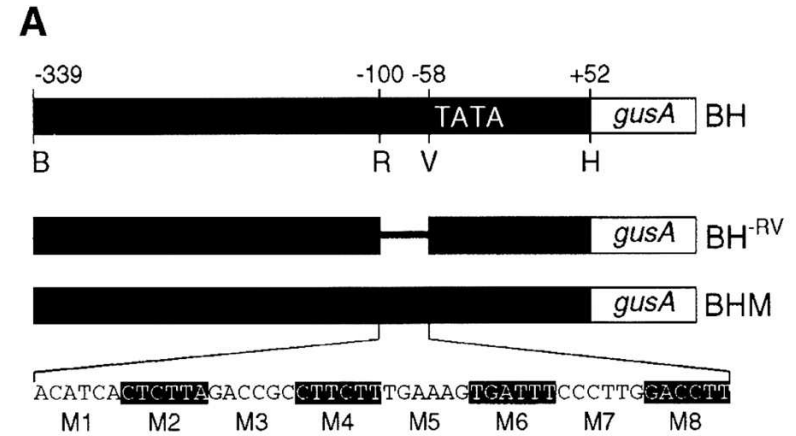
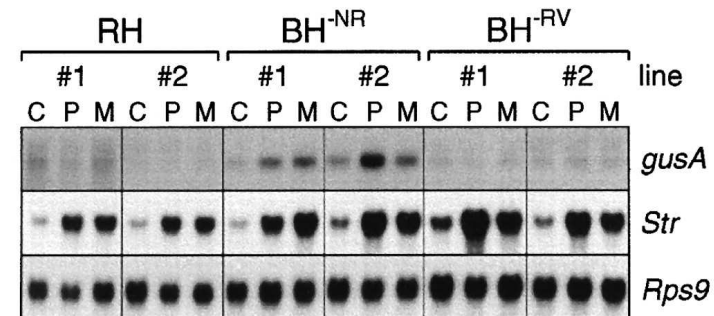
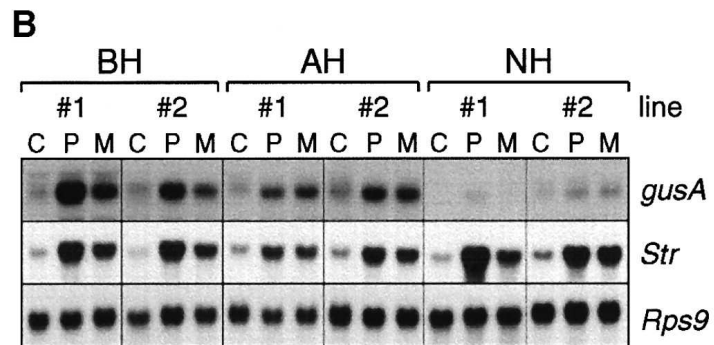
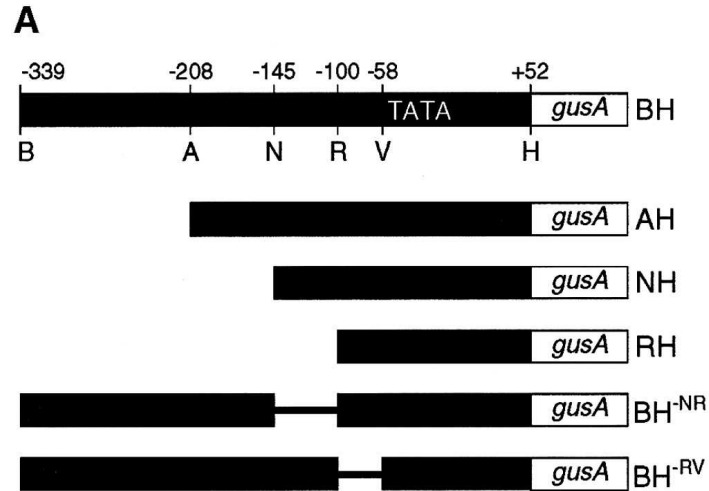

Downstream targets

- expression profiling
- proteomics
- second site mutagenesis
- educated guess

Special methods and tools

- DR5 auxin response reporter
- Transient transfection
- Laser ablations and laser capture

DR5 (Auxin) Response Reporter

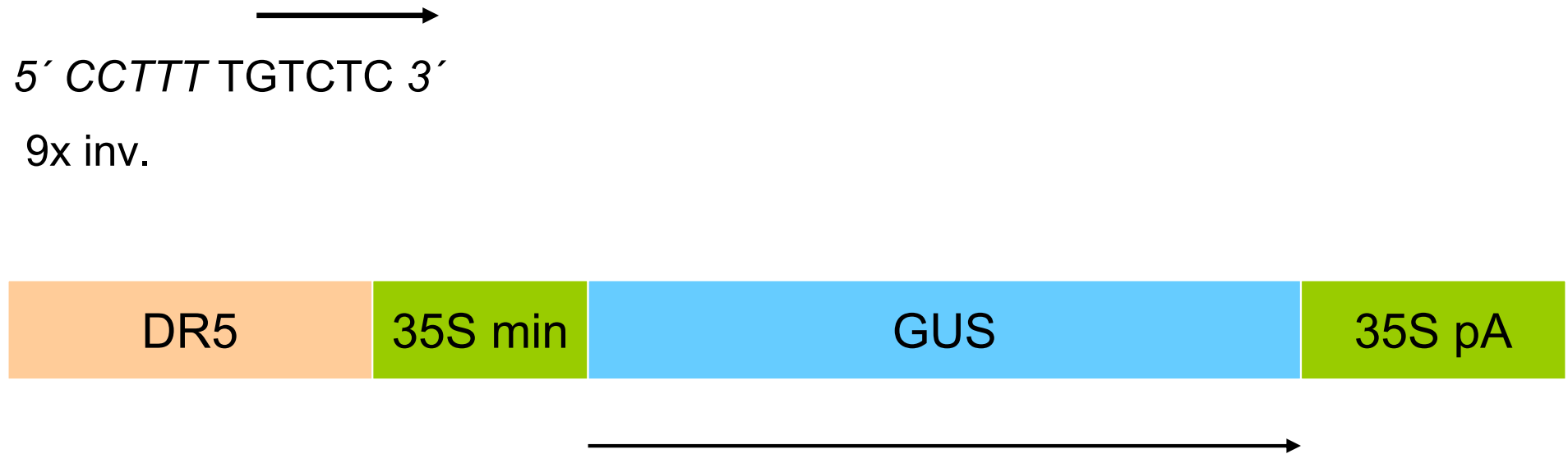

DR5: Ulmasov *et al.*, 1997

DR5::GUS

- Auxin

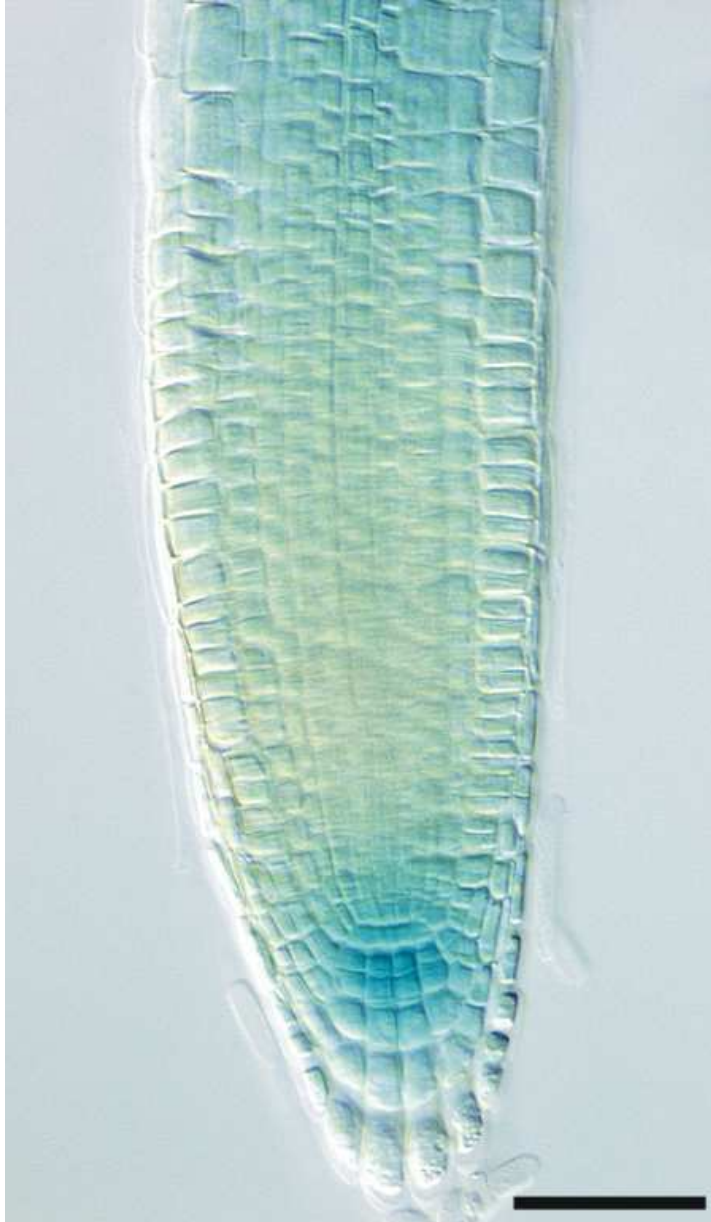

+ Auxin

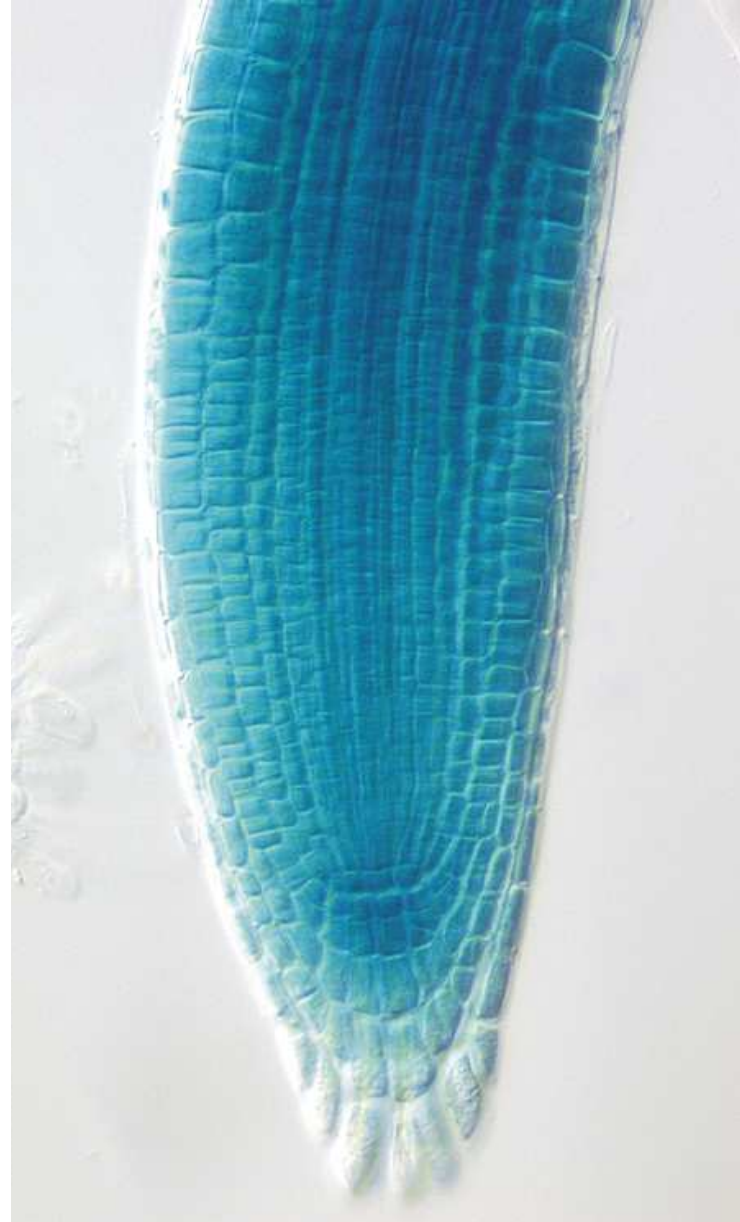

DR5::GFP Auxin Reporter

DR5rev

35S min

GFP

35S pA

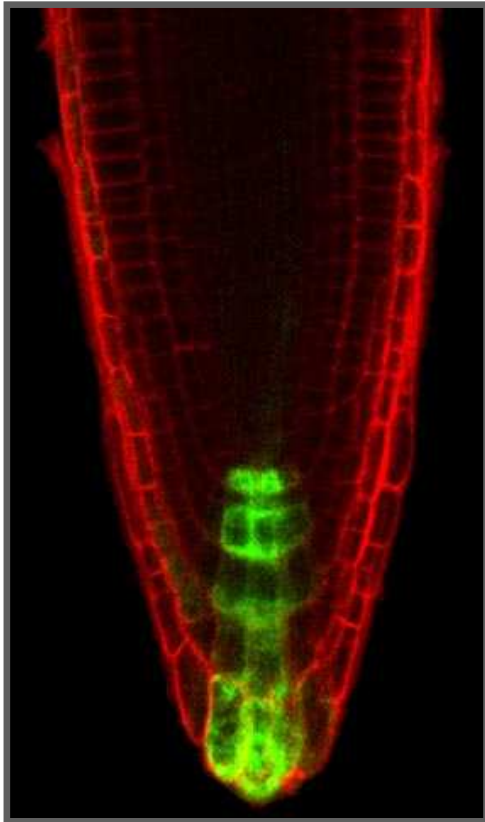

Root

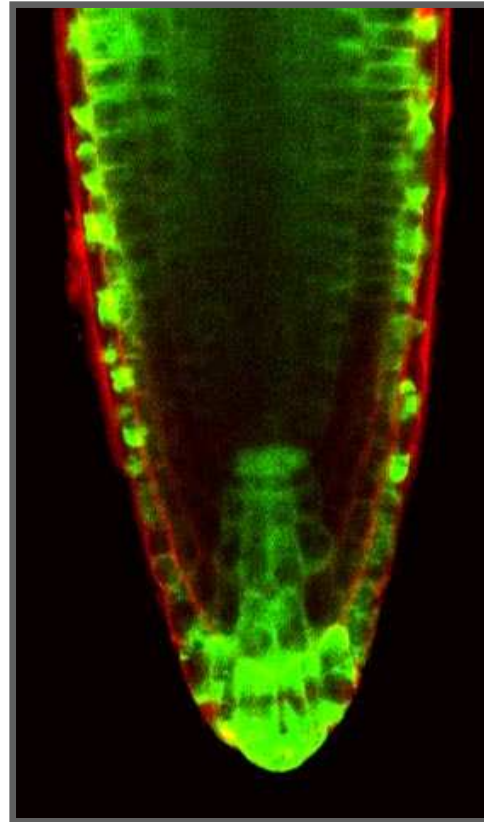

Root + Auxin



anti-IAA AB

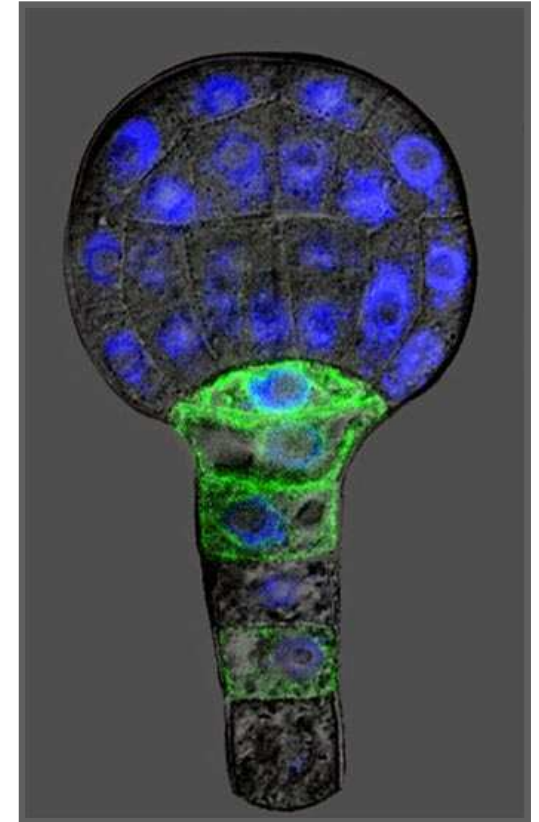

Embryos

Laser ablations

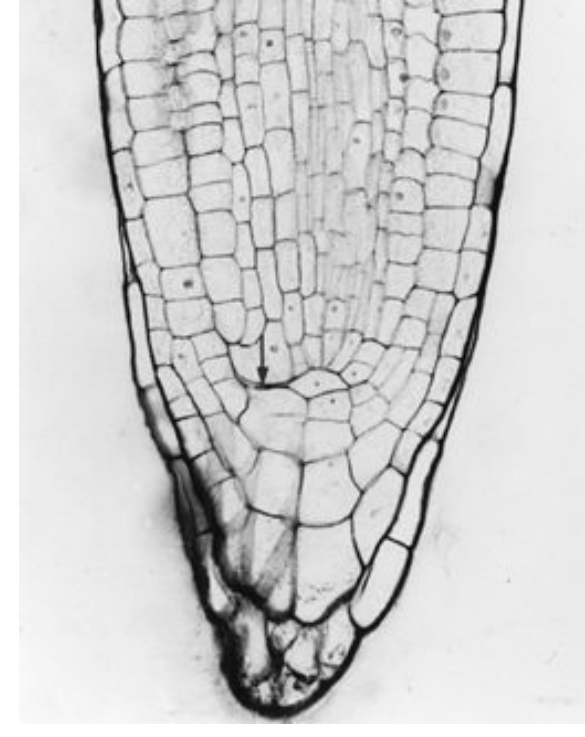
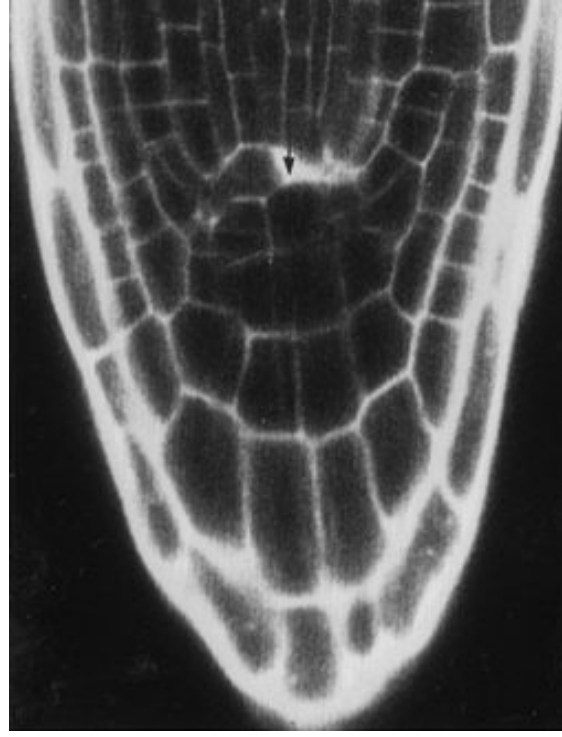
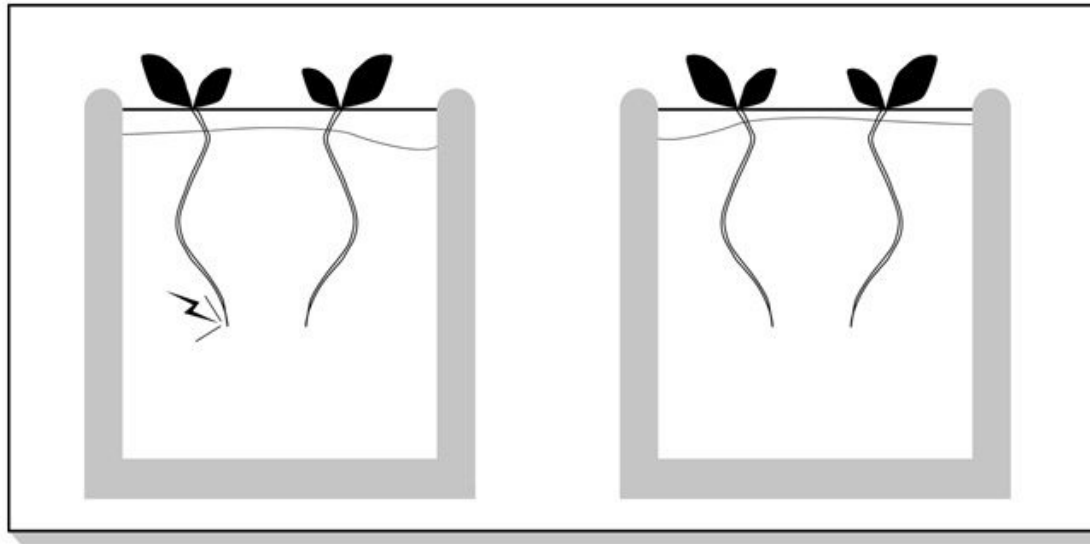

Transient transfection

Confocal imaging of three fluorescent proteins

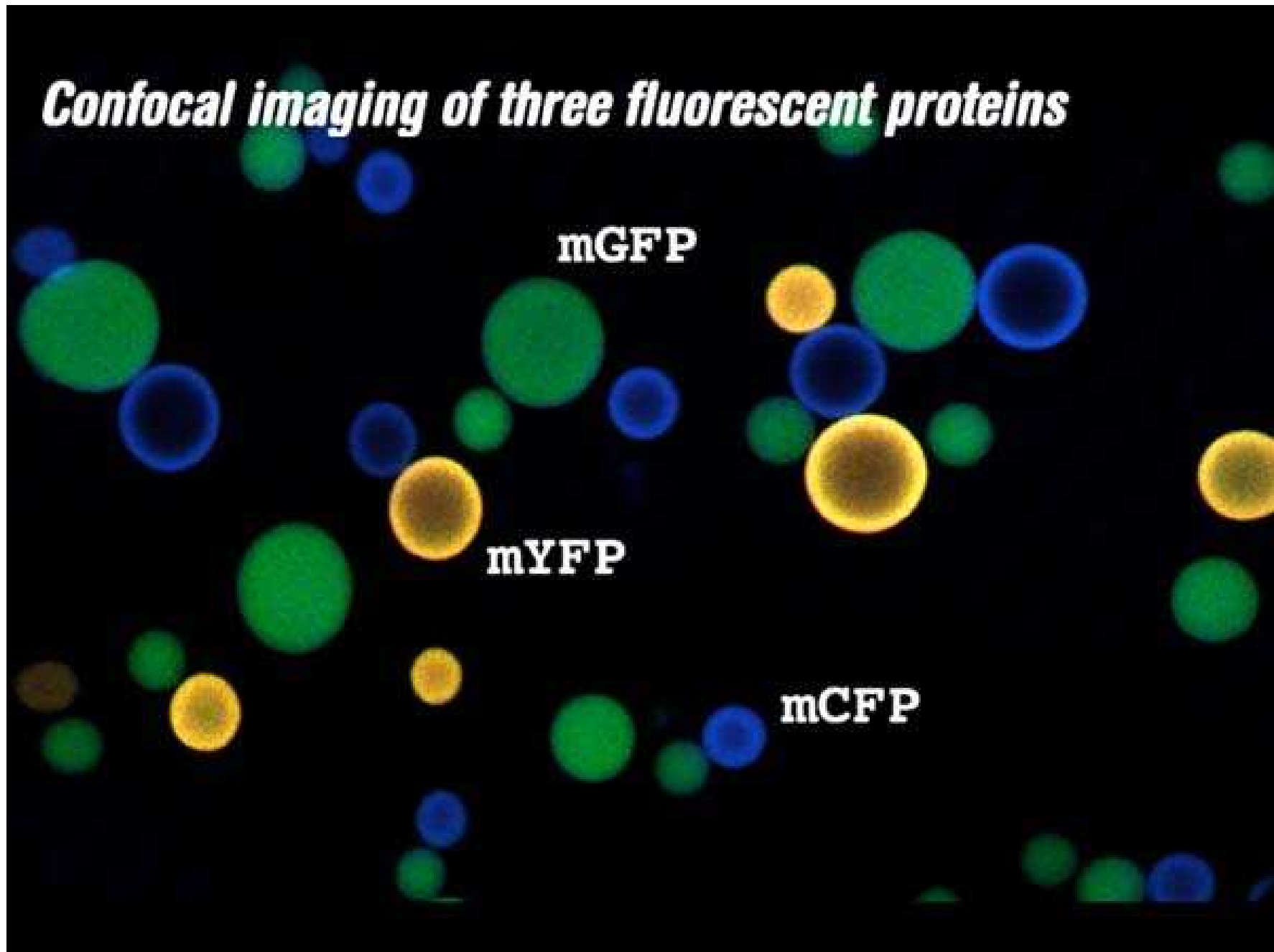

Protoplasts

Onion epidermis cells

C

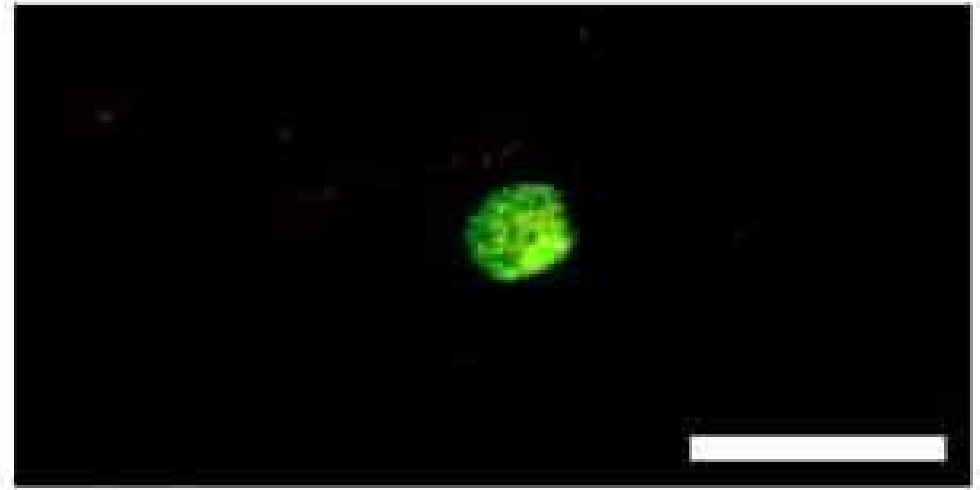

D

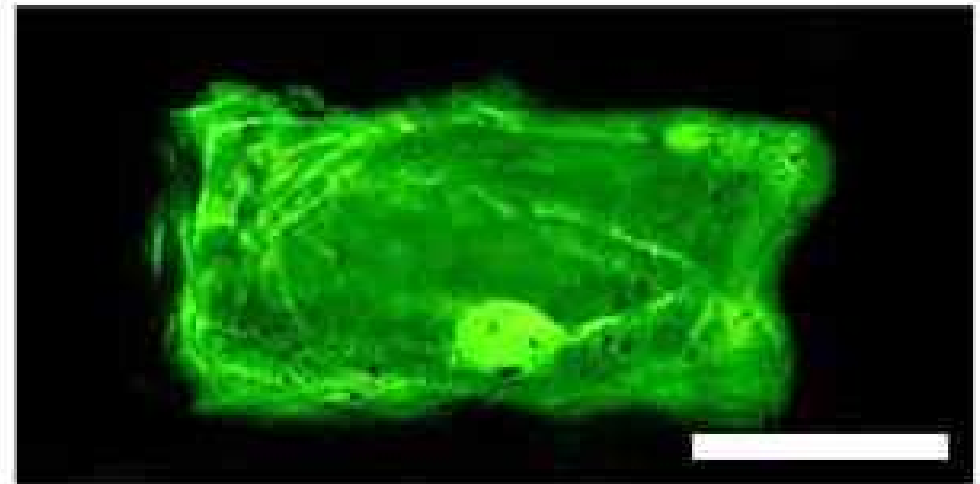

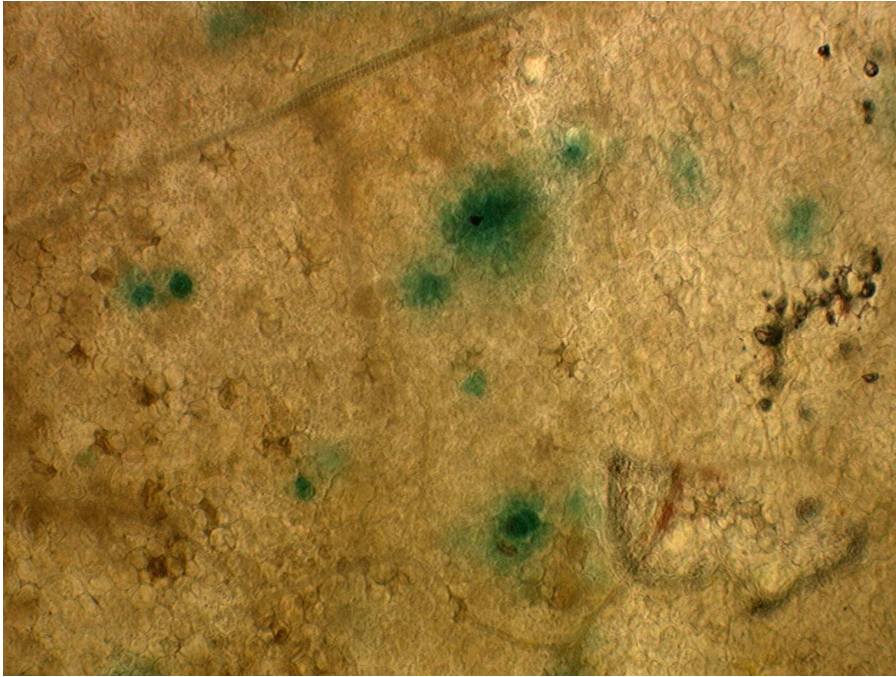

GUS

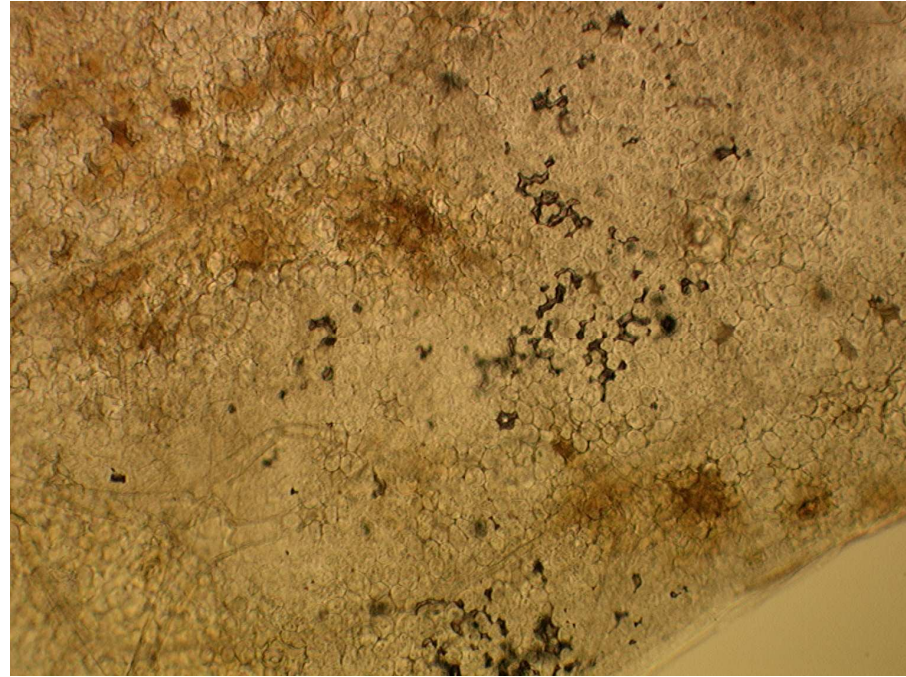

GUS + Diphtheria Toxin

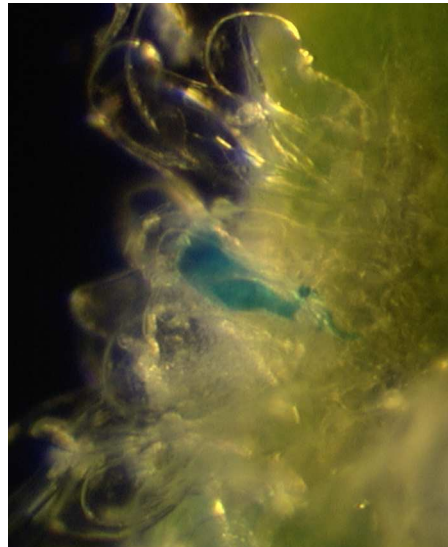

GUS + IPT (cytokinin biosynthesis)

Laser capture

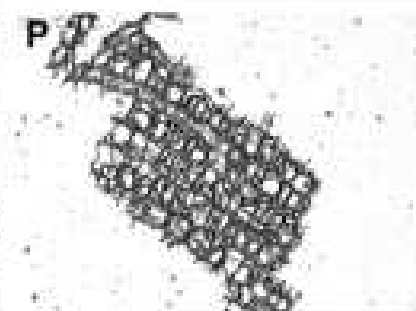
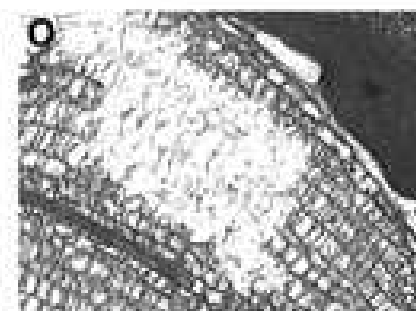
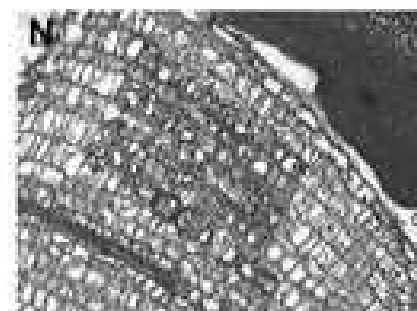
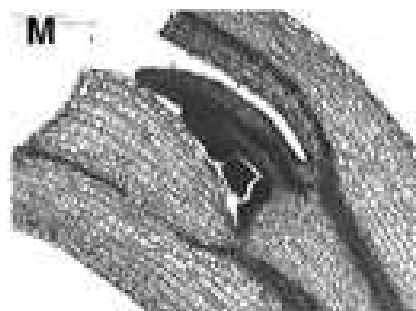
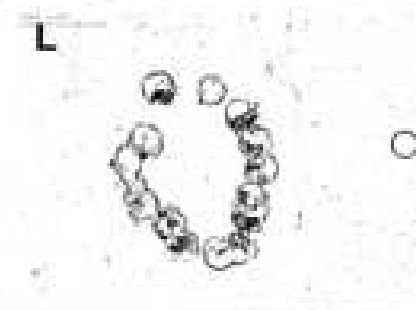
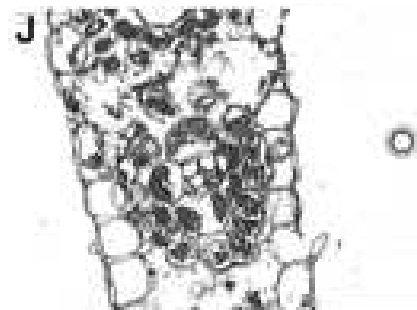
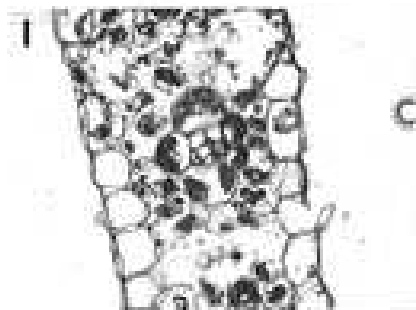
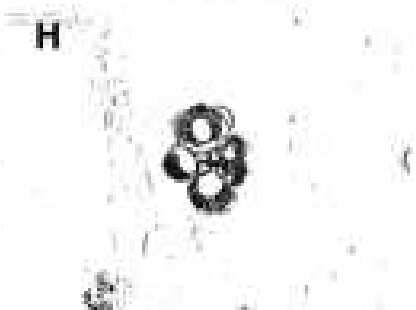
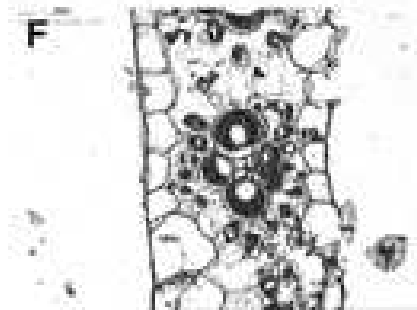
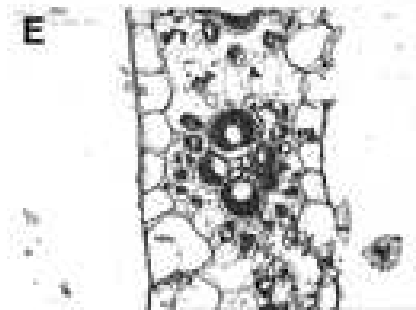
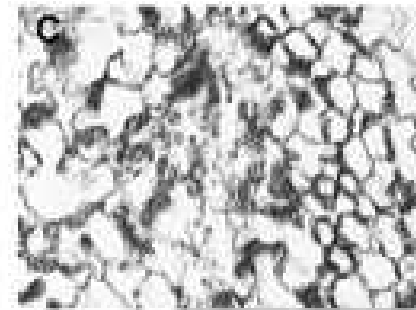
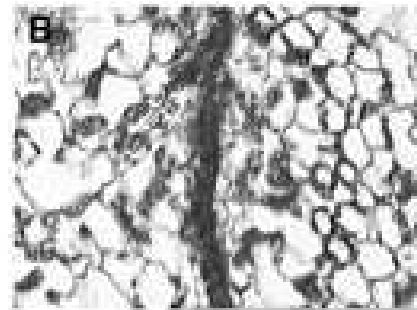
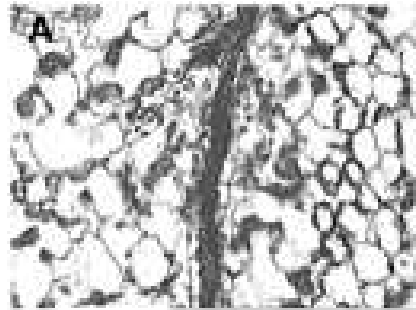

Reconstitution of signaling pathway

