

Fyziologie působení farmak a toxických látek

Přednáška č.6

Jaderné receptory (ER, AR, PR, GR, TR, RAR/RXR, PPAR) a jejich ligandy.

JADERNÉ RECEPTORY

Nuclear Hormone Receptors

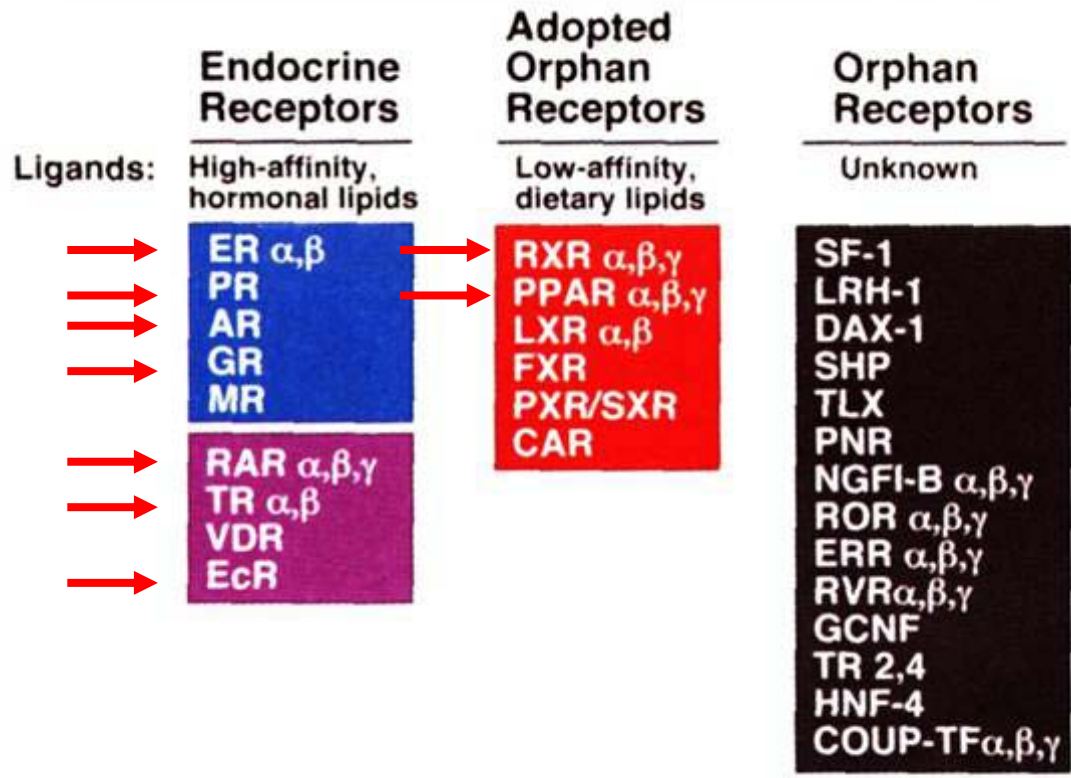
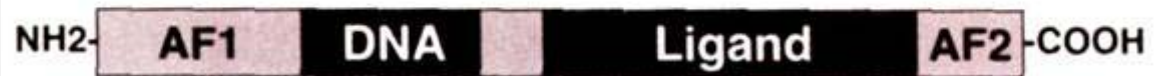
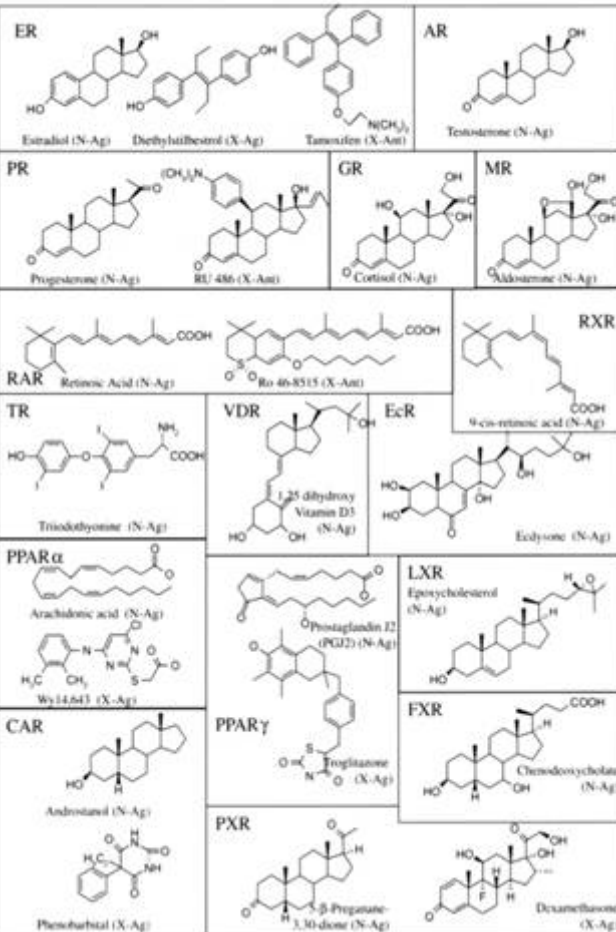

The nuclear receptors comprise the largest family of metazoan transcription regulators. These proteins share an architecture that includes a poorly conserved amino-terminal domain, a highly conserved **DNA-binding domain (DBD)**, a connecting hinge region and a discrete **ligand-binding domain (LBD)**. Their ligands include the sex steroids (estrogen, progesterone and testosterone), as well as related molecules such as glucocorticoids, mineralocorticoids, bile acids and oxysterols, and more diverse ligands such as vitamin D3, thyroid hormone and retinoids.

Jaderné receptory a enzymy:

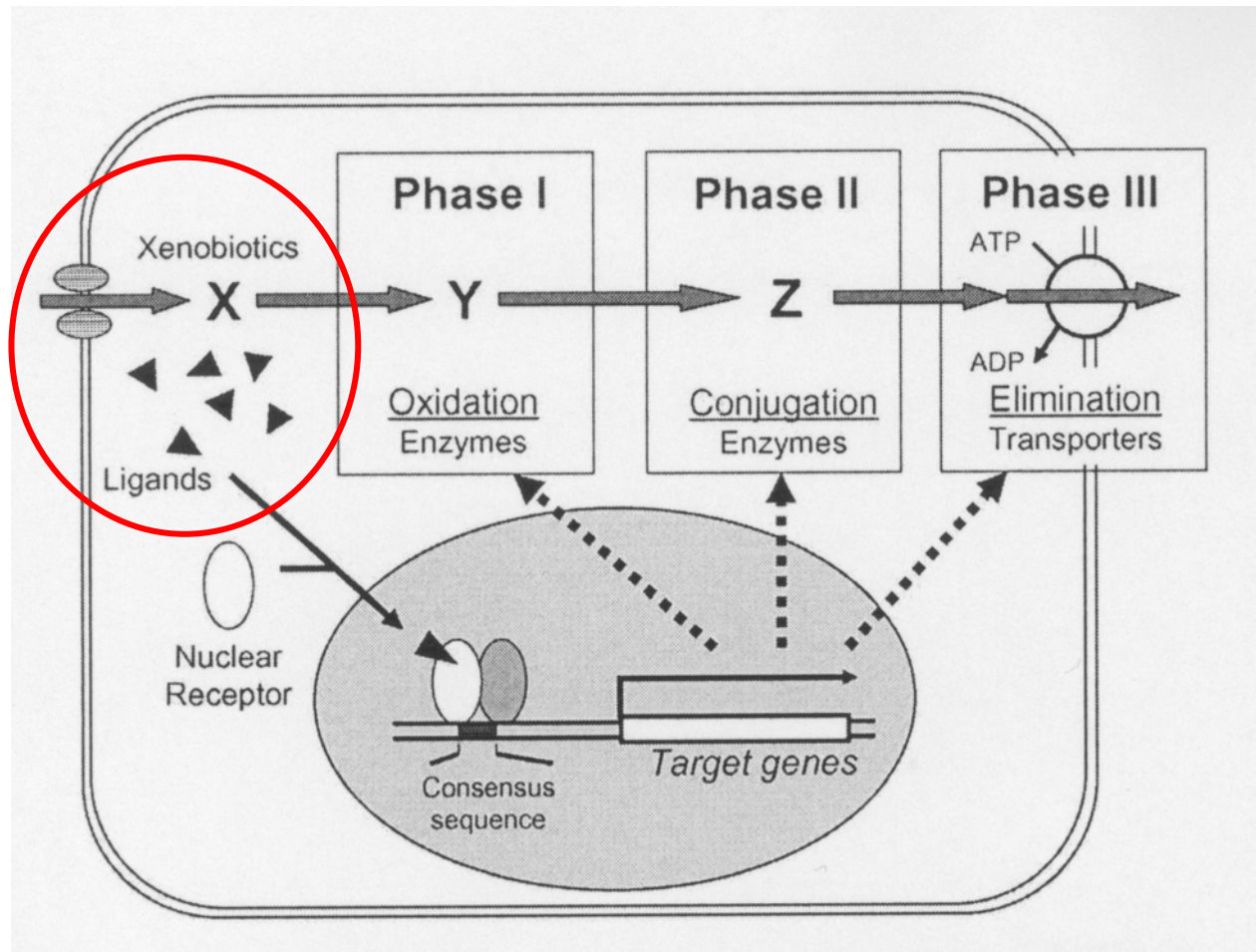

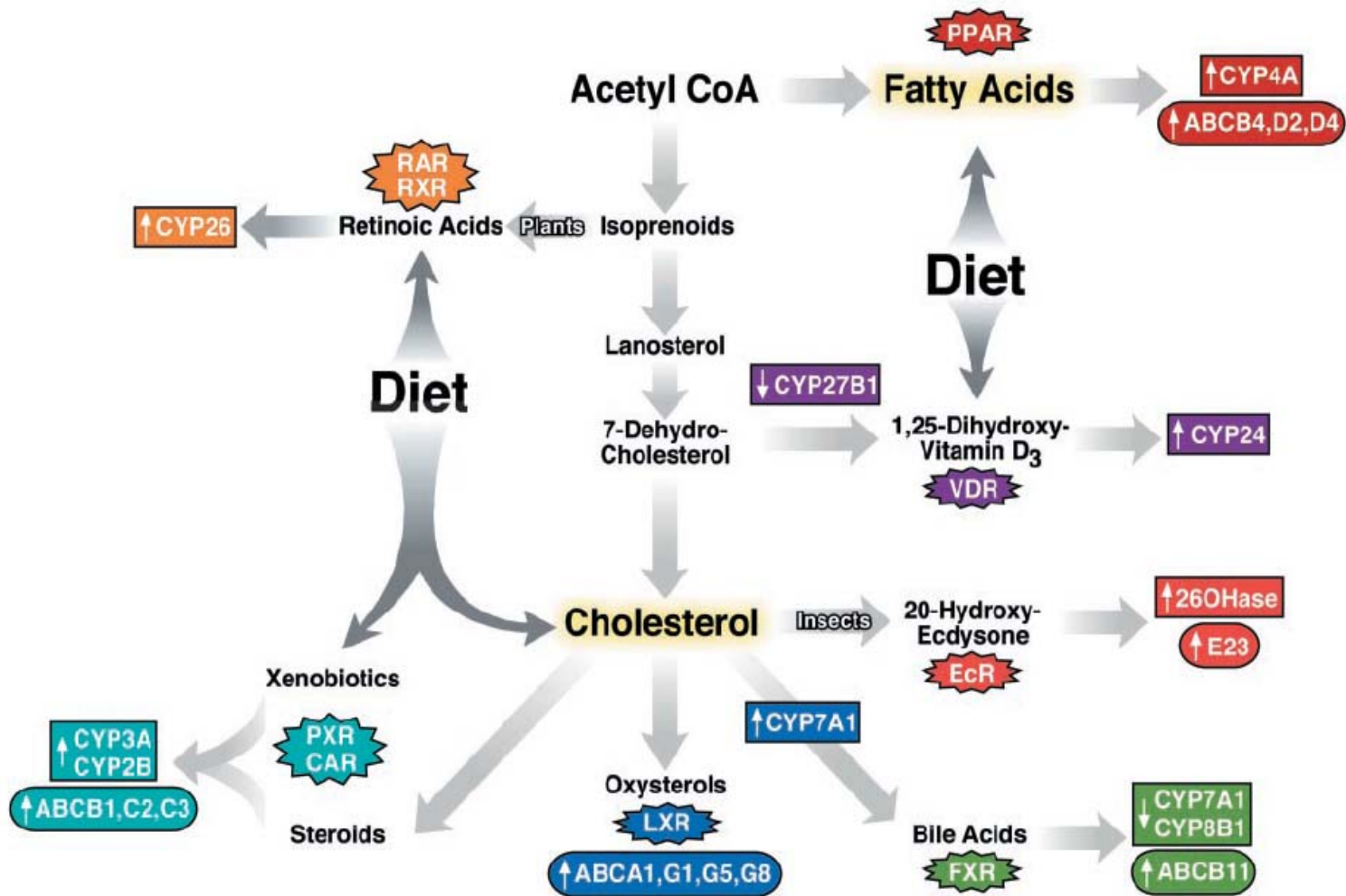

Metabolic pathways for the acquisition and elimination of nuclear receptor ligands. With the exception of thyroid hormones and some xenobiotics, all nuclear receptor ligands are derived from the biosynthetic pathways that generate cholesterol and fatty acids from acetyl coenzyme A (Acetyl CoA). Ligands (or their lipid precursors) for the RXR heterodimer receptors are also acquired from the diet

Feedback and interactions:

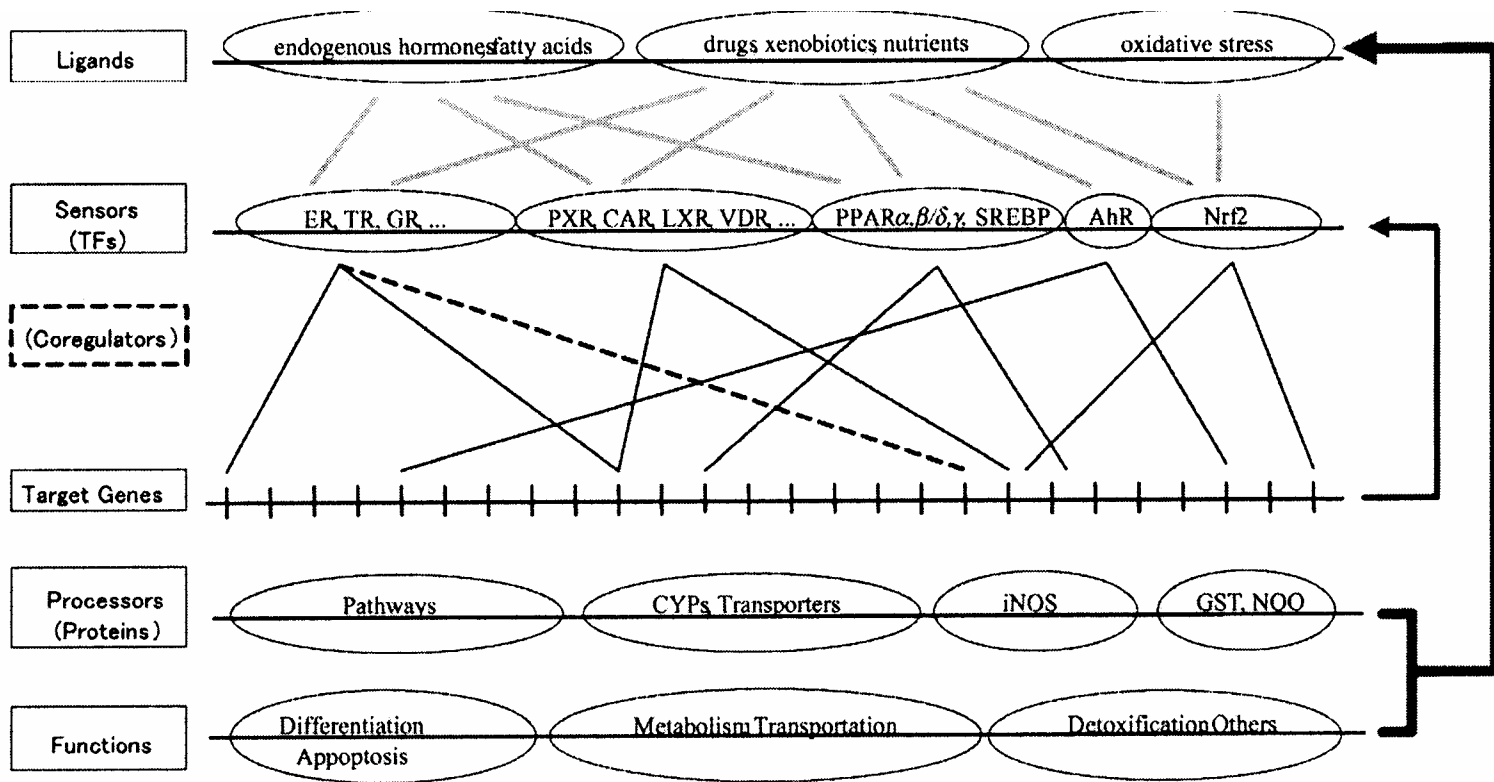

Fig. 5. Schematic diagram of overall xenobiotic responsive systems. iNOS: inducible nitric oxide synthase, GST: glutathione S-transferase NQO: NAD(P)H:quinone oxidoreductase

ers (Phase III).

Ligand	NR	Response element	Target gene		
			Phase I	Phase II	Phase III
Xenobiotics	AhR	XRE	CYP1A1 (+) CYP1A2 (+) CYP1B1 (+)	UGT1A1 (+) UGT1A6 (+)	ABCG2 (+)
Xenobiotics Phenobarbital	CAR	DR-3, DR-4, DR-5 SR-6, ER-6	CYP2A6 (+) CYP2B1 (+) CYP2B6 (+) CYP2C9 (+) CYP2C19 (+)	UGT1A1 (+)	ABCC2 (+) ABCC3 (+) ABCC4 (+)
Xenobiotics Steroids	SXR/PXR	DR-3, DR-4, DR-5 ER-6, ER-8	CYP1A2 (+) CYP2B6 (+) CYP2C9 (+) CYP2C19 (+) CYP3A4 CYP3A7 CYP7A1 (-) CYP3A (+)	SULT2A1 (+) UGT1A1 (+) UGT1A3 (+) UGT1A4 (+)	ABCA1 (+) ABCB1 (+) ABCB11 (+) ABCC1 (+) ABCC2 (+) ABCC3 (+) ABCG2 (+)
Bile acids	FXR	IR-1 DR-1	CYP7A1 (-) CYP8B1 (-)	UGT2B4 (+) SULT2A1 (+)	ABCB4 (+) ABCB11 (+) ABCC2 (+)
Oxysterols	LXR α , β	DR-4	CYP2B6 (-) CYP3A4 (-)		ABCA1 (+) ABCG1 (+) ABCG4 (+) ABCG5 (+) ABCG8 (+)
Fatty acids Fibrates	PPAR α	DR-1	CYP4A1 (+) CYP4A3 (+) CYP7A	UGT1A9 (+) UGT2B4 (+)	ABCA1 (+) ABCC2 (+) ABCD2 (+) ABCD3 (+)
Fatty acids Carboprostacyclin	PPAR δ		CYP4A (+)	UGT1A (+)	ABCA1 (+)
Eicosanoids Thiazolidinediones	PPAR γ		CYP4AB (+)	UGT1A9 (+)	ABCA1 (+) ABCG2 (+)
Retinoic acids	RAR α , β , γ		CYP2B6 (+)		ABCB1 (+) ABCG4 (+)
1,25(OH) $_2$ - vitamin D $_3$	VDR	DR-3 ER-6 IR-0	CYP2B6 (+) CYP2C9 (+) CYP3A4 (+)	SULT2A1 (+)	ABCC2 (+) ?
Gluco- Corticoid	GR	GRE	CYP2C9 (+) CYP2B6 (+) CYP3A4 (+)		
ROS Electrophiles	Nrf2	ARE		γ -GCS (+) GST (+) NQO1 (+) UGT (+) HO-1 (+)	ABCC1 (+) ? ABCC2 (+) ABCC3 (+) ABCG2 (+) ?

ROS, reactive oxygen species; (+), up-regulation; (-), down-regulation.

Hepatocytes as model cells:

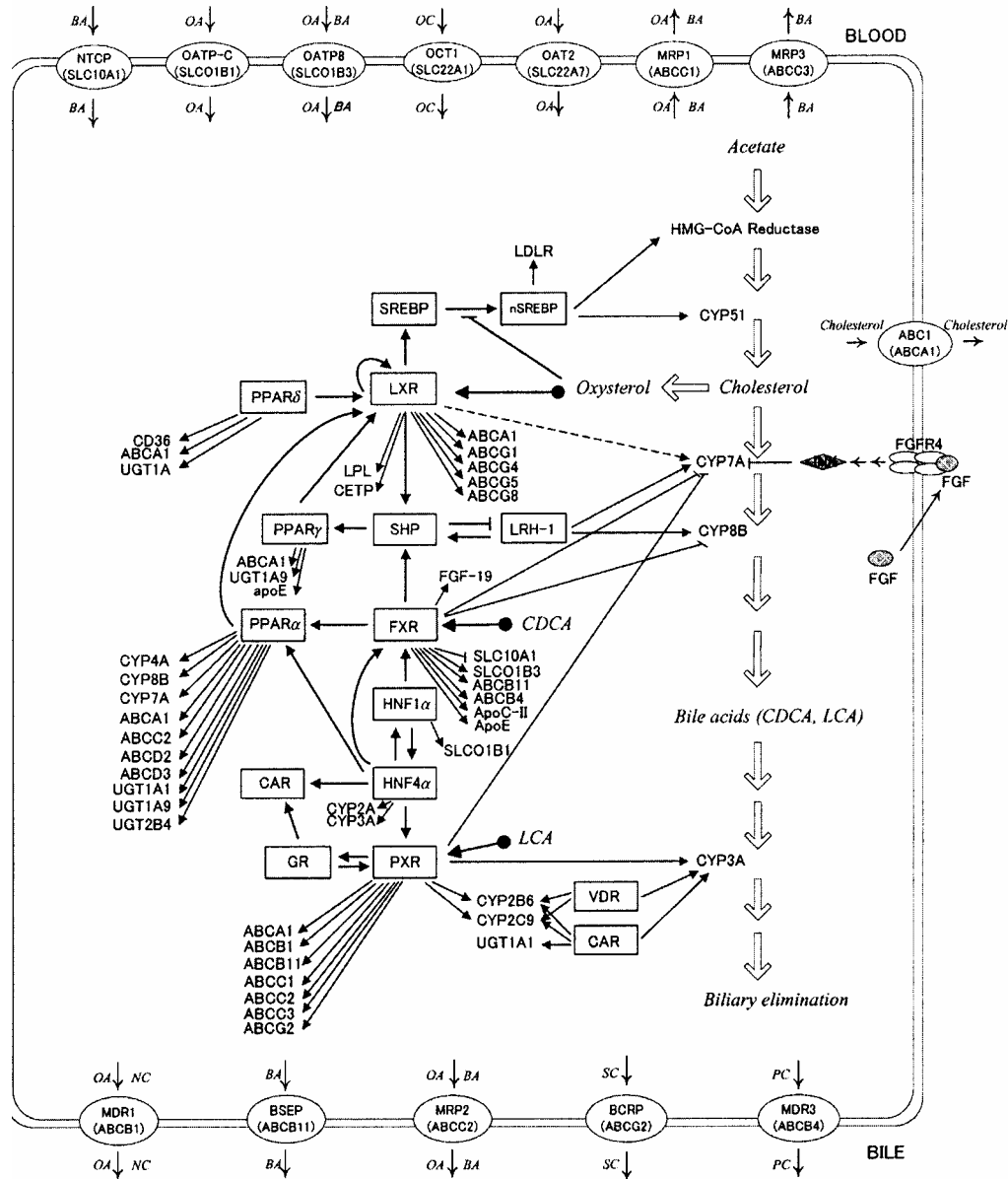

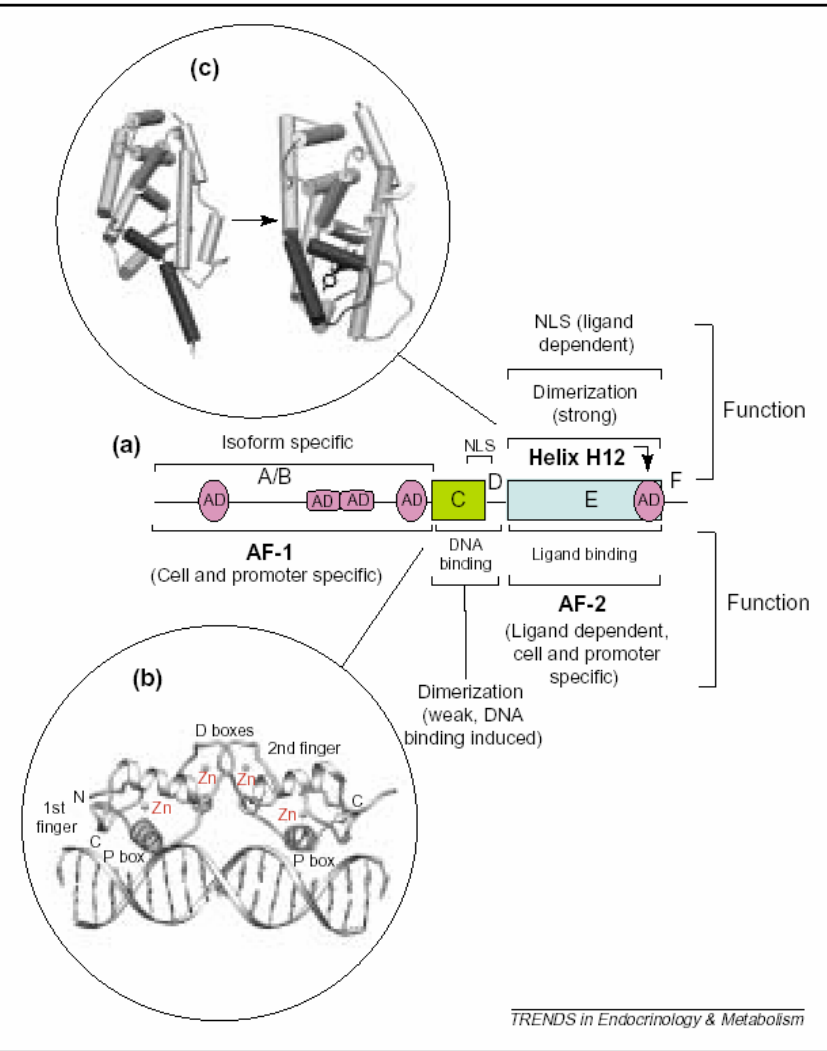
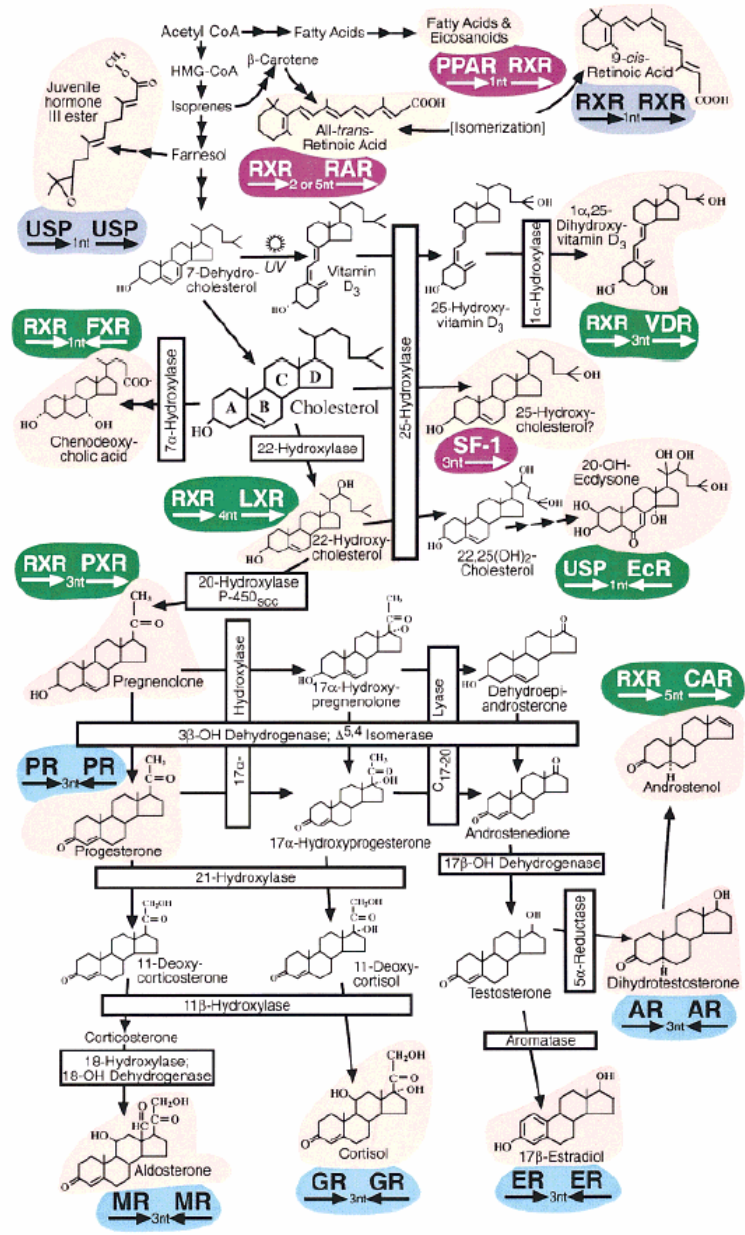

Fig. 1. (a) Schematic of the structural and functional organization of NRs. The evolutionary conserved regions C (DBD) and E (LBD) are indicated as boxes and a black line represents the divergent regions A/B, D and F. Two transcription AFs have been described in several NRs, a constitutively active (if taken out of the context of the receptor) AF-1 in region A/B and a ligand-inducible AF-2 in region E. Within these AFs, ads have been defined. (b) Estrogen receptor DBD complex on a cognate DNA response element. (c) Agonist-induced changes of the LBD, allowing binding of coactivators (the bound coactivator-binding peptide is shown). Figures 1b,c are three-dimensional views derived from the corresponding crystal structures. Abbreviations: See Glossary.



DNA binding

Fig. 2. The types of DNA-response elements used by nuclear receptors.

(a) Symmetric repeats using the consensus half-site 5'-AGAACA-3' are used by the glucocorticoid receptor (GR), progesterone receptor (PR), androgen receptor (AR) and mineralocorticoid receptor (MR), each of which is a homodimer. The estrogen receptor (ER) binds similar symmetric sites but with consensus 5'-AGGTCA-3' half-sites. (b) A '1-5 rule' specifies the use of direct repeats with variable spacings by RXR and its many partners (depicted in red). Some receptors, such as the vitamin D receptor (VDR) or RevErb, can form homodimers as an alternative to heterodimers. The size of the inter-half-site spacing (n) can vary from one to five base-pairs. (c) Sites containing just one copy of 5'-AGGTCA-3' flanked with specific 5' sequences (xxx) are used by the nerve growth factor induced B (NGFI-B) receptor, RevErb and some other orphan receptors.

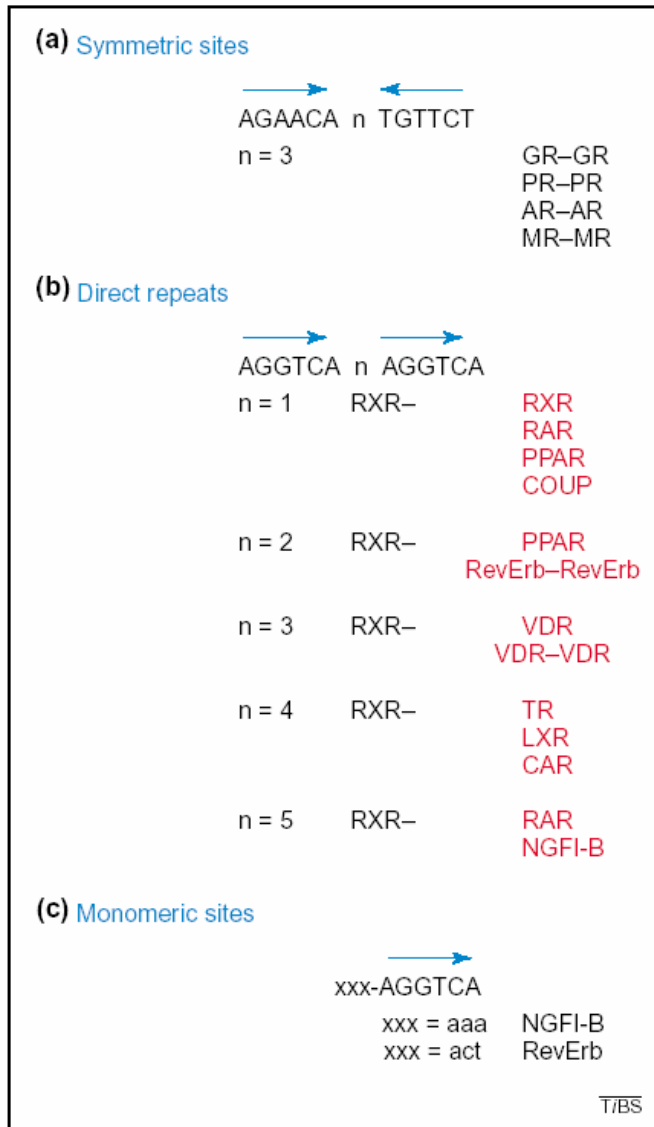

We can divide the receptors into subgroups on the basis of their pattern of dimerization. One group consists of the steroid receptors, all of which appear to function as homodimers. This group includes receptors for estradiol (ER), progesterone (PR), androgens (ARs), glucocorticoids (GRs) and mineralocorticoids (MRs). A second major group contains receptors that form heterodimers with retinoid X receptor (RXR) - the receptor for 9-*cis* retinoic acid. Members of this group include the receptors for all-*trans* retinoic acid (RAR), vitamin D3 (VDR) and thyroid hormone (TR), as well as liver X receptor (LXR), peroxisome proliferator activated receptor (PPAR) and others. A third group consists of receptors that can bind DNA as monomers, such as NGFI-B, RevErb, ROR and SF-1.

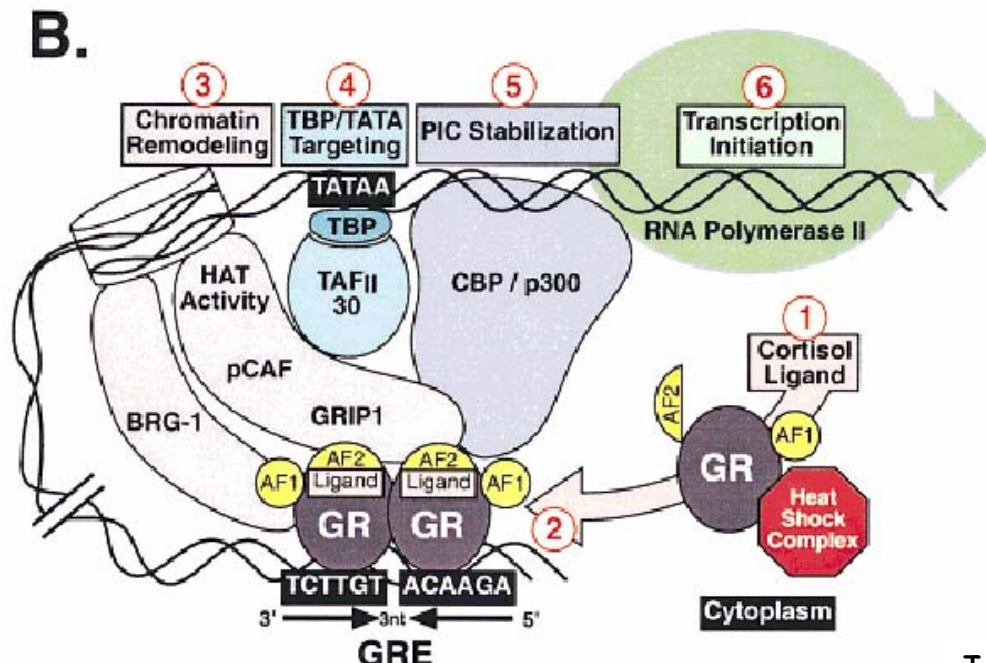
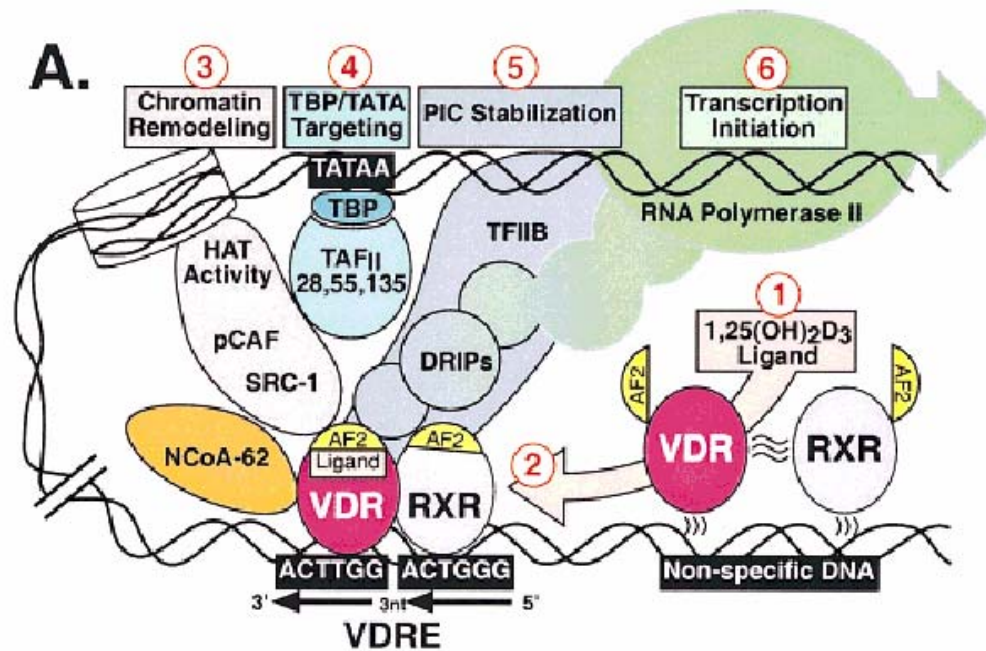

A: Unliganded heterodimerizing receptors, exemplified here by VDR, exist as weakly associated heterodimers with RXR, presumably bound nonspecifically to DNA [Haussler et al 1998]. Binding of the 1,25(OH)₂D₃ ligand to VDR (1) promotes high-affinity heterodimerization with RXR accompanied by binding of the heterodimer to its direct repeat VDRE (2).

B: Unliganded GR, like other receptors in group (d) (see Fig. 2), exists as a complex with heat shock proteins in the cytoplasm. Upon binding its cortisol ligand (1), GR dissociates from the cytoplasmic complex, translocates to the nucleus and forms a homodimer on its palindromic GRE (2). Triggered by a ligand-mediated change in GR conformation, the AF1 and AF2 domains then synergize to promote a series of events (3–6) involving the recruitment of coregulatory complexes similar to those described for the VDR-RXR heterodimer, but with some distinctive features.

Toxic compounds, pharmaceuticals

?????

Cell and signaling -specific context

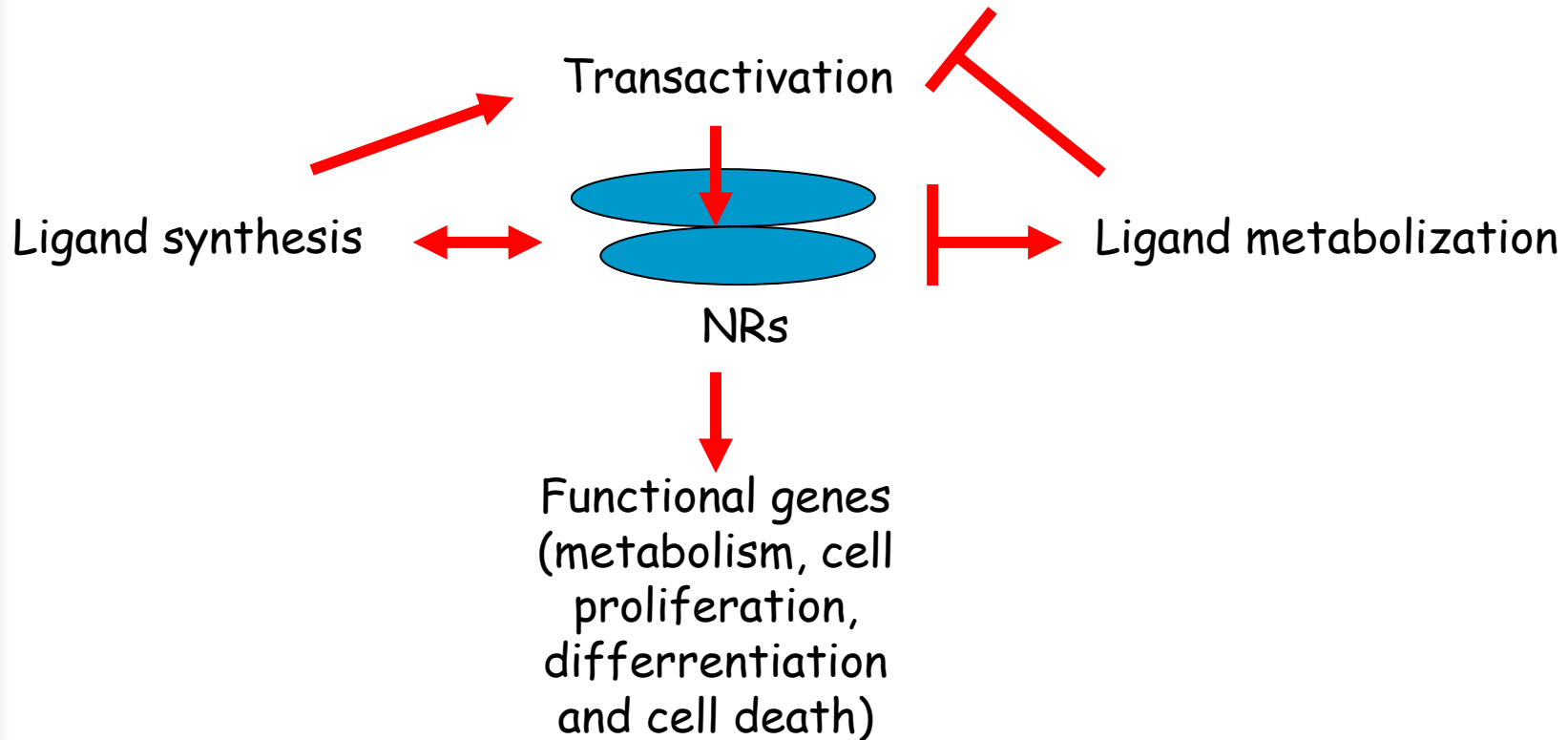

Nizkomolekulární toxické látky nebo farmaka mohou výrazným způsobem ovlivnit endokrinní signalizaci.



Intracrine



Autocrine

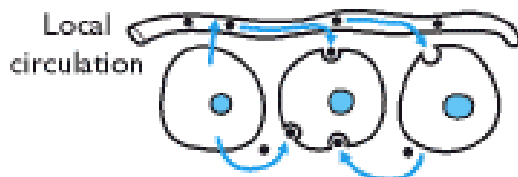

Paracrine

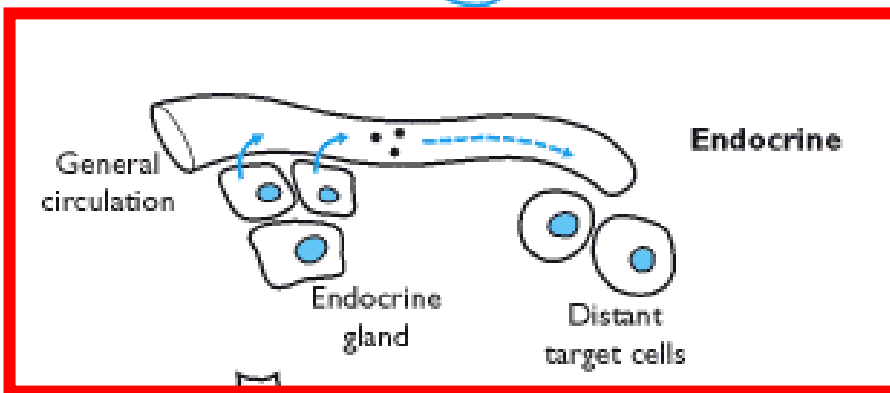

Endocrine

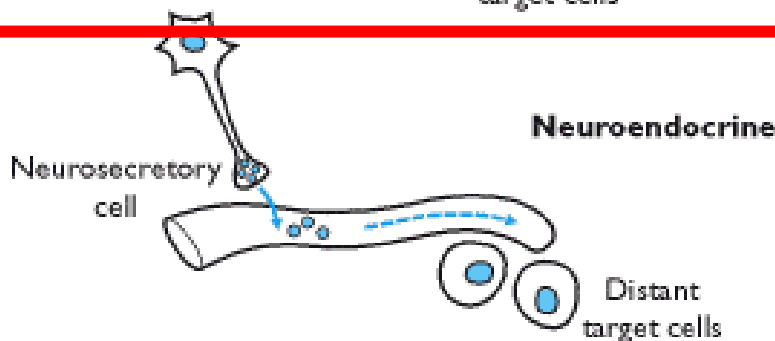

Neuroendocrine



Steroidní hormony

Protein and Peptide Hormones

Prohormone

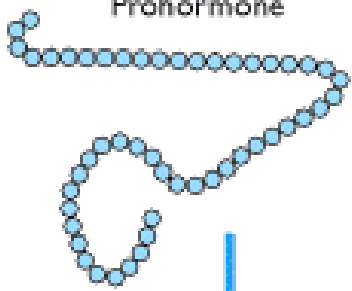

↓
Endothelin

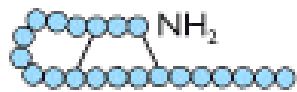

Insulin

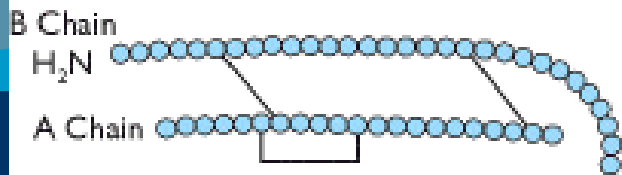

Steroid Hormones

Cholesterol

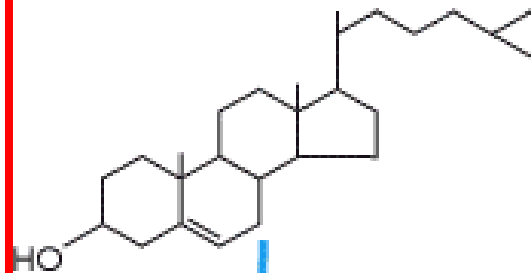

↓
Steroid Nucleus

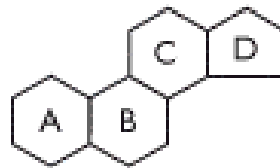

Tyrosine Derivatives

Tyrosine

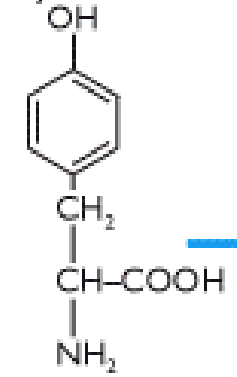

↓
Thyroxine

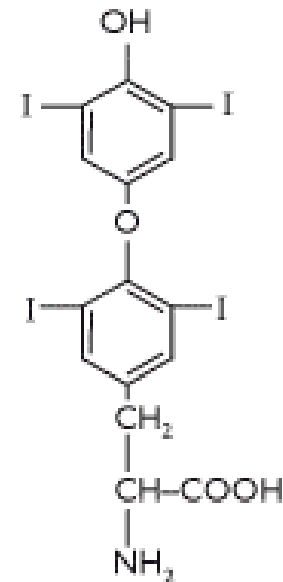

↓
Epinephrine

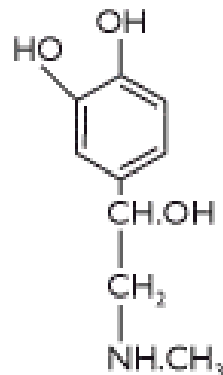

Hormones

Peptide/protein

Steroid

Amino acid or fatty acid derived

Thyroid hormones

Thyroxine (T₄)

Triiodothyronine (T₃)

Adrenal cortical steroids

Cortisol

Aldosterone

DHEA

Male reproductive hormones

Inhibin

Testosterone

Dihydrotestosterone

Female reproductive hormones

Inhibin

Estradiol

Oxytocin

Progesterone

Human chorionic gonadotropin (hCG)

Human chorionic somatotrophin

Five major steroid families:

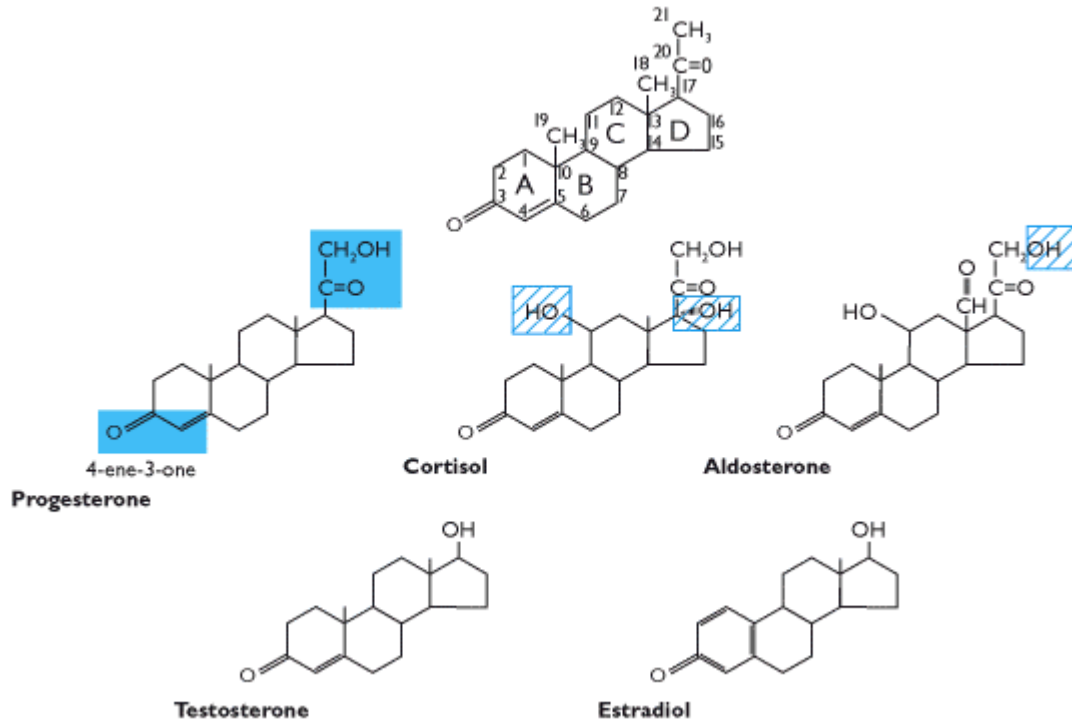

Shaded boxes show structural requirements for glucocorticoid and mineralocorticoid activity. Hatched boxes show additional structural requirements for specific glucocorticoid or mineralocorticoid activity.

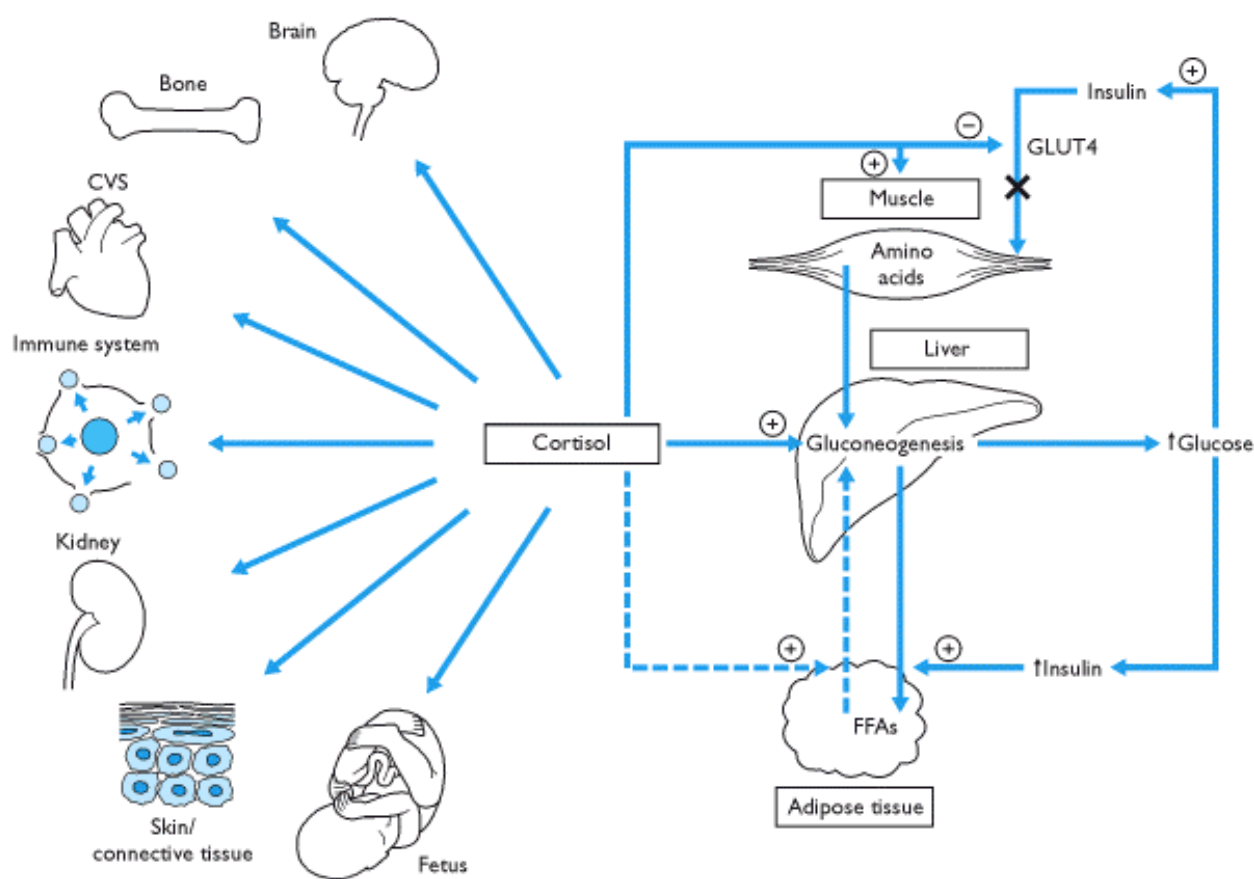

- Cortisol stimulates the release of amino acids from muscle. These are taken up by the liver and converted to glucose.
- The increased circulating concentration of glucose stimulates insulin release. Cortisol inhibits the insulin-stimulated uptake of glucose in muscle via the GLUT4 transporter.
- Cortisol has mild lipolytic effects. These are overpowered by the lipogenic action of insulin secreted in response to the diabetogenic action of cortisol.
- Cortisol also has varied actions on a wide range of other tissues

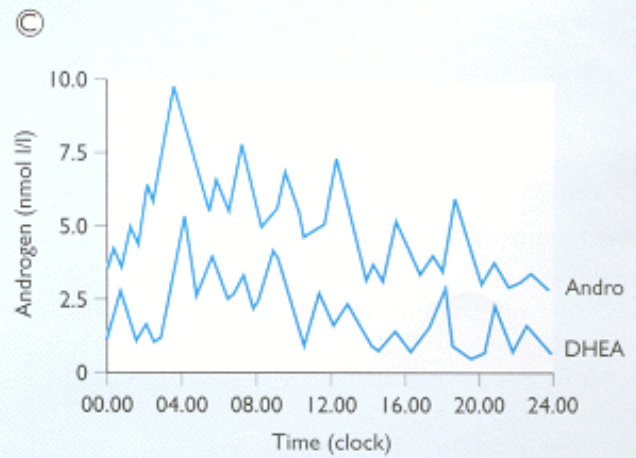
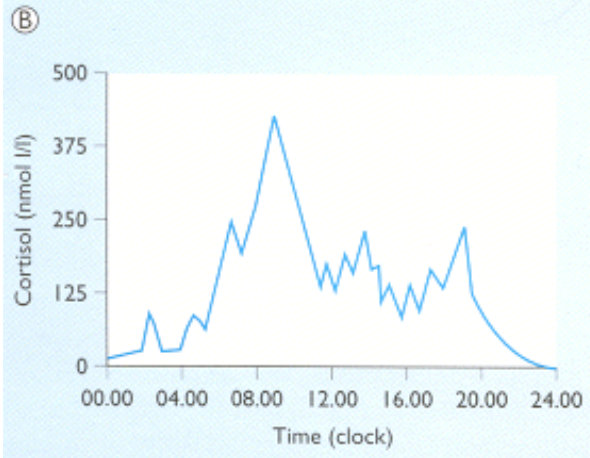
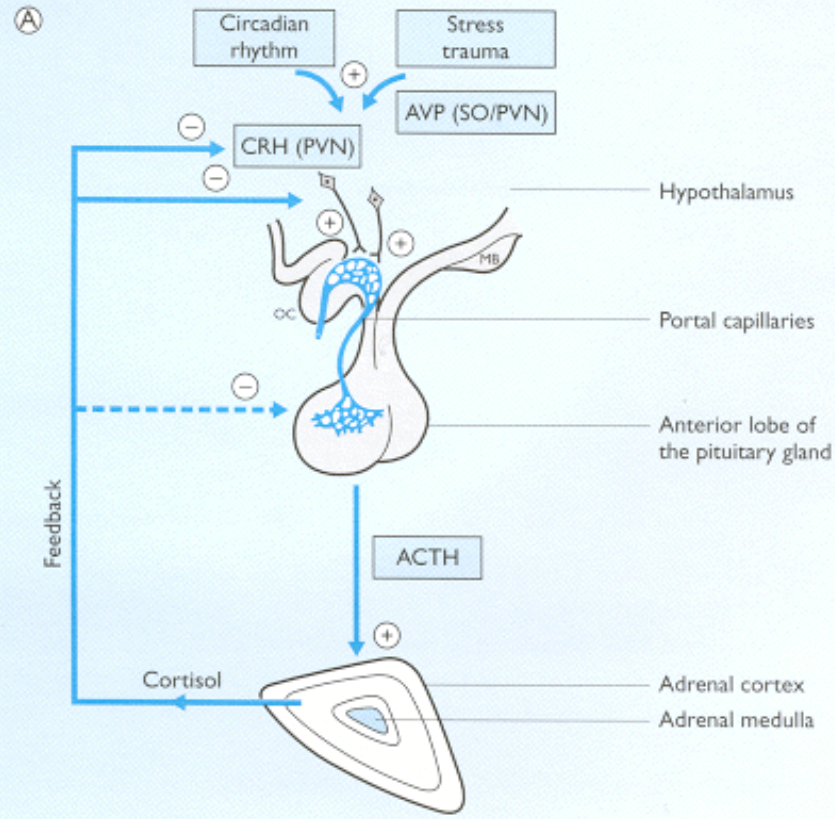

The glucocorticoid receptor and activation by cortisol

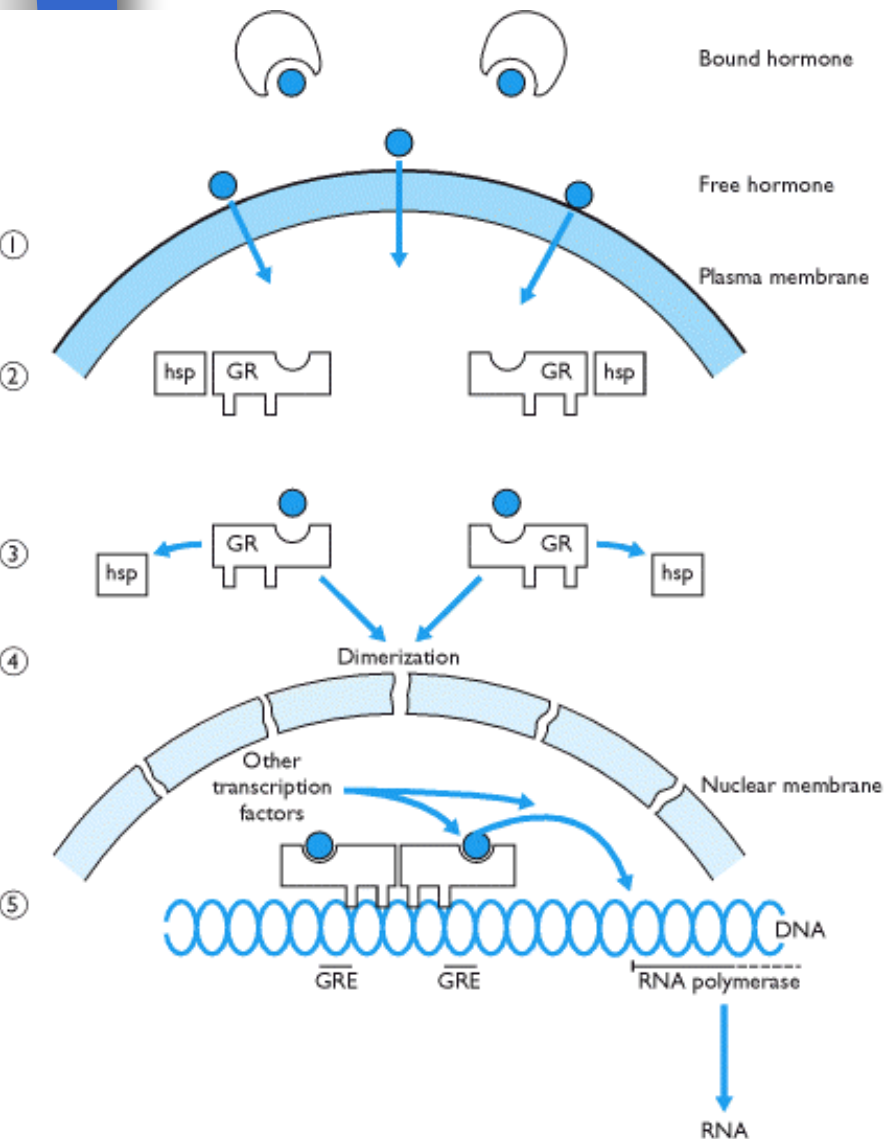

- 1) Unbound, lipophilic cortisol readily crosses cell membranes and in target tissues will combine with the glucocorticoid receptor (GR).
- 2) Like the androgen and progesterone receptors, unliganded GRs are located in the cytoplasm attached to heat shock proteins (hsp-90, hsp-70 and hsp-56).
- 3) When hormones bind to these receptors hsp's are released and the hormone receptor complexes translocate to the nucleus.
- 4) These complexes form homo- or heterodimers and the zinc fingers of their DNA-binding domains slot into the glucocorticoid response elements (GREs) in the DNA helix.
- 5) Together with other transcription factors, such as NF- κ B or c-jun and c-fos, they initiate RNA synthesis (activation of RNA polymerase) downstream of their binding.

Diagrammatic outline of the synthesis of cortisol from cholesterol in the adrenal cortex

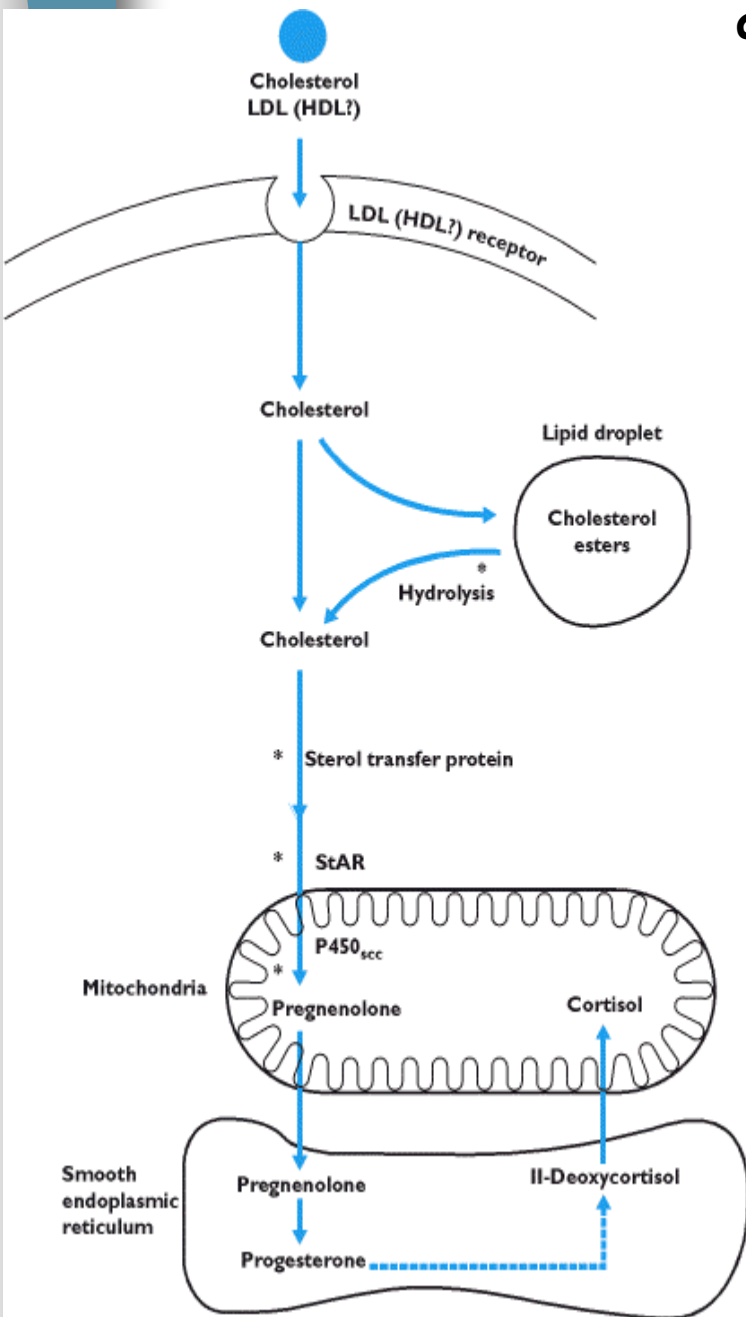

Cholesterol is either obtained from the diet or synthesized from acetate by a CoA reductase enzyme. Approximately 300 mg cholesterol is absorbed from the diet each day and about 600 mg synthesized from acetate. Cholesterol is insoluble in aqueous solutions and its transport from the main site of synthesis, the liver, requires apoproteins to form a lipoprotein complex. In the adrenal cortex, about 80% of cholesterol required for steroid synthesis is captured by receptors which bind low-density lipoproteins (LDL). The remaining 20% is synthesized from acetate within the adrenal cells by the normal biochemical route.

Biosyntéza peptidových hormonů:

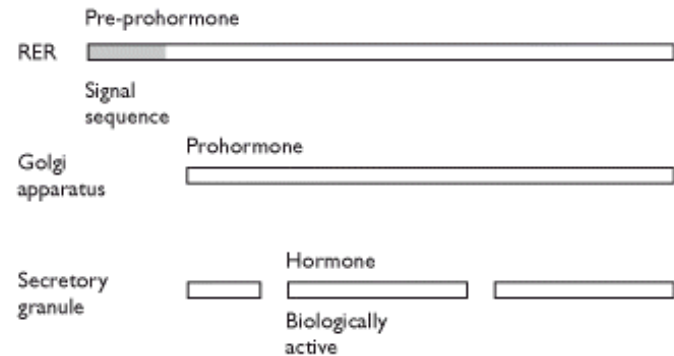
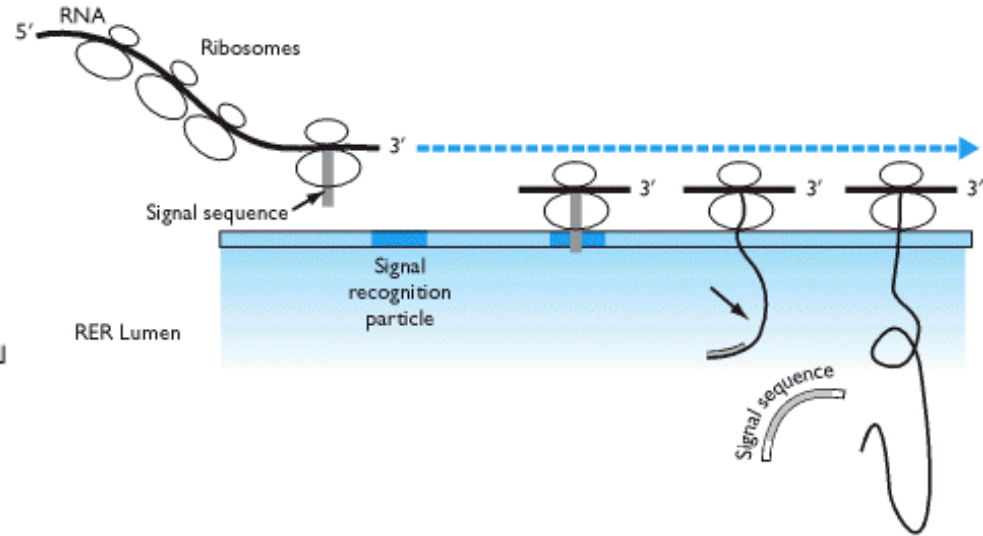
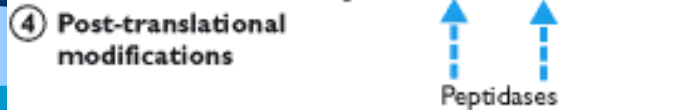
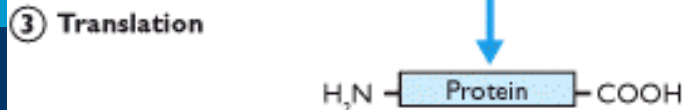
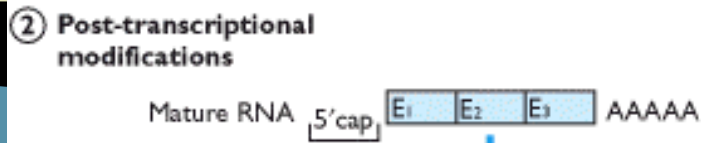
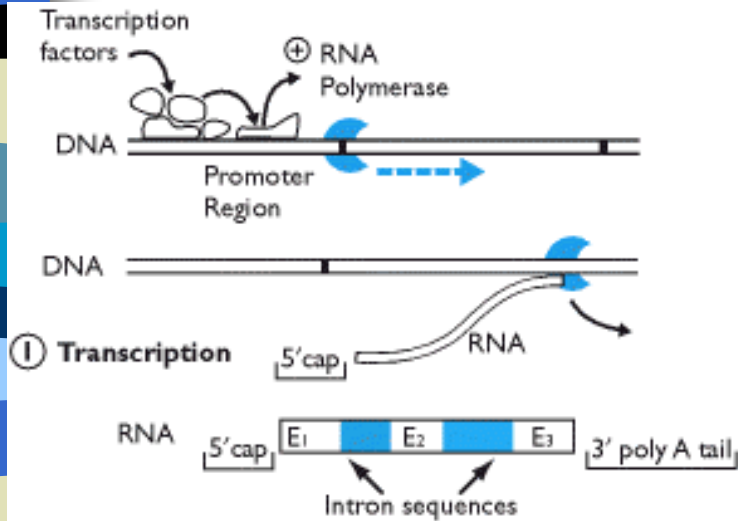

Biosynthese steroidhormonu:

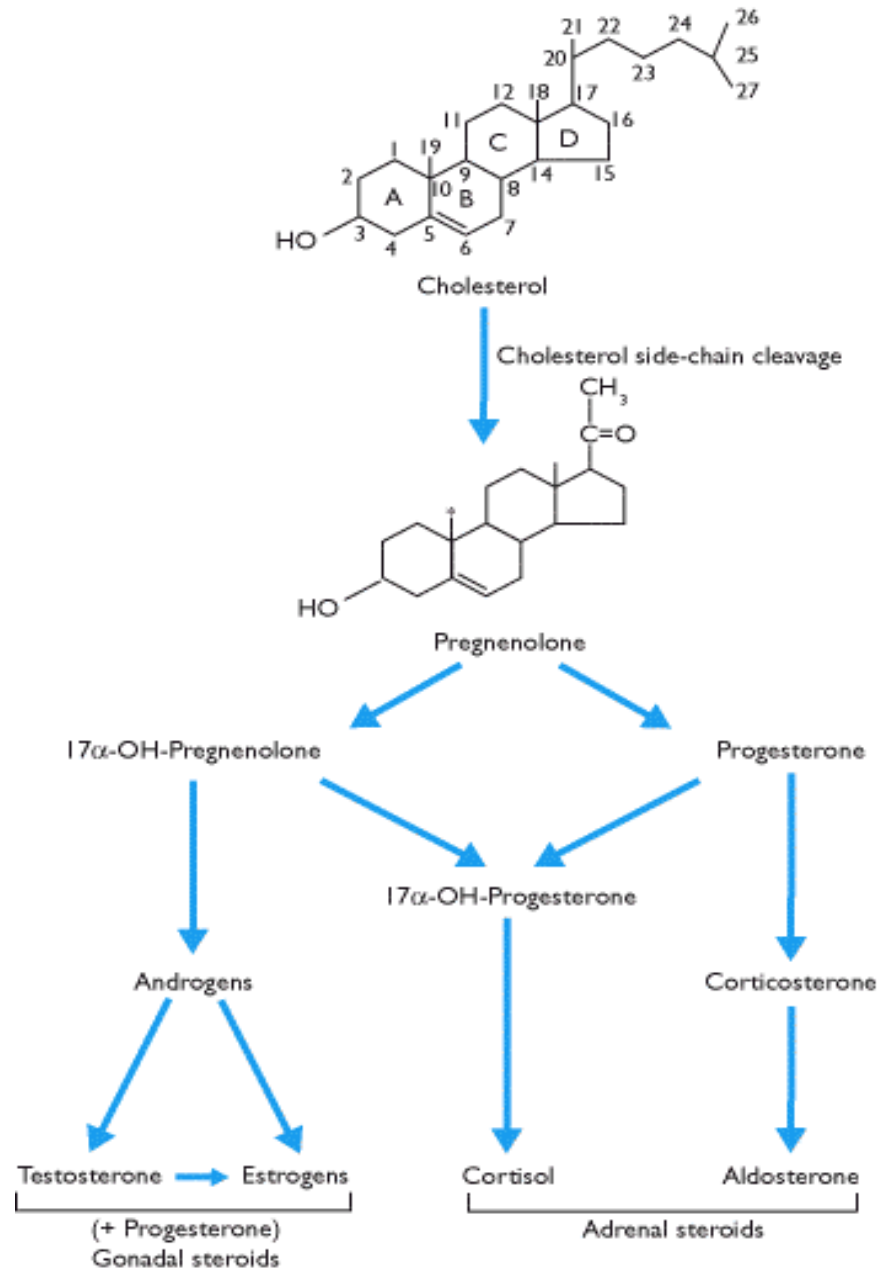

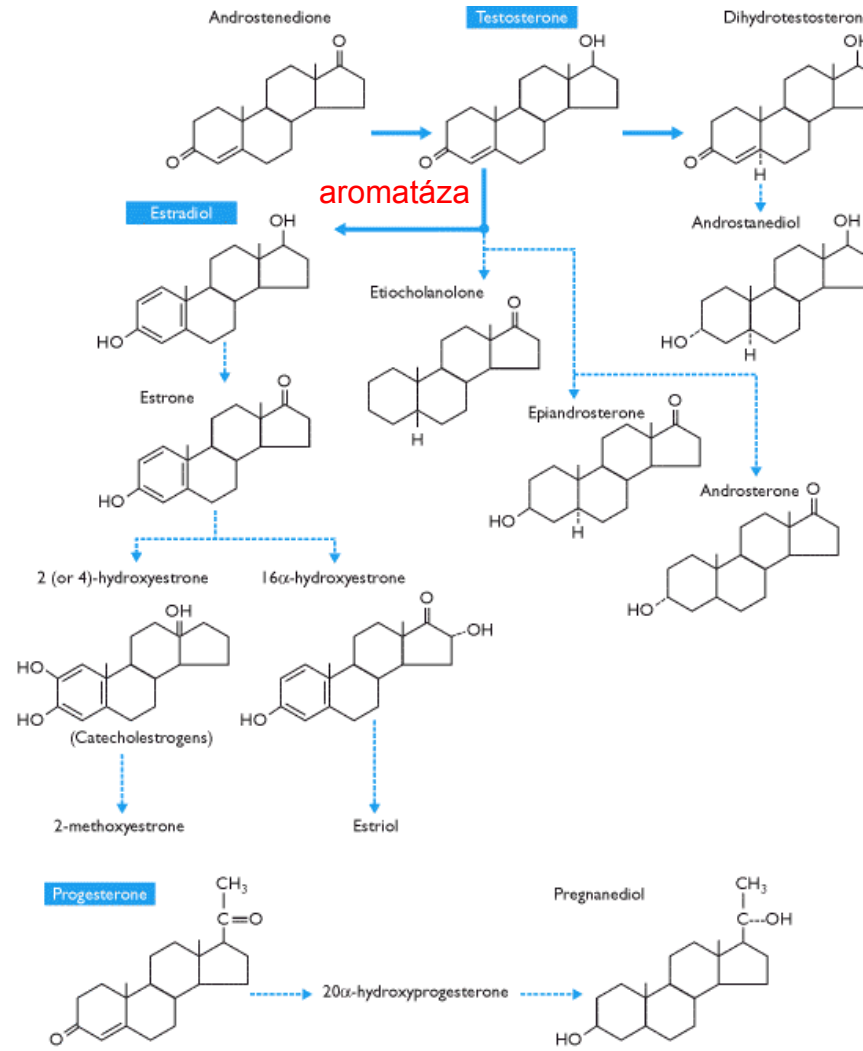
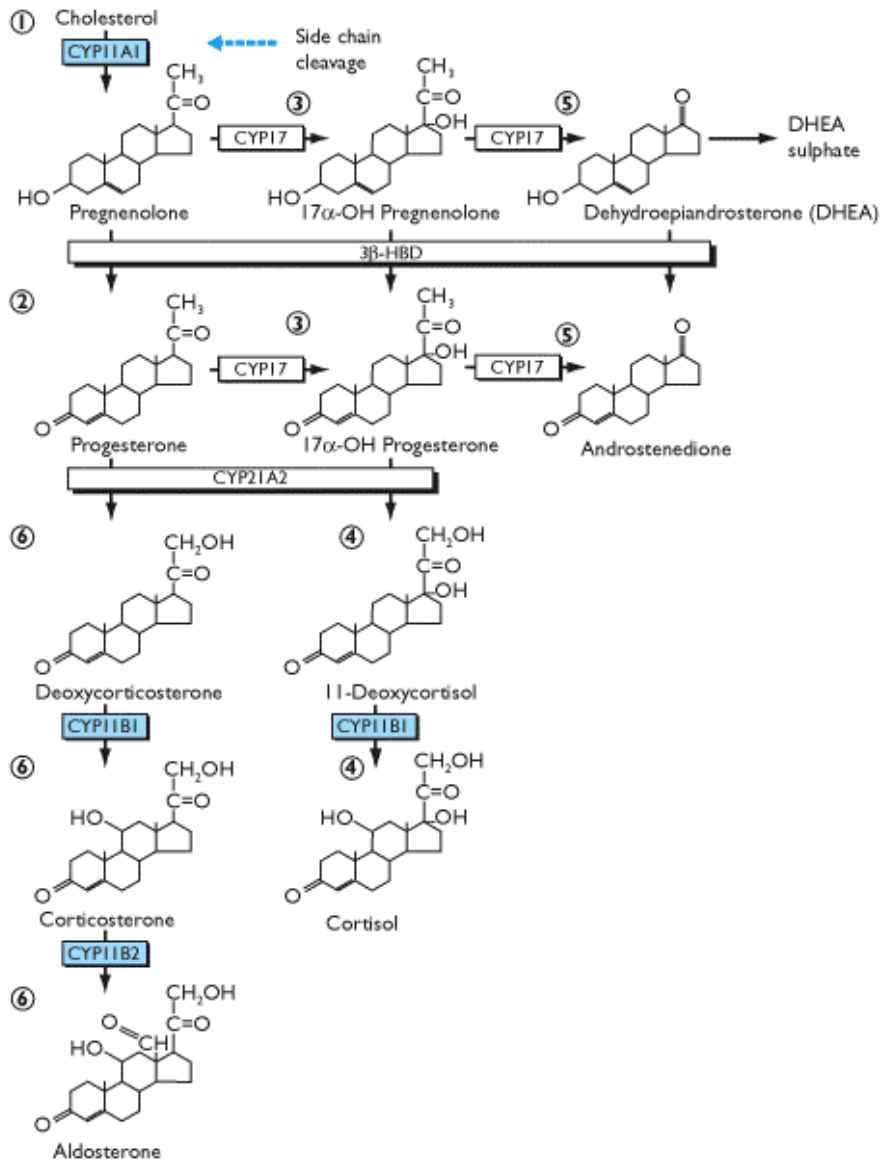
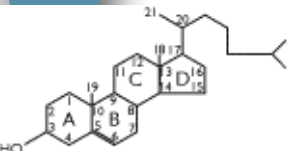

Male	Testis	Adrenal	Peripheral conversion
Testosterone	95	<1	<5
5 α -DHT	20	<1	80
Androstenedione	20	<1	90
DHEA	2	<1	98
DHEA-S	<10	90	-

Female	Ovary	Adrenal	Peripheral conversion
Testosterone	5-25	5-25	50-70
5 α -DHT	-	-	100
Androstenedione	45-60	30-45	10
DHEA	20	80	-
DHEA-S	<5	>95	-

Total serum concentrations of testosterone - male: 9-25 nmol/l - female: 0.5-2.5 nmol/l
 Abbreviations: DHT, dihydrotestosterone; DHEA(-S), dihydroepiandrosterone (-sulfate).

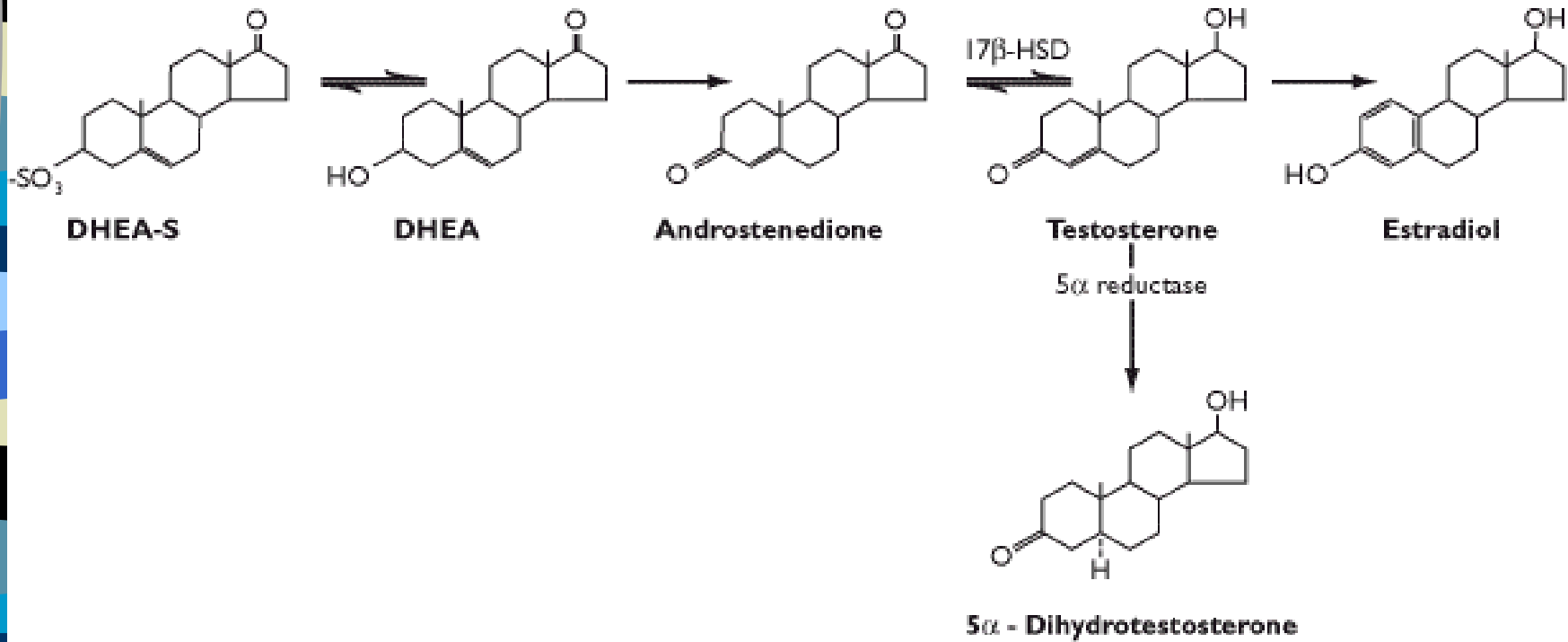

Only about 2% of circulating **testosterone** is in the free form and able to enter cells. The rest is either **bound to albumin (approximately 40%) or to sex-hormone-binding globulin (SHBG)** and is in equilibrium with the free form. SHBG is synthesized in the liver and its circulating concentration is increased by estrogen or excess thyroid hormones and decreased by exogenous androgens, glucocorticoids or growth hormone and by hypothyroidism, acromegaly and obesity. Most circulating testosterone is converted in the liver to metabolites such as androsterone and etiocholanolone that, after conjugation with glucuronide or sulfate are excreted in the form of 17-ketosteroids. The majority of urinary ketosteroids are of adrenal origin and, thus, determinations of ketosteroids do not reliably reflect testicular secretion.

Estradiol, the most important steroid secreted by the ovary because of its biologic potency and diverse actions, is transported bound to albumin (approximately 60%) and about 30% to SHBG. It is rapidly converted to estrone by 17 β -hydroxy-steroid dehydrogenase in the liver and, whilst some estrone re-enters the circulation, most of it is further metabolized to estriol via 16 α -hydroxyestrone or to 2- or 4-hydroxyestrone (catechol estrogens) by the action of catecho-*O*-methyltransferase. The latter metabolites can be formed in the brain and may compete with receptors for catecholamines. Metabolites are conjugated with sulfate or glucuronide before excretion by the kidney.

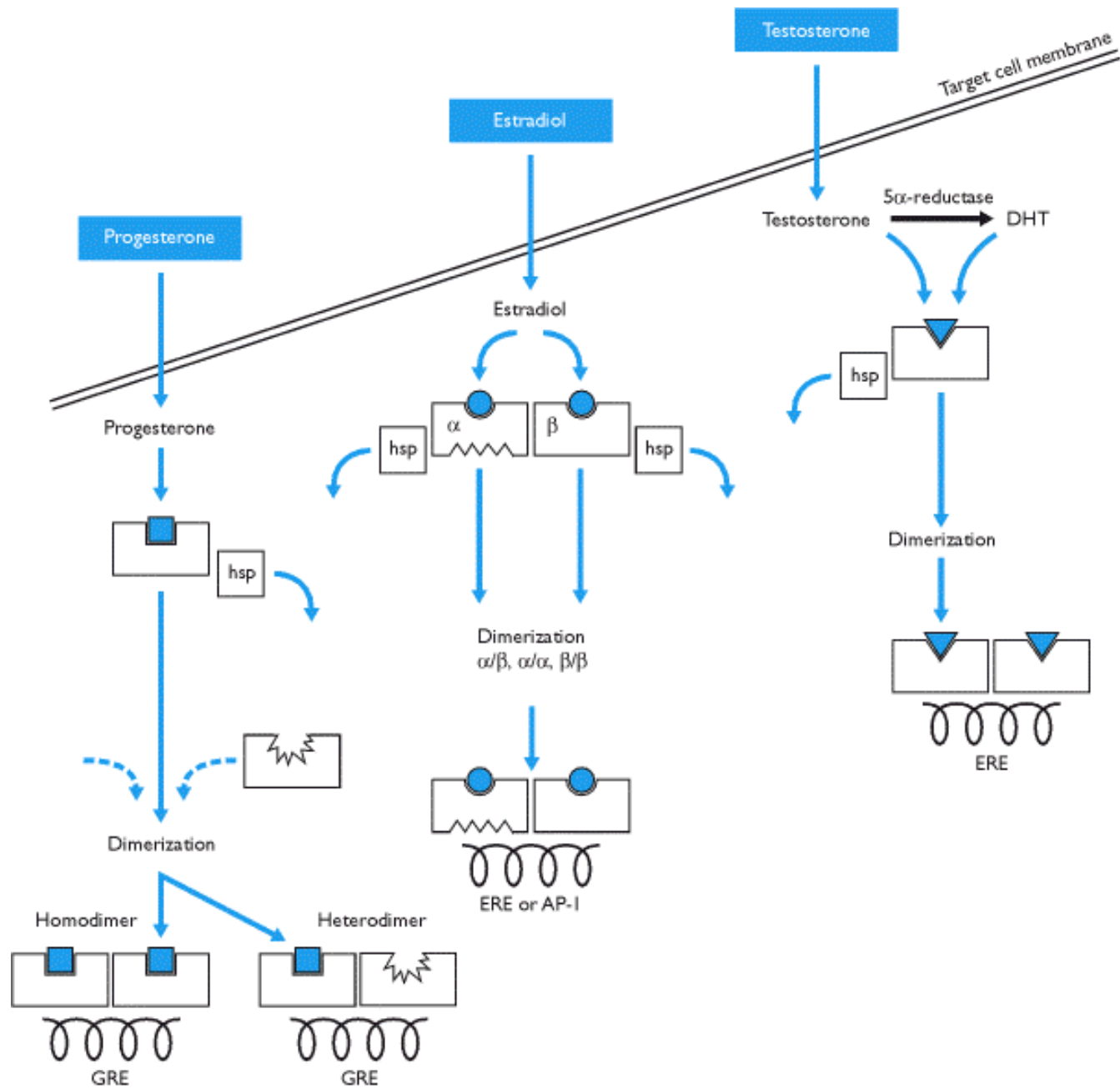



Tyroidní hormony štítné žlázy

Protein and Peptide Hormones

Prohormone

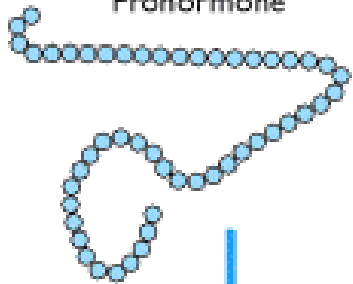

↓
Endothelin

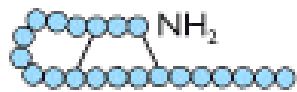

Insulin

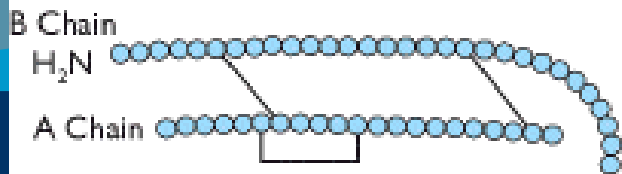

Steroid Hormones

Cholesterol

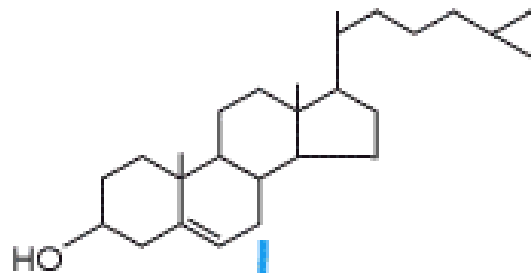

↓
Steroid Nucleus

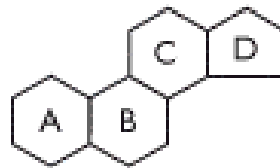

Tyrosine Derivatives

Tyrosine

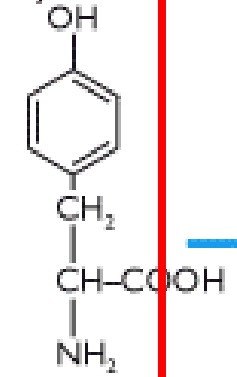

↓
Thyroxine

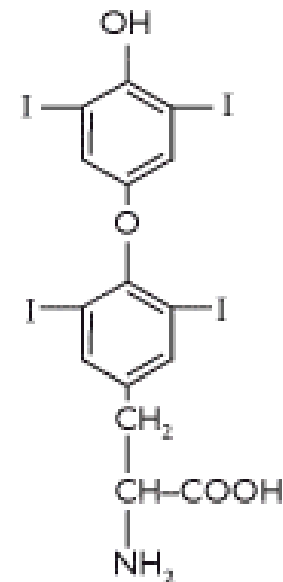

↓
Epinephrine

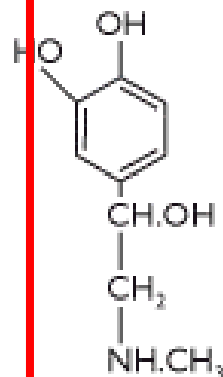

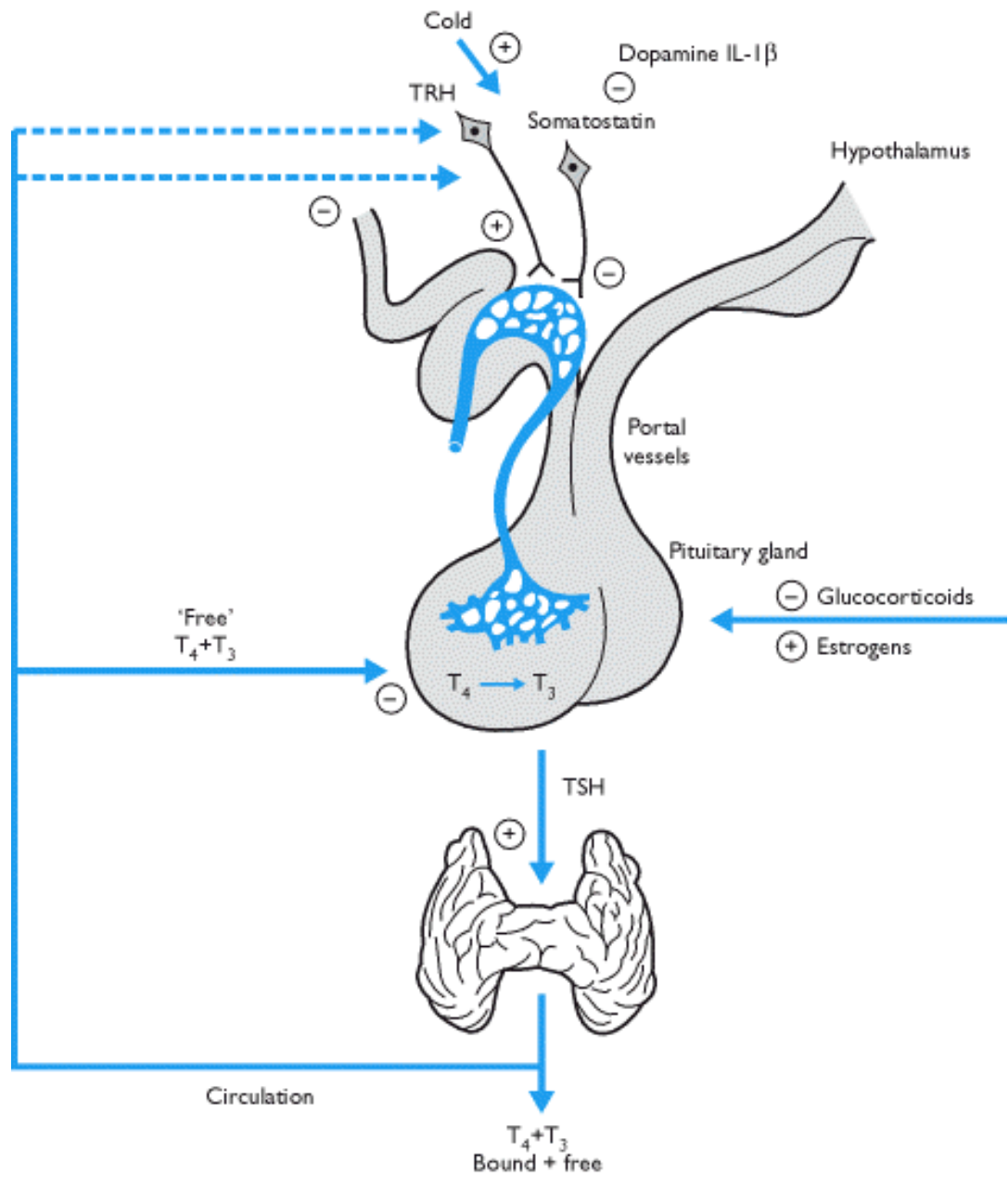

Thyroid hormone synthesis:

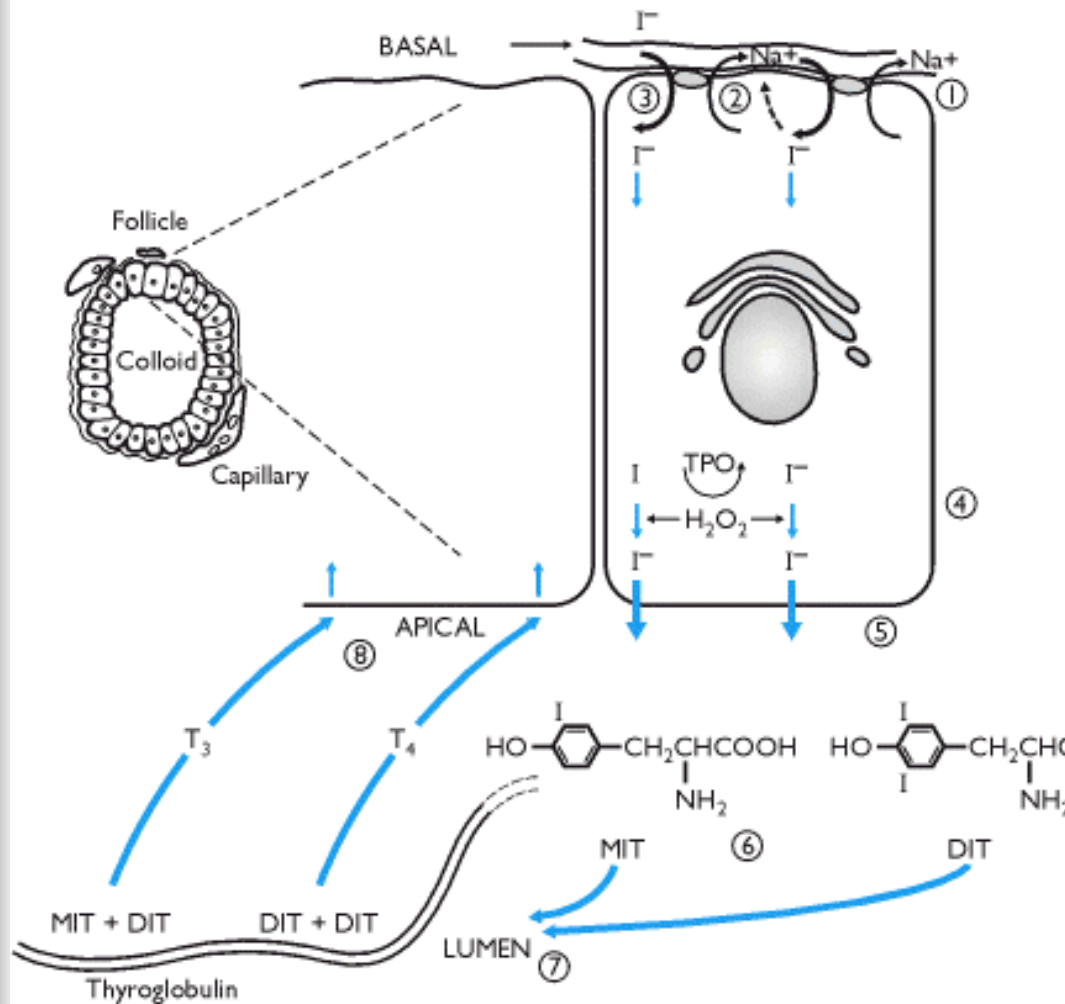

- 1) Active uptake of iodide (I^-) in exchange for Na^+ .
- 2) Iodide may be discharged from the follicular cell by administration of competing ions such as perchlorate, bromide or chlorate.
- 3) Iodide uptake, the main control point for hormone synthesis, is stimulated by TSH.
- 4) Oxidation of iodide by hydrogen peroxide (H_2O_2) to form active iodine. The reaction is catalyzed by thyroid peroxidase (TPO).
- 5) Active transport of iodine across the apical surface of the follicular cell.
- 6) Incorporation of active iodine into the tyrosine residues of thyroglobulin molecules to form mono- and di-iodotyrosines (MIT and DIT).
- 7) Uptake of the thyroglobulin into the lumen of the follicle and lining of iodinated tyrosine residues.

Thyroid hormone excretion:

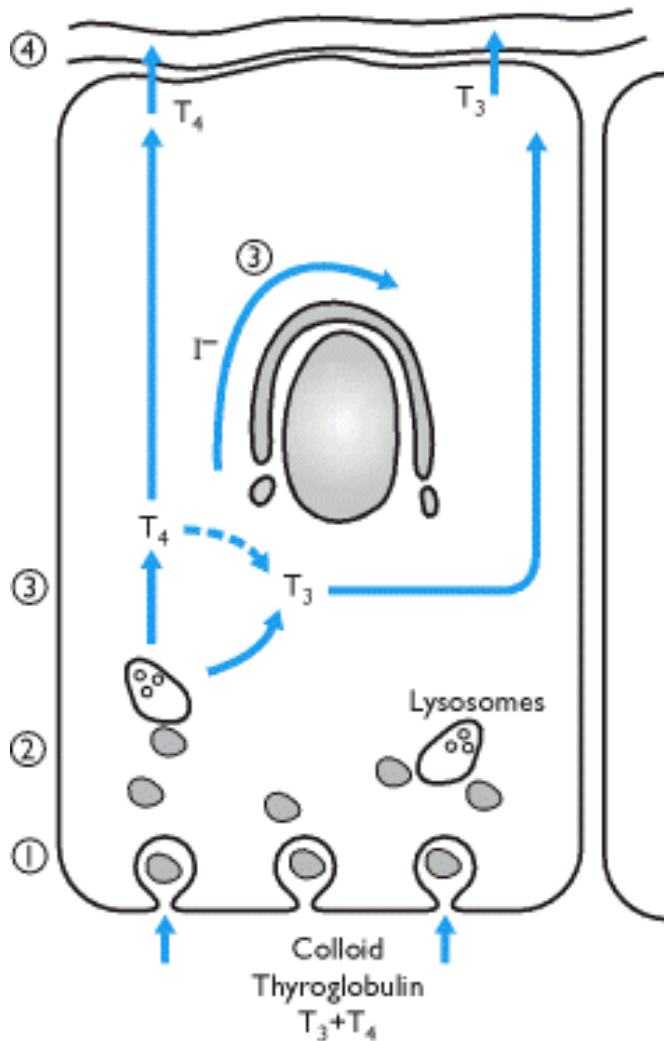

- 1) Under the influence of TSH, colloid droplets consisting of thyroid hormones within the thyroglobulin molecules are taken back up into the follicular cells by pinocytosis.
- 2) Fusion of colloid droplets with lysosomes causes hydrolysis of thyroglobulin and release of T₃ and T₄.
- 3) About 10% of T₄ undergoes mono-deiodination to T₃ before it is secreted. The released iodide is reutilized. Several-fold more iodide is reused than is taken from the blood each day but in states of iodide excess there is loss from the thyroid.
- 4) On average approximately 100 μg T₄ and about 10 μg T₃ are secreted per day

The iodothyronines are virtually insoluble in water and, once released from thyroglobulin, they are very rapidly bound to the plasma proteins, **transthyretin** (previously called thyroxine-binding prealbumin), **thyroxine-binding globulin** (TBG) and **albumin**. These vary in their capacity and affinity for T3 and T4); about 70% of circulating thyroid hormones are bound to TBG. Only a tiny fraction (<0.5%) of released thyroid hormones exist in a free form in the circulation and this is in equilibrium with the bound forms of thyroid hormones.

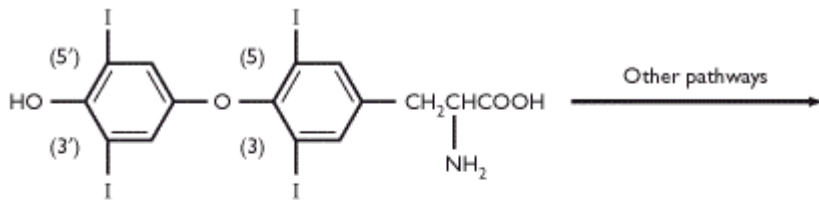

3,5,3',5'-Tetraiodothyronine (thyroxine, or T₄)

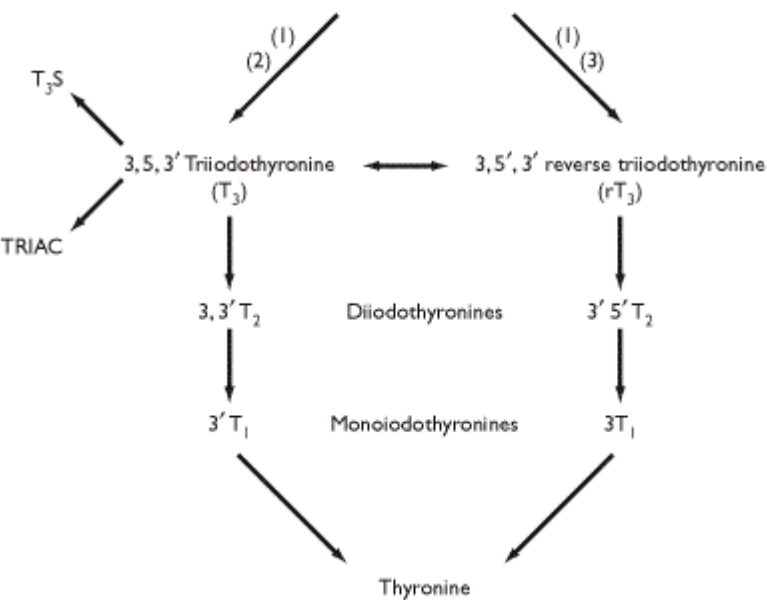

- Thyroid hormones are metabolized by a series of deiodinations which involve three types of deiodinases (indicated by numbers in brackets)

- Some T₄ is metabolised by being sulfated, decarboxylated, deaminated or conjugated with glucuronide (other pathways).

- Some T₃ may be sulfated (T₃S) or converted to the acetic acid derivative triiodoacetic acid (TRIAC) that is more potent than its parent T₃.

- Serum half lives: T₄ – 7 days, T₃ – 1 day, rT₃ – 4 hours.

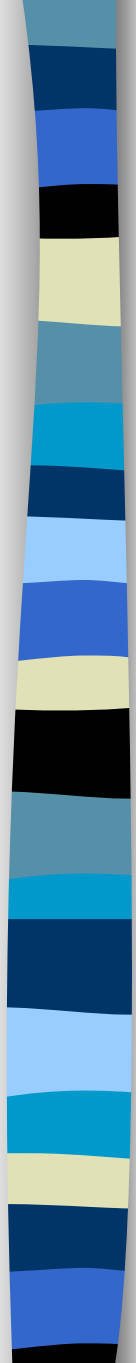

Eighty per cent of the total thyroid hormones secreted each day is T₄ but this is relatively inactive at nuclear receptors and, thus, considered to be a prohormone. Approximately 70-80% of released T₄ is converted by deiodinases to the biologically active T₃, the remainder to reverse-T₃ (rT₃) which has no significant biological activity. Deiodinases are unusual selenium-containing enzymes that are present in a number of tissues and are responsible for the metabolism of thyroid hormones.

Removal of an iodine atom from the 5th carbon atom (5') of the outer tyrosine ring of T₄ by Type 1 and Type 2 deiodinases produces T₃ whilst deiodination of the inner (5) tyrosine ring by Type 1 and Type 3 deiodinases produces rT₃. Further deiodinations at the 3rd and 5th carbon atoms of both outer and inner tyrosine rings produce increasingly inactive diiodo- and monoiodo-thyronines and at the same time conserving iodine. Iodothyronines are excreted in the urine although some T₃ and T₄ is conjugated with glucuronide and excreted via the bile in the feces.

Many of the actions of thyroid hormones are mediated by their binding to nuclear receptors that have a preferential affinity for T₃. T₃ receptors are, like all the steroid hormone receptors, members of a family of nuclear transcription factors that, in combination with other transcription factors, regulate gene expression in target cells. Unlike some steroid receptors (i.e. those for sex steroids and glucocorticoids), thyroid hormone receptors exist in the nucleus, not the cytoplasm, and may remain bound to DNA in the absence of hormone binding.

Thyroid hormones are lipid soluble and readily cross cell membranes. Once inside the nucleus, T₃ binds to its receptor. This dimerizes with another T₃ receptor (to form a homodimer) or with a different receptor, notably the retinoid X receptor, to form a heterodimer. In this form, the dimers interact with DNA. This occurs between recognition sites in the 'zinc fingers' of the DNA-binding domains of the receptors and particular base sequences in the DNA helix known as hormone response elements (HRE). The location of HREs determines which genes are regulated by T₃.

There is also evidence that thyroid hormones can have rapid, non-genomic effects on membrane receptors independent of protein synthesis. These include stimulation of sugar transport, Ca²⁺-ATPase activity and increased Na⁺ transport in muscle. The receptors for these effects have not been identified.

Retinoidy a jejich receptory:

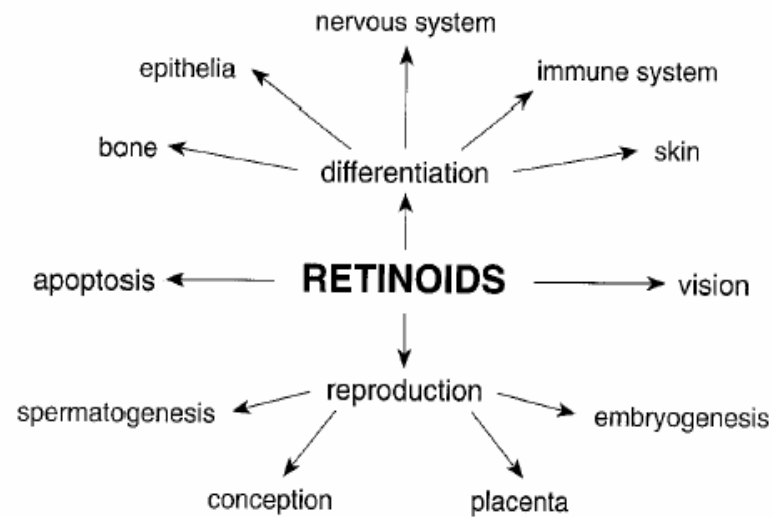

FIG. 1. Functions of naturally occurring retinoids.

TABLE I - LIGANDS AND ISOFORMS OF RAR AND RXR RECEPTORS

Receptor	Isoforms	Chromosomal location	Ligand
RAR α	$\alpha 1, \alpha 2$	17q21.1	} all- <i>trans</i> RA & 9- <i>cis</i> RA
RAR β	$\beta 1, \beta 2, \beta 3, \beta 4$	3p24	
RAR γ	$\gamma 1, \gamma 2$	12q13	
RXR α	$\alpha 1, \alpha 2$	9q34	} 9- <i>cis</i> RA
RXR β	$\beta 1, \beta 2$	6q21	
RXR γ	$\gamma 1, \gamma 2$	1q22-q22	



Receptory pro retinoidy (RAR, RXR)

Struktura a syntéza kyseliny retinové

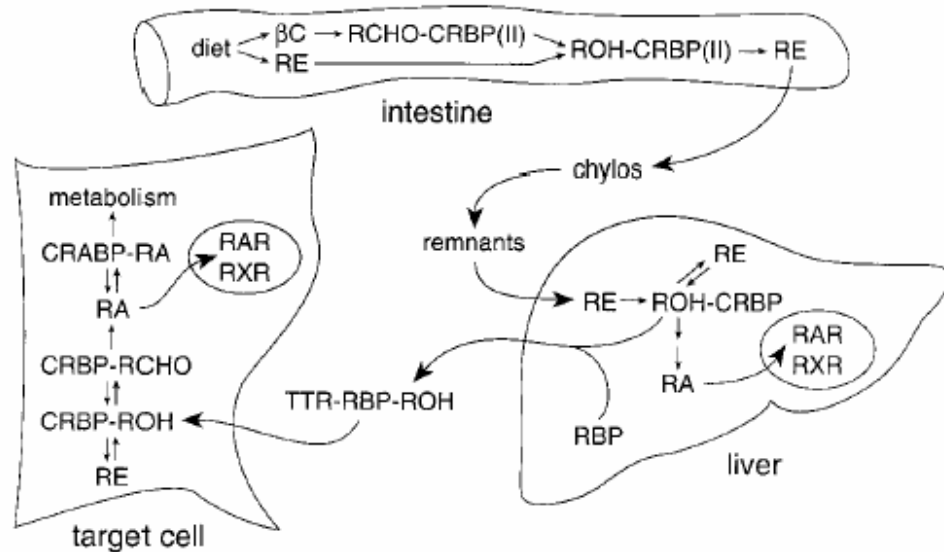
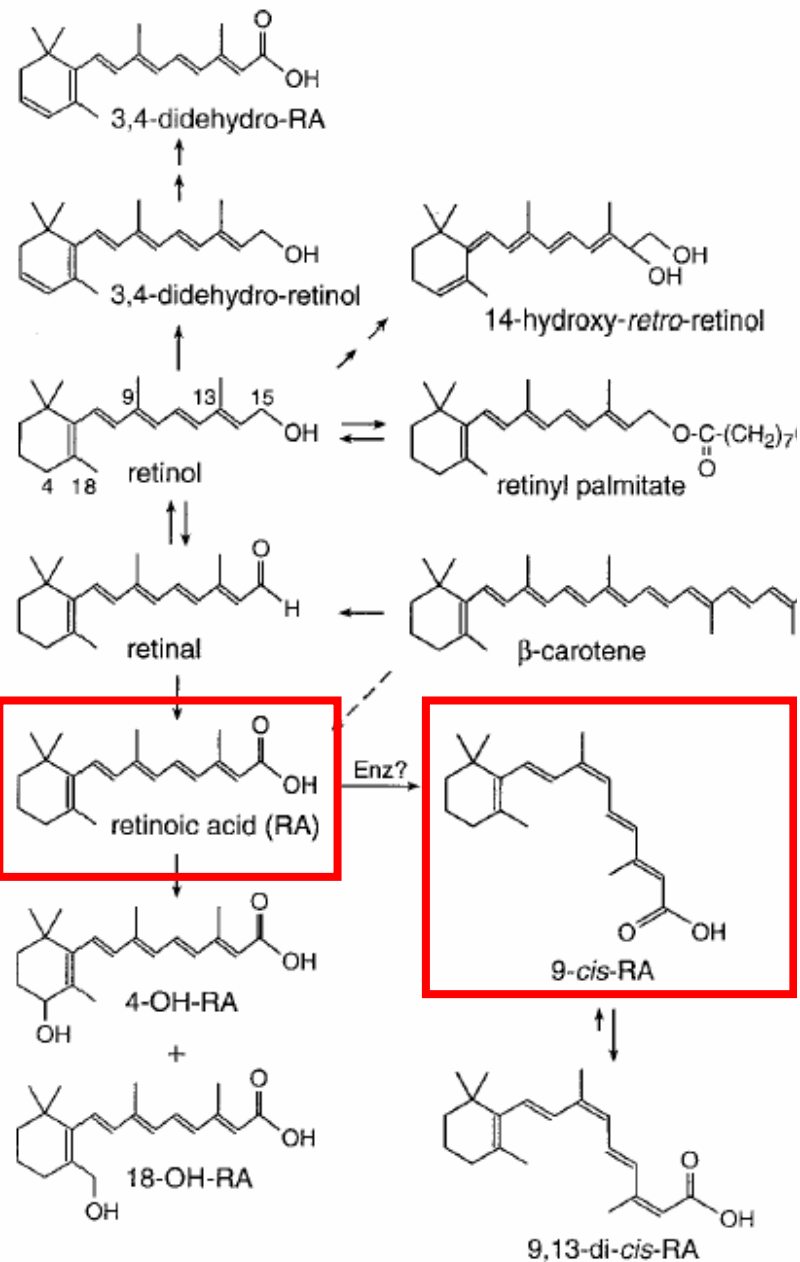

FIG. 3. Absorption, distribution, and metabolism of naturally occurring retinoids.

FIG. 2. Structures of naturally occurring retinoids.

TABLE 1
Retinoid Binding Proteins

Class/Protein	MW (kDa)	Primary ligands	Loci	Prospective function
Extracellular lipid-binding proteins (lipocalins)				
RBP	21	Retinol	Serum	Retinol transporter
β -lactoglobulin	18.3	Retinol?	Milk	Retinol transporter?
E-RABP	18.5	RA = 9cRA	Epididymis	RA/9cRA transporter
Intracellular lipid-binding proteins				
CRBP	14.6	Retinol \gg retinal	Many (e.g., liver, kidney, testis)	<i>holo</i> : substrate for LRAT and RoDH <i>apo</i> : stimulates REH; inhibits LRAT
CRBP(II)	14.6	Retinol = retinal	Intestine	<i>holo</i> : substrates for LRAT and retinal reductase
CRABP	15	RA \gg 9cRA > 13cRA \gg 9,13cRA	Many (e.g., testis, lung, kidney)	<i>holo</i> : substrate for RA metabolism; sequesters RA and possibly RA metabolites
CRABP(II)	15.7	RA \gg 9cRA > 9cRA \gg 9,13cRA	Adult skin, embryo	Same as for CRABP but with different affinities for RAs?
Others				
CRALBP	33	11- <i>cis</i> -retinal, 11- <i>cis</i> -retinol	RPE	Protects retinoids from isomerization
IRBP	145	Retinol, many others	Retina	Lipid transporter

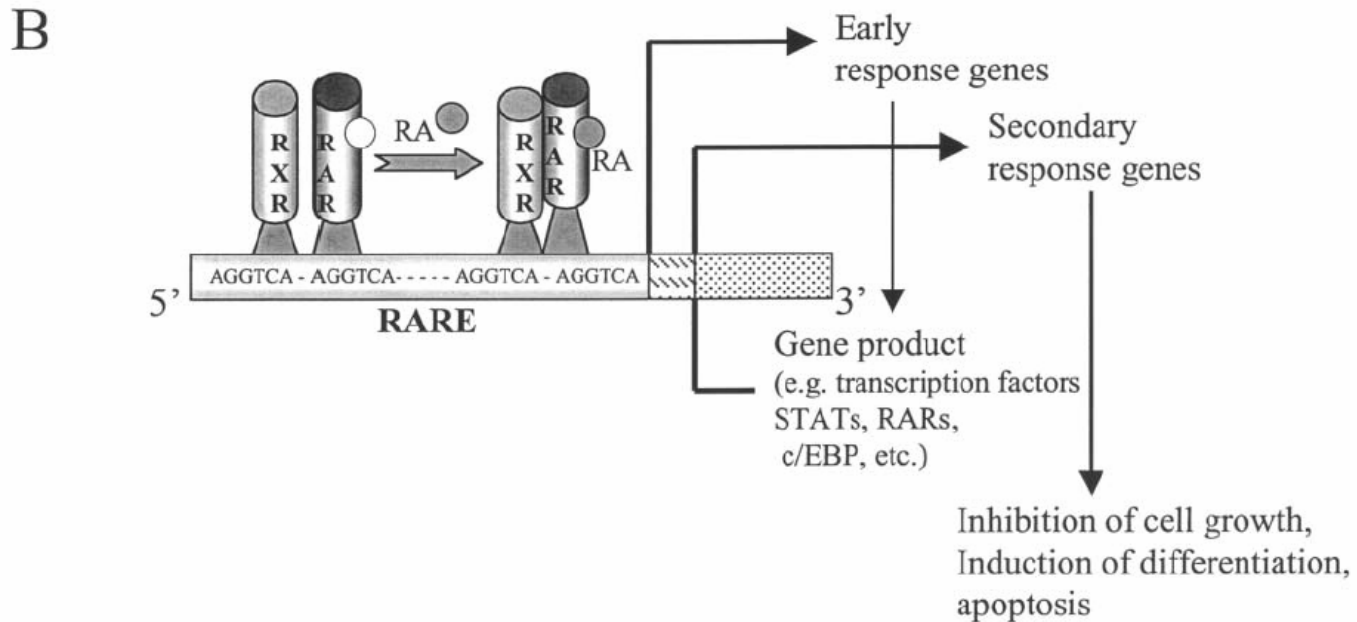
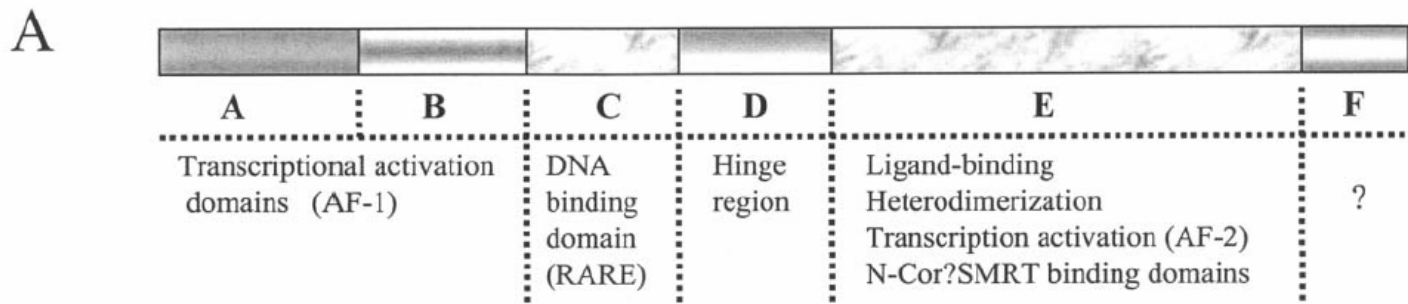

Fig. 1 - Structure and functions of retinoid receptors. A) Schematic representation of retinoid receptor protein depicting various functional domains. B) A molecular model for retinoid action. The liganded RAR forms heterodimer with RXR, binds to specific regulatory sequences (RARE) in the promoter region of target genes. Transactivation of such early response genes is a primary event of retinoid action. In addition to this, the products of early response genes can activate the transcription of secondary genes. Transactivation of these genes therefore represents secondary action of retinoids since their transcription requires protein synthesis. This cascade of gene events leads to secondary and tertiary events that eventually produce a phenotype that is characteristic of retinoid action.

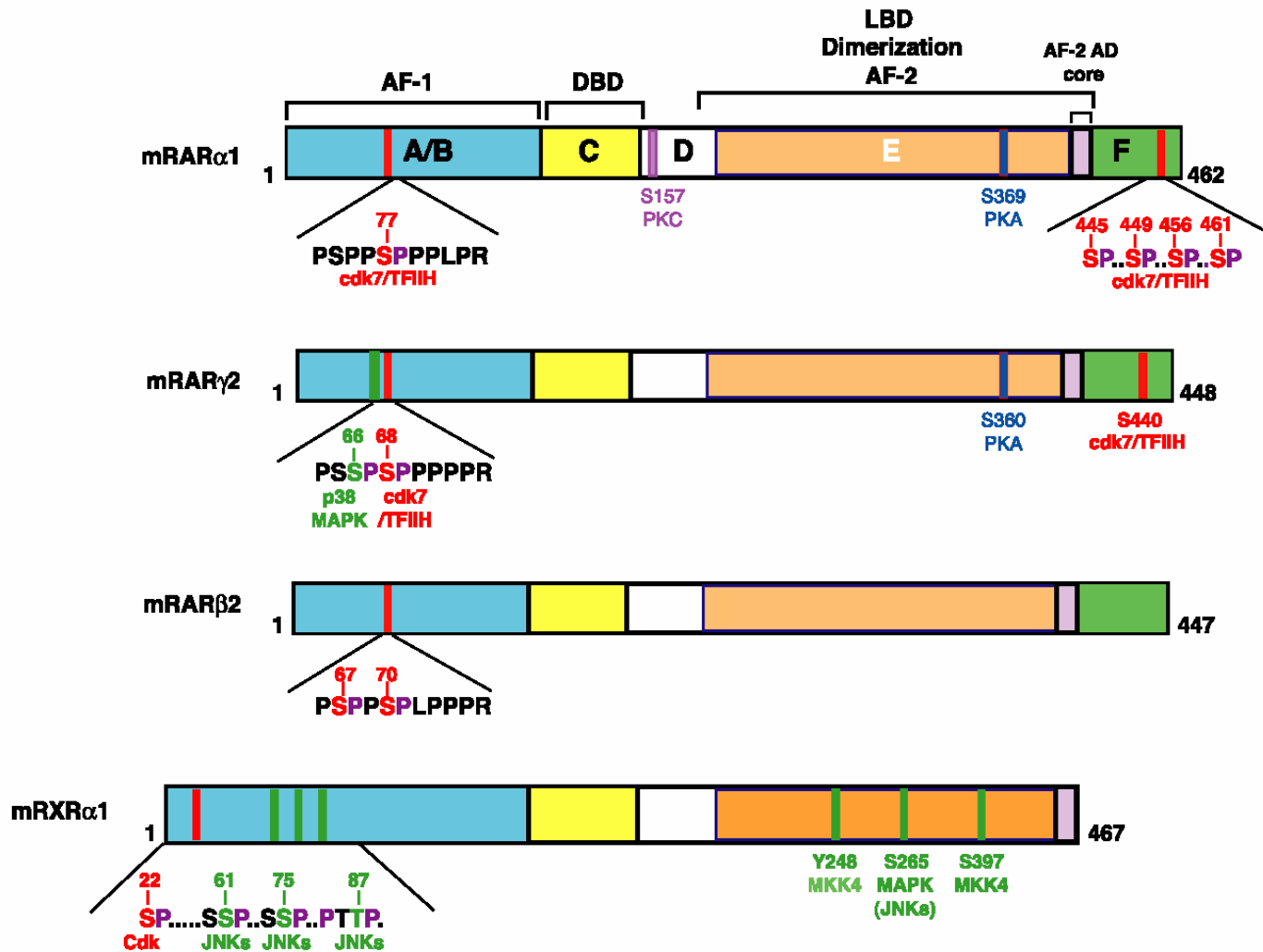

Fig. 1. Schematic representation of the functional domains and the major phosphorylation sites of nuclear retinoid receptors. The DNA-binding domain (DBD) and the ligand-binding domain (LBD) are schematically represented (not to scale). The functional AF-1 and AF-2 domains which lie in the A/B and E regions, respectively, are depicted. The target sequences for phosphorylation are also shown. MAPK, mitogen-activated protein kinase; MKK, MAPK kinase; JNK, Jun amino-terminal kinase.

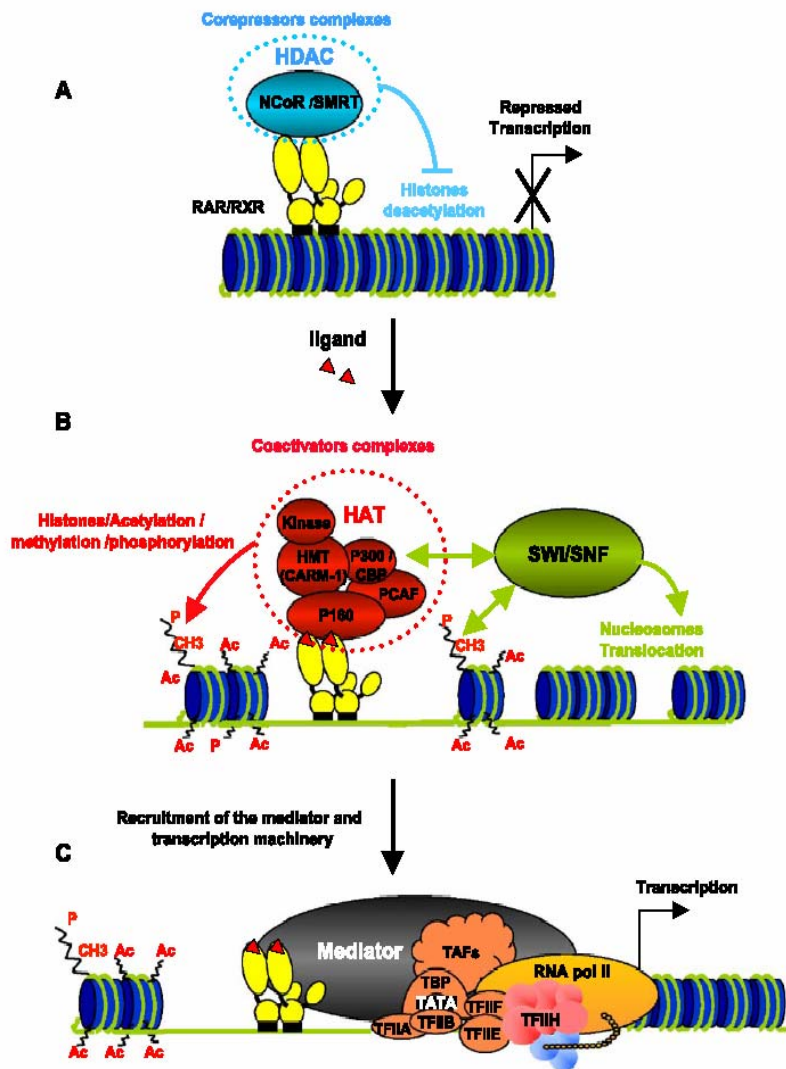

Fig. 5. Three-step mechanism of retinoid receptor action. (A) In the absence of ligand, retinoid receptors bound to response elements located in the promoter of target genes are associated with histone deacetylase-containing (HDAC) complexes tethered through corepressors and repress transcription. (B) Upon ligand binding, the corepressors dissociate, allowing the recruitment of coactivators associated with complexes displaying histone acetyltransferase (HAT), methyltransferase, kinase or ATP-dependent remodeling (SWI/SNF) activities that decompact repressive chromatin. (C) In the third step, the coactivators dissociate and the SMCC mediator complex assembles. Then the mediator expedites entry of the RNA Pol II and the general transcription factors to the promoter, resulting in transcription initiation.

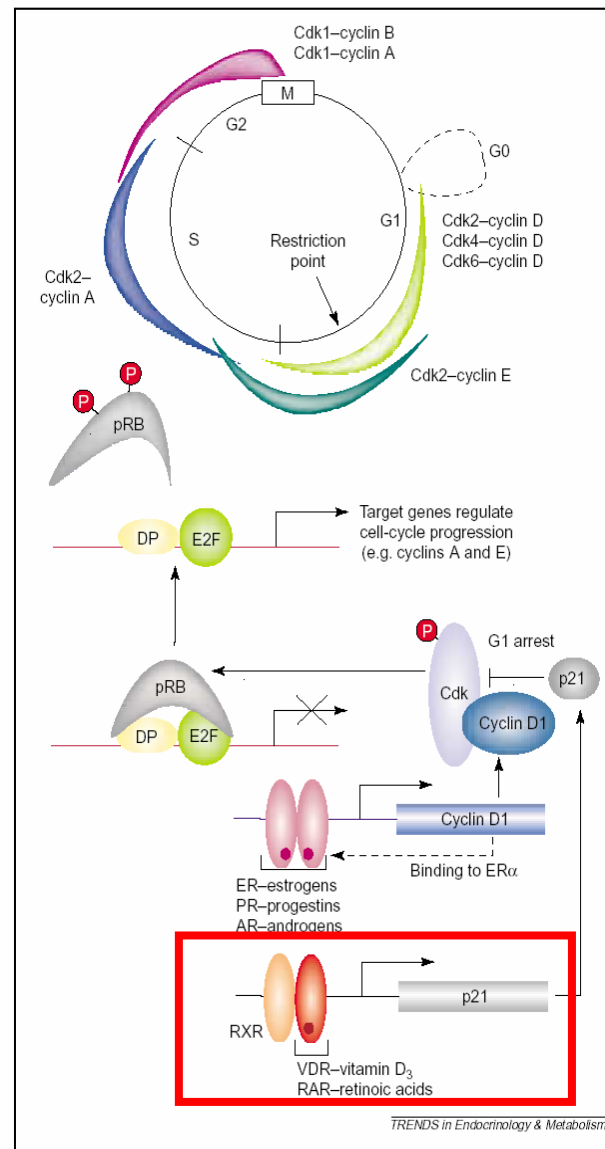

Fig. 2. Scheme illustrating cell-cycle regulation by certain nuclear receptors. The cell cycle phases G1, S, G2 and M are depicted in (a), together with a schematic illustration of the corresponding levels of the various Cdk-cyclin complexes. Some steroid receptors (ER, AR and PR) stimulate expression of the gene that encodes cyclin D1, which interacts with and activates Cdk4. The activated cyclin-Cdk complex phosphorylates pRB, which dissociates from the α -E2F complex, thus allowing transcription of cell cycle regulatory genes. In an opposite regulatory mode, vitamin D₃ and retinoic acids can induce expression of the CKI p21, which blocks Cdk activity, resulting in G1 arrest of treated cells, such as U937. Abbreviations: See Glossary.

Retinoid X Receptors (RXRs) consist of a family of nuclear receptors that target and regulate multiple signalling pathways. The early evolutionary emergence of RXRs in comparison to other nuclear receptors may have allowed for the development of unique properties as transcriptional regulators.

The complexity of these receptors is derived from their ability to activate transcription as homodimers or as obligate heterodimeric partners of a multitude of other nuclear receptors. In addition, RXRs can regulate gene expression in a ligand-dependent (forming permissive heterodimeric complexes) or - independent (forming non-permissive heterodimeric complexes) manner.

RXRs have a small ligand binding pocket and therefore bind their ligands (such as 9-*cis* RA) with both high affinity and specificity. In the presence of ligand, permissive RXR heterodimers bind coactivators, but nonpermissive complexes can bind coactivators or corepressors depending on the activation of the RXR's heterodimeric partner.

Physiologically, the temporal and tissue specific pattern of RXRs as well as the presence of phenotypic abnormalities in receptor knockout studies (most severe in RXRa $-/-$ animals) demonstrate the important role for these receptors both during development (morphogenesis) and in adult differentiated tissues (cell proliferation, cell differentiation, cell death). These receptors also play an important regulatory role metabolic signaling pathways (glucose, fatty acid and cholesterol metabolism), including metabolic disorders such as type 2 diabetes, hyperlipidemia and atherosclerosis.

RXRs function as master regulators producing diverse physiological effects through the activation of multiple nuclear receptor complexes. RXRs represent important targets for pharmacologic interventions and therapeutic applications.



Receptory aktivované peroxizómovými proliferátory (PPAR)

Ligand-independent
activation domain (AF-1)

Ligand-dependent
activation domain (AF-2)



DNA
Binding Domain
(2 zinc fingers)

Ligand Binding and
Dimerization Domains

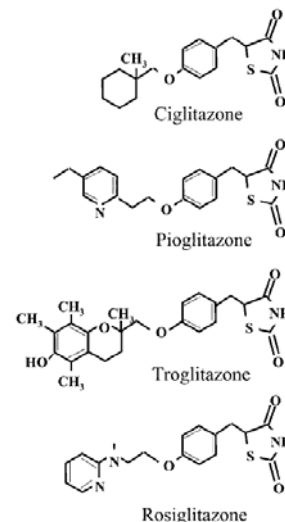
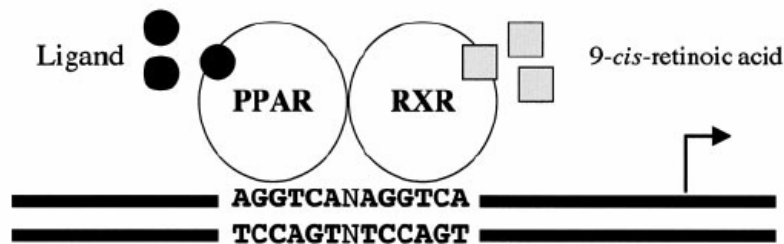
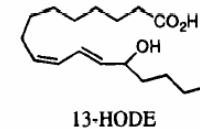
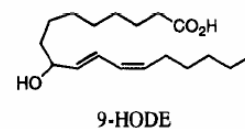
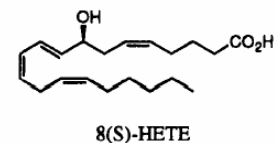
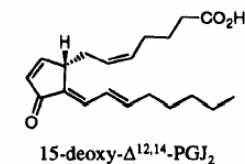
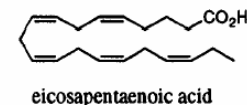
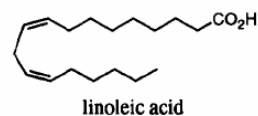
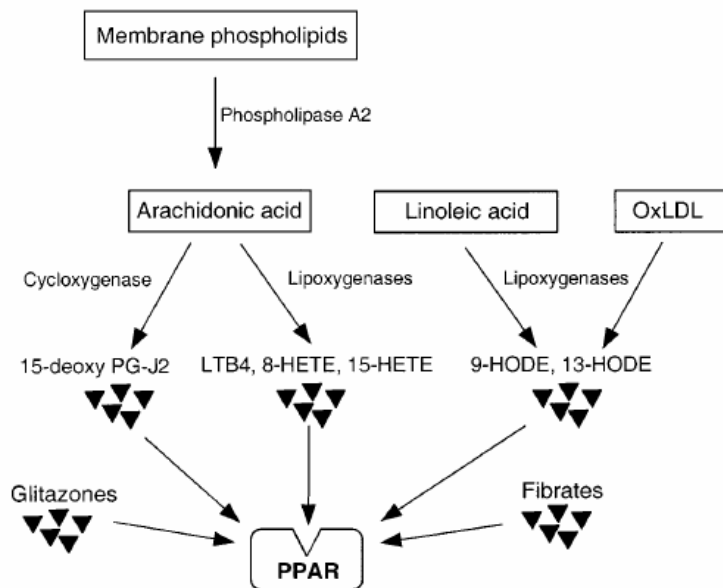

FIG. 1. General structure and mechanism of action of PPARs. PPAR isoforms share a common domain structure and molecular mechanism of action.



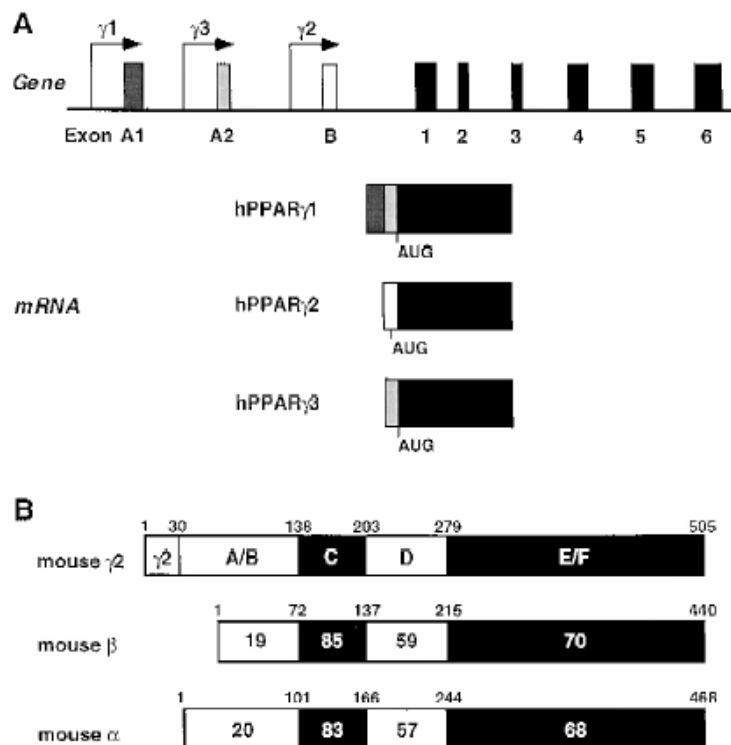

Fig. 1. Structure of PPARs. (A) Genomic organization of the human PPAR γ gene (not drawn to scale). Alternative promoter usage and splicing results in three different transcripts. PPAR γ 1, PPAR γ 2 and PPAR γ 3 are transcribed from promoters located upstream of exons A1, B and A2, respectively. PPAR γ 1 and PPAR γ 3 mRNAs encode the same protein. (B) Structural and functional domains of PPARs. γ 2: PPAR γ 2-specific N-terminus of A/B domain. A/B: N-terminal A/B domain containing a ligand-independent activation function 1 (AF-1). (C) DNA-binding domain. (D) Hinge region. (E/F): C-terminal ligand-binding domain containing the ligand-dependent activation function 2 (AF-2). Sequence similarities were determined by the BESTFIT program (GCG package) using reported mouse PPAR α [8], PPAR β [14], PPAR γ 1 [14] and PPAR γ 2 [32] sequences.

Gene	Localization of PPRE	PPRE	function of gene product
ACO	(-570/-558)	TGACCTtTGTCCT	First step in fatty acid β -oxidation
	(-214/-202)	TGACCTtCTACCT	
HD	(-2939/-2927)	TGACCTatTGAACt&TACCT	Second and third step in fatty acid β -oxidation
C-ACS	(-175/-154)	TGACTGgTGCCTgaaAGACCT	Conversion of fatty acids into acyl-CoA derivatives
CYP4A6	(-650/-662)	TCACTTtTGCCTAGTTCA	Formation of dicarboxylic acids by ω -oxidation
	(-728/-740)	GGACCTGGCCTtTGTCCT	
	(-27/-1)	TGACCTtTGCCCA	
HMG-CoAS	(-104/-92)	AGACCTtTGCCCC	Liver ketogenesis
MCAD	(-301/-336)	TGGTCAgcctTCACCT-TTACCcgagagaa AGGTCA	First step in β -oxidation of medium-chain fatty acids
L-FABP	(-68/-56)	TGACCTaTGGCCT	Liver fatty acid binding protein
aP2	(-5222/-5209)	GGATCAgAGTTCA	Adipose tissue fatty acid binding protein
ME	(-328/-340)	TCAACTtTGACCC	Malate decarboxylation, providing NADPH for fatty acid synthesis
PEPCK	(-999/-987)	AGACCT-TATCCC	Gluconeogenesis and glyceroneogenesis
LPL	(-169/-157)	TGCCCTtTCCCC	Hydrolysis of triglyceride-rich particles
apo A-I	(-212/-197)	TGAACCctTGACCCtTGCCCT	Protein component HDL, co-factor LCAT
apoA-II	(-734/-716)	CAACCTtTACCT	Protein component HDL
Consensus		TGACCT _g TGACCT	

Fig. 2. Functional PPRES. The DR-1s are indicated by a solid arrow which is indicated above the sequence when the coding strand is depicted; a dotted arrow indicates eventual additional half sites located adjacent to the DR-1 element. Abbreviations used in this figure include: ACO, acyl-CoA oxidase; ACS, acyl-CoA synthetase; aP2, adipocyte fatty acid binding protein P2; apo, apolipoprotein; L-FABP, liver fatty acid binding protein; HD, enoyl-CoA hydratase-3-hydroxyacyl-CoA dehydrogenase; HMG-CoAS, HMG-CoA synthase; LPL, lipoprotein lipase; MCAD, medium-chain acyl-CoA dehydrogenase; ME, malic enzyme.

The **peroxisome proliferator-activated receptors (PPAR α , γ , δ)** are activated by polyunsaturated fatty acids, eicosanoids, and various synthetic ligands. Consistent with their distinct expression patterns, gene-knockout experiments have revealed that each PPAR subtype performs a specific function in fatty acid homeostasis.

PPAR α is a global regulator of fatty acid catabolism. PPAR α activation up-regulates the transcription of liver fatty acid-binding protein, which buffers intracellular fatty acids and delivers PPAR α ligands to the nucleus. In addition, expression of two members of the adrenoleukodystrophy subfamily of ABC transporters, ABCD2 and ABCD3, is similarly up-regulated to promote transport of fatty acids into peroxisomes where catabolic enzymes promote β -oxidation. The hepatocyte CYP4A enzymes complete the metabolic cascade by catalyzing ω -oxidation, the final catabolic step in the clearance of PPAR α ligands.

PPAR γ was identified initially as a key regulator of adipogenesis, but it also plays an important role in cellular differentiation, insulin sensitization, atherosclerosis, and cancer. Ligands for PPAR γ include fatty acids and other arachidonic acid metabolites, antidiabetic drugs (e.g., thiazolidinediones), and triterpenoids. In contrast to PPAR α , PPAR γ promotes fat storage by increasing adipocyte differentiation and transcription of a number of important lipogenic proteins.

Ligands for **PPAR δ** include long-chain fatty acids and carboprostacyclin. Pharmacological activation of PPAR δ in macrophages and fibroblasts results in up-regulation of the ABCA1 transporter, and because of its widespread expression, PPAR δ may affect lipid metabolism in peripheral tissues.

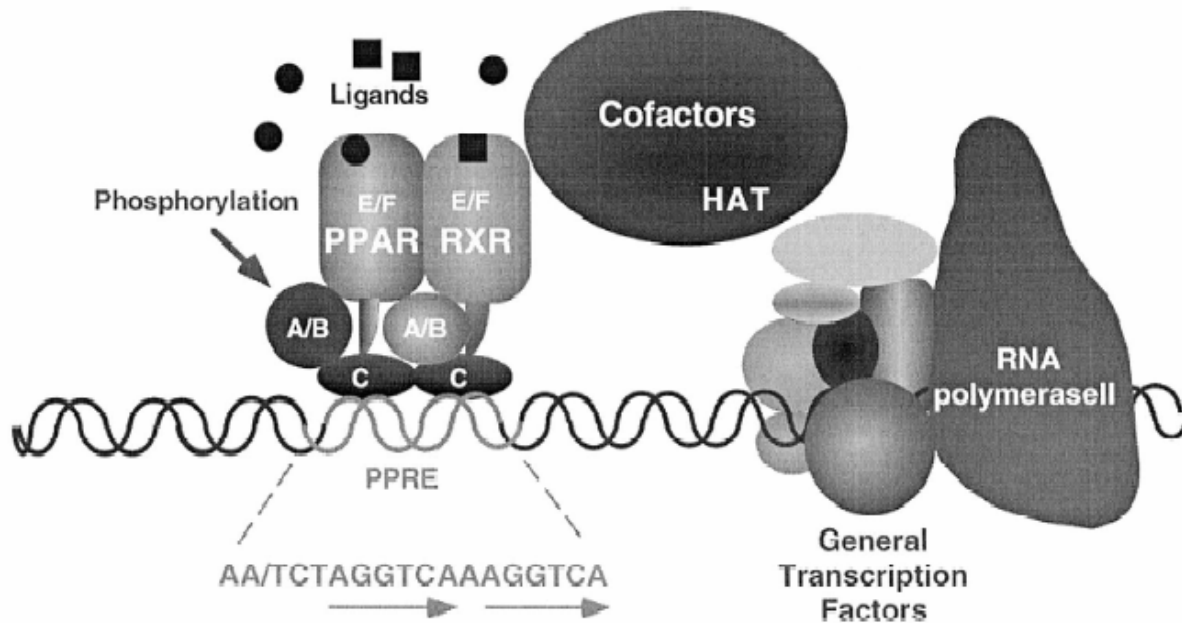

Fig. 3. Mechanisms of transactivation. The PPAR/RXR heterodimer binds to a PPRE (PPAR-response elements) located in the promoter of target genes through the C domain (DNA-binding domain) of PPAR and RXR. Receptor activity is regulated by both phosphorylation of A/B domain and ligand-binding by E/F domain (ligand-binding domain). The activated PPAR/RXR heterodimer associates with cofactors containing histone acetyl-transferase activity (HAT), modifying nucleosome structure and contacting general transcription factors.

A**Wy 14,643****ETYA****Clofibrate****Bezafibrate****GW2331****Indomethacin****GW2433****BRL49653
(Rosiglitazone)****B****Linolenic acid****Linoleic acid****9-HODE****13-HODE****Arachidonic acid****8(S)-HETE****Leukotriene B4****15-deoxy-Δ12,14-
-Prostaglandin J2****Eicosapentaenoic acid**

Fig. 4. Natural and synthetic PPAR ligands. (A) Synthetic PPAR agonists comprise peroxisome proliferators (Wy 14,643), fatty acid analogs (ETYA), fibrates (Clofibrate, Bezafibrate, GW2331, GW2433), non-steroidal anti-inflammatory drugs (Indomethacin) and thiazolidinediones (Rosiglitazone). (B) Natural PPAR agonists comprise polyunsaturated fatty acids and their metabolites.



Endocrine disrupting compounds (EDCs)

Hormone Systems That Can Be Affected

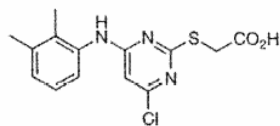
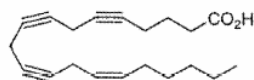
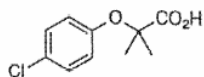
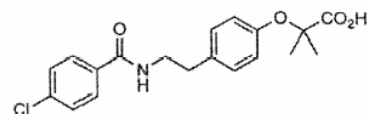
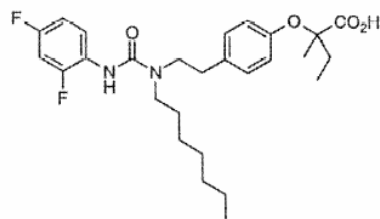
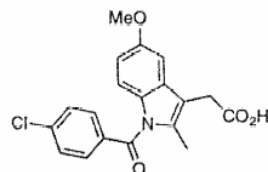
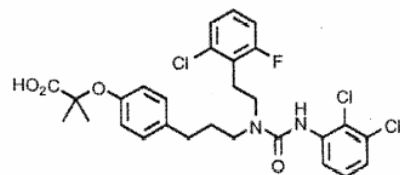
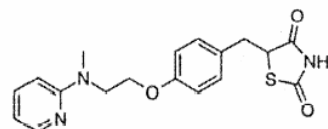
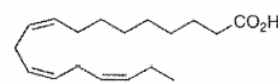
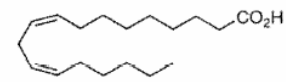
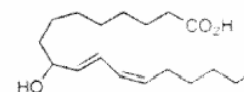
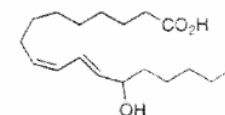
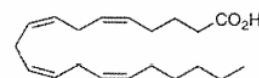
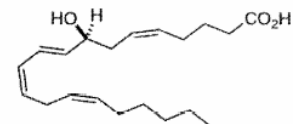
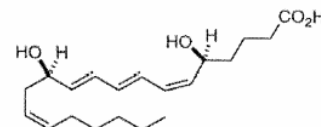
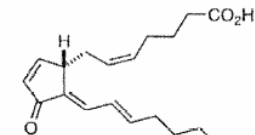
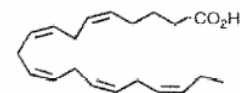
<i>Endocrine system</i>	<i>Functions</i>
Glucocorticoids	Glucose, carbohydrate, lipid, protein metabolism
Estrogen, Androgen	Sexual development
Progesterone	Menstruation cycle, synthesis of testosterone
Thyroid	Brain development, behaviour
Retinoids	Cell differentiation, Embryonal development

The Range of EDCs which harm humans or wildlife

Pesticides & Herbicides	DDT, Atrazine, and many others
Metals	Arsenic, Cadmium, Lead, Mercury
Pharmaceuticals	Birth control pills, DES, Cimetidine
Plastics and their additives	Phthalates, Bisphenol A, Heavy Metals
Industrial products and by-products	Dioxins, PCBs, PAHs, BFRs