

3. DEVELOPMENT OF MUSCLE, CARTILAGE AND BONE

Contribution of Embryonic Cells to the Developing Limb Bud

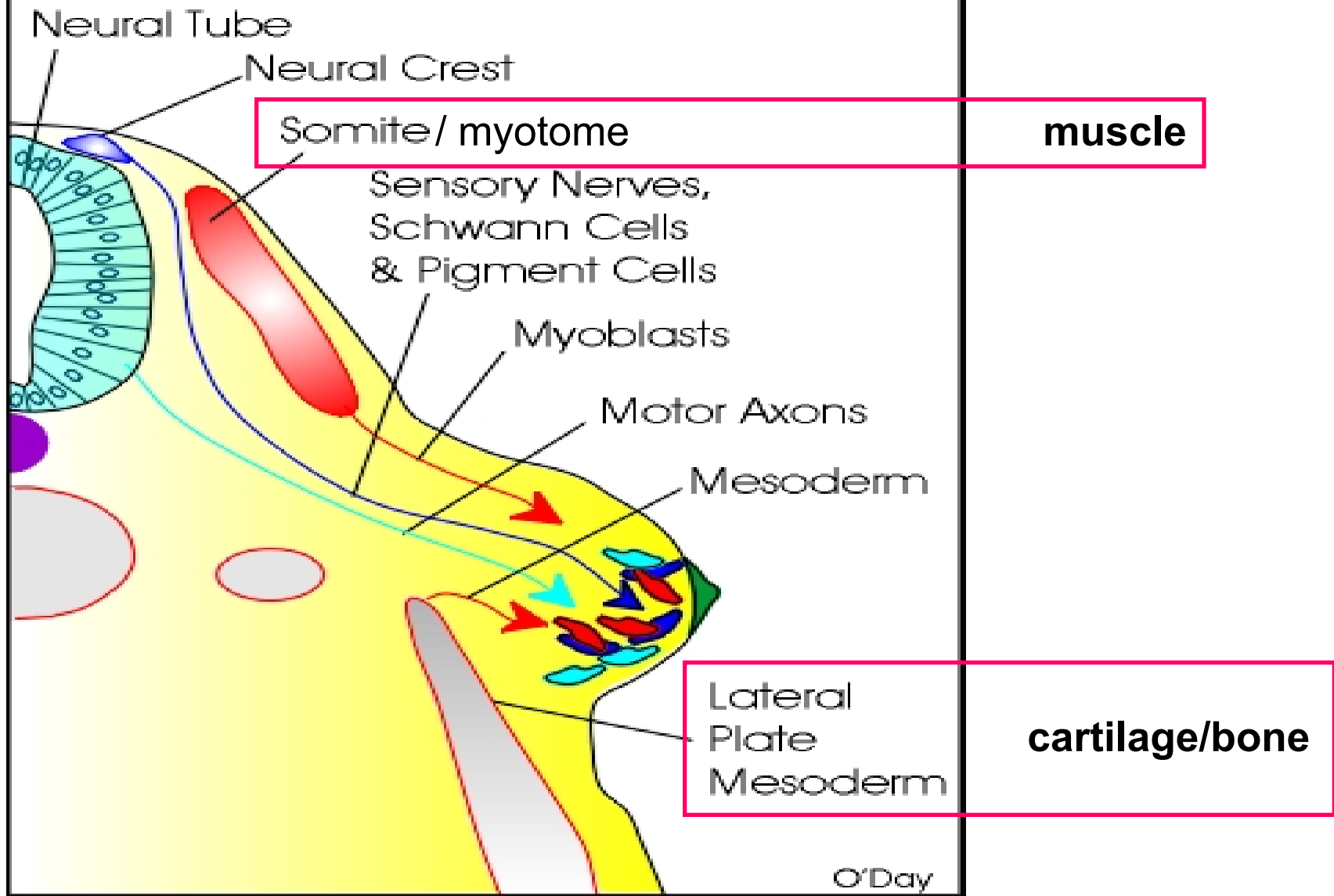

(A)

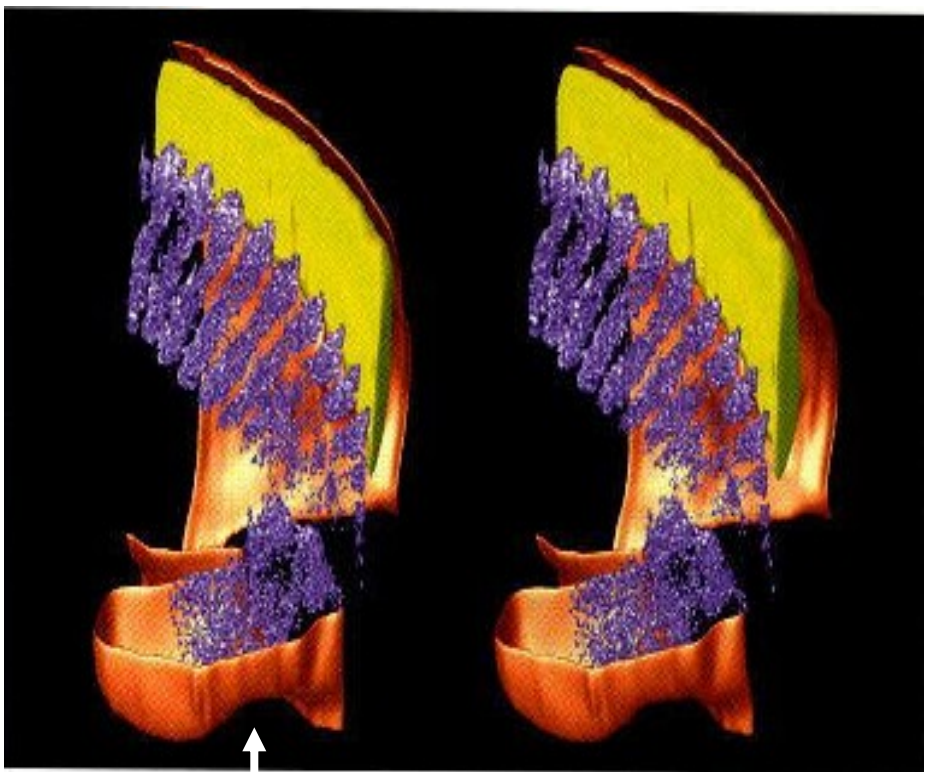
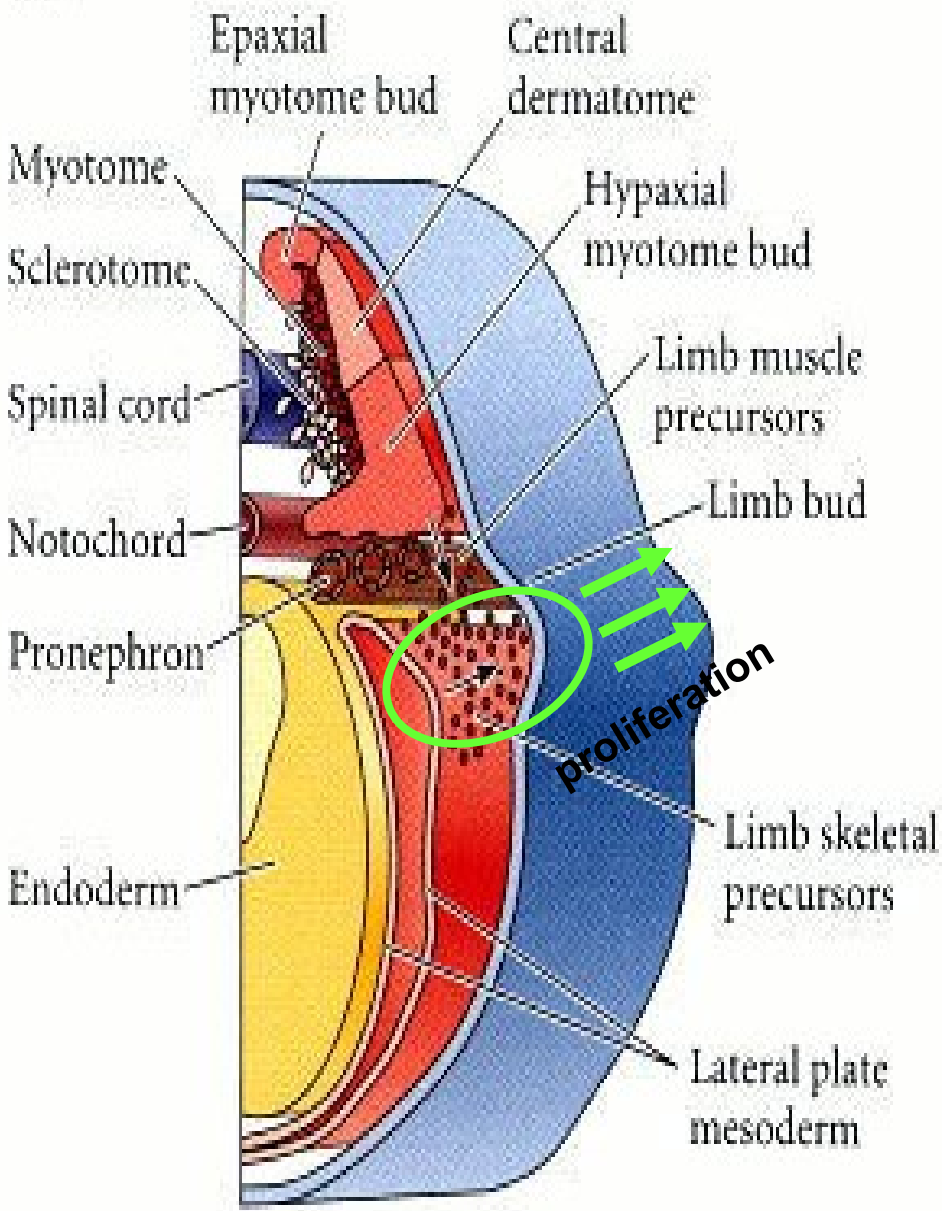

Limb bud (myotome cells in purple)

AT THE BEGINNING THERE WAS VITAMIN A.....

LETTERS TO NATURE



Limbs generated at site of tail amputation in marbled balloon frog after vitamin A treatment

P. Mohanty-Hejmadi, S. K. Dutta & P. Mahapatra

Department of Zoology, Utkal University, Bhubaneswar 751004, Orissa, India

NI AZI and Saxena¹ first observed that vitamin A has an inhibitory and modifying influence on tail regeneration in *Bufo andersonii* tadpoles. A positive relationship was later found between the inhibiting influence of vitamin A and the developmental stage of the regenerating tail in the same species². There have been several subsequent reports³⁻⁷ on the effects of vitamin A and its derivatives on limb development and regeneration. Thus in regenerating amphibian limbs, application of retinoids produces pattern duplication in the proximodistal and anteroposterior axes of the limb^{3,8,9}, and local application of retinoic acid to the anterior side of developing chick limbs causes duplications in the anteroposterior axis of limb^{10,11}. Here we show that vitamin A can cause limb development when applied to amputated tail stumps of the tadpoles of the marbled balloon frog *Uperodon systoma* (Anura Microhylidae). This is the first report of homeotic transformation mediated through vitamin A in vertebrates.

Following amputation through the middle of the tail at the hind-limb bud stage, tadpoles were exposed to a solution of 10 IU per ml vitamin A palmitate (Arovit, Roche; see Table 1 for details) for 24 h (set I), 48 h (set II), 72 h (set III), 96 h (set

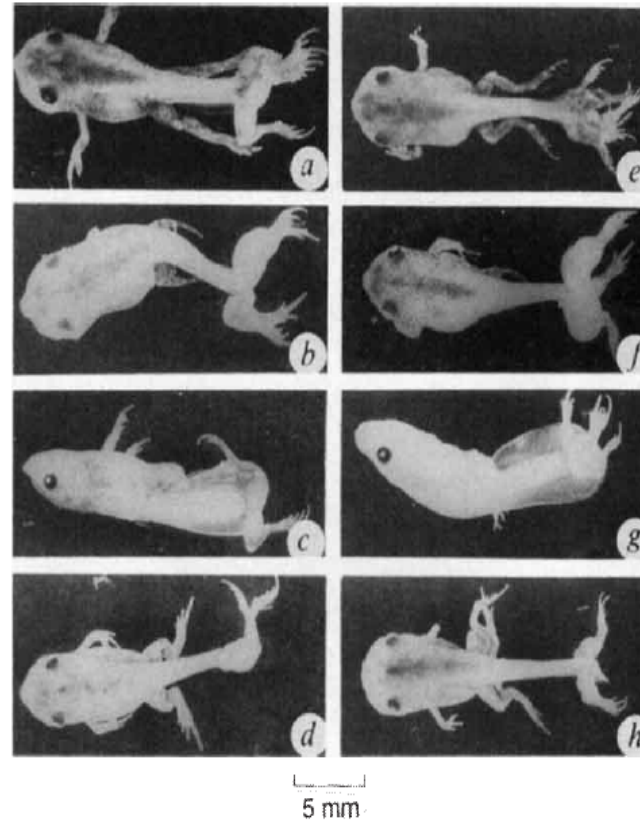
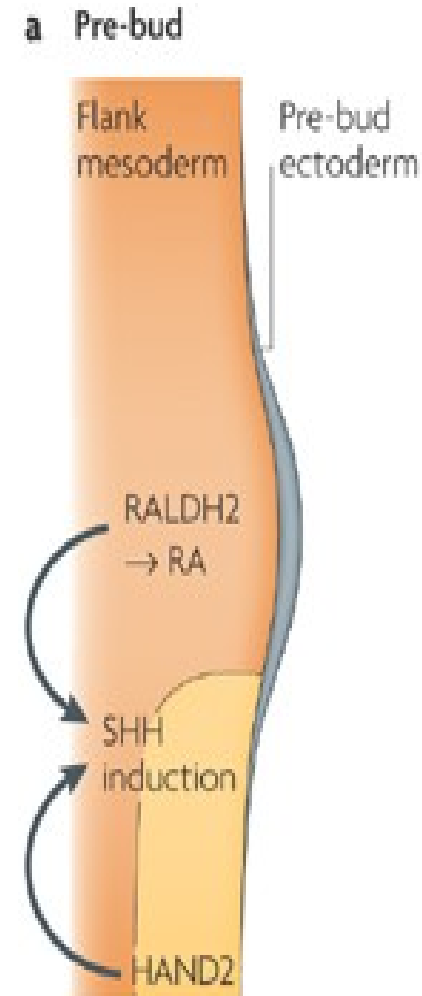

FIG. 1 Effects of vitamin A (10 IU) treatment for various times on limb generation from amputated tail stump. a, Treatment for 24 h, 3 limbs are generated; b, 72 h, 4 limbs; c and d, 96 h, 2 limbs; e, 120 h, 7 limbs; f, 120 h, 3 limbs; g, 144 h, 3 limbs; h, 144 h, 2 limbs, plus an extra pair of limbs below the original hindlimb.



Nature. 1992 Jan 23;355(6358):352-3.

RALDH2- retinaldehyde dehydrogenase 2

.....LATER CAME TBX

DNA binding domain derived from the prototype gene called transcription factor T. Limb identity factors Tbx4 (hindlimb) and Tbx5 (forelimb)

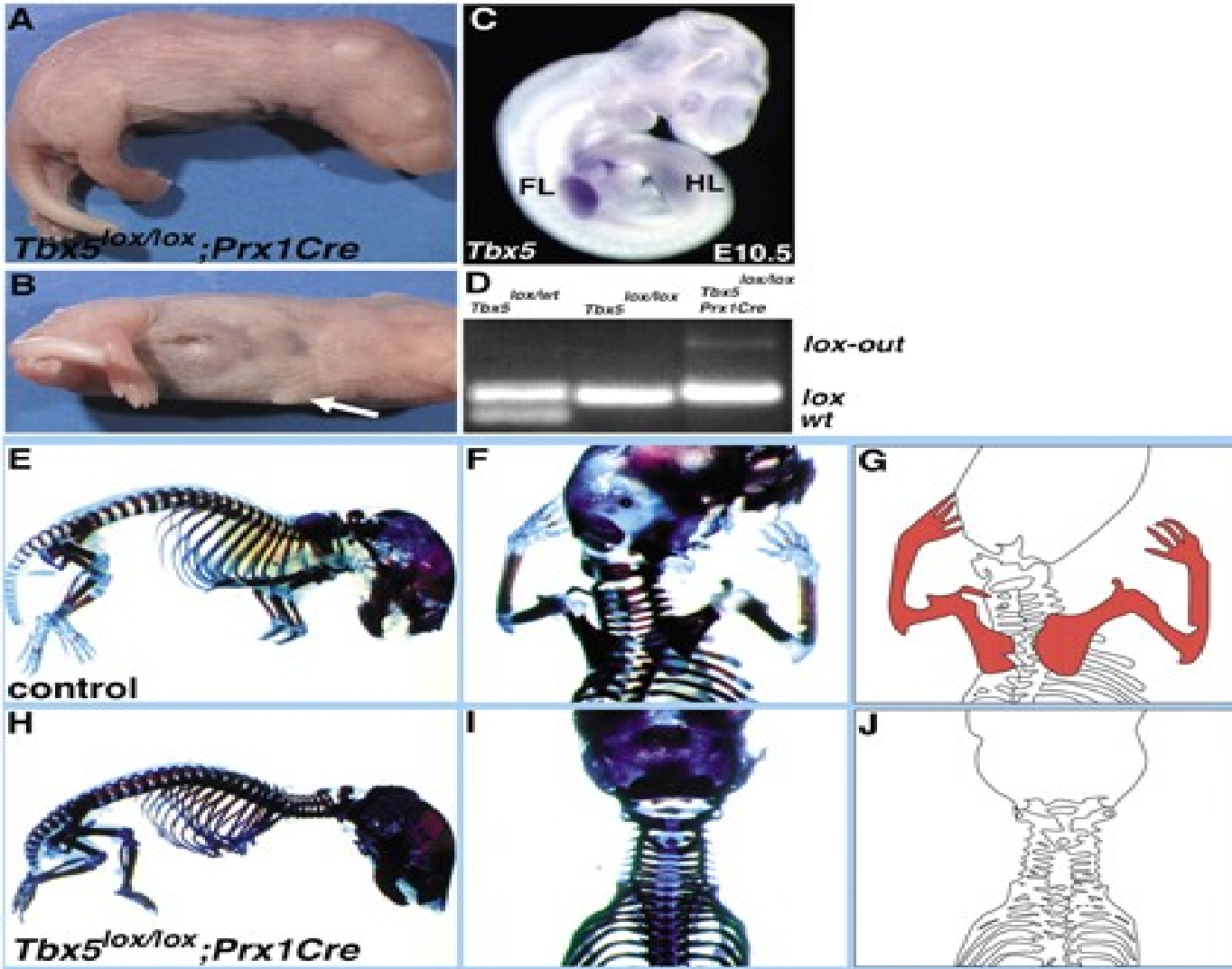

Stage 14/15

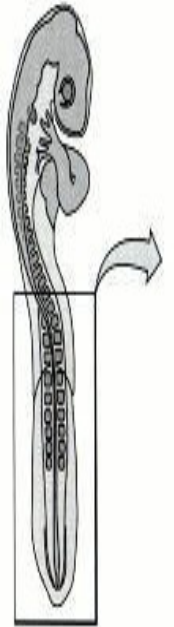

(A) Normal

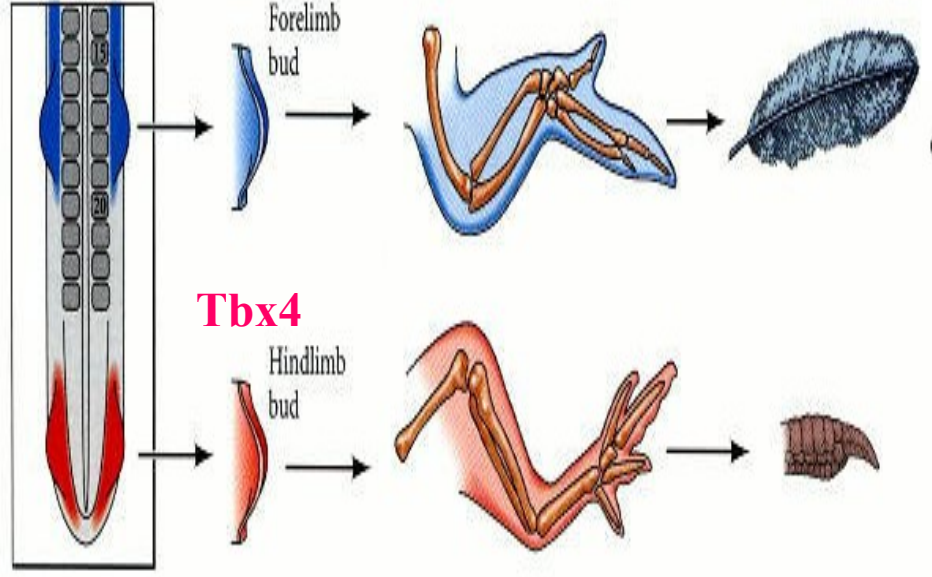

(B) FGF induced

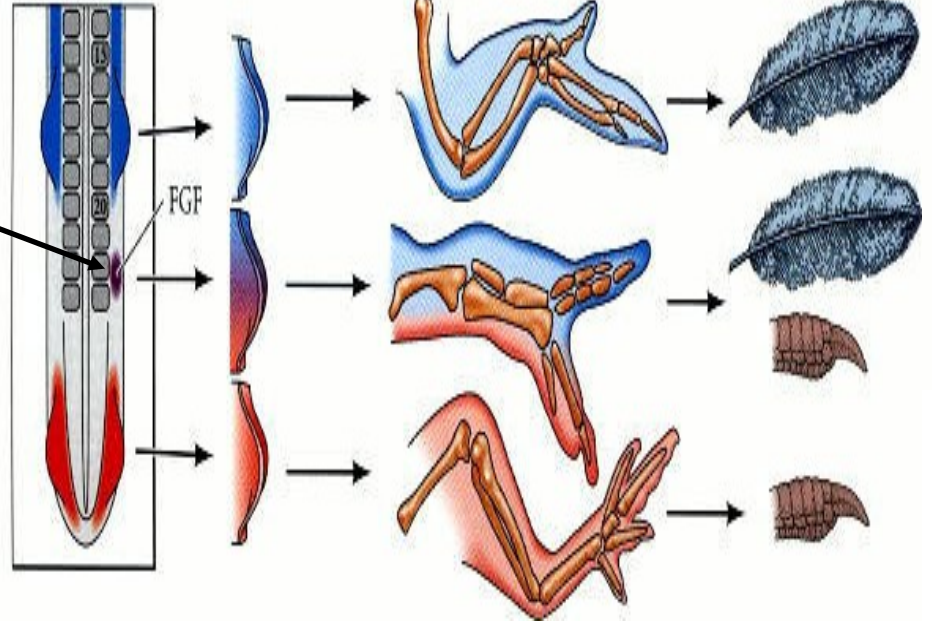

Limb bud induced by implantation of FGF-bead

Tbx5

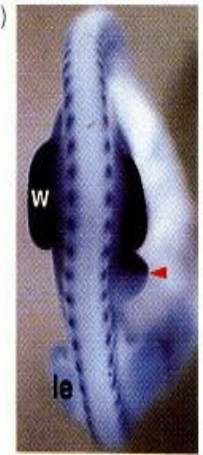

Tbx4

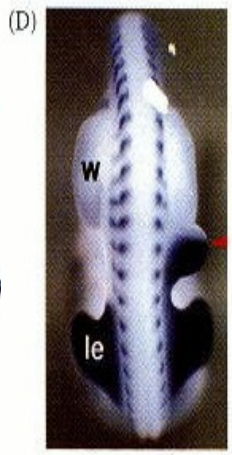

(E)

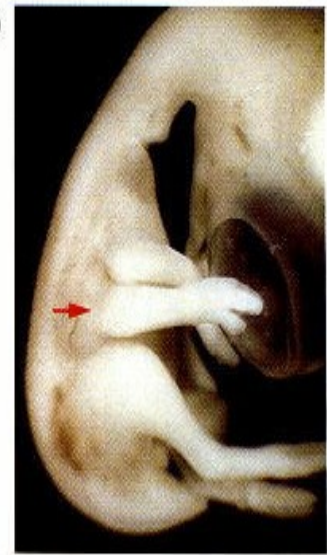

(F)



RA → Hox6 (limb field) → Tbx (limb identity) → limb growth/patterning

Initiation: *Tbx5* - dependent

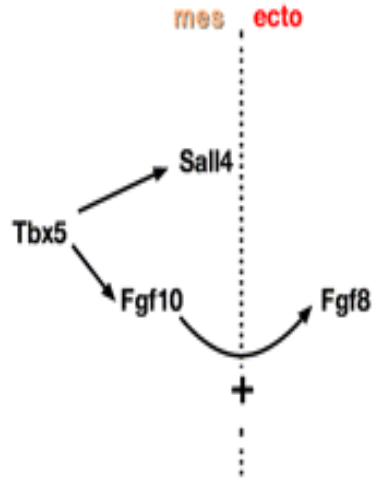
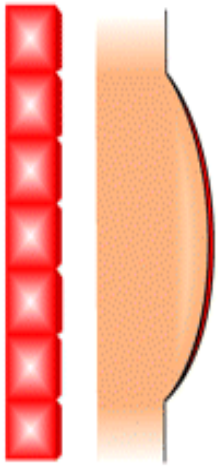

AER

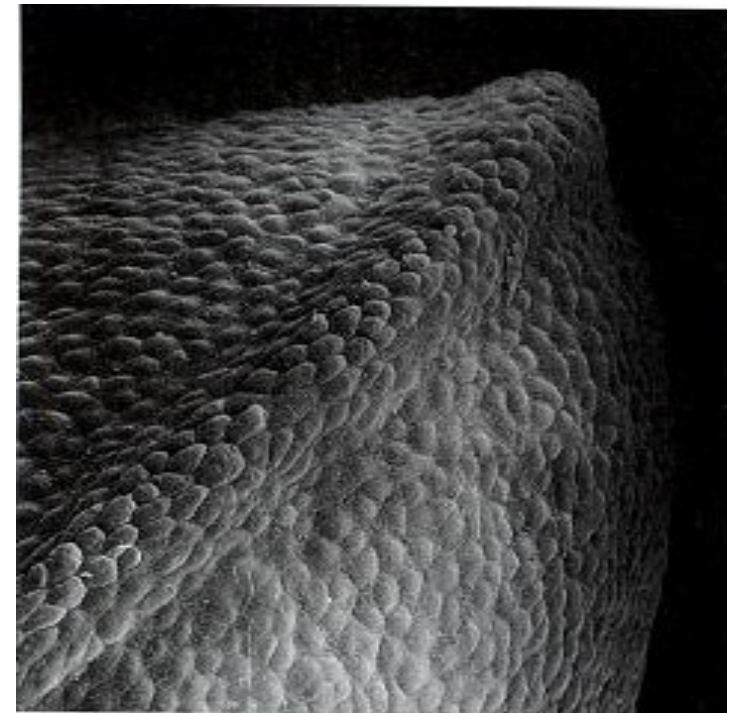
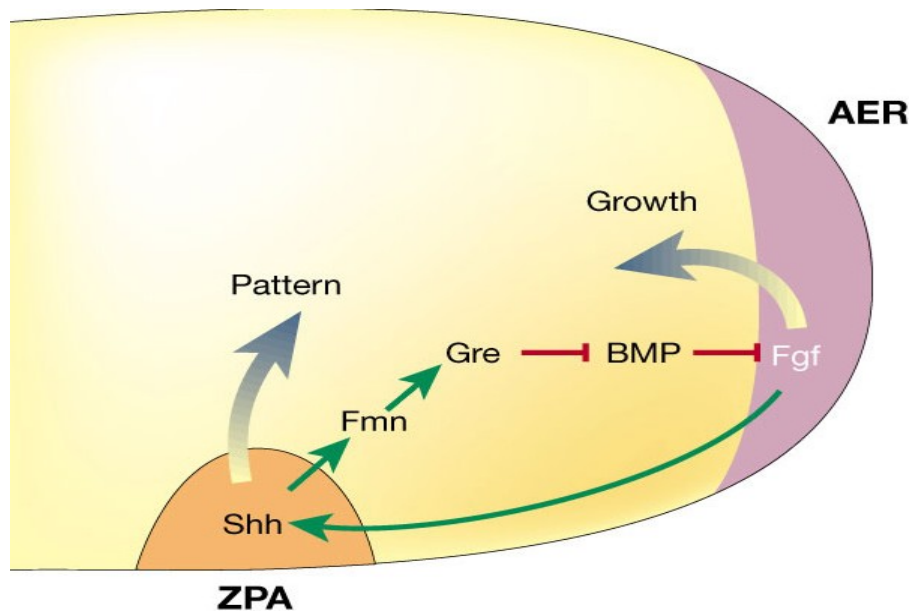
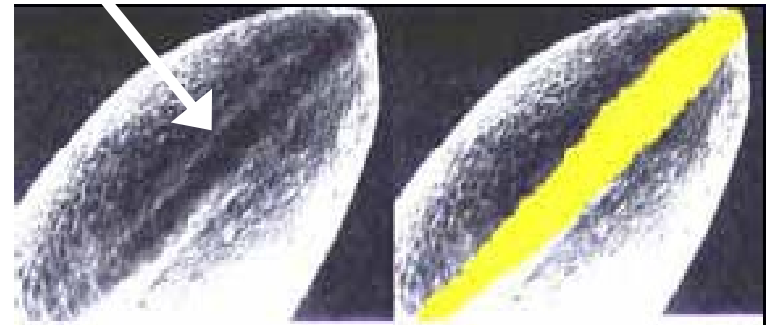

.....FOLLOWED BY FGF

FGF10 → proliferation in the mesoderm → limb bud growth

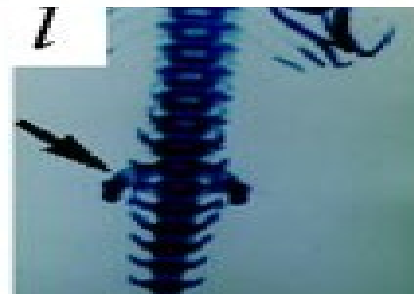
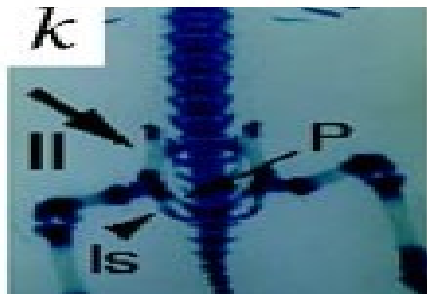
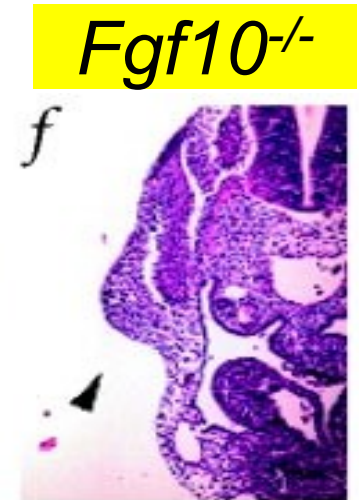
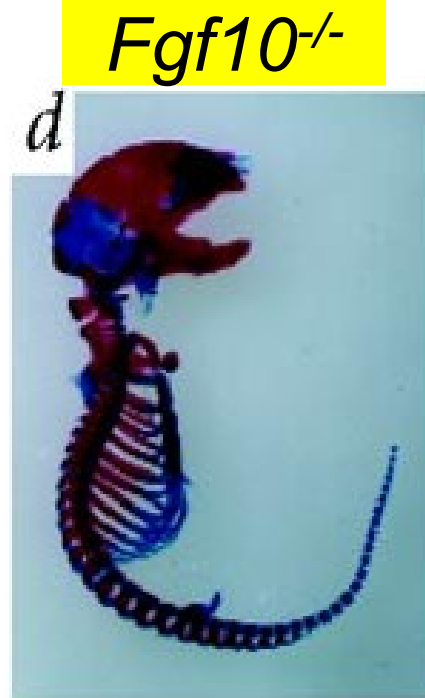
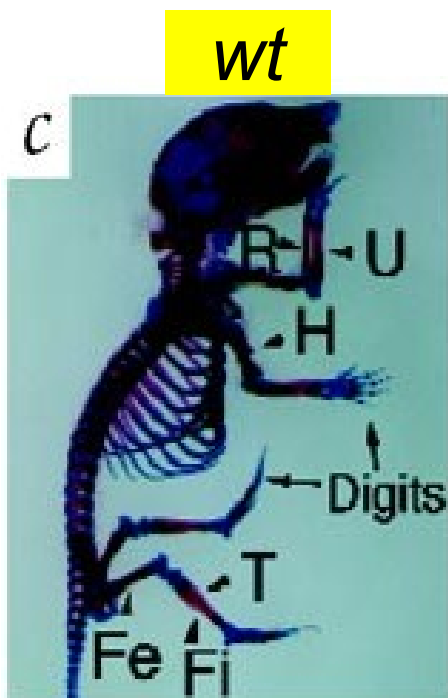

Fgf-10 is required for both limb and lung development and exhibits striking functional similarity to *Drosophila* branchless

Hosung Min, Dimitry M. Danilenko, Sheila A. Scully, et al.

Genes Dev. 1998 12: 3156-3161

Access the most recent version at doi:[10.1101/gad.12.20.3156](https://doi.org/10.1101/gad.12.20.3156)

.....FOLLOWED BY SHH

SHH function: normal attenuated lost

Forelimbs

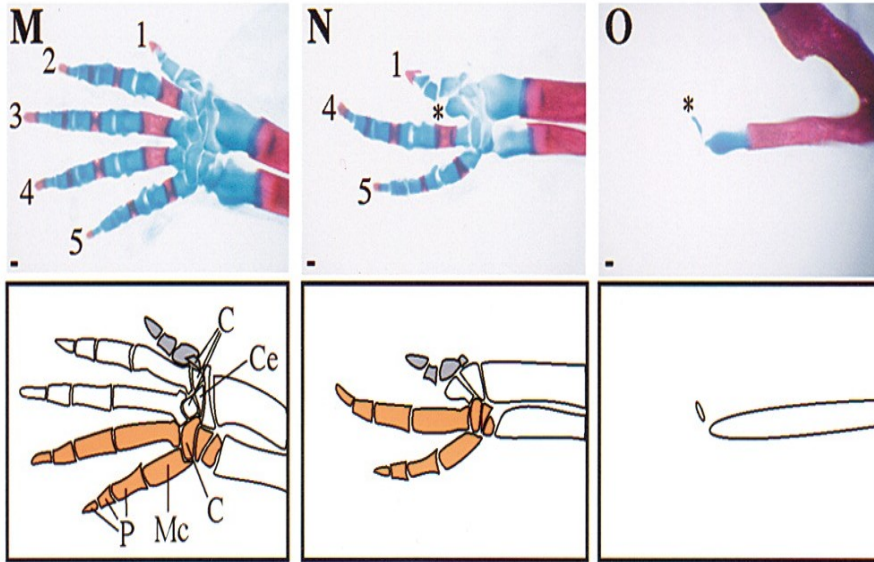

Hindlimbs

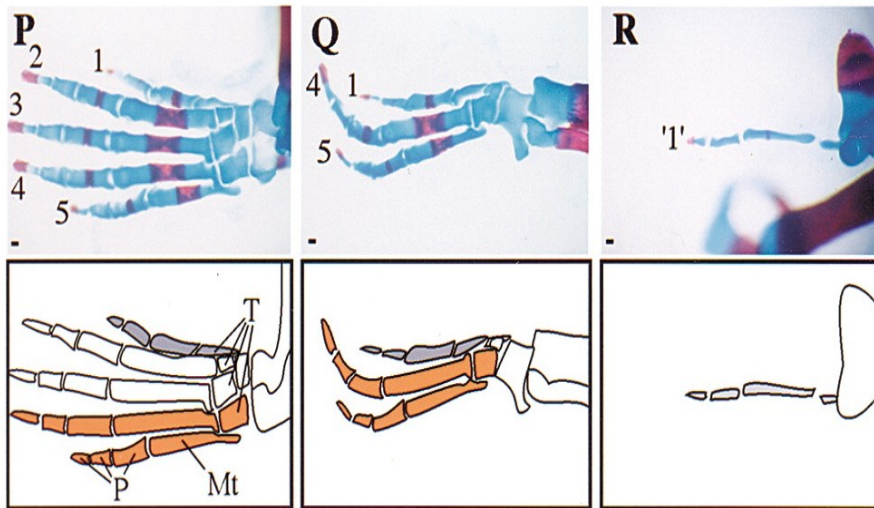

Forelimb

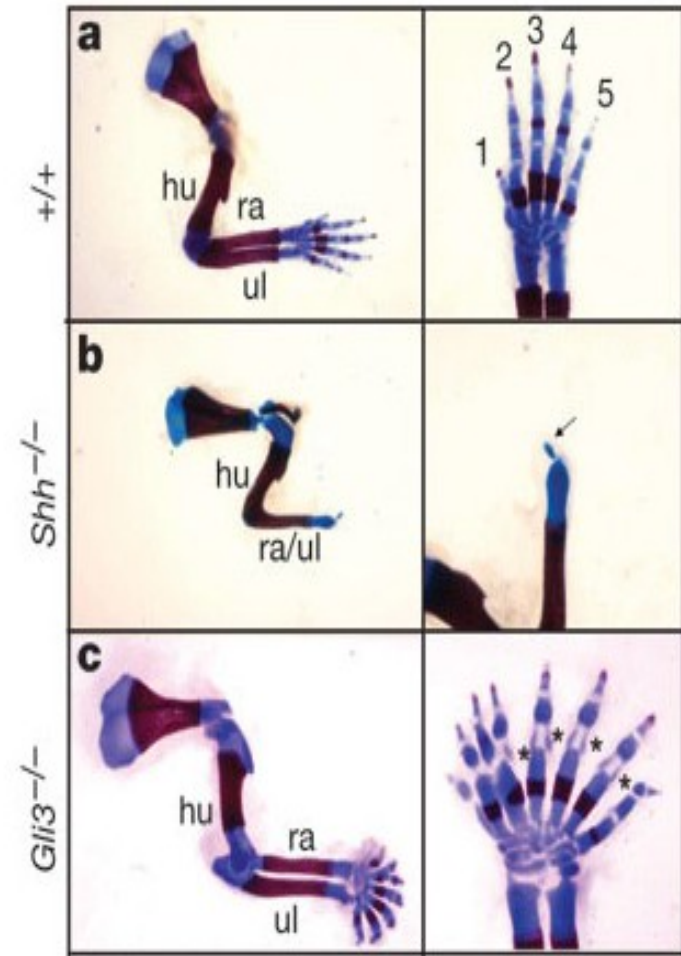

Nature 418, 979-983 (29 August 2002)

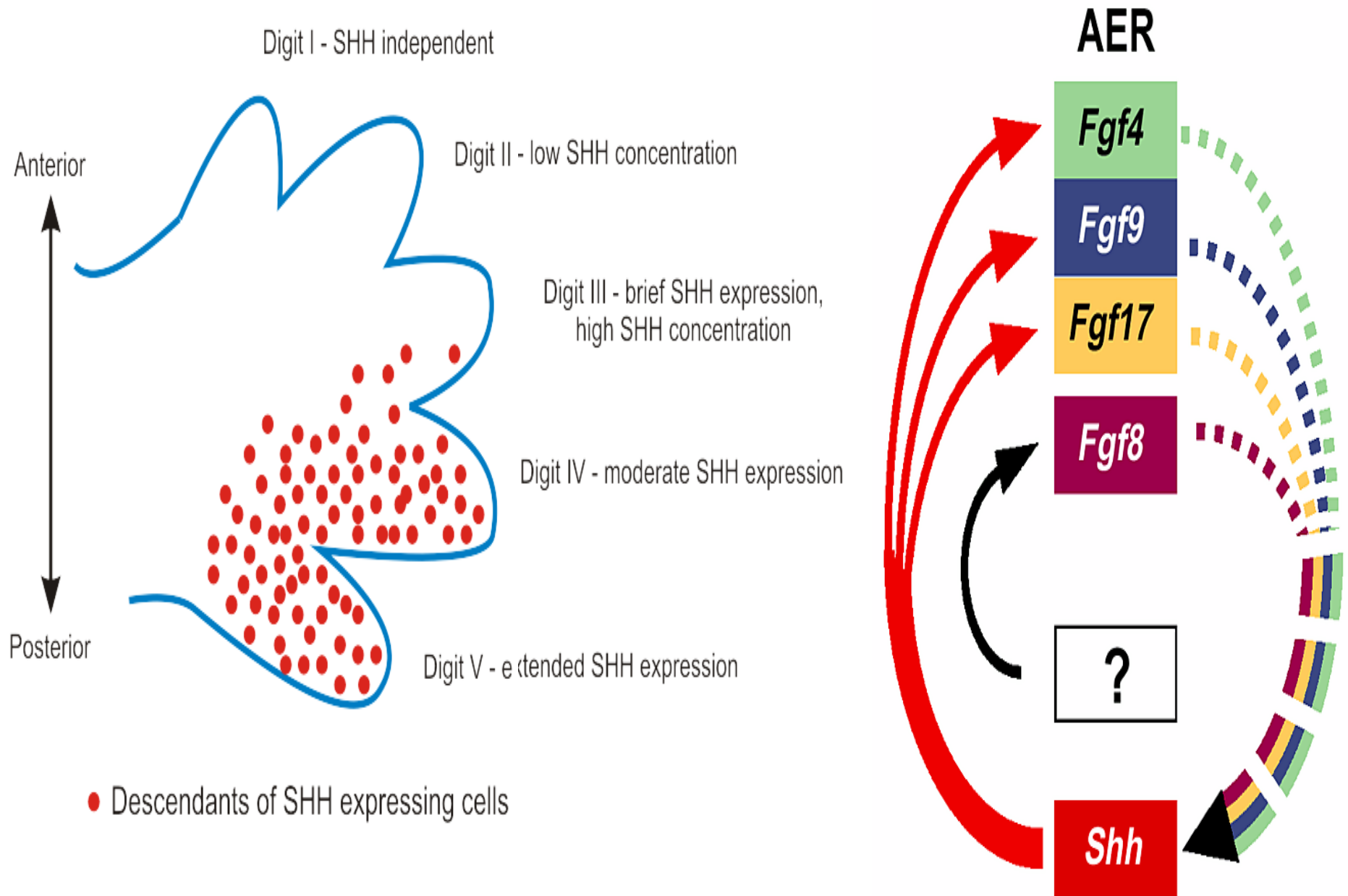

a Normal FL and HL

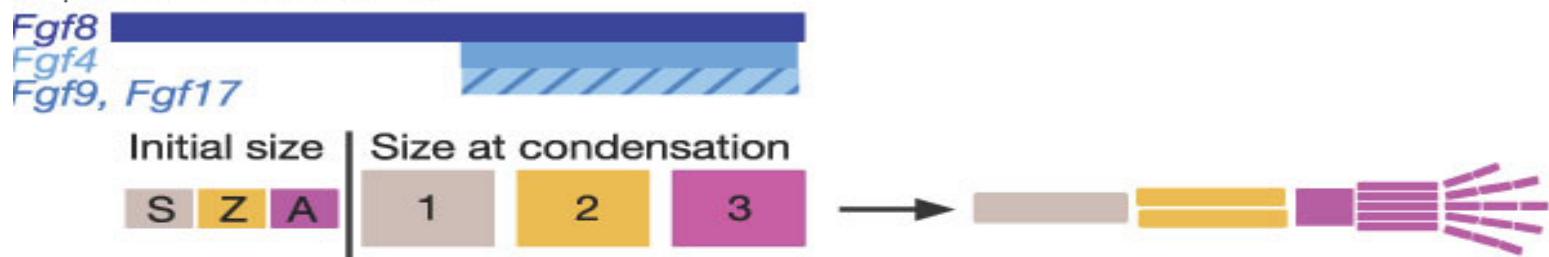

AER KO mutant phenotypes

b *Fgf8* single KO FL

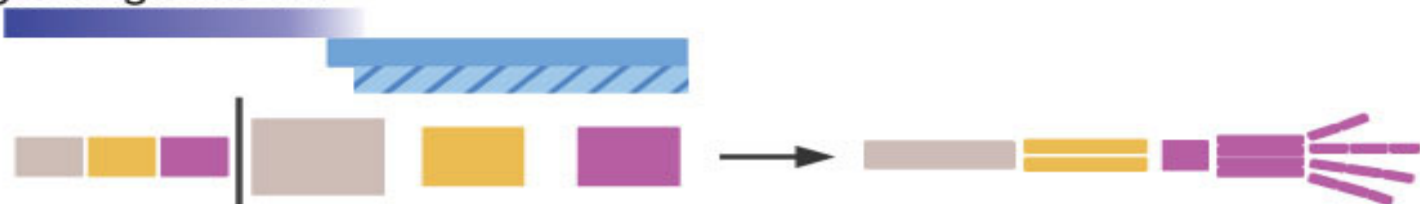

c *Fgf4; Fgf8* double KO FL

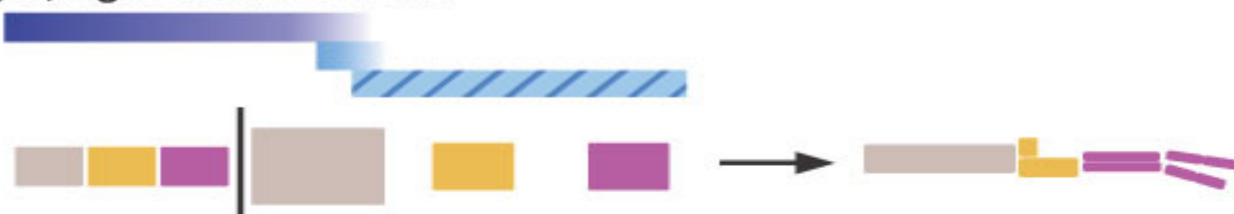

d *Fgf8* single KO HL



e *Fgf4; Fgf8* double KO HL



MUSCLE DIFFERENTIATION BY BASIC HELIX-LOOP-HELIX (bHLH) FACTORS

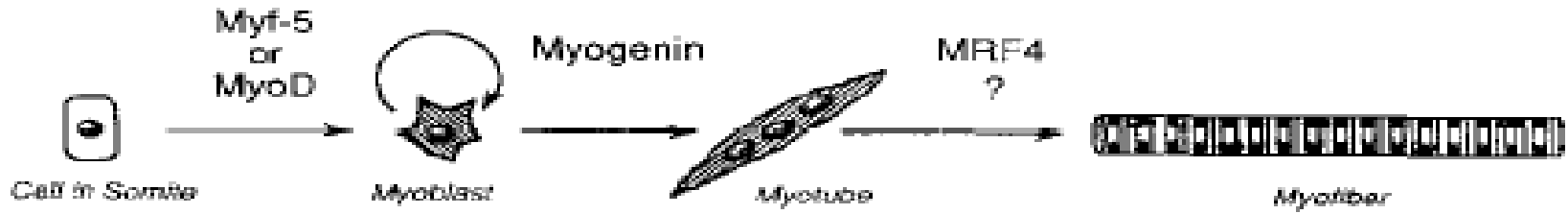

MyoD^{+/-} *Myf-5*^{+/-}

MyoD^{-/-} *Myf-5*^{-/-}

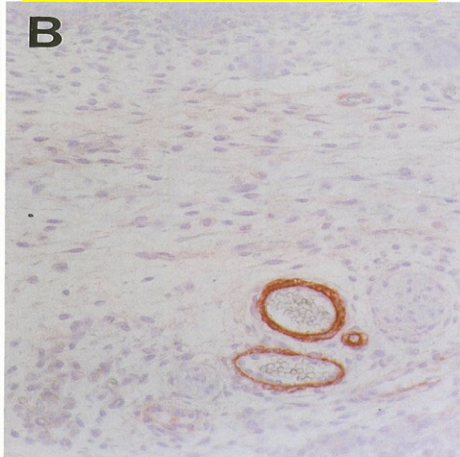
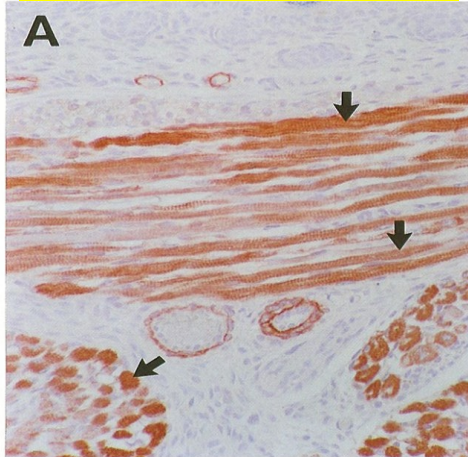

α -actin IHC
(smooth and striated muscle fibers)

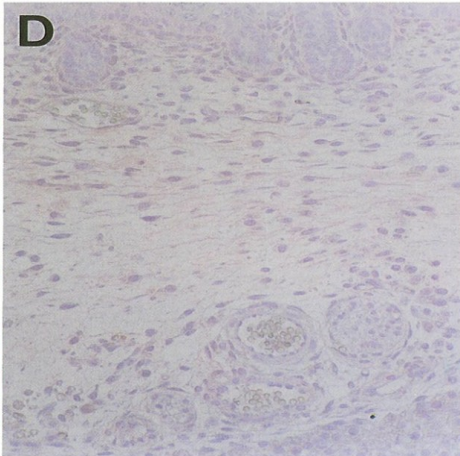
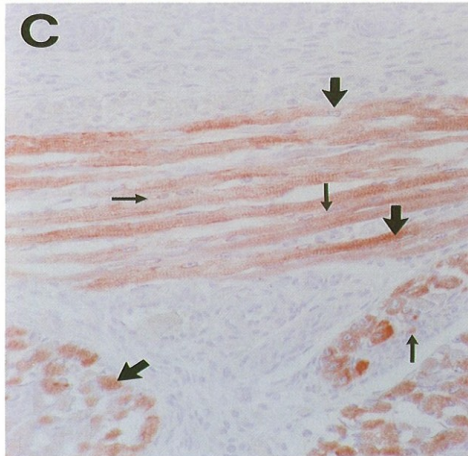

desmin IHC
(skeletal muscle fibers, myoblast-like cells)

CARTILAGE DIFFERENTIATION BY SOX9 (Sry-Box9)

wt

Sox9^{+/-}

Sox9^{-/-}

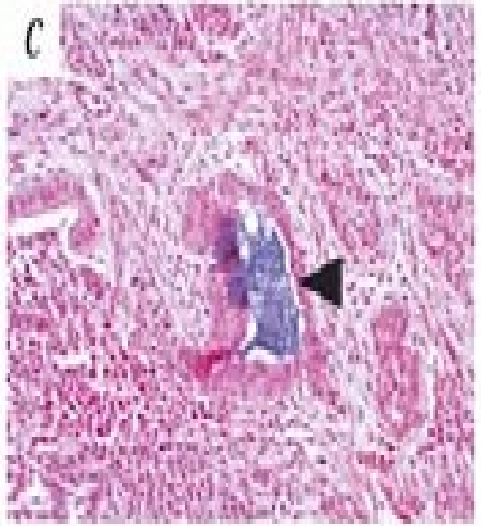
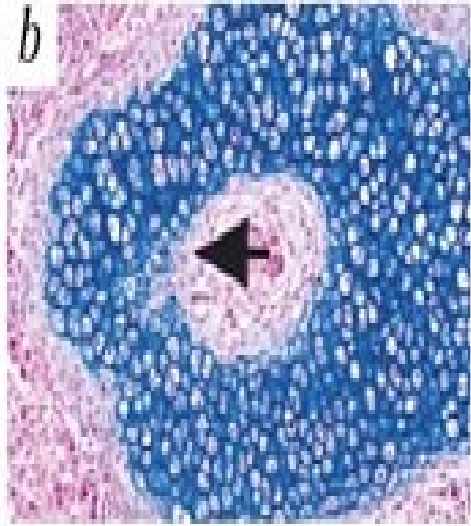

alcian blue

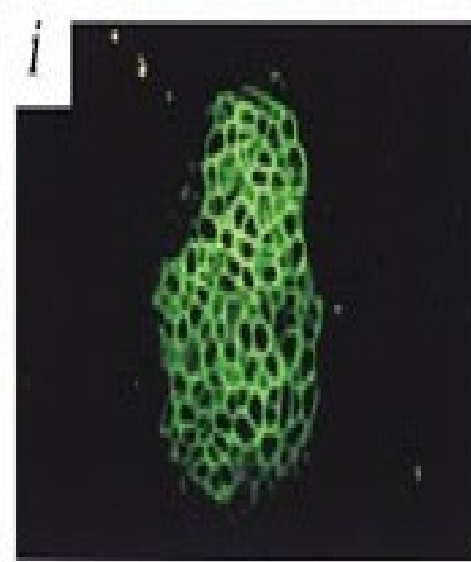
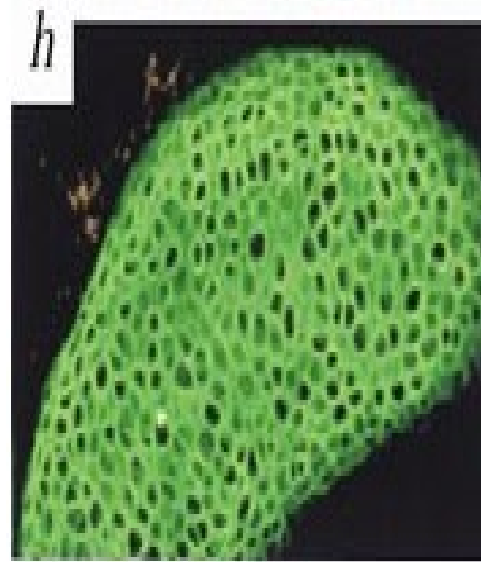

collagen type II

BONE DIFFERENTIATION BY CBFA1 (RUNX2)

Runx2 (Runt-related transcription factor 2)

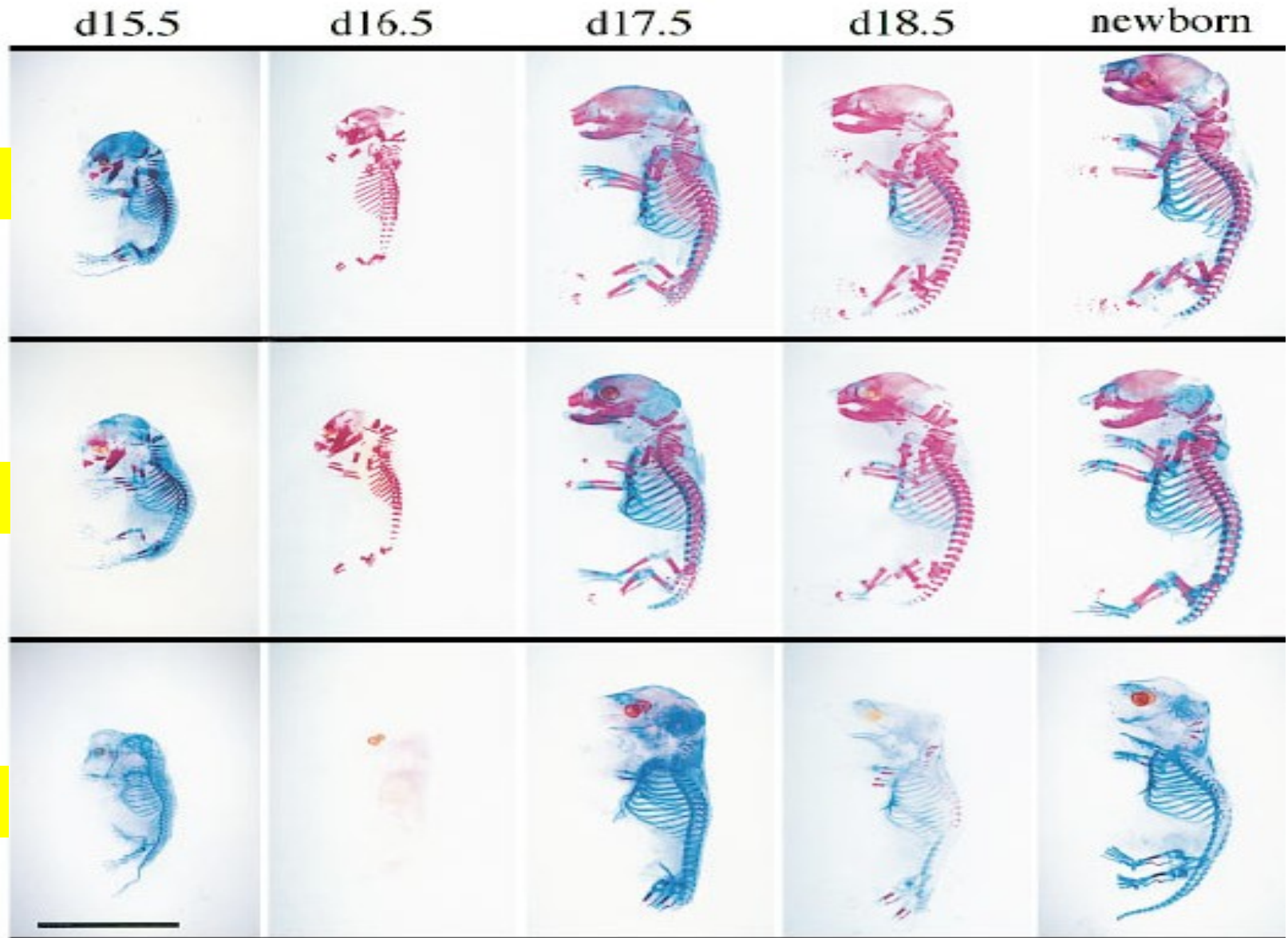

How do the limbs grow?

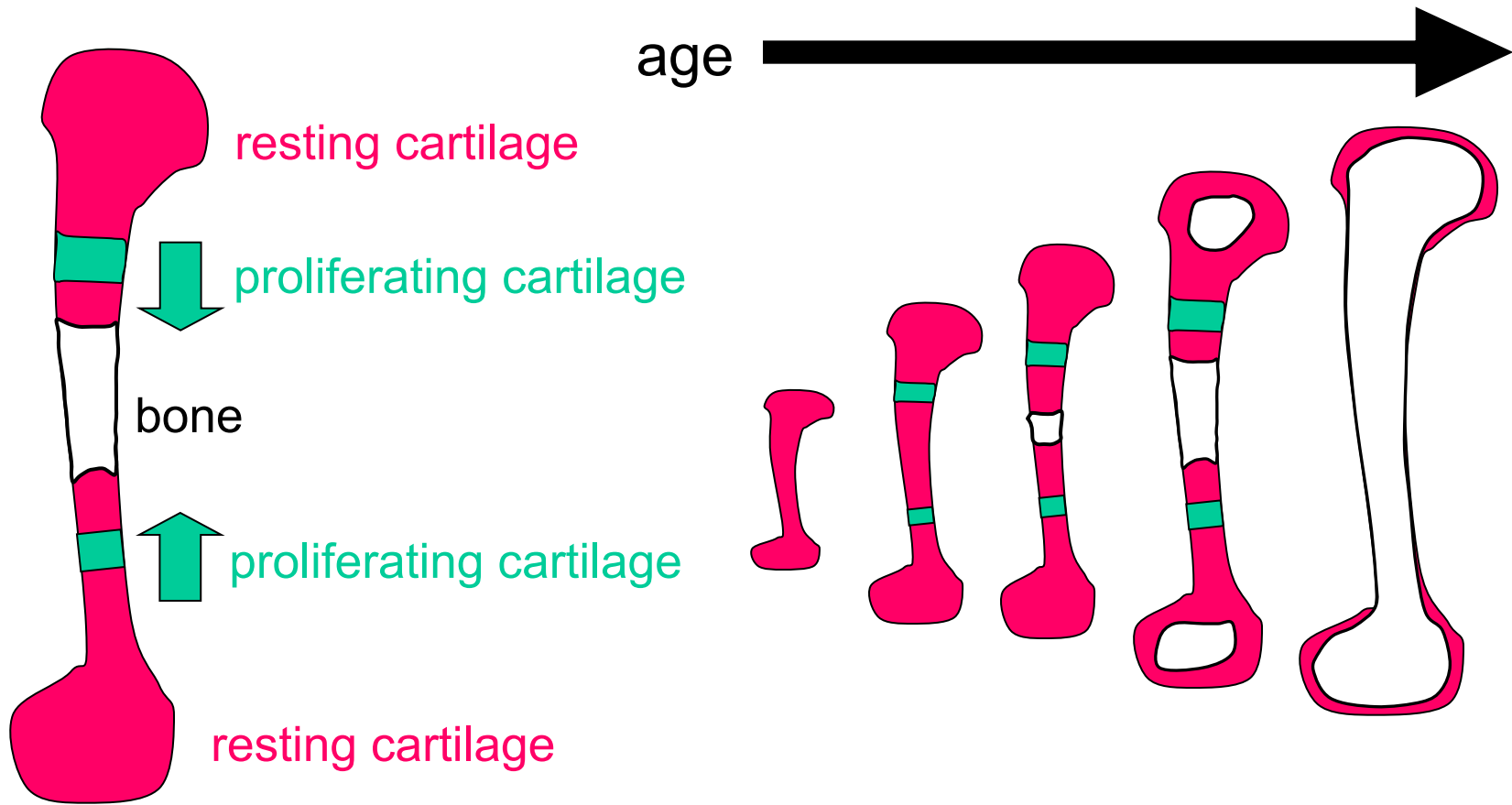

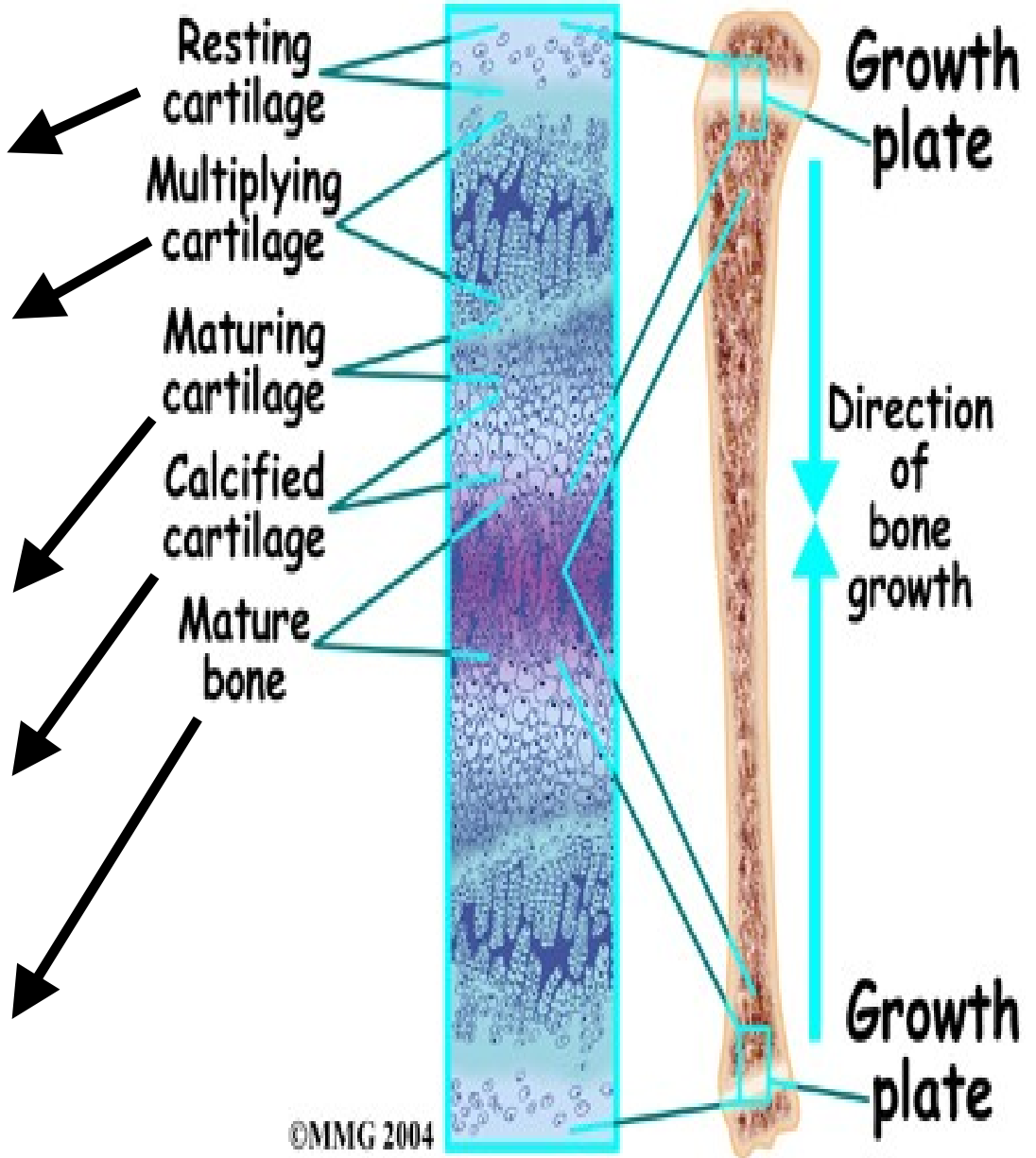
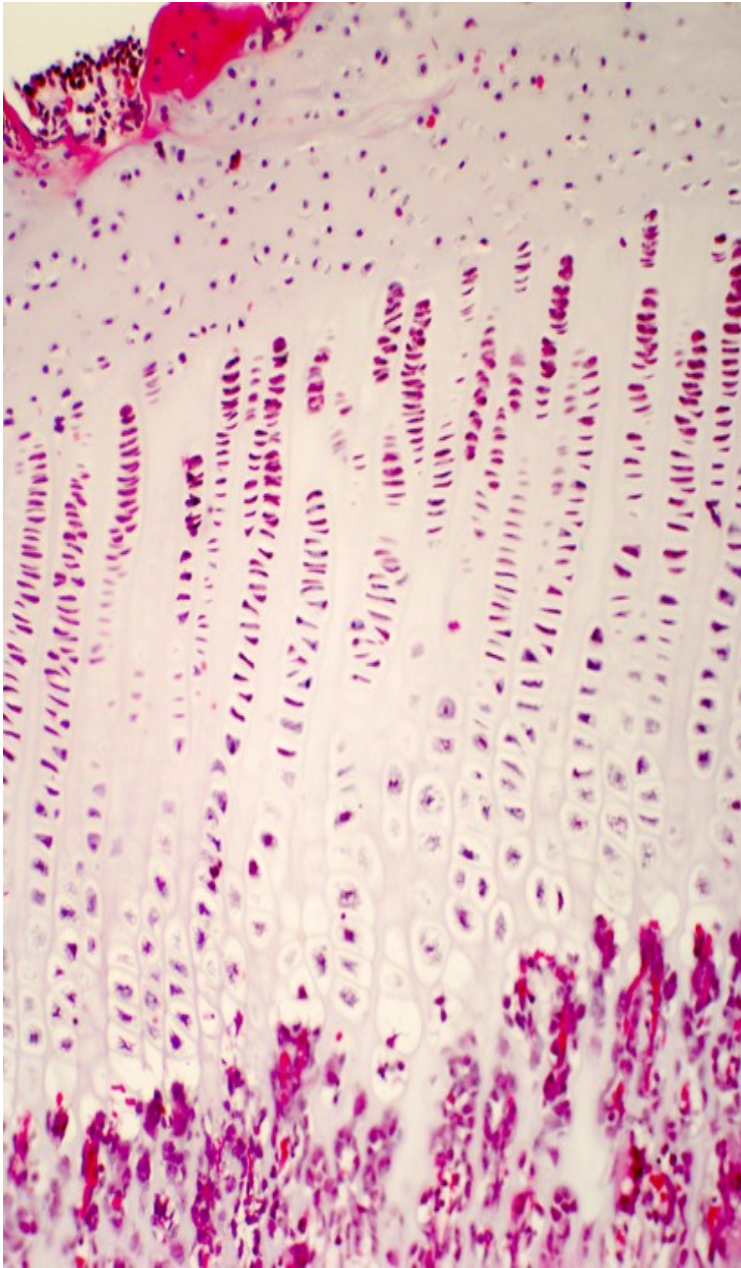

©MMG 2004

wt

Ihh^{-/-}

Indian hedgehog (Ihh)

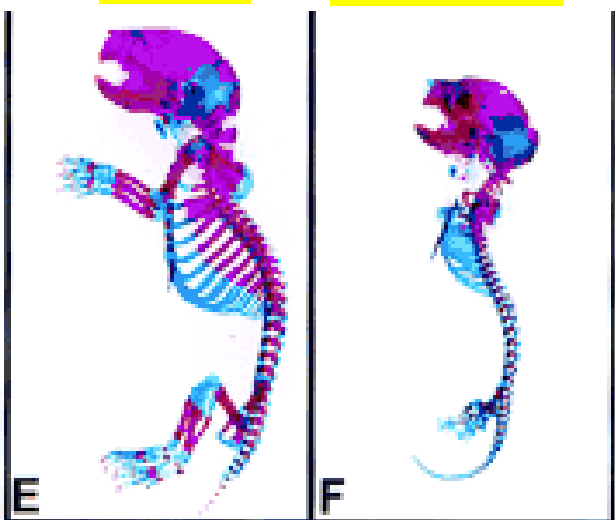

12.5 dpc

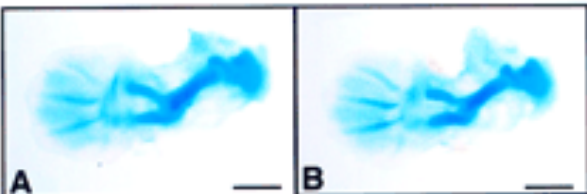

14.5 dpc



16.5 dpc



18.5 dpc



wt

Ihh^{-/-}

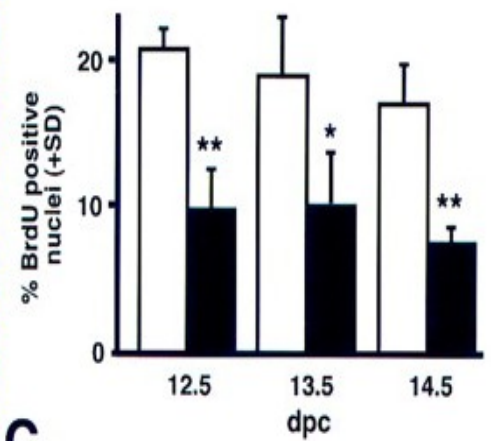
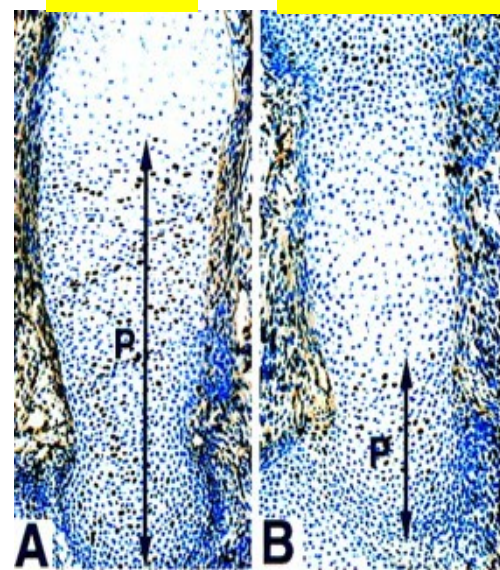

C

wt

Pthrp^{-/-}

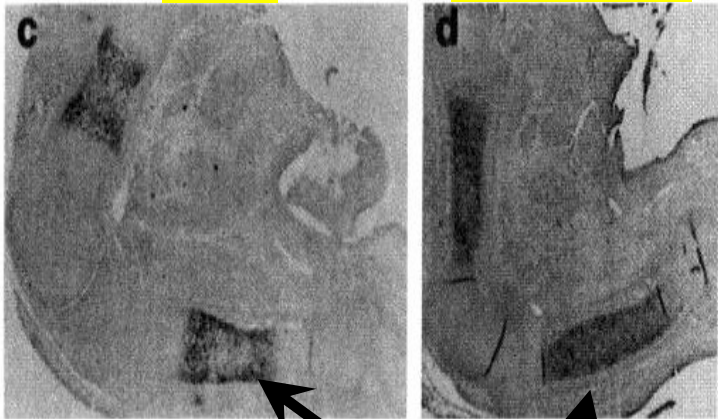

Coll type X in situ

wt

Pthrp receptor



wt

Pthrp receptor

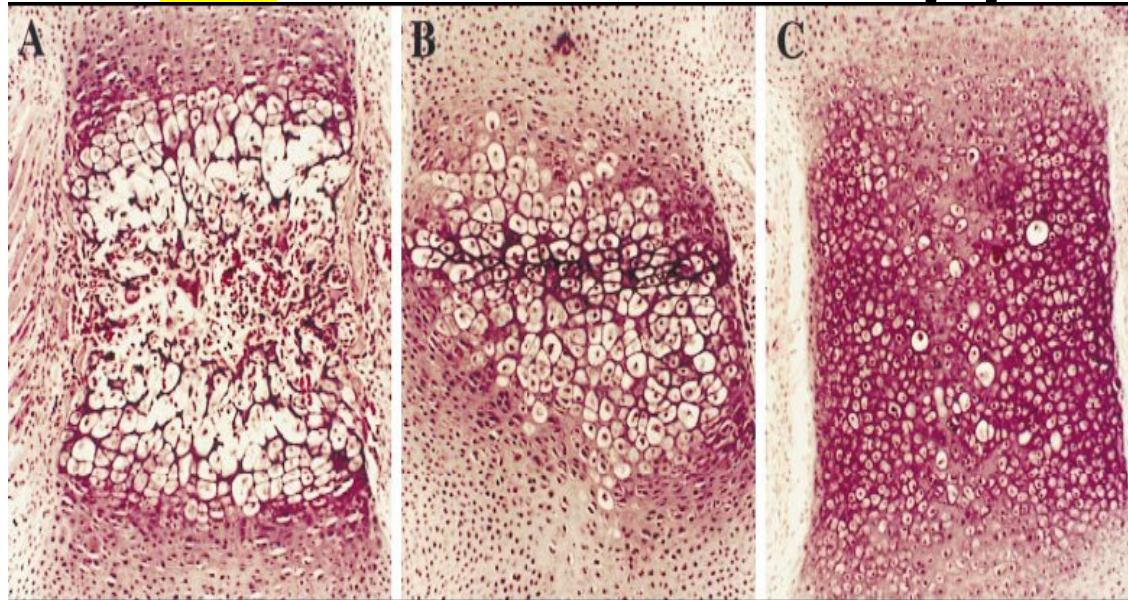

Sternal cartilage

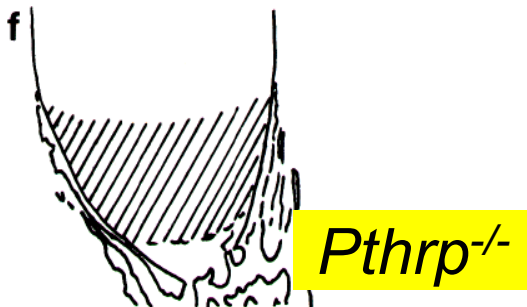
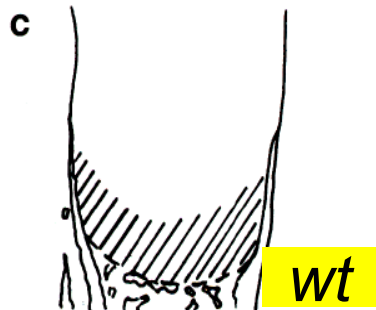

Periarticular
chondrocytes

Proliferating
chondrocytes

Prehypertrophic
chondrocytes

Hypertrophic
chondrocytes

Osteoblasts

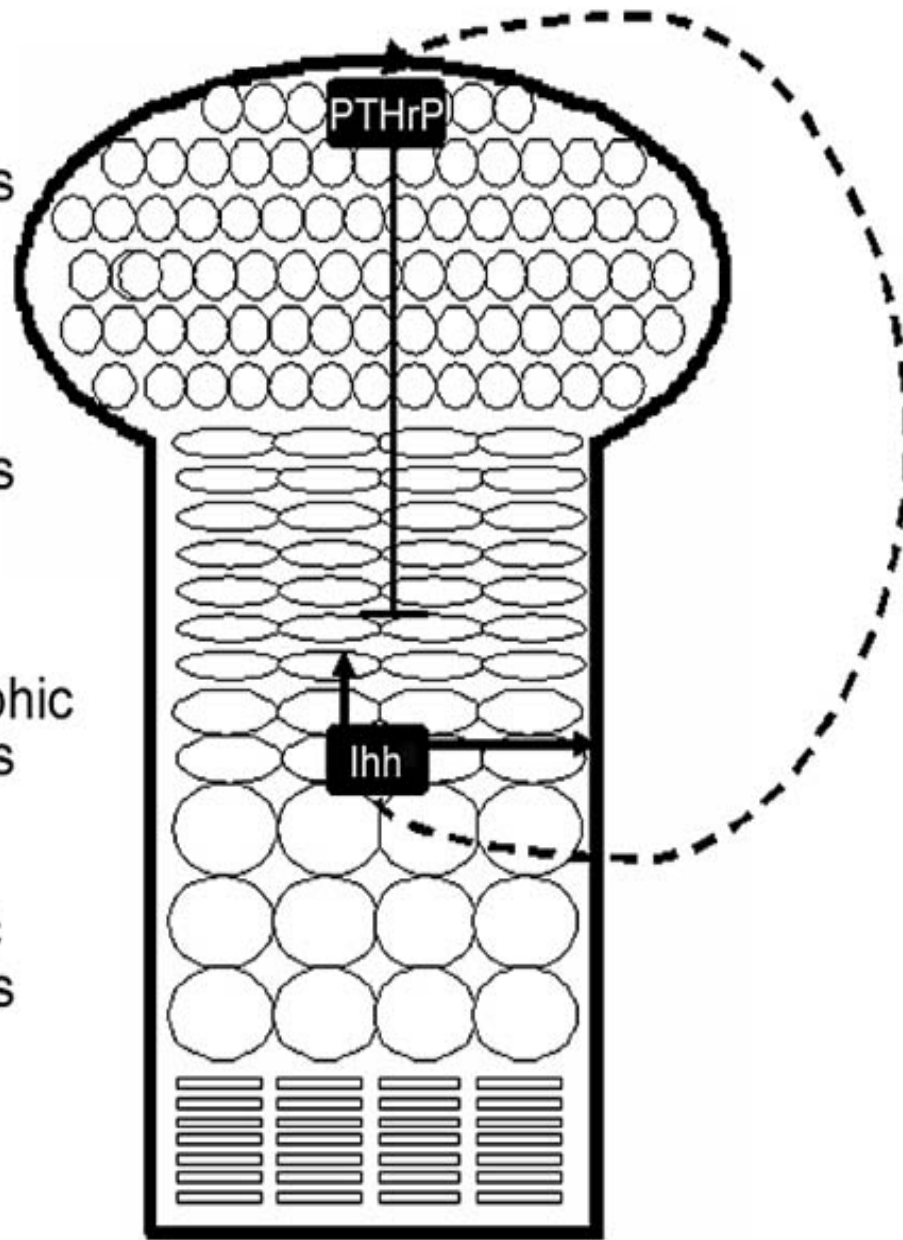

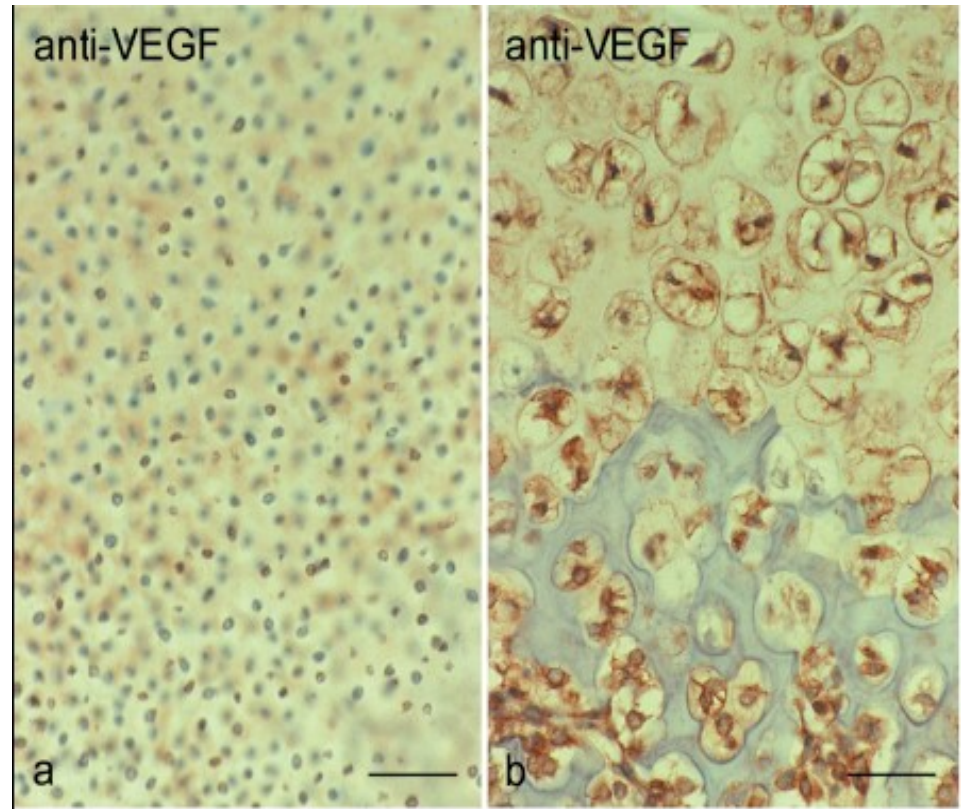
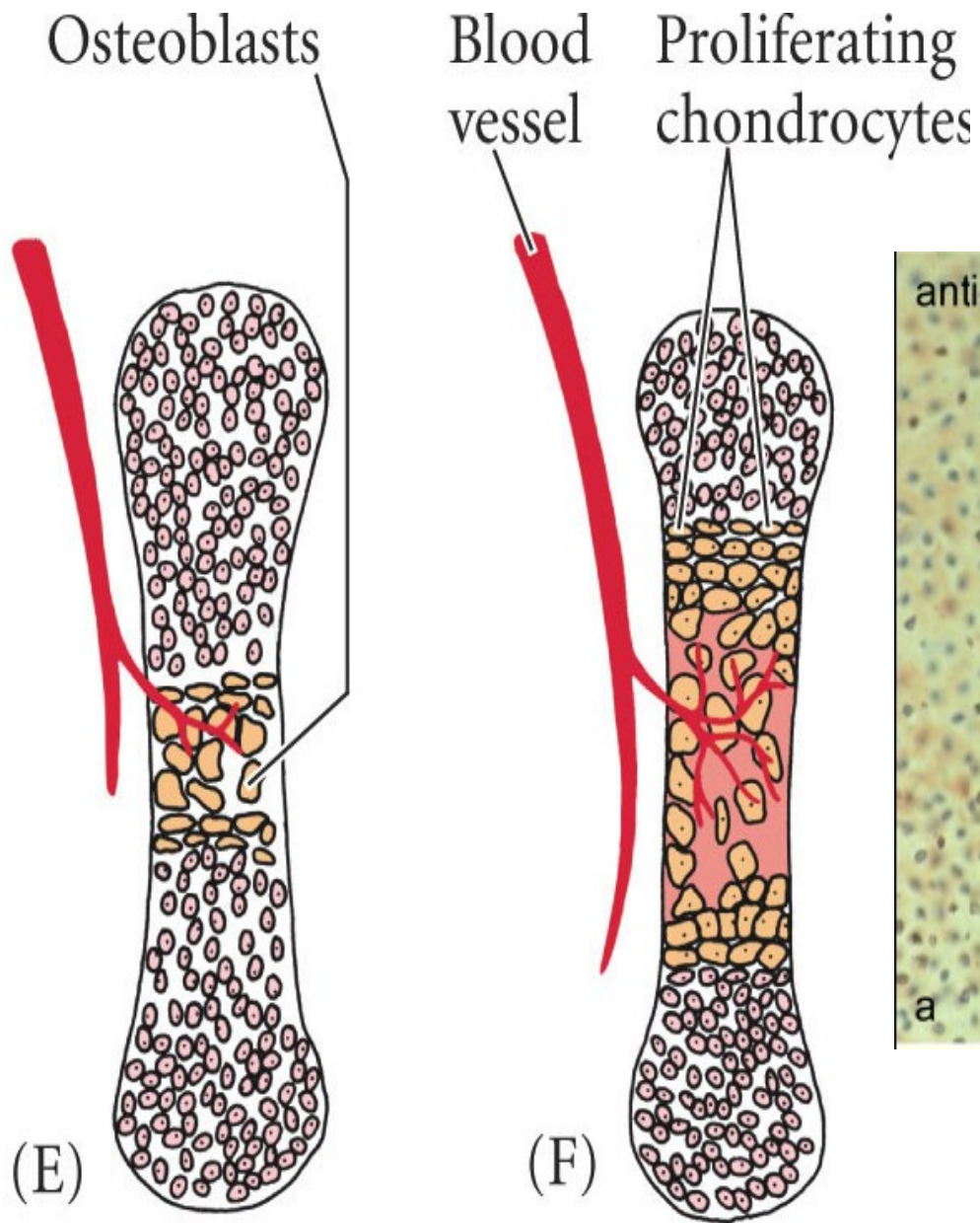

VEGFA is necessary for chondrocyte survival during bone development

Elazar Zelzer¹, Roni Mamluk², Napoleone Ferrara³, Randall S. Johnson⁴, Ernestina Schipani⁵, Bjorn R. Olsen^{1,*}

¹Department of Cell Biology, Harvard Medical School, Boston, MA 02115, USA

²Department of Surgical Research, Children's Hospital and Harvard Medical School, Boston, MA 02115, USA

³Department of Molecular Oncology, Genentech, South San Francisco, CA 94080, USA

⁴Molecular Biology Section, Division of Biology, University of California, San Diego, CA 92093, USA

⁵Endocrine Unit, Massachusetts General Hospital and Harvard Medical School, Boston, MA 02114, USA

*Author for correspondence (e-mail: bjorn_olsen@hms.harvard.edu)

Accepted 30 December 2003

Development 131, 2161-2171

Published by The Company of Biologists 2004

doi:10.1242/dev.01053

wt

Vegfa^{-/-}

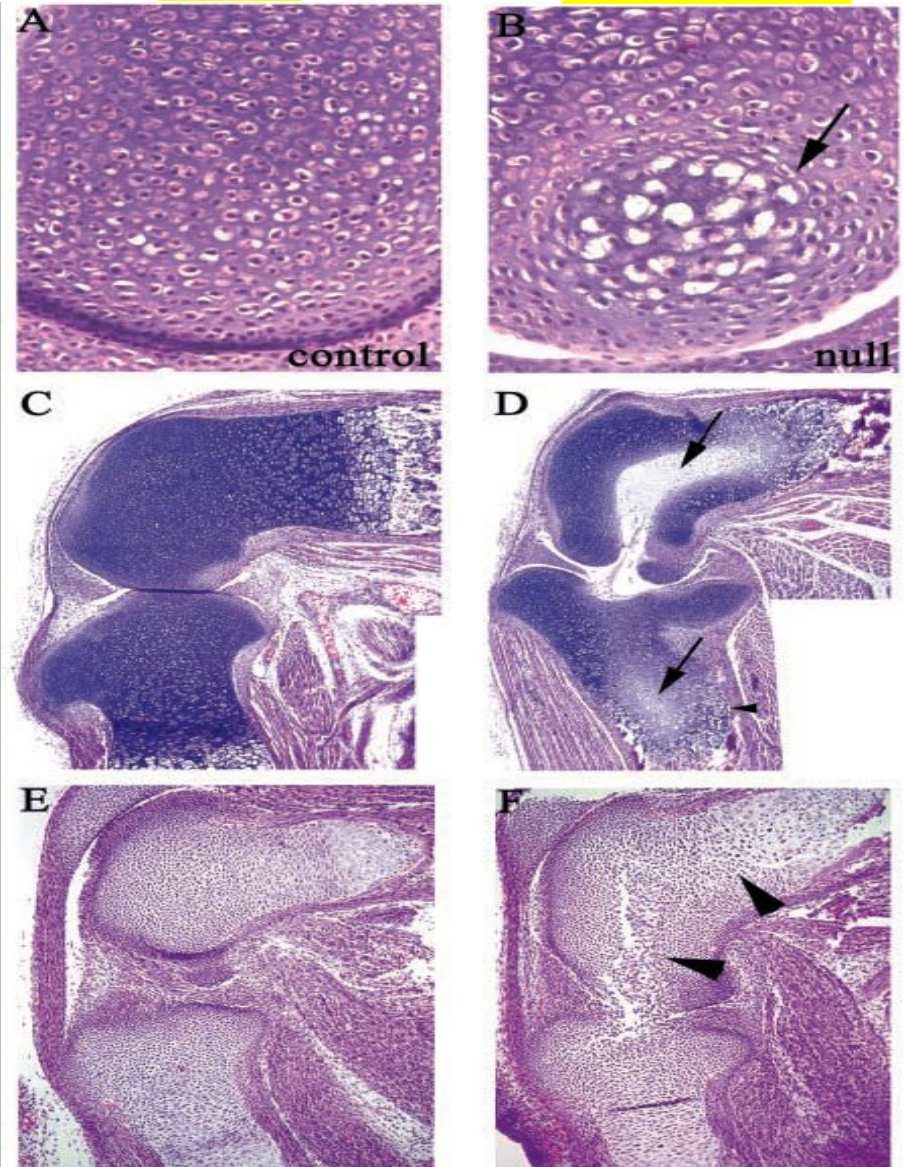

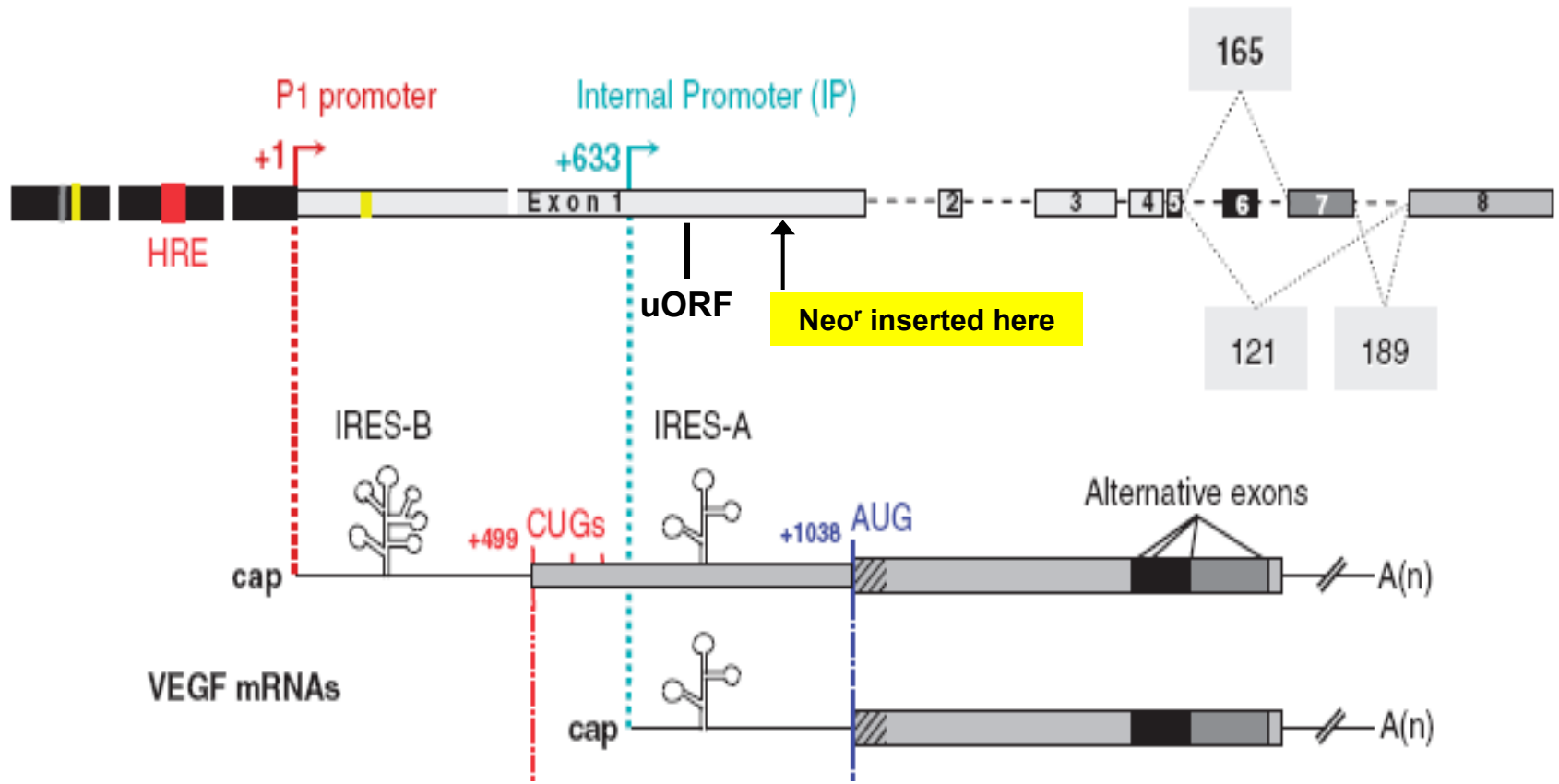

Vegf transcription

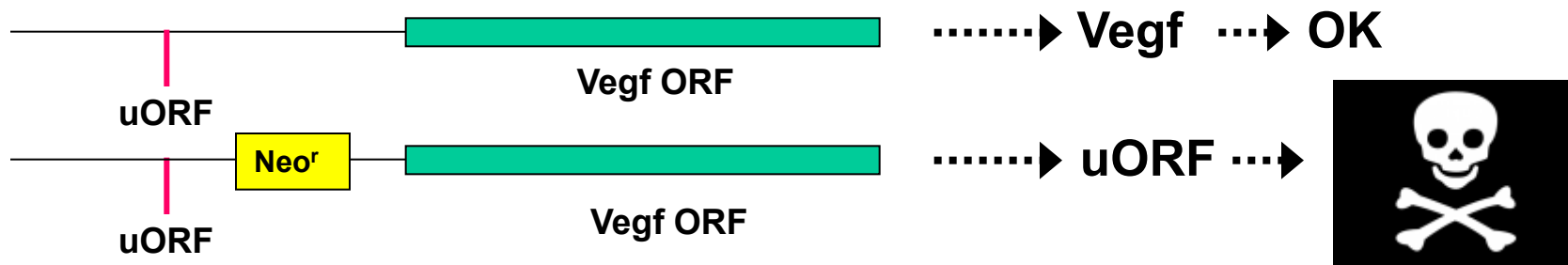

C-type Natriuretic Peptide (CNP)

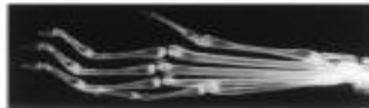

wild-type

CNP ↑

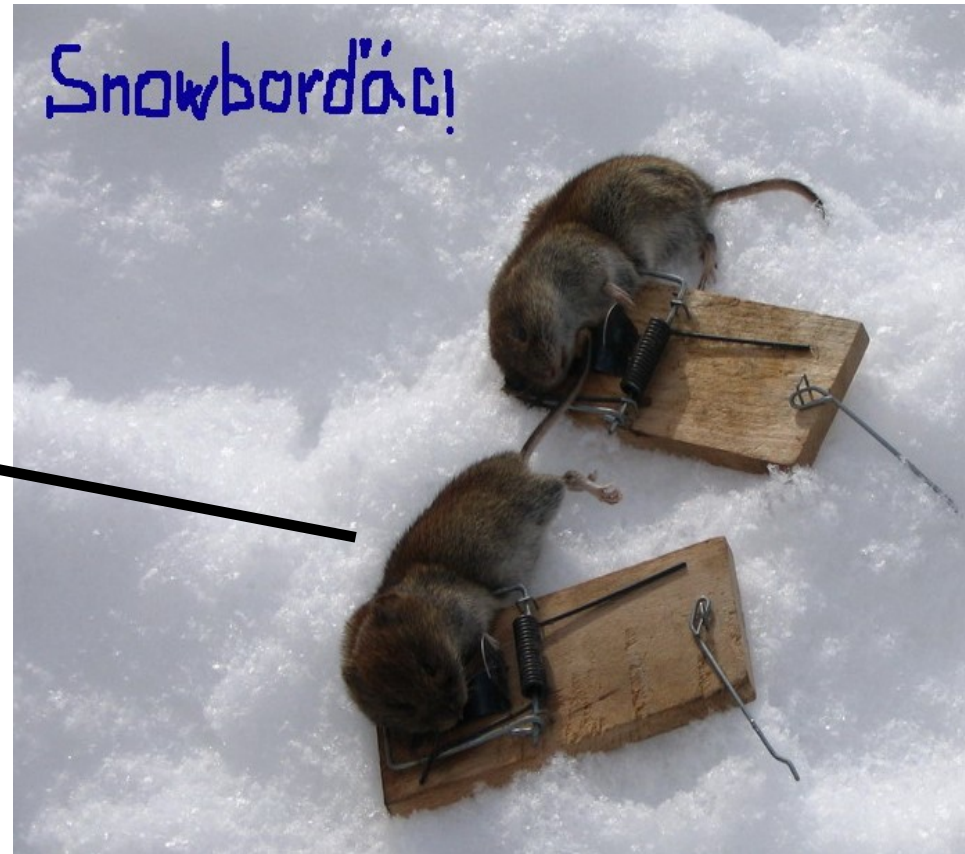

CNP over-expression???

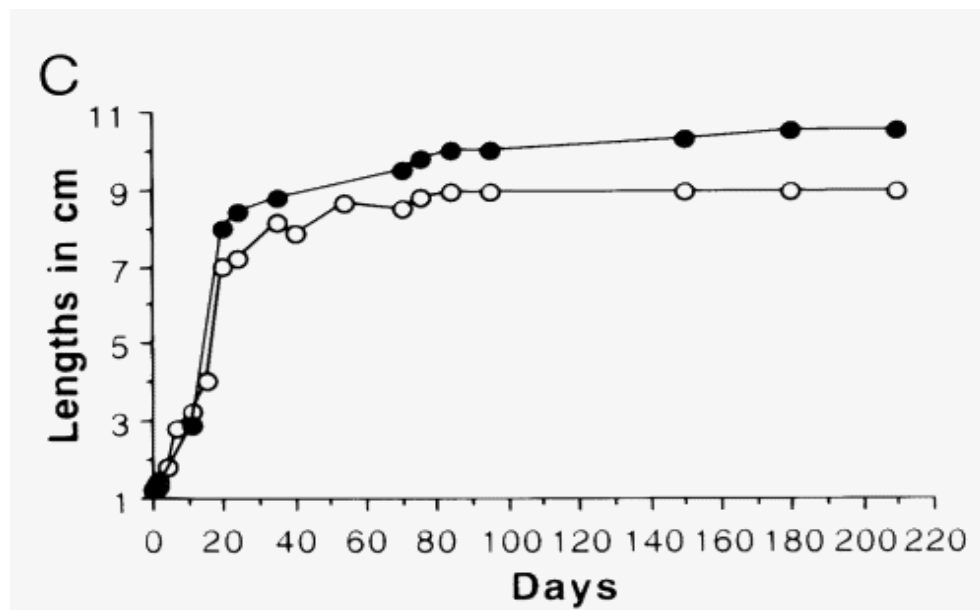
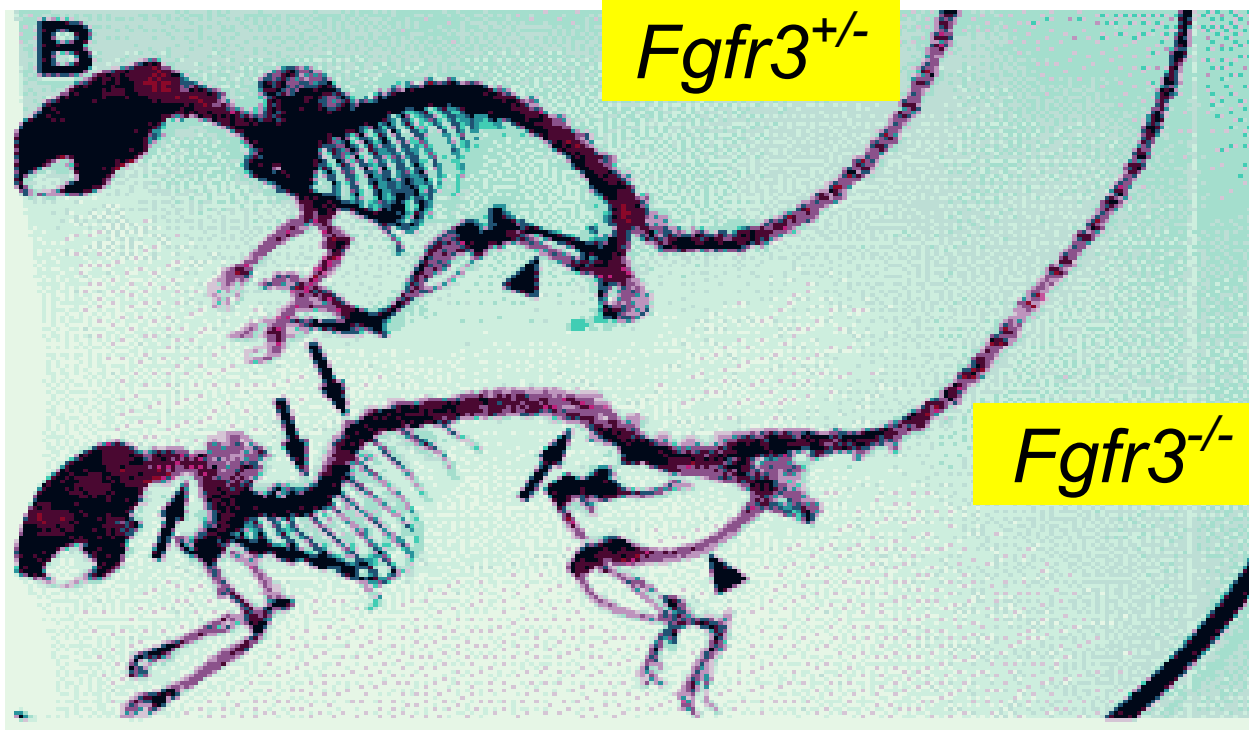

Chuxia Deng

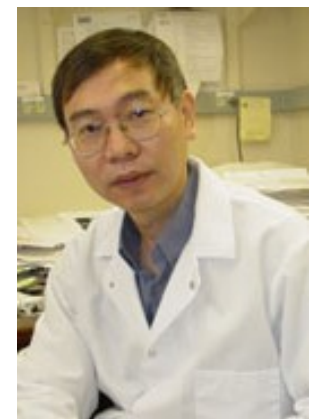

An Expressed *Fgf4* Retrogene Is Associated with Breed-Defining Chondrodysplasia in Domestic Dogs

Heidi G. Parker,¹ Bridgett M. VonHoldt,² Pascale Quignon,¹ Elliott H. Margulies,³ Stephanie Shao,¹ Dana S. Mosher,¹ Tyrone C. Spady,¹ Abdel Elkhouloun,¹ Michele Cargill,^{4*} Paul G. Jones,⁵ Cheryl L. Maslen,⁶ Gregory M. Acland,^{7,8} Nathan B. Sutter,⁸ Keiichi Kuroki,⁹ Carlos D. Bustamante,¹⁰ Robert K. Wayne,² Elaine A. Ostrander^{1†}

Retrotransposition of processed mRNAs is a common source of novel sequence acquired during the evolution of genomes. Although the vast majority of retroposed gene copies, or retrogenes, rapidly accumulate debilitating mutations that disrupt the reading frame, a small percentage become new genes that encode functional proteins. By using a multibreed association analysis in the domestic dog, we demonstrate that expression of a recently acquired retrogene encoding fibroblast

dachshund, Pekingese, and basset hound, where it was found to be dominant and allelic on the basis of arranged crosses (5). The phenotype primarily affects the length of the long bones, with growth plates calcifying early in development, thus producing shortened bones with a curved appearance (Fig. 1A) (6, 7).

To identify the genetic foundations of breed-defining phenotypes such as canine chondrodysplasia, we developed a multibreed approach for mapping fixed canine traits. A total of 835 dogs from 76 distinct breeds that provided maximal coverage of phenotypic variation were genotyped by using the Affymetrix version 2.0 single-nucleotide polymorphism (SNP) chip (8, 9). Chondrodysplastic breeds, or cases, were defined on the basis of specific morphologic criteria set forth in each breed standard (8, 10) and comprised 105 dogs

FGF4 ↑↑↑

FGF4 normal



WHEN SOMETHING GOES WRONG WITH FGFR3

Hypochondroplasia
Achondroplasia
SADDAN
Thanatophoric Dysplasia



Leslie Thompson



William Wilcox

STATURE

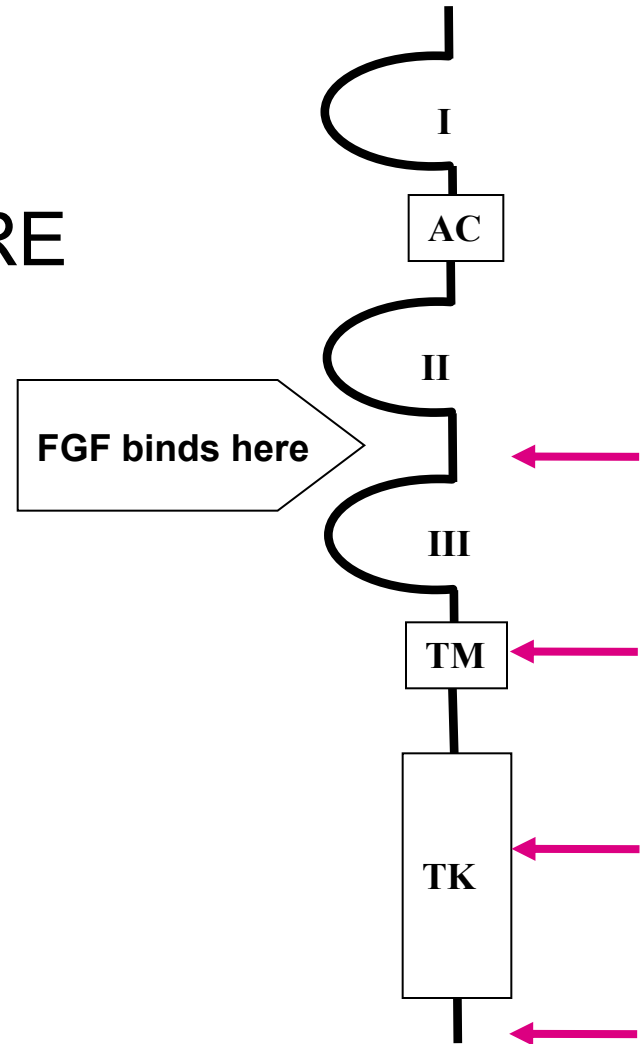

Achondroplasia



Thanatophoric dysplasia

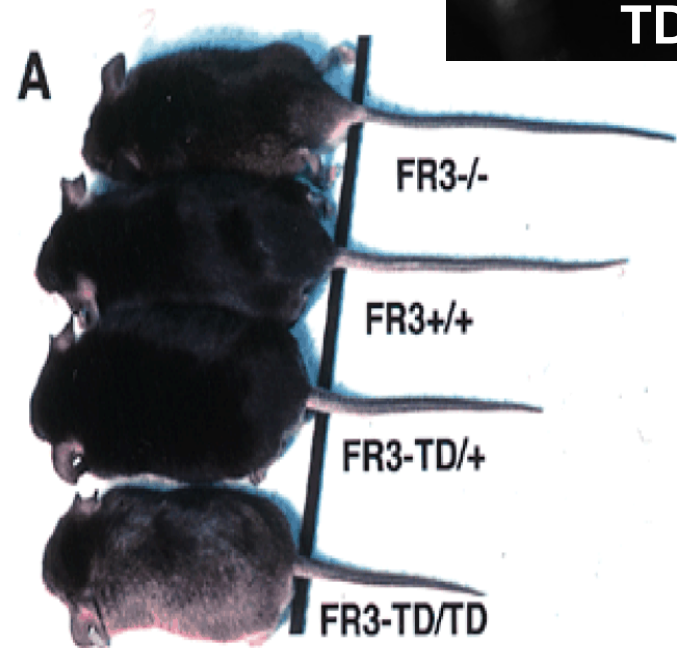
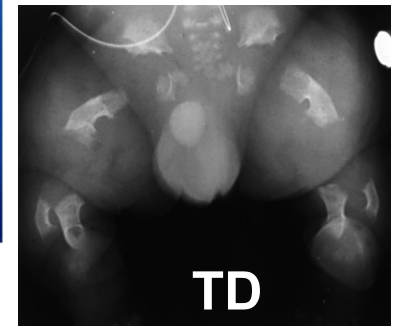
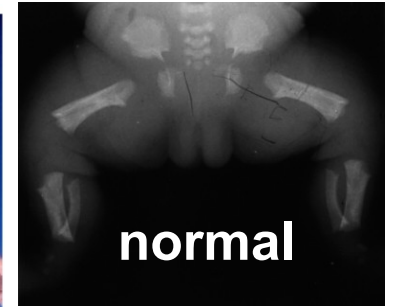

CNP rescues dwarfism caused by ACH

Kazuwa Nakao



C

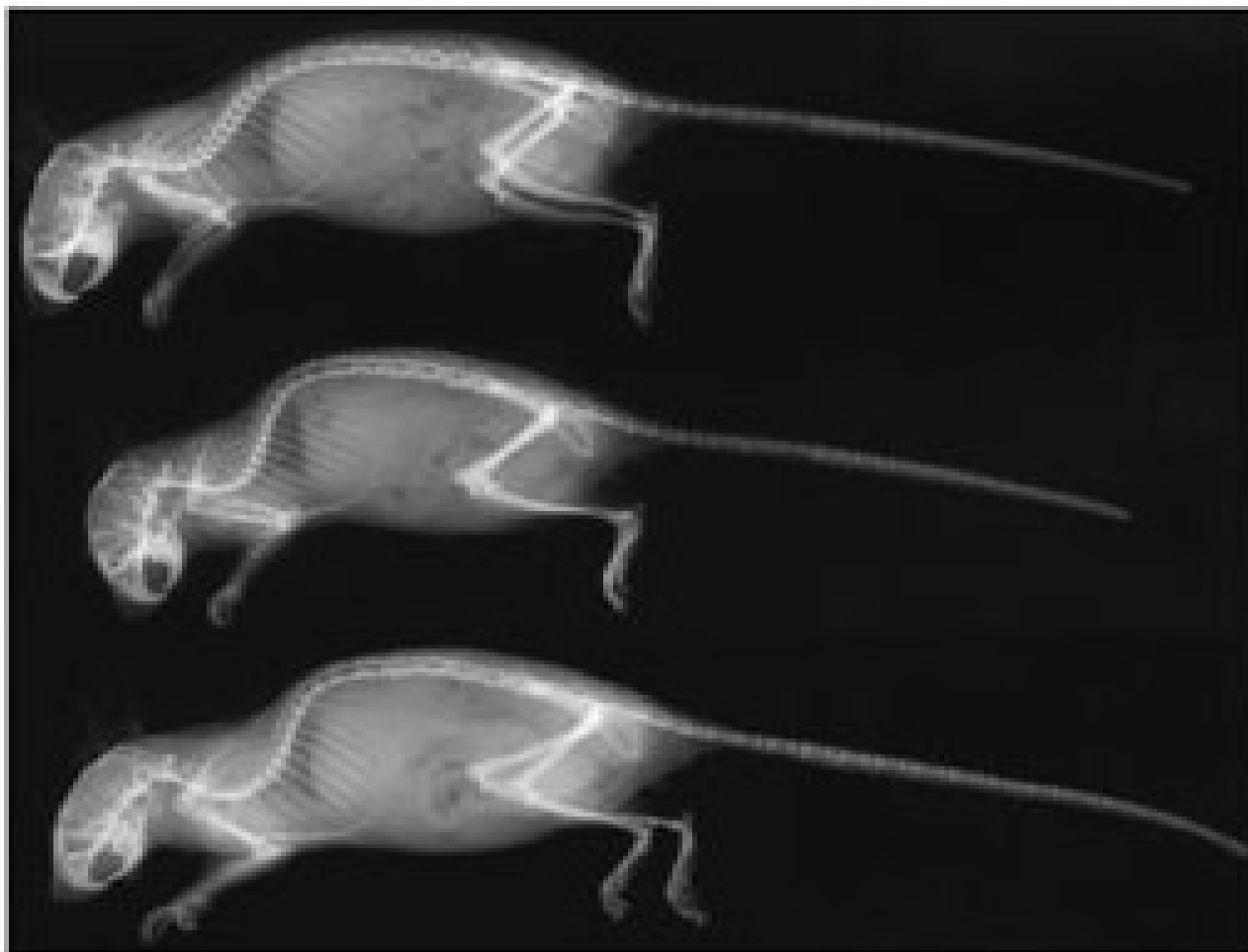

wild-type

$Fgfr3^{Ach}$

$Fgfr3^{Ach/CNP}$ ↑

Nature Medicine 10, 80 - 86 (2004)

CNP and FGFR3 pathways interact to maintain normal growth

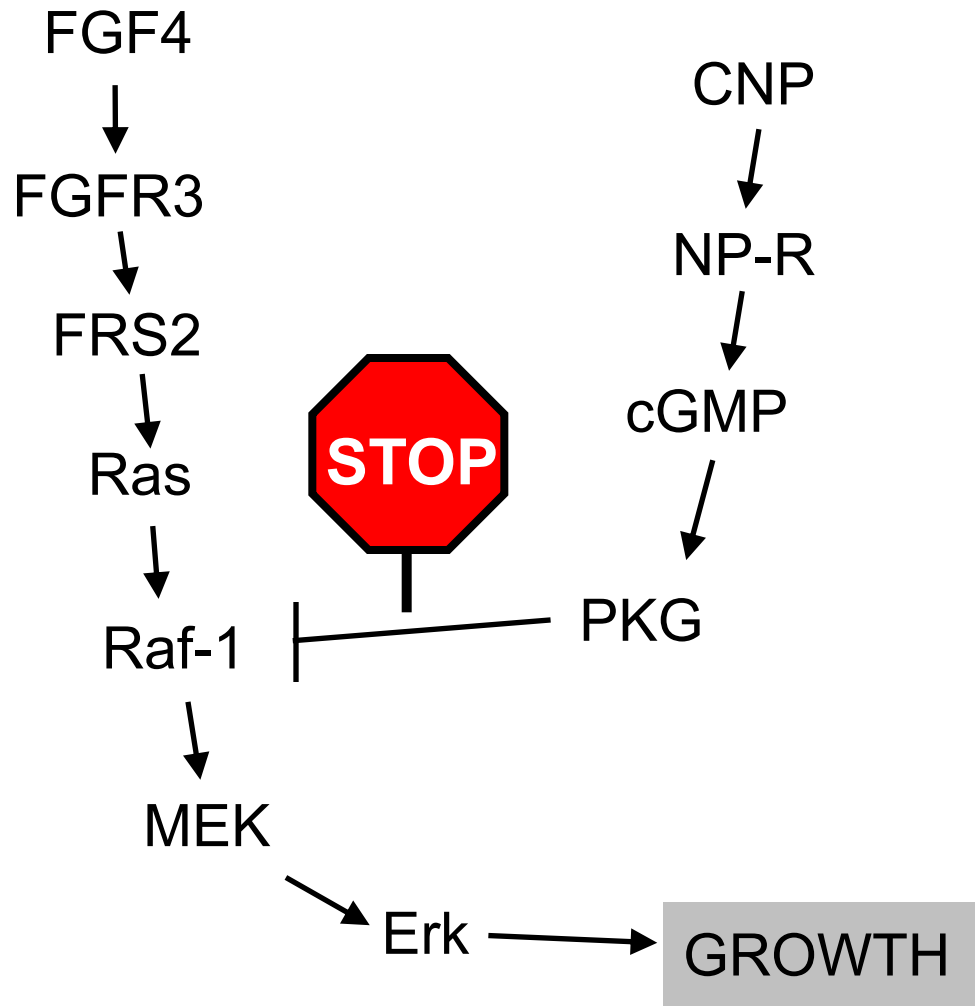

WHEN SOMETHING GOES WRONG WITH SOX9

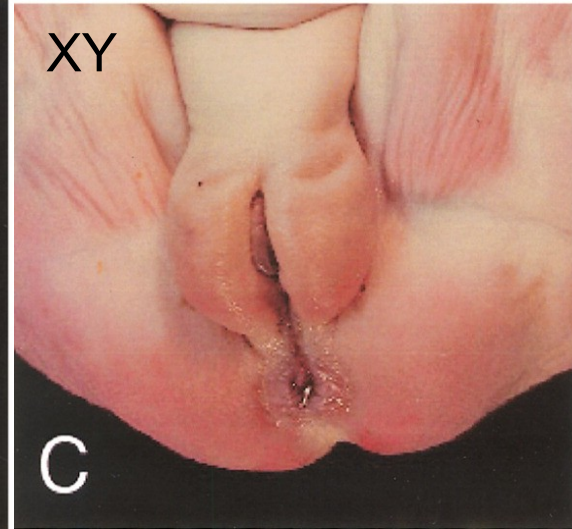
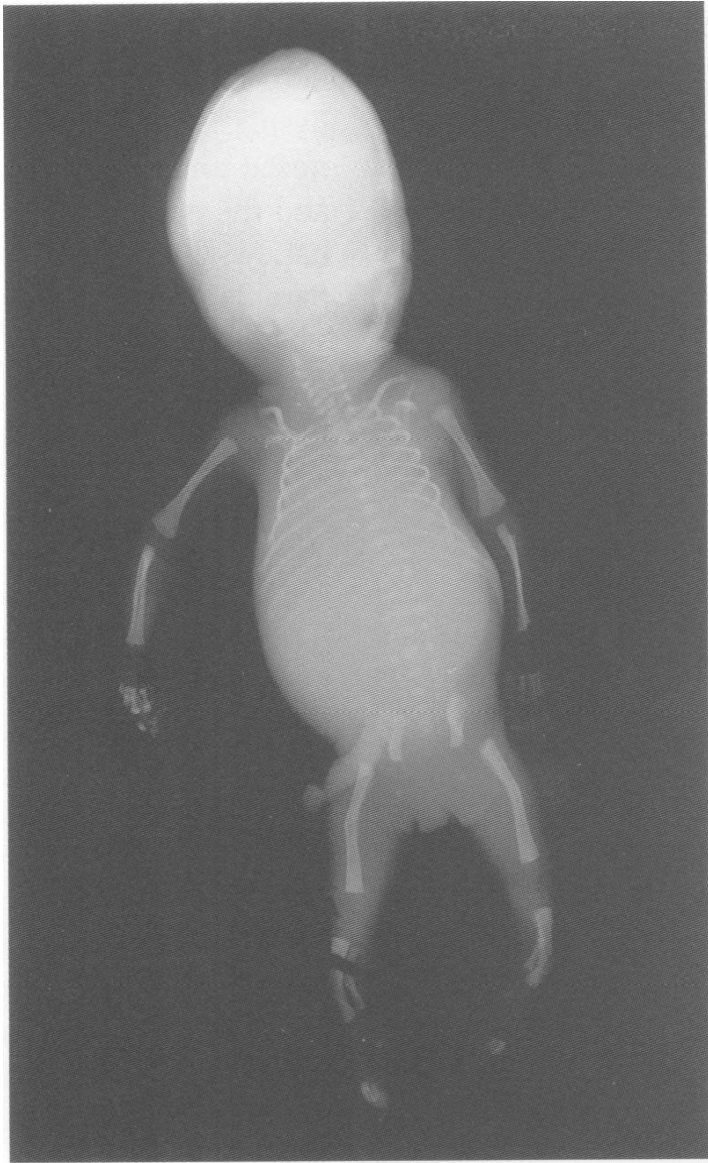

CAMPOMELIC DYSPLASIA
Sox9 haploinsufficiency

..... OR WITH SHH

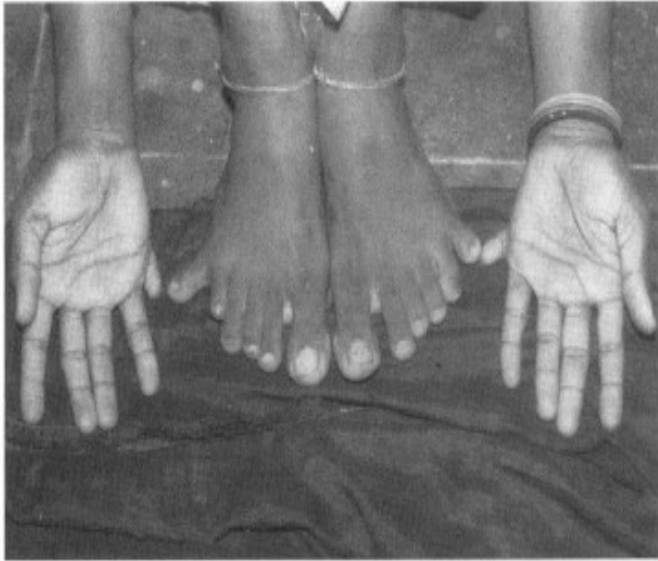

POLYDACTYLY TYPE-A
Loss-of-function mutation in
Gli3 (negative regulator of SHH)



POLYDACTYLY TYPE-II
SHH upregulation via transcriptional enhancer
mutation

Nosology and Classification of Genetic Skeletal Disorders: 2006 Revision

Andrea Superti-Furga,^{1*} Sheila Unger,^{1,2} and the Nosology Group of the International Skeletal Dysplasia Society

¹Center for Pediatrics and Adolescent Medicine, Department of Pediatrics, University of Freiburg, Freiburg, Germany

²Institute for Human Genetics, University of Freiburg, Freiburg, Germany

Received 23 July 2006; Accepted 7 August 2006

The objective of the paper is to provide the revision of the Nosology of Constitutional Disorders of Bone that incorporates newly recognized disorders and reflects new molecular and pathogenetic concepts. Criteria for inclusion of disorders were (1) significant skeletal involvement corresponding to the definition of skeletal dysplasias, metabolic bone disorders, dysostoses, and skeletal malformation and/or reduction syndromes, (2) publication and/or MIM listing, (3) genetic basis proven or very likely, and (4) nosologic autonomy confirmed by molecular or linkage analysis and/or distinctive diagnostic features and observation in multiple individuals or families. Three hundred seventy-two different conditions were included and placed in 37 groups defined by molecular, biochemical and/or radiographic criteria. Of these conditions, 215 were associated with one or more of 140 different genes. Nosologic status was classified as final (mutations or locus identified), probable (pedigree evidence), or *bona fide* (multiple observations and clear diagnostic criteria, but no pedigree or locus evidence yet). The number of recognized genetic disorders with a significant skeletal component is growing and the distinction between dysplasias, metabolic bone disorders, dysostoses,

and malformation syndromes is blurring. For classification purposes, pathogenetic and molecular criteria are integrating with morphological ones but disorders are still identified by clinical features and radiographic appearance. Molecular evidence leads to confirmation of individual entities and to the constitution of new groups, but also allows for delineation of related but distinct entities and indicates a previously unexpected heterogeneity of molecular mechanisms; thus, molecular evidence does not necessarily simplify the Nosology, and a further increase in the number of entities and growing complexity is expected. By providing an updated overview of recognized entities with skeletal involvement and of the underlying gene defects, the new Nosology can provide practical diagnostic help, facilitate the recognition of new entities, and foster and direct research in skeletal biology and genetic disorders. © 2006 Wiley-Liss, Inc.

Key words: nosology; skeletal disorders; osteochondrodysplasias; dysostoses; malformation syndromes; developmental biology; molecular defects

How to cite this article: Superti-Furga A, Unger S, and the Nosology Group of the International Skeletal Dysplasia Society. 2007. Nosology and classification of genetic skeletal disorders: 2006 revision.

Am J Med Genet Part A 143A:1–18.

..... OR WITH ANOTHER 140 OR SO GENES