

snímek 1

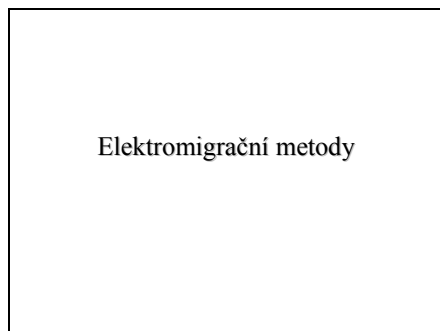

---

---

---

---

---

---

---

---

snímek 2

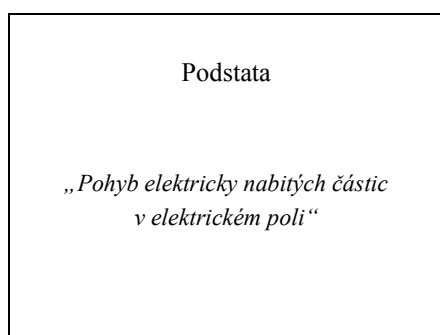

---

---

---

---

---

---

---

---

snímek 3

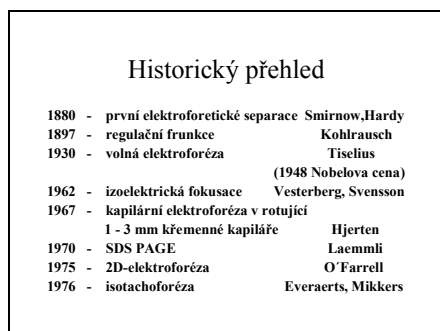

---

---

---

---

---

---

---

---

snímek 4



---

---

---

---

---

---

---

---

snímek 5

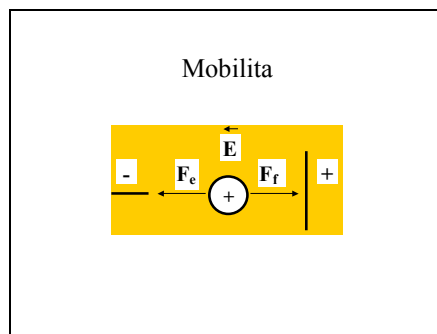

---

---

---

---

---

---

---

---

snímek 6

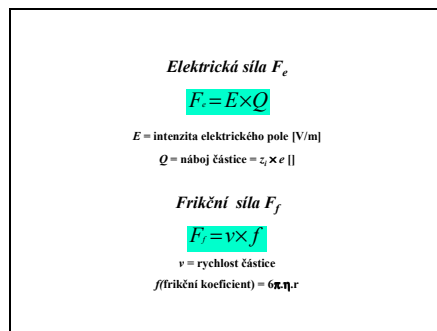

---

---

---

---

---

---

---

---

snímek 7

*Ustálený stav*

$$E \times Q = v \times f$$

↓

$$v = \frac{E \times Q}{f}$$

mobilita  $\rightarrow \mu = \frac{v}{E} = \frac{Q}{E \times f} \quad [\text{m}^2 \text{V}^{-1} \text{s}^{-1}]$

---

---

---

---

---

---

---

---

snímek 8

Sekundární jevy

- Jouleovo teplo
- Elektrosmóza

---

---

---

---

---

---

---

---

snímek 9

Jouleovo teplo

$$P = \frac{E \times i}{S} = \frac{i^2}{\kappa \times S^2}$$

$P$  = výkon [W.m<sup>-3</sup>]  
 $S$  = průřez [m<sup>2</sup>]  
 $\kappa$  = vodivost [ $\Omega^{-1} \cdot \text{m}^{-1}$ ]  
 $i$  = elektrický proud [A]

---

---

---

---

---

---

---

---

snímek 10

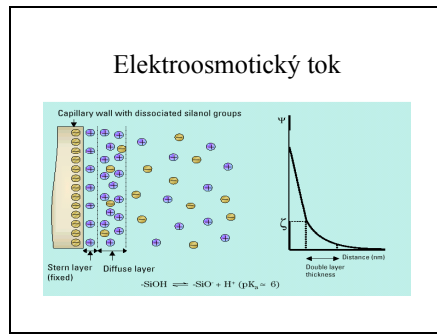

---

---

---

---

---

---

---

---

snímek 11

### Elektroosmotický tok

$$\zeta = \frac{4\pi\eta\mu_{eo}}{\epsilon}$$

$\zeta$  = potenciál Helmholtzovy dvojrstvy  
 $\eta$  = viskozita  
 $\epsilon$  = dielektrická konstanta  
 $\mu_{eo}$  = elektroosmotická mobilita

$$v_{eo} = \frac{\epsilon}{4\pi\eta} \times E\zeta$$

---

---

---

---

---

---

---

---

snímek 12

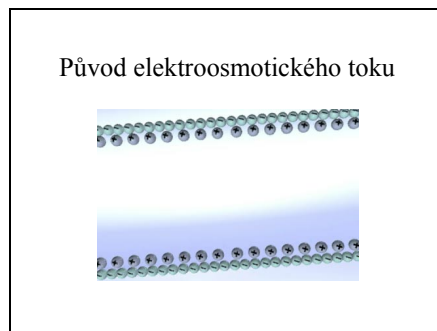

---

---

---

---

---

---

---

---

snímek 13

Elektroforéza

*„Dělení nabitých částic na základě  
rozdílných elektroforetických  
mobilit“*

---

---

---

---

---

---

---

---

snímek 14

Elektroforéza

- Volná
- Zónová

---

---

---

---

---

---

---

---

snímek 15

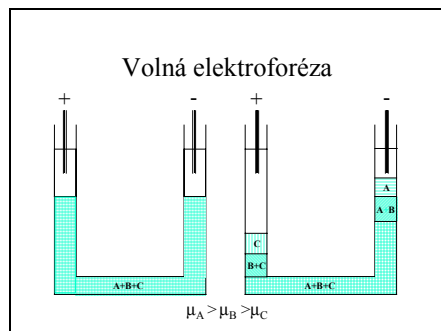

---

---

---

---

---

---

---

---

snímek 16

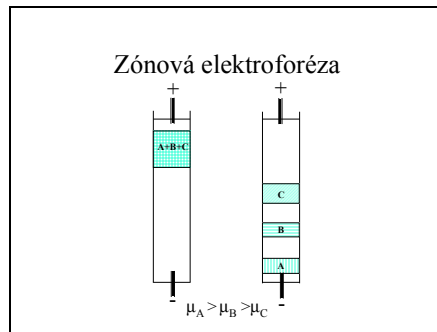

---

---

---

---

---

---

---

---

snímek 17

- Stabilizace
- Rotací
  - Gradienty hustoty
  - Porézními medii
  - Kapilárou

---

---

---

---

---

---

---

---

snímek 18

- Požadavky na porézní media
- Homogenita
  - Inertnost - nespécifické interakce  
- nulový EOF
  - Reprodukovatelná a snadná příprava
  - Mechanická pevnost
  - transparentnost

---

---

---

---

---

---

---

---

snímek 19

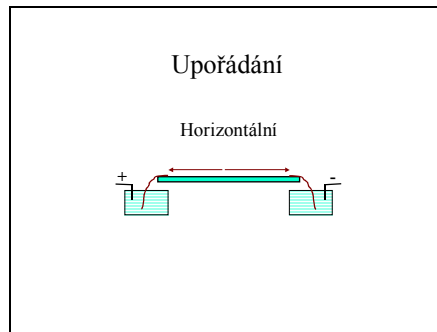

---

---

---

---

---

---

---

---

snímek 20

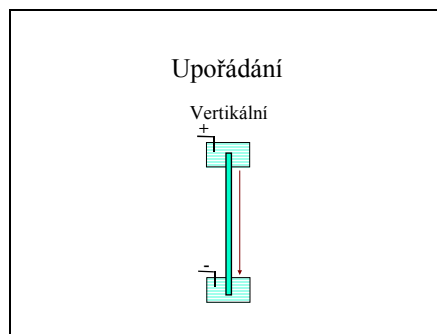

---

---

---

---

---

---

---

---

snímek 21

**Chromatografický papír**

Složení – celuloza

- Nehomogenní
- Přítomnost ionogenních skupin
- Špatně se chladí – pálí se

Použití : téměř už se nepoužívá

---

---

---

---

---

---

---

---

snímek 22

**Agar a agarosa**

Složení – kopolymer galaktosy a anhydrogalaktosy

- Přítomnost ionogenních skupin – silný EOF
- + Velké pory
- + Snadná příprava

Použití : imunoelektroforetické metody  
elektroforéza NK

---

---

---

---

---

---

---

---

snímek 23

**Acetát celulosy**

Složení – acetát celulosy

- + Komerčně dostupný
- + Dobré mechanické vlastnosti

Použití : imunoelektroforetické metody  
klinické aplikace

---

---

---

---

---

---

---

---

snímek 24

**Škrob**

Složení – hydrolyzovaný škrob

- + poprvé se uplatňuje efekt molekulového síta
- Špatné mechanické vlastnosti
- Komplikovaná a nereprodukovatelná příprava
- Není transparentní

Použití : izoenzymová analýza

---

---

---

---

---

---

---

---



snímek 25

**Sypané vrstvy**

Složení – Sephadex – zesíťovaný dextran

+ uplatňuje efekt molekulového síta

Použití : preparativní

---

---

---

---

---

---

---

---

snímek 26

**Polyakrylamid**

Složení – kopolymer akrylamidu a N,N,-metylenbisakrylamidu

+ plně splňuje požadavky  
- **Monomery jsou neurotoxiny !!!!!**

Použití : analýza bílkovin

---

---

---

---

---

---

---

---

snímek 27

**Polyakrylamid**

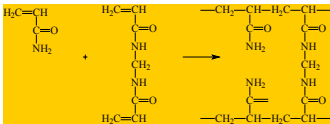

---

---

---

---

---

---

---

---

snímek 28

### Polyakrylamid - příprava

#### Radikálová polymerace

- Katalyzátor – tetramethylethyldiamin  
TEMED
- Iniciátor - chemický –  $(\text{NH}_4)_2\text{S}_2\text{O}_8$   
- fotochemický – ribloflavin + UV

---

---

---

---

---

---

---

---

snímek 29

### Polyakrylamid - složení

$$T = \frac{a+b}{m} \times 100\%$$

$$C = \frac{b}{a+b} \times 100\%$$

a – akrylamid (g)  
b – methylenbisakrylamid (g)  
m – objem (ml)

---

---

---

---

---

---

---

---

snímek 30

### Fergussonova rovnice

PAGE není pouze pasivním nosičem, ale podílí se na separaci efektem molekulového síta.

$$\log \mu = \log \mu_0 + K_r [T]$$

$\mu$  - mobilita  
 $\mu_0$  - mobilita při limitním zředění  
 $K_r$  - retardační koeficient

---

---

---

---

---

---

---

---

snímek 31

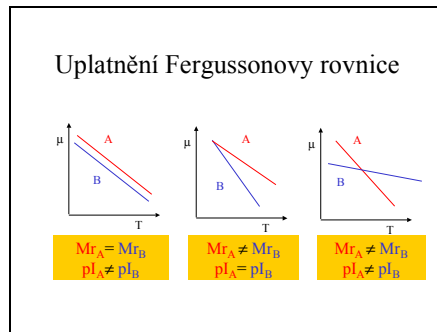

---

---

---

---

---

---

---

---

snímek 32

Provedení PAGE

vertikální x horizontální  
deskové x trubičkové  
homogenní x gradientové  
kontinuální x diskontinuální

---

---

---

---

---

---

---

---

snímek 33



---

---

---

---

---

---

---

---

snímek 34

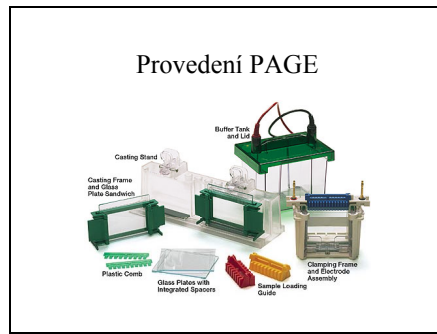

---

---

---

---

---

---

---

---

snímek 35

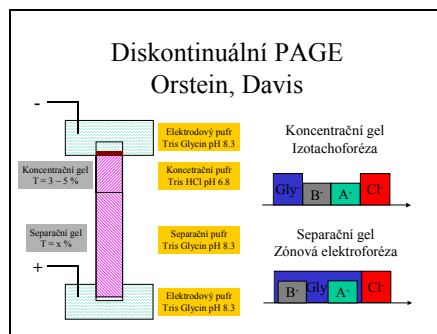

---

---

---

---

---

---

---

---

snímek 36

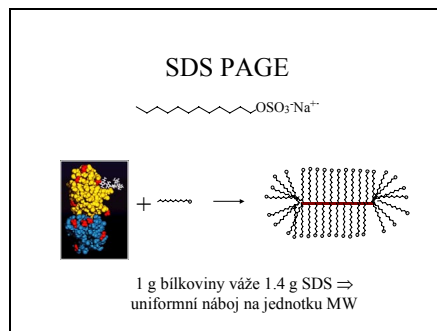

---

---

---

---

---

---

---

---

snímek 37

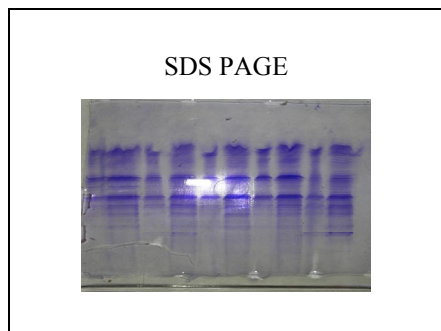

---

---

---

---

---

---

---

---

snímek 38

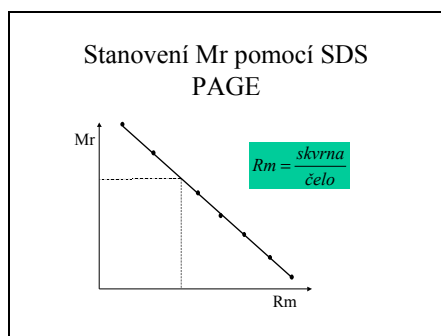

---

---

---

---

---

---

---

---

snímek 39

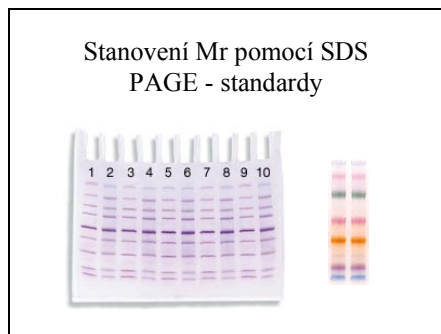

---

---

---

---

---

---

---

---

snímek 40

**Použití SDS PAGE**

- Stanovení Mr
- Analýza komplexních směsí
- Sledování purifikace bílkovin
- Stanovení podjednotkového složení

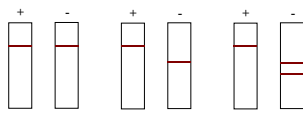

---

---

---

---

---

---

---

---

snímek 41

**PAGE - sekvenace DNA**

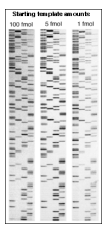

---

---

---

---

---

---

---

---

snímek 42

**Kapilární zónová elektroforéza  
CZE**

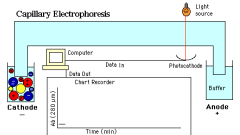

---

---

---

---

---

---

---

---

snímek 43

### Módy CZE

Use CE Mode...	For Analysis of...
Capillary zone electrophoresis (CZE)	Ions, etc.
Micellar electrokinetic chromatography (MEKC)	Neutral and ionic analytes
Chiral capillary electrophoresis (CCE)	Chiral molecules
Capillary electrochromatography (CEC)	Small molecules
Capillary gel electrophoresis (CGE/SDS-PAGE)	DNA/RNA size/protein MW
Capillary isoelectric focussing (CIEF)	Protein/peptide isoelectric point
Capillary isotachopheresis (CITP)	Ions

---

---

---

---

---

---

---

---

---

---

snímek 44

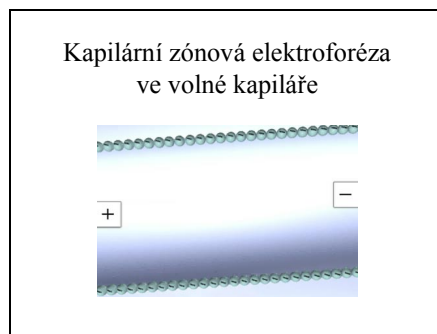

---

---

---

---

---

---

---

---

---

---

snímek 45

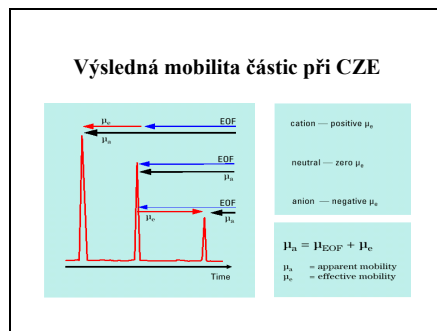

---

---

---

---

---

---

---

---

---

---

snímek 46

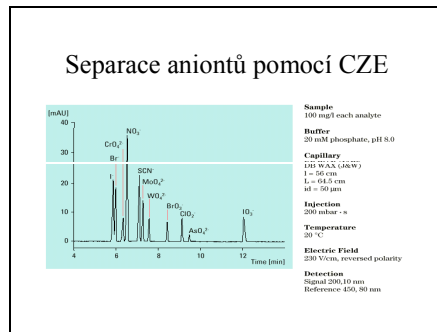

---

---

---

---

---

---

---

---

snímek 47

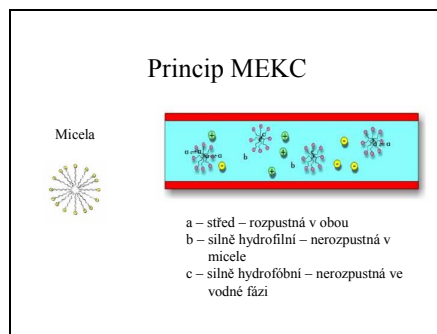

---

---

---

---

---

---

---

---

snímek 48

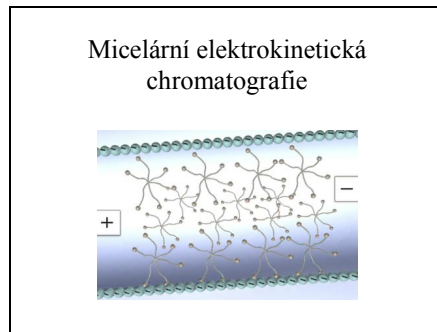

---

---

---

---

---

---

---

---



### snímek 49

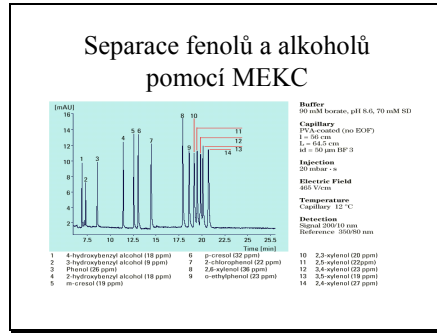

---

---

---

---

---

---

---

---

---

---

---

---

---

### snímek 50

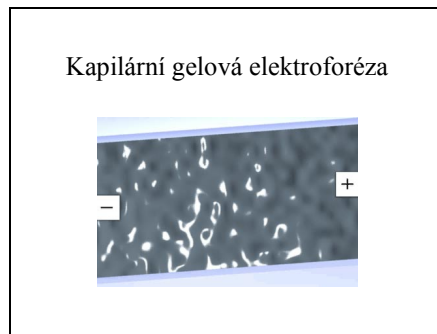

---

---

---

---

---

---

---

---

---

---

---

---

---

### snímek 51

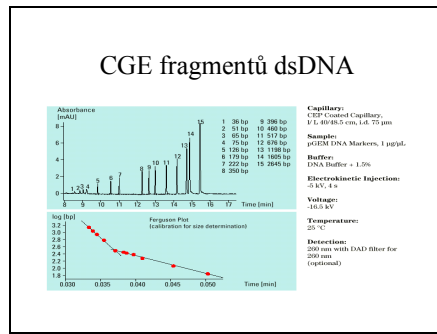

---

---

---

---

---

---

---

---

---

---

---

---

---

snímek 52

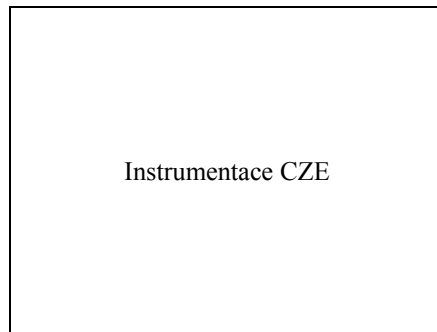

---

---

---

---

---

---

---

---

Instrumentace CZE

snímek 53

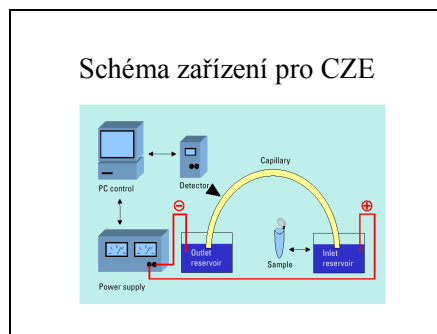

---

---

---

---

---

---

---

---

snímek 54

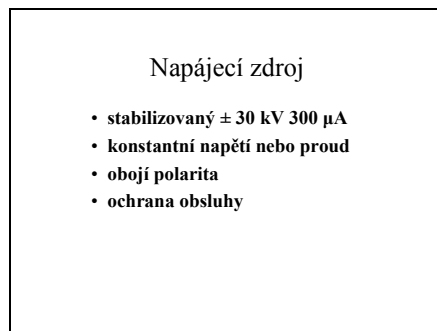

---

---

---

---

---

---

---

---

Napájecí zdroj

- stabilizovaný  $\pm 30$  kV 300  $\mu$ A
- konstantní napětí nebo proud
- obojí polarita
- ochrana obsluhy

snímek 55

**Kapilára**

- křemenná - 25 -100  $\mu\text{m}$  i.d  
- 350  $\mu\text{m}$  o.d.
- délka až 100 cm délka
- polyimidové vnější pokrytí

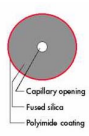

The diagram shows a cross-section of a capillary tube. It consists of a central 'Capillary opening', an outer layer of 'Fused silica', and an outermost layer of 'Polyimide coating'.

---

---

---

---

---

---

---

---

snímek 56

**Dávkování - hydrodynamické**

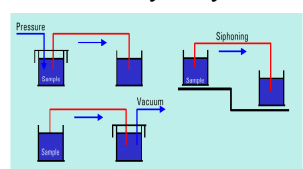

The diagram illustrates three hydrodynamic dosing methods. 1. 'Pressure': A reservoir on the left is connected to a 'Sample' reservoir, which is then connected to a 'Syringe' reservoir. 2. 'Vacuum': A reservoir on the left is connected to a 'Sample' reservoir, which is then connected to a 'Syringe' reservoir. 3. 'Siphoning': A reservoir on the left is connected to a 'Sample' reservoir, which is then connected to a 'Syringe' reservoir.

---

---

---

---

---

---

---

---

snímek 57

**Dávkování - elektrokinetické**

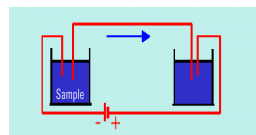

The diagram shows an electrokinetic dosing setup. A reservoir labeled 'Sample' is connected to a reservoir with a positive charge (+). A red arrow indicates the direction of flow from the 'Sample' reservoir to the positively charged reservoir.

---

---

---

---

---

---

---

---

snímek 58

**Detekce spektrofotometrická**

UV light source

$Abs = \epsilon cl$

where  
 $\epsilon$  = molar absorptivity  
 $c$  = concentration  
 $l$  = pathlength

---

---

---

---

---

---

---

---

snímek 59

**Detekce fluorescenční**

Light  
Excitation  $\lambda$       Emission  $\lambda$

---

---

---

---

---

---

---

---

snímek 60

**Izoelektrická fokusace**

*„Elektroforéza v gradientu pH,  
částice jsou separovány podle  
svých pI“*

---

---

---

---

---

---

---

---

snímek 61

**Tvorba gradientu**

**Anoda (+)  $\text{H}_3\text{O}^+$   $6\text{H}_2\text{O} \rightarrow \text{O}_2 + 4\text{H}_3\text{O}^+ + 4\text{e}^-$**

**Katoda (-)  $\text{OH}^-$   $4\text{H}_2\text{O} \rightarrow 2\text{H}_2 + 4\text{OH}^- - 4\text{e}^-$**

**Ampholyty**

$$\begin{array}{c} \text{---CH}_2\text{---N---(CH}_2\text{)}_n\text{---N---CH}_2\text{---} \\ | \qquad \qquad \qquad | \\ \text{(CH}_3\text{)}_3 \qquad \qquad \text{R} \\ \text{NR}_3 \qquad \qquad \qquad \text{R-CH}_2 \\ \qquad \qquad \qquad \qquad \qquad \text{-CH}_2\text{COOH} \\ \qquad \qquad \qquad \qquad \qquad \text{-H} \end{array}$$

---

---

---

---

---

---

---

---

snímek 62

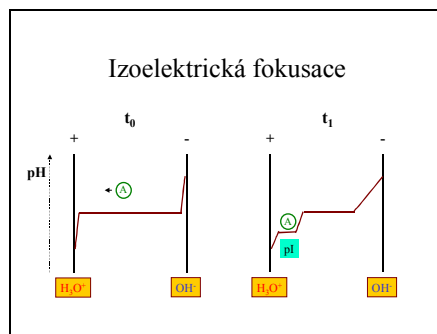

---

---

---

---

---

---

---

---

snímek 63

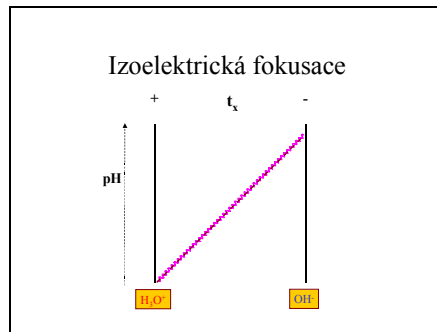

---

---

---

---

---

---

---

---

snímek 64

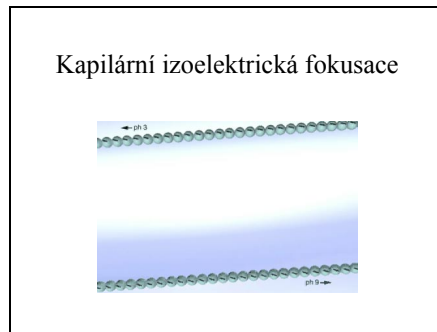

---

---

---

---

---

---

---

---

snímek 65

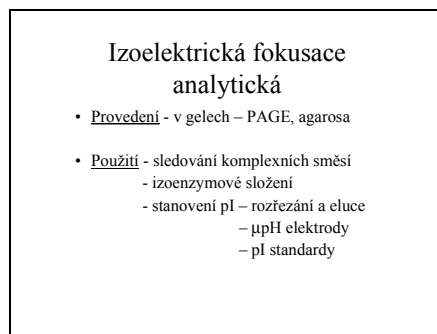

---

---

---

---

---

---

---

---

snímek 66



---

---

---

---

---

---

---

---

snímek 67



---

---

---

---

---

---

---

---

snímek 68

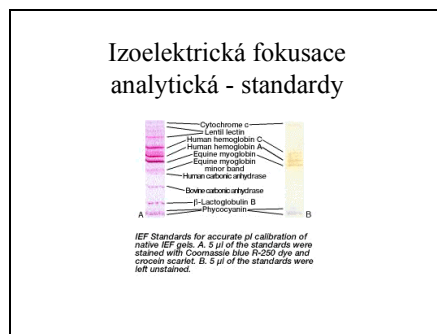

---

---

---

---

---

---

---

---

snímek 69

**Izoelektrická fokusace preparativní**

- **Provedení** - v sypaných vrstvách – Sephadex
  - v gradientech hustoty – sacharoza
  - rotaci – Rotofor (BioRad)



- **Použití** – izolace bílkovin

---

---

---

---

---

---

---

---

snímek 70

**Dvourozměrné metody**

- Metoda titračních křivek
- Dvourozměrná elektroforéza

---

---

---

---

---

---

---

---

snímek 71

**Metoda titračních křivek**

I.rozměr – IEF  
bez vzorku

II.rozměr – elektroforéza  
se vzorkem

---

---

---

---

---

---

---

---

snímek 72

**Dvojrozměrná elektroforéza**

I.rozměr IEF

II.rozměr SDS-PAGE

---

---

---

---

---

---

---

---



snímek 73

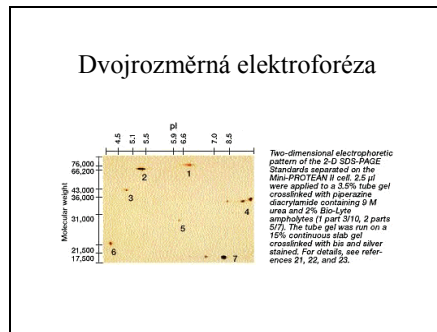

---

---

---

---

---

---

---

---

snímek 74

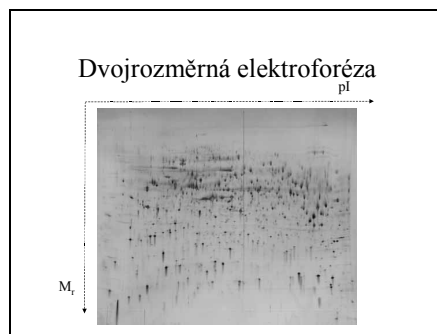

---

---

---

---

---

---

---

---

snímek 75

### Izotachoforéza

*„Vzorek je umístěn mezi dva elektrolyty : vedoucí L (leading) s nejvyšší mobilitou a - uzavírající T (terminating) s nejmenší mobilitou“*

---

---

---

---

---

---

---

---

snímek 76

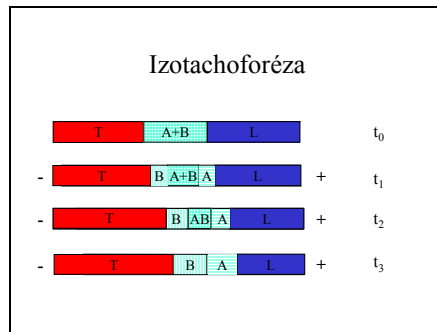

---

---

---

---

---

---

---

---

snímek 77

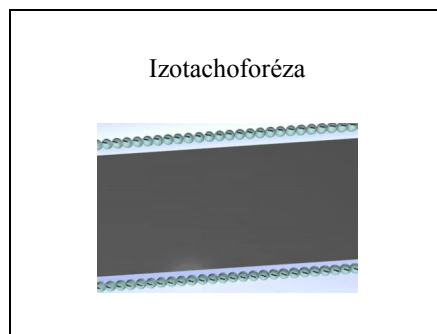

---

---

---

---

---

---

---

---

snímek 78

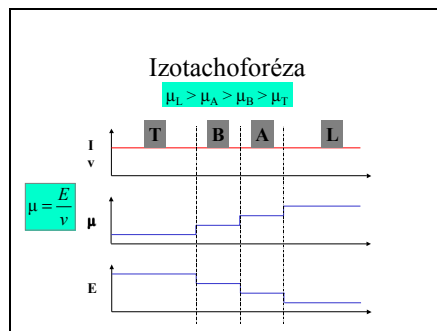

---

---

---

---

---

---

---

---

snímek 79

Kohlrauschova regulační funkce

$$\sum_i \sum_z \frac{|z|^{c_i}}{\mu^{c_i}} = K_i$$
$$c_i = c_i \cdot \frac{\mu_i + \mu_s}{\mu_i} \cdot \frac{\mu_i}{\mu_i + \mu_s} \cdot \frac{z_i}{z_i}$$

---

---

---

---

---

---

---

---

snímek 80

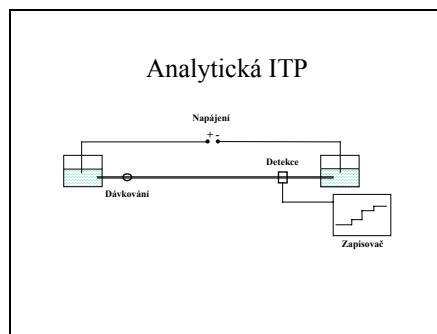

---

---

---

---

---

---

---

---

snímek 81

Analytická ITP  
instrumentace

- Napájení - stejnosměrné 30 kV 0,2 – 0,5mA
- Kapilára 0,1 – 2 mm
- Dávkování - dávkovací ventil
- Detekce - universální – konduktometrická
  - potencialně
  - gradientová
- selektivní – UV-VIS

---

---

---

---

---

---

---

---

snímek 82

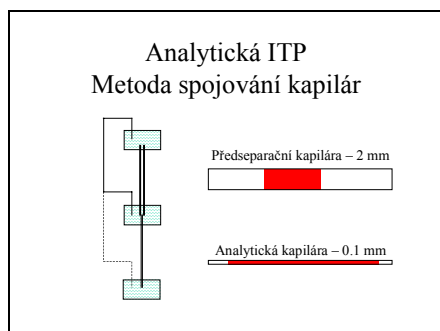

---

---

---

---

---

---

---

---

snímek 83

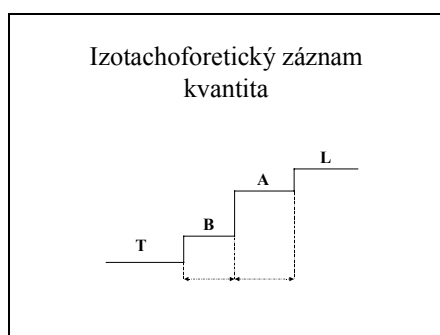

---

---

---

---

---

---

---

---

snímek 84

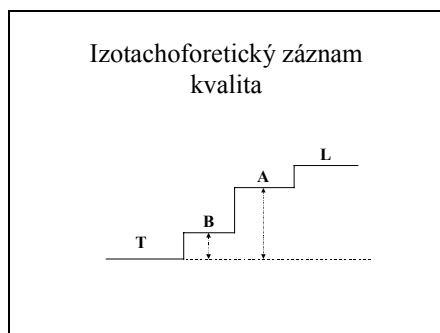

---

---

---

---

---

---

---

---

snímek 85

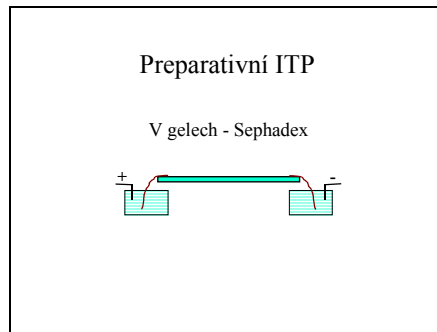

---

---

---

---

---

---

---

---

snímek 86

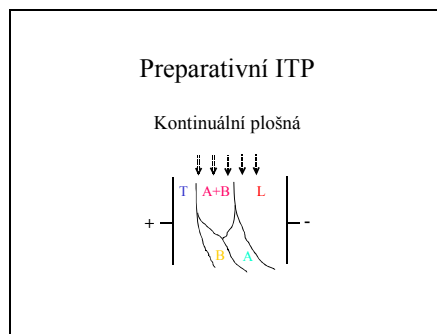

---

---

---

---

---

---

---

---

snímek 87

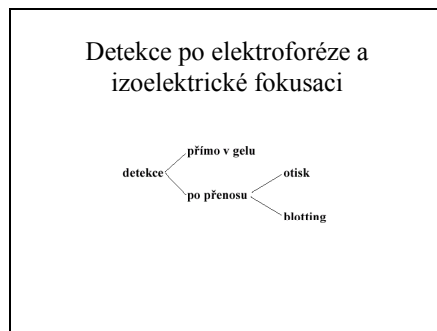

---

---

---

---

---

---

---

---

snímek 88

**Nespecifická detekce**  
**Reakce s barvičkou**

Postup : A. Fixace  
B. Barvení  
C. Odbarvování

Používané barvičky *Amido Black 10 B*  
*Coomassie Brilliant Blue R 250*  
*Coomassie Brilliant Blue G 250*  
*Fast Green*  
*Ponceau S*

---

---

---

---

---

---

---

---

snímek 89

**Nespecifická detekce**

**Barvení Ag**

Ag — amoniakální Ag<sup>+</sup>  
— AgNO<sub>3</sub>

Postup : A. Navázání Ag<sup>+</sup> na bílkovinu  
B. Redukce Ag<sup>+</sup> na Ag<sup>0</sup>

---

---

---

---

---

---

---

---

snímek 90

**Nespecifická detekce**

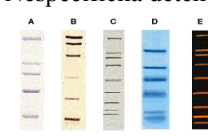

SDS-PAGE Standards provide accurate molecular weight determinations. A. High range SDS-PAGE Standards run on a 7.5% gel and stained with Coomassie Brilliant Blue R 250 dye. B. Low range Silver Stain SDS-PAGE Standards run on a 12% gel and stained with Bio-Rad's Silver Stain K<sub>1</sub>. C. Broad range Bio-Rad's SDS-PAGE Standards run on a 4-20% gradient gel, blotted to nitrocellulose, and detected with Anti-AP. D. Polypeptide SDS-PAGE Standards run on a 16.5% Tris/Glycine gel and stained with Coomassie Brilliant Blue G-250 dye. E. Broad range SDS-PAGE standards for SYPRO Orange staining run on a 4-20% gel and stained with SYPRO Orange.

---

---

---

---

---

---

---

---

snímek 91

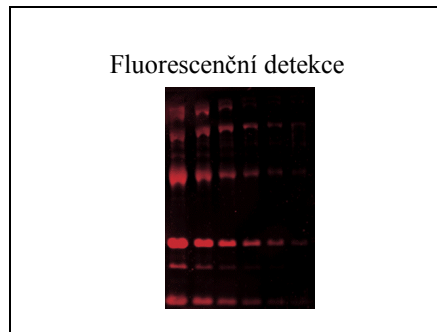

---

---

---

---

---

---

---

---

snímek 92

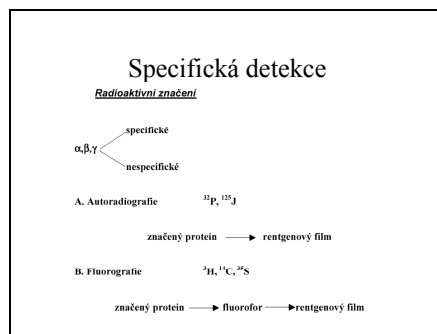

---

---

---

---

---

---

---

---

snímek 93

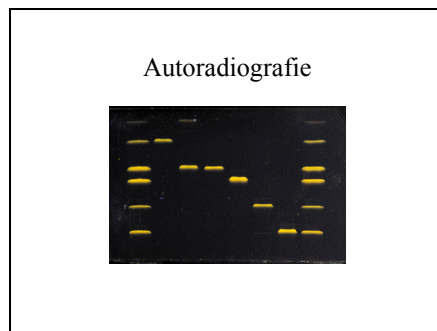

---

---

---

---

---

---

---

---

snímek 94

**Specifická detekce**

Detekce různých skupin bílkovin

glykoproteiny	-	Schiffova reakce (oxidace s $\text{HIO}_4$ , reakce s Schiffovým činidlem - bazický fuchsín)
lipoproteiny	-	Sudan B
hemoproteiny	-	peroxidázová aktivita (hem + benzidín + $\text{H}_2\text{O}_2$ )
$\text{Cu}^{2+}$	-	alizarín
$\text{Fe}^{3+}$	-	fenantrolin

---

---

---

---

---

---

---

---

snímek 95

**Detekce glykoproteinů**

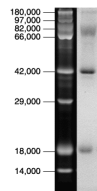

---

---

---

---

---

---

---

---

snímek 96

**Detekce na základě biologické aktivity**

Detekce na základě enzymové aktivity

Rozdělení

A. bezbarvý substrát → barevný produkt
B. barevný substrát → bezbarvý produkt
C. bezbarvý substrát → bezbarvý produkt → barevný produkt
D. auxiliární enzymy → barevný produkt

Detekce

- přímo v gelu
- přímo v gelu se zapolymerovanými substráty
- otisk - zymogram
- indikátorové gely

---

---

---

---

---

---

---

---



snímek 97

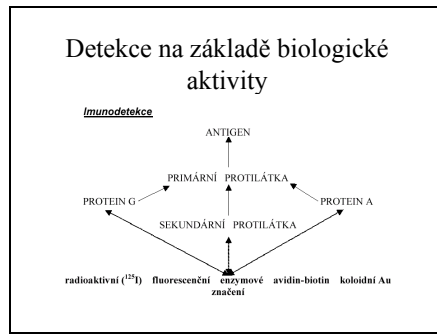

---

---

---

---

---

---

---

---

snímek 98

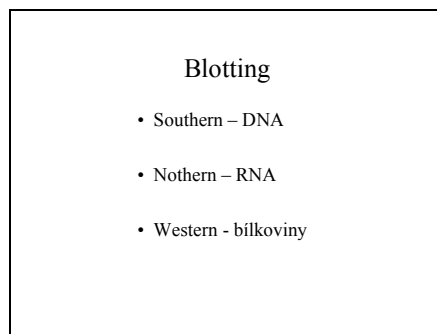

---

---

---

---

---

---

---

---

snímek 99

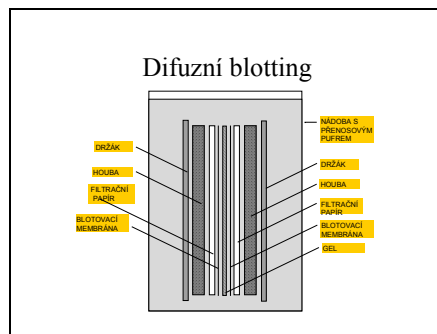

---

---

---

---

---

---

---

---

snímek 100

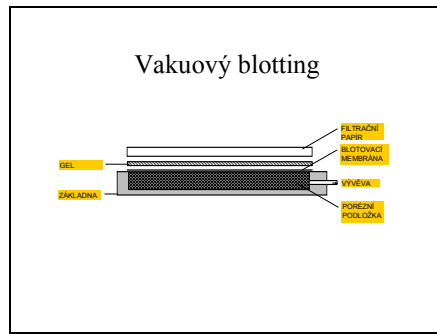

---

---

---

---

---

---

---

---

snímek 101

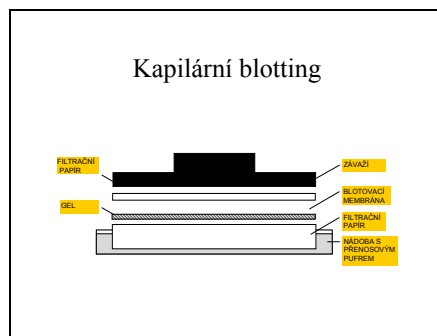

---

---

---

---

---

---

---

---

snímek 102

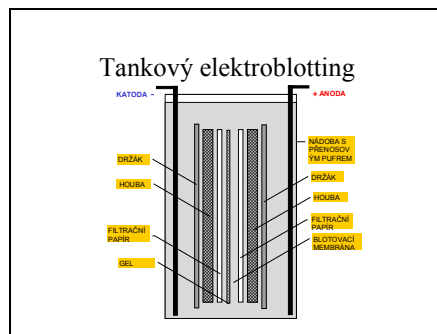

---

---

---

---

---

---

---

---

snímek 103



---

---

---

---

---

---

---

---

snímek 104

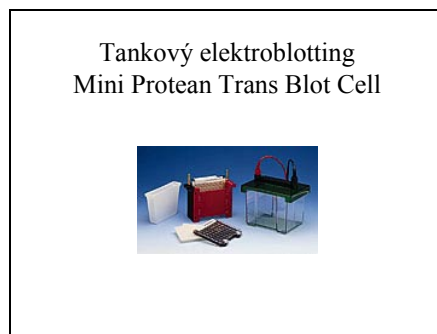

---

---

---

---

---

---

---

---

snímek 105

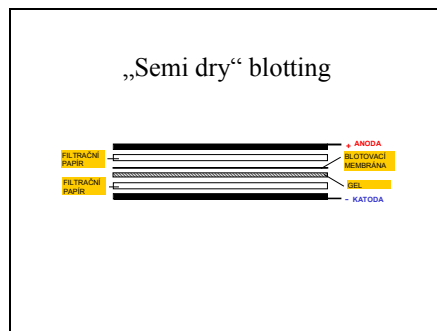

---

---

---

---

---

---

---

---

snímek 106

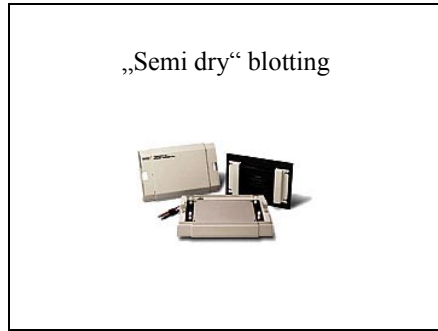

---

---

---

---

---

---

---

snímek 107

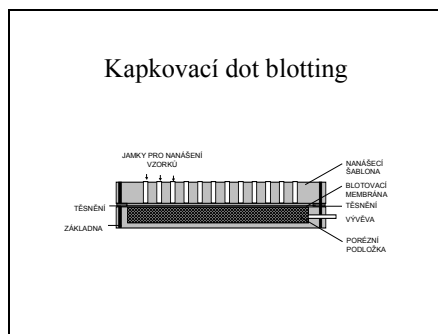

---

---

---

---

---

---

---