

Geography Academic Writing Course

How the write better abstracts?

Petr Sudický
KAA FF MU
sudicky@phil.muni.cz

Academic Writing in English

My research is excellent and will speak for itself!

- international character of academia
- conventions and models of each discipline
- writing style equally important as content
- academic English
 - clear structure, thesis statement at the beginning
 - formulaic language
- quality in lies not in being particularly inventive, but in the mastery of the discipline-specific language

What is a good abstract?

What is your idea of a well-written abstract?

“A well-written abstract should be powerful enough to persuade the reader/reviewer that the research article/dissertation itself is worth publishing/reading.”

Abstract functions

Why on earth do we have to write the abstracts?

- 1) screening devices – reader's decision
- 2) mini-texts – short summary
- 3) preview – roadmap for reader's
- 4) help for reviewers – oversight of the paper
- 5) indexing help – writers and editors

! writing ability of the author + novelty of the topic

Abstract structure

Is there a general structure for abstracts?

- 1) introduction/general background
- 2) aim/purpose of the work
- 3) methodology applied
- 4) results and outcomes
- 5) discussion/evaluation

clear structure = easy reading = positive feedback

Structure of dissertation abstracts (UM)

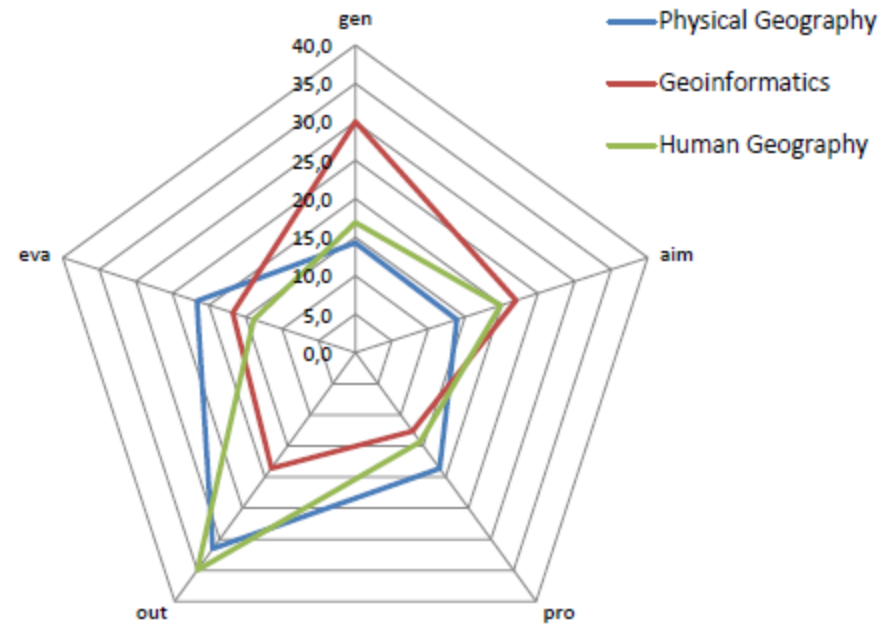
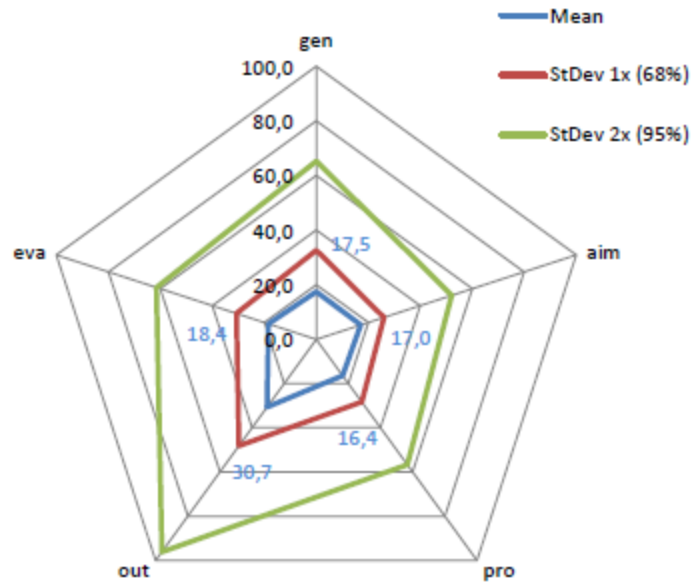

Abstract structure types (UM)

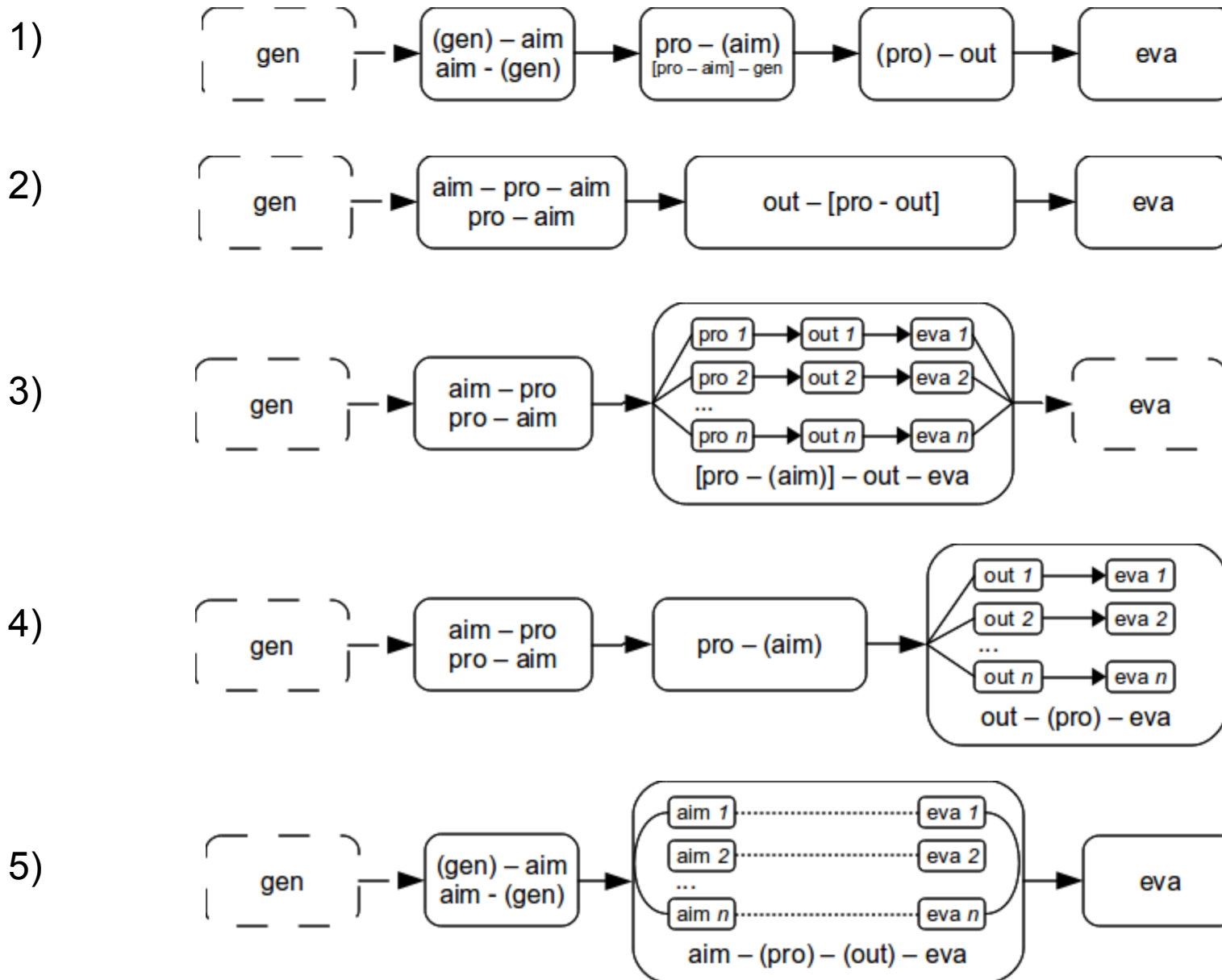

Influences on abstract writing

- norms of the journal, conference
- influence of the supervisor
- timing, time of writing
- general writing skills
- formal academic writing training
- purpose of the abstract
- gravity of the occasion

Functions of Abstracts: **UM** and **MU**

UM: Global Relative Mean Move Distribution

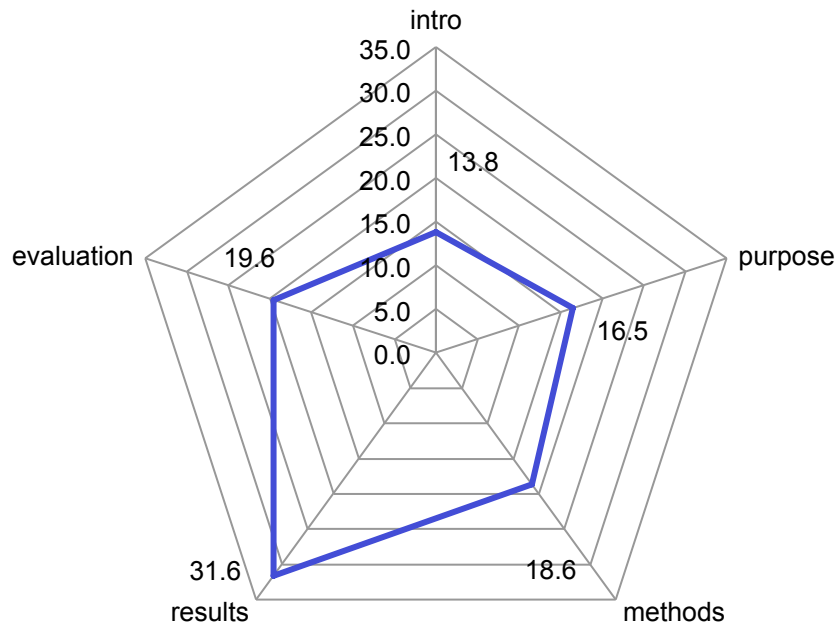

MUNI: Global Relative Move Distribution

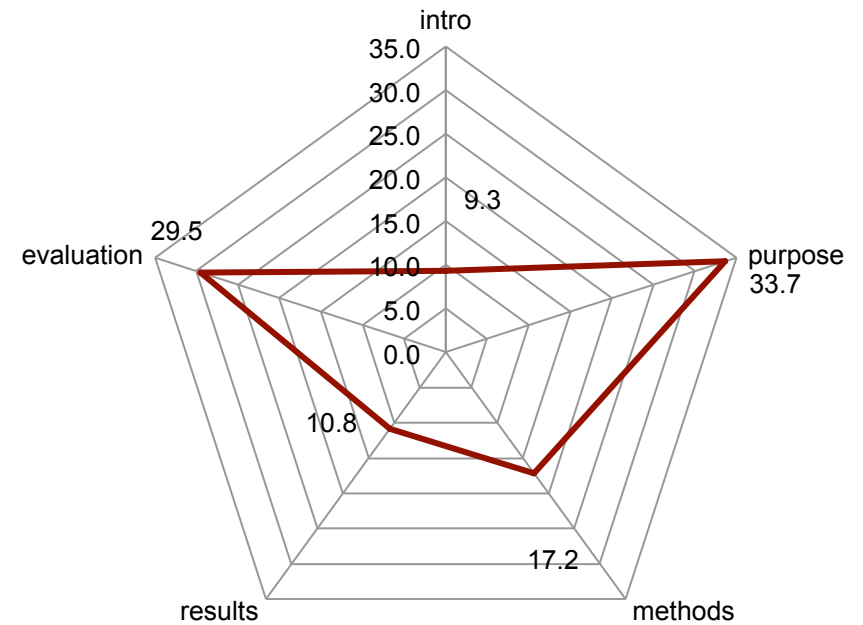

Abstract Types: UM and MUNI Totals

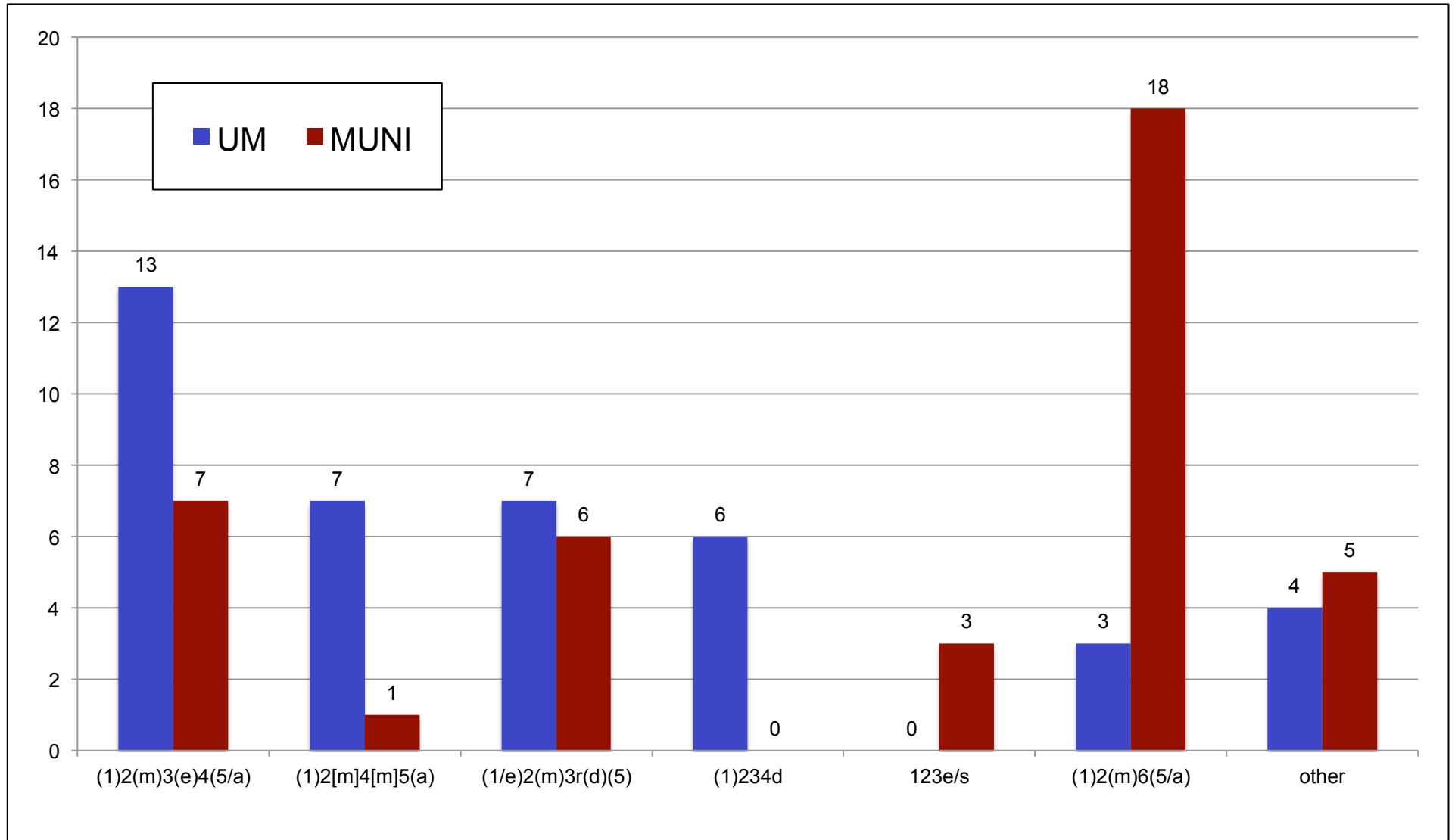

Abstracts and sub-disciplines (UM)

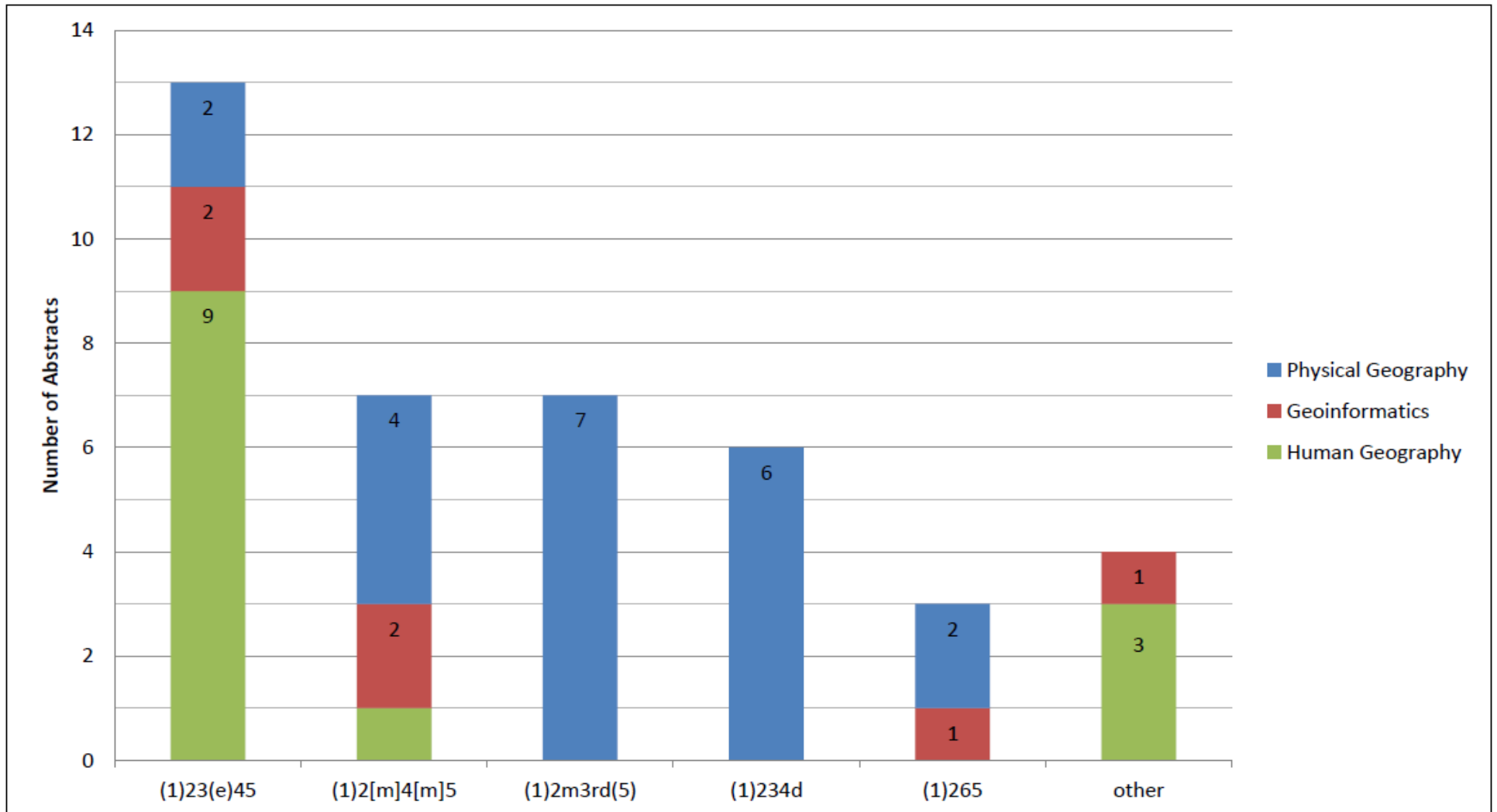

Abstract Types and Sub-disciplines (MU)

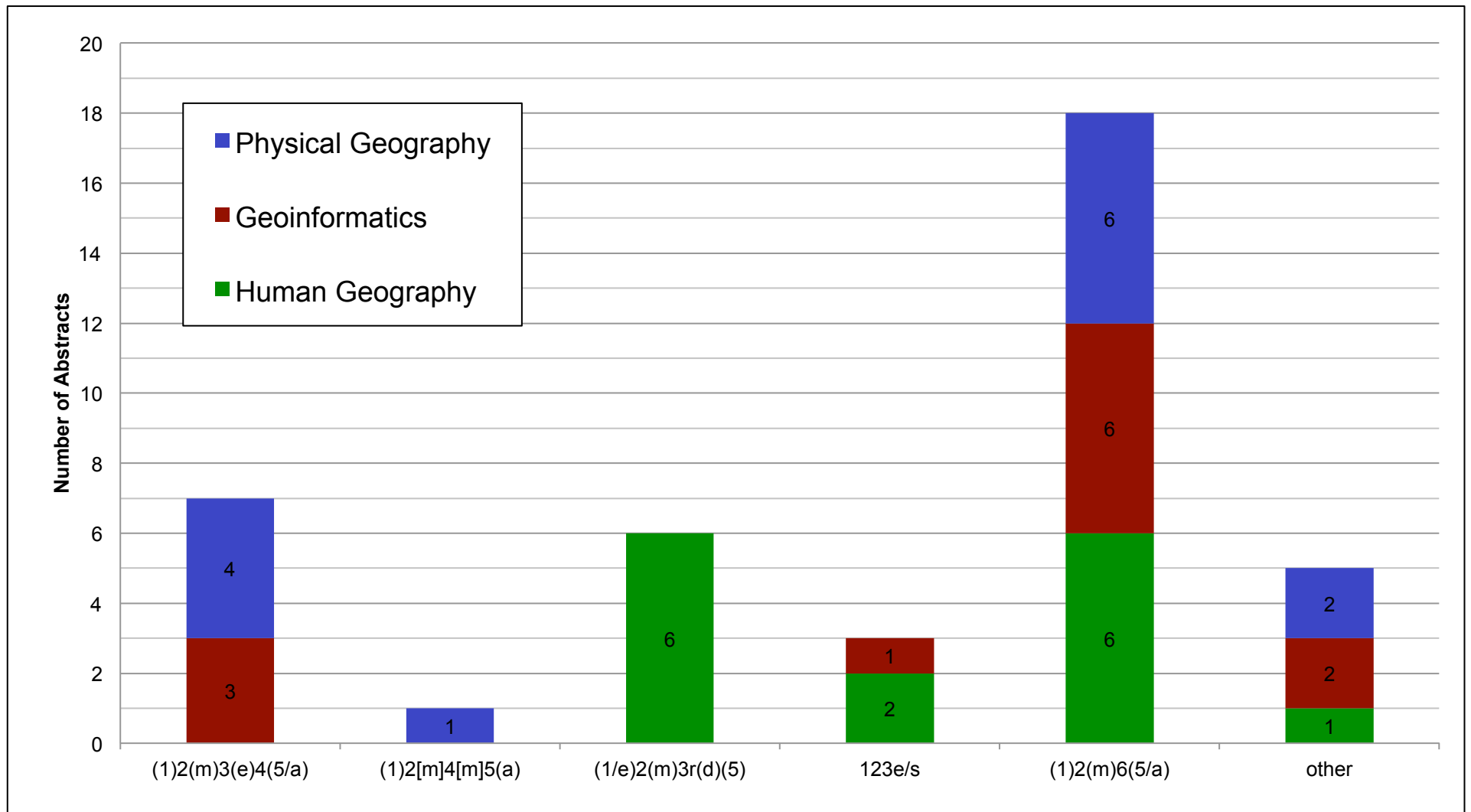

Filling the structure with words

“Producing a piece of academic writing, such as an essay, a research report, a summary, or a thesis, can sometimes be a difficult task. Even when we know what we want to write about, the question is: **how do we express our ideas adequately in an academic paper?**”

[Usually], consulting a grammar book or writer's guide may not provide a straightforward answer, and it can be very interruptive for the writing process. Today, we will look into a quick and easy alternative: **we will learn how to look up a word or phrase and how it is used in corpus data.**” (Matt O'Donnel)

Thank you for your attention!

Petr Sudický
sudicky@phil.muni.cz