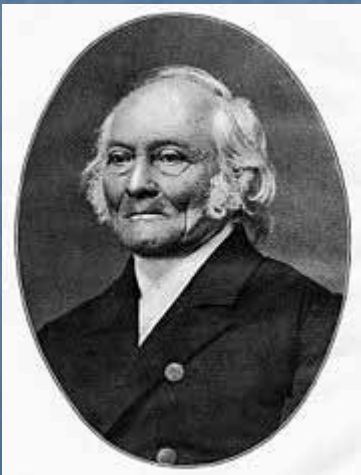


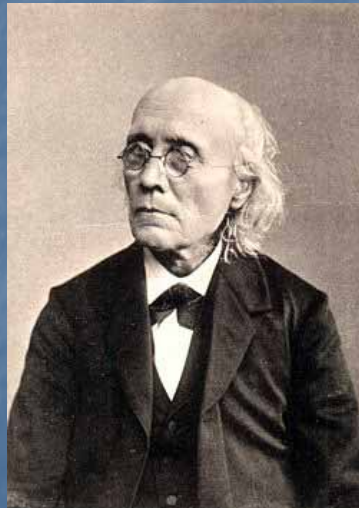
# Obecná fyziologie smyslů



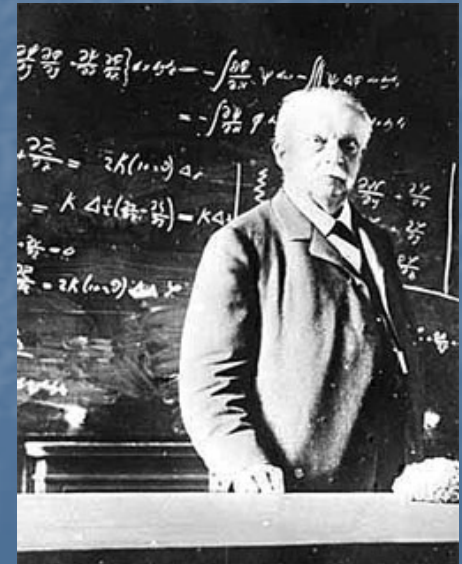
- Přes receptory vstupují informace do NS
- Smysly jsou branami do vědomí.
  - Jak vedou k subjektivní zkušenosti?
  - Jakými fyziologickými pochody?
  - Otcové experimentální psychologie



Ernst Weber  
1795-1878



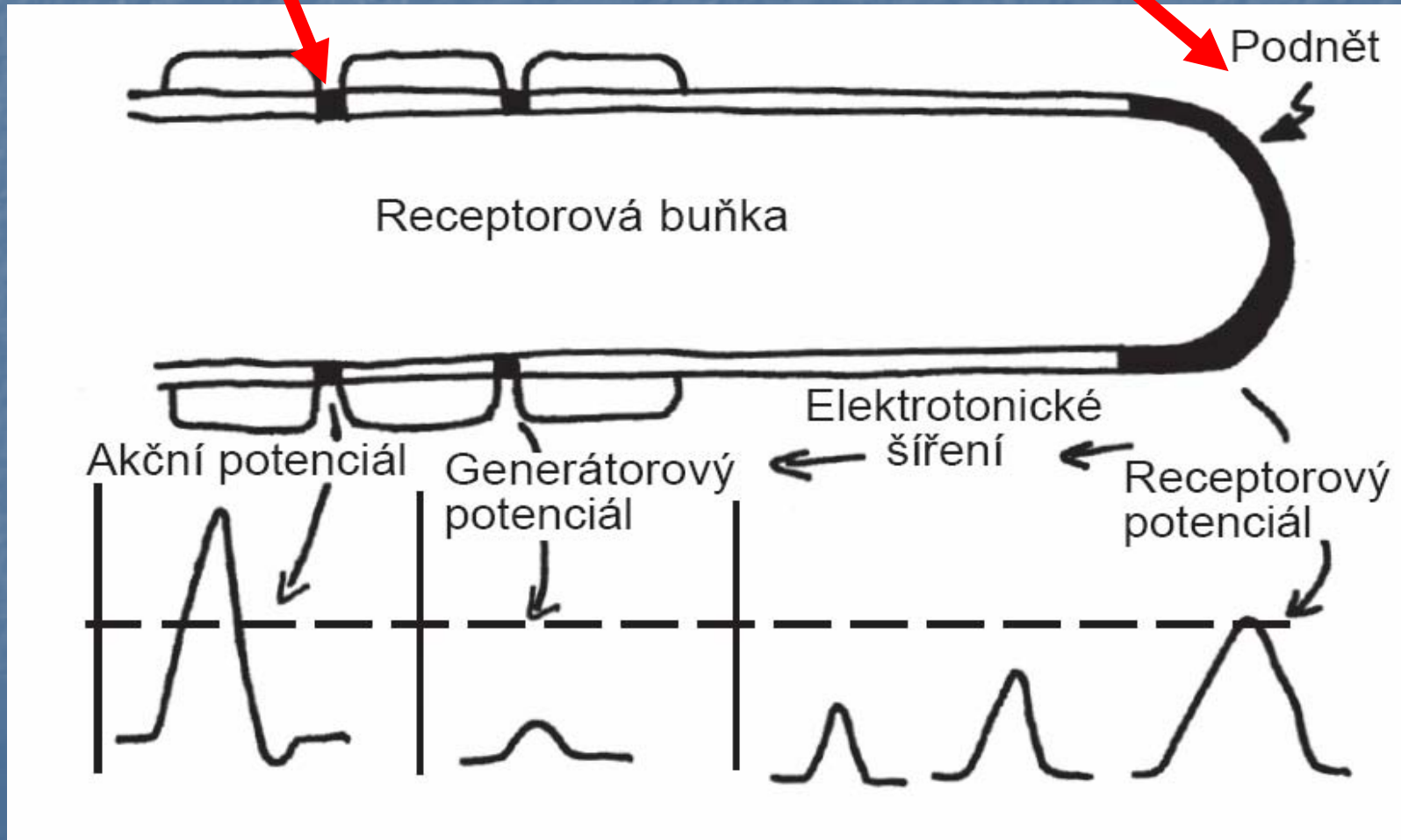
Gustav Fechner  
1801-1887



Hermann Helmholtz  
(1858 – 1871)

Transformace

Transdukce



Amplifikace

# Obecné principy

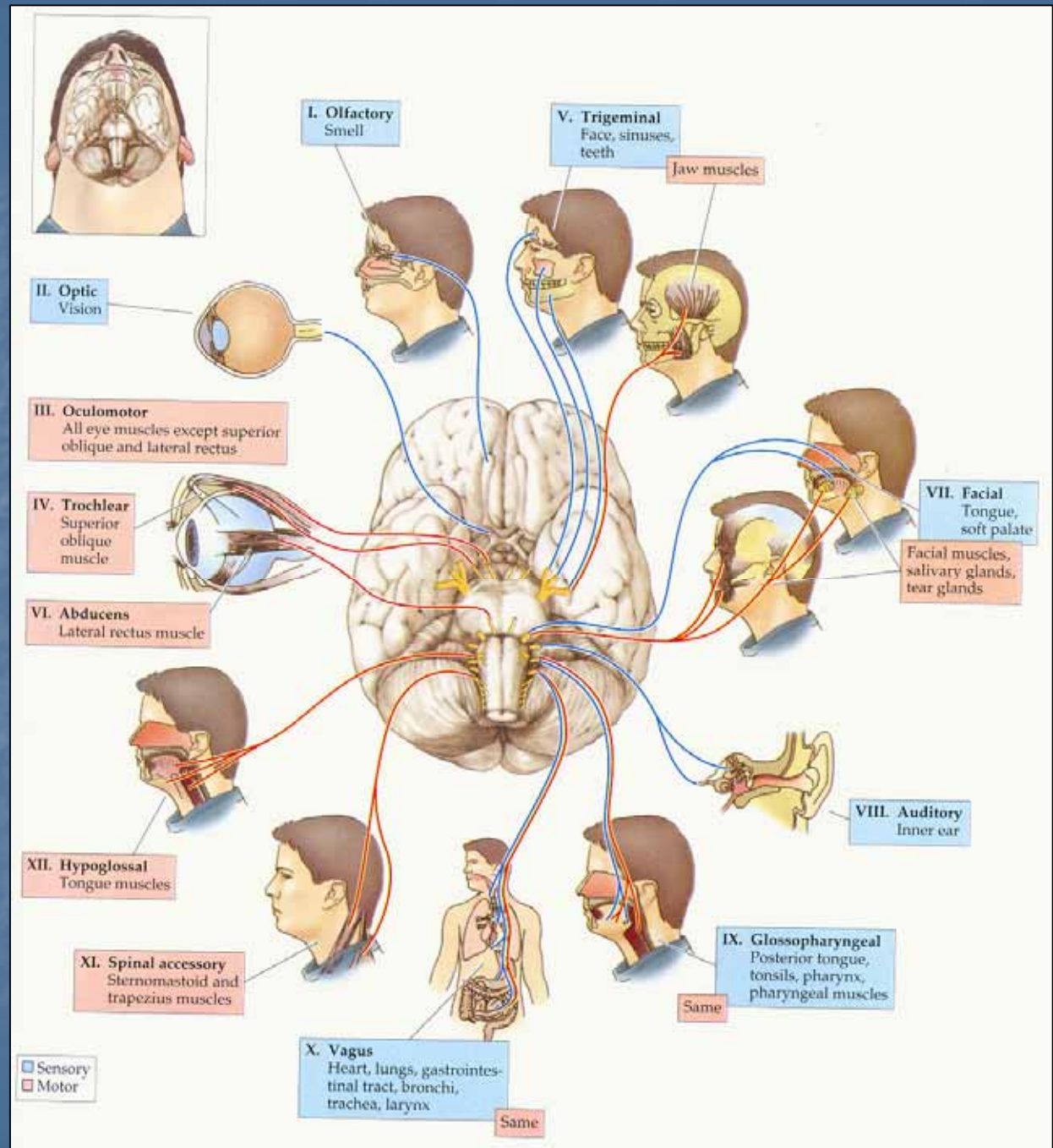
- 4 základní vlastnosti podnětu:
  - Modalita
  - Lokace („adresa“)
  - Intenzita
  - Trvání

# Modality – formy energie: chemická, teplotní, mechanická, světelná, elektrického a magnetického pole

Table 10.1 Main types of sensory modalities

Sensory modality	Form of energy	Receptor organ	Receptor cell
Chemical			
common chemical	molecules	various	free nerve endings
arterial oxygen	O <sub>2</sub> tension	carotid body	cells and nerve endings
toxins (vomiting)	molecules	medulla	chemoreceptor cells
osmotic pressure	osmotic pressure	hypothalamus	osmoreceptors
glucose	glucose	hypothalamus	glucoreceptors
pH (cerebrospinal fluid)	ions	medulla	ventricle cells
Taste	ions and molecules	tongue and pharynx	taste bud cells
Smell	molecules	nose	olfactory receptors
Somatosensory			
touch	mechanical	skin	nerve terminals
pressure	mechanical	skin and deep tissue	encapsulated nerve endings
heat and cold	temperature	skin, hypothalamus	nerve terminals and central neurons
pain	various	skin and various organs	nerve terminals
Muscle			
vascular pressure	mechanical	blood vessels	nerve terminals
muscle stretch	mechanical	muscle spindle	nerve terminals
muscle tension	mechanical	tendon organs	nerve terminals
joint position	mechanical	joint capsule and ligaments	nerve terminals
Balance			
linear acceleration (gravity)	mechanical	vestibular organ	hair cells
angular acceleration	mechanical	vestibular organ	hair cells
Hearing	mechanical	inner ear (cochlea)	hair cells
Vision	electromagnetic (photons)	eye (retina)	photoreceptors

Vstup určuje  
 Povahu (kvalitu)  
 vjemu- Labeled lines



## 3 úrovně organizace sensorických systémů

- A) Receptory
- B) Sensorické obvody a dráhy
- C) Sensorická percepce

## 3 úrovně organizace sensorických systémů

### A) Receptory

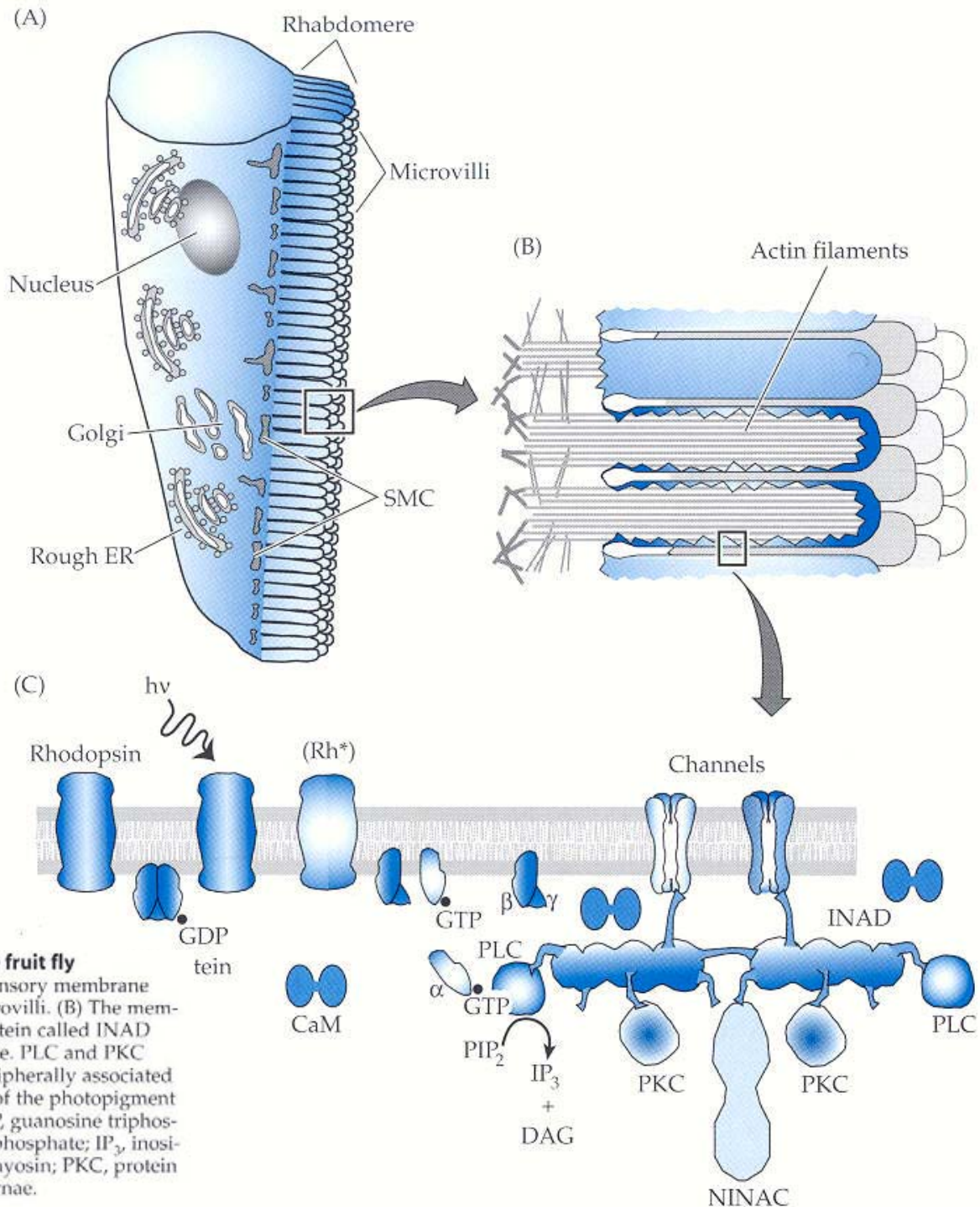
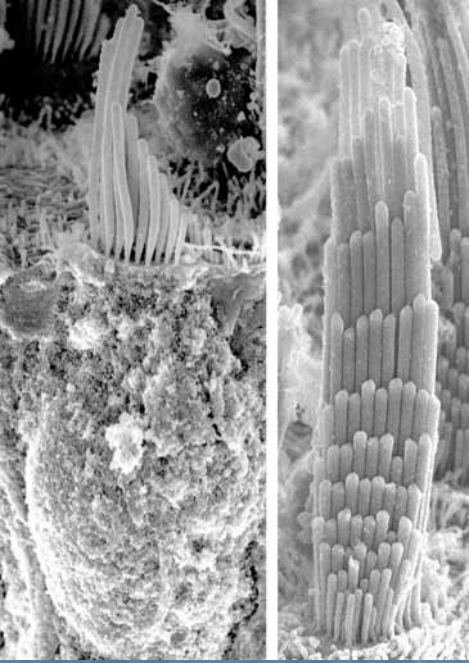
Sensorická membrána

a) mikrovili- mikrovlásky (vláskové buňky, vomeronasální chemorecepce, fotorecepce členovců)

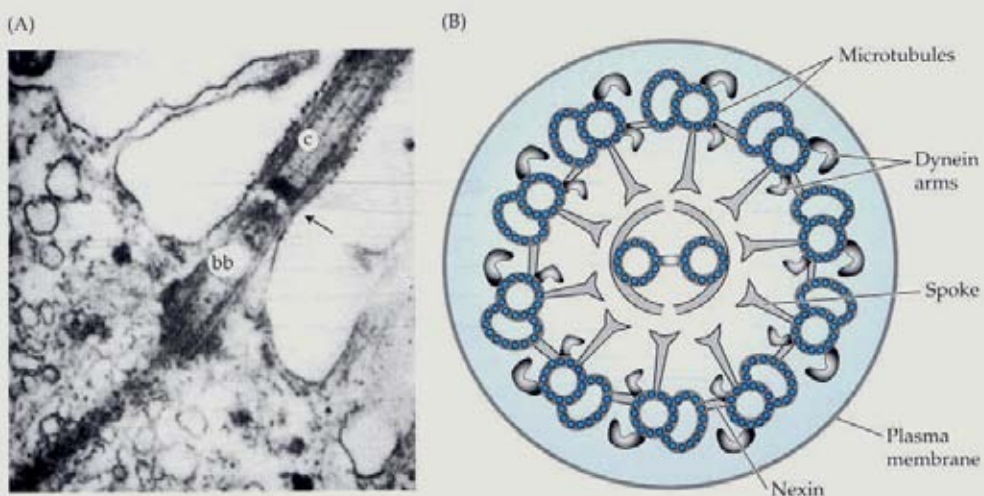
b) cilie – brvy, řasinky (čich v nosní sl., fotorecepce obratlovců)



Mikrovily, mikroklky  
 Mikrofilamenta  
 vláskové buňky,  
 čich, vom., foto. členov.



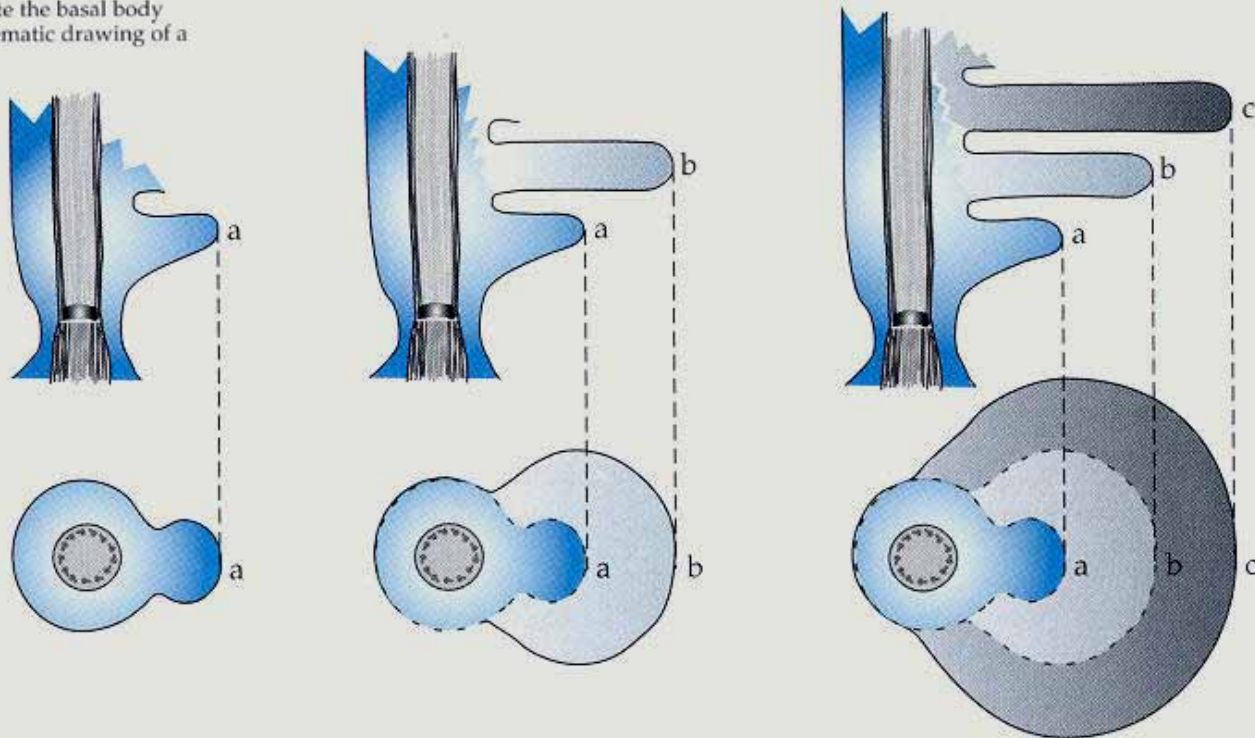
**Organization of sensory membrane of a photoreceptor in the fruit fly *Drosophila*** (A) Anatomy of a *Drosophila* photoreceptor. The sensory membrane forms a structure, called a rhabdomere, composed of 50,000 microvilli. (B) The membrane of the microvillus is highly organized by a scaffolding protein called INAD (C), which binds to proteins in the cytosol and plasma membrane. PLC and PKC proteins are shown as if cytosolic but are likely to be at least peripherally associated with the plasma membrane. Abbreviations: Rh\*, activated form of the photopigment rhodopsin; GDP, guanosine diphosphate; CaM, calmodulin; GTP, guanosine triphosphate; PLC, phospholipase C; PIP<sub>2</sub>, phosphatidylinositol 4,5-bisphosphate; IP<sub>3</sub>, inositol 1,4,5-triphosphate; DAG, diacylglycerol; NINAC, a form of myosin; PKC, protein kinase C; ER, endoplasmic reticulum; SMC, submicrovillar cisternae.



**Figure 2.3**  
**Cilium** (A) Structure of a cilium from a sea urchin embryo. Note the basal body (bb) at the base of the cilium (c). Magnification 22,000 $\times$ . (B) Schematic drawing of a cross section of cilium. (A from Chakrabarti et. al., 1998.)

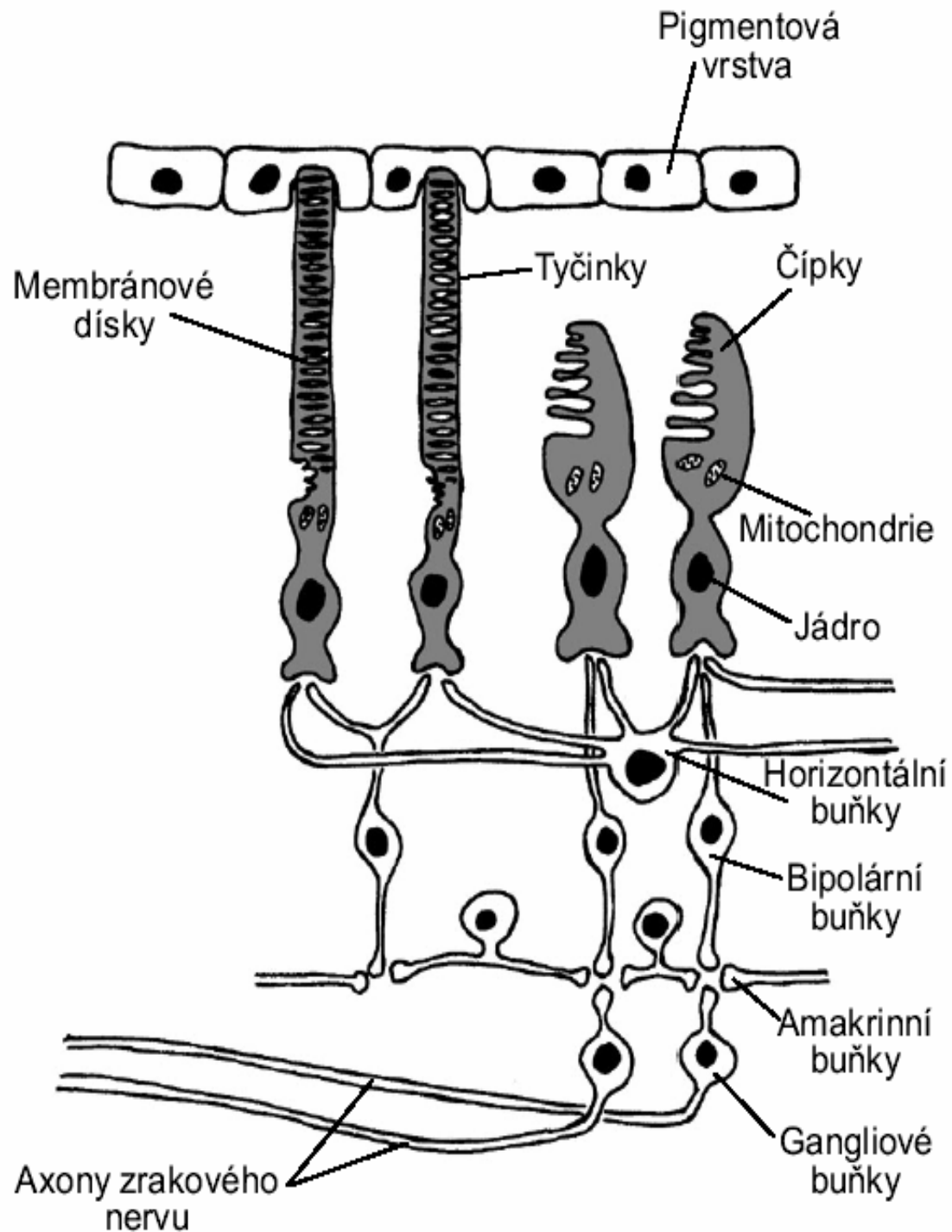
# Cilie (brvy, řasinky) Mikrotubuly

cilie (čich v nosní  
sliznici,  
fotoreceptory  
obratlovců)



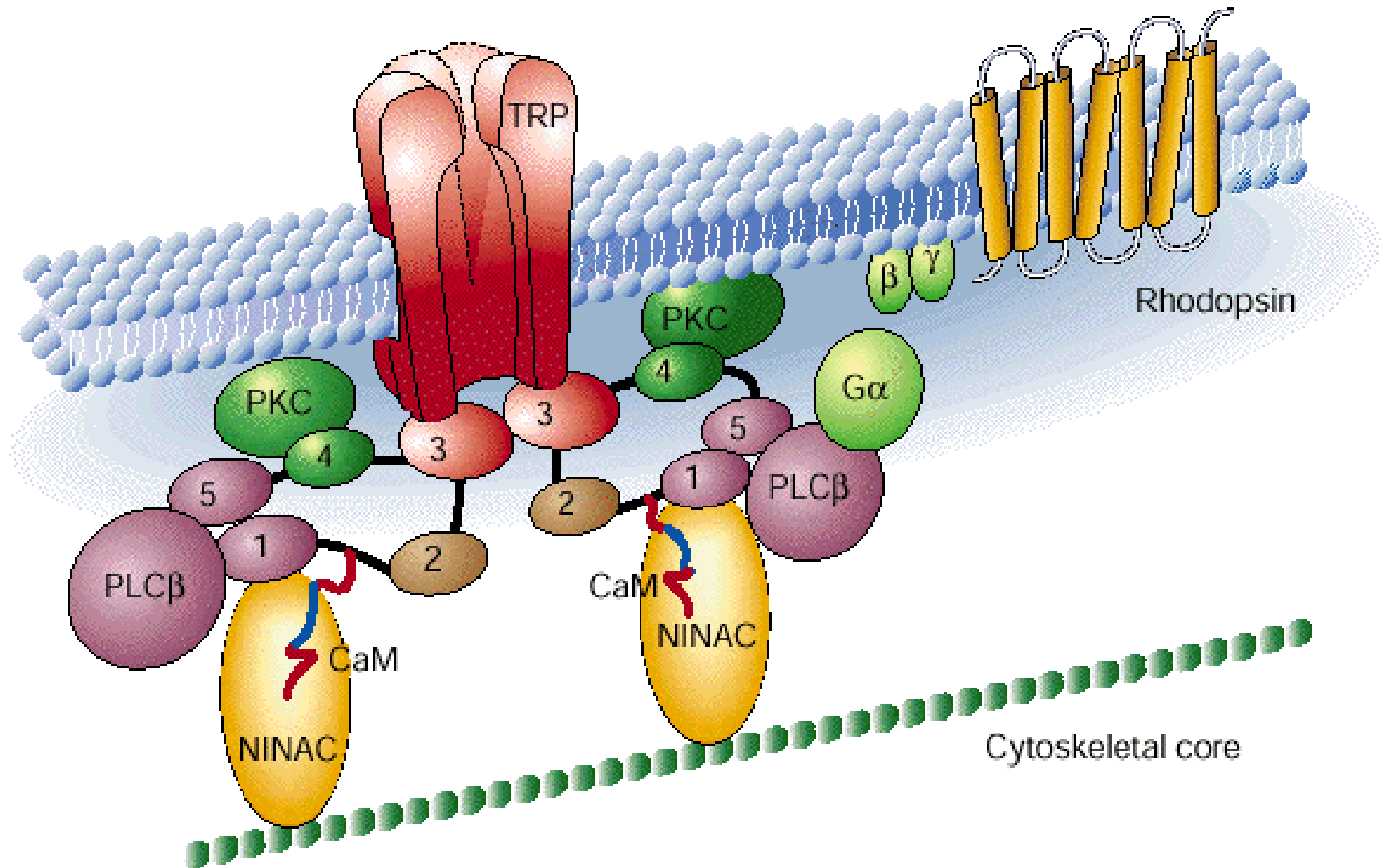
**Figure 2.4**  
**Formation of disks of a rod photoreceptor** Disks are initiated at the base of the rod outer segment adjacent to a cilium. (After Steinberg, 1980.)

Cilia jsou produkována z bazálních tělísek z centriol, která jsou v dělicích se buňkách nezbytná pro organizaci a separaci chromozómů. U tyčinek se ciliu organizuje a dává vznik vychlípeninám membrány. U tyčinek pak fúzuje membrána a měchýřky se odštípnou a tvoří vesikuly v cytoplasmě. U čípků není membránová fúze úplná, takže disky se neuzavřou.



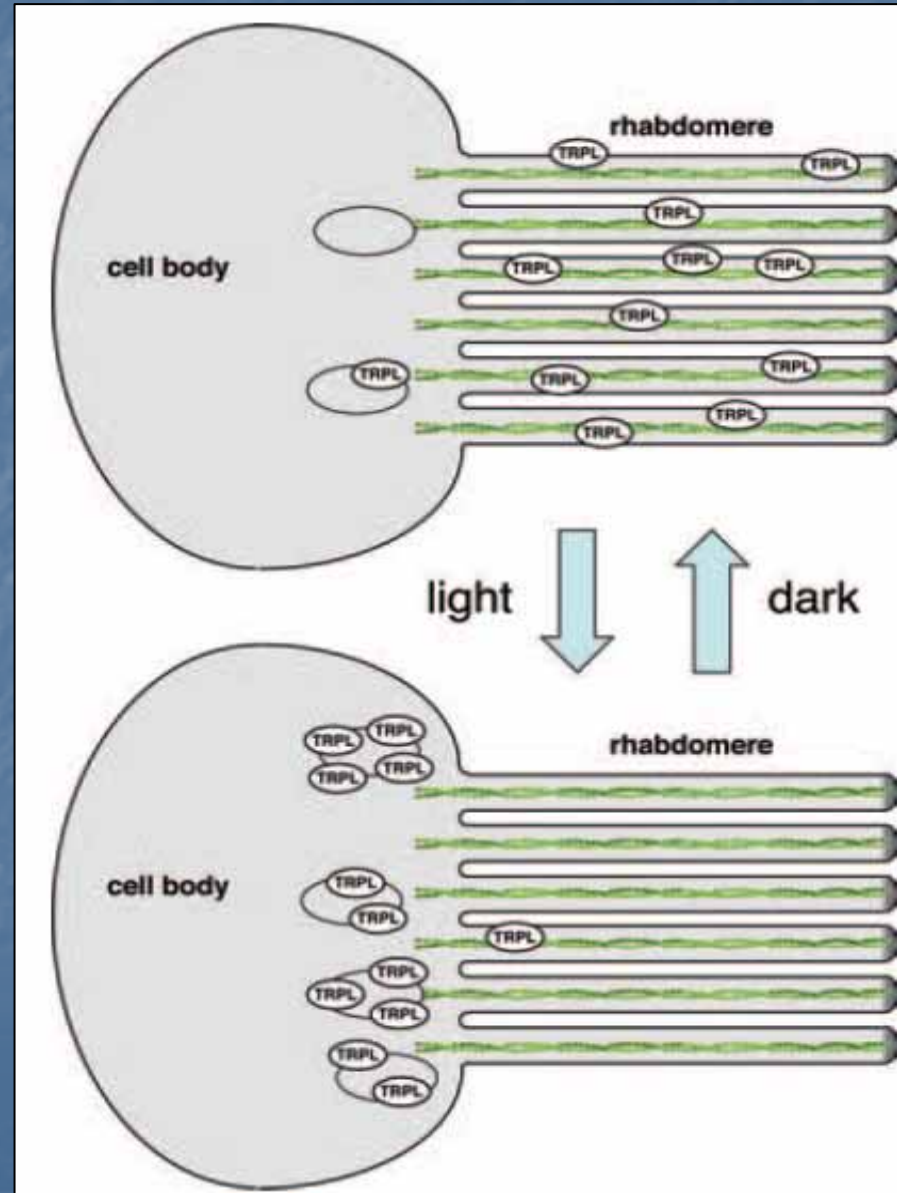
# Úloha cytoskeletu v signálních drahách recepčních buněk

Difuzní model signálového přenosu x Signalplex (transducizóm), scaffolding proteins; Multimolekulární signalizační komplex



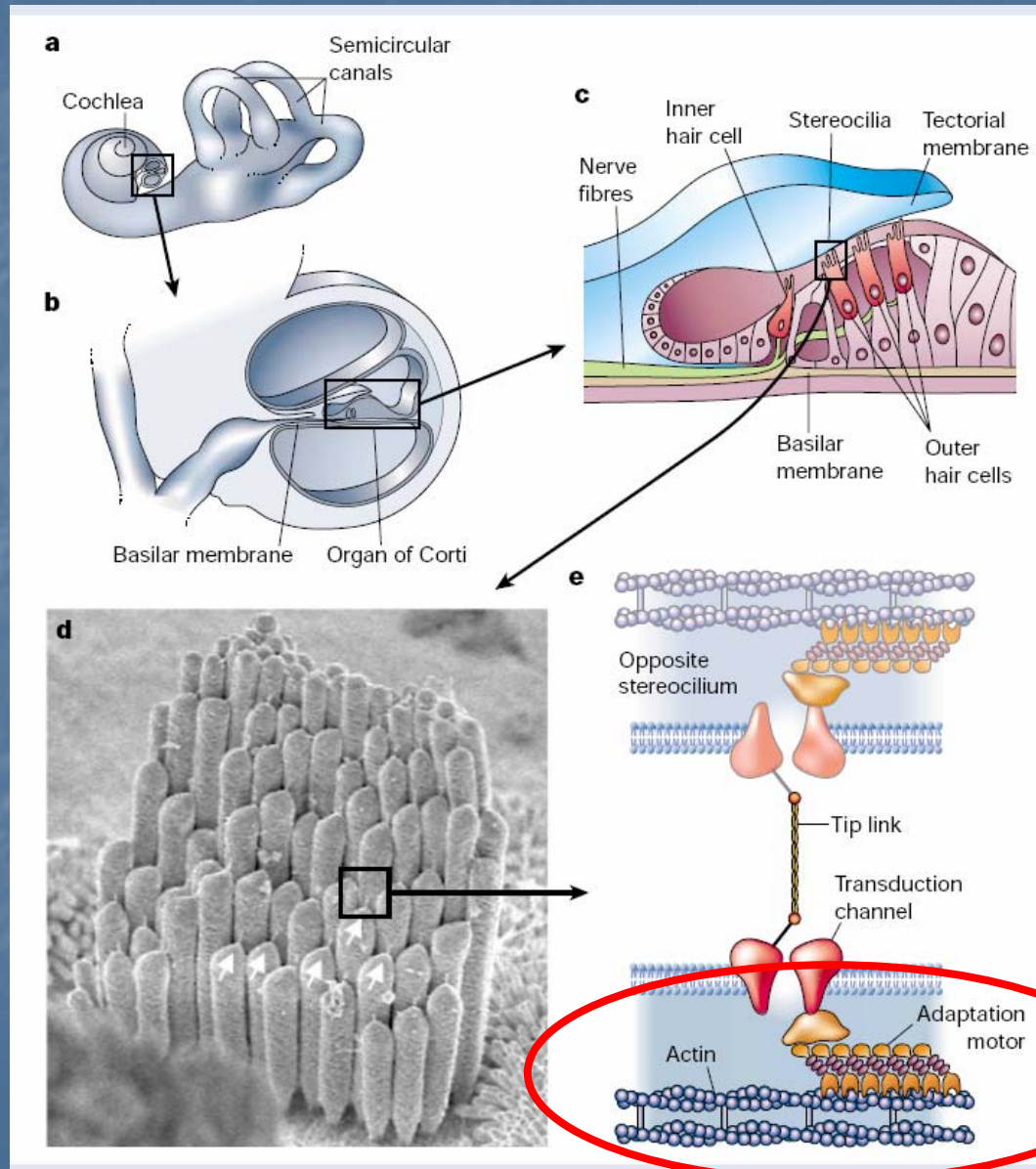
# Úloha cytoskeletu v signálních drahách recepčních buněk

Velká adaptabilita zraku Drosophily  
Translokace recepčního komplexu po aktinu  
podle množství dopadajícího světla.

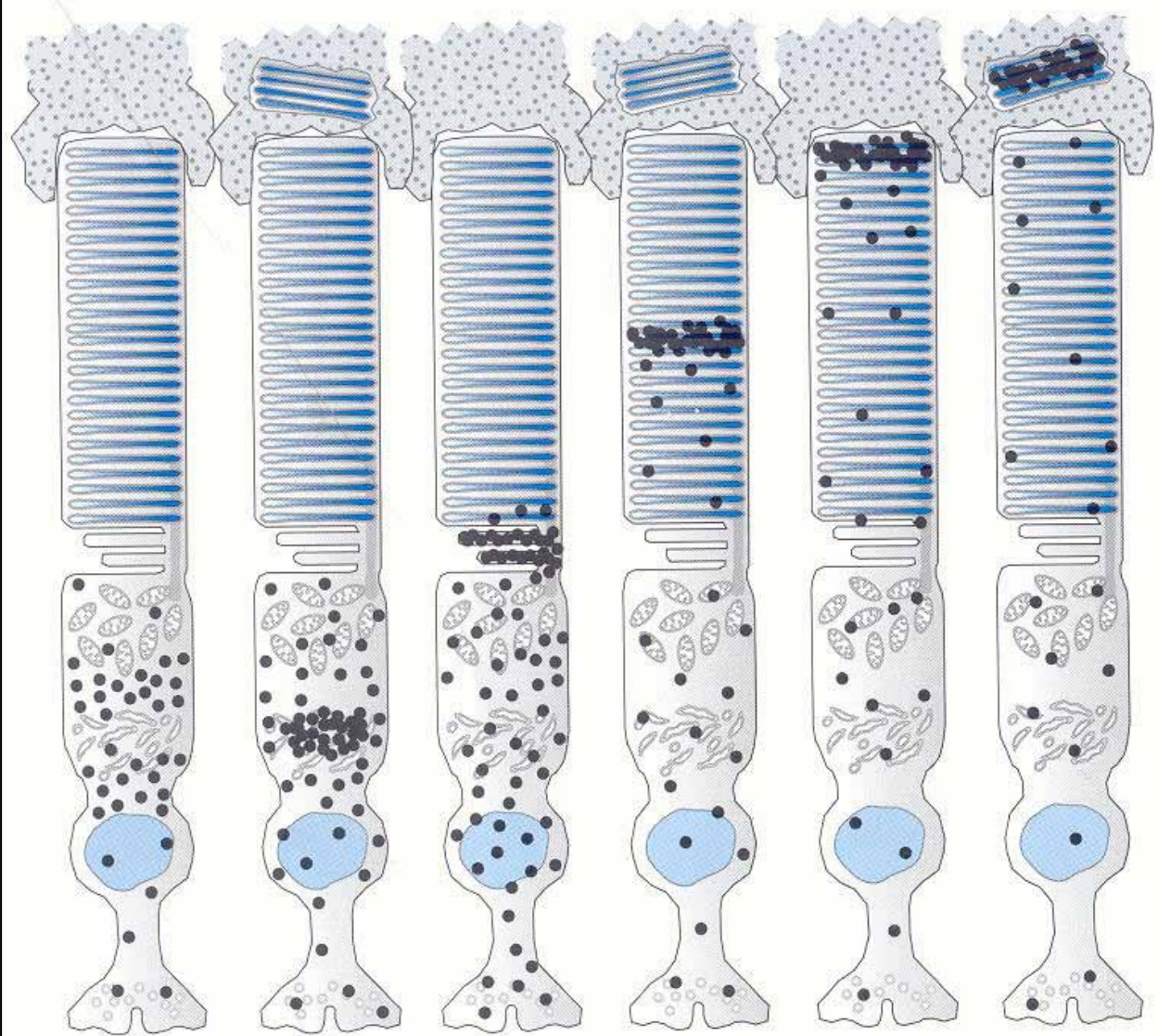


# Úloha cytoskeletu v signálních drahách recepčních buněk

Adaptabilita sluchu na rozsah intenzit  
Aktivní rezonanční aparát zesilující zvuky



# Obnova smyslové membrány

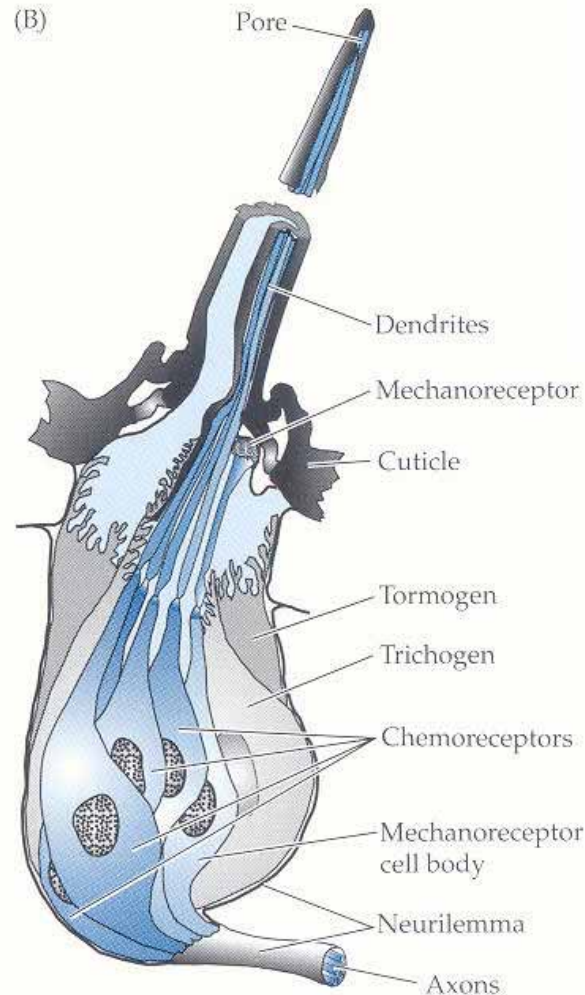
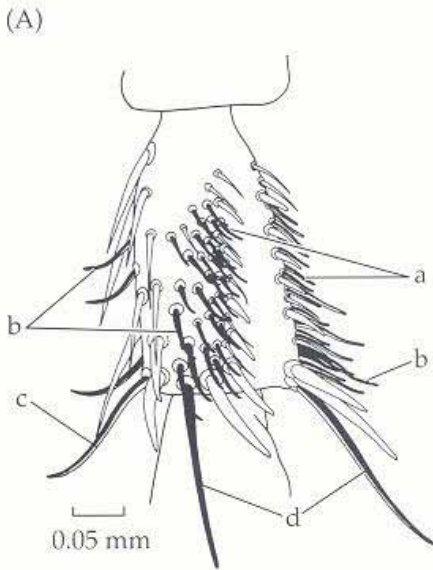
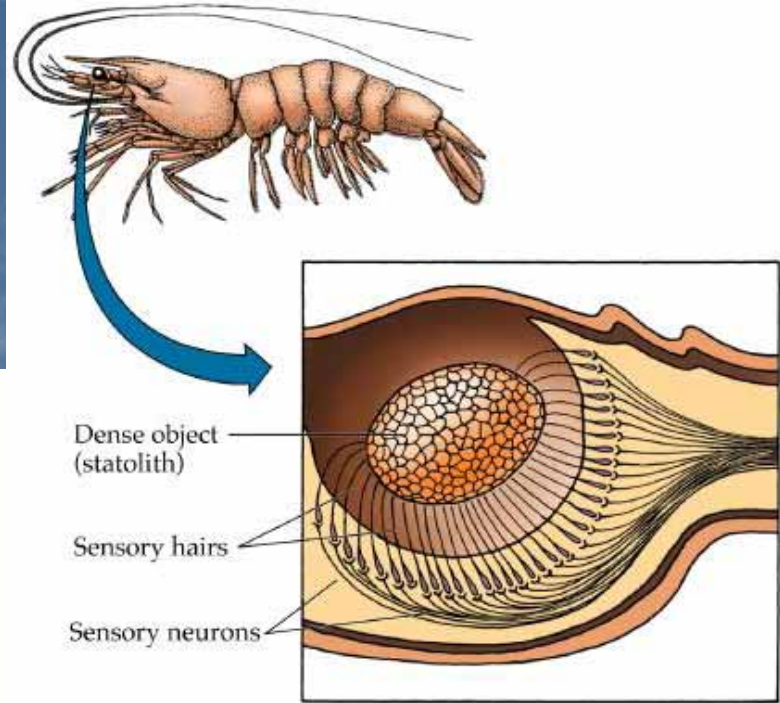


**Figure 2.7**

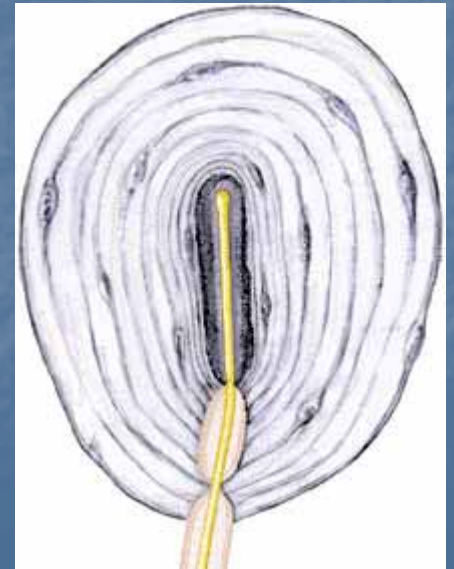
**Renewal of sensory membrane in a vertebrate photoreceptor** Renewal of membrane in the outer segment of rod photoreceptor. Black dots indicate labeled amino acid, first incorporated into protein in the inner segment, then transported to the outer segment as components of the disk (largely as rhodopsin). Synthesis of new disks pushes label upward until, after 10–14 days, it is shed by the outer segment and phagocytosed by the cells of an adjacent cell layer, called the retinal pigment epithelium. (After Young, 1976.)

# Externí specializace

## Ochrana, podpora, účast na recepci

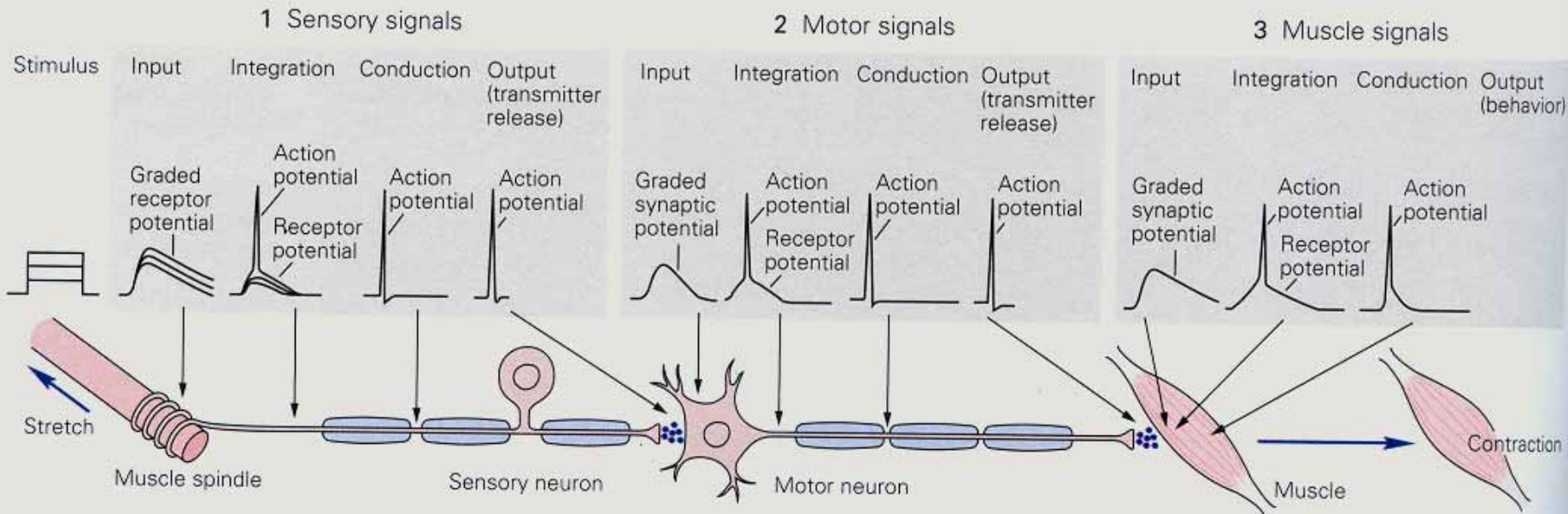
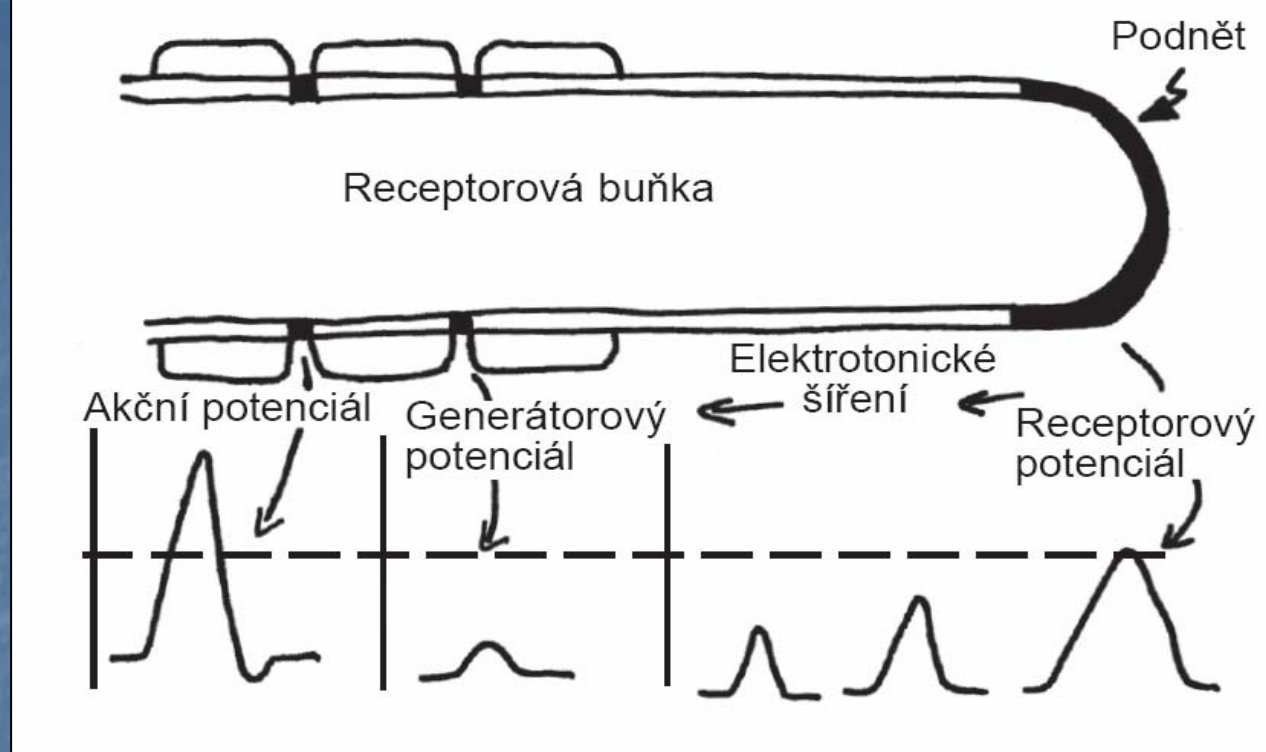


**Figure 2.8**  
**Taste receptors of the housefly**  
 (A) Chemosensory bristles (hairs) on the tarsus of the housefly. Letters indicate different anatomical classes of hairs (type a, type b, etc; see discussion in Chapter 8). (B) Structure of a chemosensory bristle. In addition to two to four chemoreceptors, the bristle also contains a single mechanoreceptor. Trichogen and tormogen cells are accessory cells that secrete the hair and bristle socket.



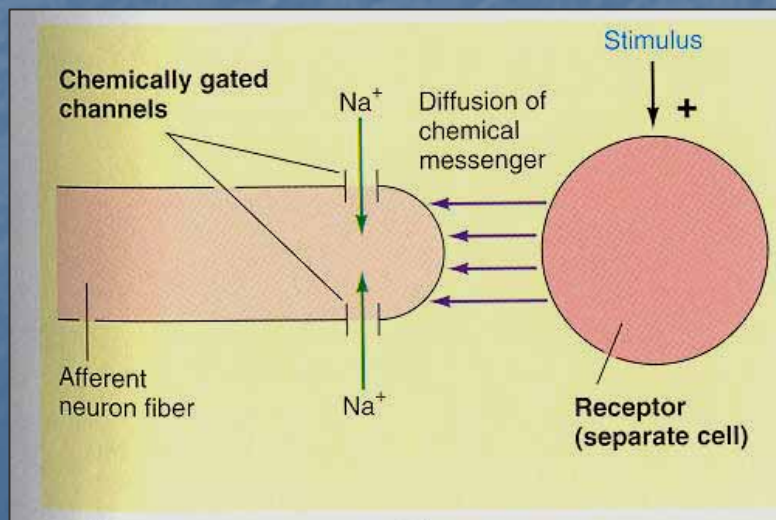


# Kódování signálu

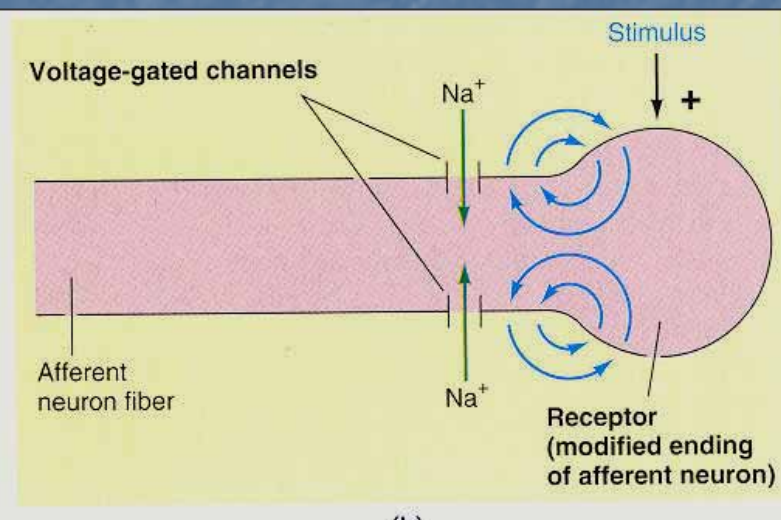


# Kódování signálu

## Sekundární receptor



## Primární receptor



**Table 10.1 Main types of sensory modalities**

Sensory modality	Form of energy	Receptor organ	Receptor cell
Chemical			
common chemical	molecules	various	free nerve endings
arterial oxygen	O <sub>2</sub> tension	carotid body	cells and nerve endings
toxins (vomiting)	molecules	medulla	chemoreceptor cells
osmotic pressure	osmotic pressure	hypothalamus	osmoreceptors
glucose	glucose	hypothalamus	glucoreceptors
pH (cerebrospinal fluid)	ions	medulla	ventricle cells
Taste	ions and molecules	tongue and pharynx	taste bud cells
Smell	molecules	nose	olfactory receptors
Somatosensory			
touch	mechanical	skin	nerve terminals
pressure	mechanical	skin and deep tissue	encapsulated nerve endings
heat and cold	temperature	skin, hypothalamus	nerve terminals and central neurons
pain	various	skin and various organs	nerve terminals
Muscle			
vascular pressure	mechanical	blood vessels	nerve terminals
muscle stretch	mechanical	muscle spindle	nerve terminals
muscle tension	mechanical	tendon organs	nerve terminals
joint position	mechanical	joint capsule and ligaments	nerve terminals
Balance			
linear acceleration (gravity)	mechanical	vestibular organ	hair cells
angular acceleration	mechanical	vestibular organ	hair cells
Hearing	mechanical	inner ear (cochlea)	hair cells
Vision	electromagnetic (photons)	eye (retina)	photoreceptors

# Kódování signálu – překódování intenzity do frekvence AP

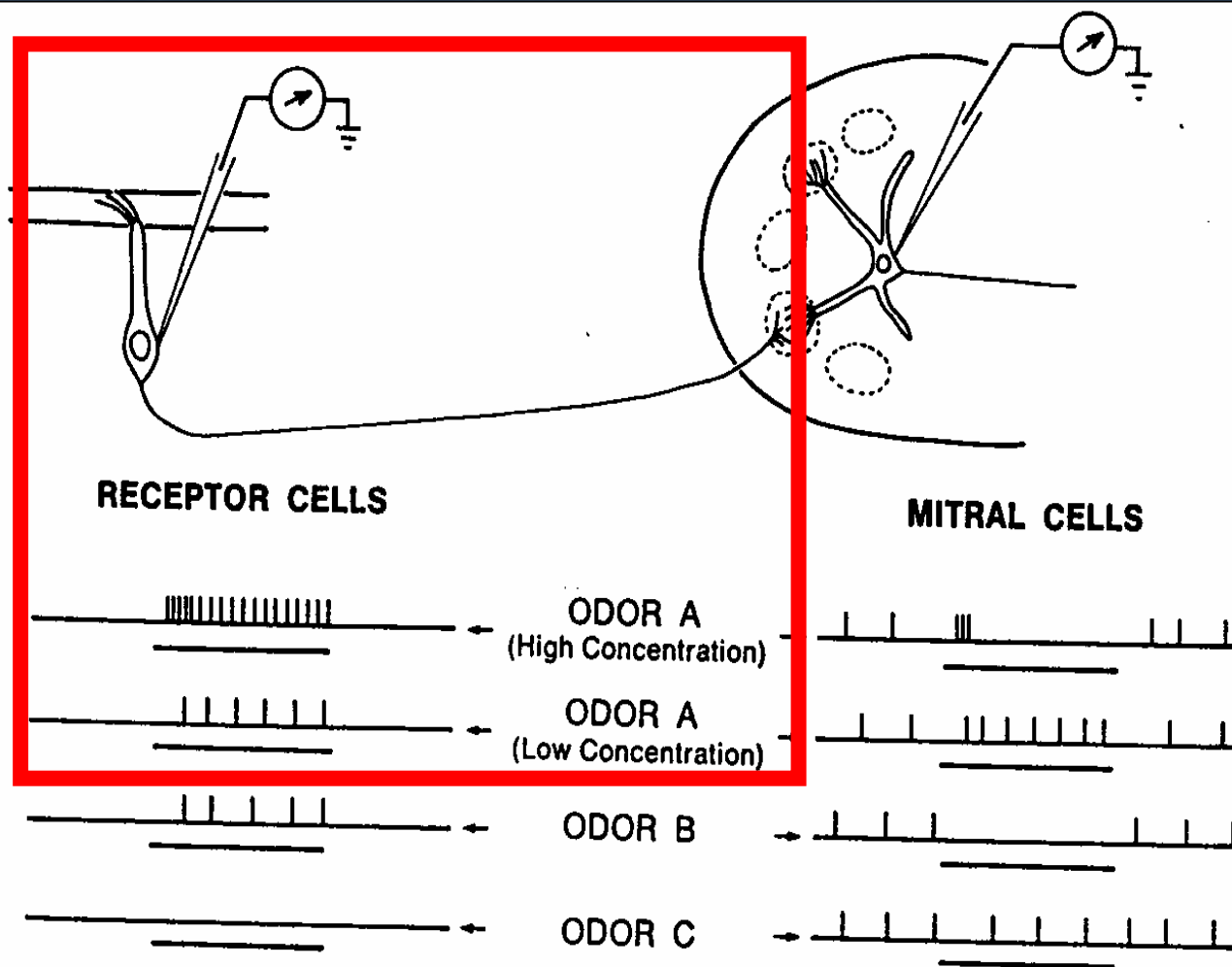
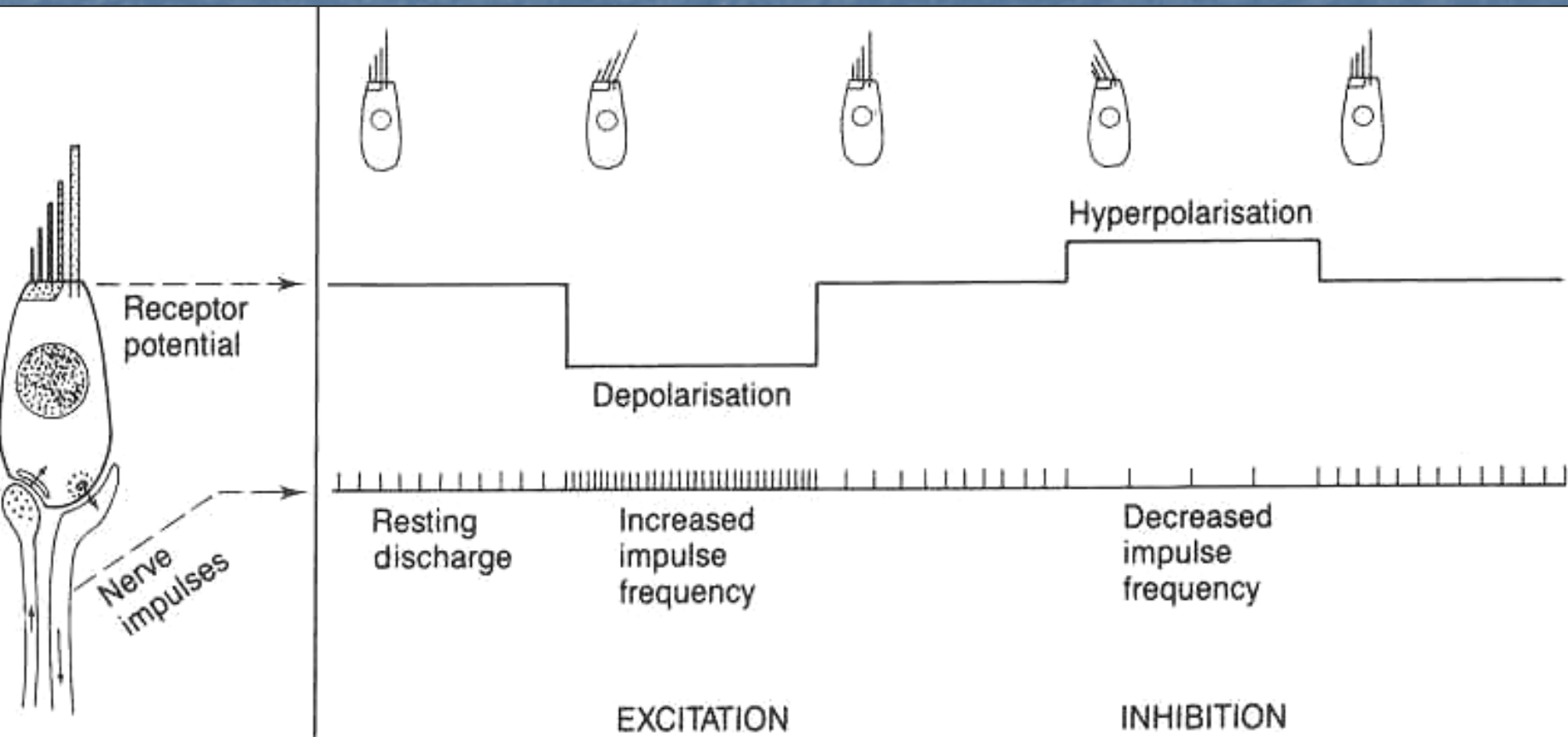


Fig. 11.11 Extracellular single-unit recordings of responses to odors of receptor cells (*left*) and mitral cells (*right*) in the salamander, showing different types of responses and different temporal patterns of activity. (After Kauer, 1974, and Getchell and Shepherd, 1978)

# Spontánní aktivita a centrifugální řízení



**Table 10.3** Common operations in sensory transduction

Transduction operations	Operations in single sensory cells	Operations in cell populations
Detection	Perireceptor mechanisms: filters; carriers: tuning; inactivation Sensitivity Rapidity	Perireceptor mechanisms: filters; carriers; tuning; inactivation Different thresholds
Amplification	Positive feedback Active processes Signal/noise enhancement	Positive feedback Signal/noise enhancement
Encoding/ discrimination	Intensity coding Quality coding Temporal differentiation	Different dynamic ranges Quality independent of intensity Center-surround antagonisms Opponent mechanisms Construction of maps
Adaptation and termination	Desensitization Negative feedback Temporal discrimination Repetitive responses	Temporal discrimination
Sensory channel gating	Open or close conductance gating	
Electrical response	Depolarization or hyperpolarization	
Transmission to brain	Electrotonic spread Active properties Synaptic output or impulse discharges	Spatial patterns: maps and image formation Temporal patterns: directional selectivity, etc.

Jednoduchá receptorová buňka (primární receptor)  
 Inervovaná receptorová buňka (sekundární receptor)  
 Místa vzniku akčního potenciálu a speciální konstrukce synapsí (ribbon u sluchu)

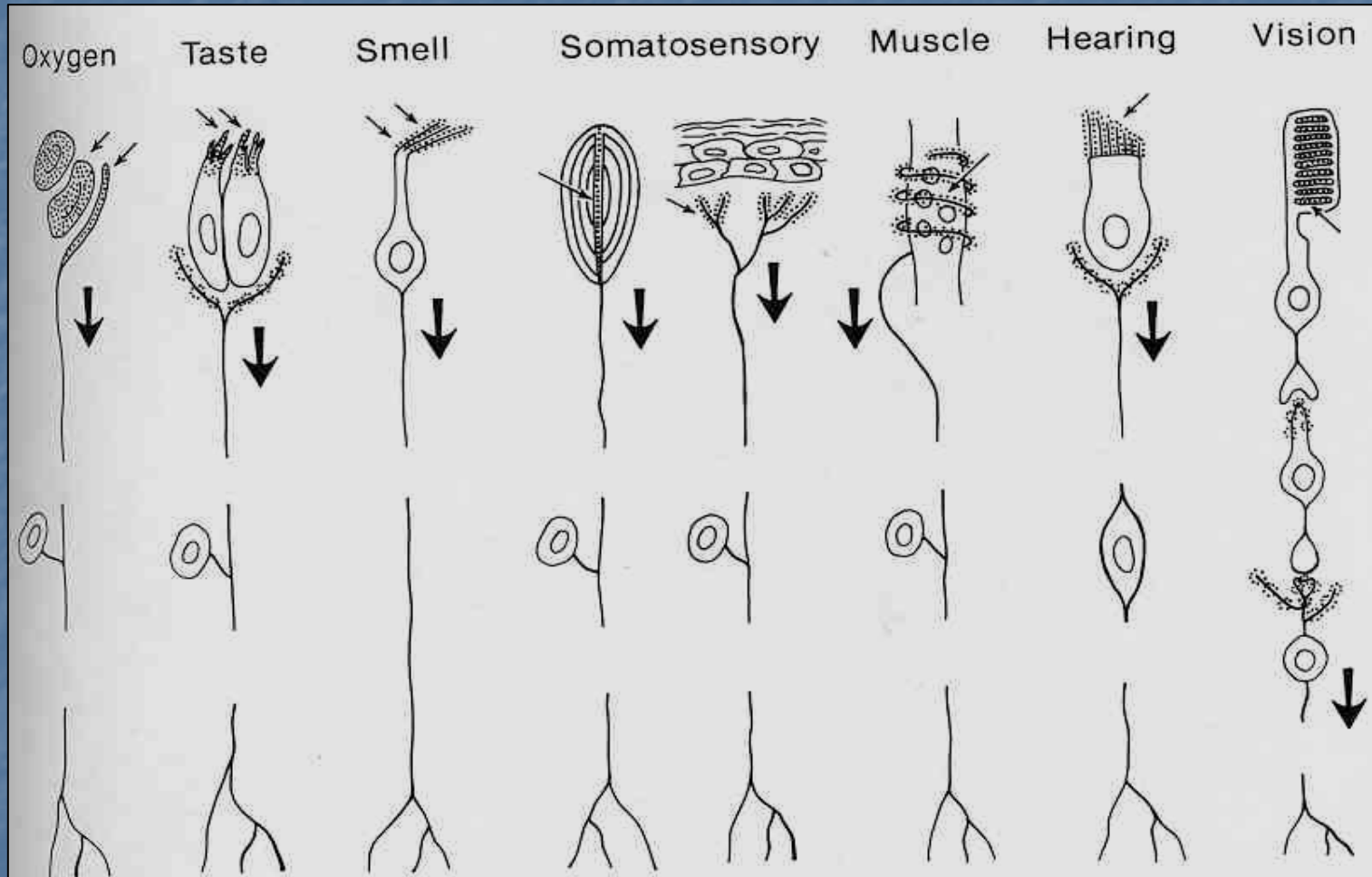
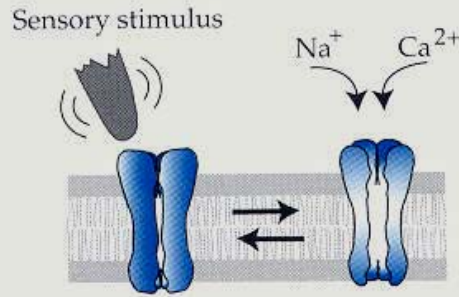


Fig. 10.1 Different types of sensory receptor cells in vertebrates. Small arrows indicate sites where sensory stimuli act. Stippling indicates sites for transduction of the sensory stimuli, and also for synaptic transmission; both of these sites mediate graded signal transmission. Heavy arrows indicate sites of impulse initiation. (Adapted from Bodian, 1967)

(A)

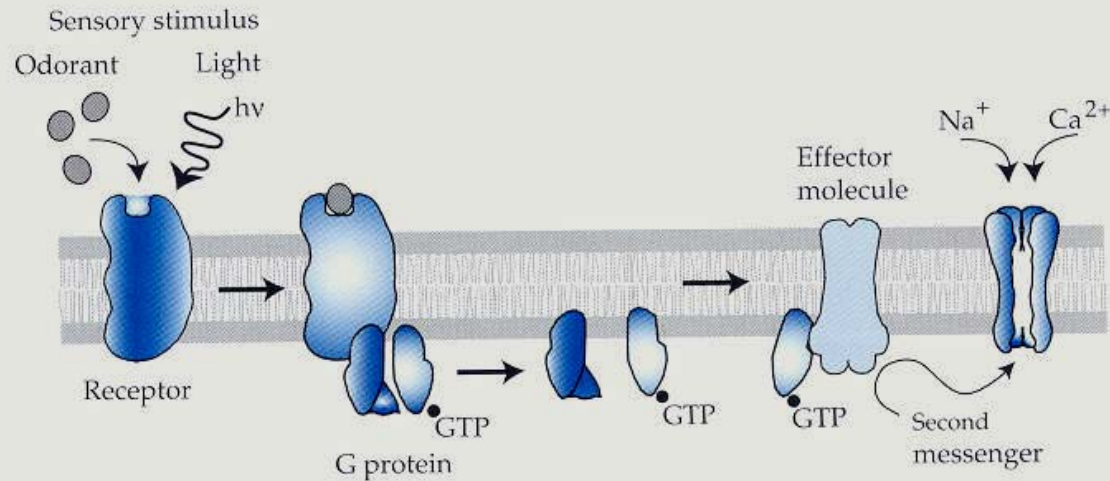


**Figure 2.1**

**Mechanisms of sensory transduction**

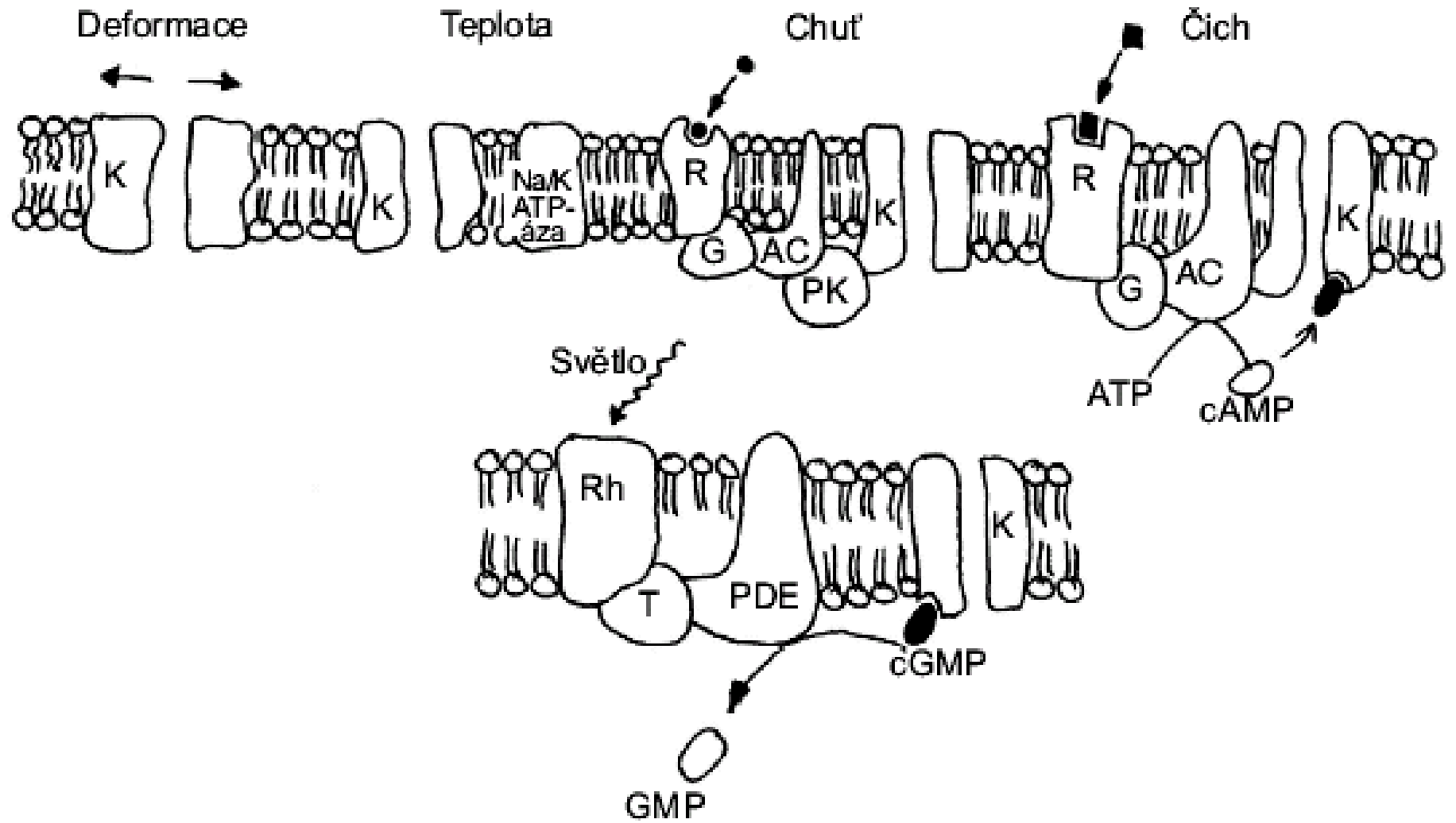
(A) Ionotropic transduction. The stimulus directly gates an ion channel that is part of the receptor molecule. (B) Metabotropic transduction. The receptor is not itself a channel but activates a heterotrimeric G protein that initiates a transduction cascade.

(B)



Ionotropní – přímá stimulace kanálu  
Metabotropní – stejně jako hormony,  
transmitery...  
Receptor ne vždy nutný – slano, MGP





**Table 10.2** Steps in sensory transduction

Transduction step	Vision	Olfaction	Taste		
			Sweet/bitter amino acids	Salt/sour	Mechanoreception (hair cells)
Energy	Photons	Molecules	Molecules	Na <sup>+</sup> , H <sup>+</sup>	Displacement
Membrane receptor	7TD family: rhodopsin	7TD family: olfactory	7TD family: gustatory		
G protein	Transducin	G <sub>olf</sub>	G <sub>gust</sub>		
G-protein target	Phosphodiesterase	Adenylate cyclase III; phospholipase C	AC; PLC		
Second messenger	cGMP	cAMP; IP <sub>3</sub>	cAMP; IP <sub>3</sub>		
Protein kinase			Protein kinase A?		
Membrane channel	Cationic; inward	Cationic; inward Anionic; inward	K <sup>+</sup>	Na <sup>+</sup> ; K <sup>+</sup>	Cationic; inward
Sensory response	Close channel	Open channel	Close channel	Open; close	Open channel
Adaptation mechanism	Ca <sup>2+</sup> ; phosphorylation?; arrestin	Ca <sup>2+</sup> ; protein kinases ?	?	?	Myosin/actin motor; Ca <sup>2+</sup> ?
Cell body output	Synapses	Impulses	Synapses	Synapses	Synapses

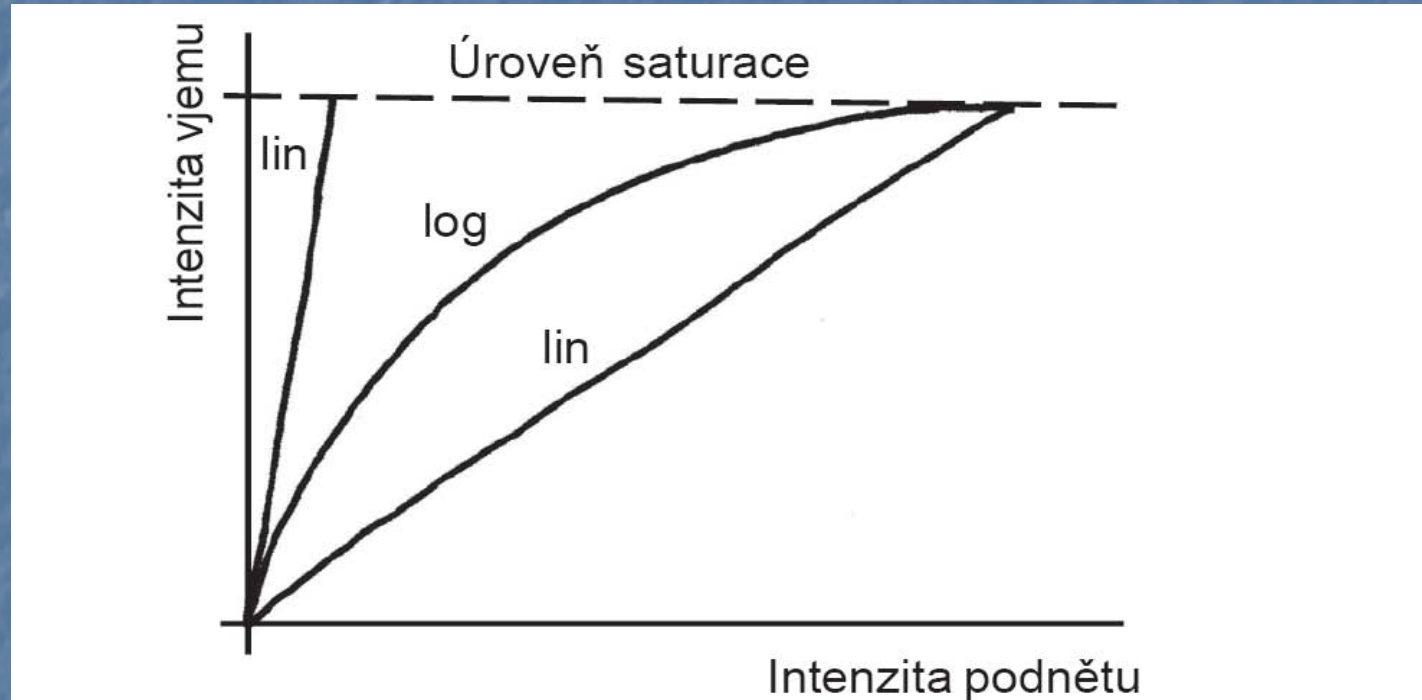
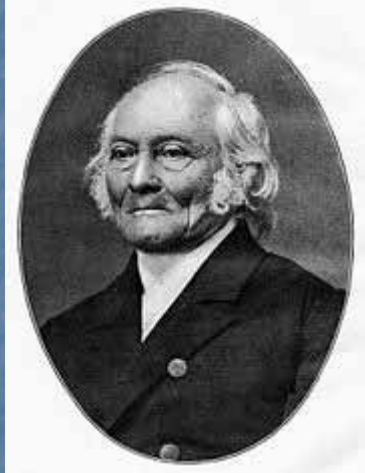
7TD family: 7 transmembrane domain receptor family.

From Shepherd (1991b)

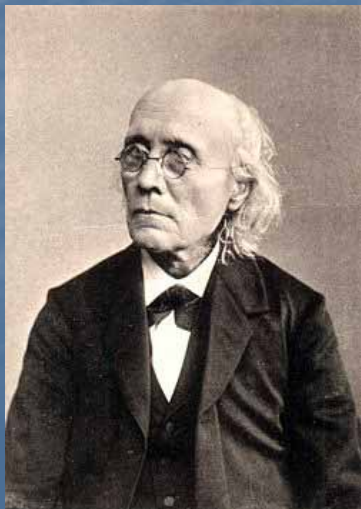
# Weber-Fechnerův psychofyzický zákon

$$S = a \log I/I_0 + b$$

Weber gradually increased the weight that a blindfolded man was holding and asked him to respond when he first felt the increase



*Obr. 4.15.* Intenzita vjemu roste s intenzitou podnětu logaritmicky – ne lineárně. Tento kompromis mezi rozlišovací schopností a saturačním prahem (nasyčením) receptorů umožňuje zachovat odstupňovanou reakci na velmi široký rozsah intenzit současně s velkou citlivostí pro slabé podněty.

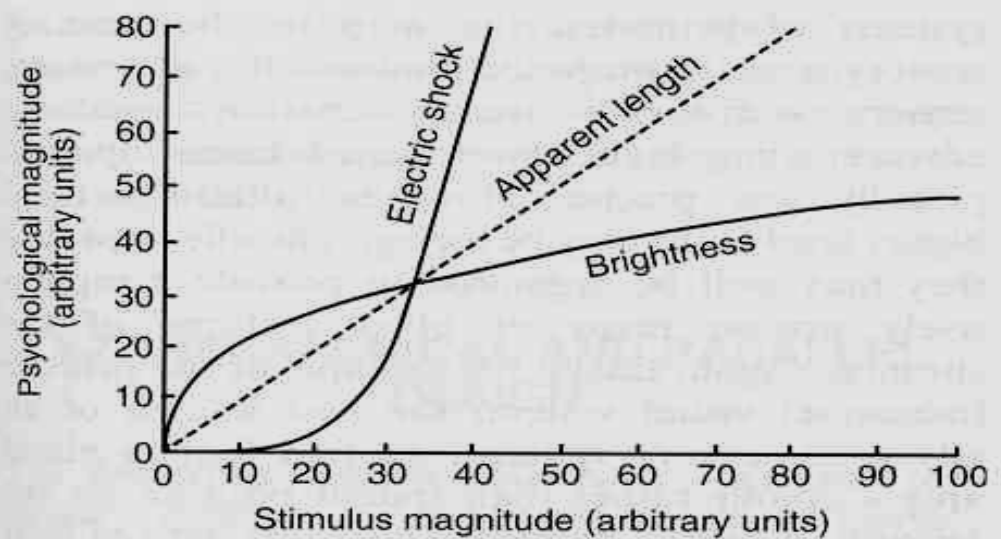
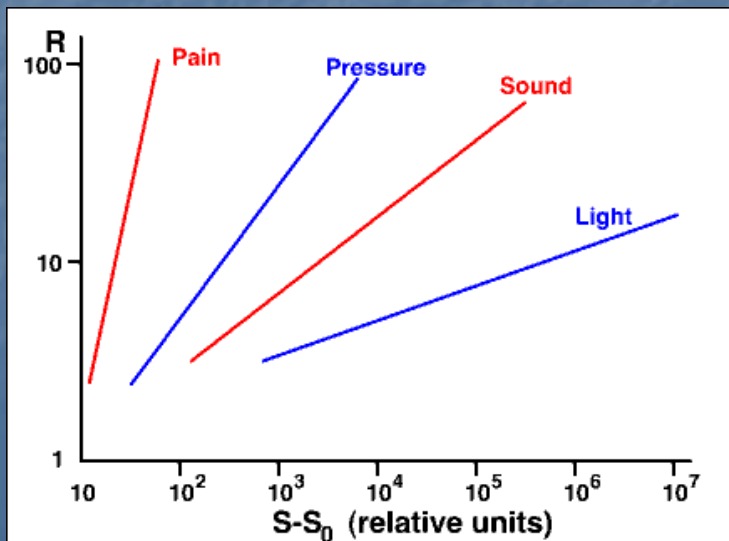


Neplatí ale pro všechny modality.

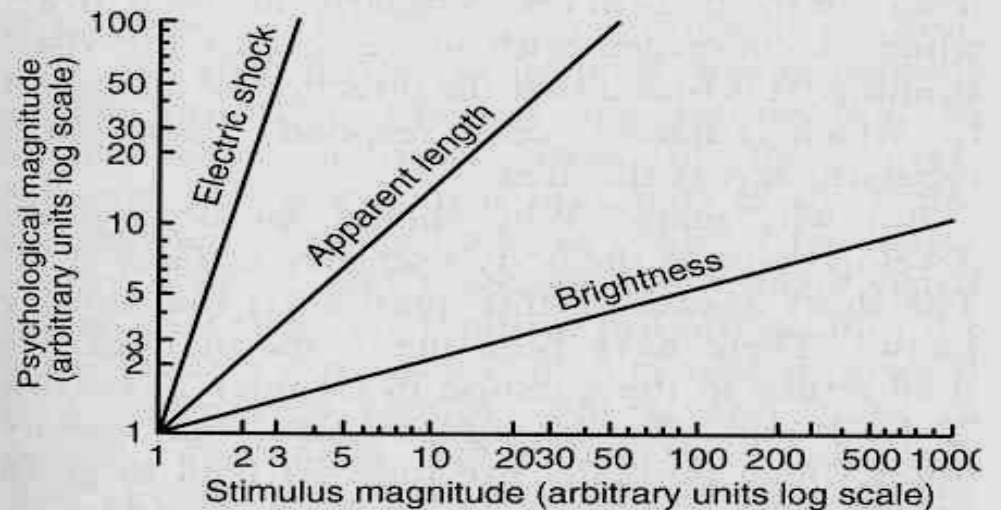
"is this sound twice as strong as that sound?" Stevens found that such results from different sensory modalities varied too much in "steepness" to be fitted by the Webner-Fechner law. Instead he introduced a formula with one more parameter, and therefore more flexible:

$$R = k (S - S_0)^{\alpha}$$

Exponent závisí na typu stimulu

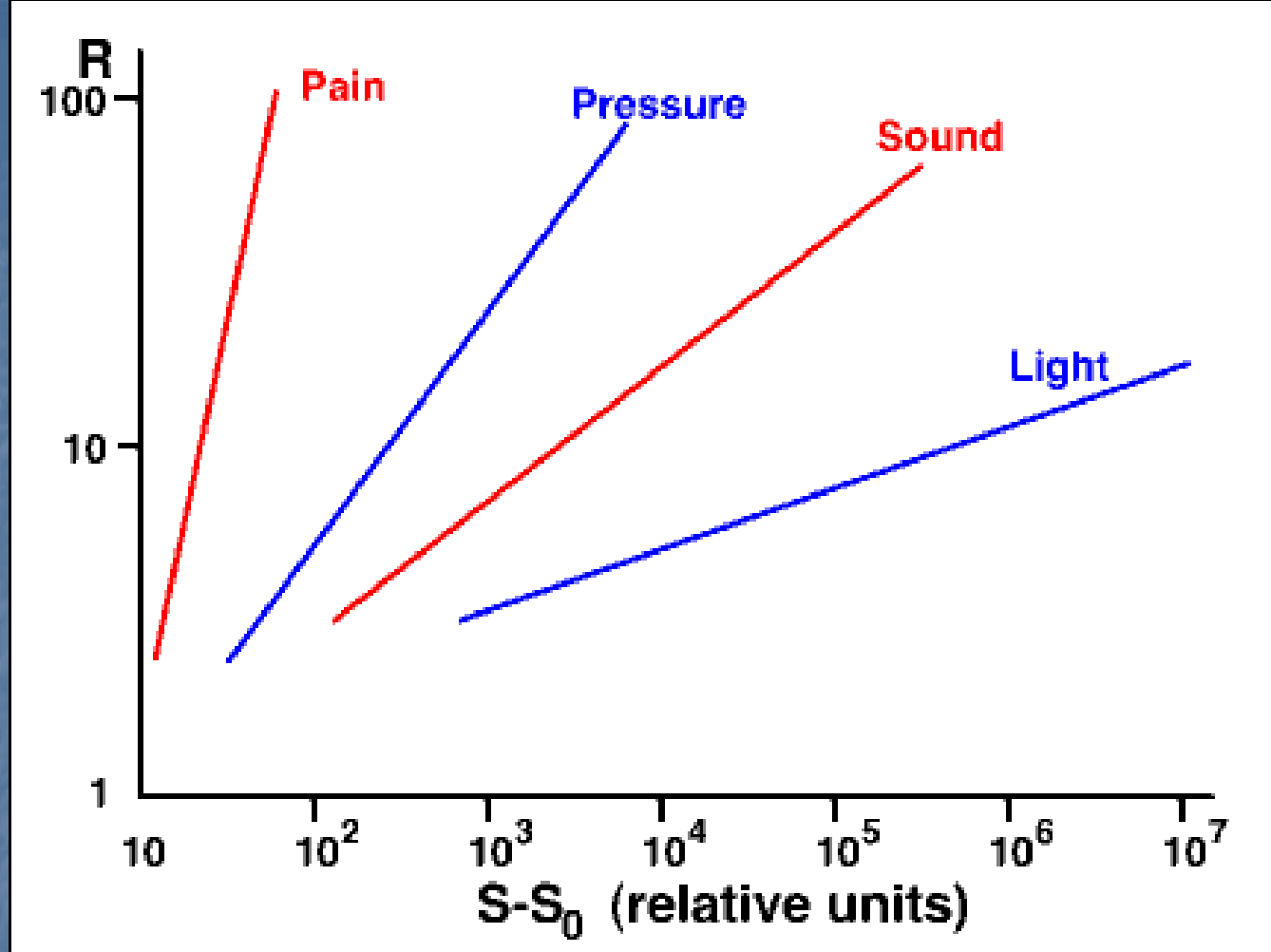


A



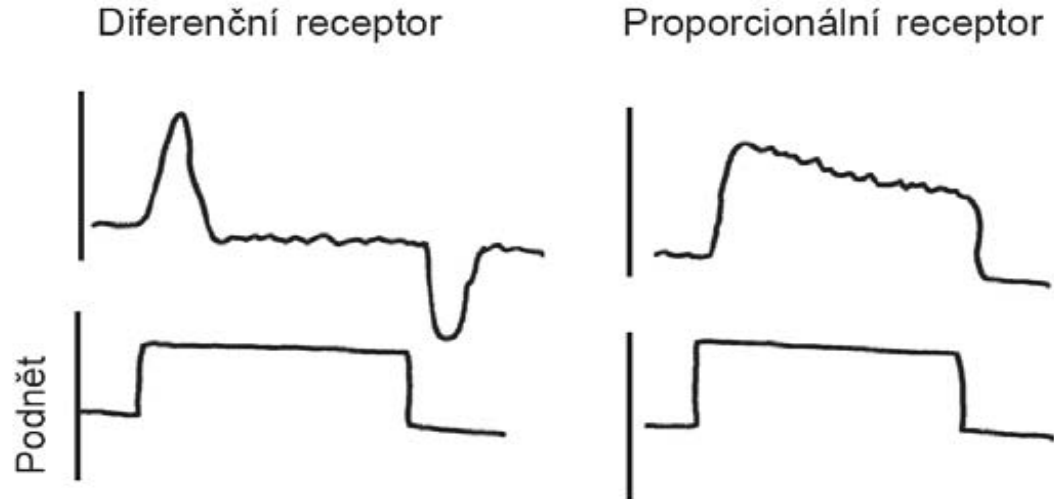
B

**Figure 3.2** Psychophysical correlations. (a) When subjective magnitude is graphed against stimulus magnitude on linear coordinates the lines are frequently curved upwards or downwards. (b) When graphed against log-log coordinates straight lines are obtained whose gradients depend on the value of the exponent, 'n'. From Stevens, 1961



Pain has a high value of  $a$ , reflected in a steep curve. In other words, once a stimulus is strong enough to elicit pain, the pain rapidly becomes stronger as the stimulus becomes stronger. The other modalities shown have successively lower  $a$  values, which means that they can cover much wider ranges of stimulus intensity.

# Sensorická adaptace

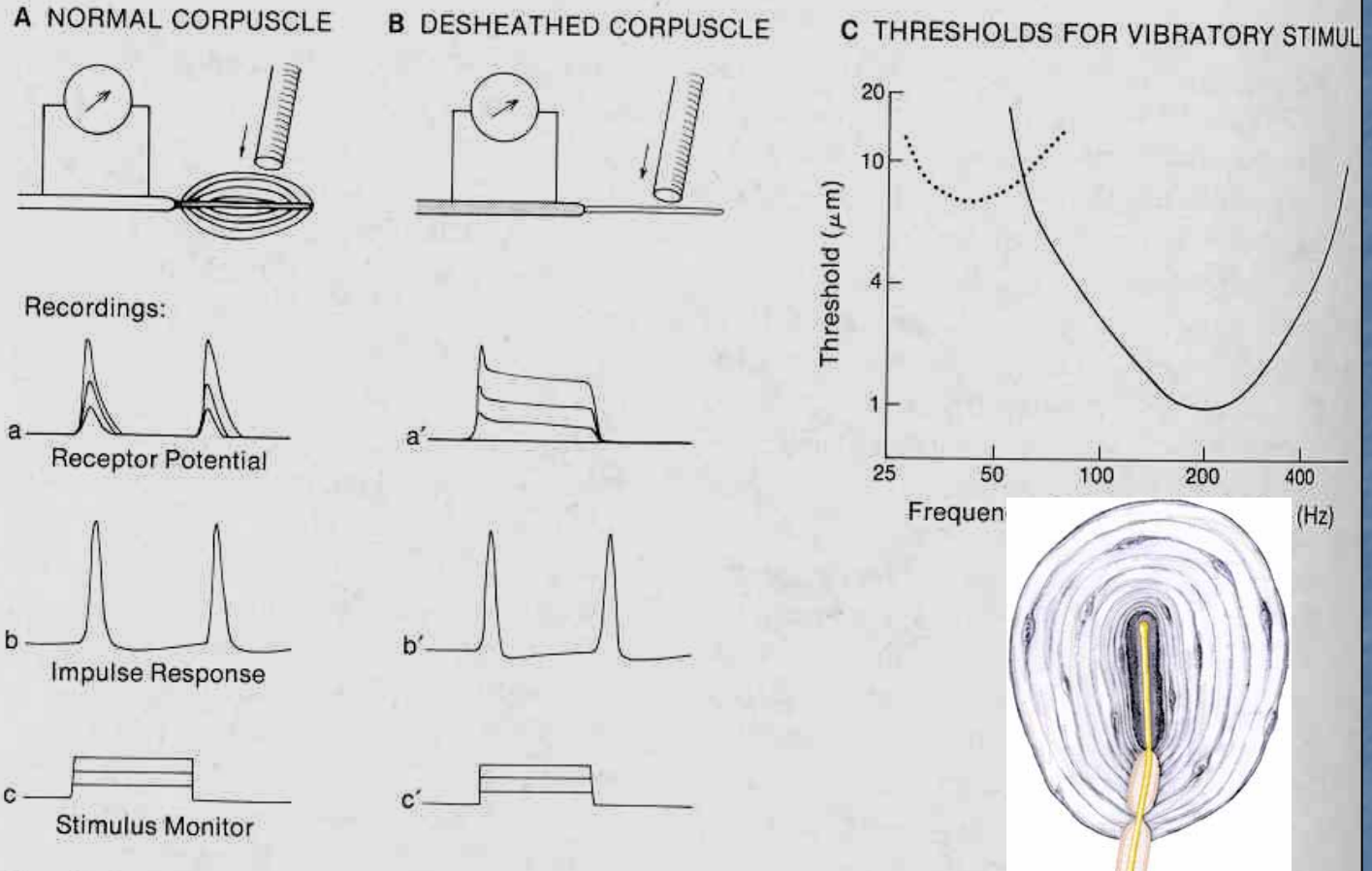


Receptor subtype	Hair follicles	Meissner corpuscle	Pacinian corpuscle	Merkel cell-neurite complex	Ruffini corpuscle	C-fibre LTM	Mechano-nociceptor Polymodal nociceptor
Skin stimulus	Light brush	Dynamic deformation	Vibration	Indentation depth	Stretch	Touch	Injurious forces
Afferent response	RA, LT	RA, LT	RA, LT	SA, LT	SA, LT	SA, LT	SA, HT

# Adaptace: inaktivace kanálů, často pod vlivem Ca, odstředivé tlumení z CNS Vliv přídatných struktur na adaptaci Paciniho tělíska

274

## SENSORY SYSTEMS



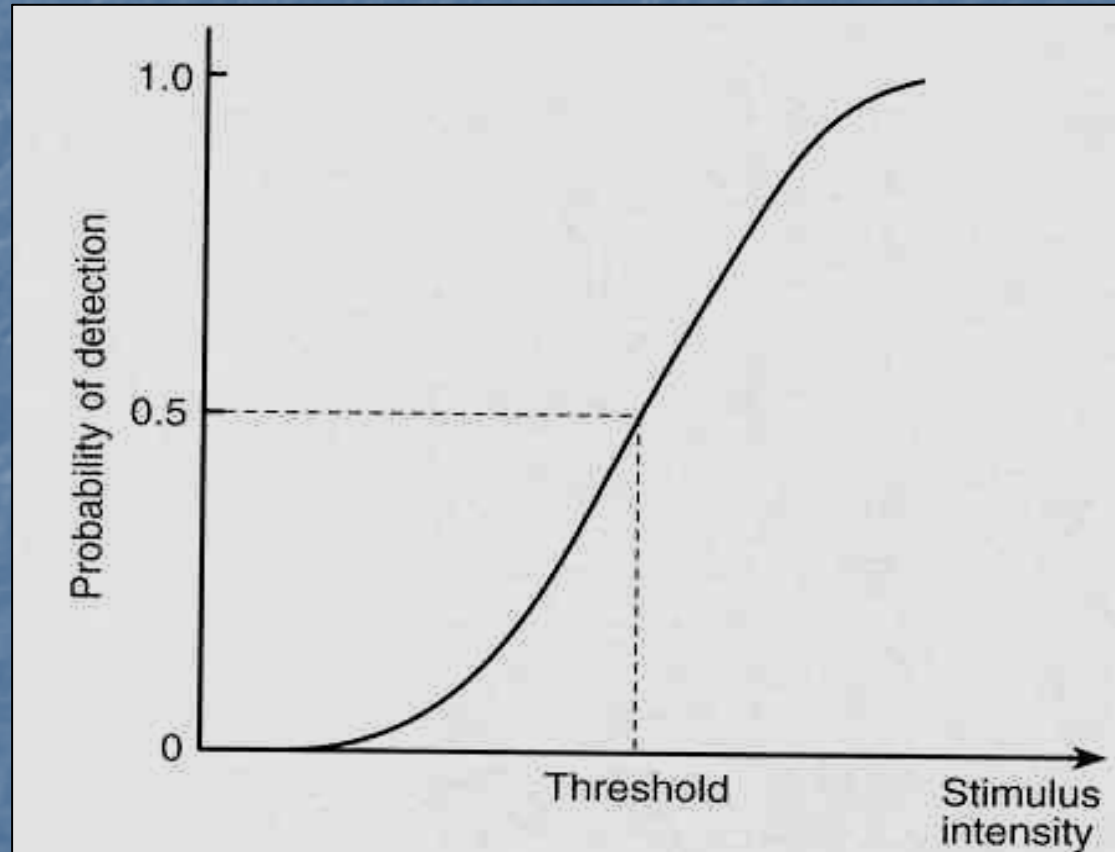
**Fig. 12.5** Experimental analysis of transduction in the Pacinian corpuscle. **A.** Diagram showing probe for stimulating the intact corpuscle, and recording from the nerve. (*Below*) recordings of the receptor potential and impulse discharge. **B.** Repeat of experiment after removal of lamellae. **C.** Sensitivity of Pacinian corpuscle to vibratory stimulation at different frequencies. Sensitivity of Meissner's corpuscle is shown by dotted line. (A, B based on Loewenstein, 1971; C modified from Schmidt, 1978)

Smyslový práh

Zesílení, šum

Časová a prostorová sumace sníží práh, ale zhorší rozlišení.

Psychometrická křivka

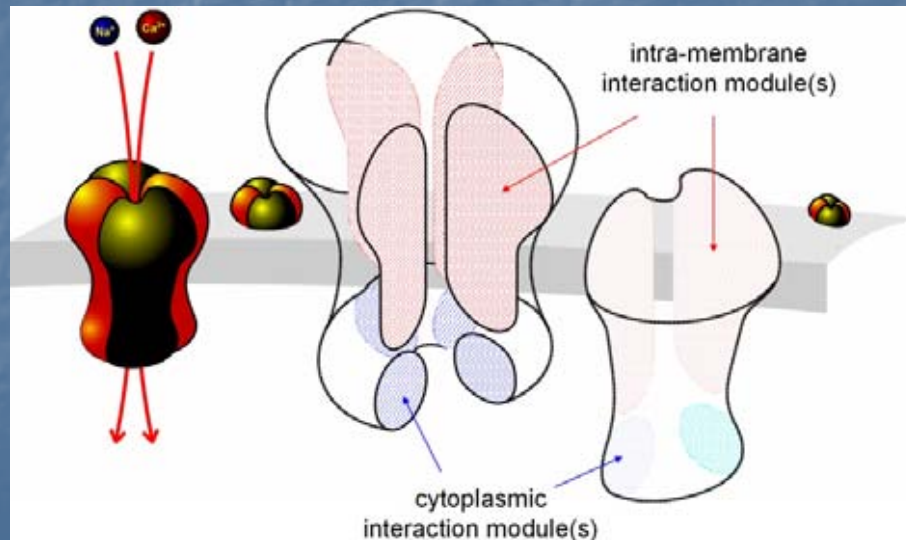


**Figure 3.1** Psychometric curve. The threshold is defined as the intensity when half the responses are correct. The position of the curve on the ordinate is arbitrary. It will shift to the right or left according to circumstances

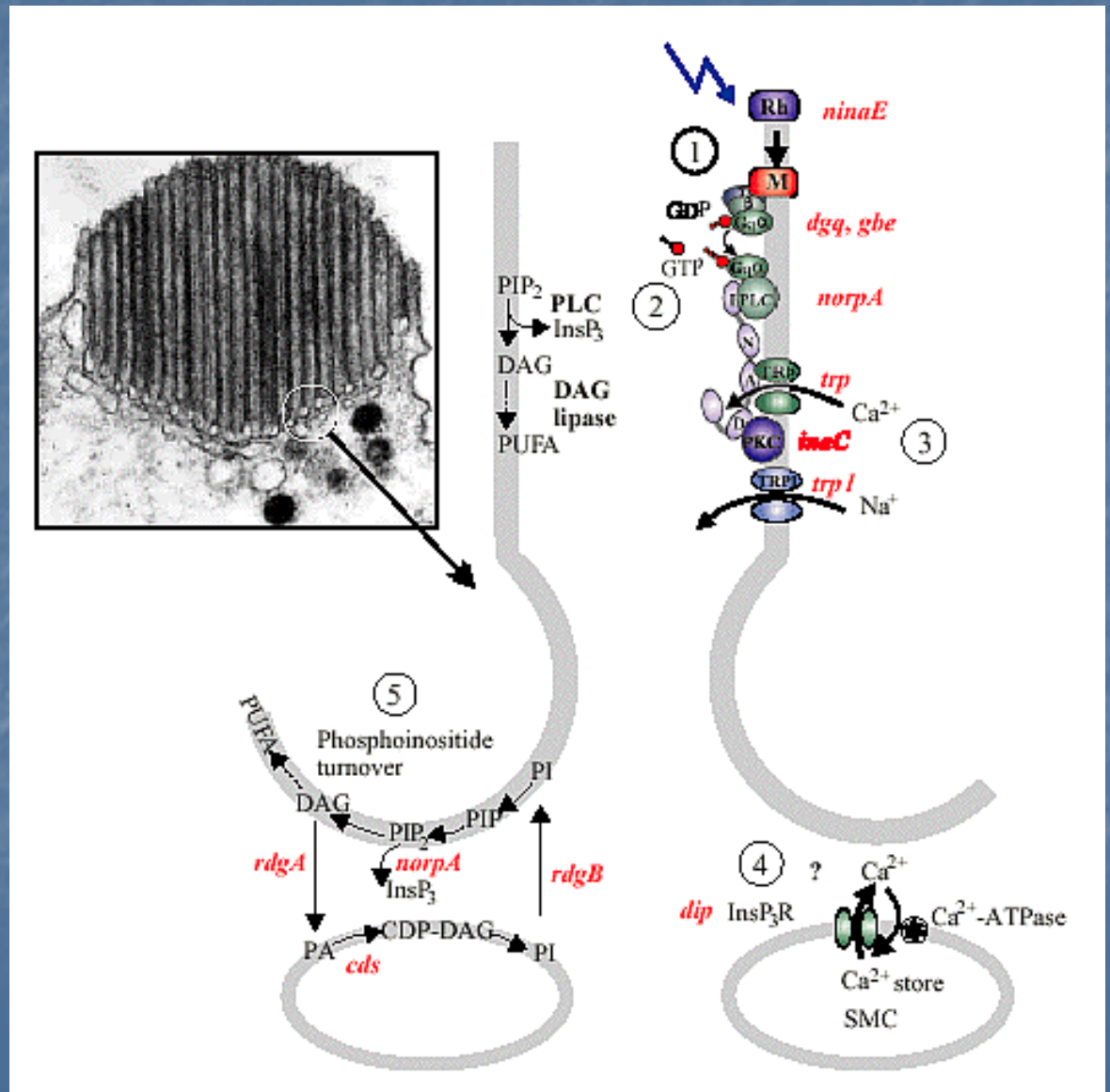


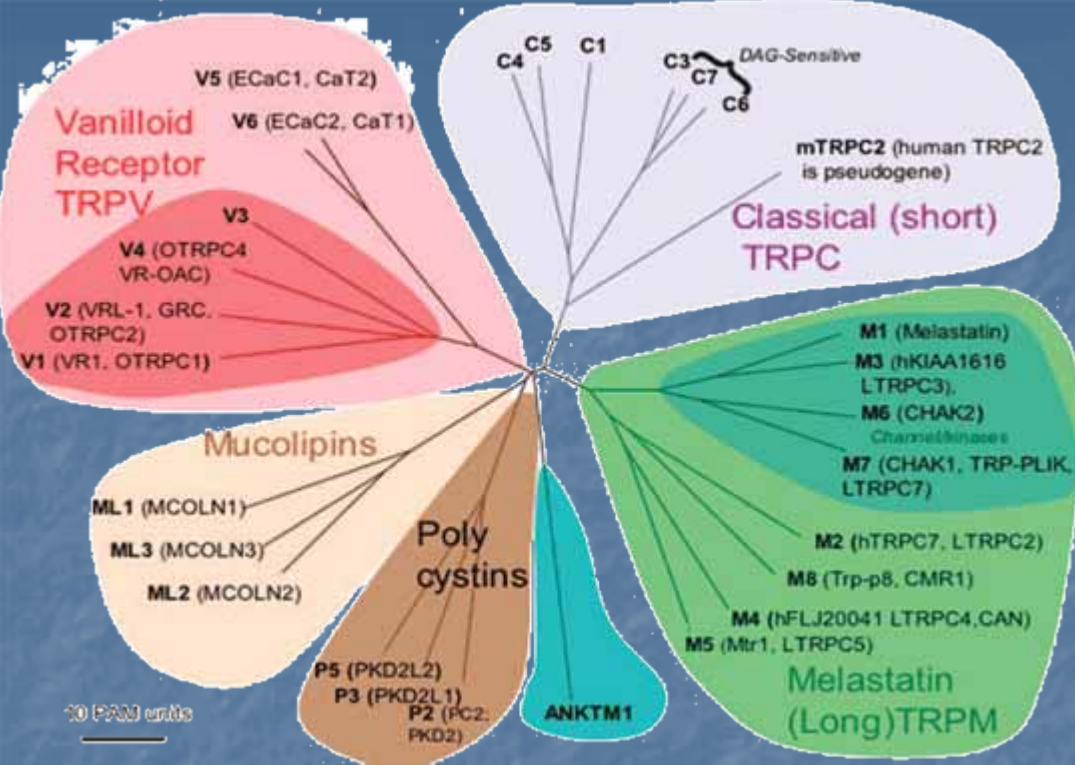
# Cítění přes TRP kanály

## TRP – transient receptor potential



TRP - 1969; Transient Receptor Potential – Přechodný receptorový potenciál, místo trvalé odpovědi na trvalé světlo

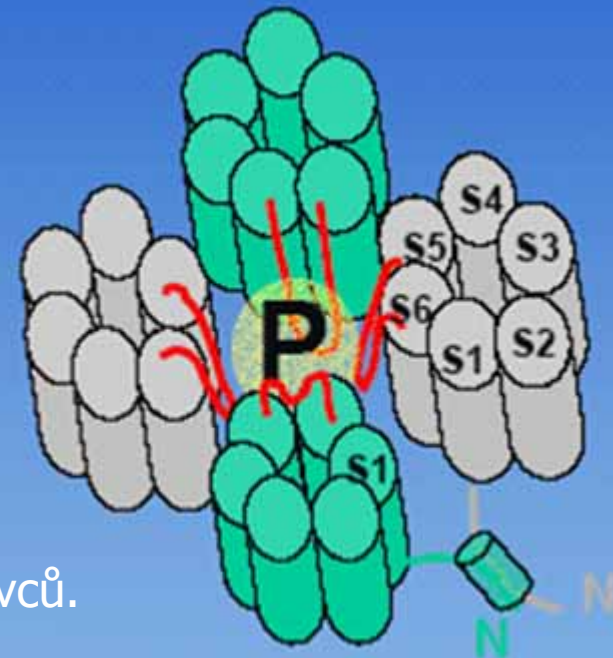
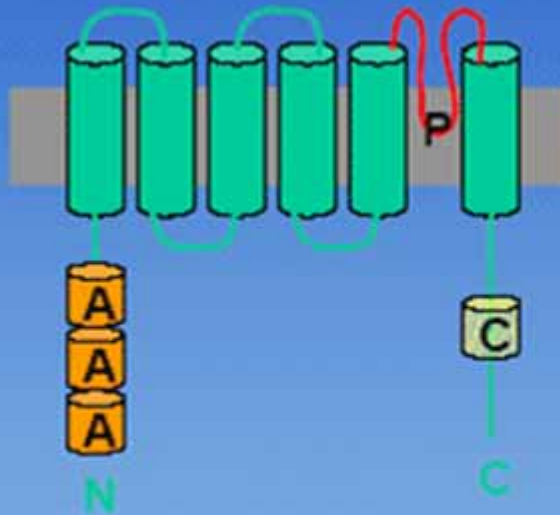




TRP kanály kromě fotorecepce *Dros.* řídí mechanorepceci hád'átka, octomilky, myši, člověka. Byly popsány v receptorech bolesti a teploty.

U myši TRP zprostředkují vnímání některých chutí.

UNIVERZÁLNÍ role ve smyslové transdukci



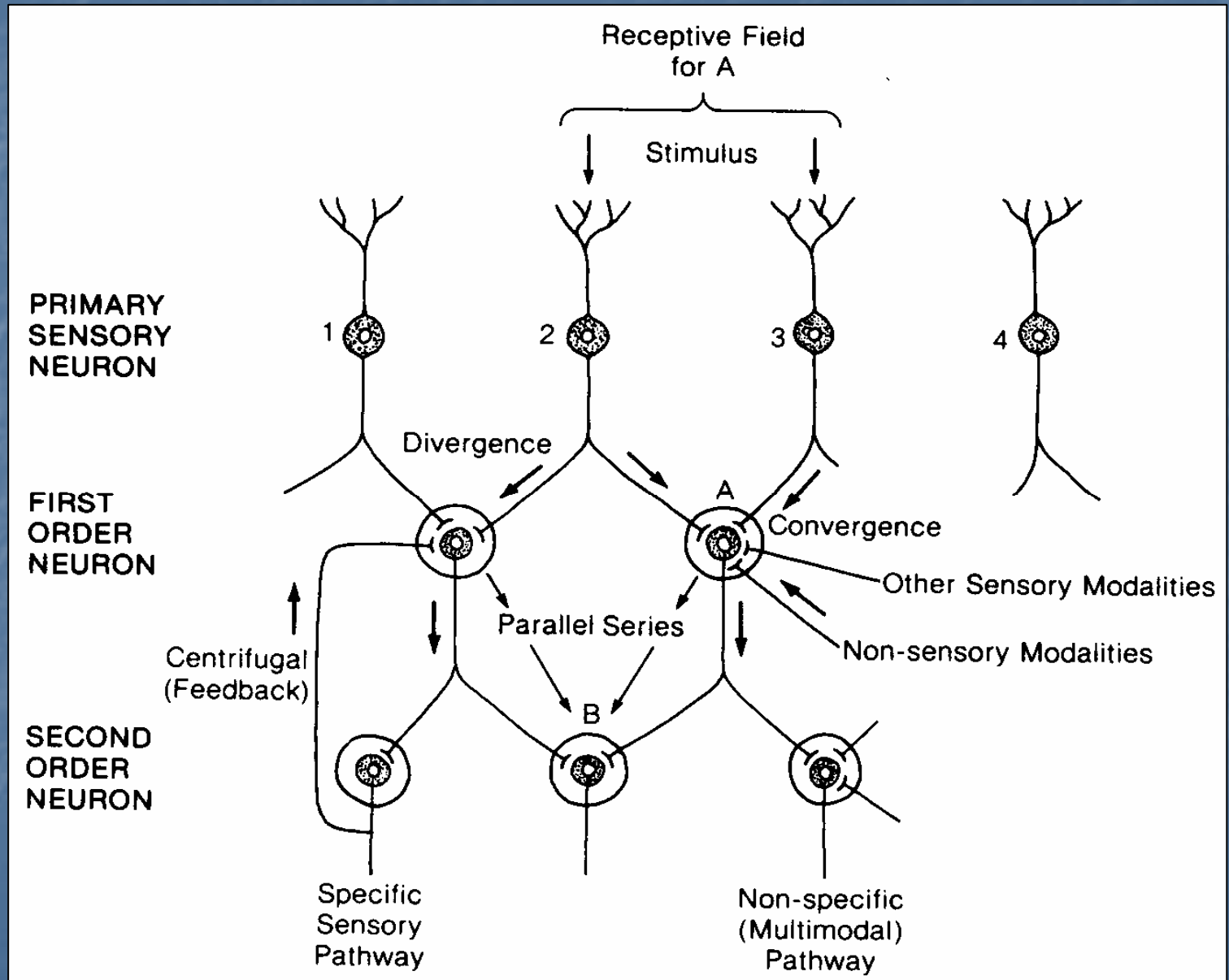
Více než 50 TRP kanálů u kvasinek, hlístů, hmyzu, ryb a savců.

## 3 úrovně organizace sensorických systémů

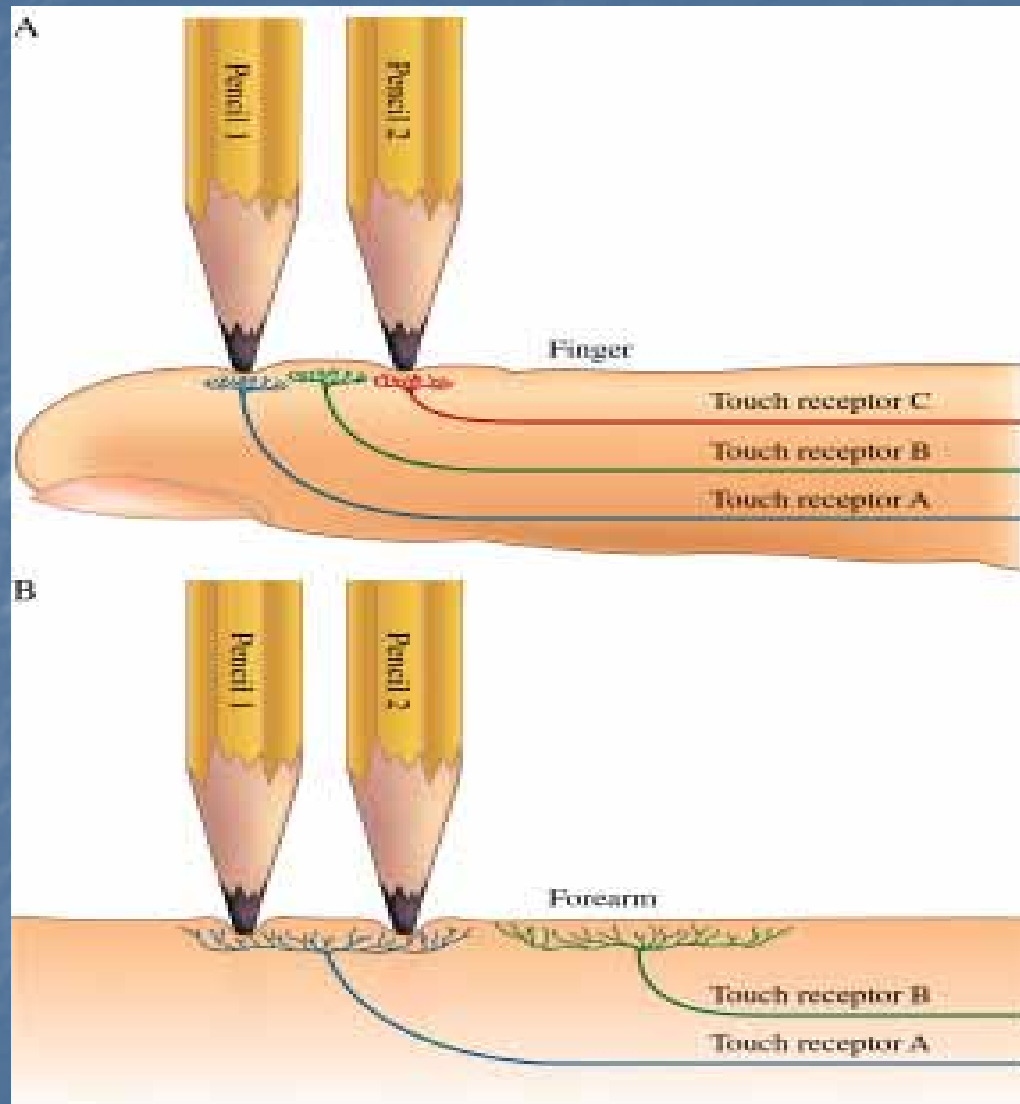
- A) Receptory
- B) Sensorické obvody a dráhy**
- C) Sensorická percepce

Ještě před vznikem digitálního zápisu se informace na periférii zpracovává.

# Konvergence, receptivní pole, zpětná vazba, syntéza, centrifugální vedení



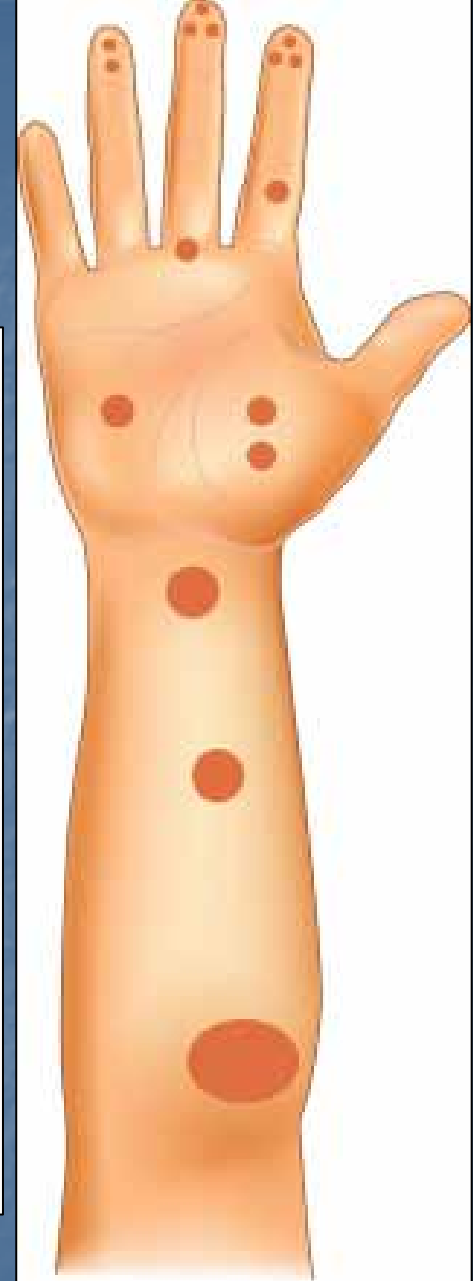
# Receptivní pole – různé velikosti



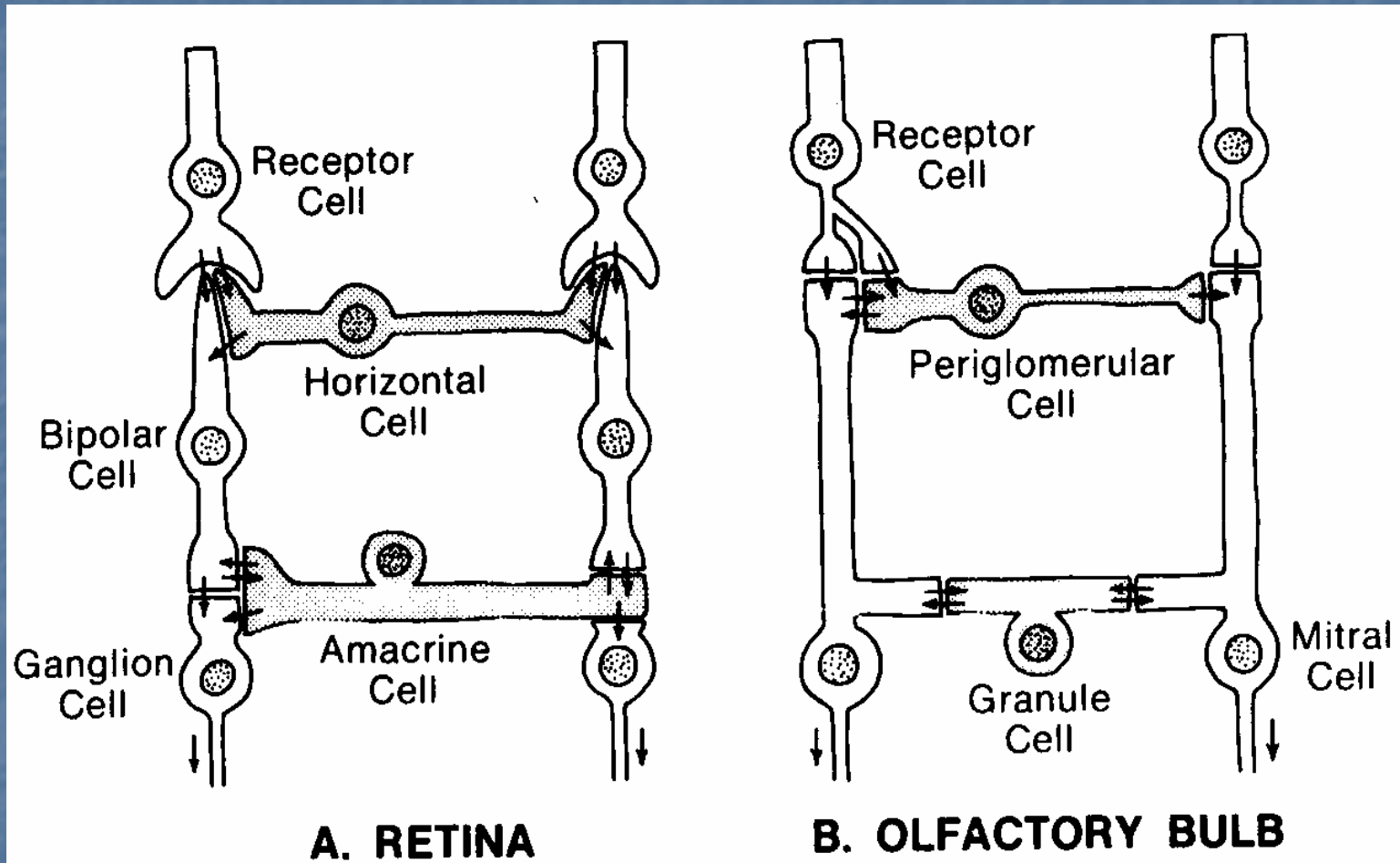
# Receptivní pole – různé velikosti

## Velikost se může dynamicky měnit-sítnice

	a	b	c	d	e	f	g
<b>Receptor subtype</b>	Hair follicles	Meissner corpuscle	Pacinian corpuscle	Merkel cell-neurite complex	Ruffini corpuscle	C-fibre LTM	Mechano-nociceptor Polymodal nociceptor
<b>Skin stimulus</b>	Light brush	Dynamic deformation	Vibration	Indentation depth	Stretch	Touch	Injurious forces
<b>Afferent response</b>	RA, LT	RA, LT	RA, LT	SA, LT	SA, LT	SA, LT	SA, HT
<b>Stimulus</b>							
<b>Receptive field</b>							
<b>Perceptual functions</b>	Skin movement	Skin motion; detecting slipping objects	Vibratory cues transmitted by body contact when grasping an object	Fine tactile discrimination; form and texture perception	Skin stretch; direction of object motion, hand shape and finger position	Pleasant contact; social interaction	Skin injury; pain



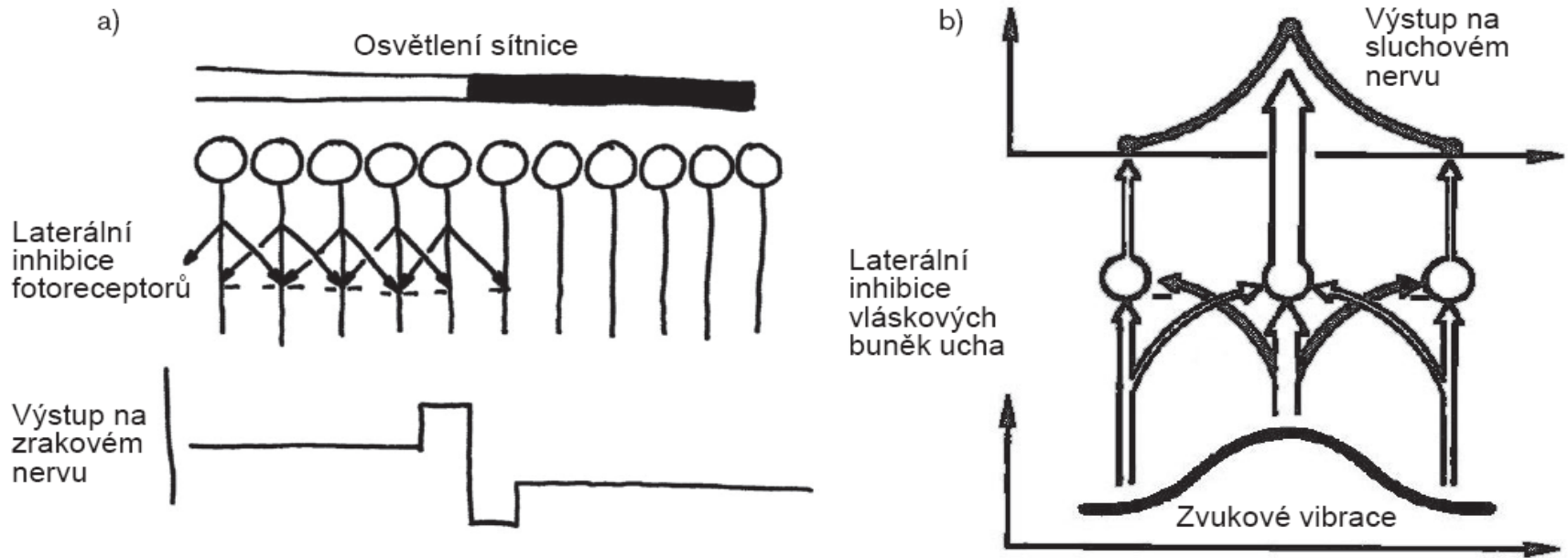
# Shodná architektura sensorických drah – shodné požadavky



Comparison between simplified basic circuit diagrams of the vertebrate retina and olfactory bulb. (After Shepherd, 1978)

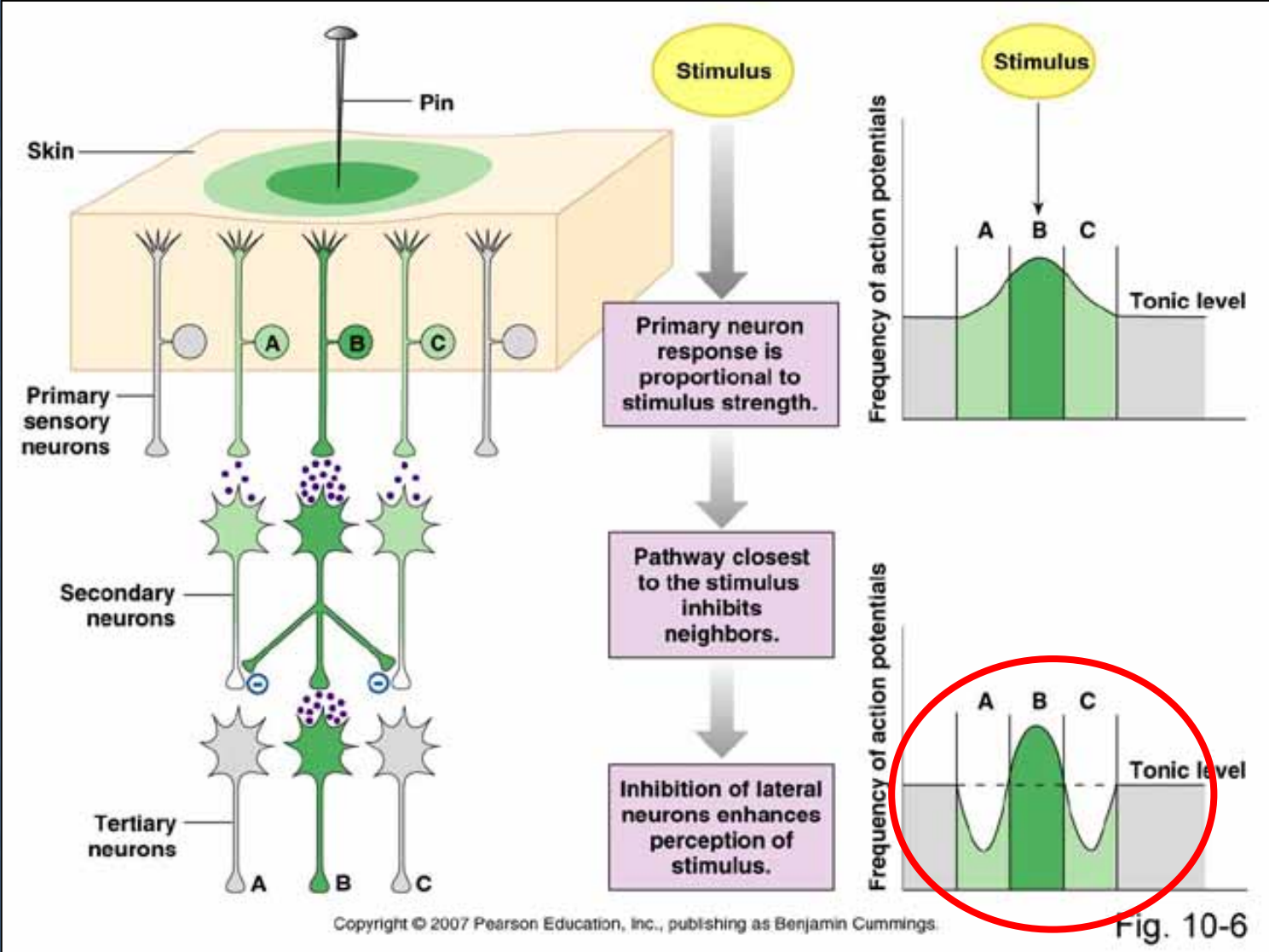


# Laterální inhibice

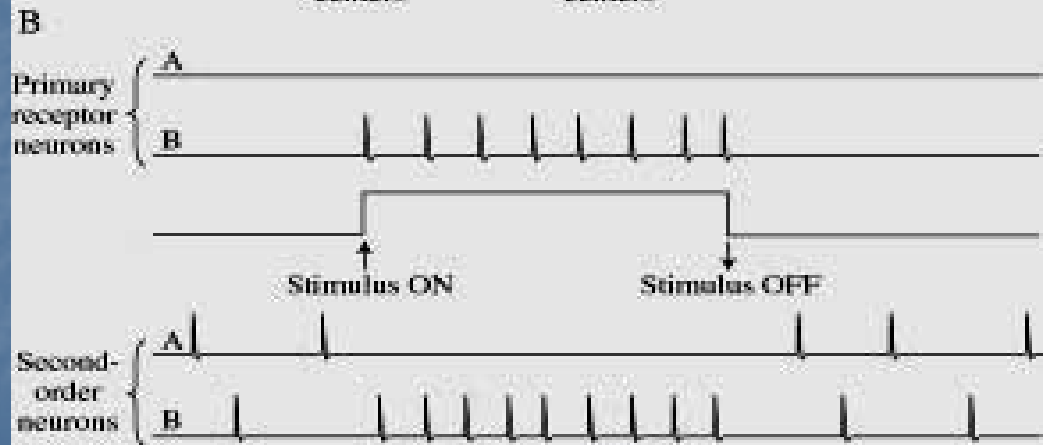
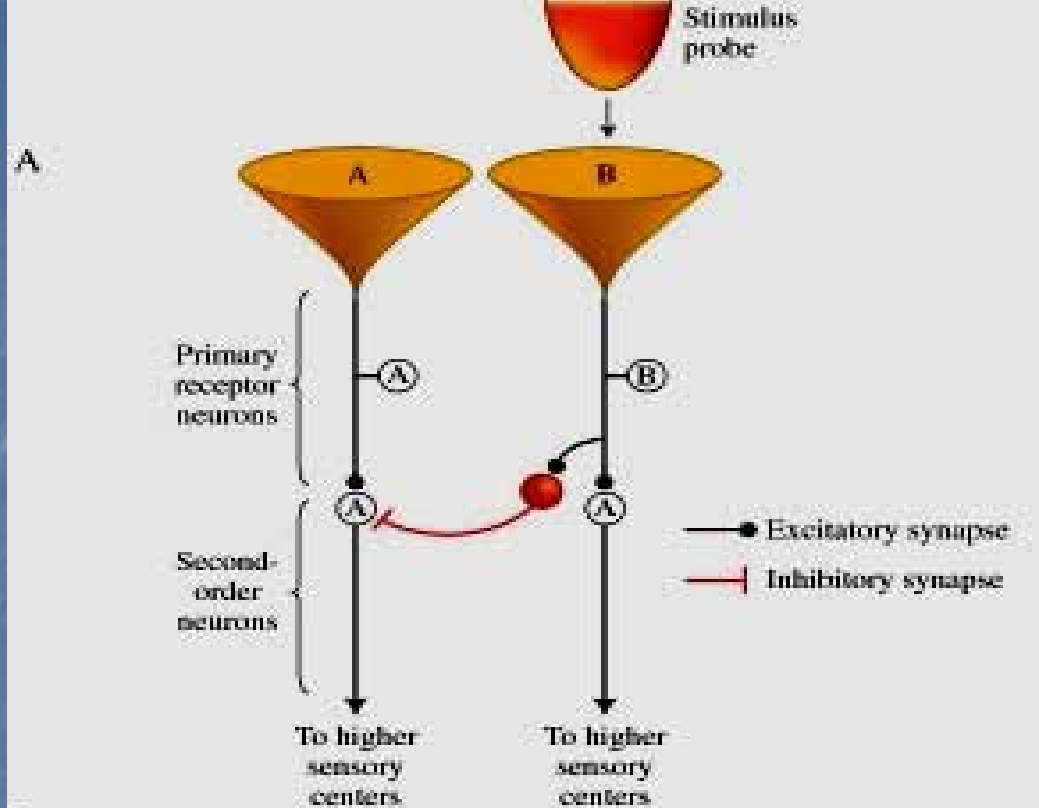


Obr. 4.17. Význam laterální inhibice při zpracování smyslových vstupů. a) Kontrastní přechod mezi osvětlenou a neosvětlenou sítnicí je ještě více zvýrazněn. b) Místo sluchového aparátu (hlemýždě), kde jsou zvukové vibrace maximální, je zvýrazněno proti méně vibrujícímu okolí – kontrast je ještě ostřejší.

# Laterální inhibice



# Laterální inhibice



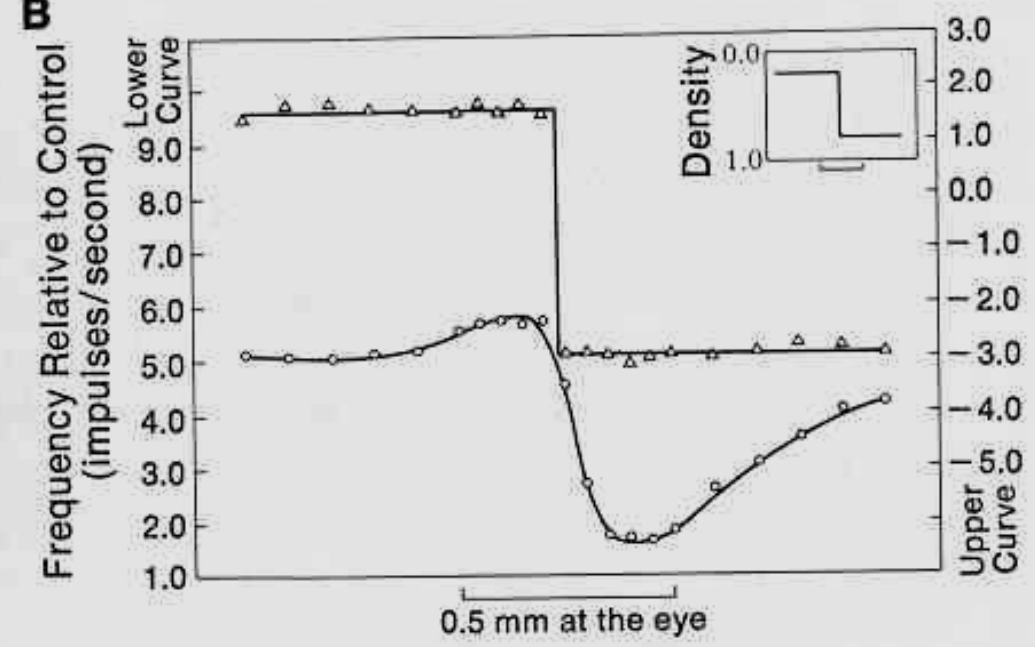
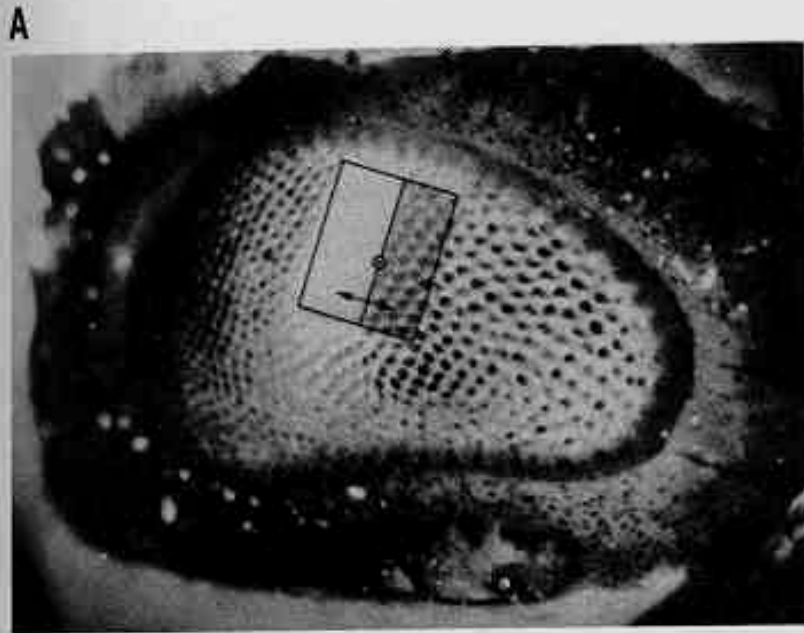


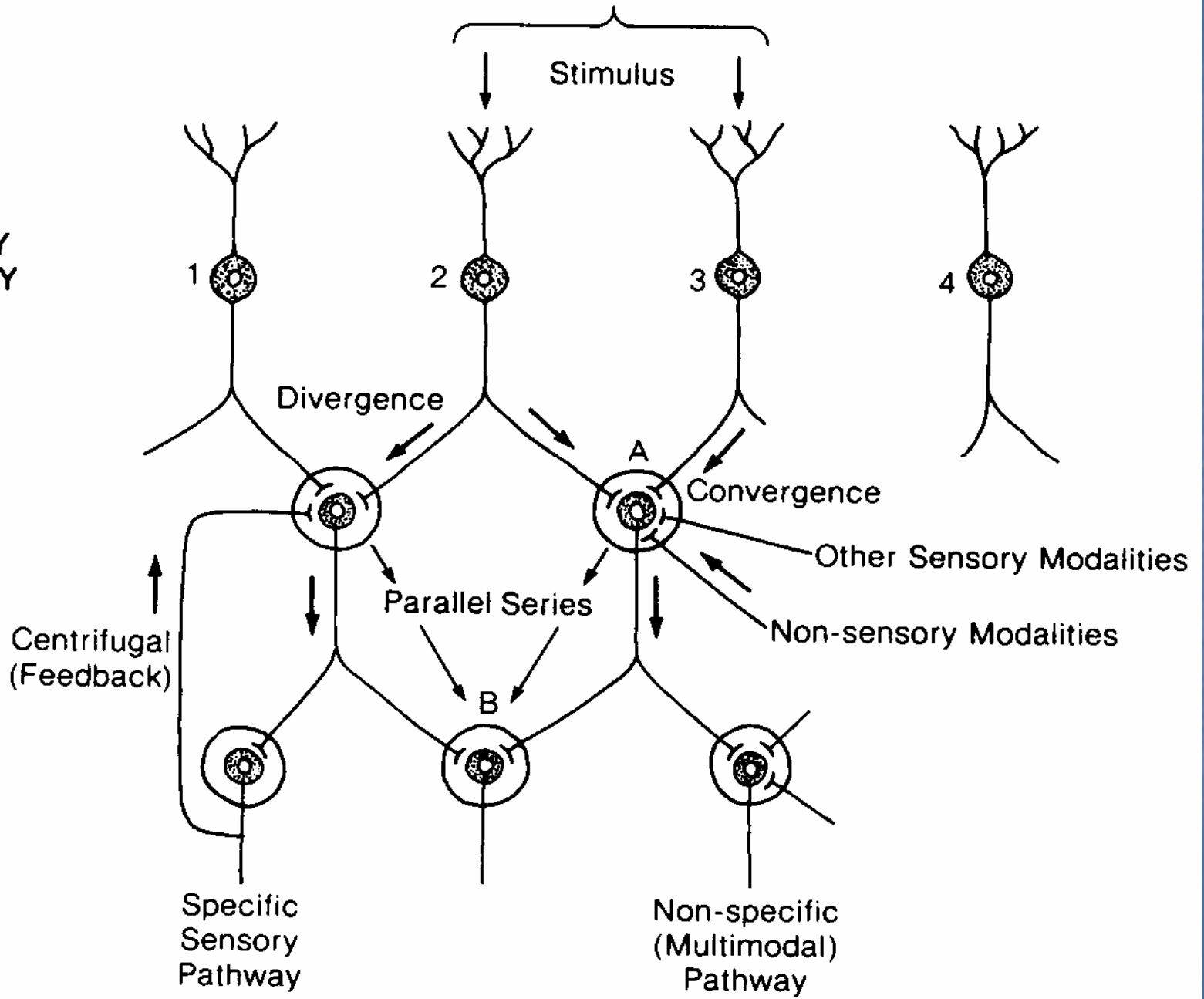
Fig. 10.6 Enhancement of spatial contrast in *Limulus* eye. **A.** Surface of *Limulus* eye, with superimposed rectangular stimulus pattern; pattern is divided into lighter (left) and darker (right) regions. Pattern is centered on test ommatidium ( $\times$ ). Arrows show directions in which the test pattern was displaced, to produce lower curve in graph in B. **B.** Recordings of spike frequency in axon from test ommatidium in A. *Lower curve:* responses to rectangular test pattern in A. *Upper curve:* responses to small spot of light, at high and low intensities corresponding to those of test pattern (see insert). The differences between the two curves illustrate that lateral inhibition enhances the response on the light side of an edge (because there is less inhibition from the more darkly lit neighbors to the right) and depresses the response on the dark side of an edge (because there is more inhibition from the brightly lit neighbors to the left). (From Ratliff, 1965)

Receptive Field for A

PRIMARY SENSORY NEURON

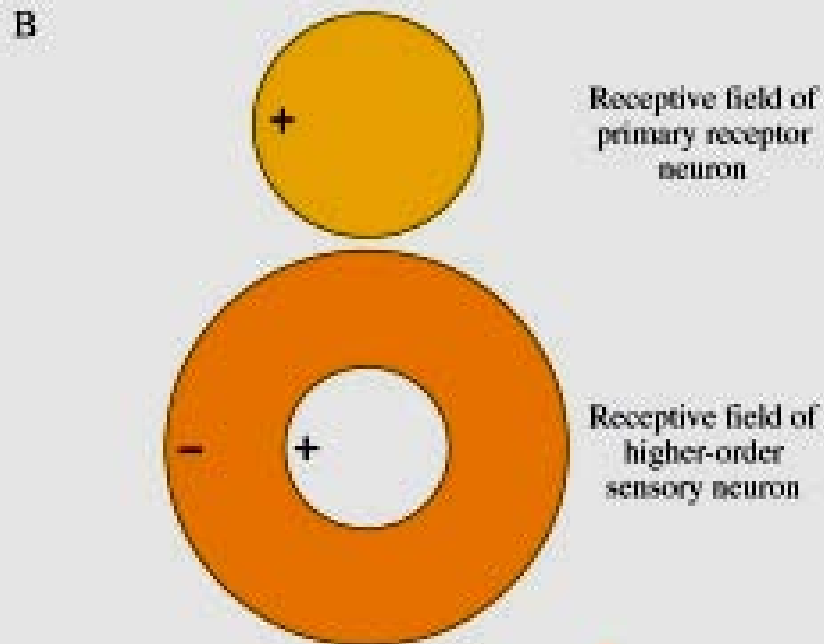
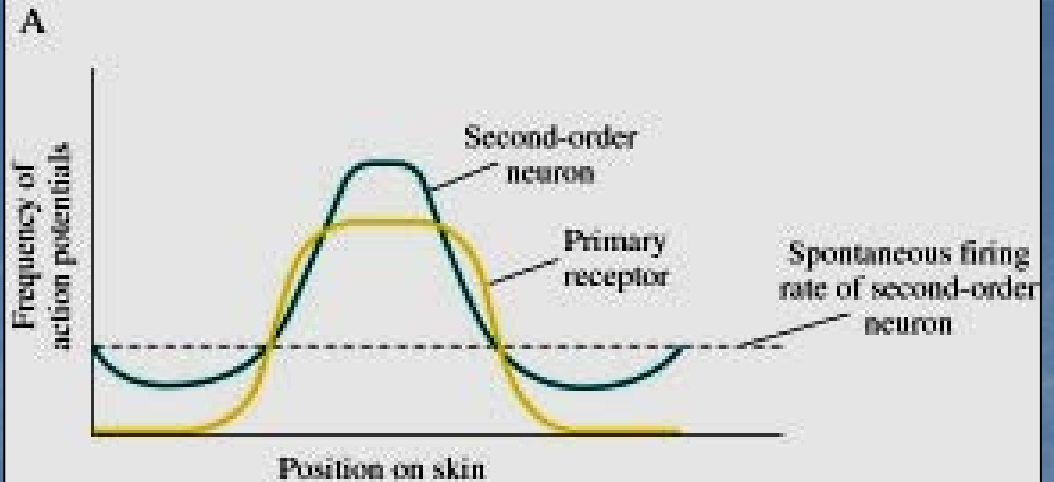
FIRST ORDER NEURON

SECOND ORDER NEURON

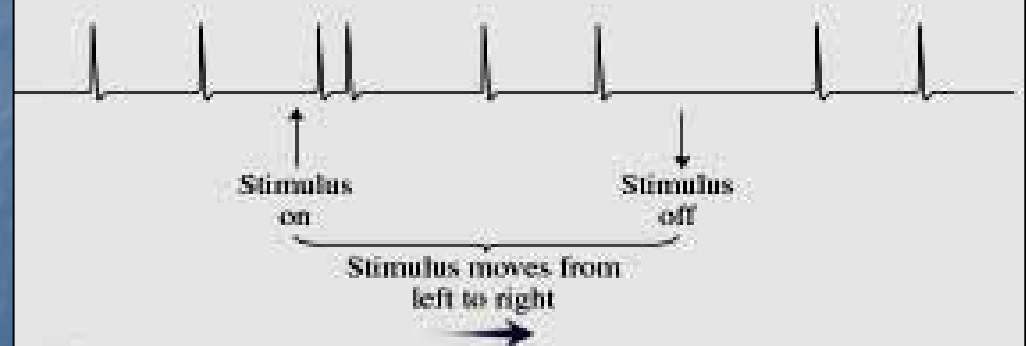
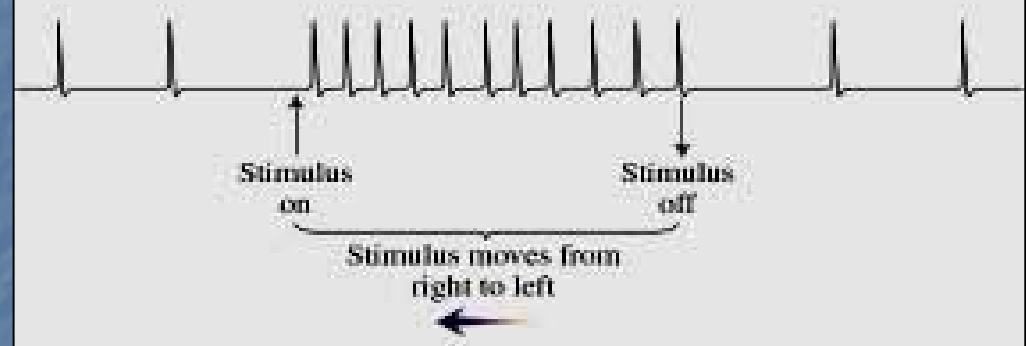
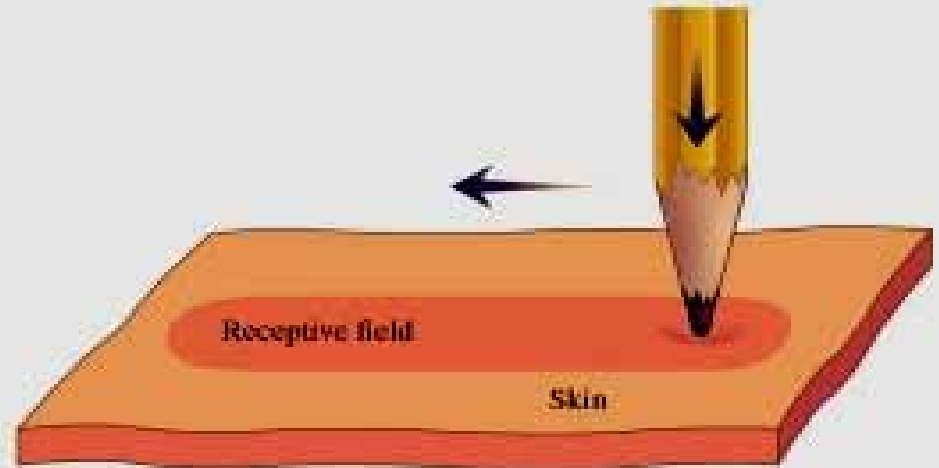


Receptivní pole primárního a sekundárního neuronu.

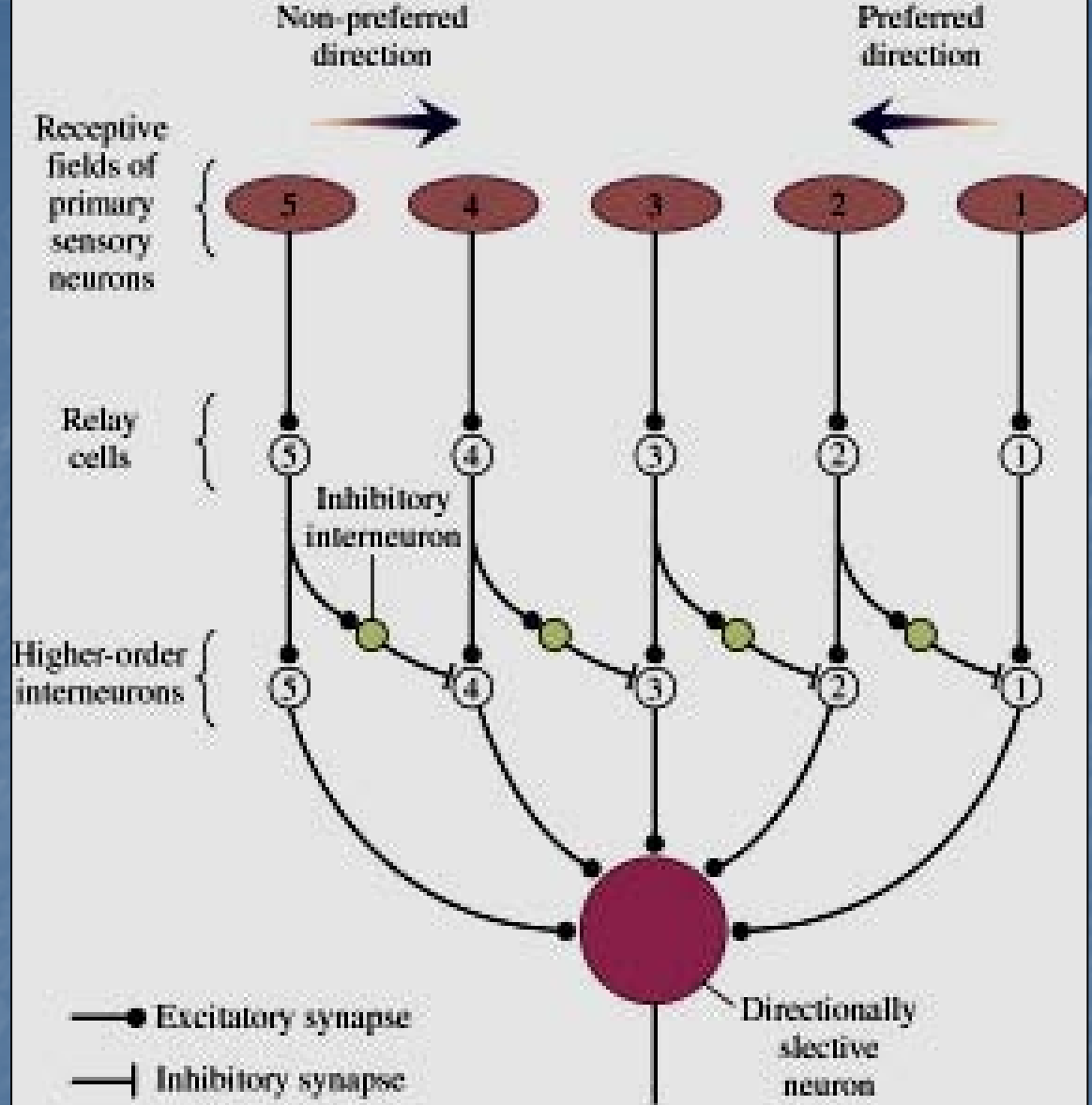
Optimální struktura pole pro maximální podráždění.



Díky propojení drah vznikne detektor směru stimulu.



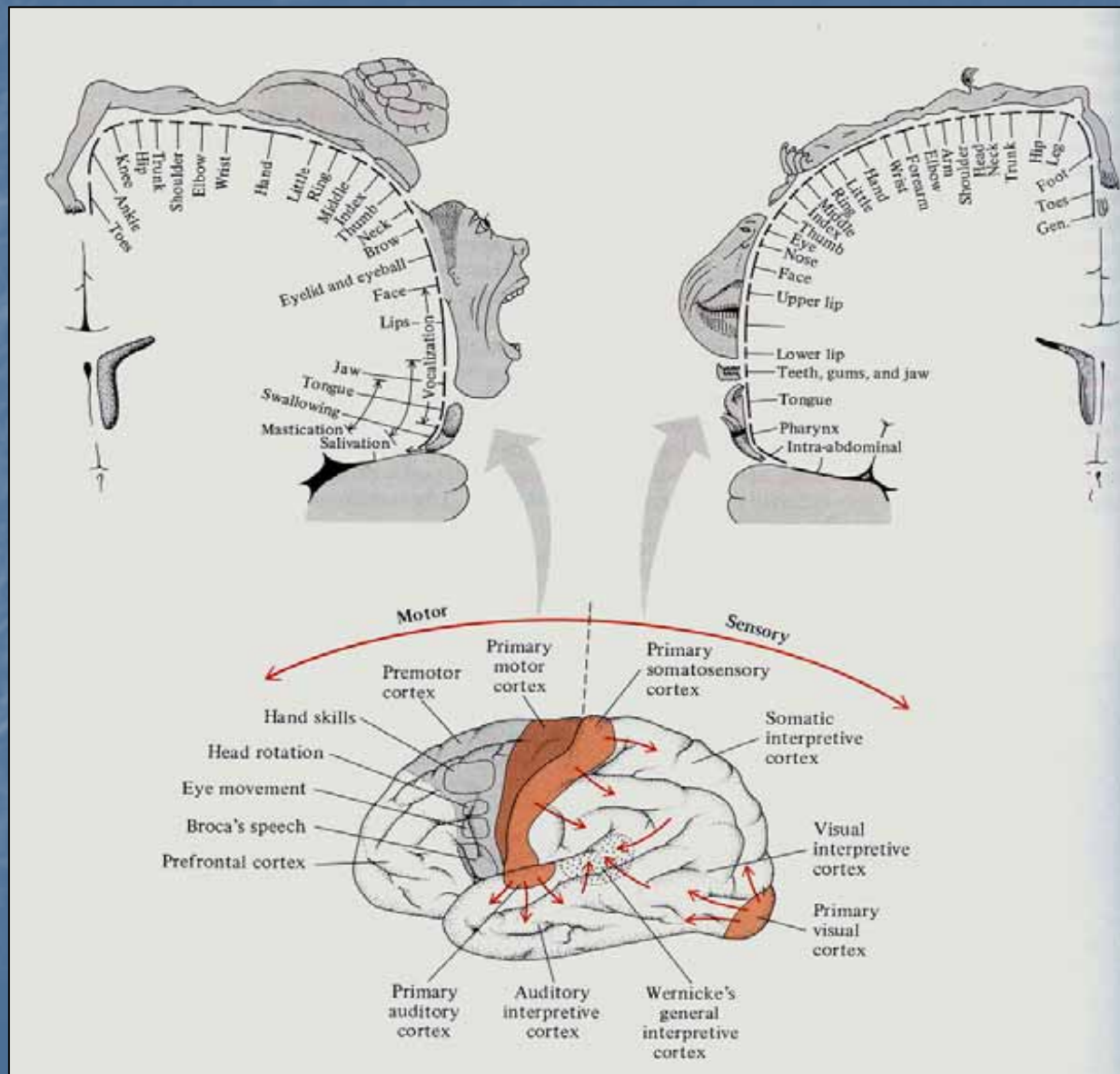
# Detektor směru stimulu





# Topografie drah a polí - Sensorické mapy

- somatotopie
- retinotopie
- tonotopie
- chemotopie



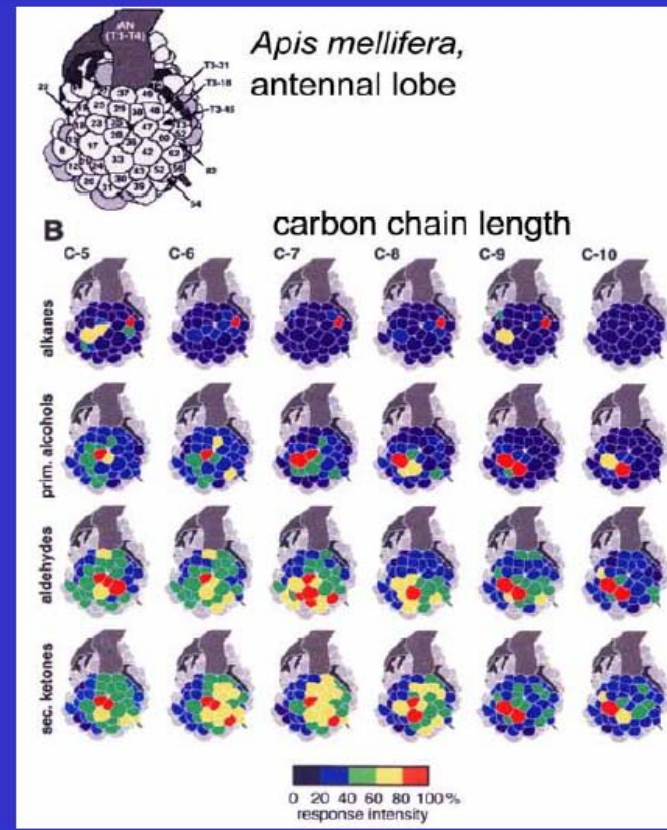
# Sensorické mapy

- somatotopie
- retinotopie
- tonotopie
- chemotopie

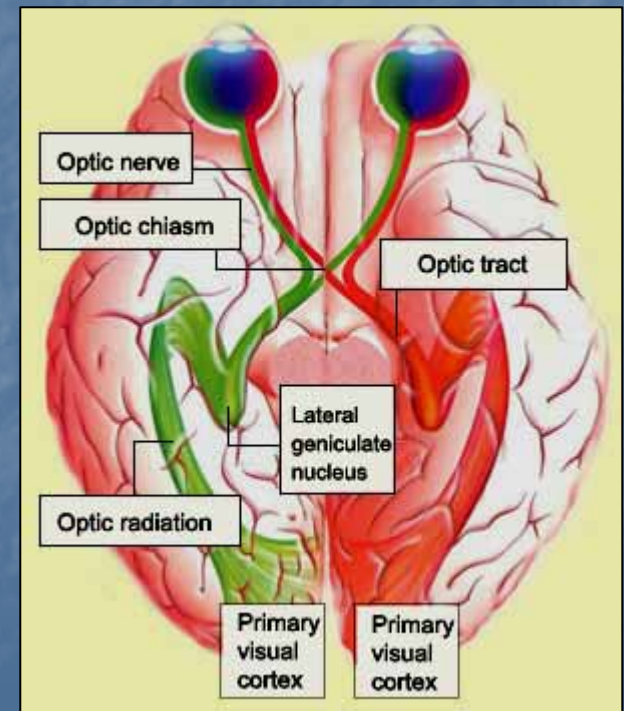
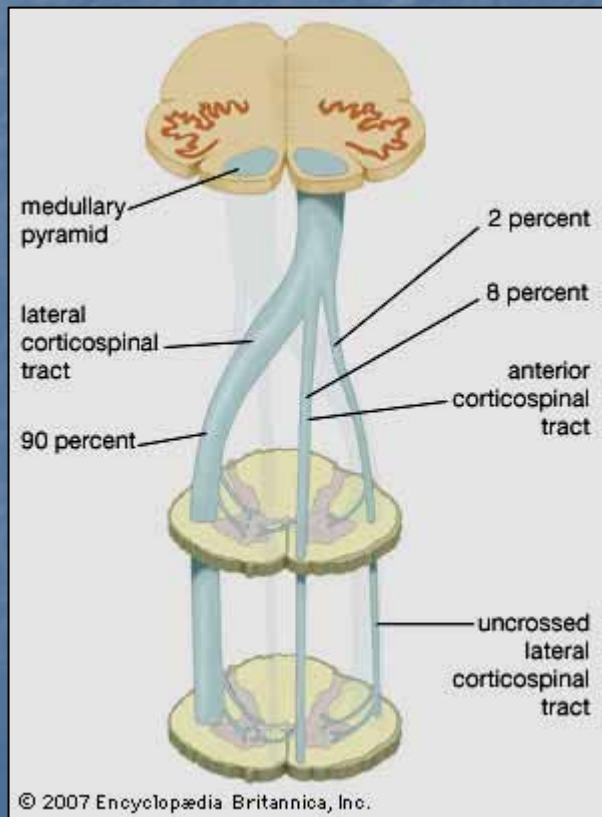
Reprezentace  
odpovídajících si plošných,  
ale i neprostorových  
vlastností.

Rychlost, směr, vůně

**Glomeruli  
responses  
reflect  
odorants'  
structural  
properties  
(chain length,  
residues,  
polarity etc.):  
odor map**

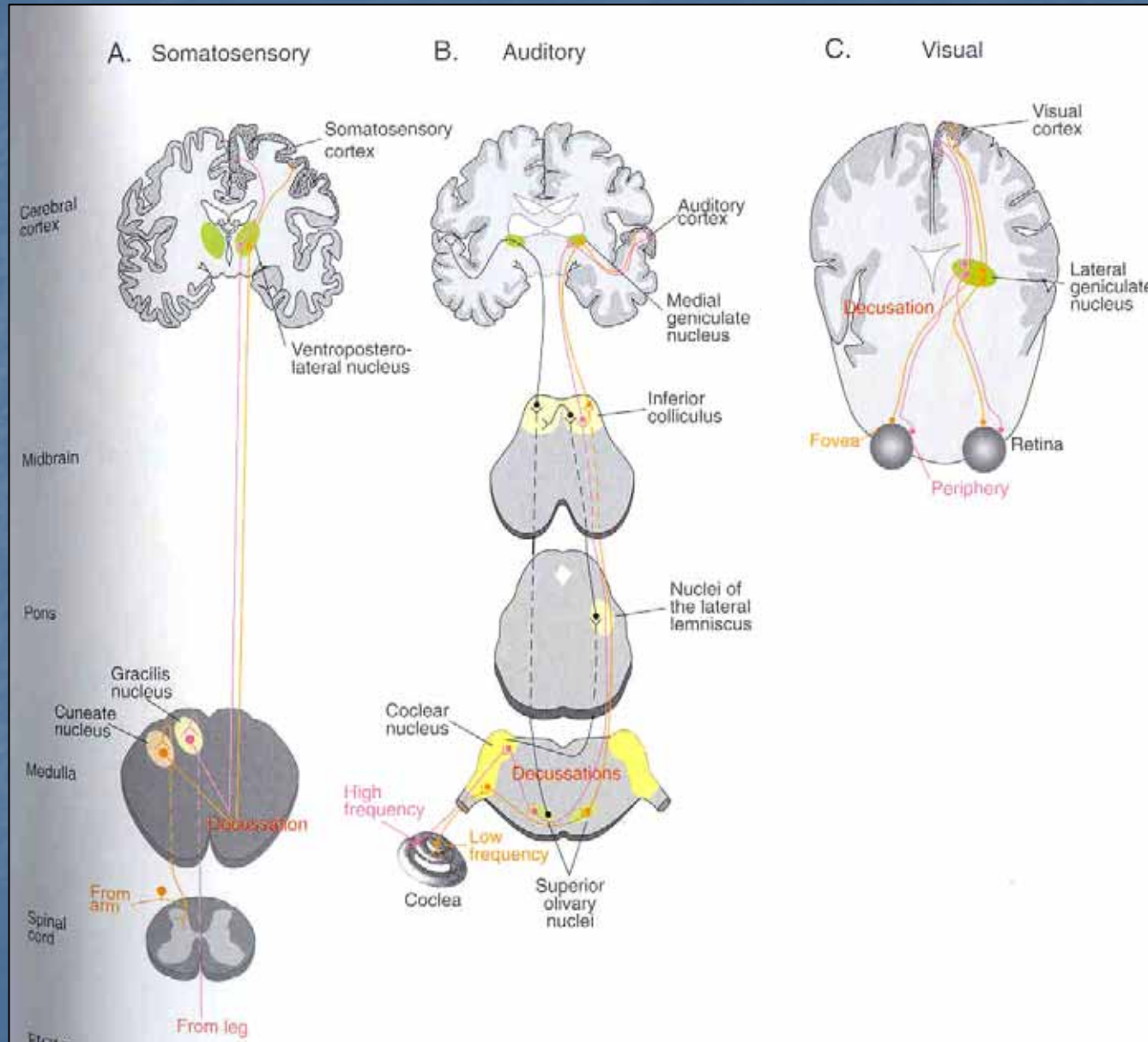


- Axony jednotlivých drah se kříží v centrální rovině před vstupem do thalamu.
- Zraková, sluchová i somatosensorická dráha.
- Čichová a chuťová dráha ne.



- V rámci jedné modality vedou paralelní dráhy – možná kvůli větší rychlosti zpracování, možná různý původ.
- Sluch: pozice zdroje a parametry zvuku jsou zpracovávány odděleně
- Zrak: odděleně se vyhodnocuje barva, kontury, pohyb, pozice
- Úkol pro CNS zpětně je integrovat do jednoho celku.

Každý sensorický systém (kromě čichu) má svá specifická jádra v thalamu.

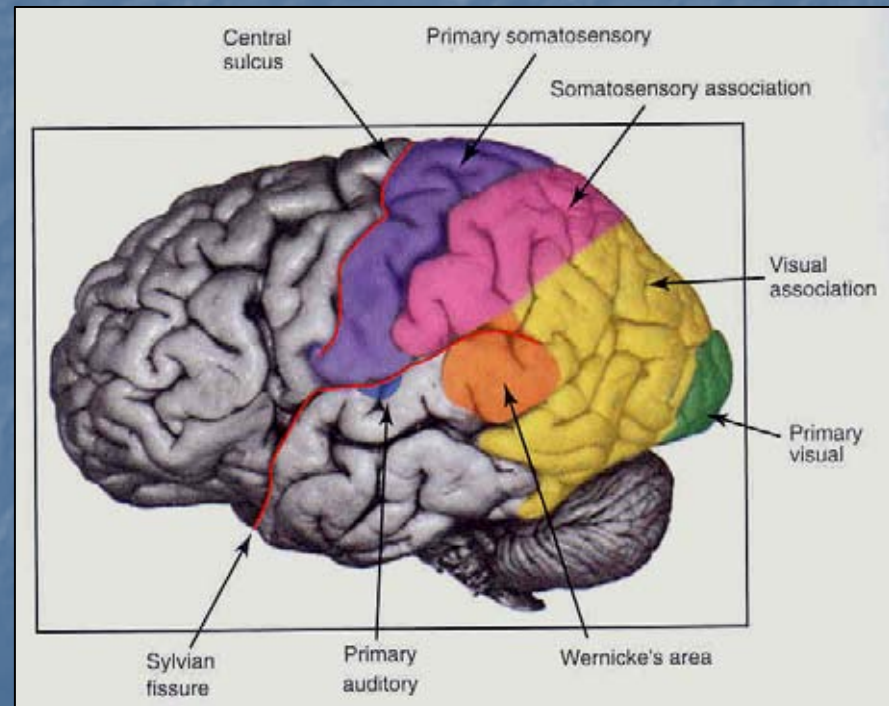


## 3 úrovně organizace sensorických systémů

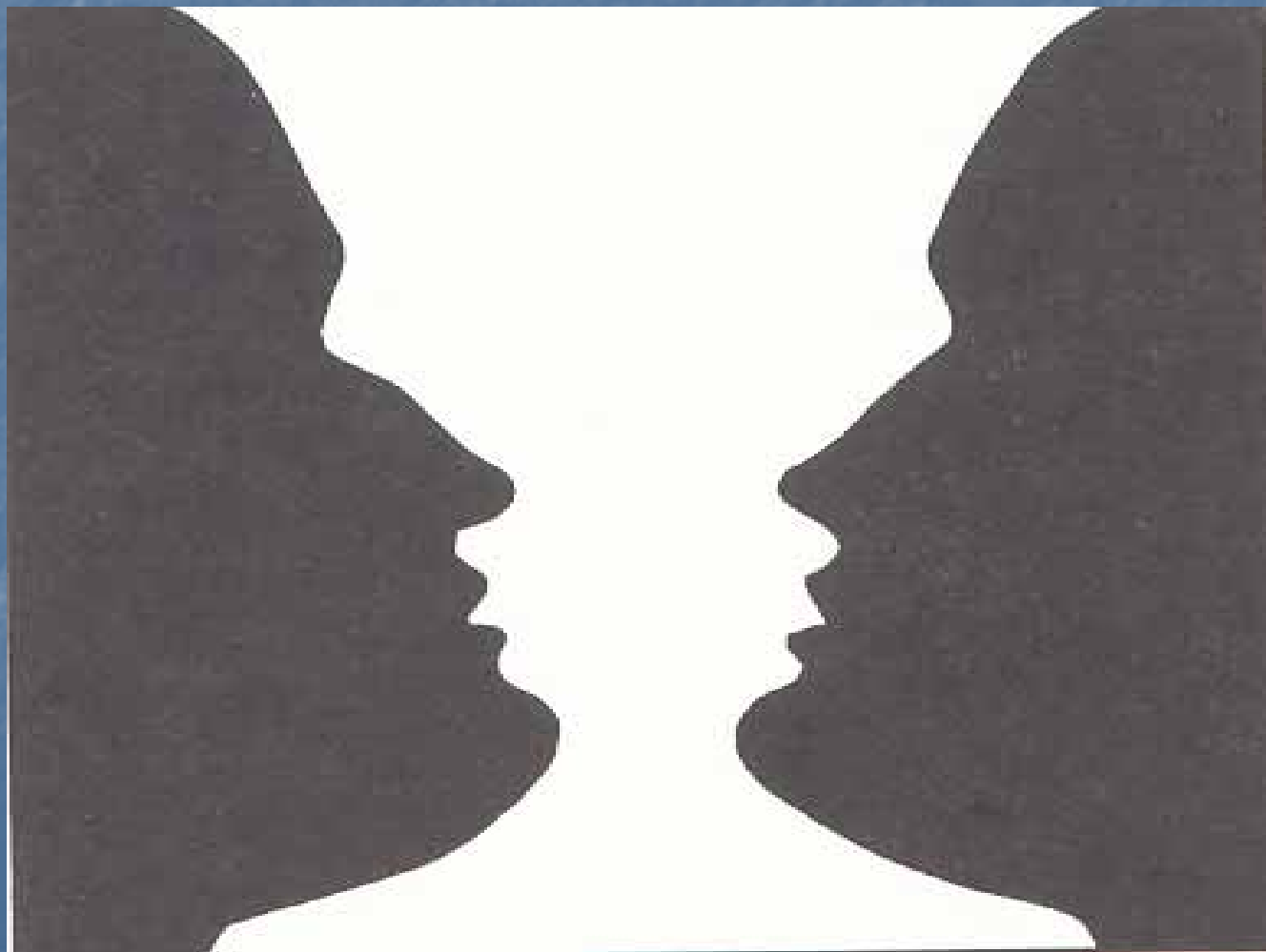
- A) Receptory
- B) Sensorické obvody a dráhy
- C) **Sensorická percepce**

## Sensorický kortex

Primární a sekundární (asociační, interpretační) oblasti kůry.  
Princip paralelních rysových analyzátorů – specialistů na linie, barvy, tóny, vzdálenosti, směry pohybu atd. Hierarchické skládání do celku



Co vnímáme, když slyšíme a vidíme? Psychofyziologie.  
Velká úloha zkušenosti a interpretace.  
Vjemy jsou automaticky zařazovány, aktivně interpretovány.  
Identifikace, emoce, paměť.

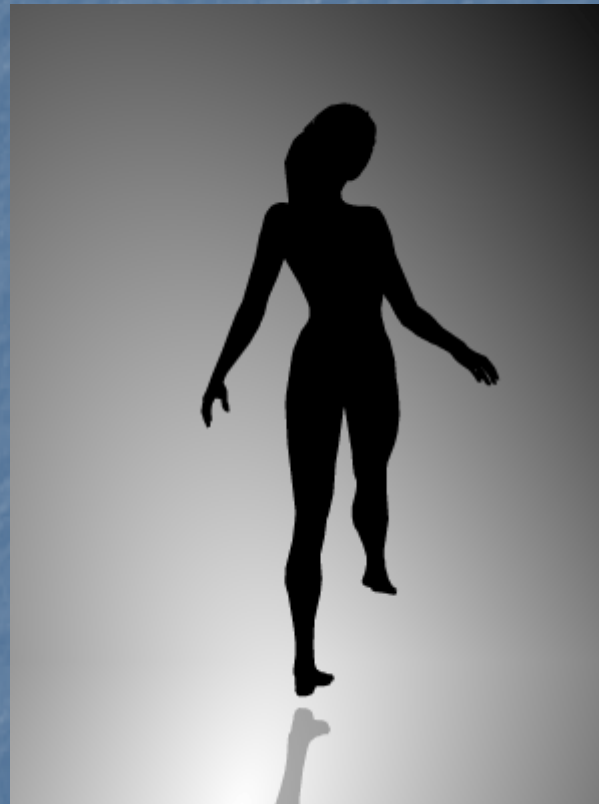




Co vidíme?



Kam se točí?



- Vjemy z různých smyslů se integrují
- Iluze s gumovou rukou – zrak a hmat spolupracují na vnímání polohy těla v prostoru
- <http://sites.sinauer.com/wolfe3e/chap13/rubberhandF.htm>

# Mechanoreception



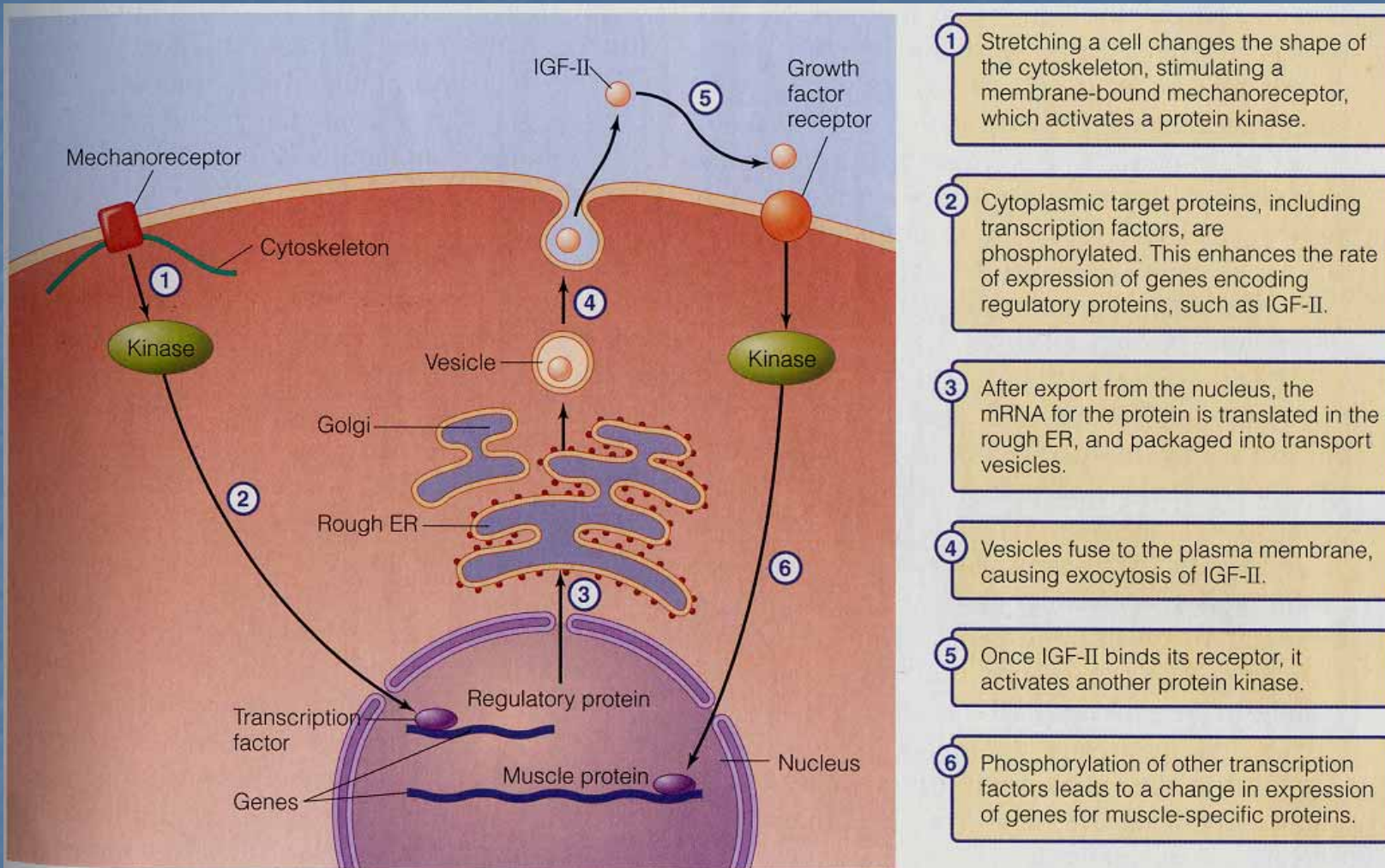
- Vedle chemorecepce nejstarší smysl.
- Odhaluje podstatné vlastnosti prostředí. Sluch, hmat, rovnováha, zrychlení, propriorecepce, osmorecepce, hygmorecepce? magnetorecepce?
- Konzervativní molekulární mechanismus
- Typicky rychlé, ionotropní řízení kanálů, ale:

- Mechanické podněty mohou zapínat a vypínat geny. V mnohobuněčné tkáni je každá buňka v kontaktu se svými sousedkami i s okolní extracelulární hmotou prostřednictvím mnoha typů přilnavých molekul, které přenášejí mezi buňkami nejen chemické signály, ale i síly mechanické a deformační. Většina buněk není schopna dlouhodobého života, pokud postrádá mechanické kontakty, ať už s okolními buňkami nebo s pevným povrchem.

- Mezenchymální kmenové buňky nasazené na podložky různé mechanické tuhosti diferencují na různé buněčné typy. Na měkkých podložkách se mění v neurony, na středně tuhých podložkách ve svalové buňky a na nejtvrděších v kostní buňky.

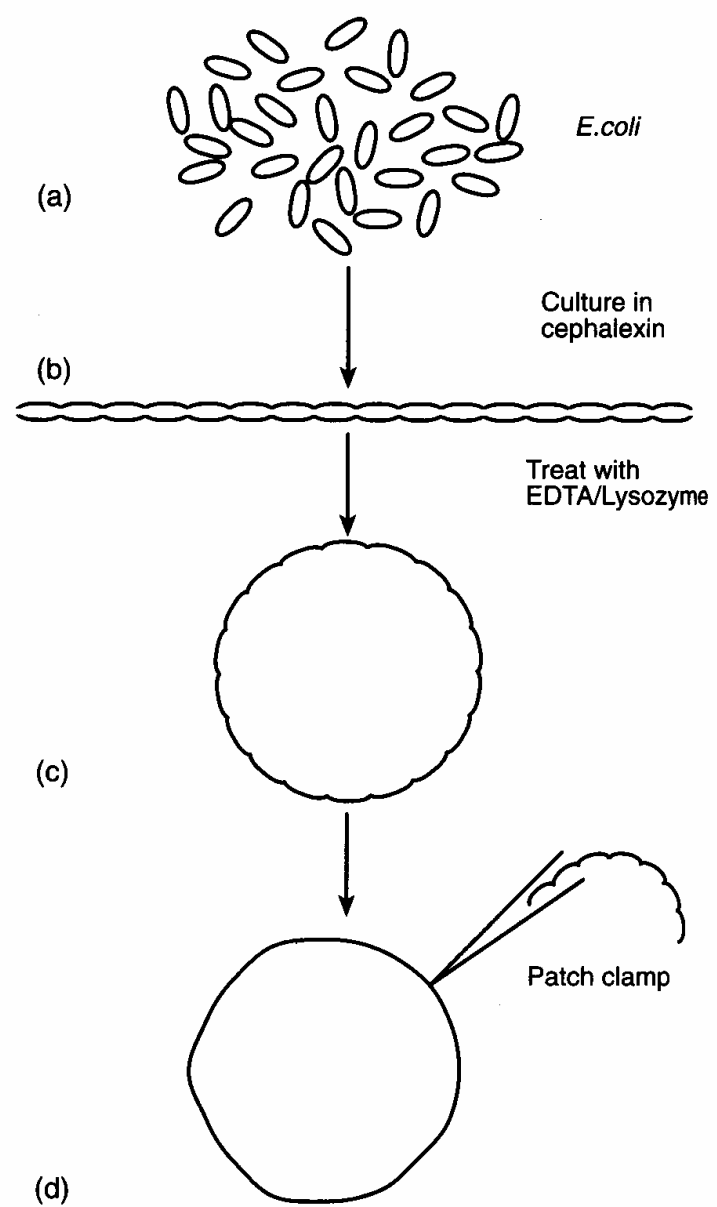
(Vesmír 3, 2010)

# Mechanorecepce může přímo řídit expresi Např. růst svalů



**Figure 5.33 Control of gene expression by stretch receptors** Some muscle cells sense the degree of stretch and respond by a cascade initiated by stretch receptors and culminating in changes in muscle gene expression.

# E. Coli jako model pro výzkum molekulárního mechanismu



**Figure 5.1** Patch-clamping *E. coli*. (a) *E. coli* cell. (b) Cultured in medium containing cephalaxin and forms lengthy filaments. (c) Filament treated with EDTA/lysozyme and rounds-up to form large spheroplast. (d) Microelectrode (tip diameter about 0.5 mm) inserted to form a patch-clamp. Further explanation in text

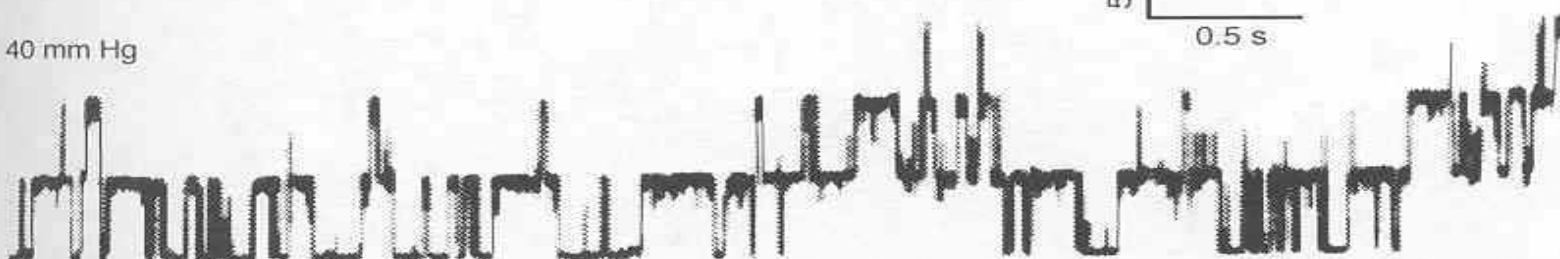
30 mm Hg

+20mV

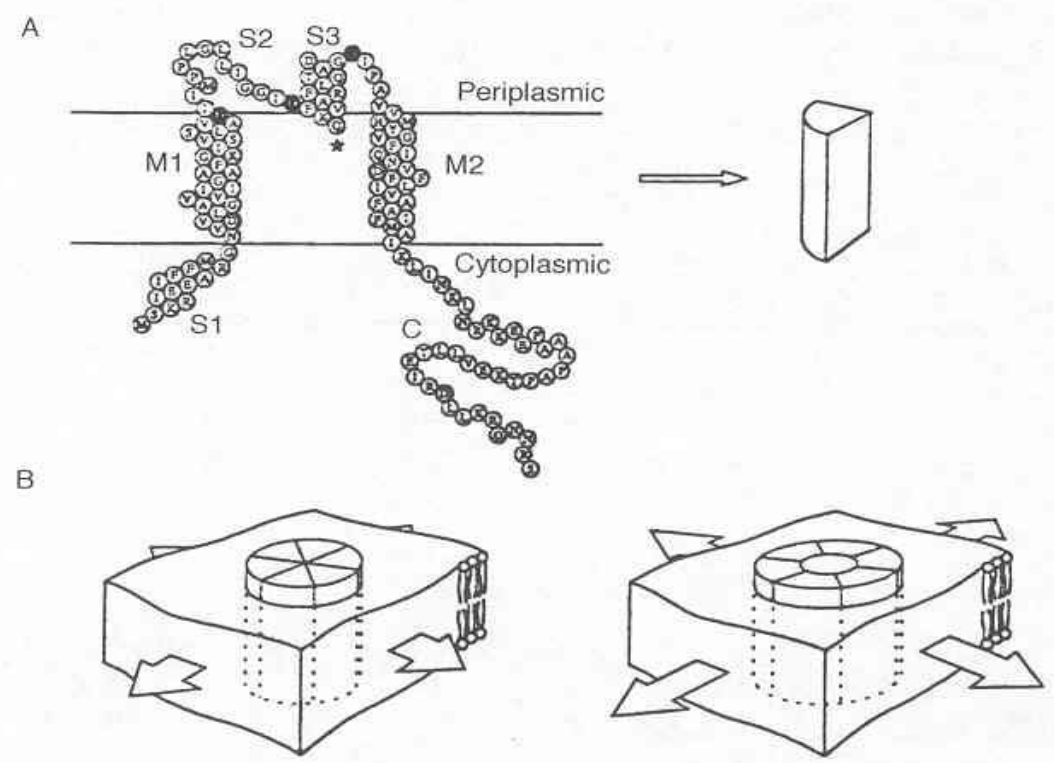


50 pA  
0.5 s

40 mm Hg



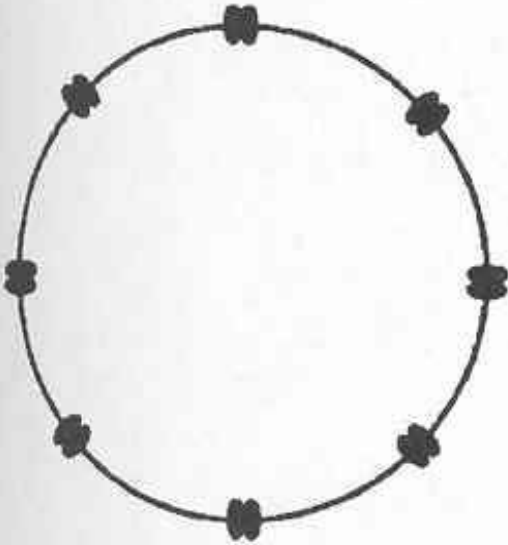
MscL kanál.  
Největší známý  
kanál 2,5nm.  
Chrání proti nárazům  
osmolarity, signál růstu.



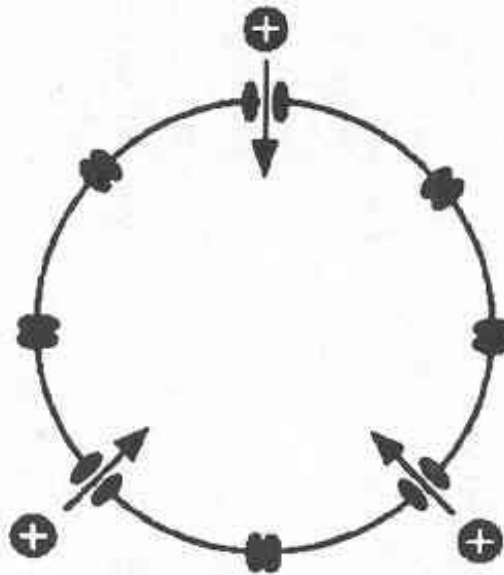


# Savčí osmosensitivní buňka hypotalamu – napojení na hormonální osy vodního hospodaření.

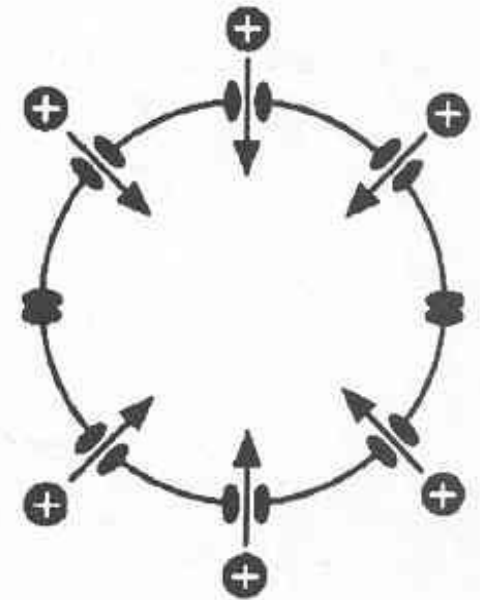
Hypotonicity  
(275 mosm)

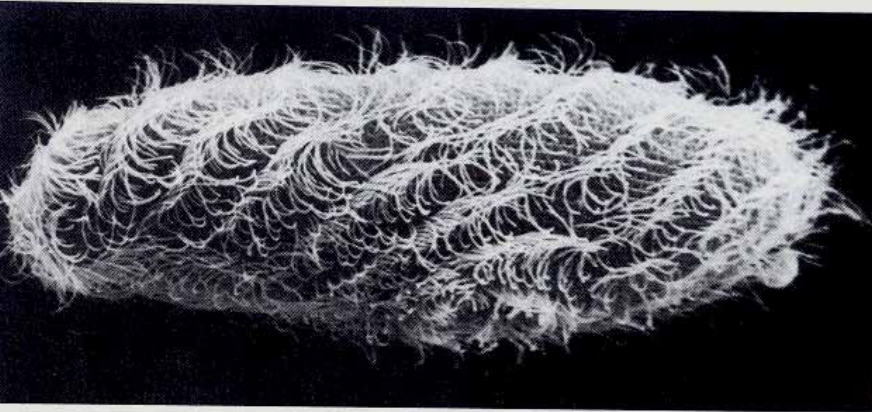


Set-point  
(295 mosm)



Hypertonicity  
(315 mosm)

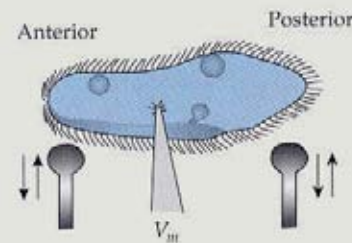
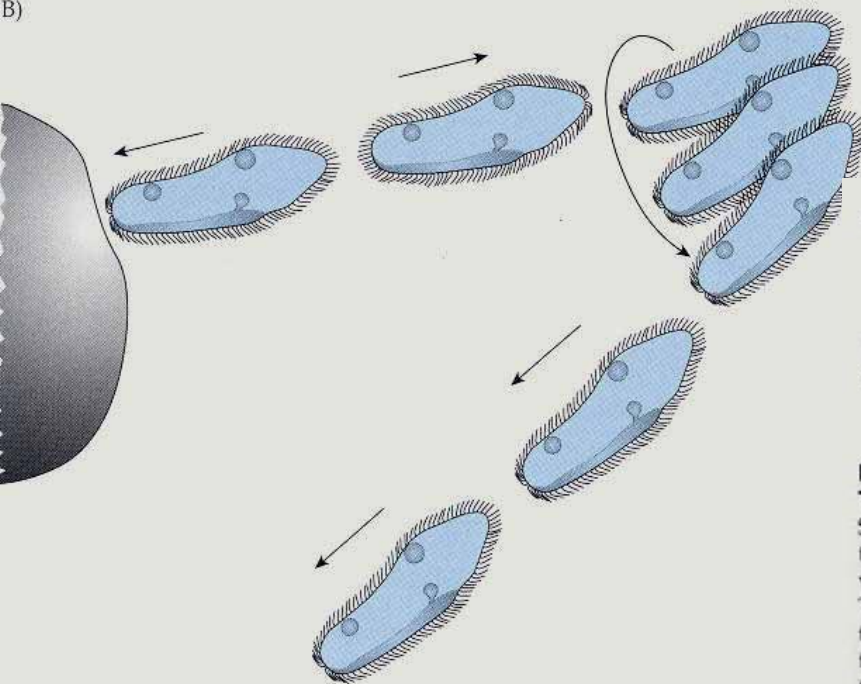




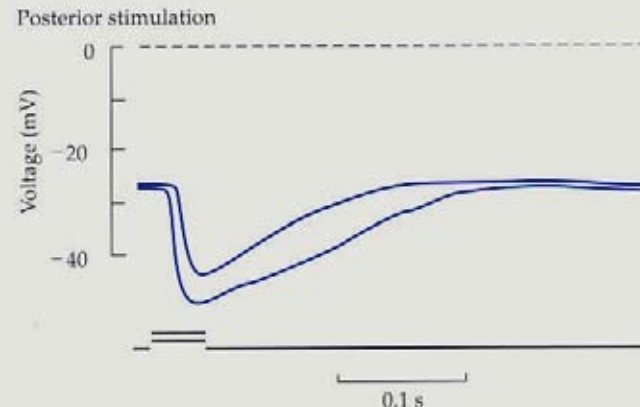
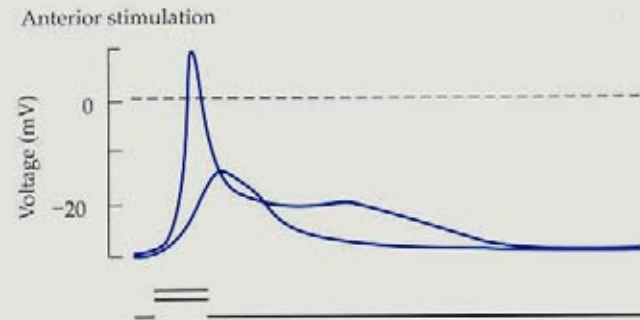
1906 - vpředu jinak než vzadu  
1969 – potenciály

Ca tok vpředu, K vzadu

B)



**Figure 5.2**  
**Touch responses of *Paramecium***  
Stimuli were produced by an electrically driven microstylus that was pressed up against the cell. The timing and relative amplitude of the stimuli are shown in the traces below each of the electrical recordings. Two amplitudes of pressure were applied at each location. (From Eckert, 1972.)



Paramecium



**Caenorhabditis elegans (hád'átko)**

960 buněk

302 neuronů

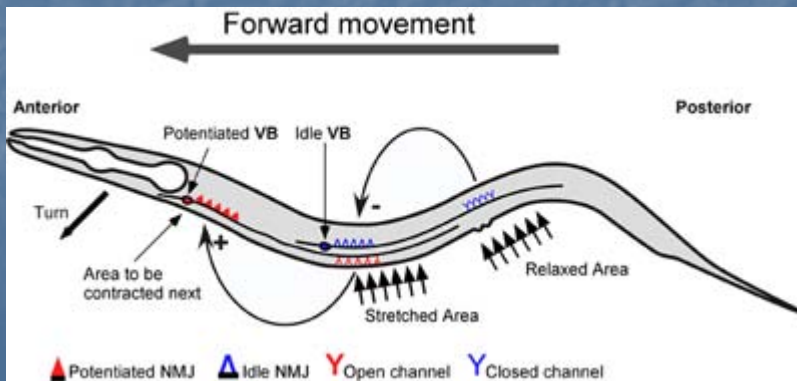
1998 genom



Courtesy of Ralf Sommer

**Figure 7.1** *Caenorhabditis elegans*. This worm is about 200  $\mu$ m in length. *C. elegans* consists of 959 somatic cells of which 302 constitute the nervous system. The body is translucent and many of its cells can be distinguished in the living animal. Reprinted from J. G. White, 1985, 'Neuronal connectivity in *Caenorhabditis elegans*', *Trends in Neurosciences* 8, 277 with permission from Elsevier Science

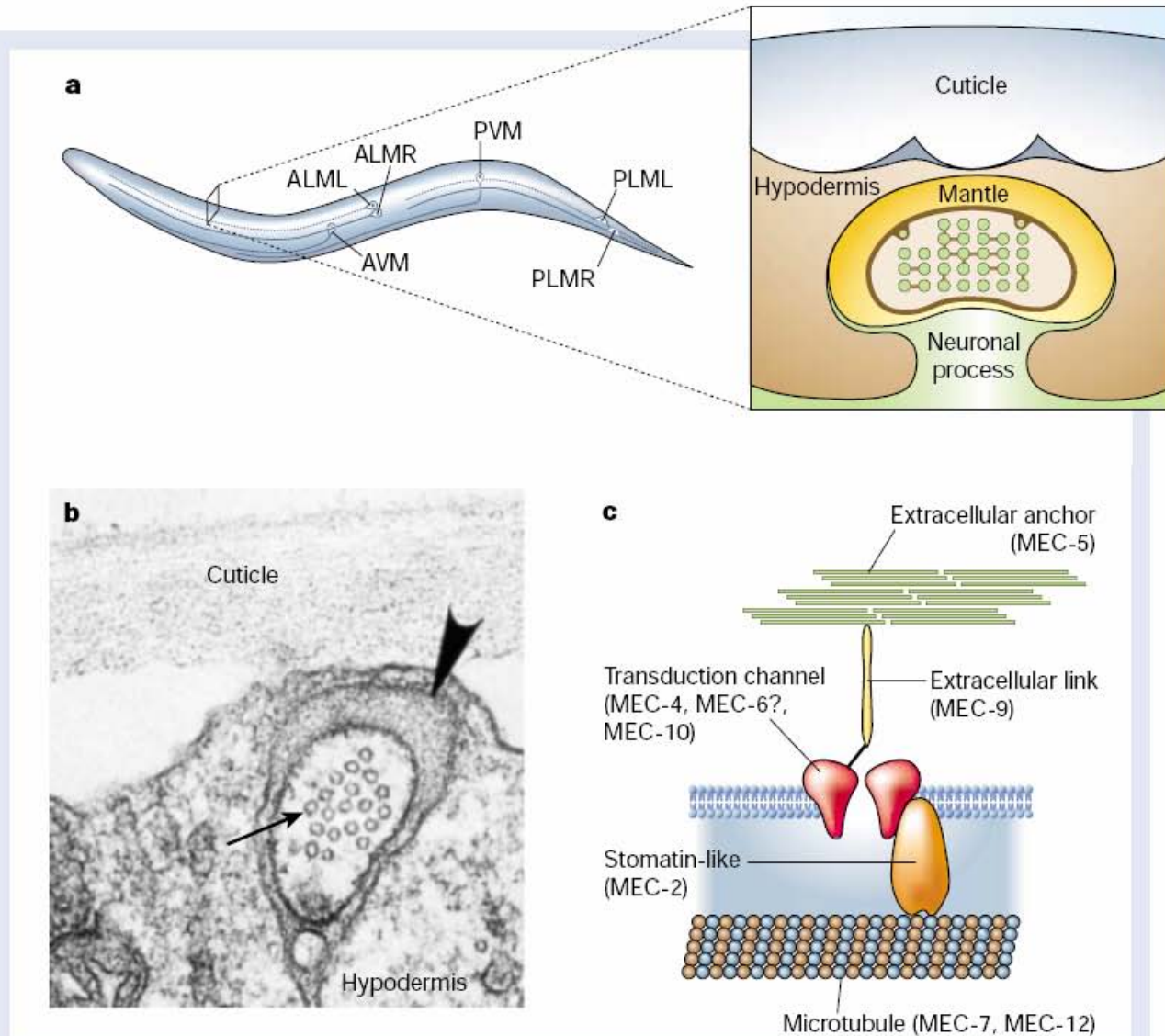
Jemný dotek na hlavu způsobí obrácení pohybu a dotek na zadní část způsobí pohyb vpřed. Byl zkoumán velký počet mutací, které způsobí poruchu tohoto základního chování. Bylo vytipováno 15 genů, které způsobí ztrátu mechanosenzitivity, aniž by byla zasažena schopnost pohybu. Dostaly jméno *mec* geny a proteiny, které kódují MEC proteiny.



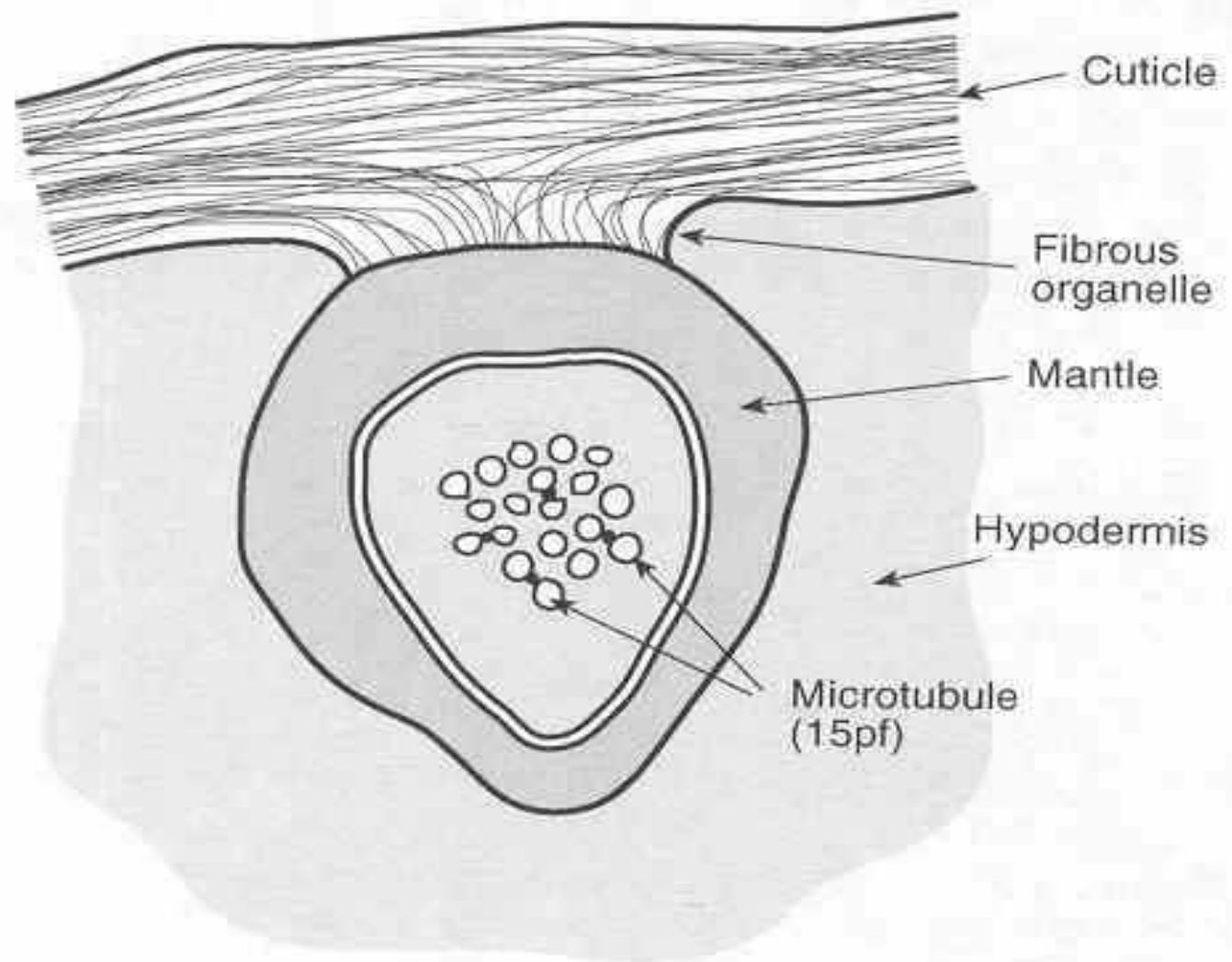
# 6 hmatových neuronů se svazky mikrotubulů

Po vyřazení kolchicinem, laserem, mutacemi ztráta citlivosti

**Figure 2** *C. elegans* touch-receptor structure and transduction model. **a**, View of *C. elegans* showing positions of mechanoreceptors. AVM, anterior ventral microtubule cell; ALML/R, anterior lateral microtubule cell left/right; PVM, posterior ventral microtubule cell; PLML/R, posterior lateral microtubule cell left/right. **b**, Electron micrograph of a touch-receptor neuron process. Mechanotransduction may ensue with a net deflection of the microtubule array relative to the mantle, a deflection detected by the transduction channel. Arrow, 15-protofilament microtubules; arrowhead, mantle. Modified from ref. 3. **c**, Proposed molecular model for touch receptor. Hypothetical locations of *mec* proteins are indicated.

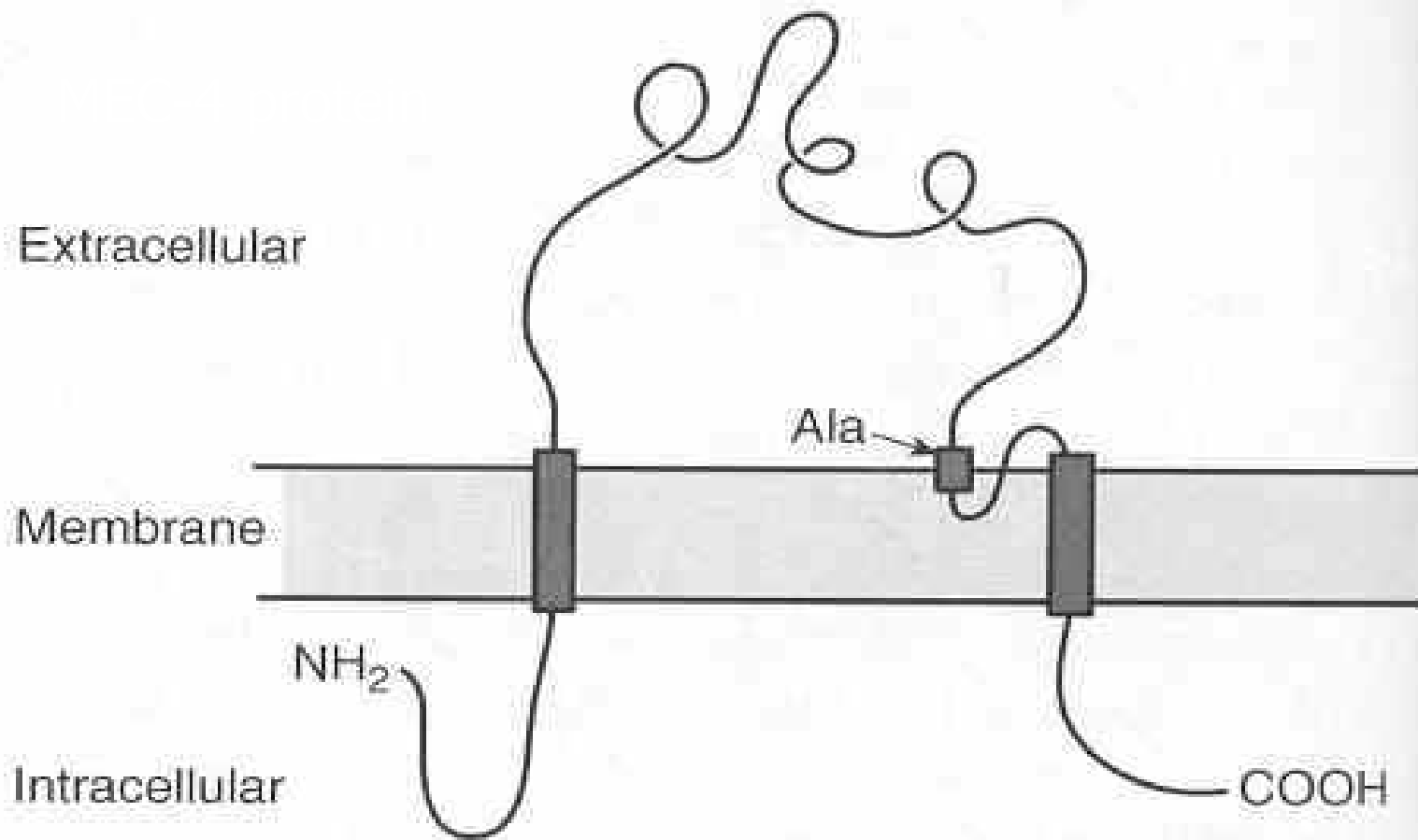


Uvnitř  
mikrotubuly,  
vně kutikula



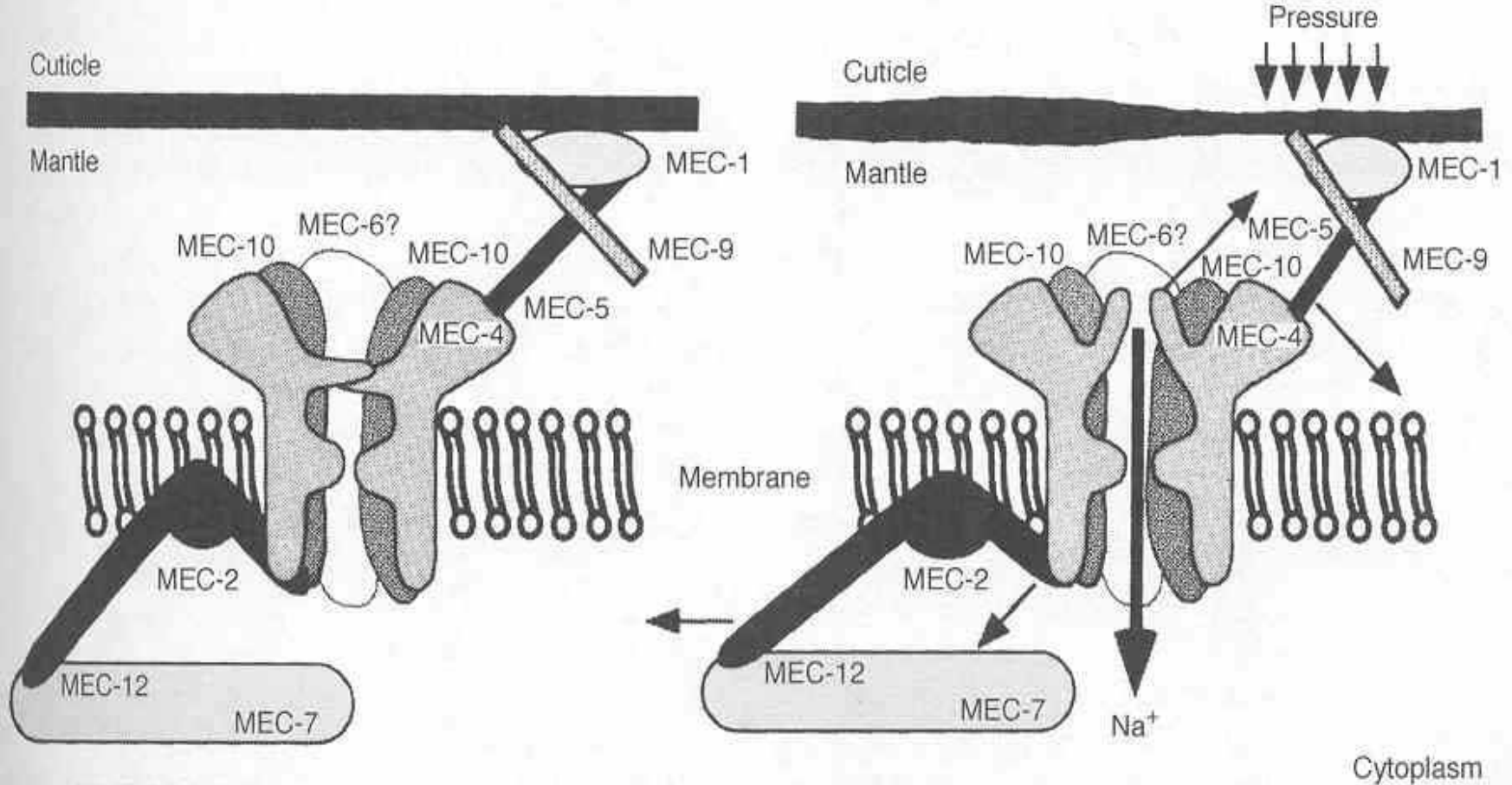
**Figure 7.3** Ultrastructure of *C. elegans* touch receptor neuron in transverse section. The neuron is surrounded by a connective tissue mantle and is attached to the cuticle by a 'fibrous organelle'. It contains a bundle of microtubules (each composed of 15 protofilaments (pf)). After Tavernarakis and Driscoll, 1997

Když byla prokázána ztráta citlivosti u některé mutace, zjišťovalo se, který to byl gen a která bílkovina. Bylo definováno několik proteinů tvořících kationtový kanál. Jak MEC-4 tak MEC-10 patří do velkorodiny příbuzné s podjednotkami savčího Na kanálu. Když jsou MEC-4 a MEC-10 exprimovány v oocytu *Xenopus* je možné pomocí voltage clamp měřit jejich otevření – proudy při určitém potenciálu. Žádné napětově senzitivní kanály se neuplatňují a vše jde na vrub podráždění



**Figure 7.4** Transmembrane topology of the MEC-4 protein. There are two transmembrane domains and a small membrane insertion just before the second transmembrane helix. The bulk of the 768 residue protein is, as indicated, in the extracellular space. When Alanine<sub>713</sub> (Ala) is replaced by a bulkier amino acid cell death ensues. After Tavernarakis and Driscoll, 1997



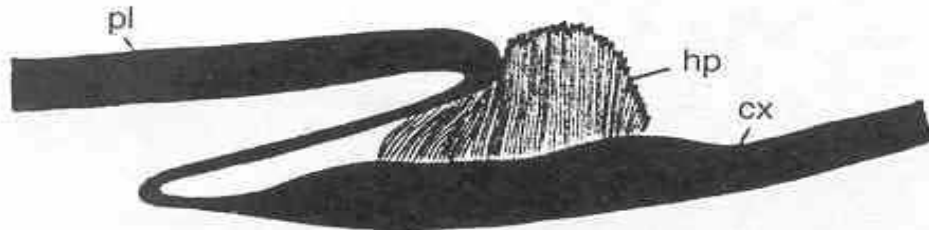


**Figure 7.6** Conceptual model of *C. elegans* touch receptor. Explanation and nomenclature in text. From N. Tavernarakis and M. Driscoll, 1997, 'Molecular modelling of mechanotransduction in the nematode *Caenorhabditis elegans*', *Annual Review of Physiology*, 59, 679. With permission, from the *Annual Review of Physiology*, Volume 59, ©1997, by Annual Reviews

Proud výrazně vzroste, když se exprimuje ještě i MEC-2. Podobně je to s MEC 6 kou. Jak je tedy celý komplex pospojován dohromady není dosud zcela jasné, ale pravděpodobně MEC-1, MEC-5 a MEC-9 jsou organizovány tak, že přenášejí tlak z kutikuly na MEC-4 a otevírají Na kanál. Tento mechanický přenos je funkční jen tehdy, když je kanál ukotven z intracelulární strany na mikrotubuly cytoplasmy. Dále se uplatní MEC 7 a 12 což jsou tubuliny, 5,1,9 jsou extracelulární, exkretované do prostoru okolo sensorických výběžků.

# Behaviorální skríníng a elektrický záznam z brvy

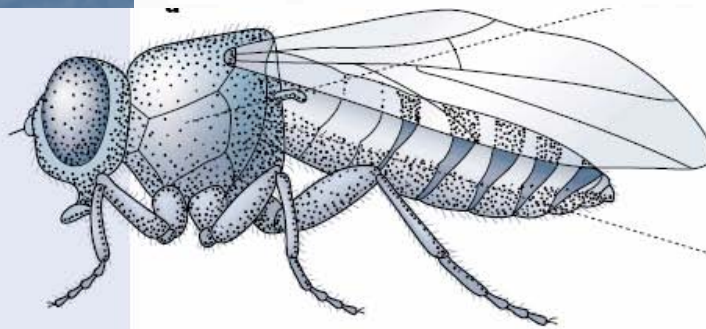
Mutanti NompA a C  
Necitliví na dotek, ale i  
nekoordinovaní a hluší  
NompA je extracelulární  
kotva a NompC je TRP  
kanál



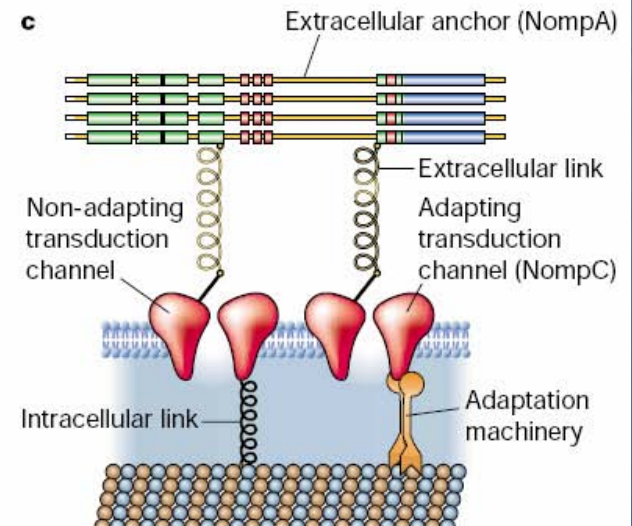
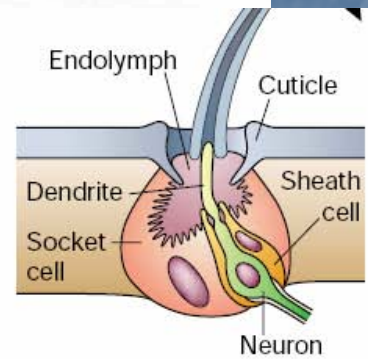
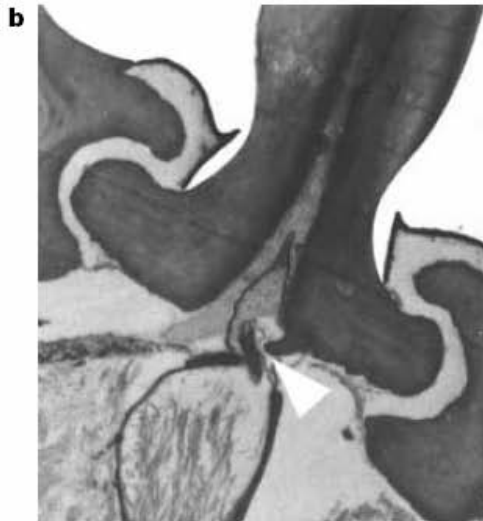
**Figure 6.3** (a) The figure shows the brushwork of sensilla at the articulation of the second leg of the cockroach, *Periplaneta americana*. The thick cuticle of the pleuron (pl) thins to a delicate articular membrane and then thickens again to form the cuticle surrounding the coxa (cx), the first segment of the leg. The brush of sensilla forms a hairplate (hp). From Pringle, 1938

**Figure 3** *Drosophila* bristle-receptor model.

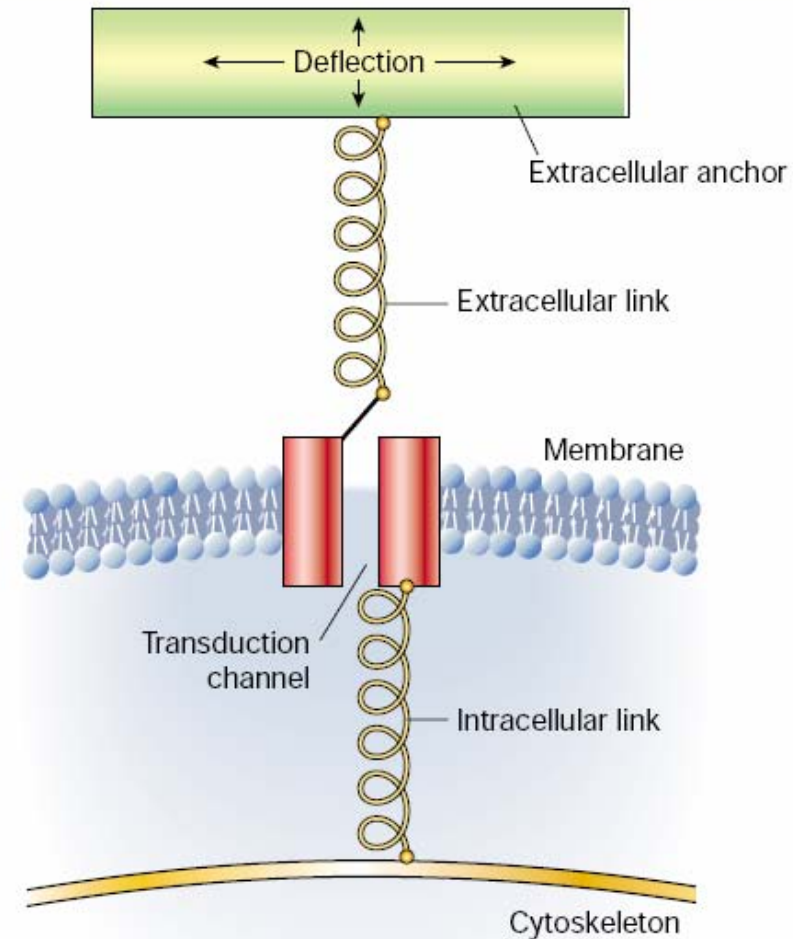
**a**, Lateral view of *D. melanogaster* showing the hundreds of bristles that cover the fly's cuticle. The expanded view of a single bristle indicates the locations of the stereotypical set of cells and structures associated with each mechanosensory organ. Movement of the bristle towards the cuticle of the fly (arrow) displaces the dendrite and elicits an excitatory response in the mechanosensory neuron.



**b**, Transmission electron micrograph of an insect mechanosensory bristle showing the insertion of the dendrite at the base of the bristle. The bristle contacts the dendrite (arrowhead) so that movement of the shaft of the bristle will be detected by the neuron.

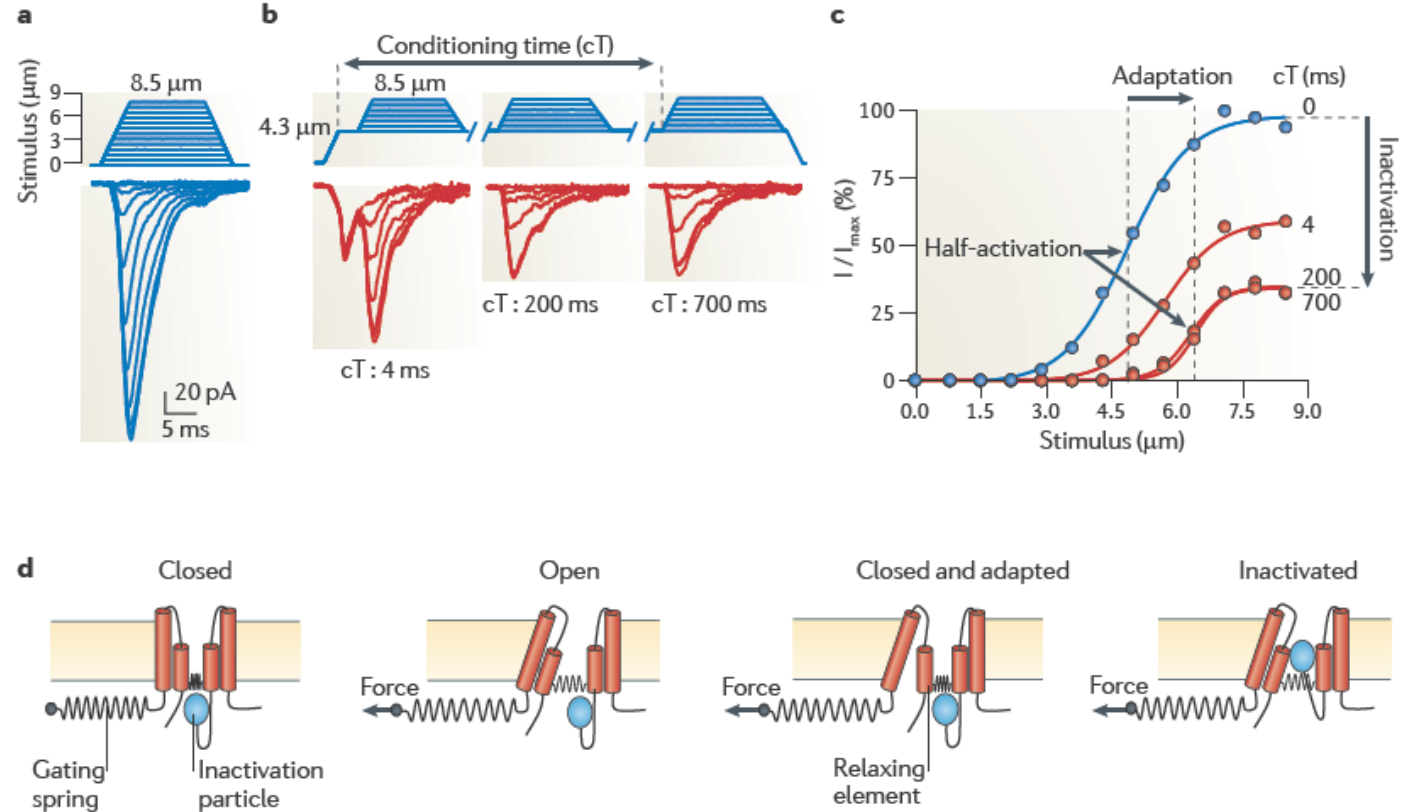


Drosophila:  
TRP kanál  
Shodný předek s vláskovými buňkami  
obratlovců  
Obecné schéma mechanorecepce:  
Iontropní, ukotvený, adaptabilní



**Figure 1** General features of mechanosensory transduction. A transduction channel is anchored by intracellular and extracellular anchors to the cytoskeleton and to an extracellular structure to which forces are applied. The transduction channel responds to tension in the system, which is increased by net displacements between intracellular and extracellular structures.

# Inaktivovatelný



**Figure 3 | Mechanisms of mechanotransducer current desensitization.** Desensitization of mechanosensitive currents manifests as a decline in response to sustained application of the mechanical stimulus. The different desensitization rates of mechanotransducer currents relate to their functions as sensors of phasic and tonic stimuli, and contribute to the extraction of biologically important information from the stimulus. **a** | A series of mechanical stimuli applied in 0.7- $\mu\text{m}$  increments in a rat dorsal root ganglion neuron elicits a family of rapidly adapting mechanosensitive currents. **b** | A conditioning stimulus of increasing duration causes desensitization, manifested as a decrease in the current response to subsequently delivered test steps. **c** | Current-stimulus ( $I$ - $X$ ) relationships derived from (**b**) at different times after the onset of the conditioning stimulus illustrate the effect of desensitization. In particular, the conditioning stimulus shifts the activation curve rightward (adaptation) and reduces its amplitude relative to the control relationship (inactivation). **d** | A cartoon representation of the main states of mechanosensitive channels in sensory neurons. Mechanical forces are conveyed to the pore-forming structure through an elastic element or gating spring, which can be a cytoplasmic domain bound to phospholipids and/or cytoskeletal elements or an associated protein. When the gating spring is stretched, channel domains are pulled apart, favouring the open state. As force is maintained, the channel either inactivates, possibly via a ball-and-chain mechanism, or adapts. The inactivating ball could be either a cytoskeletal element or part of the channel protein. During adaptation, the stiffness of the gating spring remains constant but the channel reverts to a closed conformation. cT, conditioning time;  $I_{\text{max}}$ , maximum current. Figure is modified, with permission, from REF. 51 © (2010) Society for Neuroscience.

## Box 1 | Experimental strategies to probe mechanotransduction

The development of various techniques for studying mechanotransduction has opened up new pathways for the investigation of molecular mechanisms of mechanosensation. These techniques can be used to bridge the gap between the properties of mechanotransducer currents *in vitro* and the characteristics of mechanoreceptors *in vivo*.

### Cell-based assays

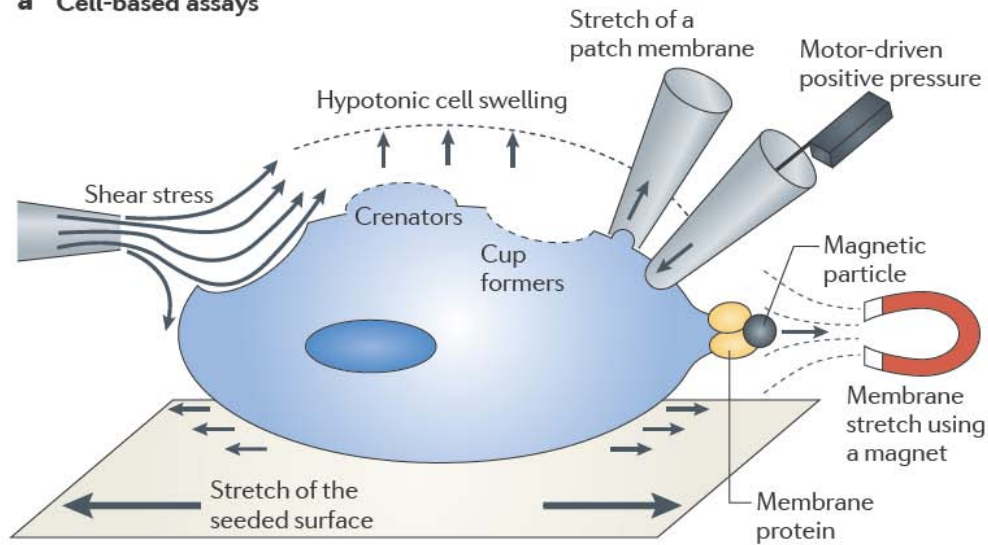
Several types of mechanical challenges can be used to activate mechanosensitive channels (see the figure, part a). These strategies are based on membrane deformation, yet each has the potential to recruit different populations of mechanosensitive channels.

**Motor-driven pressure.** Focal deformation of the plasma membrane uses an electrically driven mechanical probe. This technique can be applied to cell bodies and neurites of sensory neurons *in vitro*<sup>43,48</sup>.

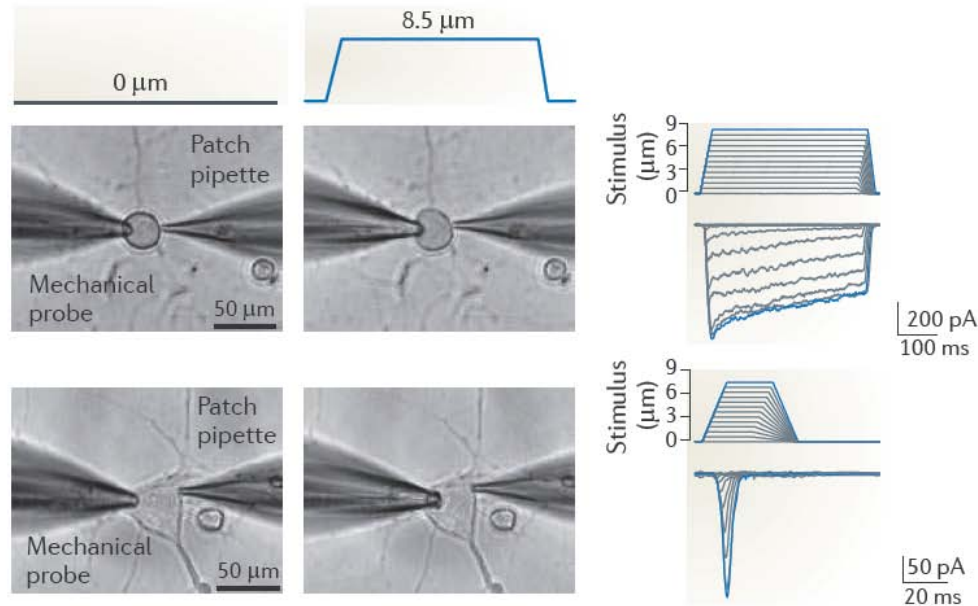
**Cell stretch.** Two methods are commonly used — surface elongation of a flexible silicone elastomer substrate on which cells have been seeded<sup>57</sup> and application of positive or negative pressures to a patch membrane through a patch pipette<sup>86,138,159</sup>.

A recently developed, related technique consists of stimulating neurites of cultured dorsal root ganglion (DRG) neurons through indentation of an elastomeric substrate adjacent to the neurite with a mechanical probe<sup>160</sup>.

### a Cell-based assays



### b Whole-cell mechano-clamp



**Fluid shear stress.** Shear stress can be generated by changing the perfusion flow and/or the viscosity of the perfusion solution. DRG neurons are sensitive to fluid-flow changes<sup>43</sup>.

**Crenators and cup formers.** Anionic and neutral amphipathic compounds, such as free fatty acids, trinitrophenol and lysolecithin, preferentially insert in the outer leaflet of the membrane and induce the crenation of the plasma membrane. Conversely, positively charged amphipathic compounds, such as chlorpromazine and tetracaine, insert in the inner leaflet of the bilayer and cause the cell to form cup shapes. Such amphipathic molecules have been shown to regulate the activities of the MscL ion channel<sup>101</sup> and of the two-pore domain K<sup>+</sup> channels TREK1 and TRAAK<sup>138,102</sup>.

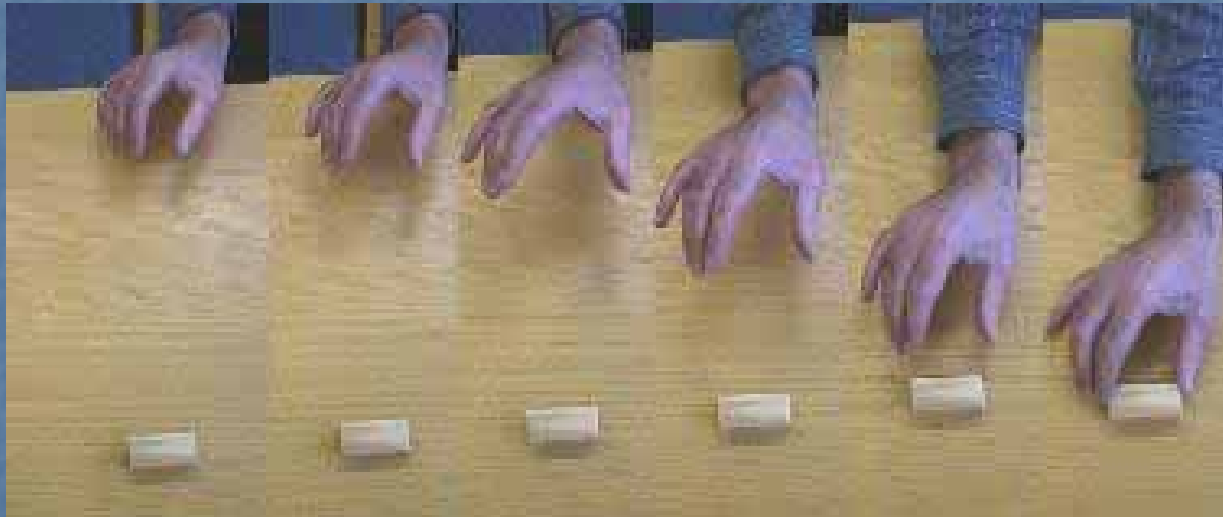
**Osmotic challenges.** Hypotonic conditions induce cell swelling, whereas hypertonicity causes cell shrinkage. Thus, owing to deformation of cell morphology and lipid bilayer tension, osmotic variations are considered by some researchers as a type of mechanical stimulation<sup>52</sup>. However, note that osmotic stress does not create uniform tension in the cell membrane and causes cytosolic alterations, including intracellular calcium elevation and exchange of osmolytes that complicate data interpretation<sup>49</sup>.

**Magnetic particles.** This technique uses magnetic particles to apply forces to cells<sup>103</sup>. Magnetic particles can be coated with specific ligands, including adhesion molecules and antibodies, which enable them to bind to receptors on the cell surface. An applied magnetic field pulls the particles so that they deliver nanoscale forces at the level of the ligand–receptor bond.

### **Whole-cell mechano-clamp**

Mechanical stimulation of DRG neurons using an electrically driven mechanical probe can be achieved during patch clamping. This technique involves the attachment of a glass micropipette to the surface of the cell membrane. It permits high-resolution recording of single or multiple ion channel currents flowing through the membrane. The microphotographs in part **b** of the figure show patch clamping of DRG neurons with small (upper panel) and large (lower panel) cell body diameters. Mechanosensitive currents (lower traces) activate gradually as a function of the stimulus strength (upper traces). The blue trace highlights the current evoked by the 8.5- $\mu$ m stimulus.

# Propriorecepce- somatický smysl

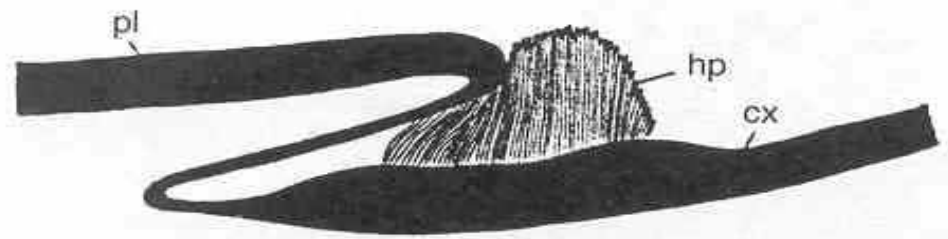
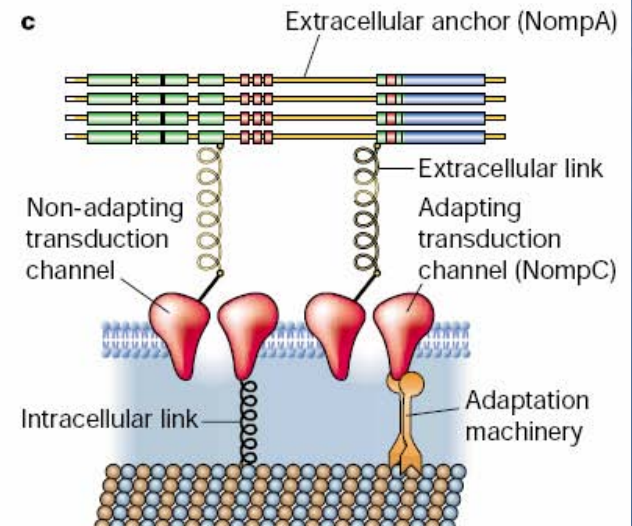
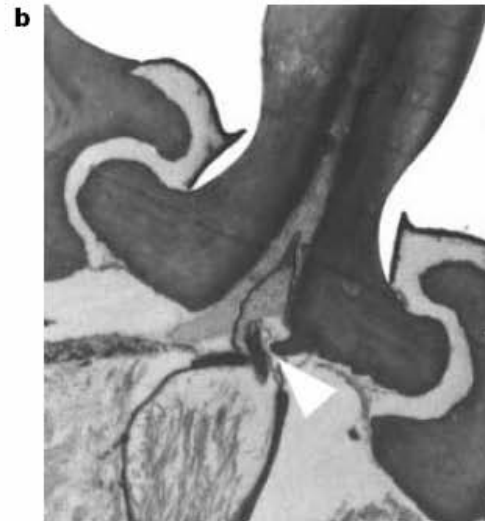
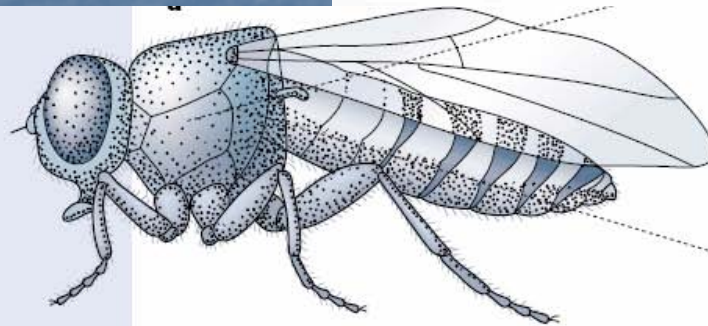


# S exoskeletem – Hmyz Kloubní spojení a proprioreceptory

**Figure 3** *Drosophila* bristle-receptor model.

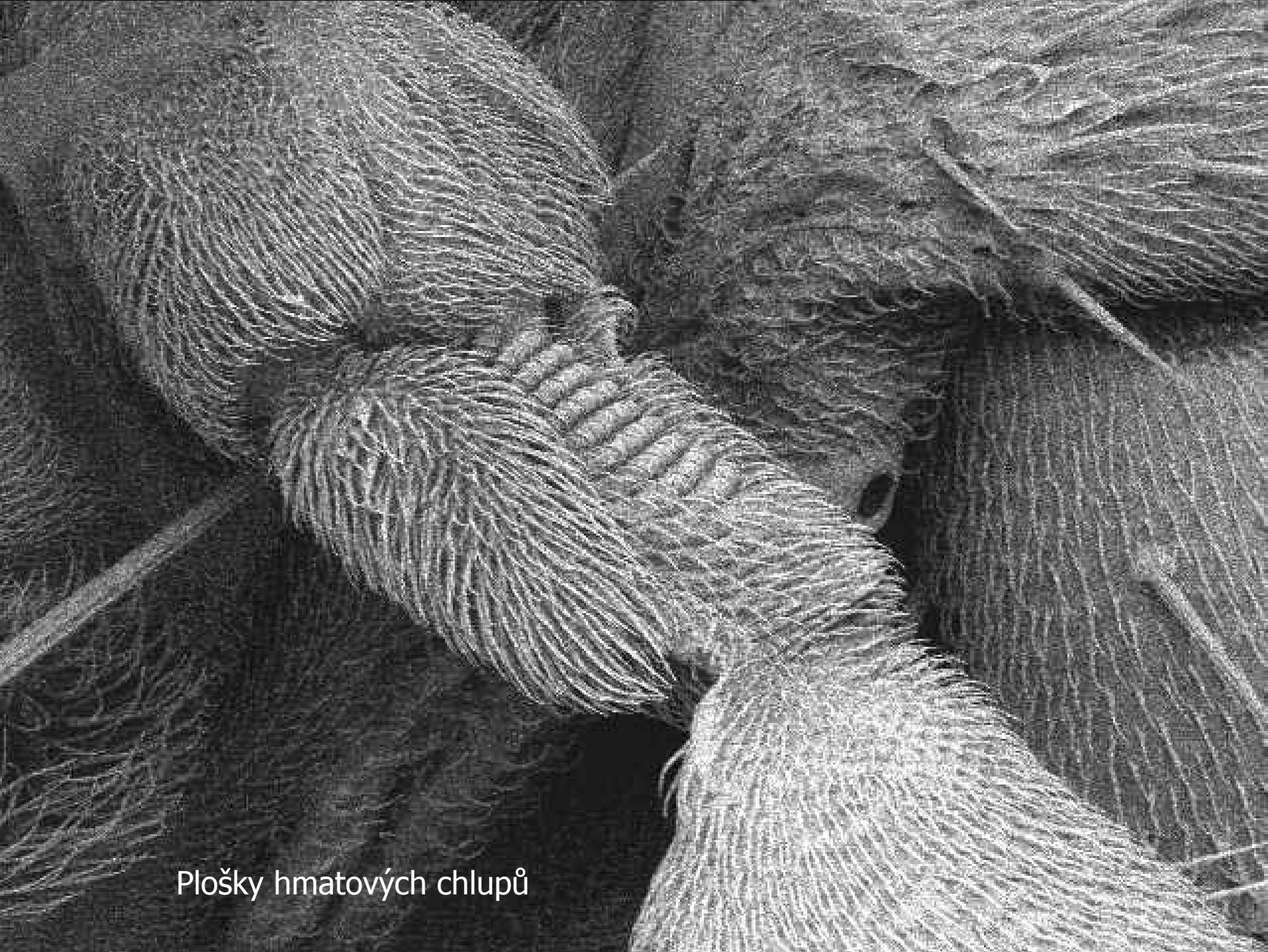
**a**, Lateral view of *D. melanogaster* showing the hundreds of bristles that cover the fly's cuticle. The expanded view of a single bristle indicates the locations of the stereotypical set of cells and structures associated with each mechanosensory organ. Movement of the bristle towards the cuticle of the fly (arrow) displaces the dendrite and elicits an excitatory response in the mechanosensory neuron.

**b**, Transmission electron micrograph of an insect mechanosensory bristle showing the insertion of the dendrite at the base of the bristle. The bristle contacts the dendrite (arrowhead) so that movement of the shaft of the bristle will be detected by the neuron. **c**, Proposed molecular model of transduction for ciliated insect mechanoreceptors, with the locations of NompC and NompA indicated.



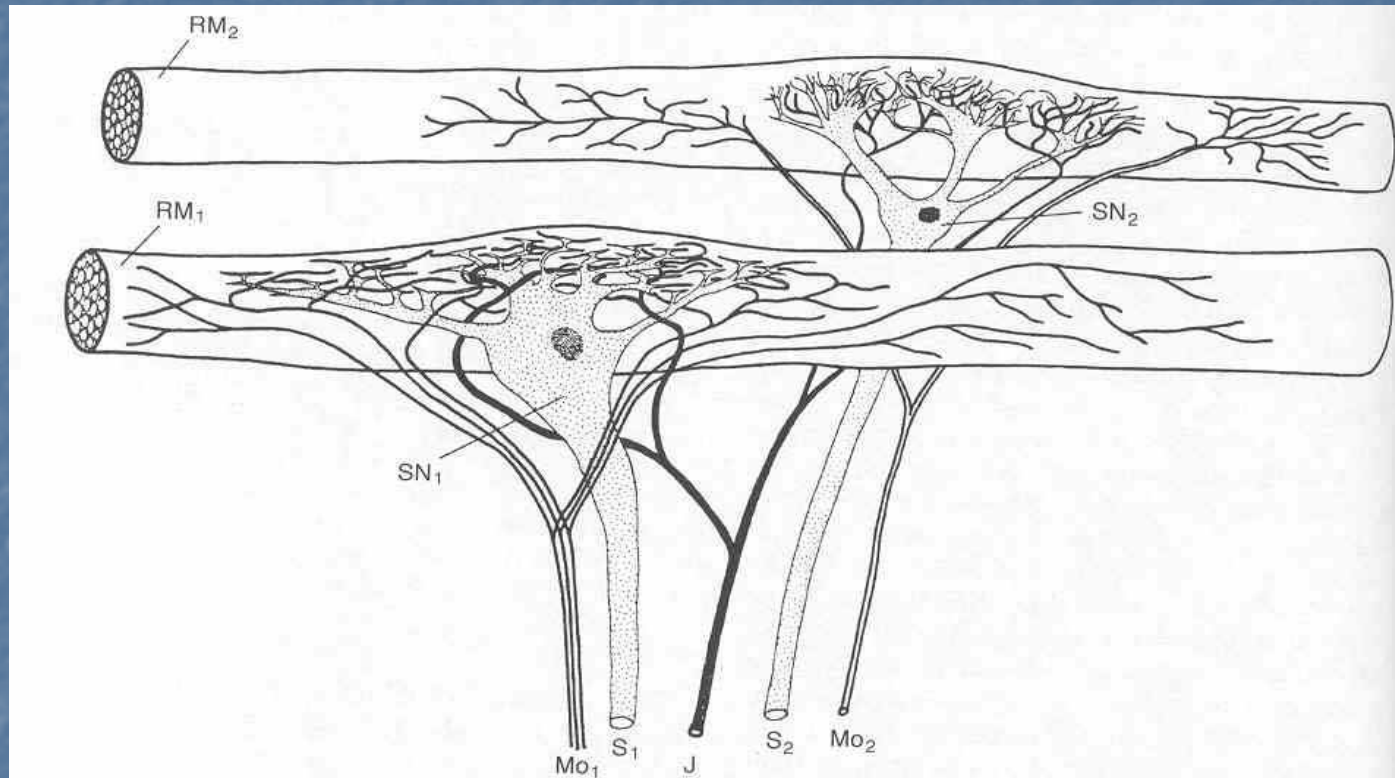
**Figure 6.3** (a) The figure shows the brushwork of sensilla at the articulation of the second leg of the cockroach, *Periplaneta americana*. The thick cuticle of the pleuron (pl) thins to a delicate articular membrane and then thickens again to form the cuticle surrounding the coxa (cx), the first segment of the leg. The brush of sensilla forms a hairplate (hp). From Pringle, 1938





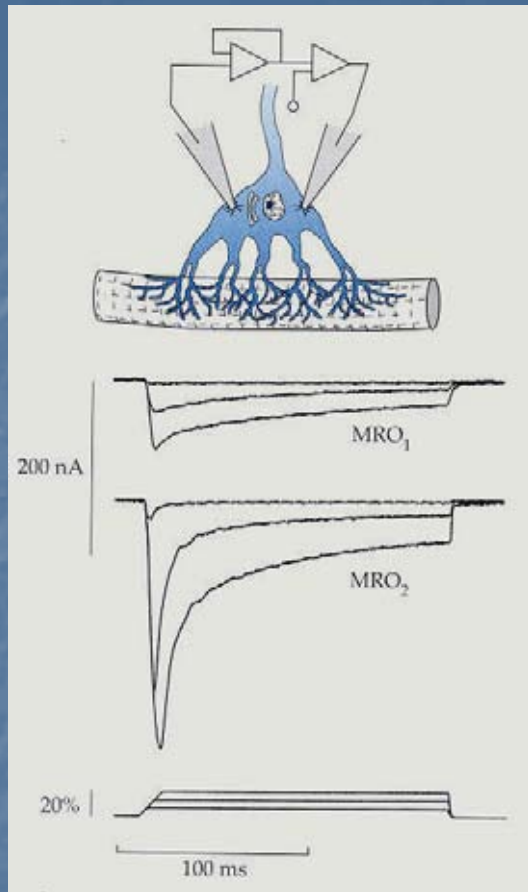
Plošky hmatových chlupů

Aktivní zvířata potřebují informace o poloze těla a končetin  
S exoskeletem odlišně od endoskeletu



**Figure 6.1** Schematic drawing of the stretch receptors in the abdominal segments of the crayfish, *Astacus fluviatilis*. RM1, RM2 = receptor muscles 1 and 2. SN1 = slow adapting sensory neuron; SN = fast adapting sensory neuron; S1, S2 = sensory fibres; Mo1 = three thin motor fibres to RM1; Mo2 = thick motor fibre to RM2; J = inhibitory fibre. From *Handbook of Physiology*, Section 1, Volume 1, *Neurophysiology* (1959), p. 378. Reproduced by permission of The American Physiological Society

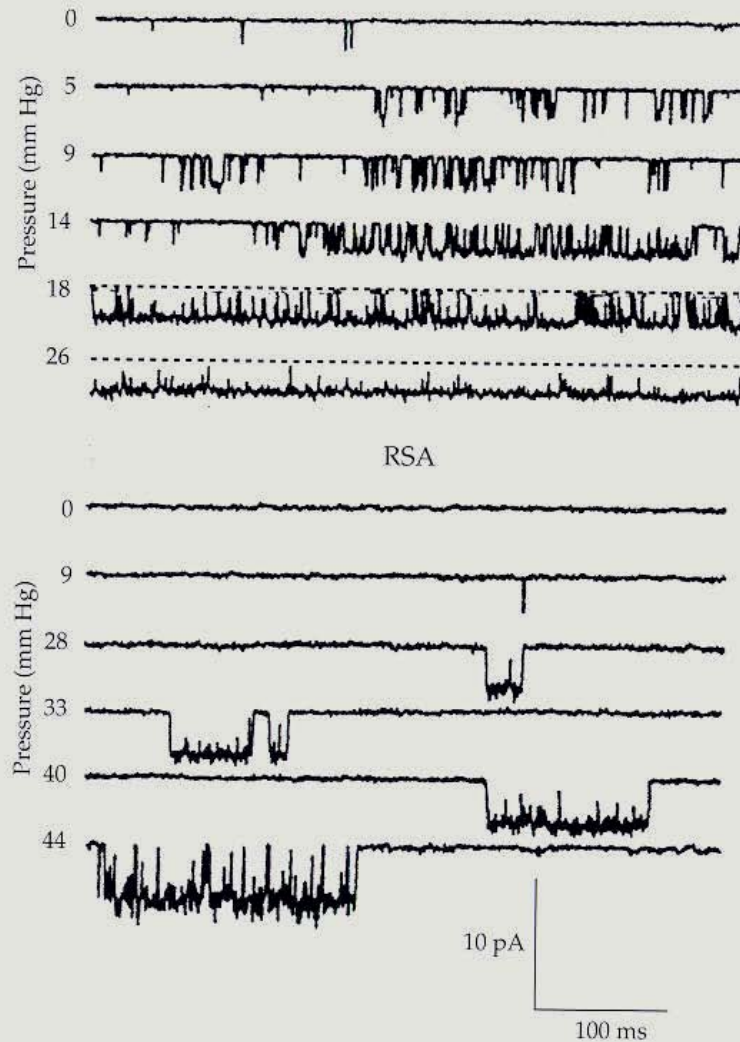
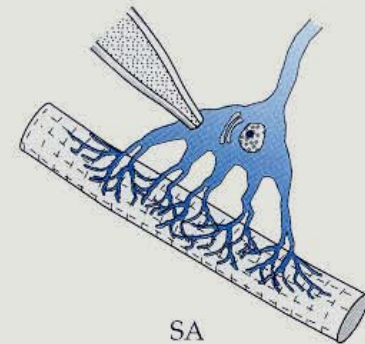
Svalová propriorecepce raka, pod pokožkou larev hmyzu  
Jiný typ recepční buňky – multipolární neuron s dendrity plnými mikrotubulů



**Figure 5.10**

**Single-channel recordings from crayfish stretch receptors**

On-cell patch recordings made from the cell body and main dendrites of stretch receptors. Channel openings were produced as in Figure 3.4 by the direct application to the patch pipette of suction from a calibrated pressure transducer. The amplitude of suction is given in units of millimeters of mercury (Hg). Pressure was applied continuously for the duration of each record. Patches were voltage-clamped at the resting membrane potential (for SA) and 50 mV negative to the resting membrane potential (for RSA). (From Erxleben, 1989.)

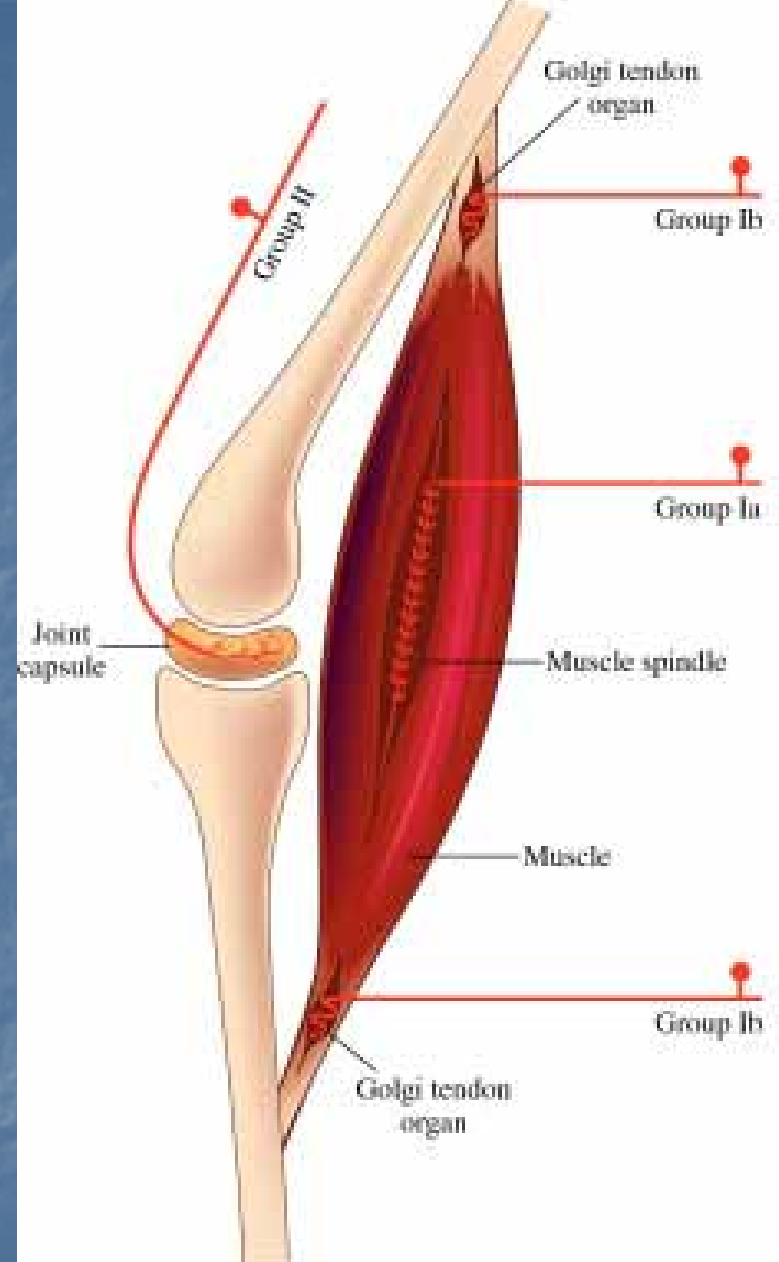


Patch clamp a řízení tlaku v pipětě

Dost velké pro elektrofyzologii  
V- clamp

Svalová propriorecepce raka

Propriorecepce u endoskeletu  
soustředěna na  
Svalová vřeténka  
Šlachová tělíska  
Spolu se zrakem a kožním  
čítím a vestibulárním aparátem  
dodávají obraz o poloze těla



# Život bez „obrazu o vlastním těle“

## 12.1 Living Without Kinesthesia

Close your eyes. Now cross your legs. Tap your foot. Raise your left hand. Touch your nose with your right index finger. These tasks shouldn't be too difficult (unless you're just back from a night on the town).

But at the age of 19, Englishman Ian Waterman suffered a viral infection and lost the ability to do these things. Not because he was paralyzed: his muscular control was unaffected by the infection. What was affected was his sense of **proprioception**, a word that literally means "sense of self," but is used by psychologists to describe our perception of where our body parts are. Proprioception, like its sister sense **kinesthesia**, is driven by somatosensory receptors in our muscles and joints, and the nerves connecting Waterman's proprioceptive receptors to his brain had been cut off.

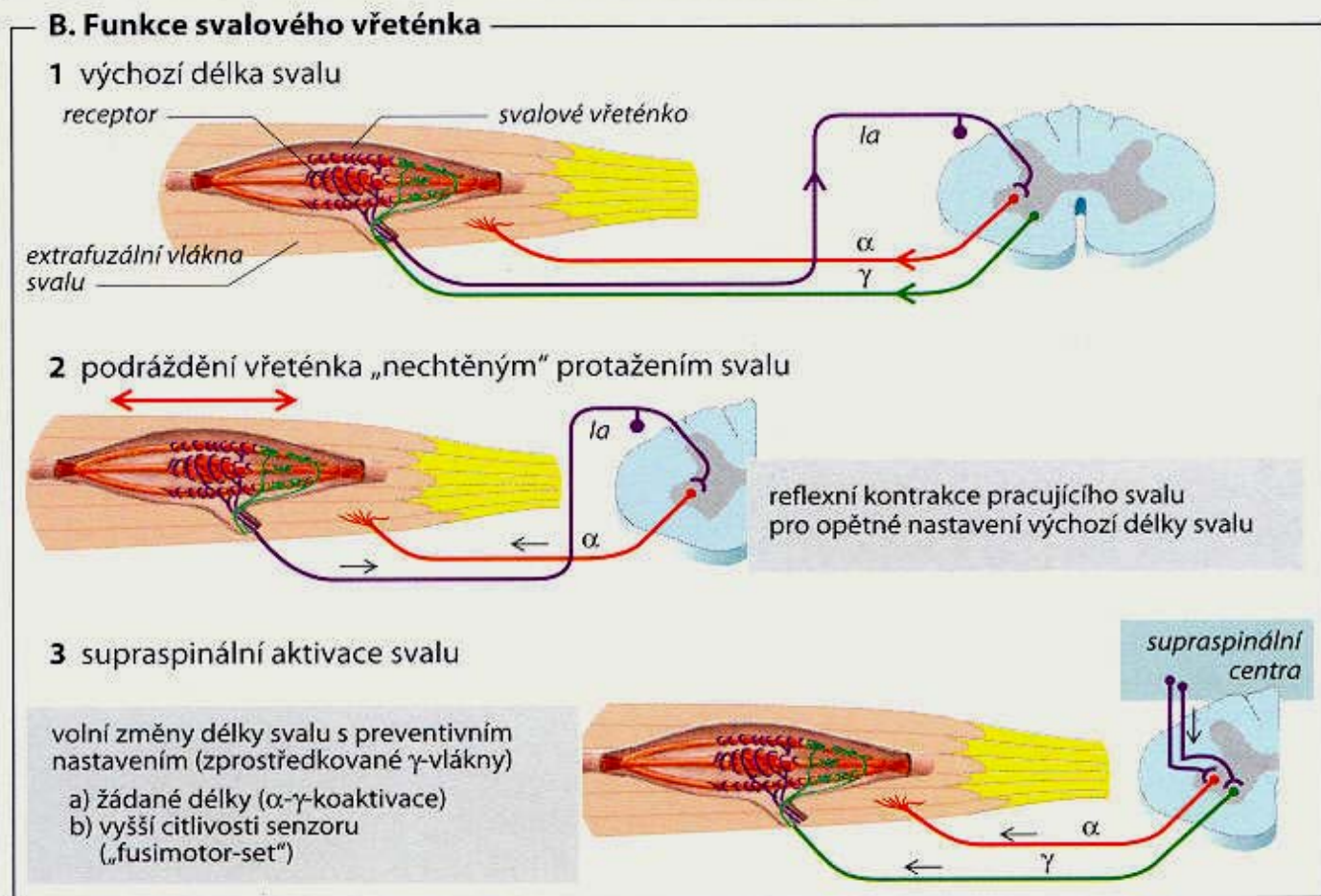
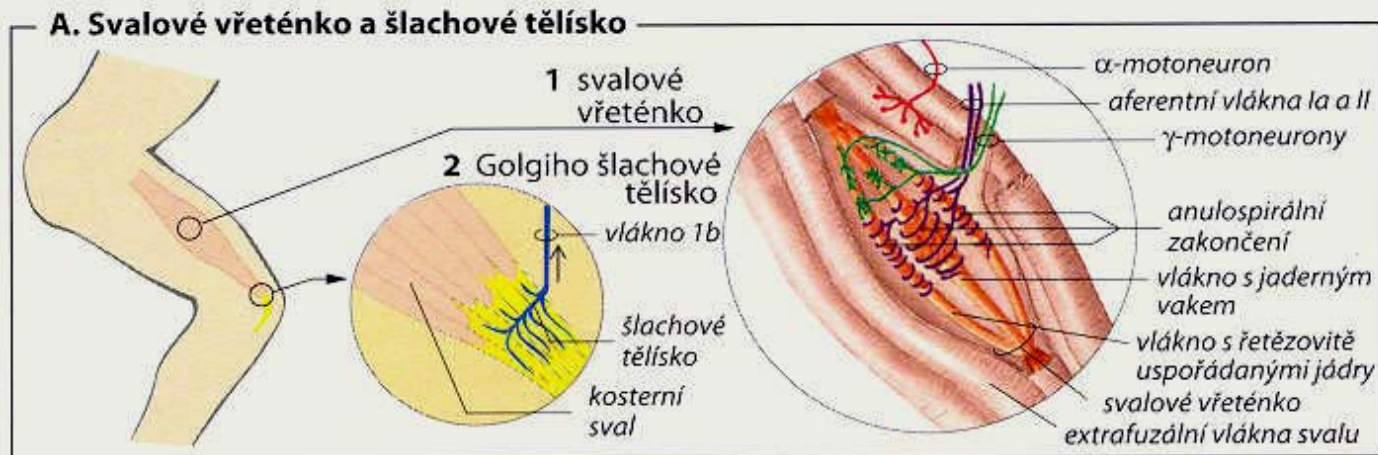
Waterman was initially confined to a wheelchair because of his condition, but over a number of years he eventually learned to use his eyes to tell him what his proprioceptive receptors no longer could. He is able to walk now because he watches his legs move and puts one foot down when it moves in front of the other.

Waterman's case is described in a book called **Pride and a Daily Marathon**, by his physician, neurologist Jonathan Cole. A summary of the case is available in an archived article in the *APA Monitor*, linked below.

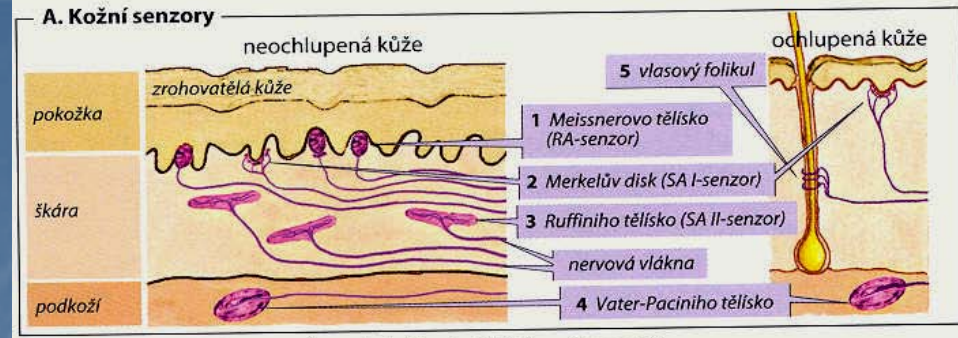


S.v.- regulace délky  
Svalu  
Eferentní inervace

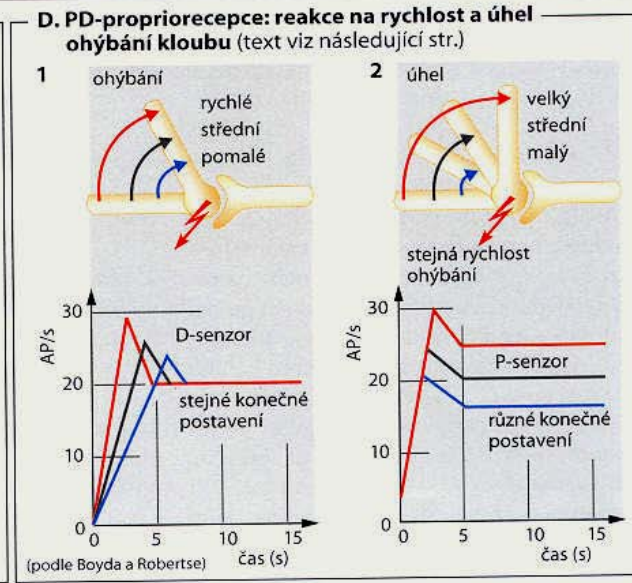
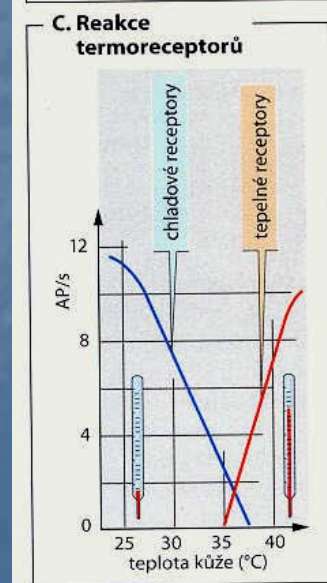
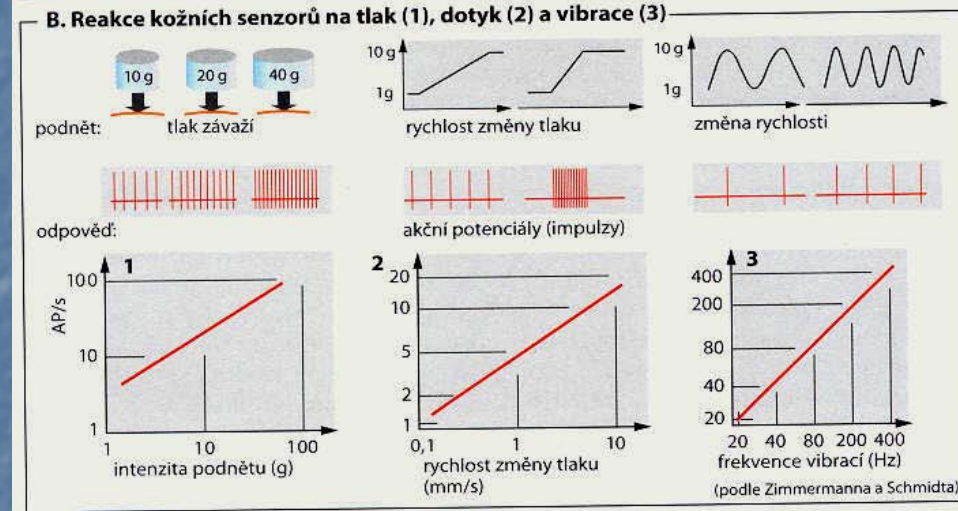
Š.ř. – ochrana před  
přepětím



# Taktilní kožní receptory – smysl pro dotek a hmat, teplotu a bolest



# Tlak, dotyk, vibrace. Různá adaptace receptorů



**Mechanoreceptors**

Pacinian corpuscle  
Touch; vibration  
Rapid adaptation  
Myelinated axon

Meissner corpuscle  
Touch; vibration  
Rapid adaptation  
Myelinated axon

Ruffini corpuscle  
Touch; pressure  
Slow adaptation  
Myelinated axon

Merkel disk  
Touch; pressure  
Slow adaptation  
Myelinated axon

Hair follicle receptor  
Hair displacement  
Rapid adaptation  
Myelinated axon

**Thermoreceptors**

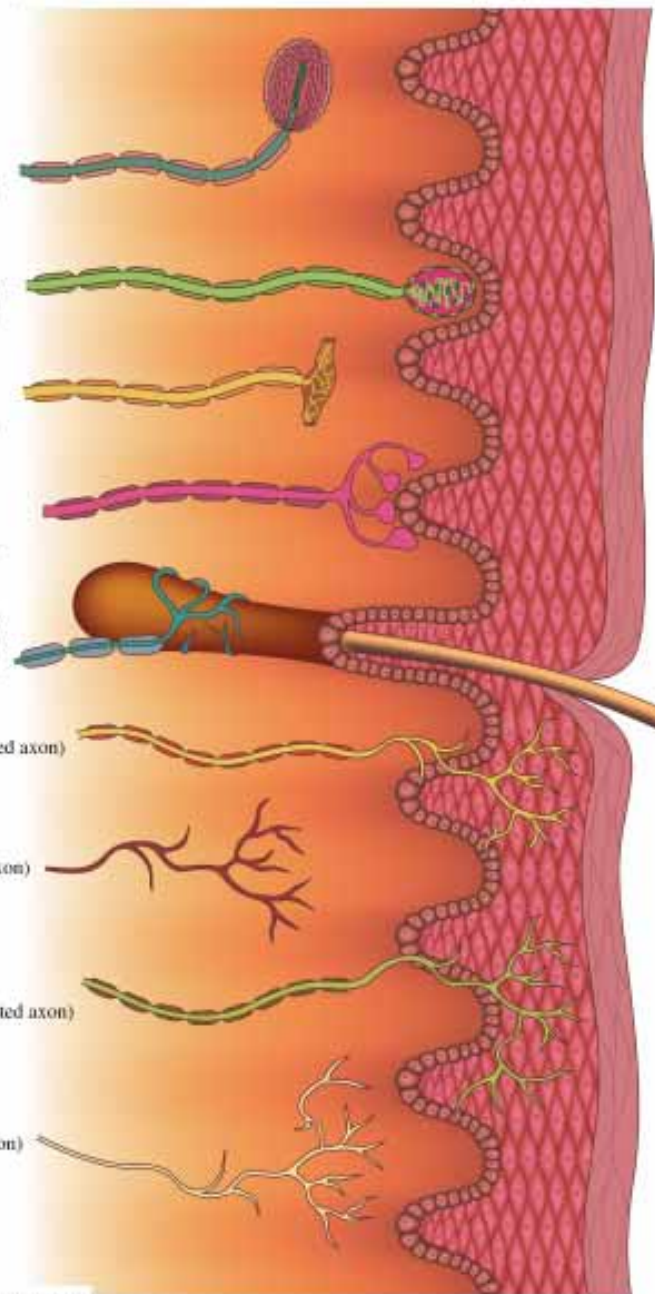
Cold (smaller myelinated axon)

Warm (unmyelinated axon)








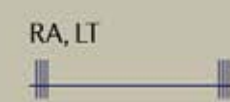













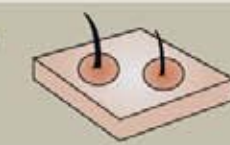
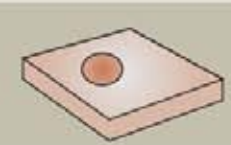
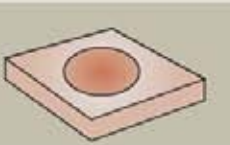
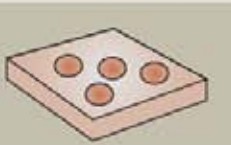
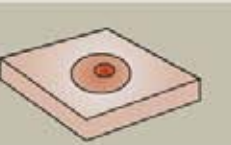
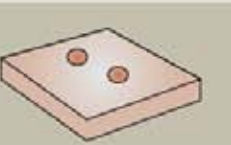
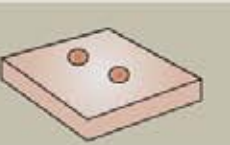
**Nociceptors**

Rapid (smaller myelinated axon)

Slow (unmyelinated axon)





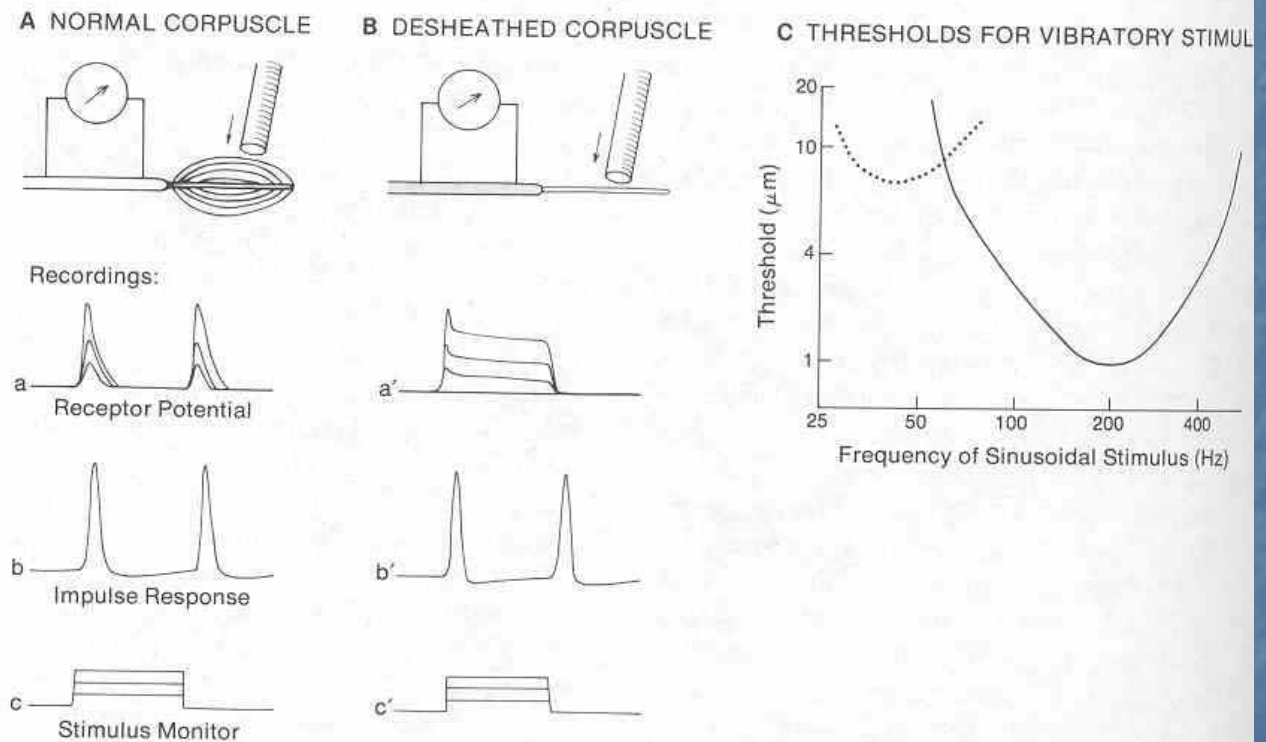
Receptor subtype	Hair follicles	Meissner corpuscle	Pacinian corpuscle	Merkel cell-neurite complex	Ruffini corpuscle	C-fibre LTM	Mechano-nociceptor Polymodal nociceptor
<b>Skin stimulus</b>	Light brush 	Dynamic deformation 	Vibration 	Indentation depth 	Stretch 	Touch 	Injurious forces 
<b>Afferent response</b>	RA, LT 	RA, LT 	RA, LT 	SA, LT 	SA, LT 	SA, LT 	SA, HT 
<b>Stimulus</b>							
<b>Receptive field</b>							
<b>Perceptual functions</b>	Skin movement	Skin motion; detecting slipping objects	Vibratory cues transmitted by body contact when grasping an object	Fine tactile discrimination; form and texture perception	Skin stretch; direction of object motion, hand shape and finger position	Pleasant contact; social interaction	Skin injury; pain

**Velikost receptivních polí**  
 Pomalá adaptace na čití tvaru – co držíme, co čteme Brailleovým písmem. Rychle adaptující – nízkofrekvenční kmity a vibrace – struktura a forma – lépe poznáme předmět a povrch, když s ním v ruce pohybujeme. Paciniho na vysoké frekvence – náhlé podráždění – jemné závany vzduchu.

# Paciniho tělísko a vliv kapsule na adaptaci

274

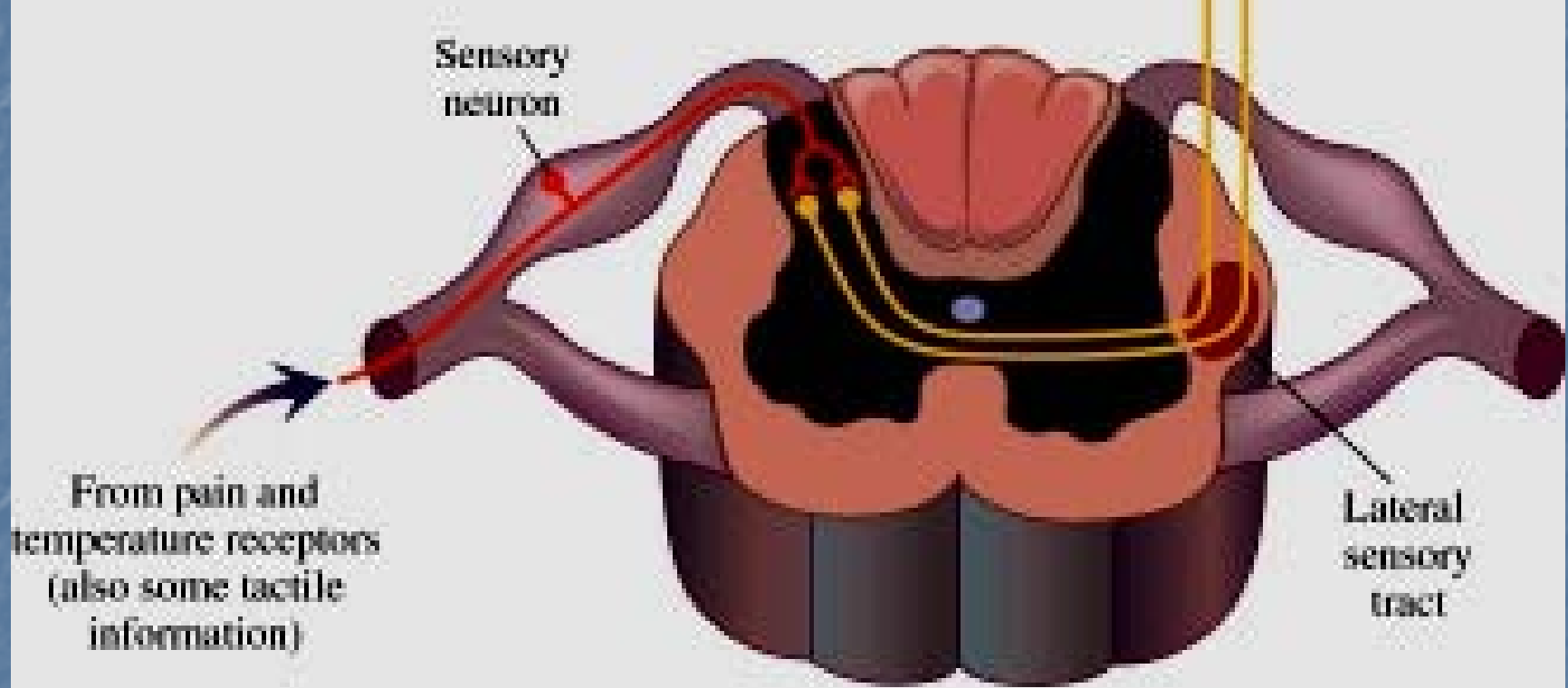
## SENSORY SYSTEMS



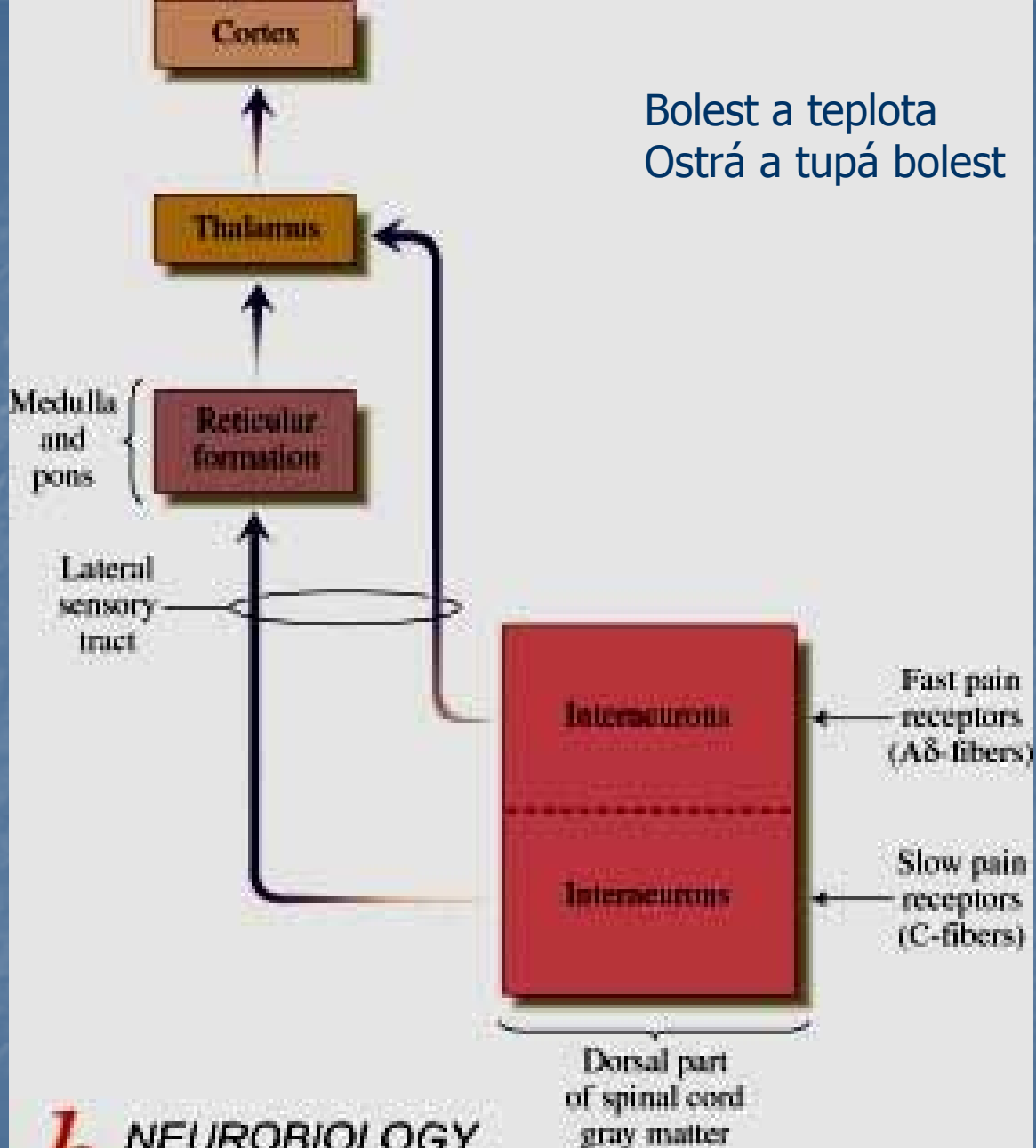
**Fig. 12.5** Experimental analysis of transduction in the Pacinian corpuscle. **A.** Diagram showing probe for stimulating the intact corpuscle, and recording from the nerve. (*Below*) recordings of the receptor potential and impulse discharge. **B.** Repeat of experiment after removal of lamellae. **C.** Sensitivity of Pacinian corpuscle to vibratory stimulation at different frequencies. Sensitivity of Meissner's corpuscle is shown by dotted line. (**A, B** based on Loewenstein, 1971; **C** modified from Schmidt, 1978)

Bolest a teplota

Vstup dorzálními kořeny a laterálním sensorickým traktem do mozku

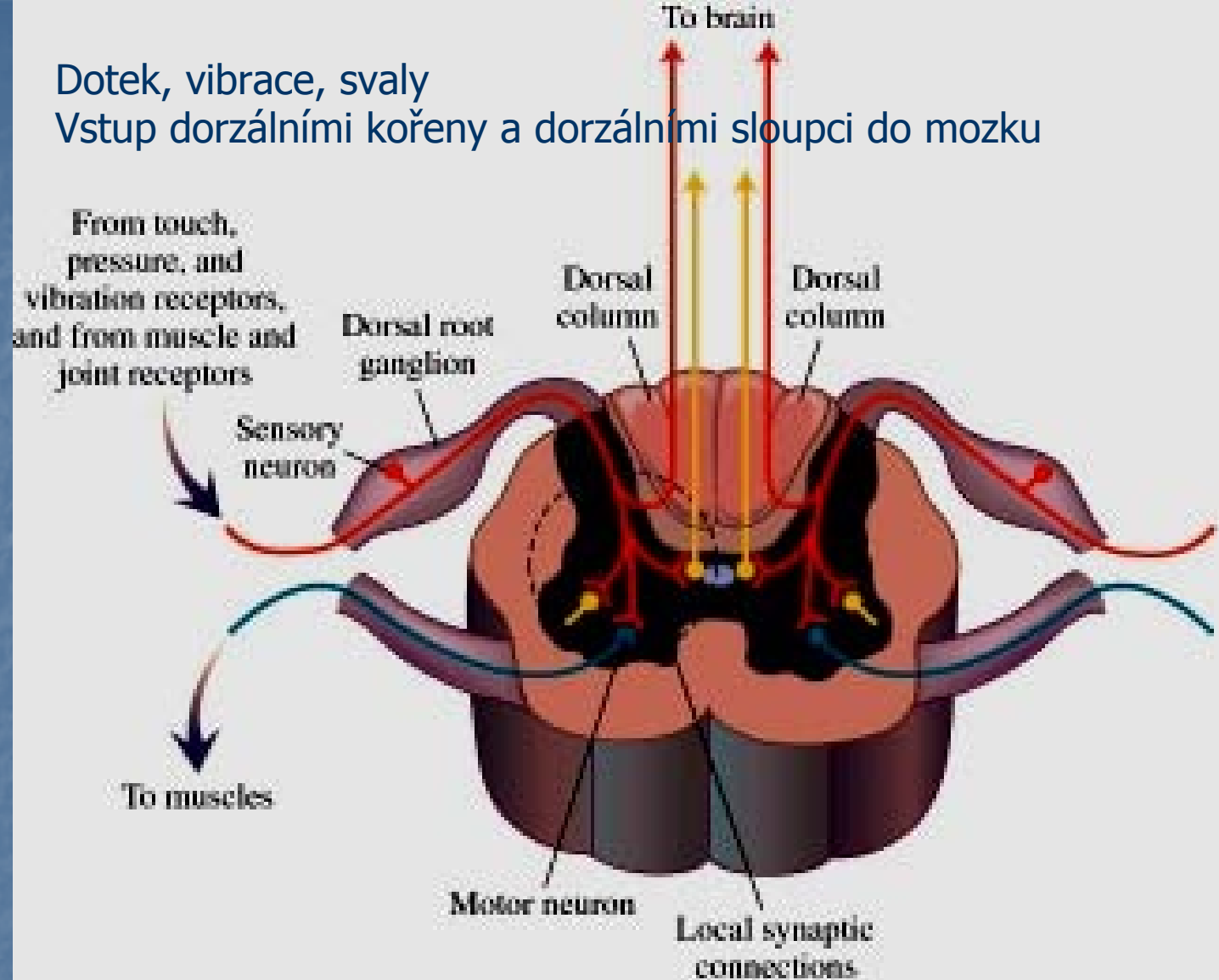


Bolest a teplota  
Ostrá a tupá bolest



Dotek, vibrace, svaly

Vstup dorzálními kořeny a dorzálními sloupci do mozku



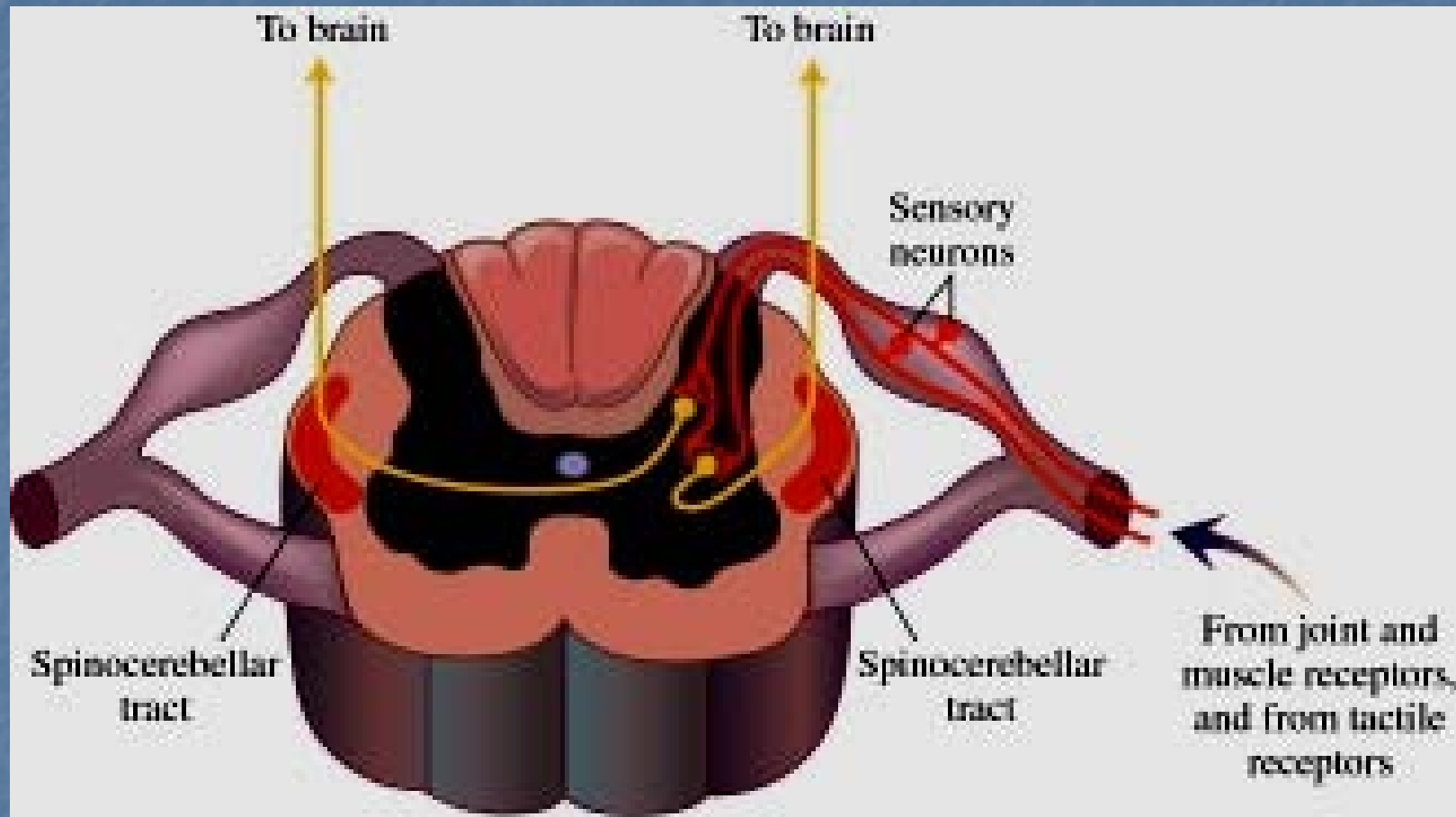
*b*

NEUROBIOLOGY  
Gary G. Matthews

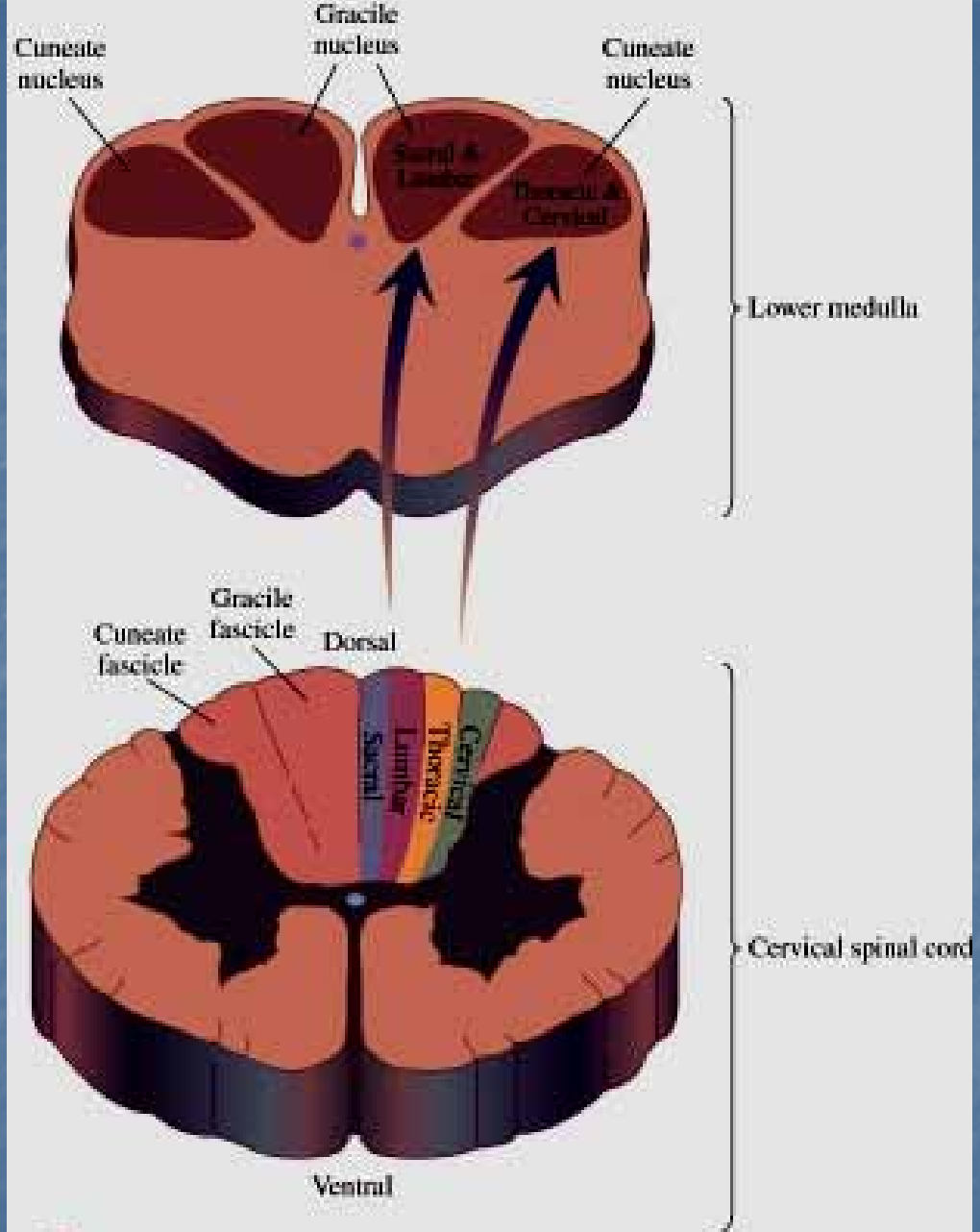
Blackwell  
Science

Proprioreceptory

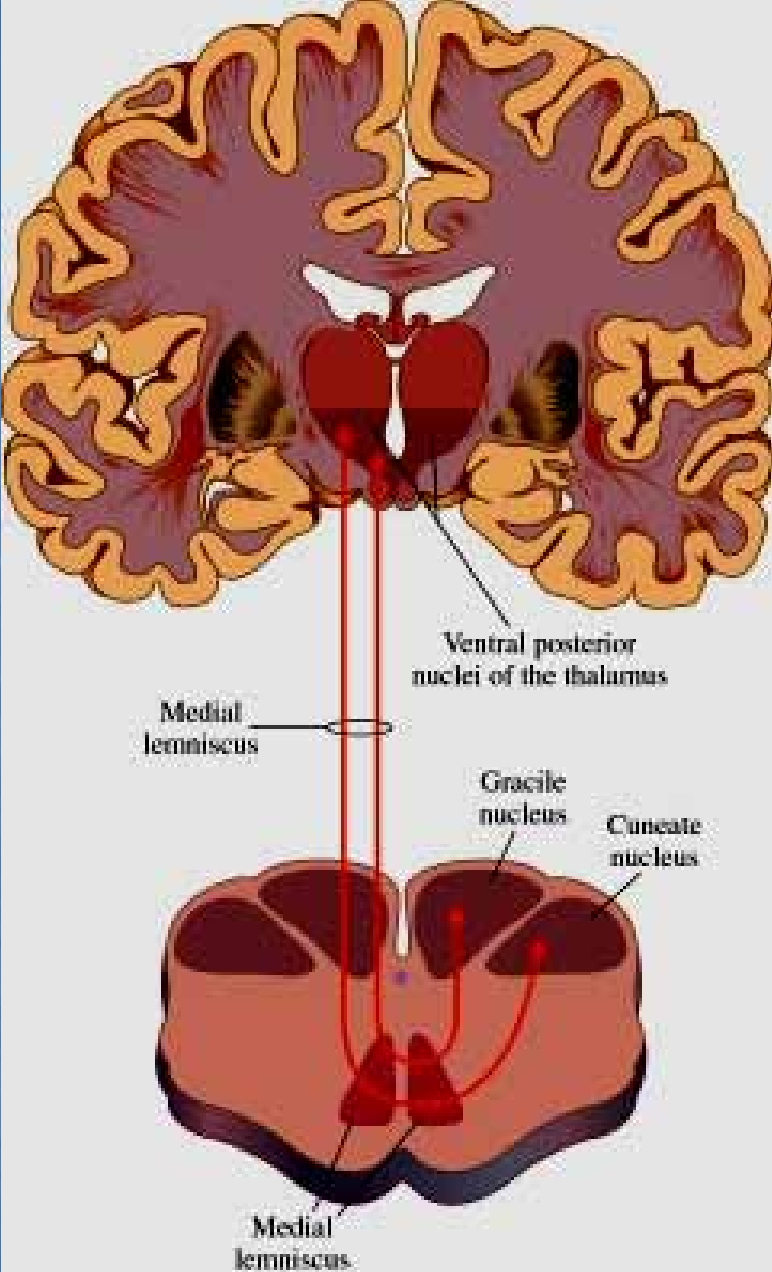
Vstup dorzálními kořeny a spinocerebrálním traktem do mozku



# Somatotopie Sensorické dráhy

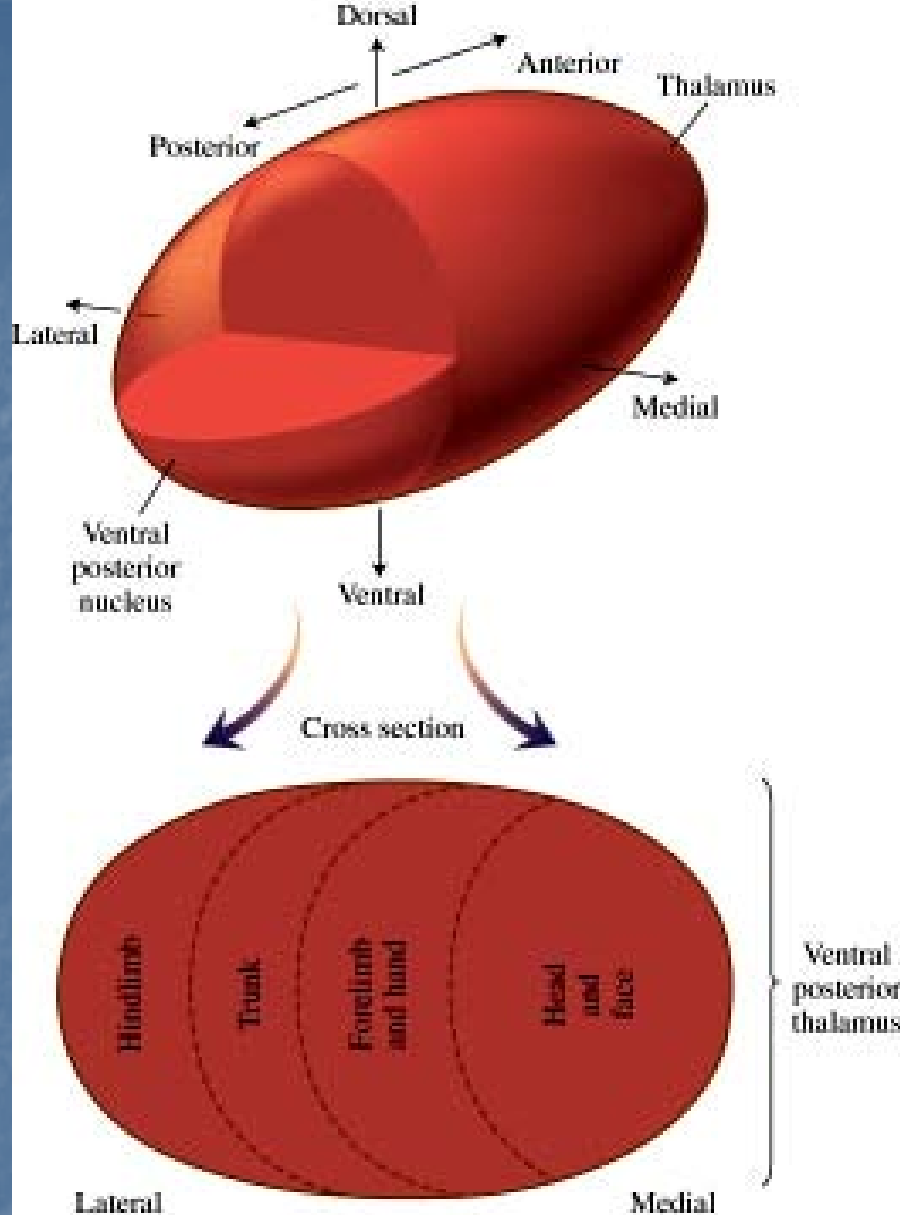


Somatotopie  
Vstup do talamu

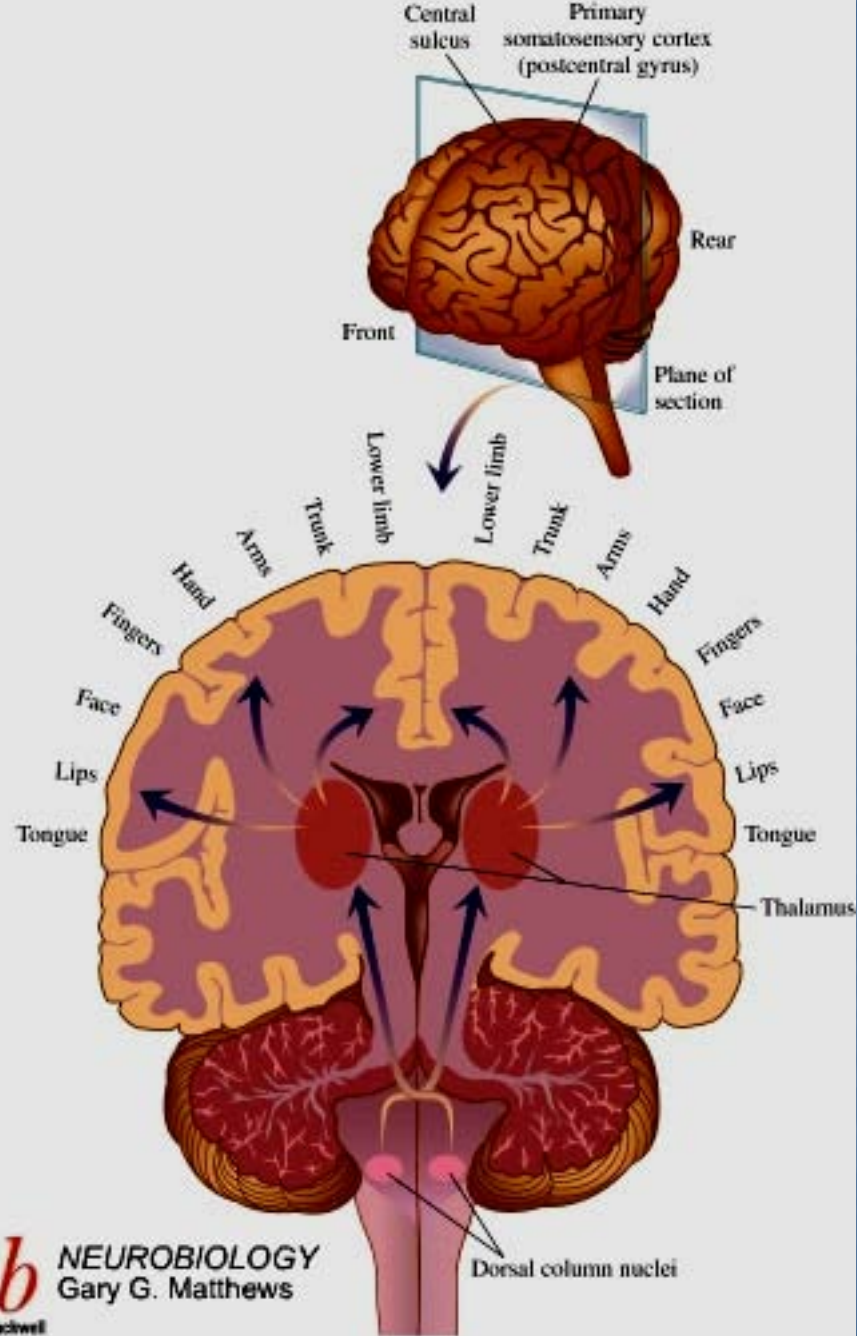




# Somatotopie talamu

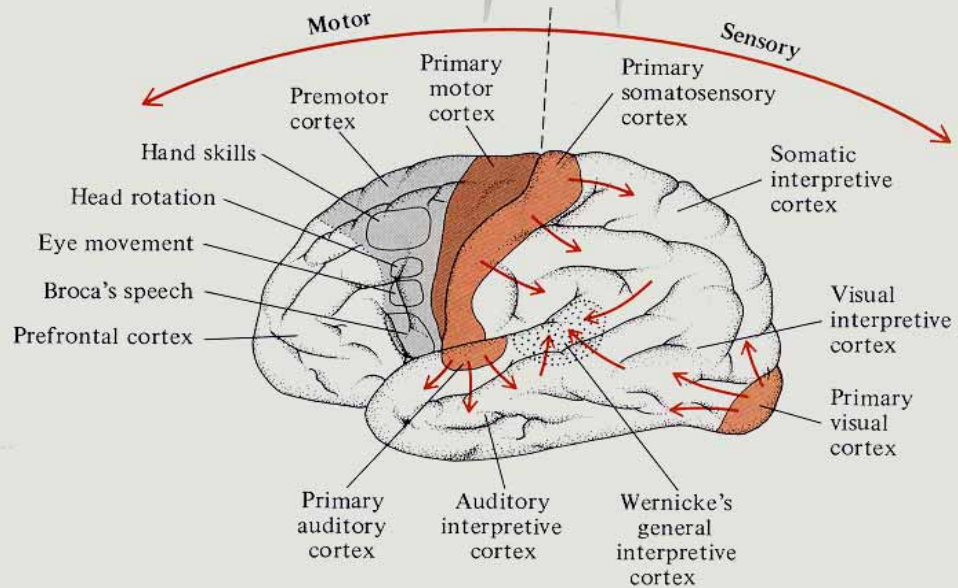
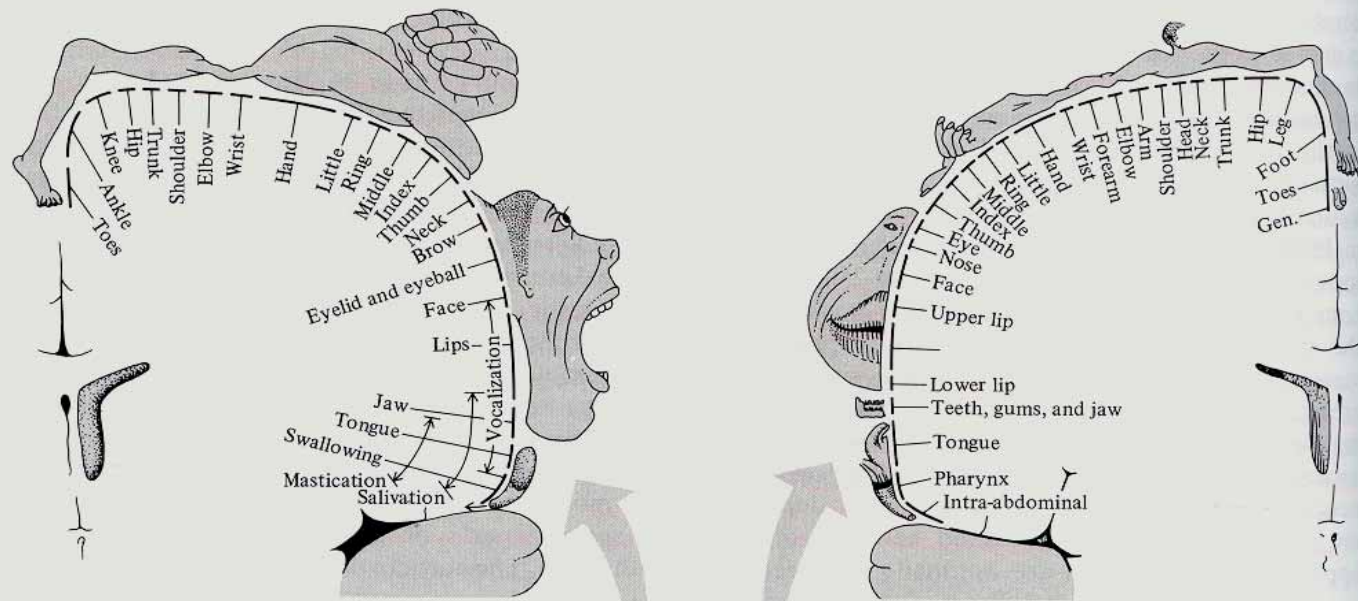


# Somatotopie somatosensorické kôry



# Somatotopie somatosensorické kůry

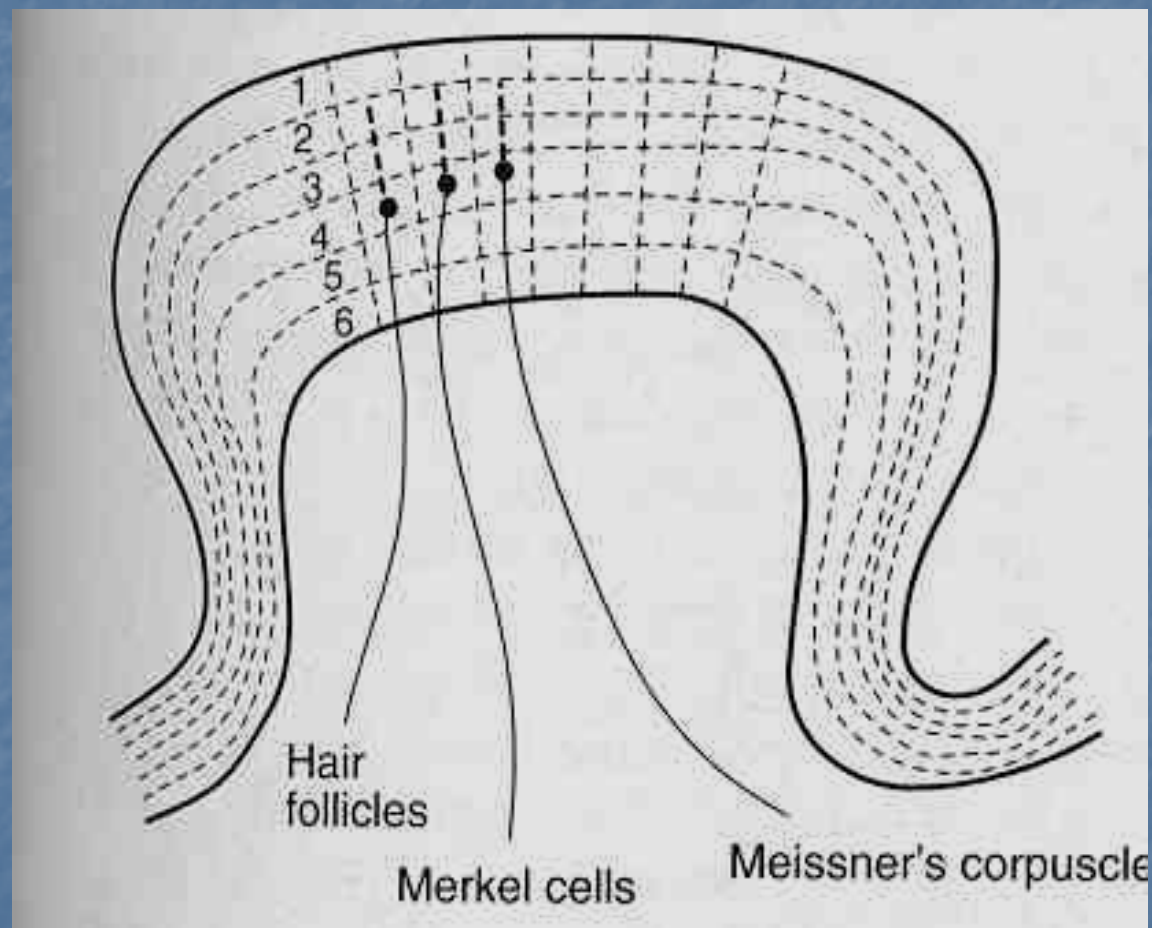
-Fantomová bolest



<http://sites.sinauer.com/wolfe3e/chap13/homunculusF.htm>

# Vertikální členění kortexu

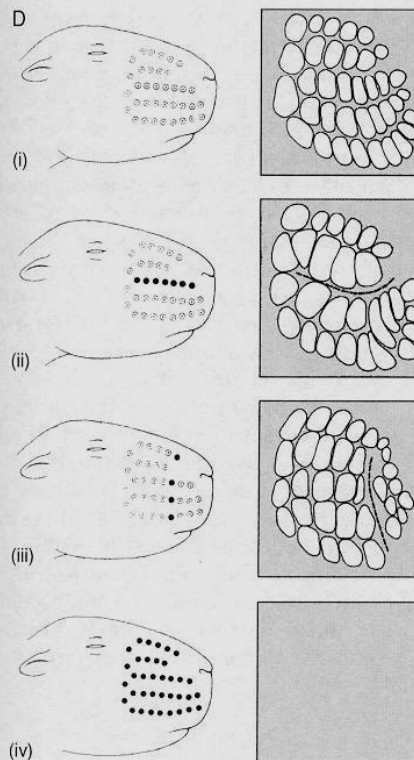
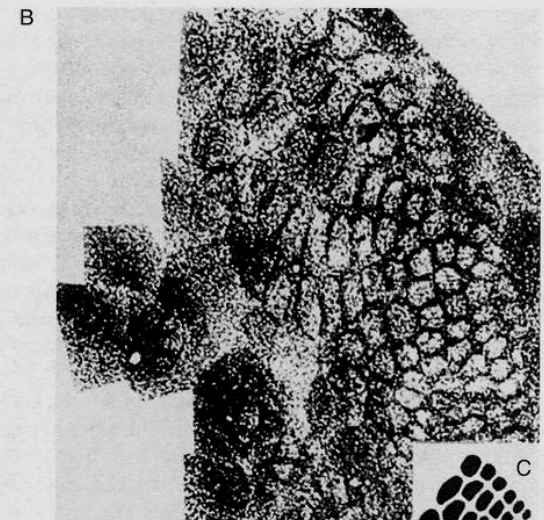
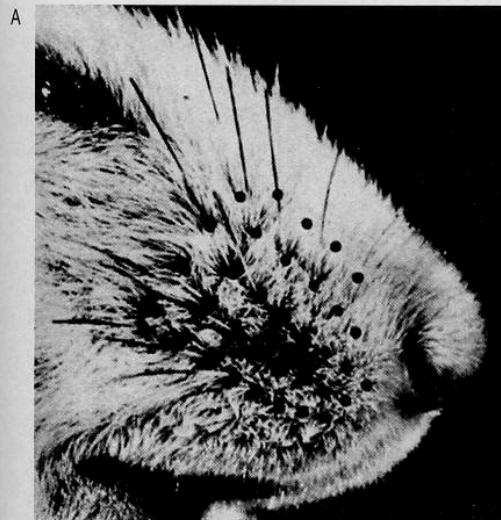
Sloupečky somatosensorické kůry odpovídající submodalitám



Plasticita  
somatosensorické kůry

Reprezentace se mění  
podle používání

Houslisté, slepci



**Figure 7.16** Mouse whisker barrels. (a) Head showing five rows of vibrissae. (b) Section of cortex showing 'barrels', each corresponding to one whisker. (c) Diagram to show the organisation of the whisker barrels. (d) Diagrams to show the effect of removing whiskers. (i) Full set of whiskers, full set of barrels; (ii) one row of whiskers removed, unaffected barrels grow into territory of unused barrels; (iii) one column of whiskers removed; again unaffected barrels colonise space left by missing barrels; (iv) total removal of whiskers; loss of all barrels. A, B, and C from Woolsey & van der Loos, 1970: with permission. D from Cowan, 1979: with permission