

Magnetika

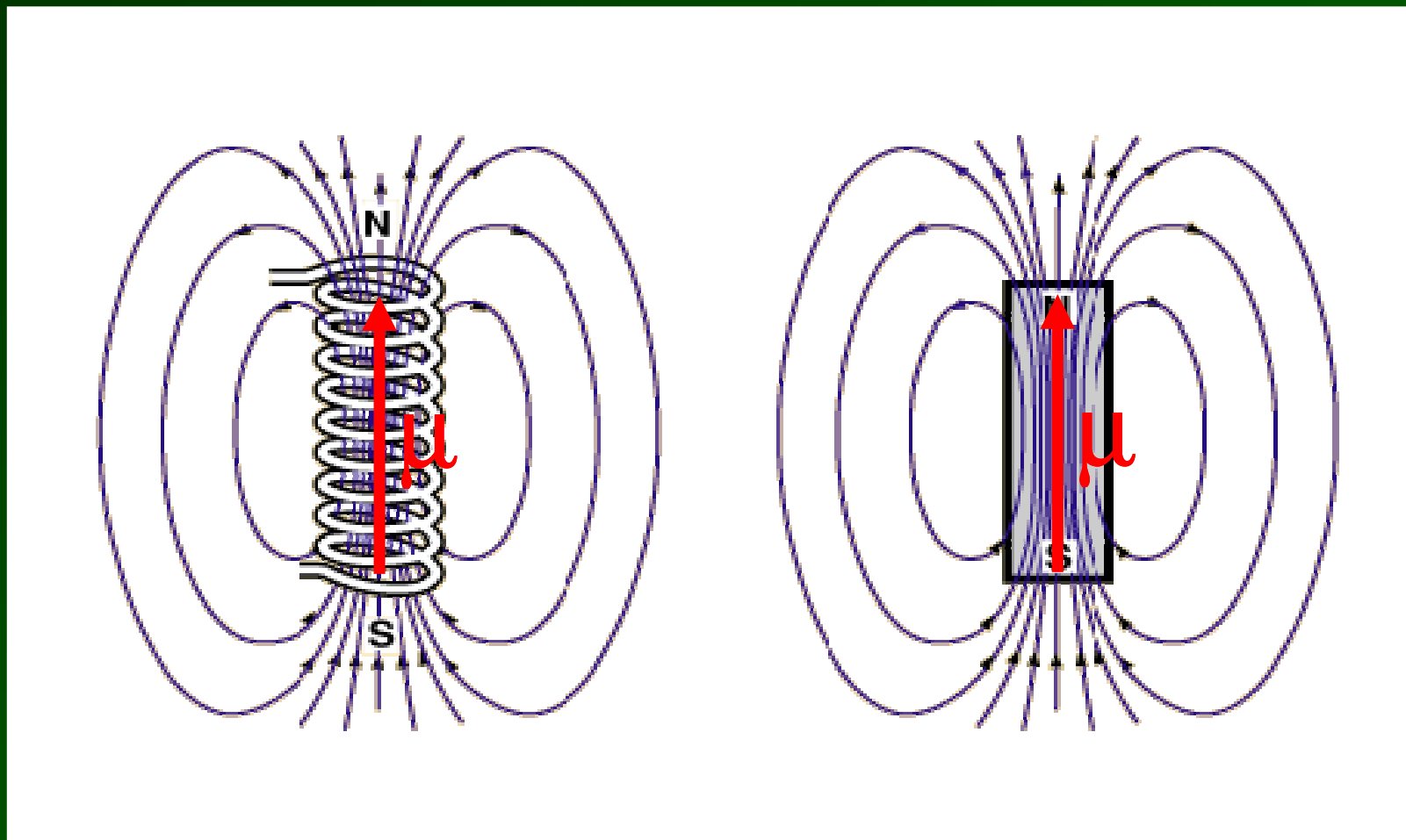

Chování magnetů v nehomogenním magnetickém poli



DIPÓL V HOMOGENNÍM POLI

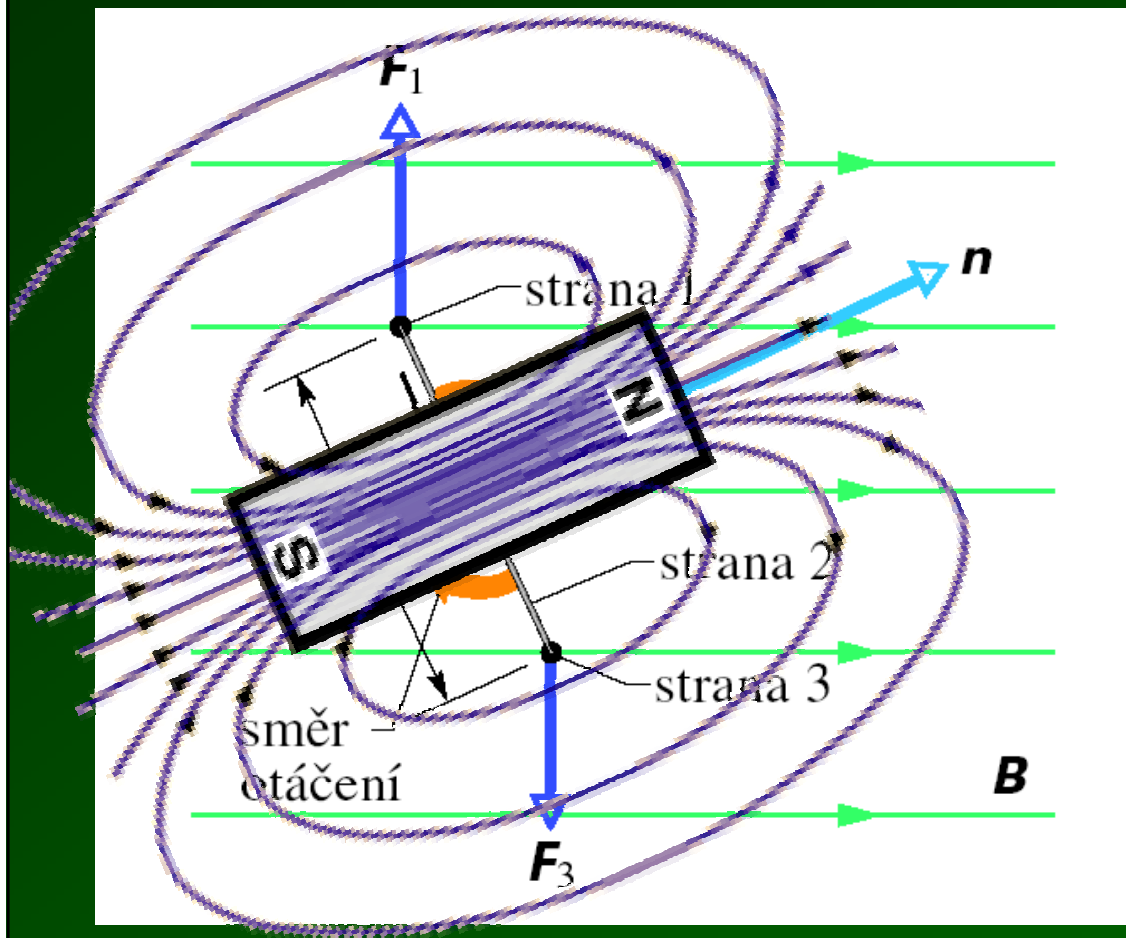

$$\vec{M} = \vec{\mu} \times \vec{B} \neq 0$$

$$\vec{F}_{\text{výsl}} = \sum \vec{F}_i = 0$$

DIPÓL V NEHOMOGENNÍM POLI

$$d\vec{F}_B = I d\vec{s} \times \vec{B}$$

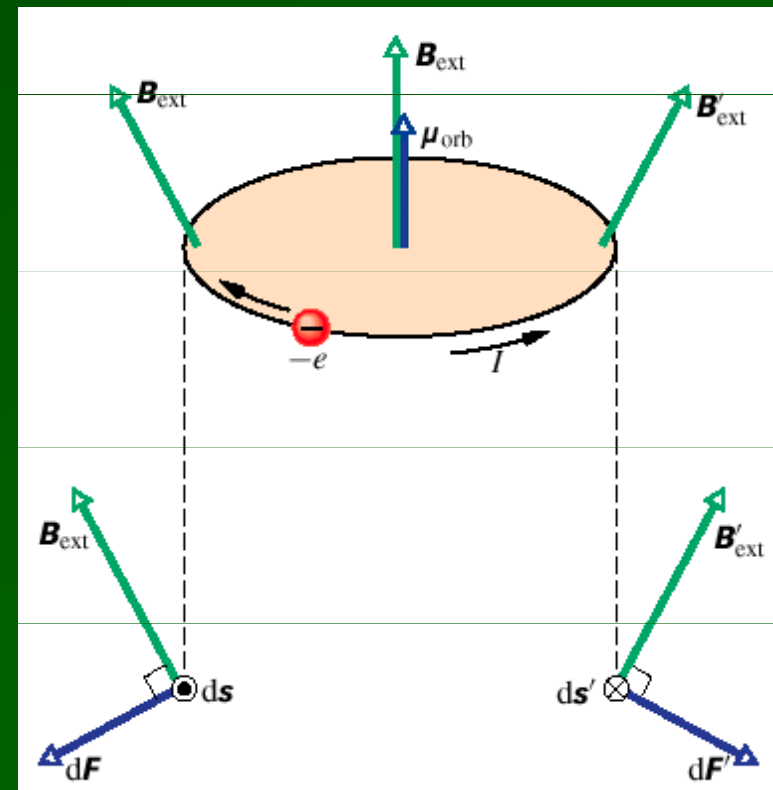
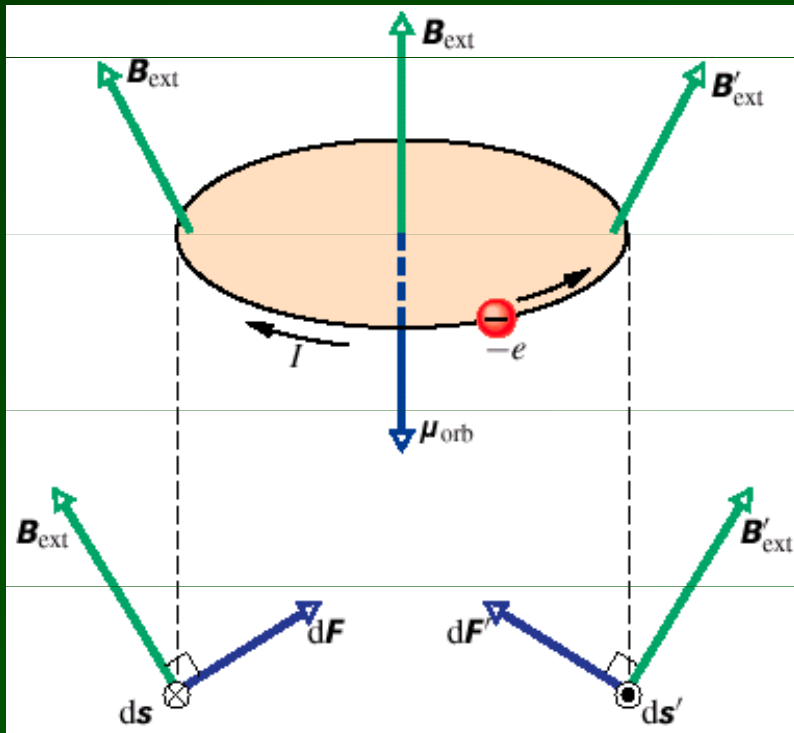
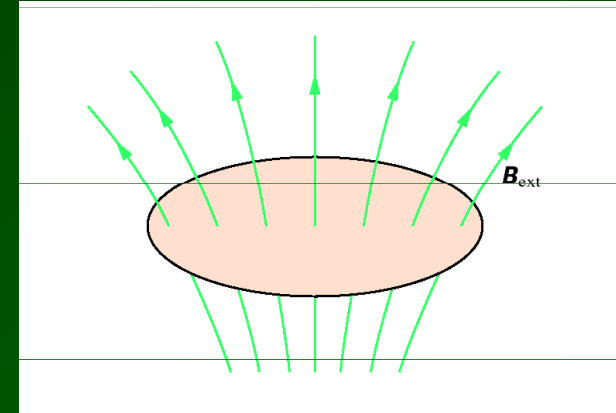
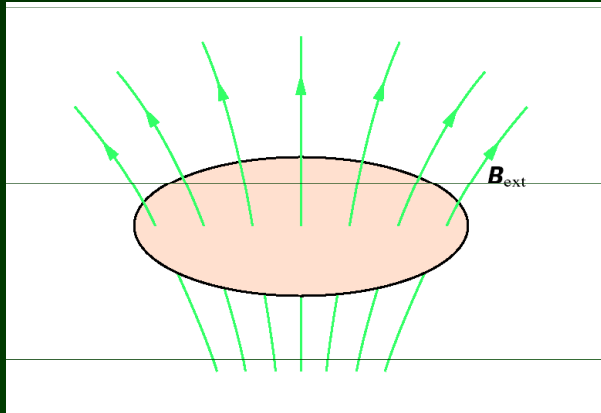

DIPÓL V NEHOMOGENNÍM POLI

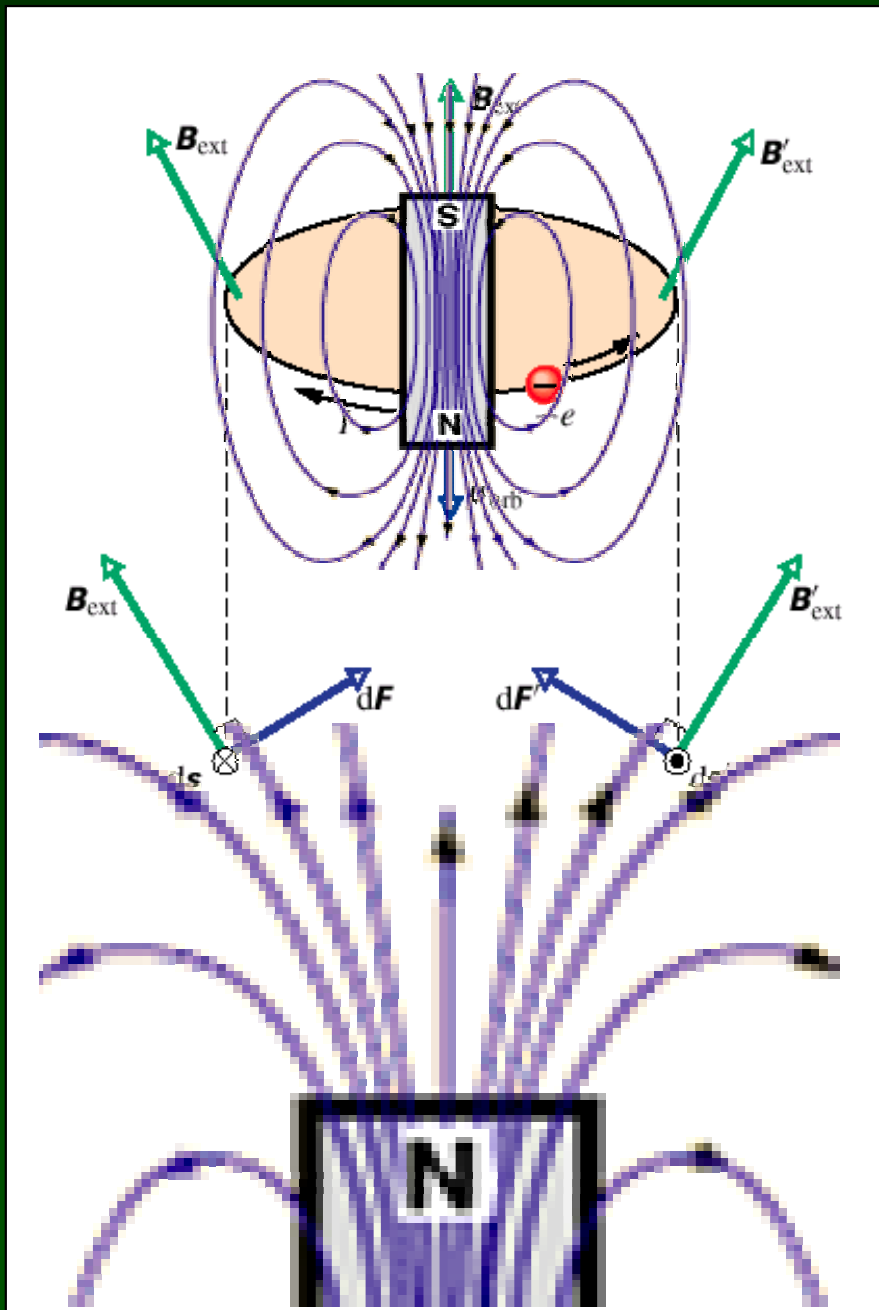

$$F_{x,y,z} = \vec{\mu} \cdot \text{grad } B_{x,y,z}$$

DIPÓL V NEHOMOGENNÍM POLI

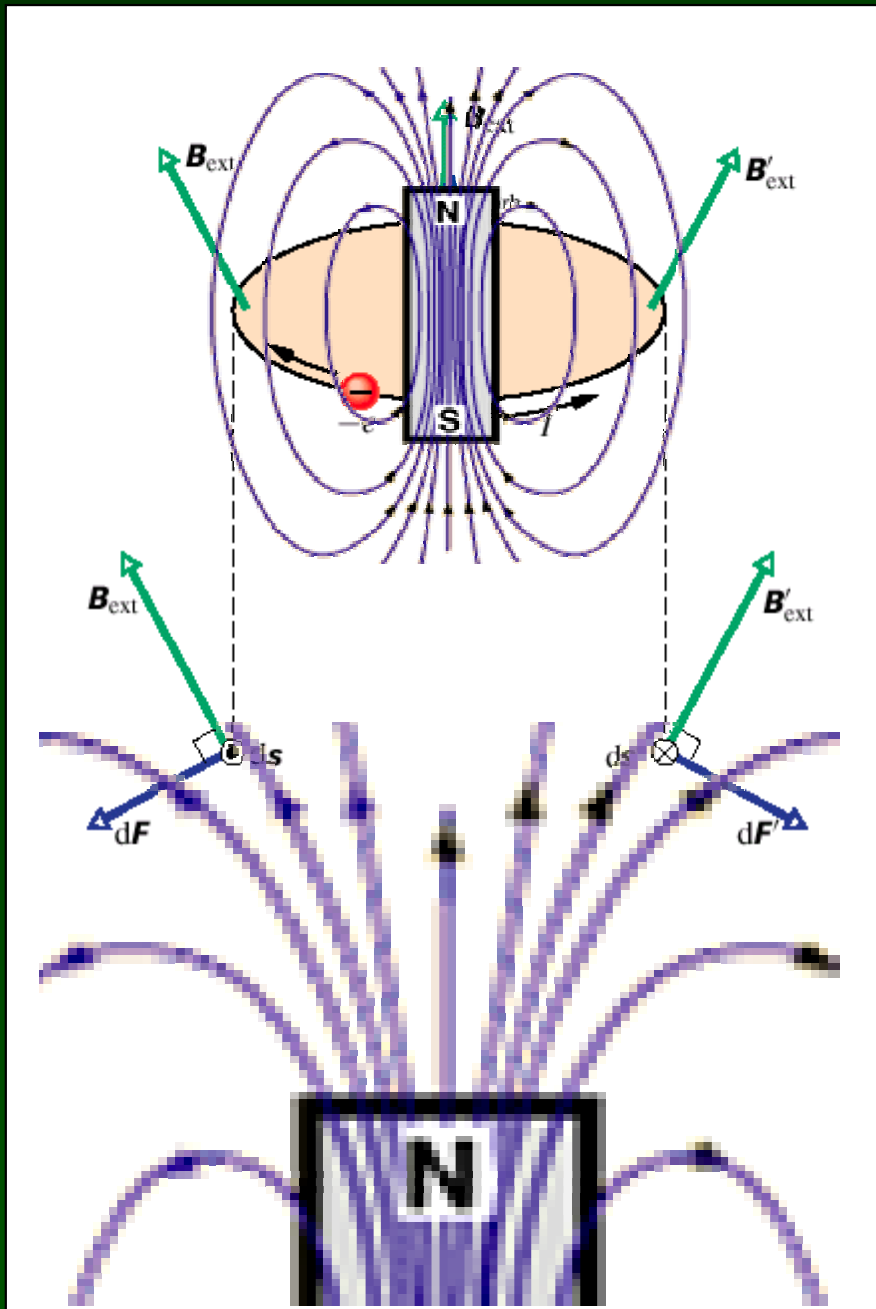

$$F_{x,y,z} = \vec{\mu} \cdot \text{grad } B_{x,y,z}$$

Dielektrikum

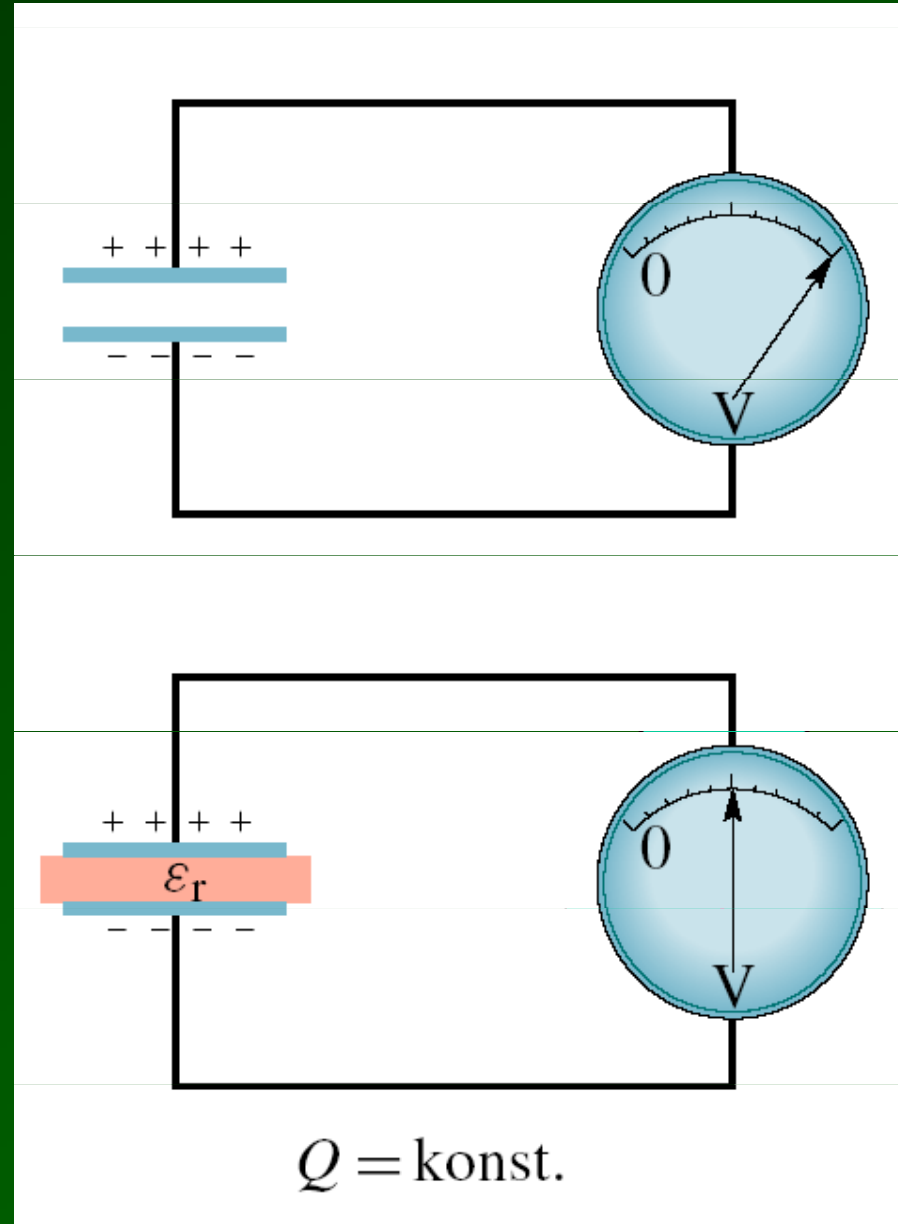

Dielektrika

Rozložení elektronů → elektrický dipól

Polární dielektrika

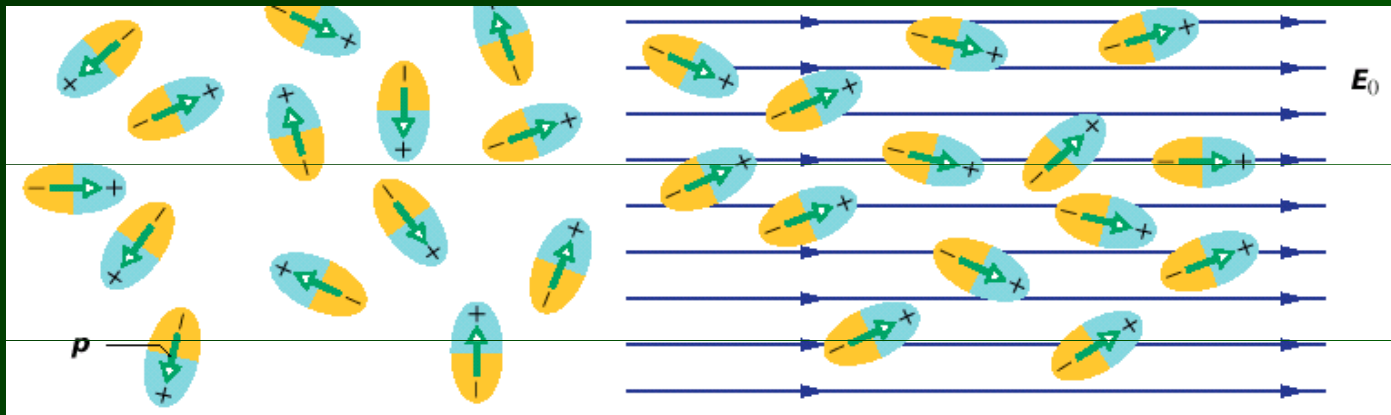

Nepolární dielektrika

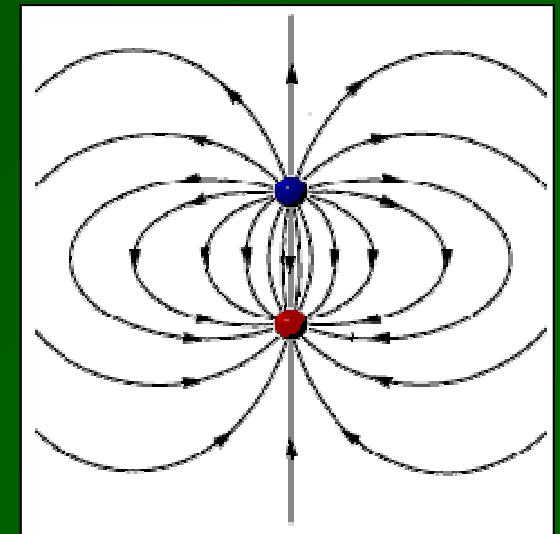
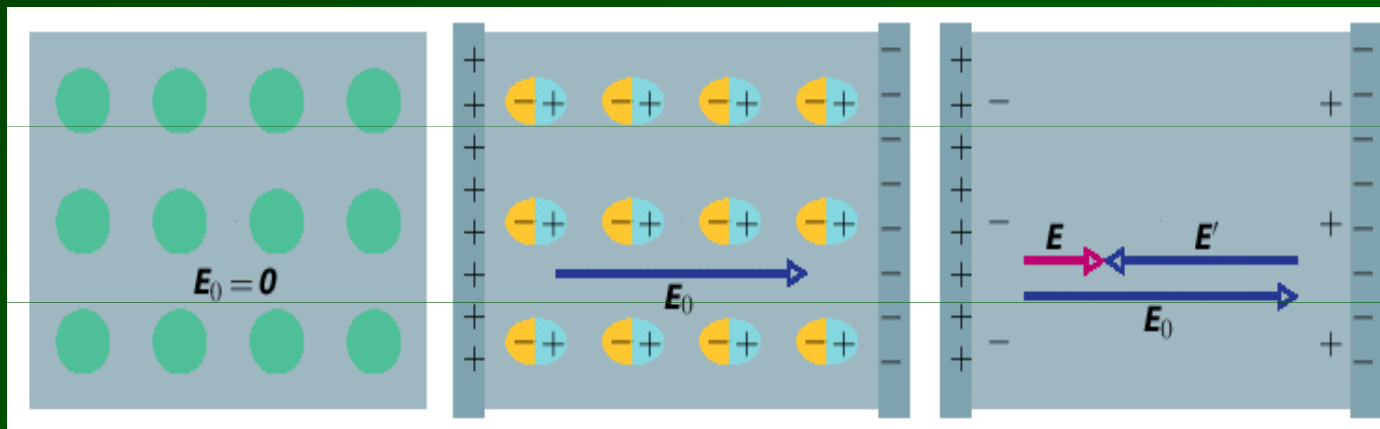

Magnetikum

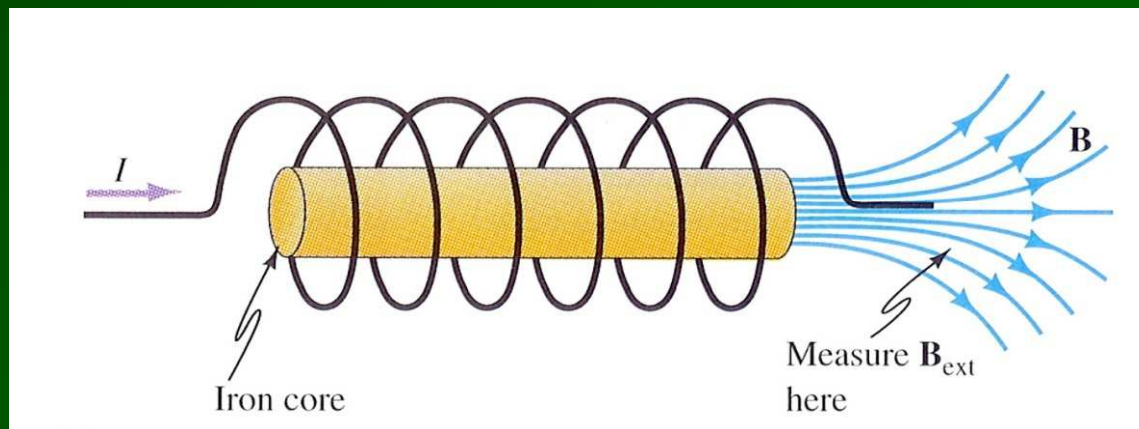
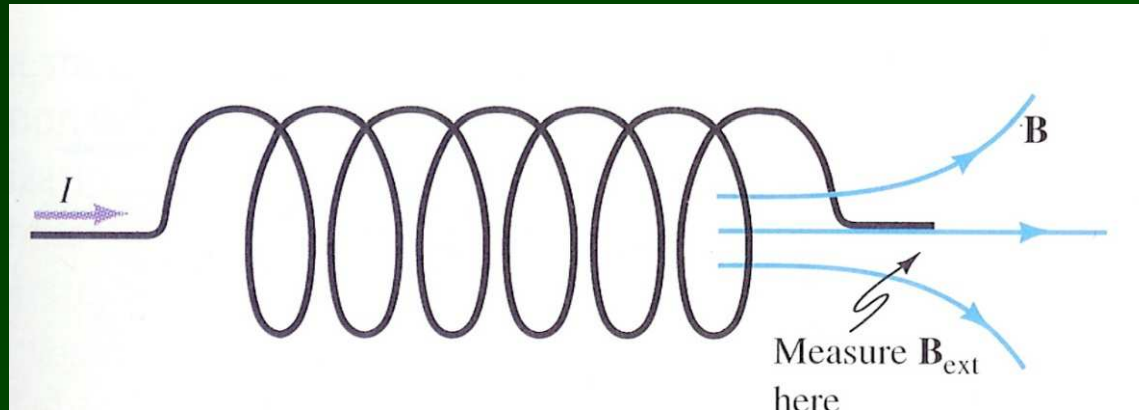

Magnetika

Pohyb elektronů → magnetický dipól

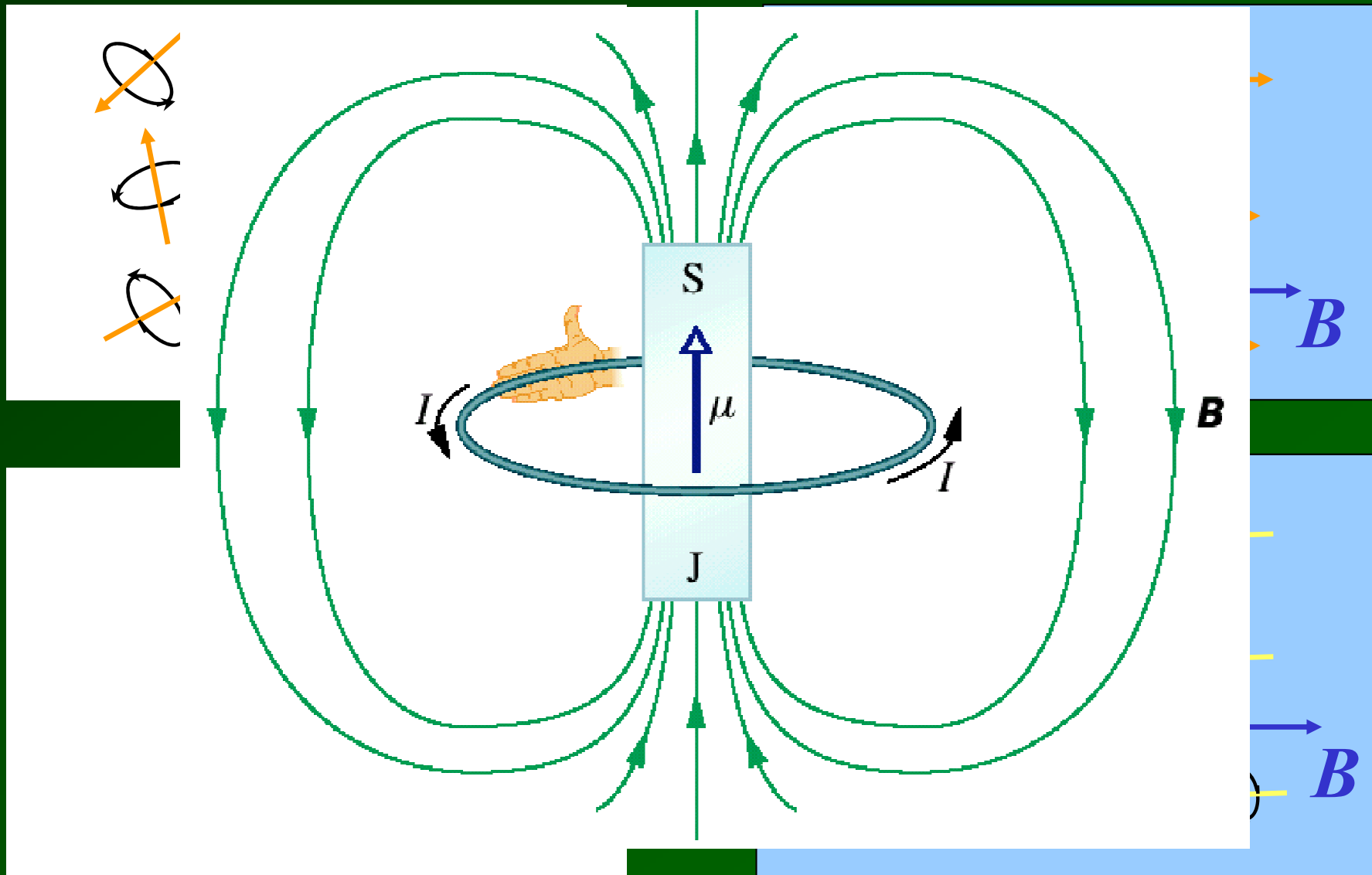

MAGNETICKÝ DIPÓL

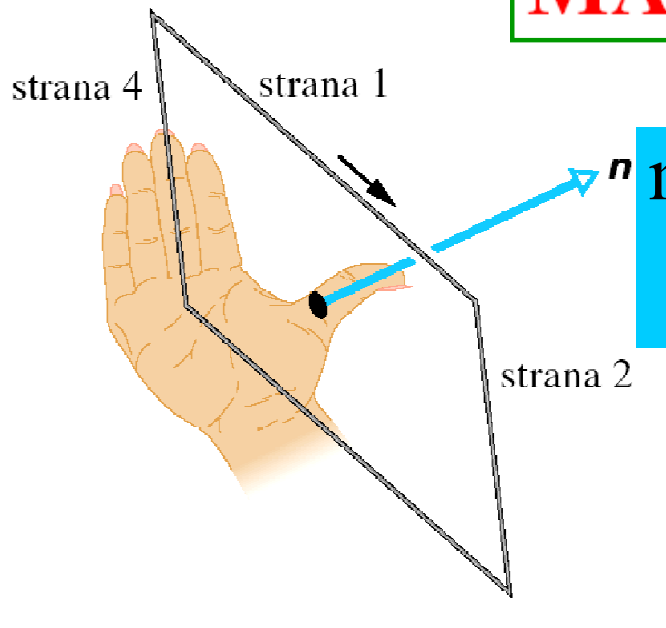

\vec{n} magnetický dipólový
moment $\vec{\mu}$

$$\vec{\mu} = NIS$$

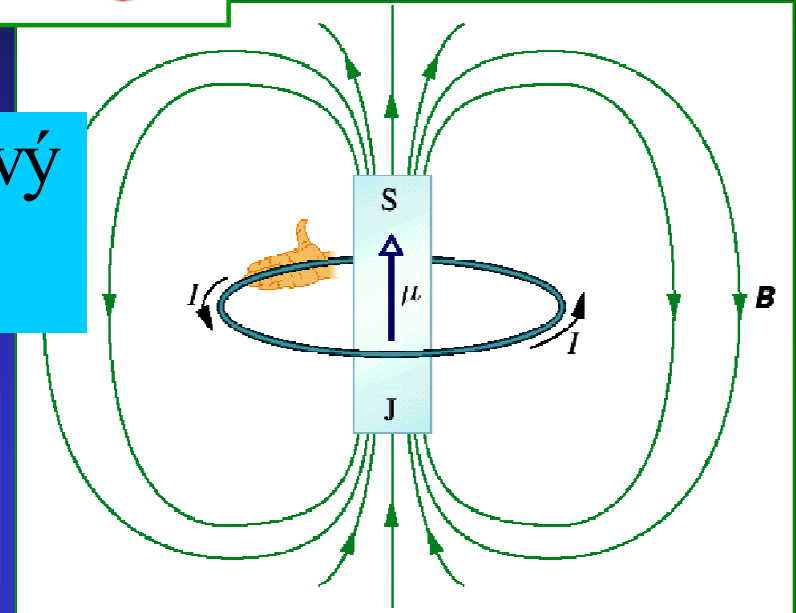

moment síly působící na dipól

$$\vec{M} = \vec{\mu} \times \vec{B}$$

potenciální energie dipólu

$$E_p = -\vec{\mu} \cdot \vec{B}$$

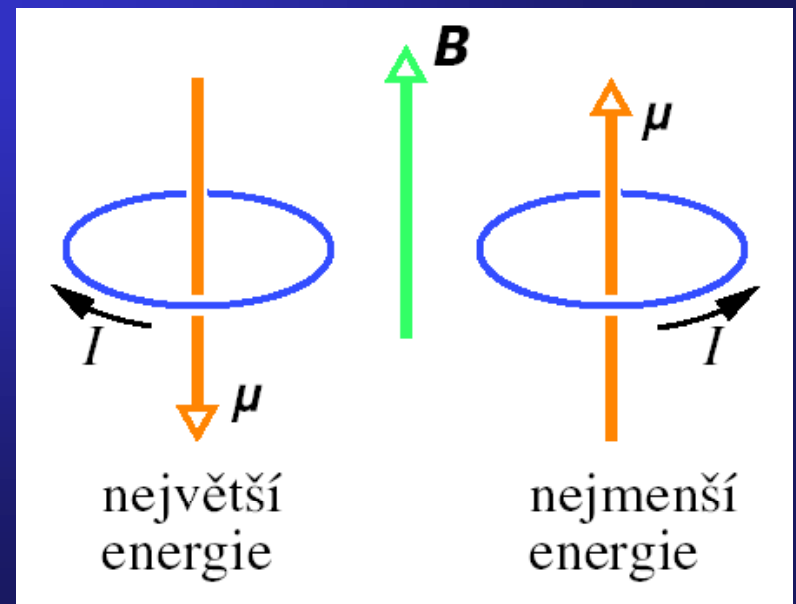

Pole v látce I

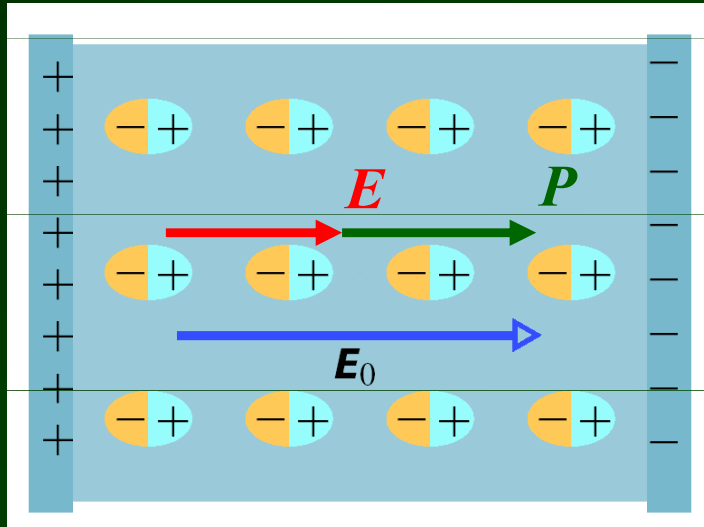

$$E = E_0 - P/\epsilon_0$$

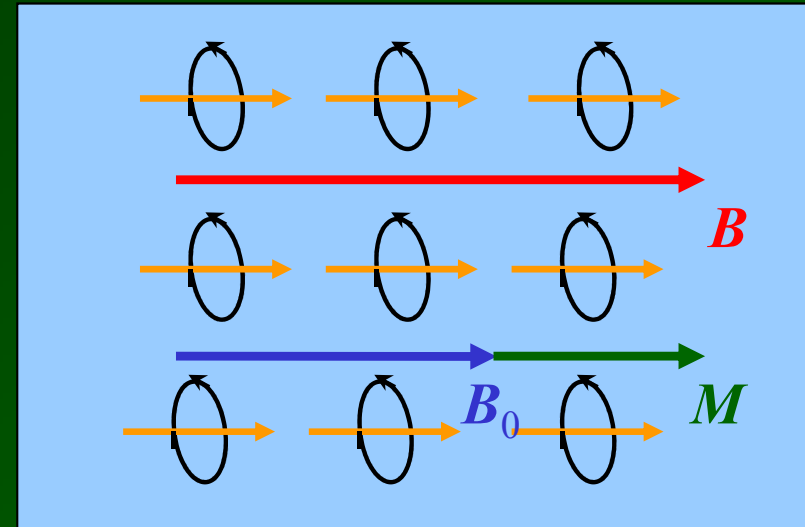

$$B = B_0 + \mu_0 M$$

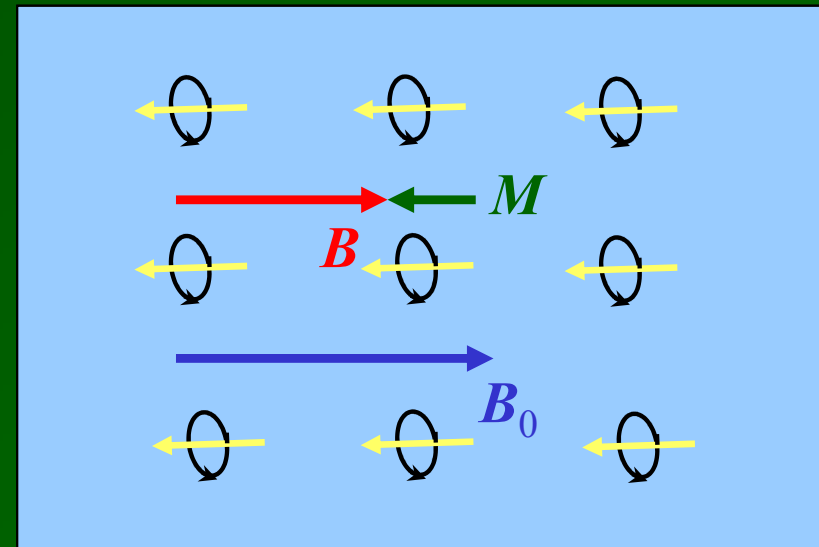

Magnetické dipóly v látce:

orbitální moment hybnosti elektronů

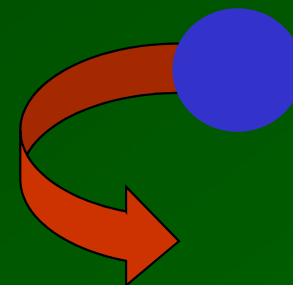

spin elektronů

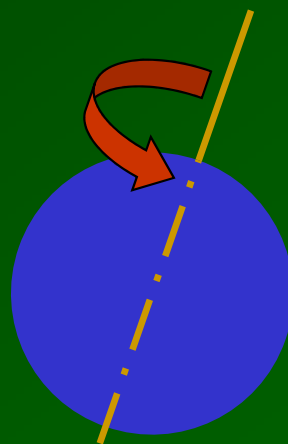

„Smyčkový model“

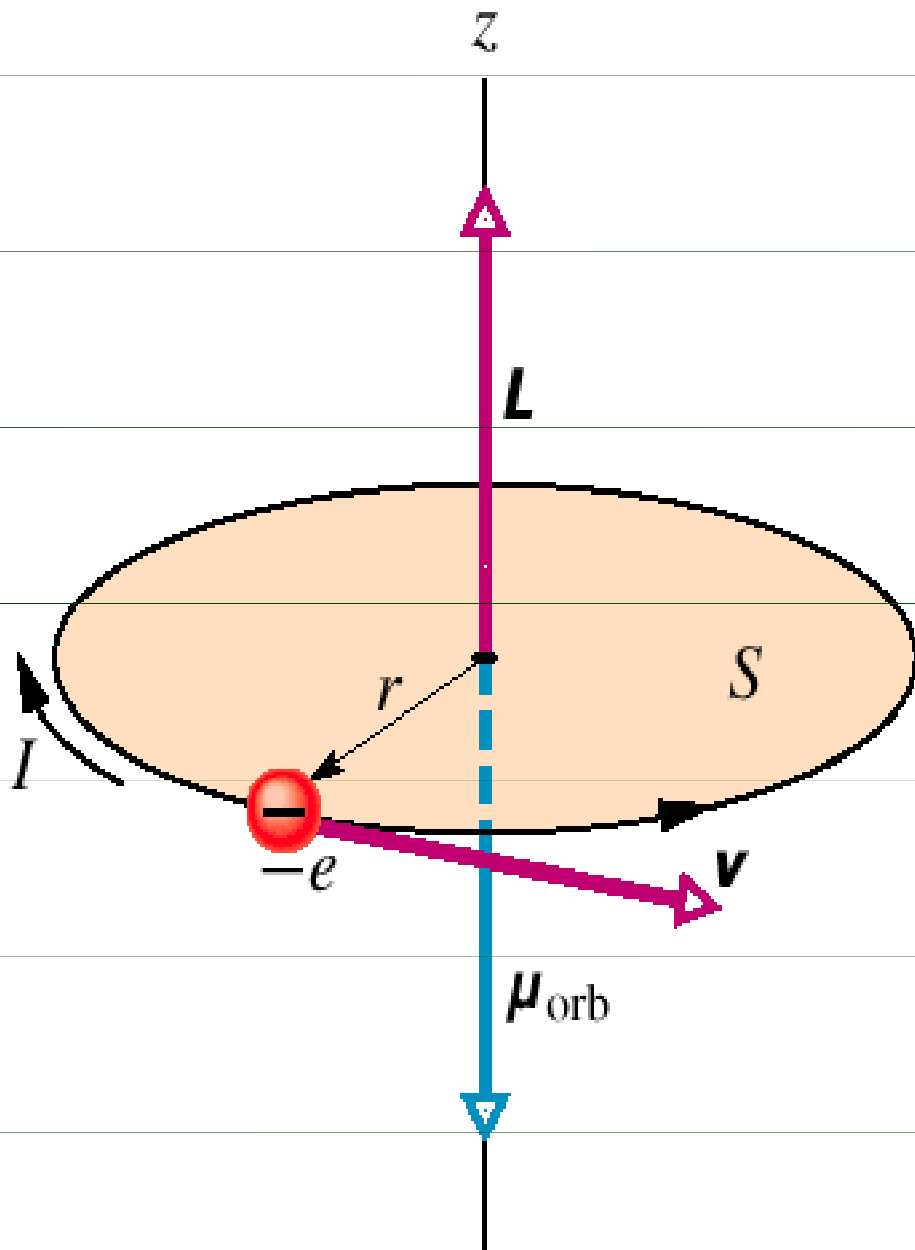

$$\mu_{\text{orb}} = IS = \frac{e}{2}rv$$

$$I = \frac{e}{T} = \frac{ev}{2\pi r}$$

$$S = \pi r^2$$

$$\vec{L} = m\vec{r} \times \vec{v}$$

$$L = mrv = \frac{2m}{e} \mu_{\text{orb}}$$

$$\vec{\mu}_{\text{orb}} = -\frac{e}{2m} \vec{L}$$

Skutečnost 1

orbitální moment hybnosti elektronu

\vec{L}

kvantováno

$$L_z = m_l \hbar$$

$$\text{pro } m_l = 0, \pm 1, \pm 2, \dots, \pm l$$

$$(E_{\text{foton}} = \hbar \omega, \hbar \approx 0,54 \cdot 10^{-34} \text{ J} \cdot \text{s})$$



orbitální dipólový magnetický moment

$$\vec{\mu}_{\text{orb}} = -\frac{e}{2m} \vec{L}$$

kvantováno

$$\mu_{\text{orb},z} = -m_l \mu_B$$

$$\mu_B = \frac{e\hbar}{2m} = 9,27 \cdot 10^{-24} \text{ J} \cdot \text{T}^{-1}$$

Bohrův magneton

$$E_p = -\vec{\mu}_{\text{orb}} \cdot \mathbf{B}_{\text{ext}} = -\mu_{\text{orb},z} B_{\text{ext}}$$

Skutečnost 2

spin elektronu

\vec{S}

kvantováno

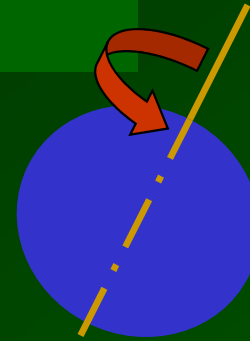

$$S_z = m_s \hbar \quad \text{pro } m_s = \pm \frac{1}{2}$$

spinový dipólový magnetický moment

$$\vec{\mu}_{spin} = -2 \frac{e}{2m} \vec{S}$$

kvantováno

$$\mu_{s,z} = \pm \mu_B.$$

$$E_p = -\mu_s \cdot \mathbf{B}_{ext} = -\mu_{s,z} B,$$

Einsteinöv - de Haasöv jev

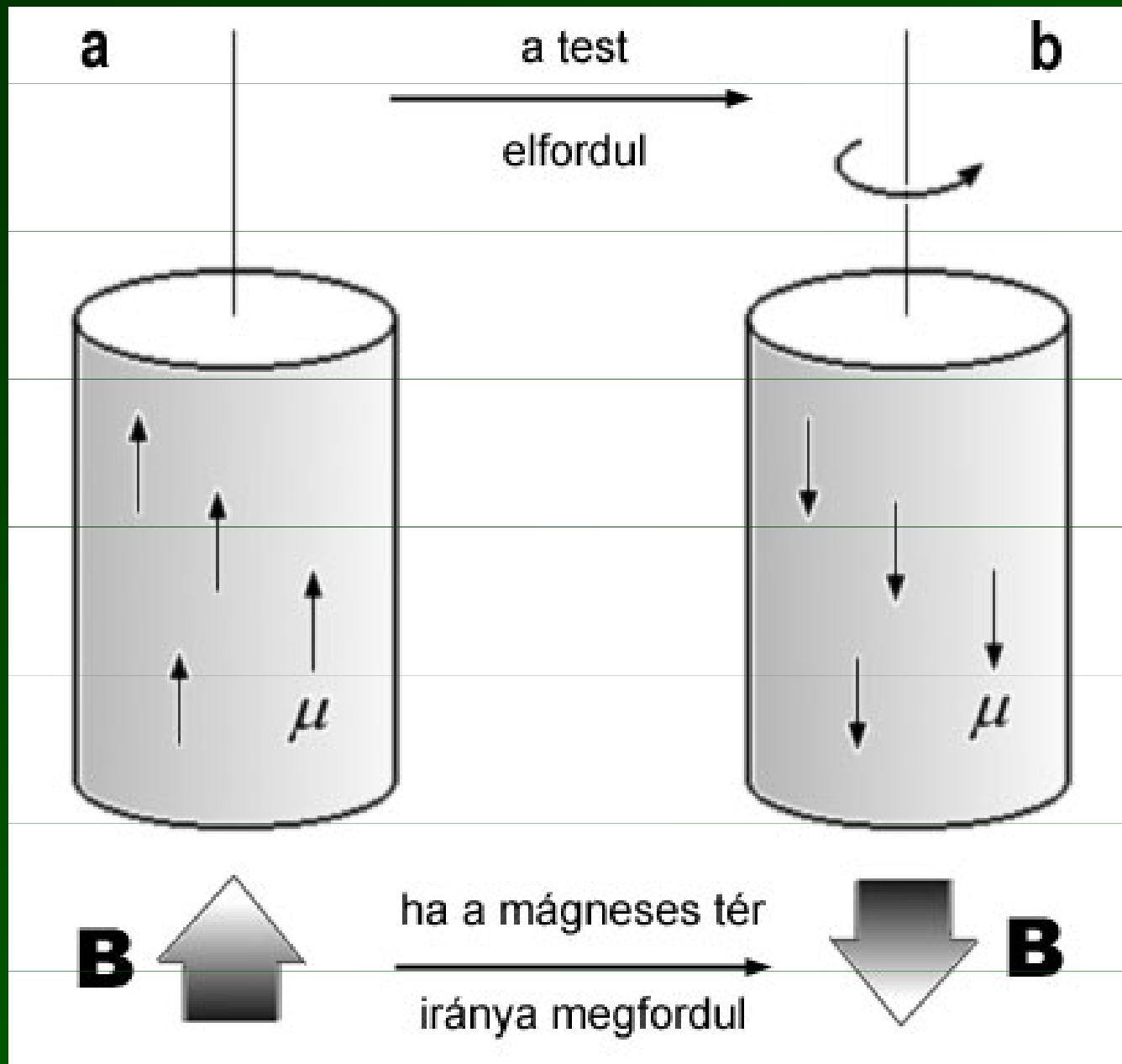

Otto Stern and Walther Gerlach, Frankfurt, Germany, 1922

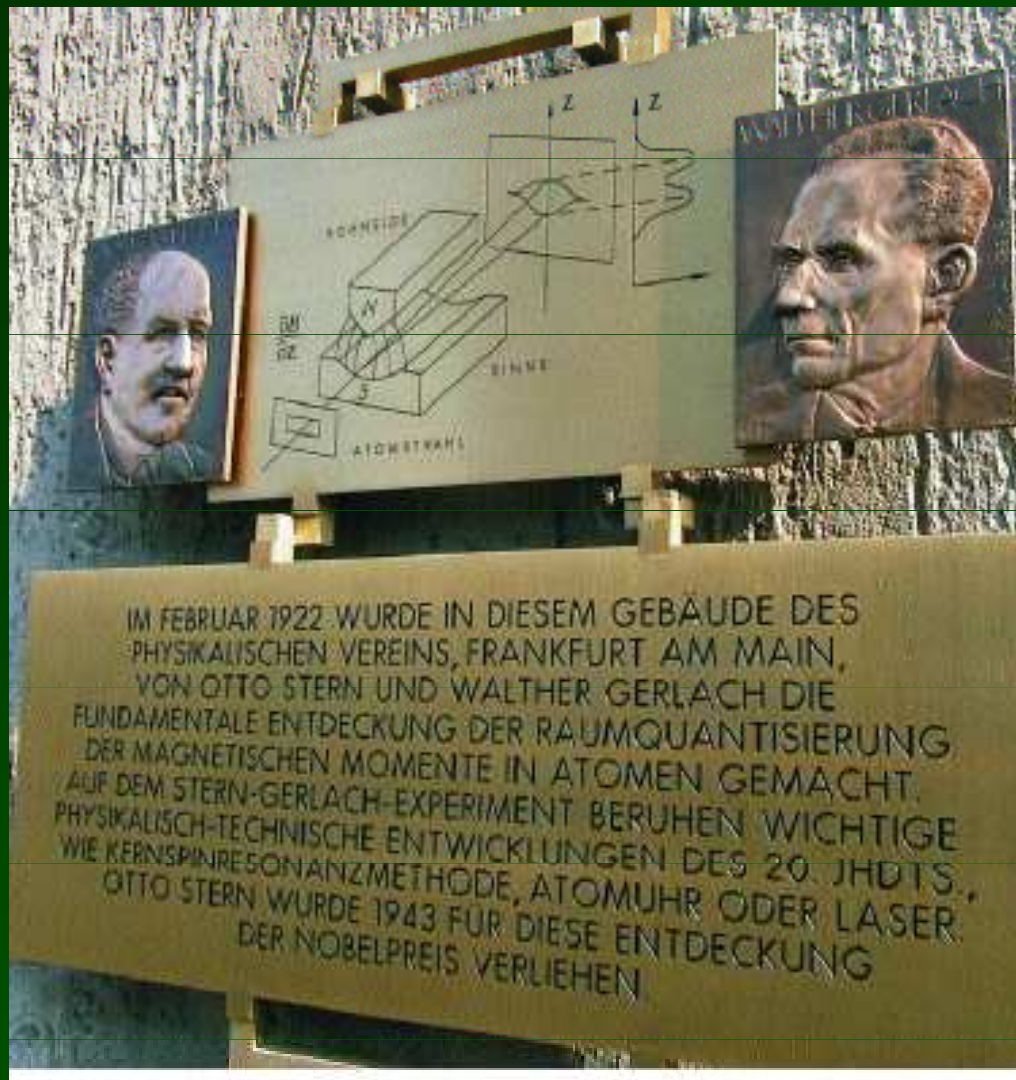

Sternův - Gerlachův experiment (1922)

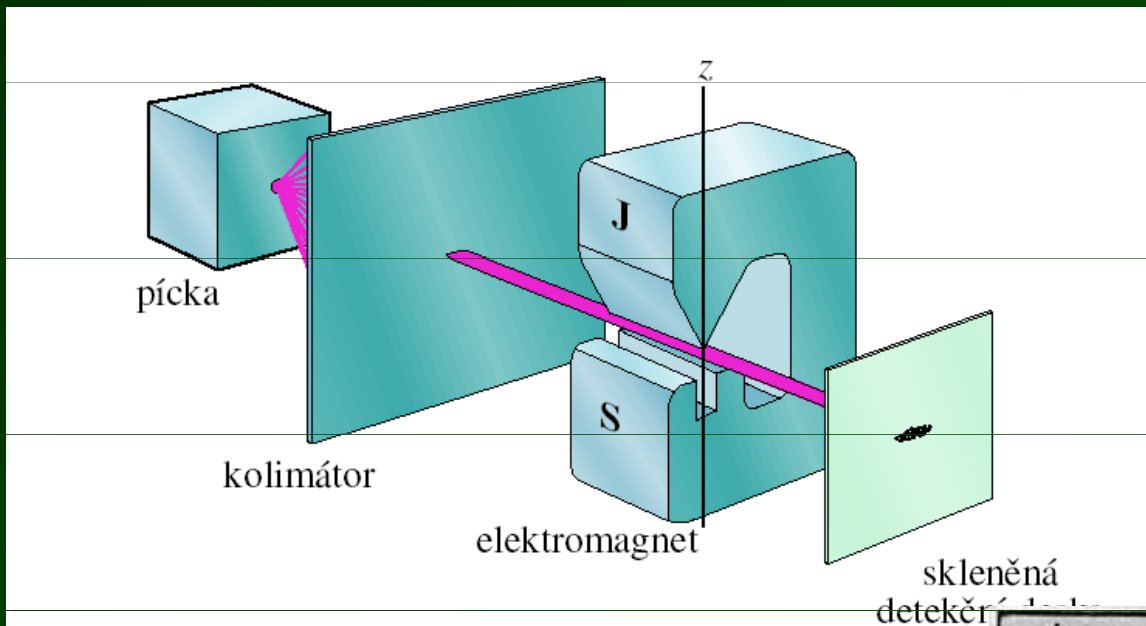

Obr. 41.8 Zařízení, na kterém Stern a Gerlach v roce 1921 ukázali prostorové kvantování. Celý přístroj se nachází v kovové aparatuře.

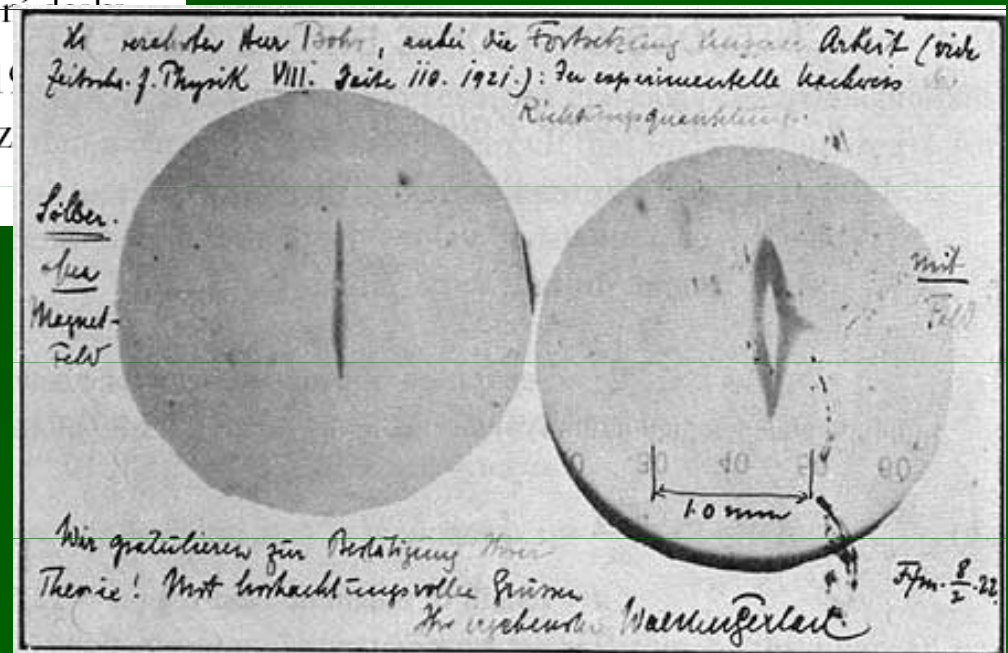

Magnetismus a elektrony a protony

Tabulka 29.2 Některé magnetické
dipólové momenty

Malý tyčový magnet	$5 \text{ A}\cdot\text{m}^2$
Země	$8,0\cdot 10^{22} \text{ A}\cdot\text{m}^2$
Proton	$1,4\cdot 10^{-26} \text{ A}\cdot\text{m}^2$
Elektron	$9,3\cdot 10^{-24} \text{ A}\cdot\text{m}^2$

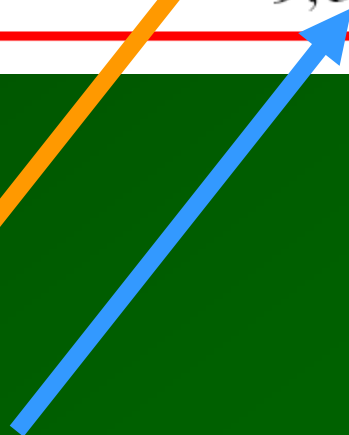
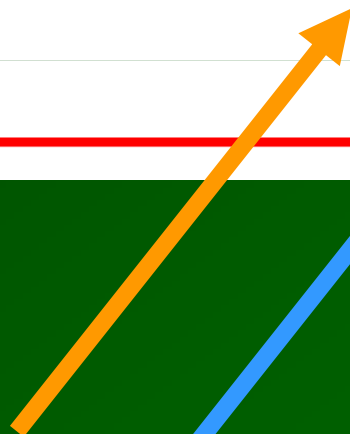

Magnetické dipóly v látce

orbitální a spinové magnetické momenty elektronů
se skládají



magnetický moment atomu/látky



klasifikace látek (magnetik)

DIA
PARA
FERO

MAGNETIKUM

Diamagnetism

is a kind of magnetism characteristic of materials that partly expel from their interior the magnetic field in which they are placed. First observed by S. J. Brugmans (1778) in bismuth and antimony; diamagnetism was named and studied by Michael Faraday (beginning in 1845). He and subsequent experimenters found that some elements and most compounds exhibit this "negative" magnetism.

Indeed, all substances are diamagnetic: the strong external magnetic field speeds up or slows down the electrons orbiting in atoms in such a way as to oppose the action of the external field in accordance with Lenz's law. The diamagnetism of some materials, however, is masked either by a weak magnetic attraction (paramagnetism) or a very strong attraction (ferromagnetism).

Diamagnetism is observable in substances with symmetric electronic structure (as ionic crystals and rare gases) and no permanent magnetic moment. Diamagnetism is not affected by changes in temperature. For diamagnetic materials the value of the susceptibility (a measure of the relative amount of induced magnetism) is always negative and typically near negative one-millionth.

DIAMAGNETIKA

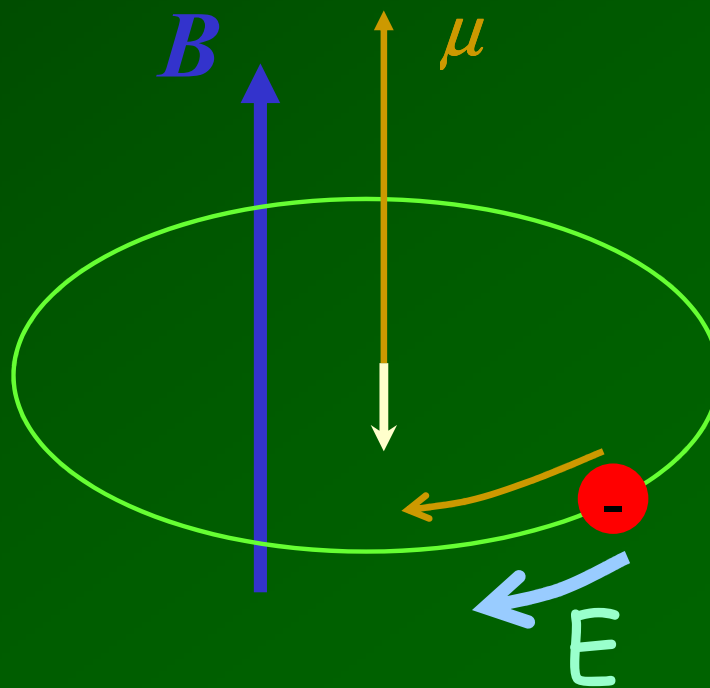
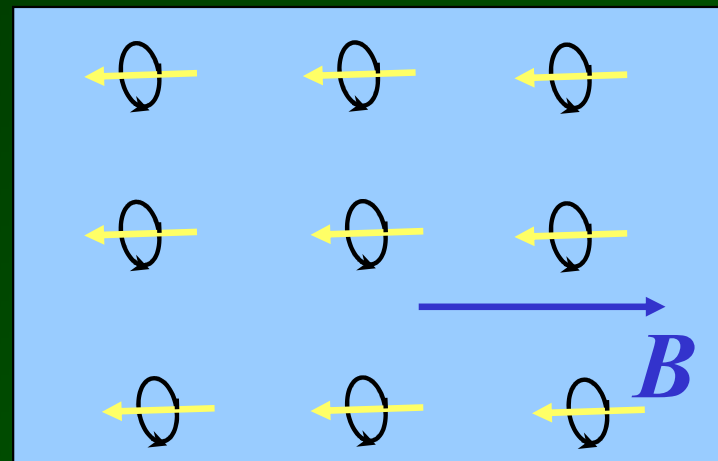
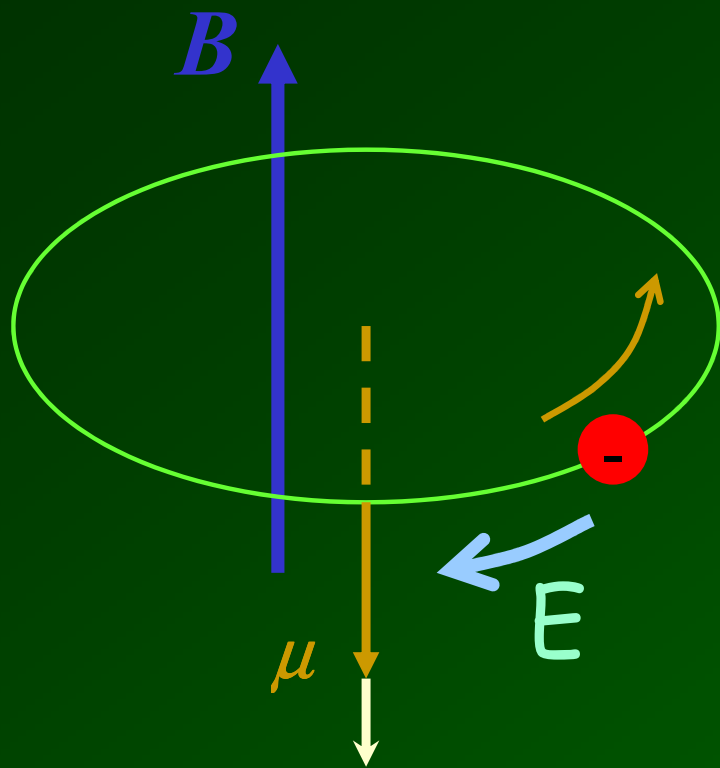

Paramagnetism

is a kind of magnetism characteristic of materials weakly attracted by a strong magnet, named and extensively investigated by the British scientist Michael Faraday beginning in 1845. Most elements and some compounds are paramagnetic. Strong paramagnetism (not to be confused with the ferromagnetism of the elements iron, cobalt, nickel, and other alloys) is exhibited by compounds containing iron, palladium, platinum, and the rare-earth elements (lanthanides and actinides). In such compounds atoms of these elements have some inner electron shells that are incomplete. Their unpaired electrons' spin and orbital magnetic moments make the atoms a permanent magnet tending to align with and hence strengthen an applied magnetic field. Strong paramagnetism decreases with rising temperature because of the re-alignment produced by the greater random motion of the atomic magnets.

Weak paramagnetism is found in many metallic elements in the solid state, such as sodium and the other alkali metals, because an applied magnetic field affects the spin of some of the loosely bound conduction electrons. The value of susceptibility (a measure of the relative amount of induced magnetism) for paramagnetic materials is always positive and at room temperature is typically about $1/100,000$ to $1/10,000$ for weakly paramagnetic substances and about $1/10,000$ to $1/100$ for strongly paramagnetic substances.

PARAMAGNETIKA

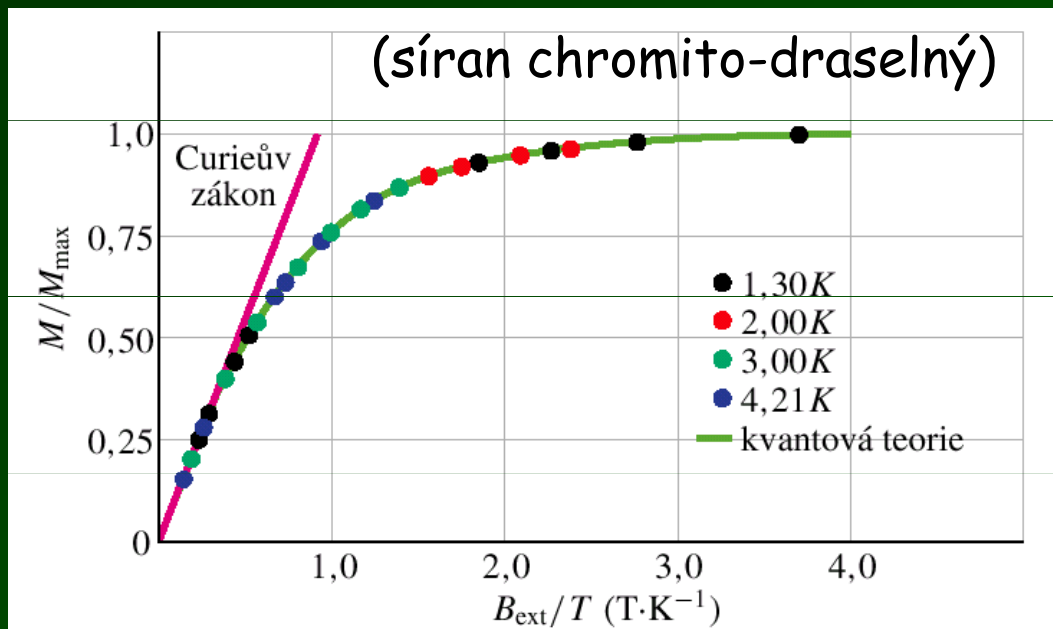
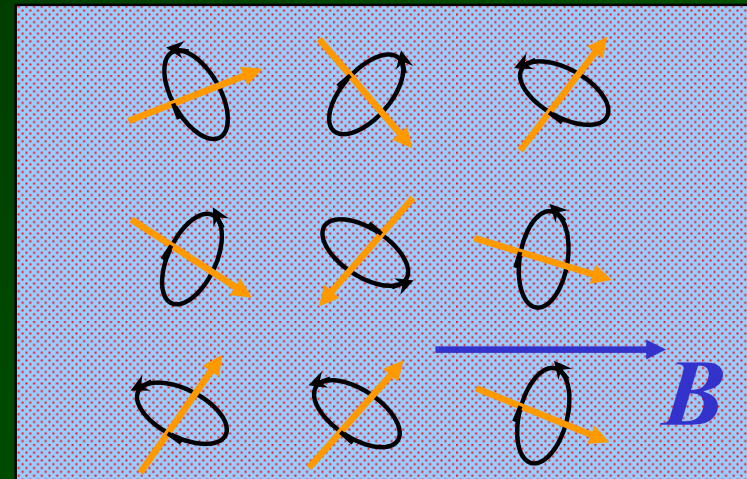

$$M = C \frac{B_{\text{ext}}}{T} \quad (\text{Curieův zákon}).$$

$$\mu_B \approx 10^{-23} \text{ J/T}$$

$$1,5 \text{ T}$$

$$\Delta E_p = 2 \mu_B = 0.17 \text{ meV}$$

$$E_k = \frac{1}{2} k_B T = 39 \text{ meV}$$

$$k_B = 1.38 \cdot 10^{-23} \text{ J/K}$$

$$300 \text{ K}$$

FEROMAGNETIKA

magnetické domény

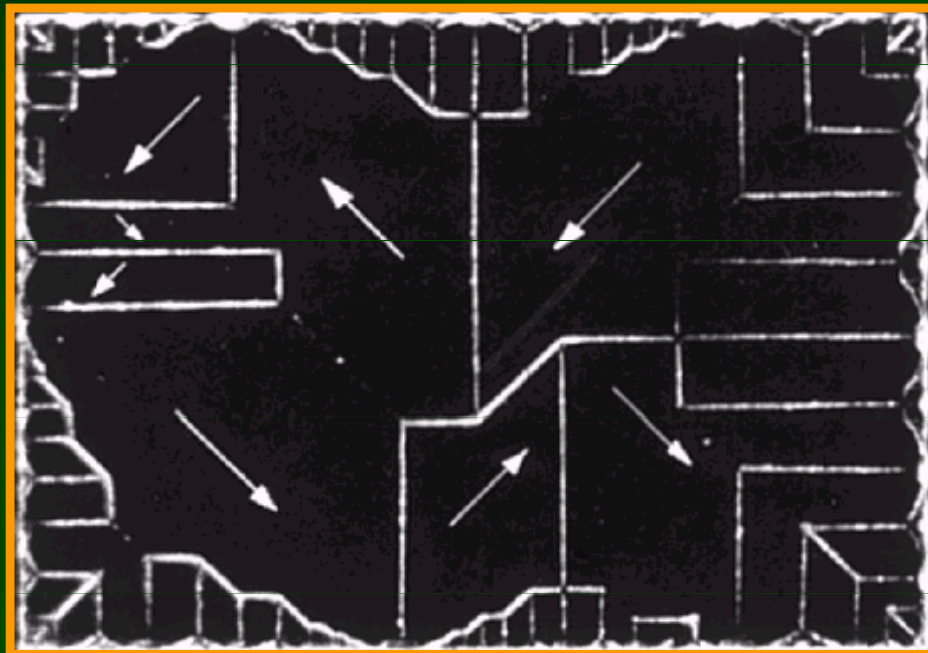
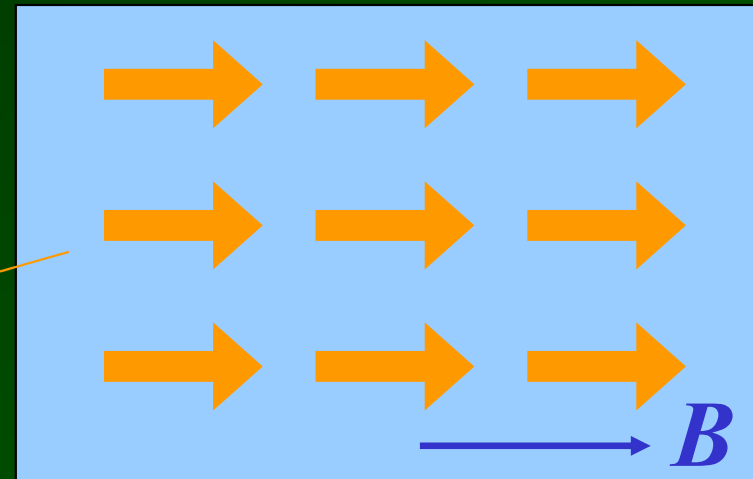

hystereze

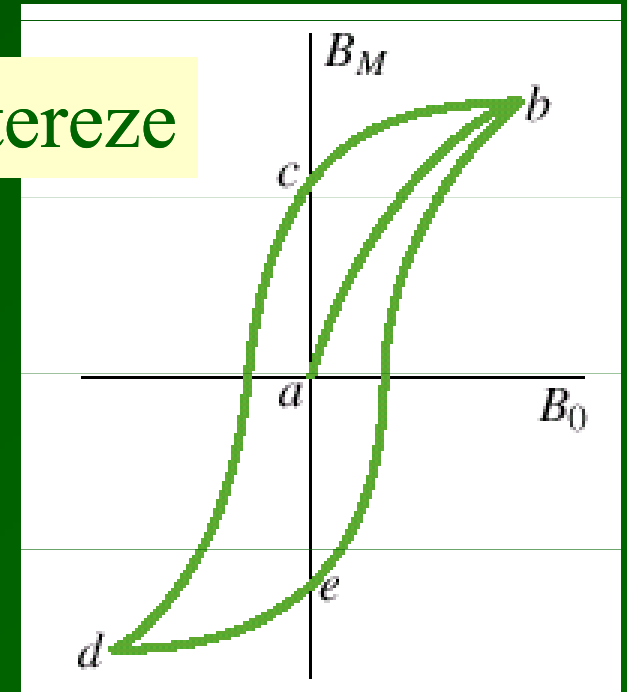

Pole v látce II

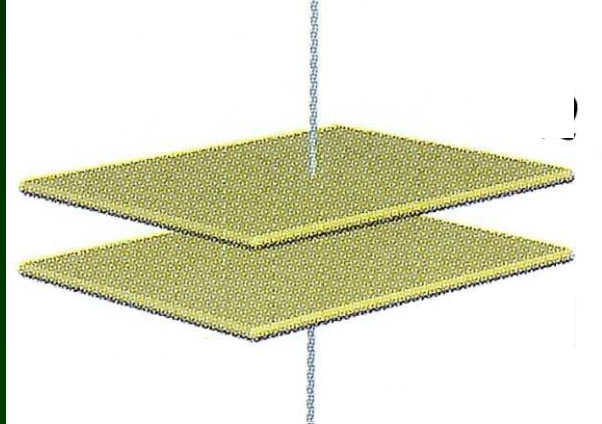

$$C = \frac{\epsilon_r \epsilon_0 S}{d}$$

$$C = Q/U$$

$$U = Ed$$

$$E = E_0 / \epsilon_r$$

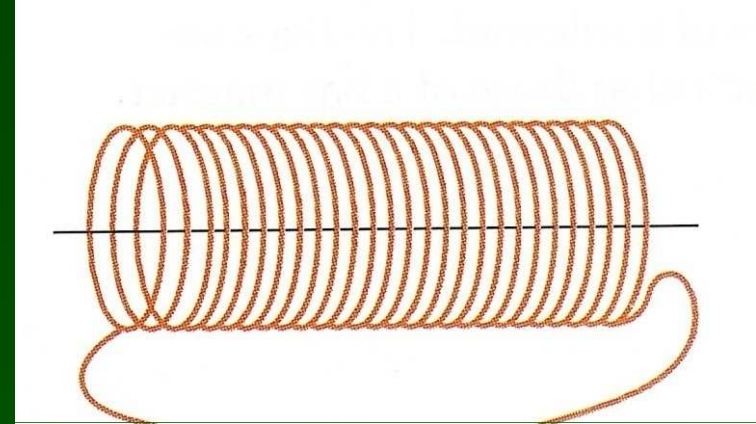

$$L = \frac{\mu_r \mu_0 N^2 S}{l}$$

$$L = \Phi/I$$

$$\Phi = BS$$

$$B = \mu_r B_0$$

$$\mu_r = 1 + \chi$$

TABLE 30.2 Magnetic Susceptibilities of Some Paramagnetic and Diamagnetic Substances at 300 K

Paramagnetic Substance	χ	Diamagnetic Substance	χ
Aluminum	2.3×10^{-5}	Bismuth	-1.66×10^{-5}
Calcium	1.9×10^{-5}	Copper	-9.8×10^{-6}
Chromium	2.7×10^{-4}	Diamond	-2.1×10^{-5}
Lithium	2.1×10^{-5}	Gold	-3.5×10^{-5}
Magnesium	1.9×10^{-5}	Lead	-1.1×10^{-5}
Niobium	2.6×10^{-4}	Mercury	-2.9×10^{-5}
Oxygen (STP)	2.1×10^{-6}	Nitrogen (STP)	-5.0×10^{-9}
Platinum	2.9×10^{-4}	Silver	-2.6×10^{-5}
Tungsten	6.8×10^{-5}	Silicon	-4.2×10^{-6}

$\mu_r > 1$

$\mu_r < 1$

Měření magnetizace

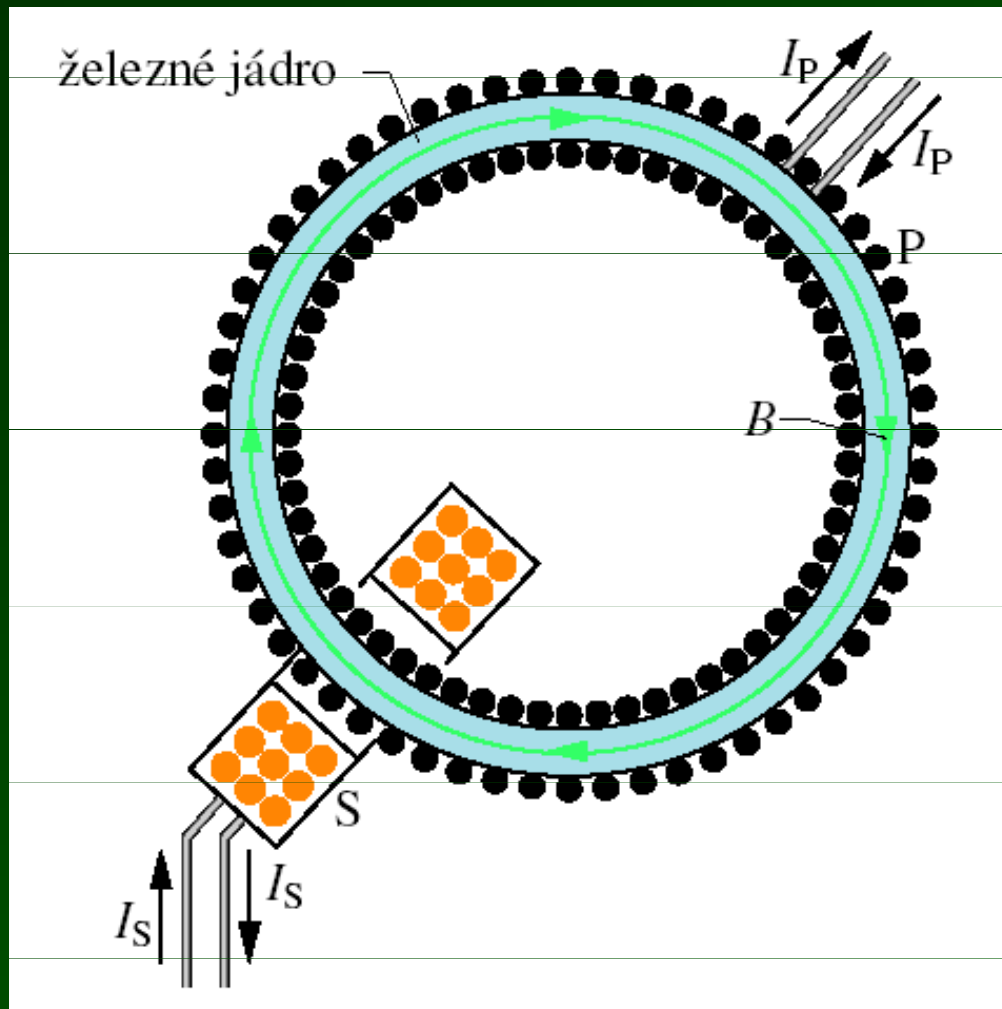

$$B_0 = \mu_0 n I_P$$

$$B = B_0 + B_M$$

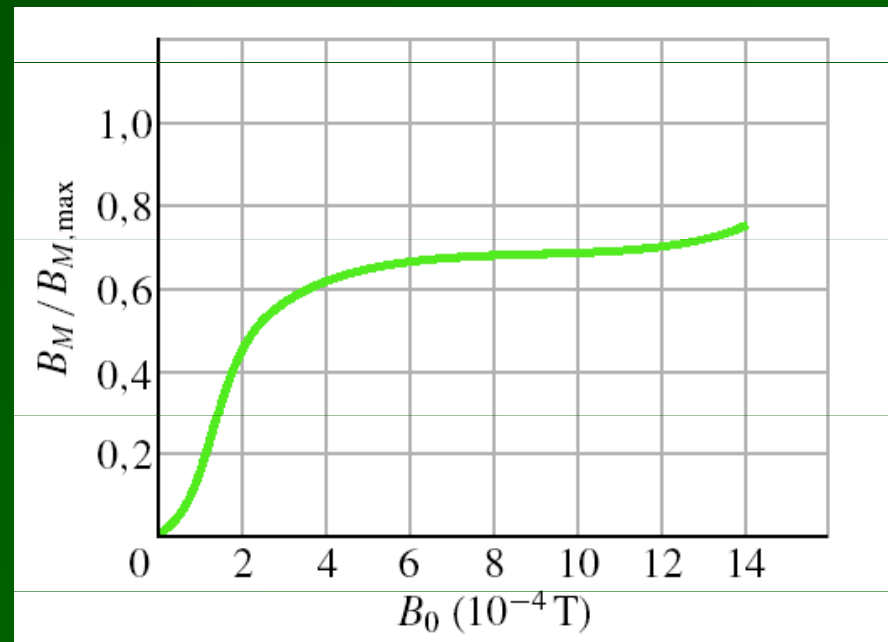

Chování magnetik v nehomogenním magnetickém poli

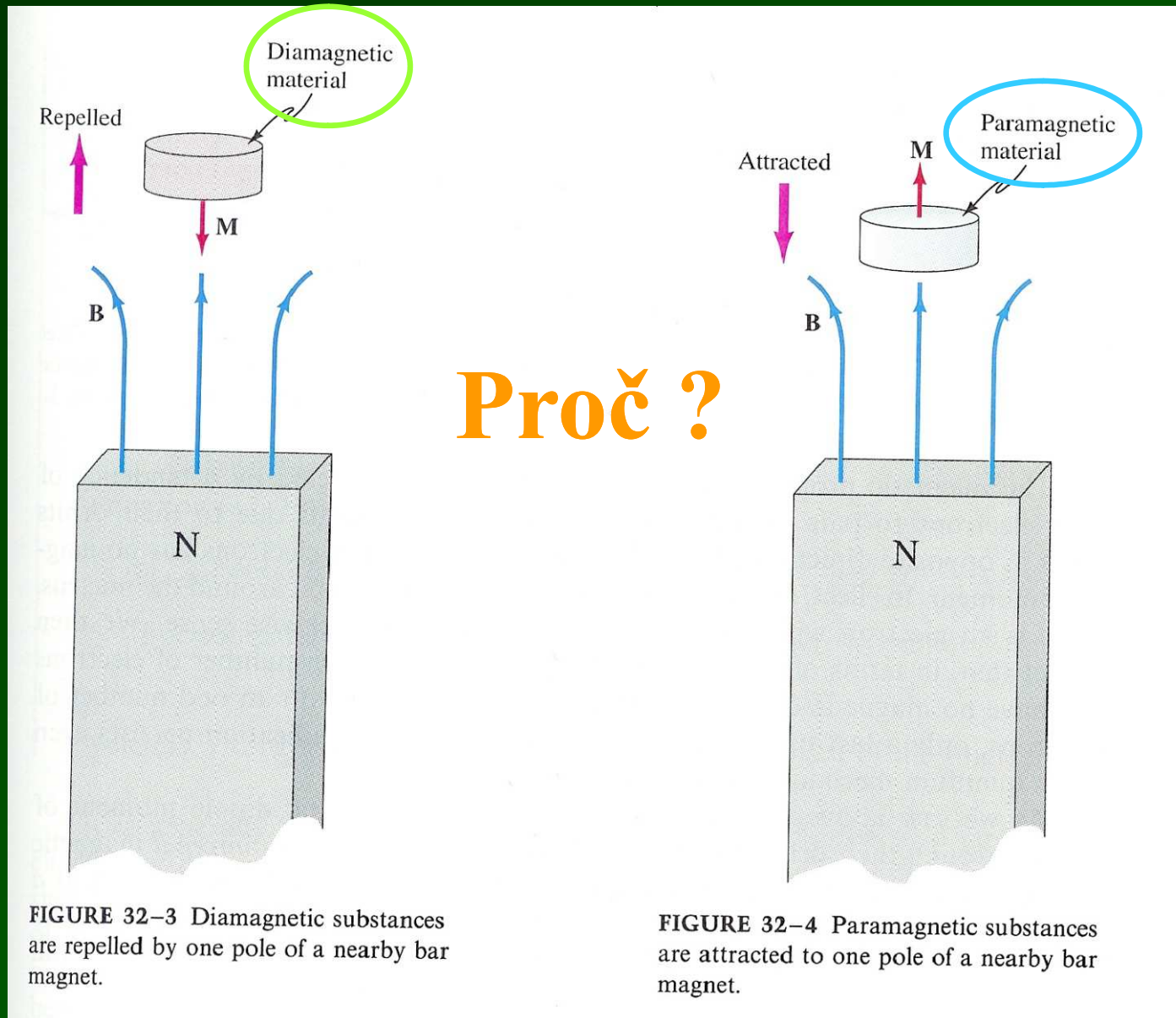

DIPÓL V HOMOGENNÍM POLI

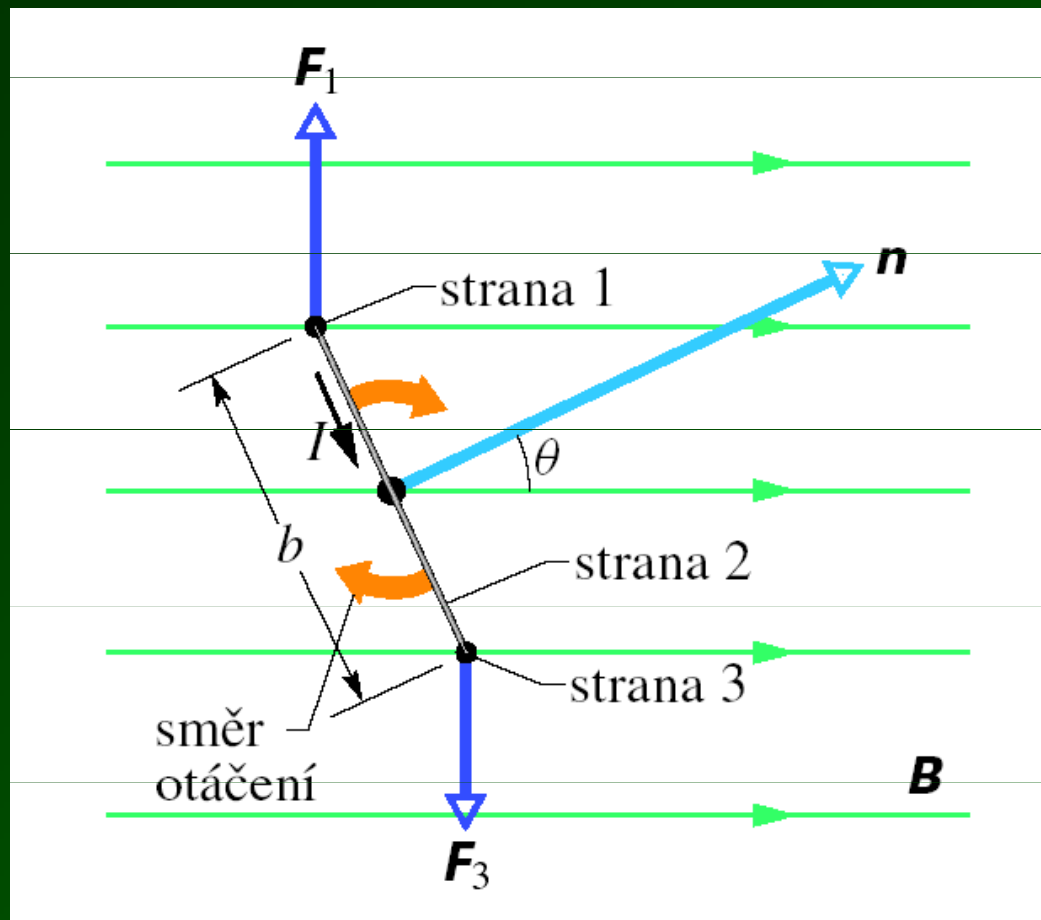

$$\vec{M} = \vec{\mu} \times \vec{B} \neq 0$$

$$\vec{F}_{\text{výsl}} = \sum \vec{F}_i = 0$$

DIPÓL V NEHOMOGENNÍM POLI

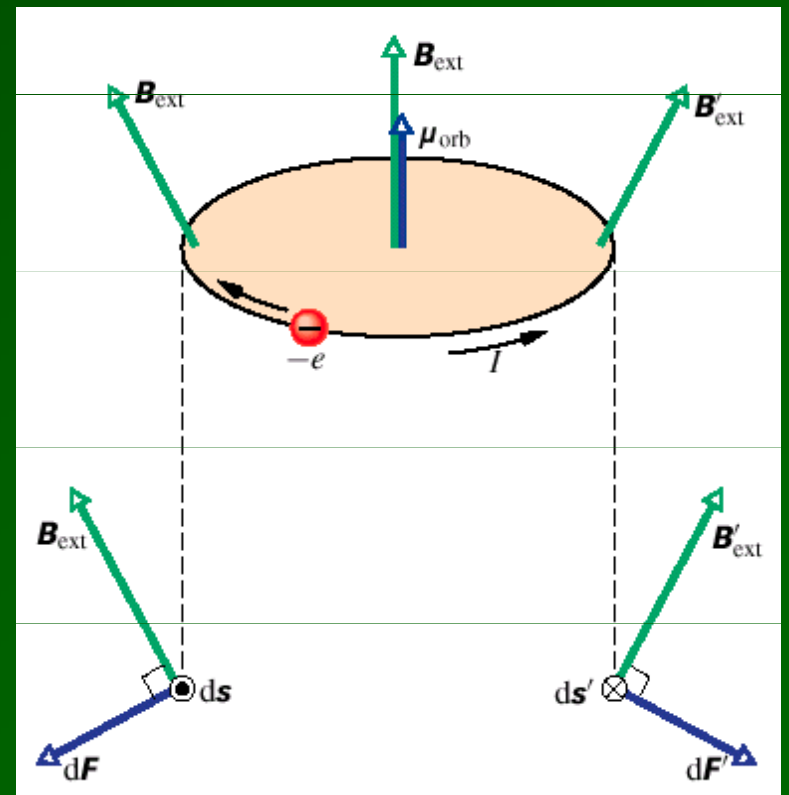
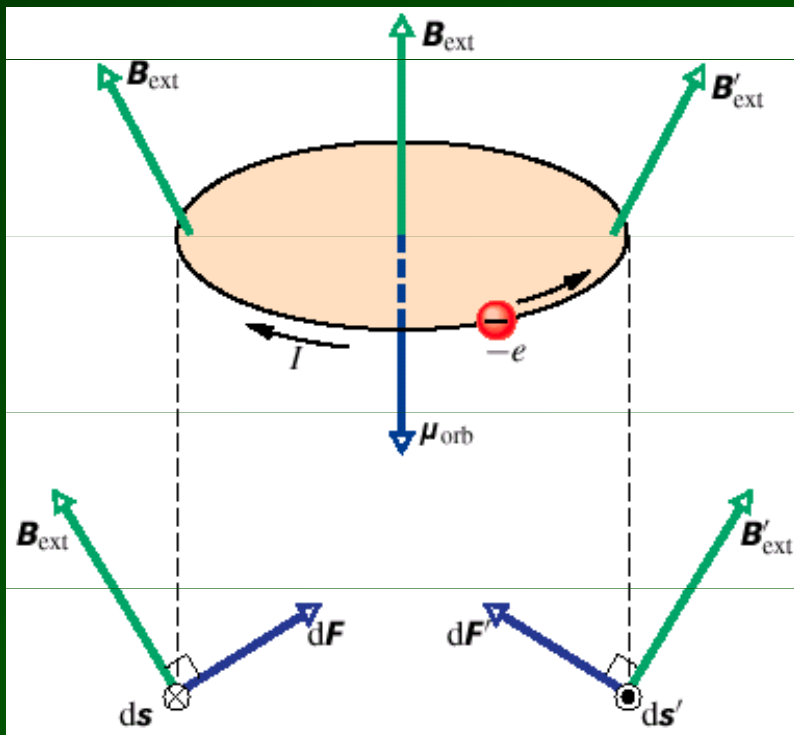
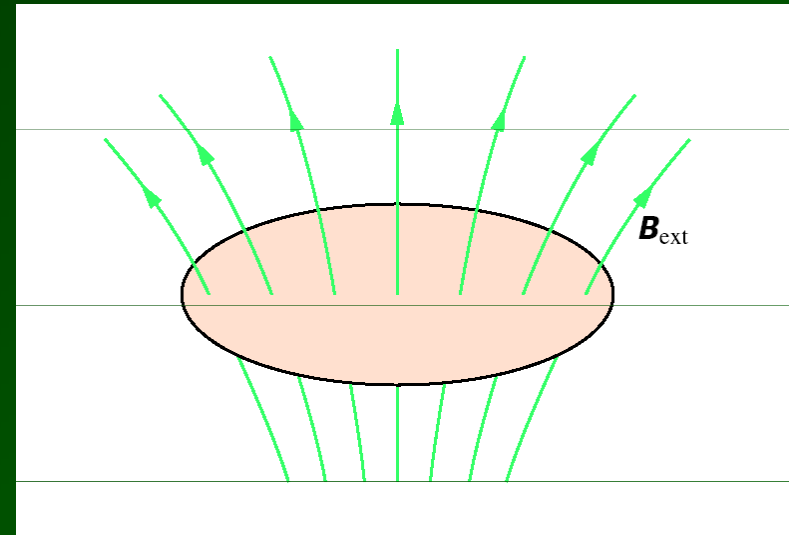
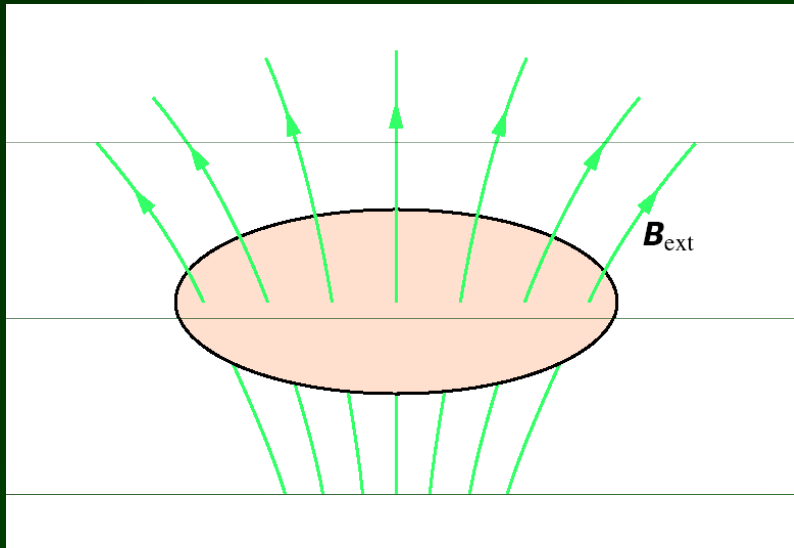

Chování magnetik v nehomogenním magnetickém poli

DIAMAGNETICKÁ LÁTKA

je vytlačována z pole ven

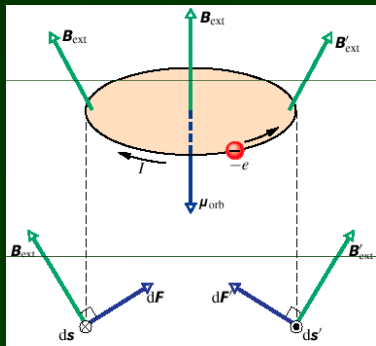

PARAMAGNETICKÁ LÁTKA

FEROMAGNETICKÁ LÁTKA

je vtahována do pole

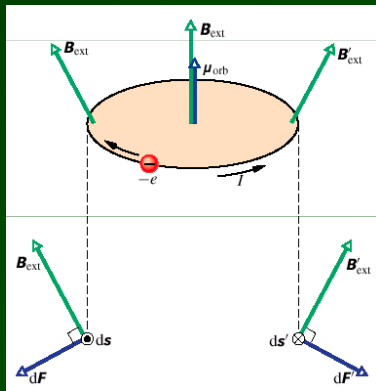

DIELEKTRIKUM

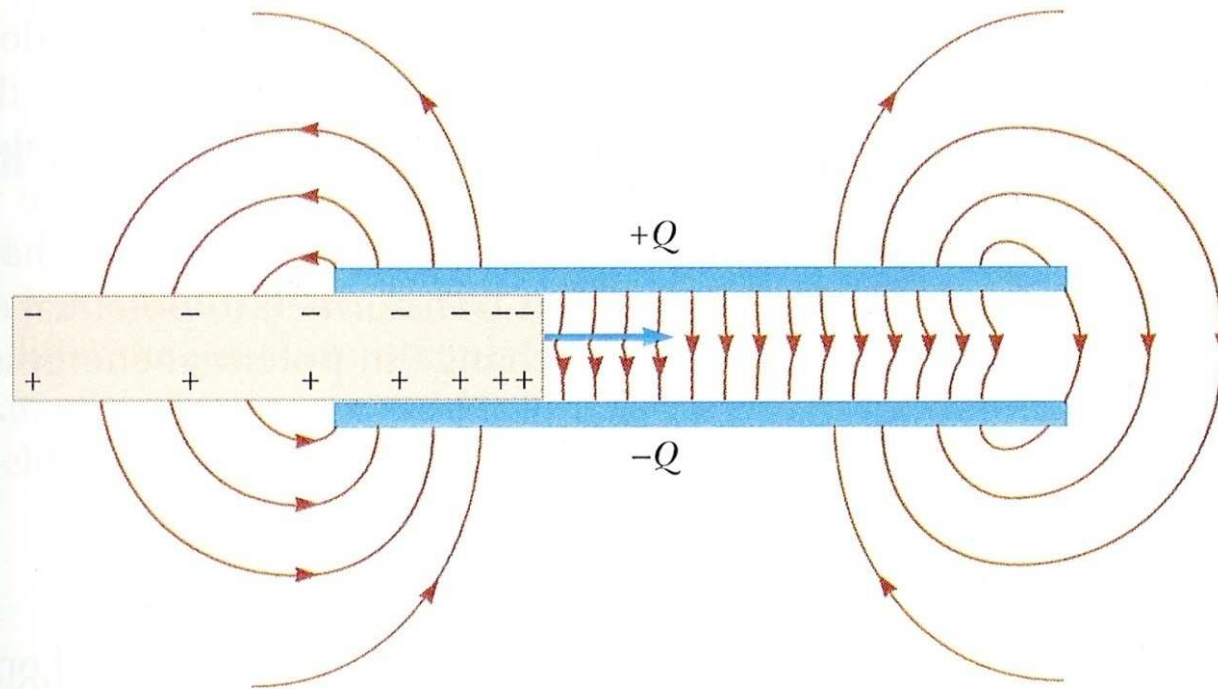

FIGURE 26.14 The nonuniform electric field near the edges of a parallel-plate capacitor causes a dielectric to be pulled into the capacitor. Note that the field acts on the induced surface charges on the dielectric that are nonuniformly distributed.

je vtahováno do pole

Fyzika v akci

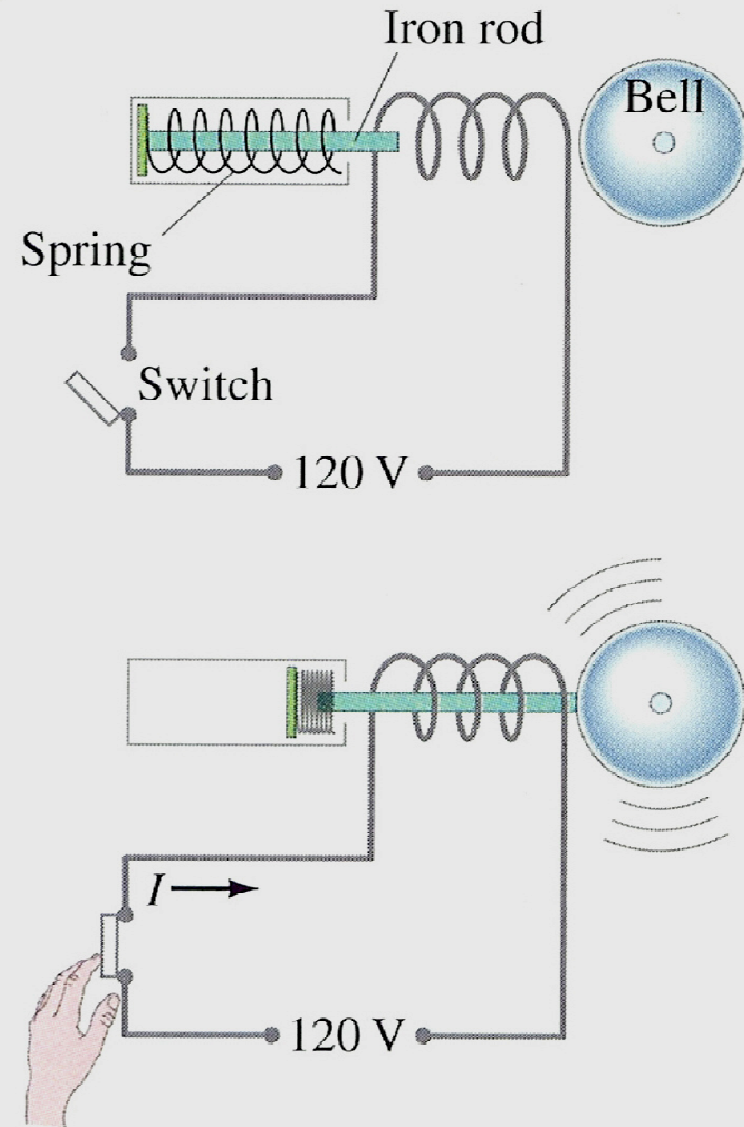

FIGURE 28–23 Solenoid used as a doorbell.

Pole v látce III

Pole na rozhraní dvou prostředí



$$E_{t1} = E_{t2}$$

$$\epsilon_{r1} E_{n1} = \epsilon_{r2} E_{n2}$$



$$B_{t1} / \mu_{r1} = B_{t2} / \mu_{r2}$$

$$B_{n1} = B_{n2}$$

Toroid s jádrem
a vzduchovou
mezerou

$$B = \frac{\mu_0 \mu_r NI}{2\pi R}$$

$$B_{1n} = B_{2n}$$
$$\oiint_S \vec{B} \cdot d\vec{S} = 0$$

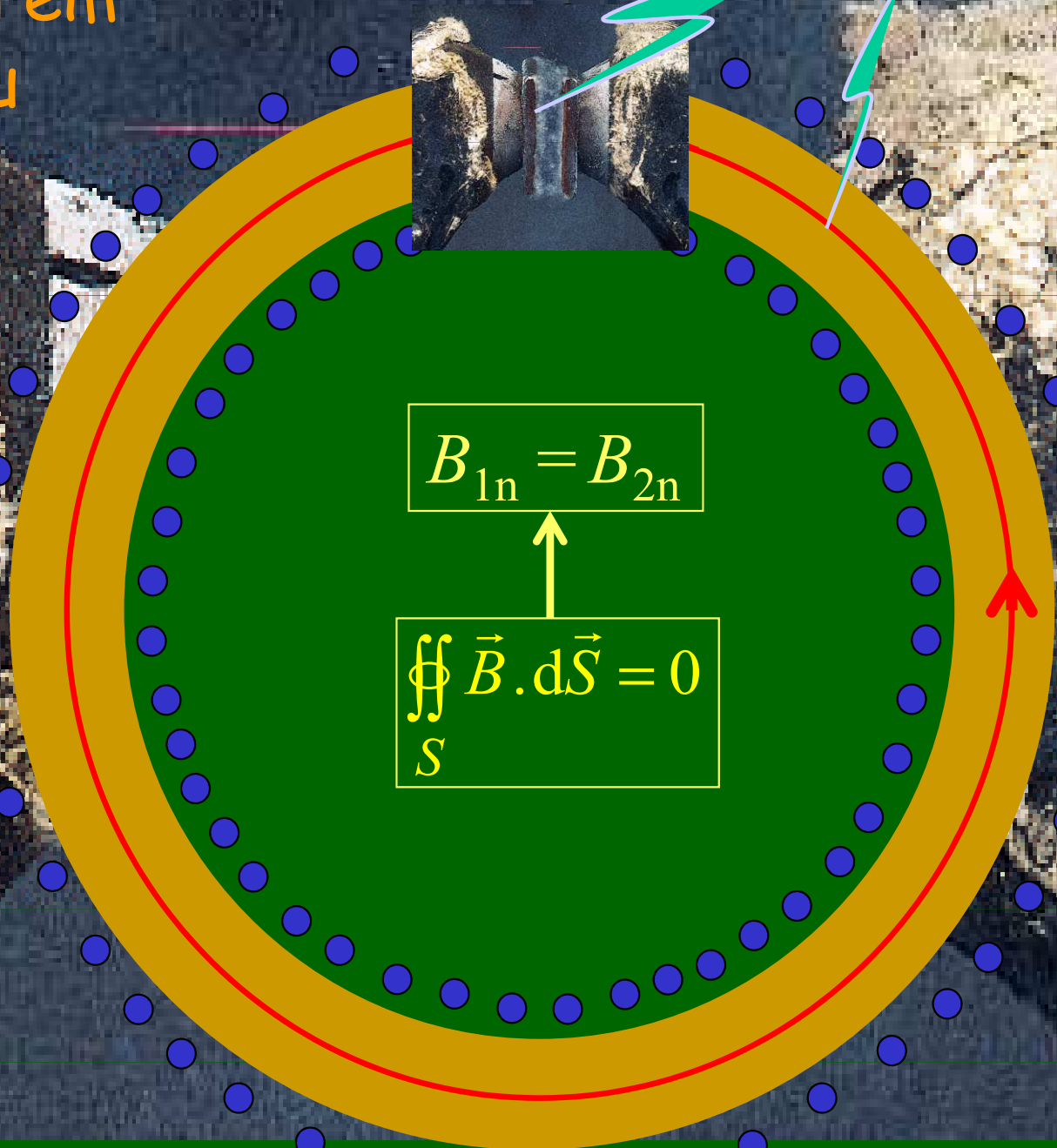

OTÁZKY

9. V uspořádání podle obr. 32.22 je mezi dvěma póly magnetu nehomogenní magnetické pole. Do tohoto pole vletí elektron kolmo do roviny stránky v místě tečky. Kam směřuje síla působící na elektron vyvolaná interakcí jeho spinu s polem (směrem vlevo, napravo, nebo je nulová), je-li průmět spinu elektronu \mathbf{S}_z orientován (a) nalevo, (b) napravo? (*Tip: Elektron modelujte kuličkou se záporným nábojem na povrchu, takže představuje proudovou smyčku podobně jako na obr. 32.9.)*)

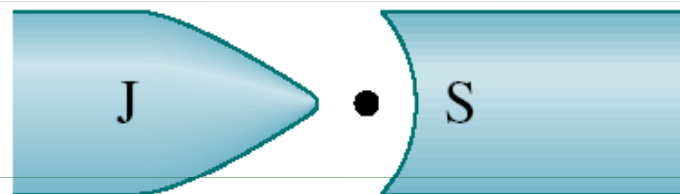

Obr. 32.22 Otázka 9

16Ú. Obr. 32.30 představuje energiové spektrum; na svislou osu vynášíme energiové hladiny atomu (jako v obr. 8.17). V nepřítomnosti pole má atom dvě hladiny E_1 a E_2 (obr. 32.30a). Je-li atom umístěn do magnetického pole 0,50 T, energiové spektrum se změní tak, jak ukazuje obr. 32.30b. (Zanedbejte spinový magnetický moment a uvažujte pouze potenciální energii $\mu_{\text{orb}} \cdot \mathbf{B}$.) Hladina E_1 se nezmění, ale hladina E_2 se rozštěpí na trojici blízkých hladin. Jaké jsou hodnoty m_l spojené s energiovou hladinou (a) E_1 a (b) E_2 ? (c) Jaká je vzájemná vzdálenost energiových hladin v tripletu na obr. 32.30b?

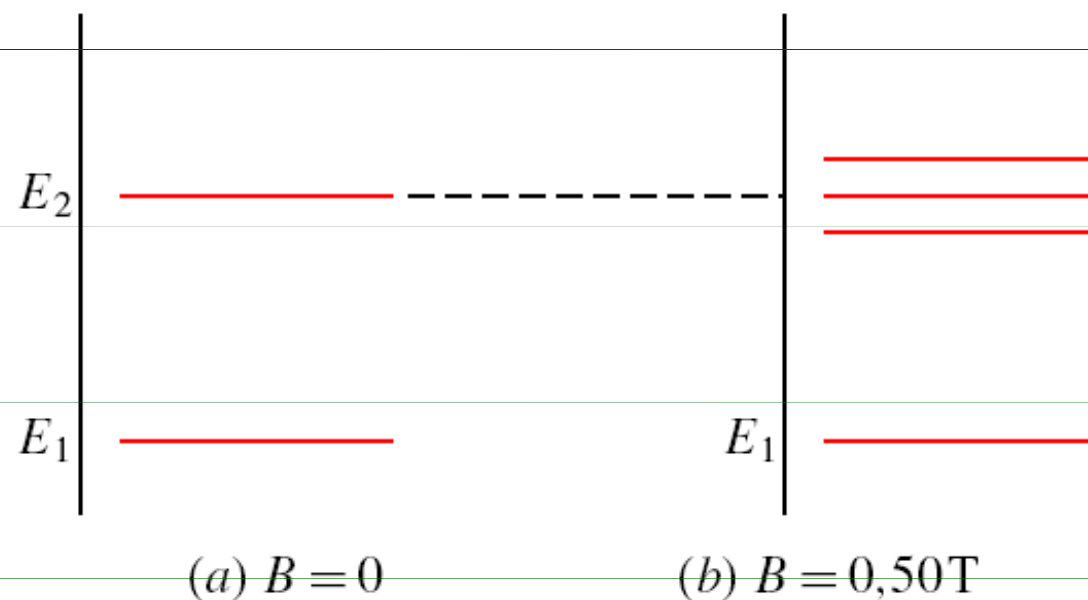

Obr. 32.30 Úloha 16

Na závěr...

atomové jádro a magnetismus

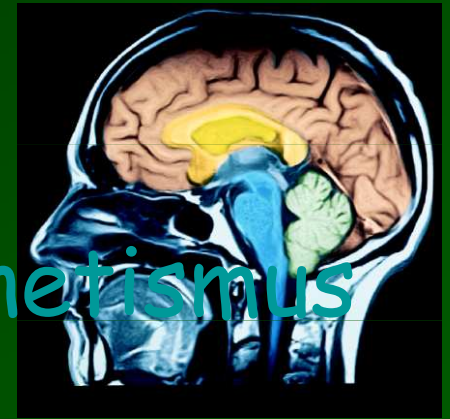

Jaderná magnetická rezonance

$1,41 \cdot 10^{-26} \text{ J/T}$

$1,80 \text{ T}$

$$f = \frac{2\mu_z B}{h} = 76,6 \text{ MHz}$$

$6,63 \cdot 10^{-34} \text{ J.s}$

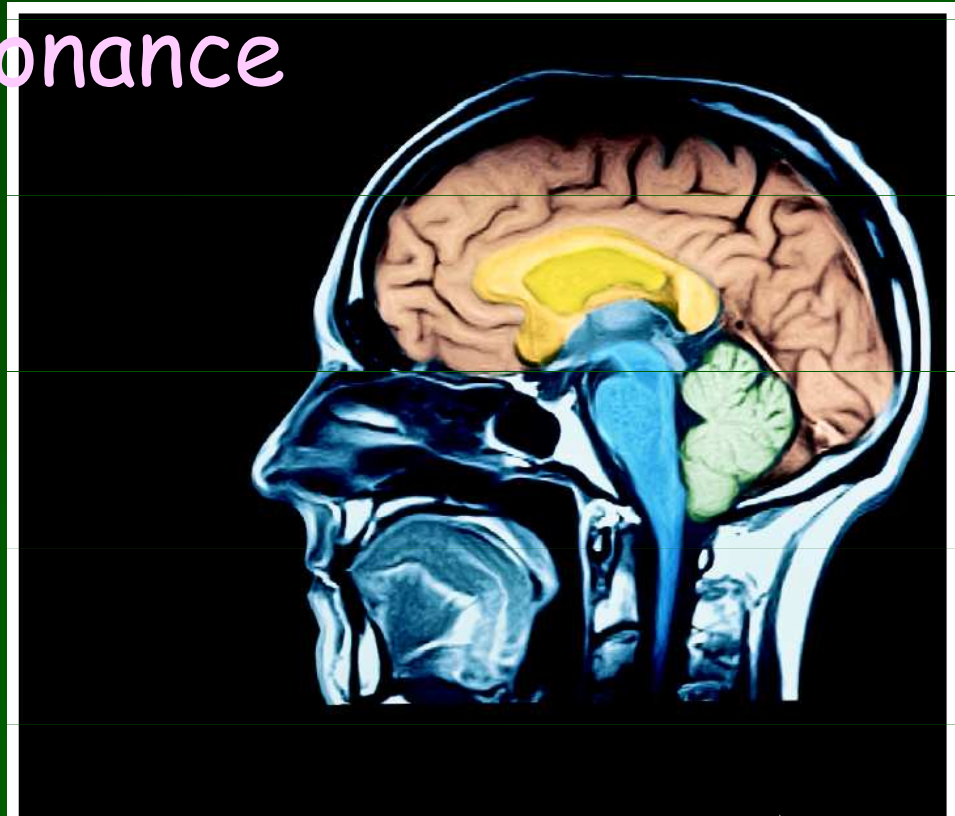

Obr. 41.13 Příčný řez lidskou hlavou vytvořený technikou MRI. Některé ze zobrazených detailů není možné získat ani při použití nejmodernějšího rentgenového tomografu CT (z anglického *computerized tomography*).

... a na začátek nového

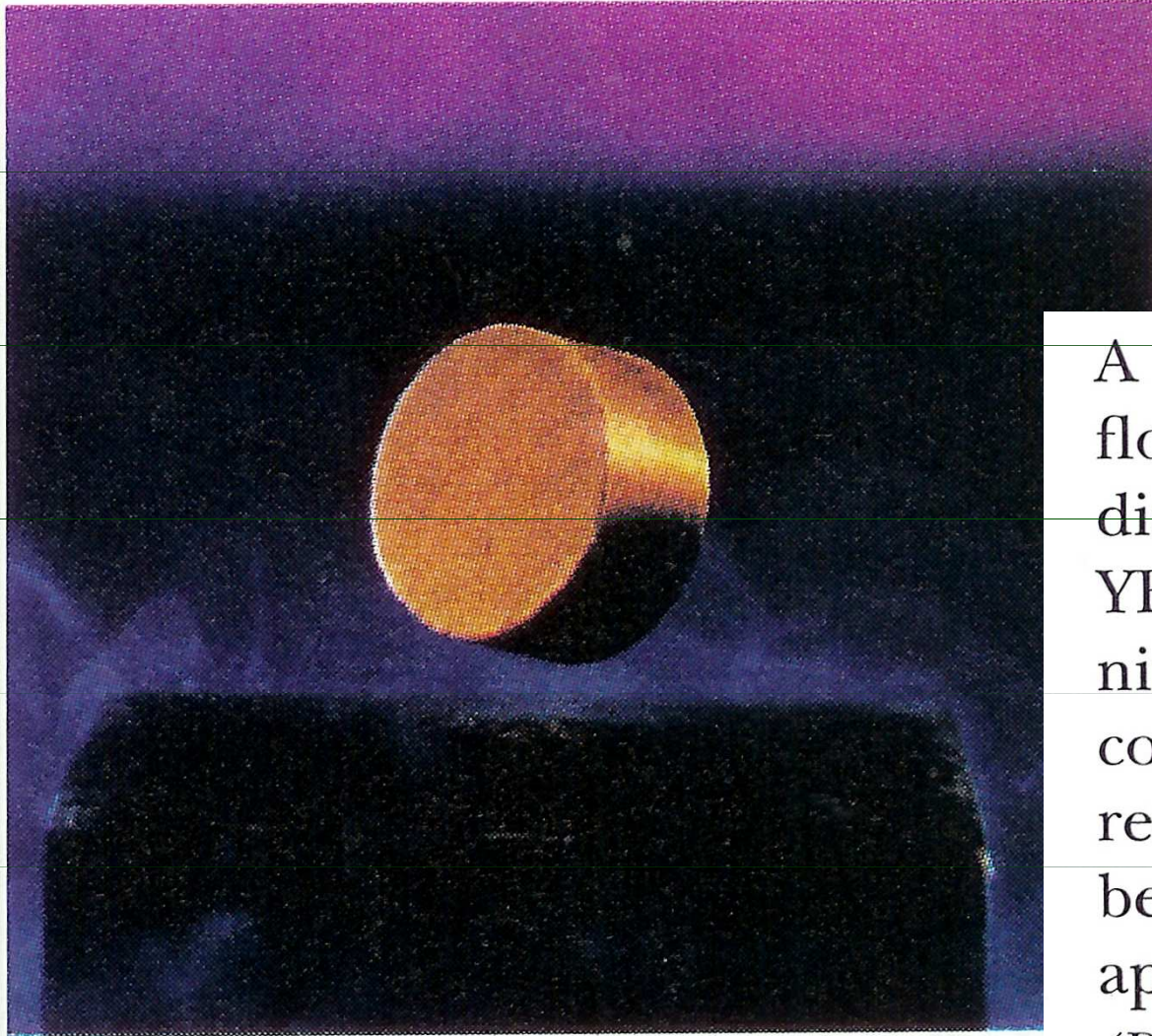

A small permanent magnet floats freely above a ceramic disk of the superconductor $\text{YBa}_2\text{Cu}_3\text{O}_7$ cooled by liquid nitrogen at 77 K. The superconductor has zero electric resistance at temperatures below 92 K and expels any applied magnetic field.

*(D.O.E./Science Source/Photo
Researchers)*