

Chemie životního prostředí II

Chemie technosféry a atmosféry

(II_07)

Technosféra – Difuzní zdroje znečištění prostředí

Ivan Holoubek

RECETOX, Masaryk University, Brno, CR

holoubek@recetox.muni.cz; <http://recetox.muni.cz>



evropský
sociální
fond v ČR



EVROPSKÁ UNIE



MINISTERSTVO ŠKOLSTVÍ,
MLÁDEŽE A TĚLOVÝCHOVY



OP Vzdělávání
pro konkurenceschopnost



INVESTICE DO ROZVOJE VZDĚLÁVÁNÍ

Prašnost

Exhalace z dopravy

Otevřené spalování

Záchyt tuhých příměsí

Technicky většinou dobře řešitelné

Emise tuhých částic:

- ↪ opracování kamene
- ↪ zpracování zeminy
- ↪ metalurgie
- ↪ energetika

Záchyt tuhých příměsí

Nežádoucí:

- ↪ Spalovny – ekologicky
- ↪ Chemický průmysl - technologicky

Důležité vlastnosti:

- ↪ velikost – 0,01 – 1000 μm
- ↪ částice jedné velikosti – mono-disperzní systém – výjimečně
- ↪ částice – různé – polydisperzní systém

Záchyt tuhých příměsí

Princip třídění

Postupné vynášení částic ze základního souboru plynem nebo kapalinou o postupně zvyšované rychlosti

Prach

Koncentrace, měrná hmotnost, lepivost, abrasivost

Odlučovače

Tvar částic, měrný povrch, permitivita, elektrický náboj a odpor, smáčivost, explozivnost...

Záchyt tuhých příměsí

Zařízení:

- ↪ Odlučovače mechanické – suché, mokré
- ↪ Odlučovače elektrické – suché, mokré
- ↪ Filtry

Účinnost odlučovačů:

Celková odlučivost – váhová % odloučeného prachu + celkové množství prachu

Frakční odlučivost – odloučení určité frakce o určité velikosti

Mez odlučivosti – rozměr částice, P₅₀, kdy je frakční odlučivost rovná 50%

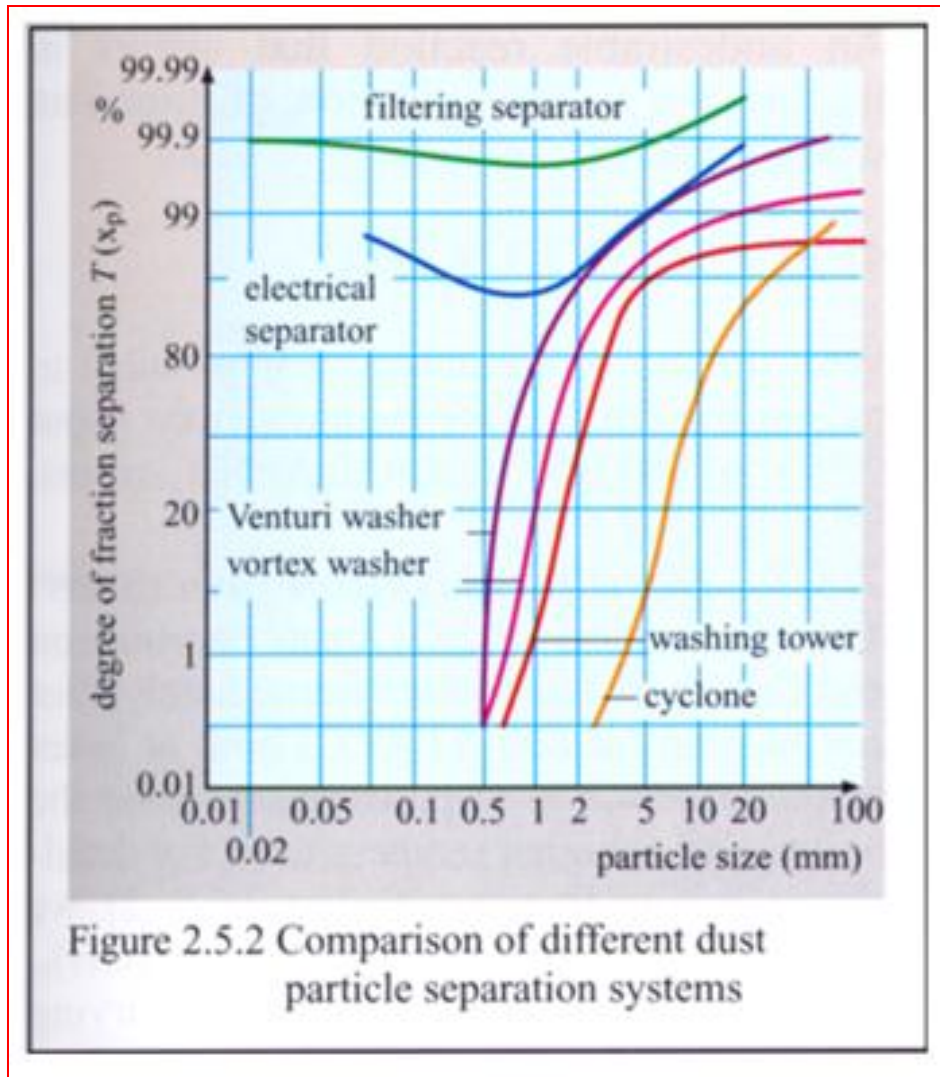

Ostatní exhalace

Domácí topeniště – náhrada tuhých paliv plynnými, elektrickými a centrálním zásobováním

Exhalace z průmyslových podniků

Velká variabilita zdrojů

↪ Typ a koncentrace produkované škodliviny

↪ Emisní podmínky

- množství odplynů
- jejich teplota, tlak, složení
- obsah tuhých příměsí
- obsah agresivních látek

Metody likvidace škodlivin v odpadních plynech

↪ mokré – absorpce

↪ suché – adsorpce
- termická likvidace
- katalytická likvidace

↪ biologické

Exhalace v dopravě

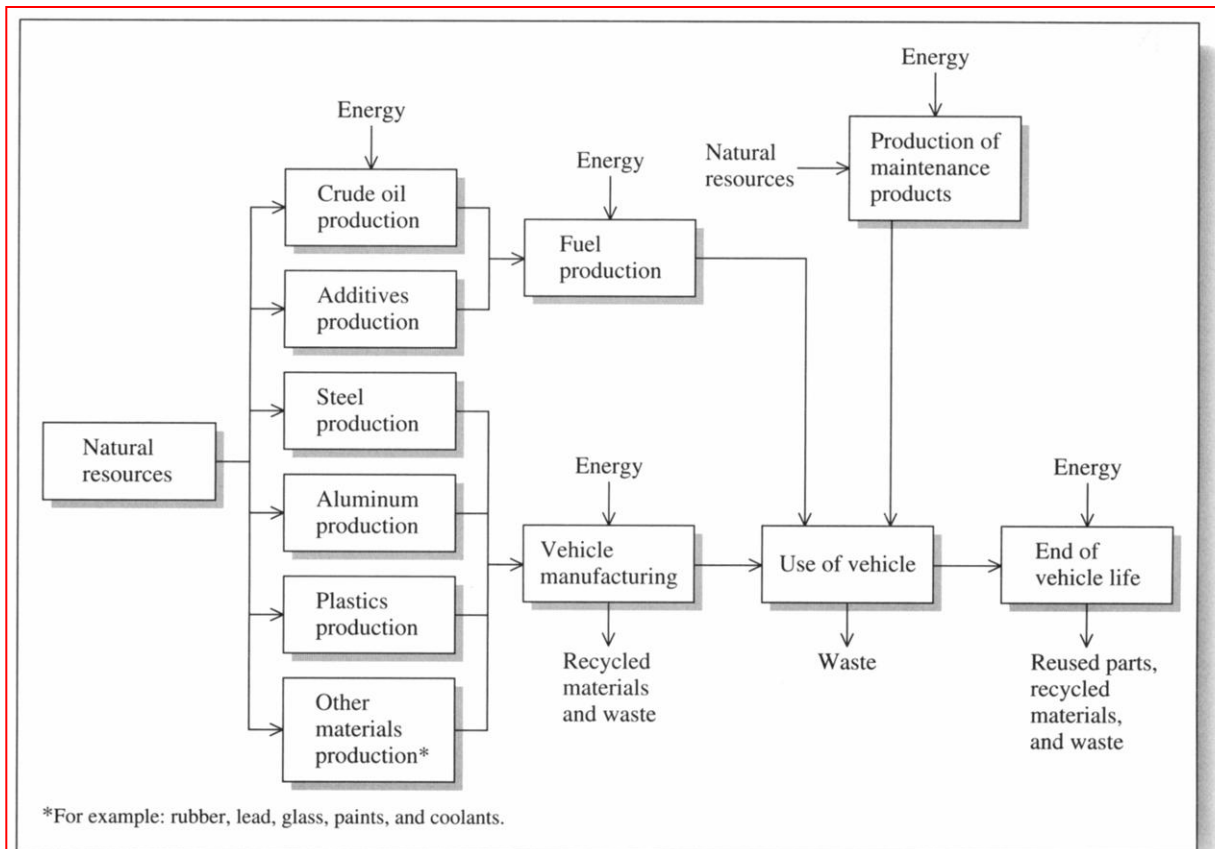

Figure 10-12

Important input and output components in life cycle assessments of motor vehicles. (Source: M. Freemantle. Total life-cycle analysis harnessed to generate "greener" automobiles. *Chemical & Engineering News* November 27, 1995: 25.)

Exhalace v dopravě

Automobilová doprava – dominantní 70 %

Největší znečišťovatel ~ 3 mld automobilů

1 vozidlo ~ 12 t škodlivin ročně

~ 700 kg CO

100 kg HCs

35 kg NO_x

PAHs, Pb, RCHO

Exhalace v dopravě

Zážehové motory – směs paliva a vzduchu je nejprve ve válci stlačena a pak zapálena elektrickou jiskrou:

- ↪ **karburační** – směs se připravuje při plnění válce
- ↪ **vstřikovací** – palivo se vstřikuje do komprimovaného vzduchu ve válci na začátku komprese

14,5 – 15 kg na 1 kg paliva

Nedokonalé spalování \Rightarrow RH, CO

Oxidace \Rightarrow RCHO, NO_x

Vysoká T, p \Rightarrow PAHs

Exhalace v dopravě

Vznětové motory - nemají karburátor ani elektrickou iniciaci – zapálení paliva – vstřikování do stlačeného vzduchu, jehož teplota kompresí dosáhla meze zápalnosti.

Nutný vysoký přebytek vzduchu:

~ 20% - tvorba sazí

~ 60% - dokonalejší spalování – více NO_x

Exhalace v dopravě

Vliv konstrukce motoru na obsah škodlivin ve výfukových plynech

Zážehové motory:

- ↪ úprava motoru
- ↪ snížení obsahu škodlivin ve výfukových plynech - lze kombinovat
- ↪ opatření týkající se změn ve složení paliva

Úprava motoru:

1. úpravy vedoucí ke zlepšení přípravy palivové směsi
2. zdokonalení zapalování
3. recirkulace výfukových plynů
4. snížení tolerancí ve spalovací části motoru
5. přechod na chudé směsi

Exhalace v dopravě

Vznětové motory

Emise škodlivin = funkce (konstrukce spalovací komory)

- ↪ osobní - motory s tlakovou předkomůrkou
- ↪ nákladní – přímý vstřik paliva do válce ⇒ nižší spotřeba, vyšší emise, hlučnost

Turbomotory – přeplňovaný vznětový motor

Spalovací vzduch je vháněn pod tlakem pomocí turbodmýchadla hnaného energií výfukových plynů

Příznivější spotřeba snížení emisí

Emise ze spalování vegetace

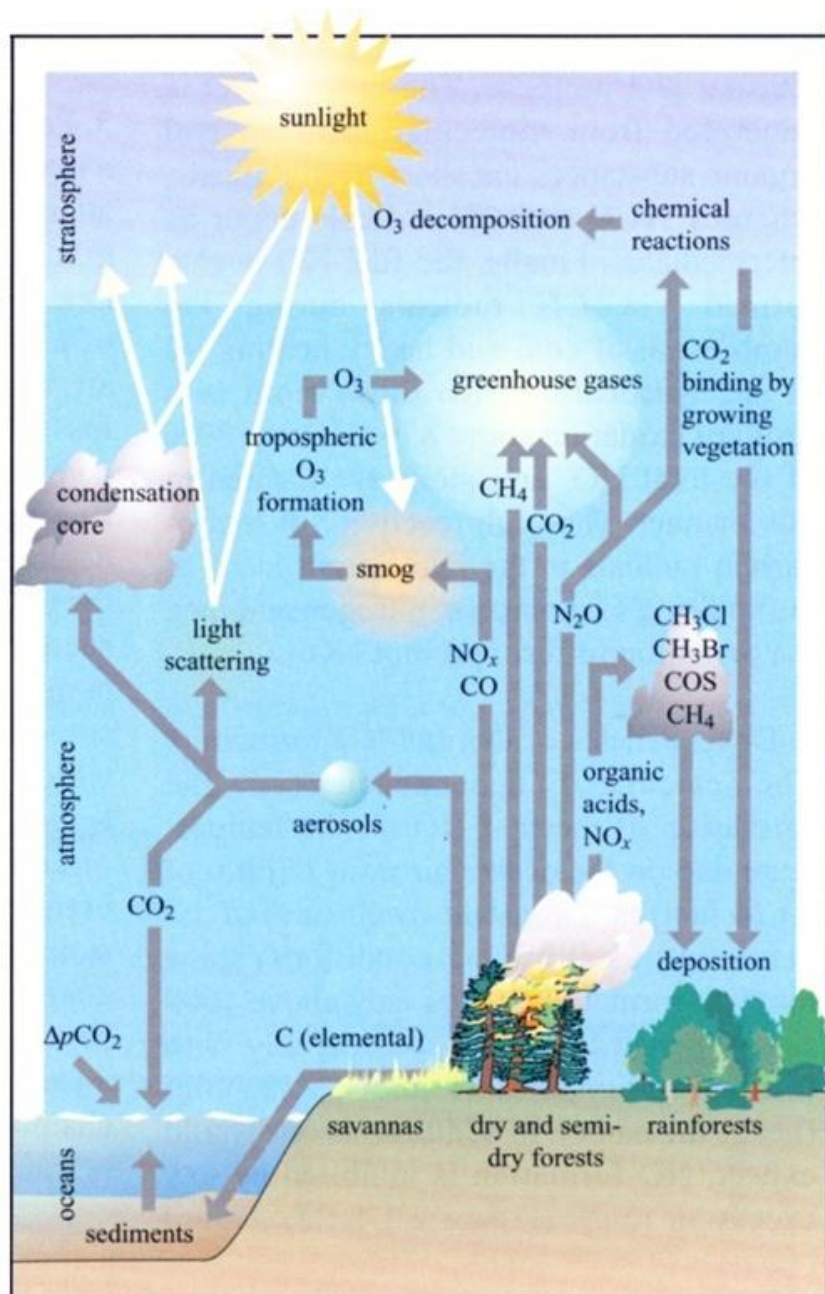

Figure 2.3.3 Emissions from burning vegetation

for Toxic Compounds in the Environment

<http://recetox.muni.cz>

Přírodní zdroje znečištění ovzduší



Figure 3.10. Natural forest fire in Yellowstone National Park on August 1, 1988. Emissions from the fire include gases (e.g., carbon dioxide, carbon monoxide, nitric oxide, organics) and aerosol particles (e.g., soot, organic matter). Photo by U.S. Forest Service, available from National Renewable Energy Laboratory.

Přírodní zdroje znečištění ovzduší



Figure 5.7. Soot emissions from a prescribed burn at Horse Creek Mesa, Big Horn National Forest, Wyoming, October 9, 1981. Photo by U.S. Forest Service staff, available from the National Renewable Energy Laboratory.

Přírodní zdroje znečištění ovzduší



Figure 5.4. Dome-shattering eruption from Mount St. Helens in the fall of 1982. Photo by Peter Frenzen, available from Mount St. Helens National Monument photo gallery.

Atmosféra – znečištění ze spalování odpadů

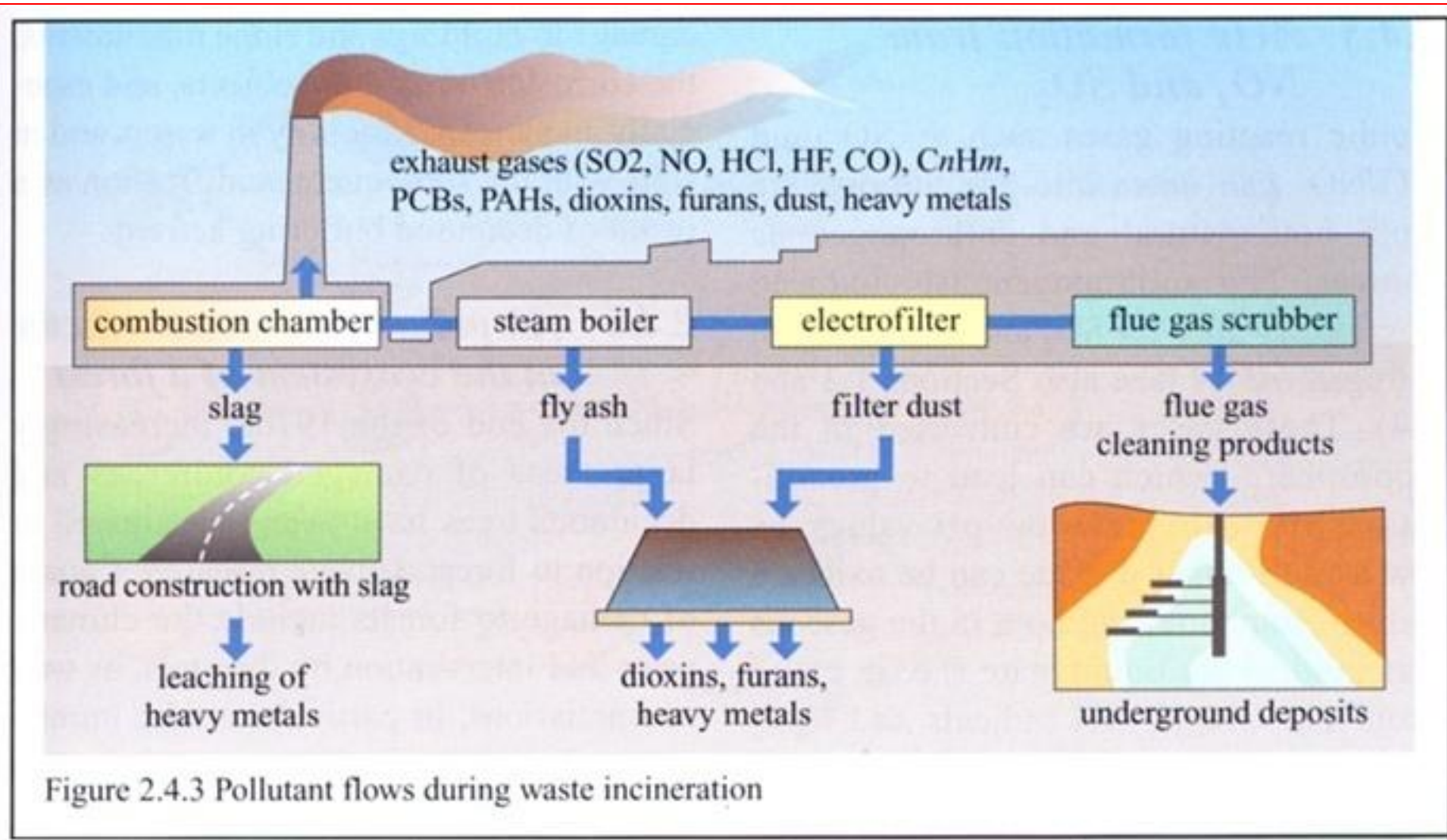

Emission of dioxin-like chemicals from open combustion (ie bushfires)?

Jochen Mueller



Outline of this talk

Background on the emission of dioxins from combustion processes

Experiments and results on emission of dioxins from bushfires in Australia

How we can explain our findings

Some lessons learned

Unintentionally produced POPs

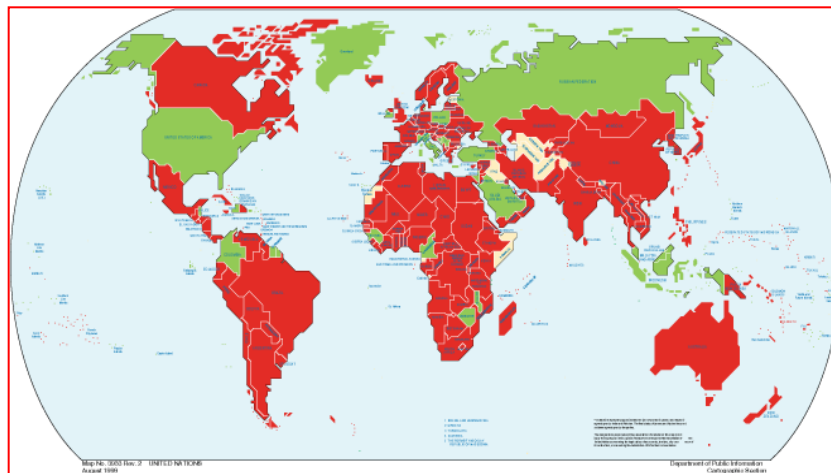

 Stockholm Convention
on persistent organic
pollutants (POPs)

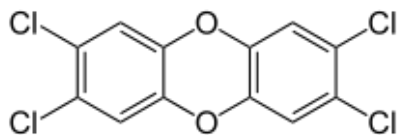

TCDD

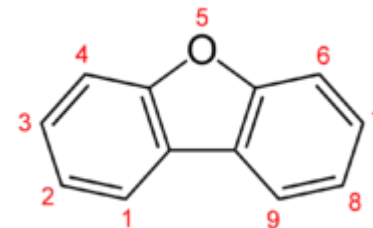

PCDFs

Dioxins and Furans → Not intentionally made

A bit of dioxin history....

Late 18th century – Soda industry starts

~ 1890 - Chloralkali industry starts

Late 1890s - Chloracne is described and named

1911 – German chemists synthesised PCDDs

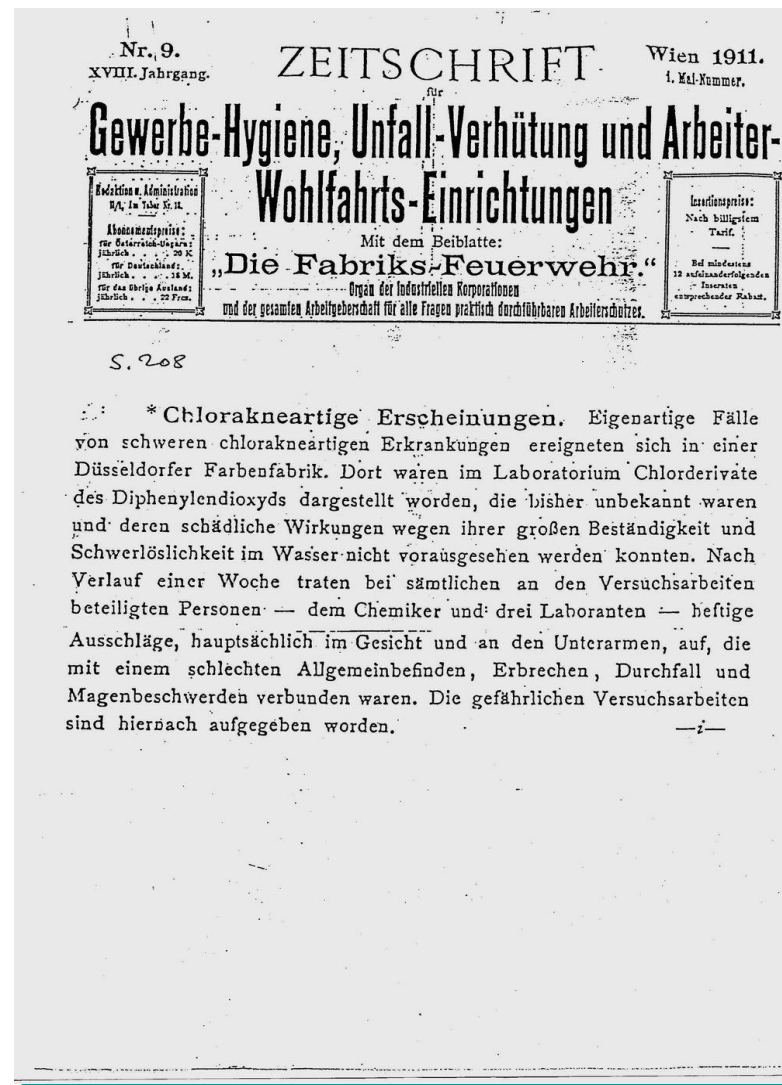

Ollie et al. found dioxins in flyash

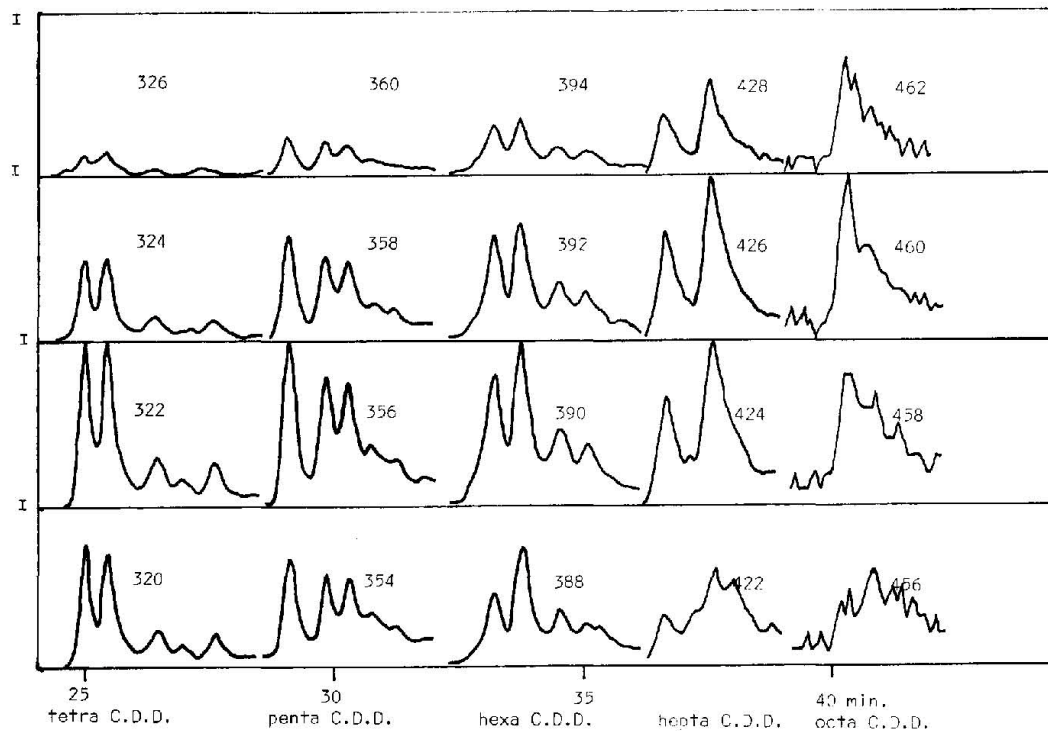

The masses which are monitored are given in the figure. 2,3,7,8-Tetrachlorodibenzo-p-dioxin had a retention time identical to the peak at 27.8 min.

No. 8

The key question - 'natural' or 'anthropogenic'

- Lots of debate... opinion including emotions
- It lead us to the work on emissions of dioxins from bush fire (not much published).

Fire plays important role in Australia's ecology

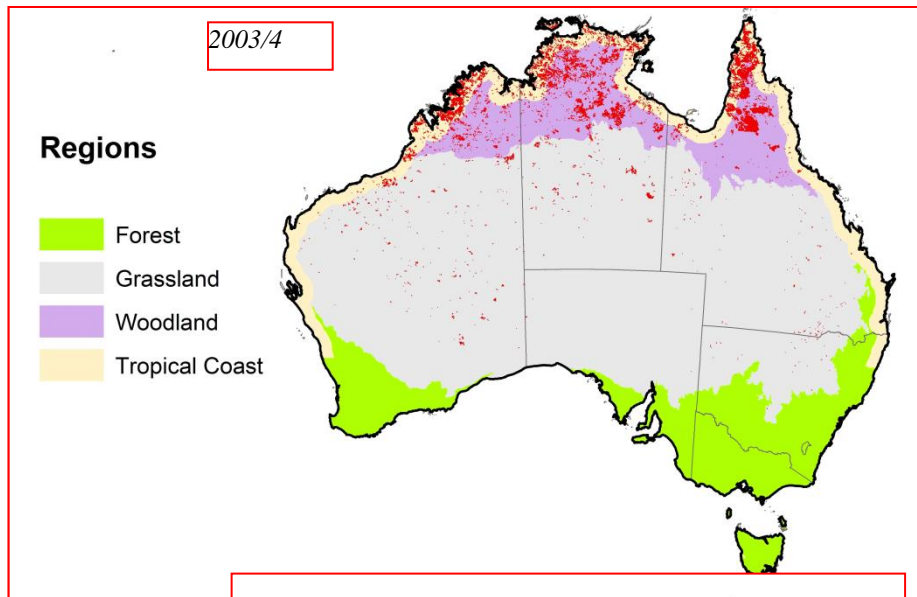

Estimate of biomass
combusted 2005

Approx. 160 000 Kt (only
about 6 000 Kt from
agriculture - most in the
NORTH (Savannah))

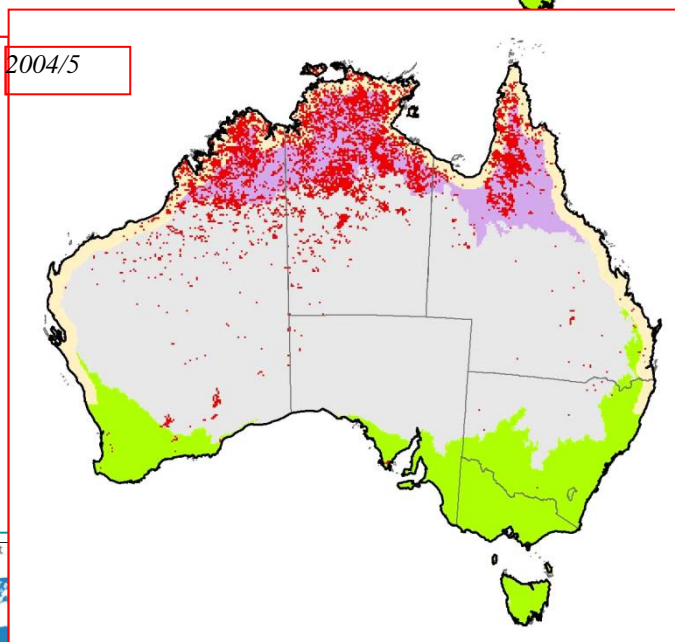

Bushfire as a source for dioxins in Australia was on the agenda before already

- ↪ 1998 desktop audit suggested > 80 % of dioxin emission in Australia from bushfire
- ↪ No field data...
- ↪ Very limited emission factors measured!

EA Study, 1998

Other sources

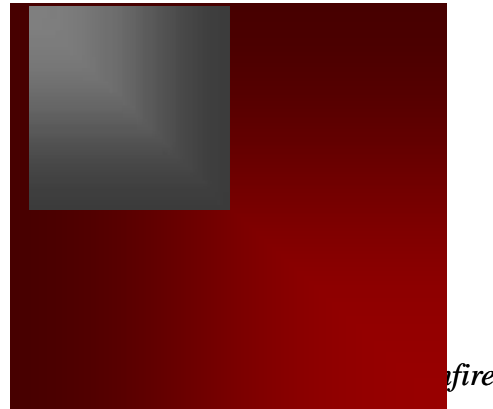

Dioxins from bushfire... first study

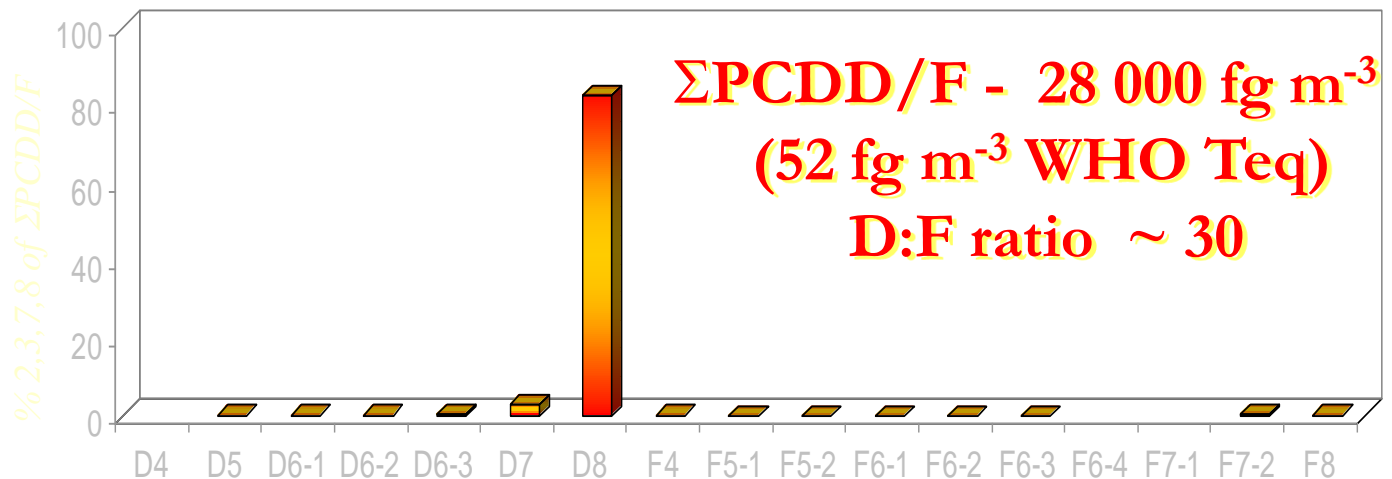
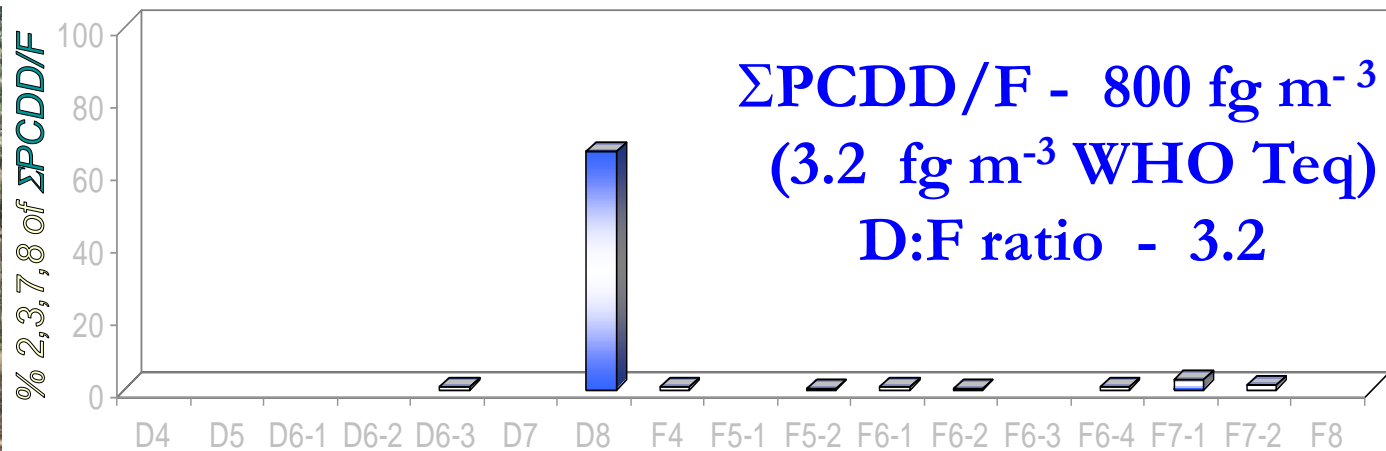
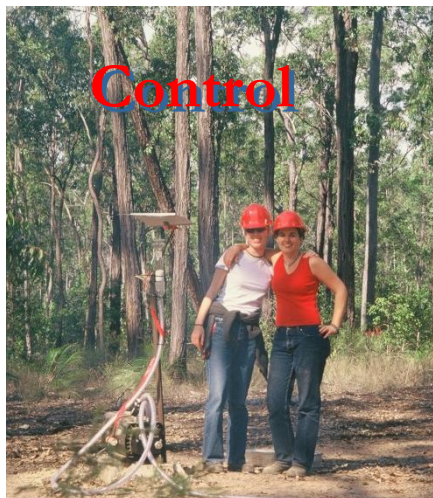

➤ Forest fire result in a substantial increase in atmospheric concentrations of PCDD/Fs

Isomer profiles

TCDF

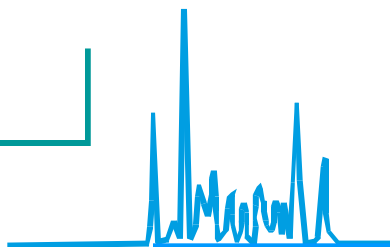

1469, 1678,
1234, 2368

TCDD

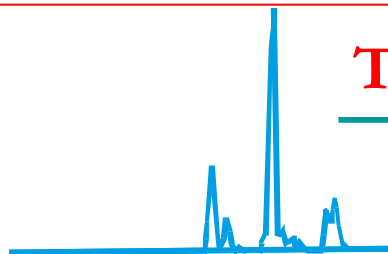

Control
atmosphere



1269, 1236, 1234,
1237,1238

Prescribed burn
atmosphere

→ Formation from precursors ?

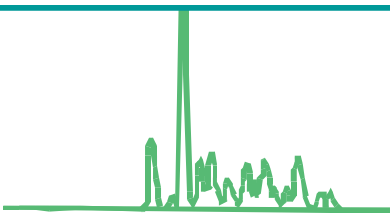
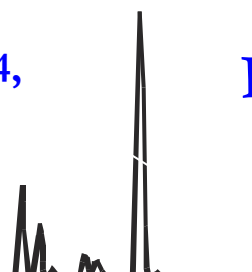

1469, 1678,
1234, 2368

Unburnt leaf
litter

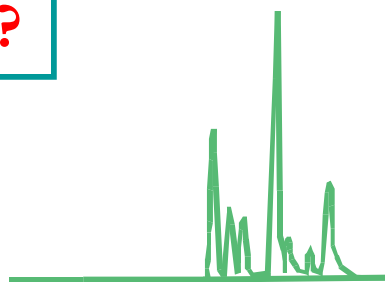

1269, 1236, 1234,
1237,1238

Burnt leaf
litter

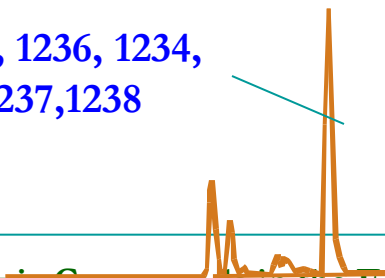
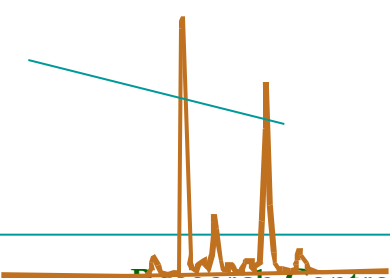

Controlled Experiment

Prange et al. EST 2003

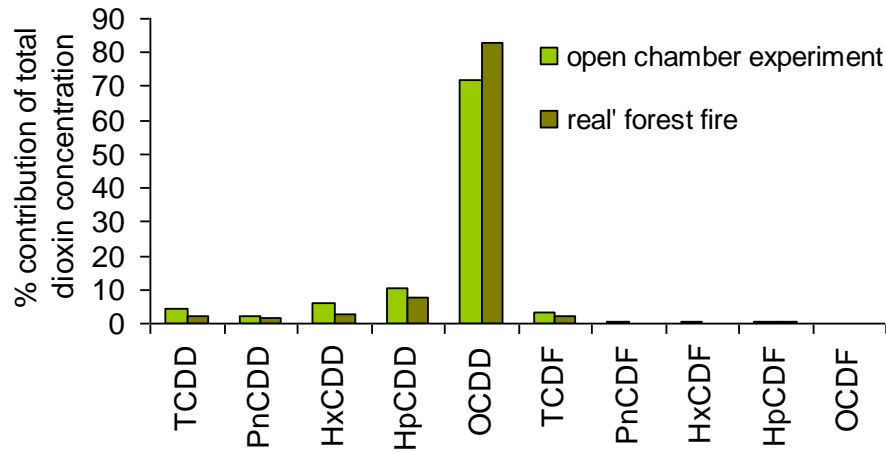
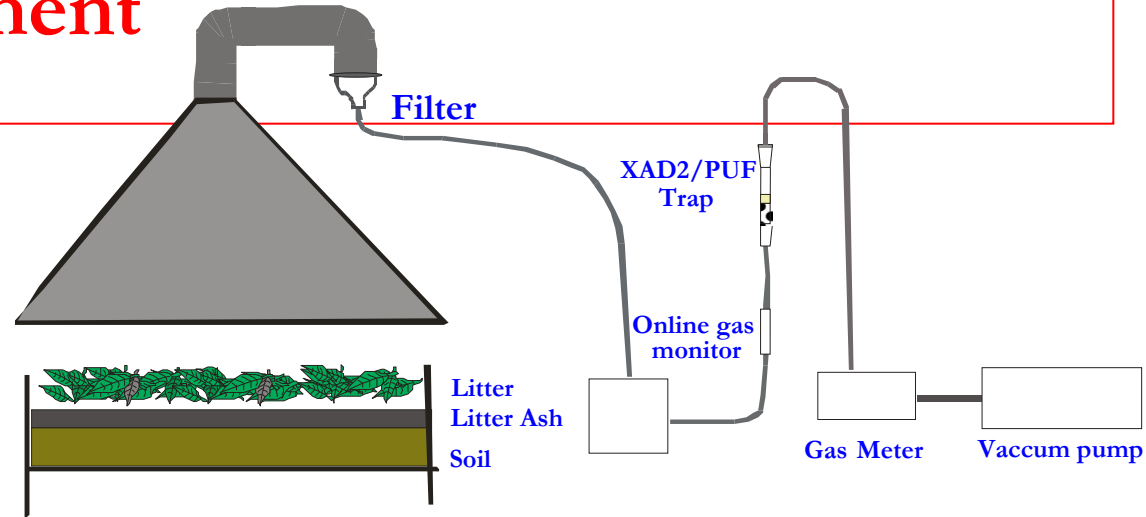

Field and Open chamber Expt –
Very similar profiles

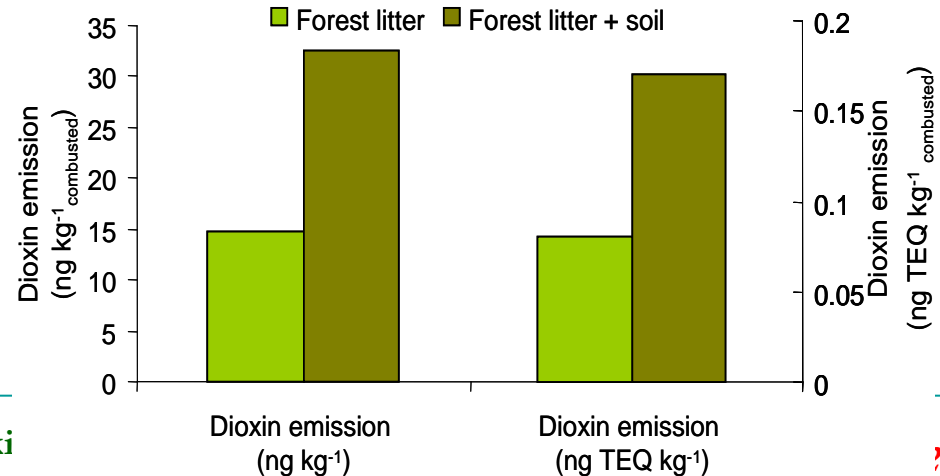

If soil included much higher
emission (re-emission?)

EF < 0.1 ng TEQ/kg dw

Research Centre for Toxi

<http://recetox.muni.cz>

US-EPA studies – with different results

- ↪ Much higher emission than Joelle's study
- ↪ Furans dominate...

Clearly suggested formation happens & key source



Australian National Dioxin Program Bushfire study (2000-2004)

- ↪ Lab and field component covering all kinds of environments and matrix
- ↪ Lab study to provide the 'real' data.... Field study to confirm lab data...
- ↪ Interdisciplinary approach driven by atmospheric scientists

Sampler from the NDP 2004

Quartz Filter



XAD/PUFF
cartridge

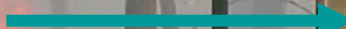

Data logger

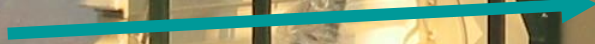

annubar

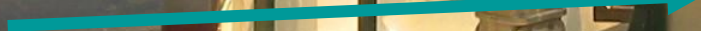

MB1 929
VICTORIA - THE PLACE TO BE

Trailer or truck mounted

Sampling of fires was carried out in the dense smoke plume with a 4 m snorkel



The 2006 sampler (next generation)

Fresh air inlet

Crane truck mounted

Thermocouples in hood
and plenum before
quartz filter

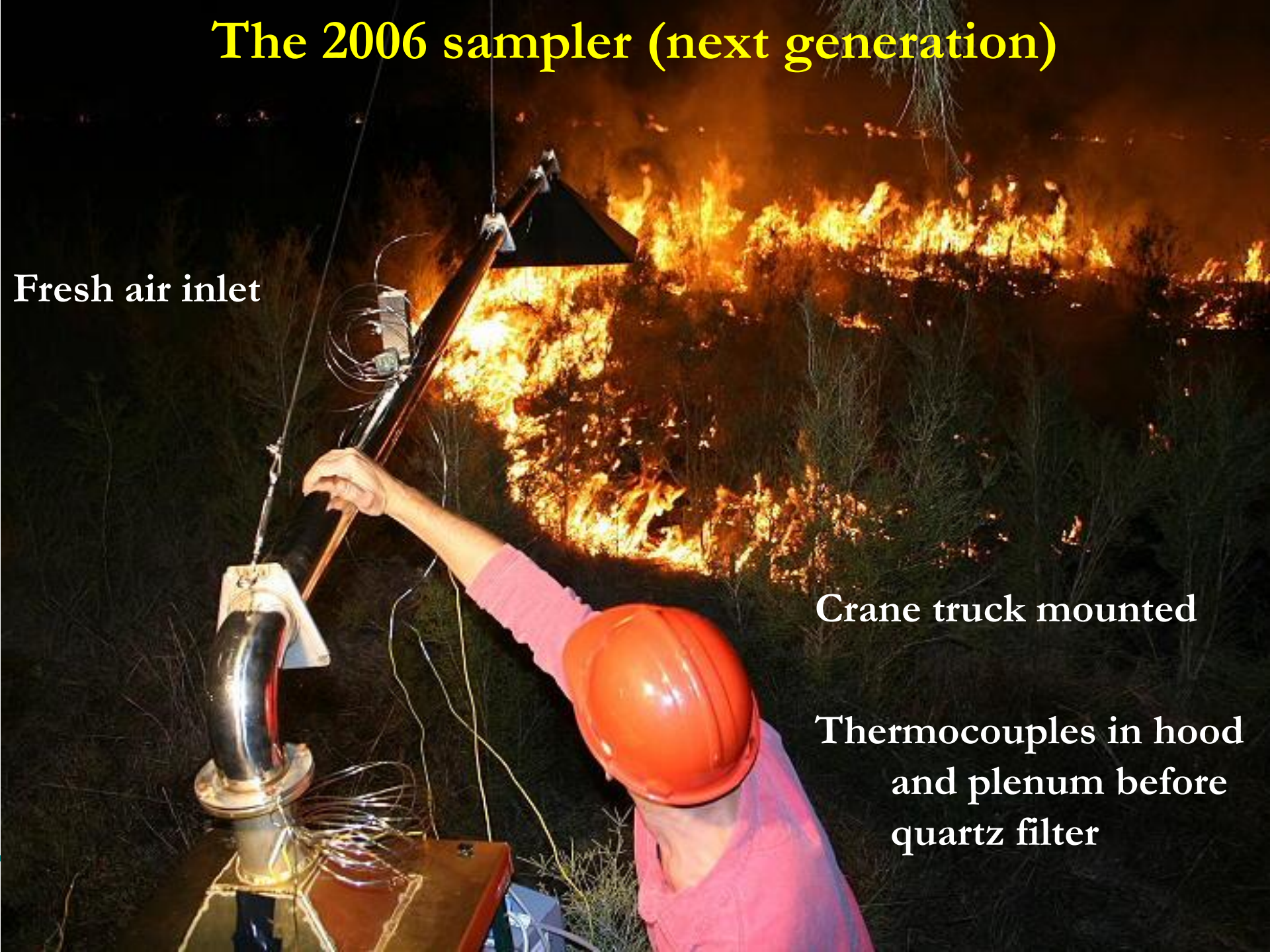

Laboratory sampling

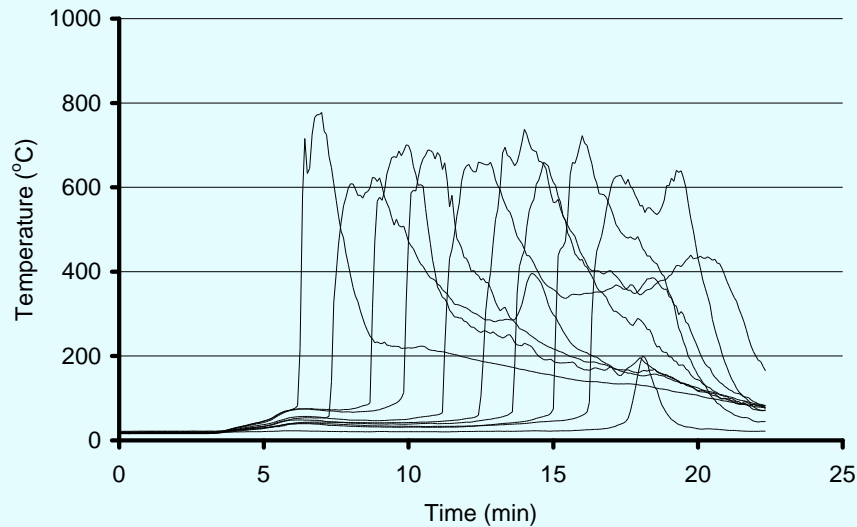
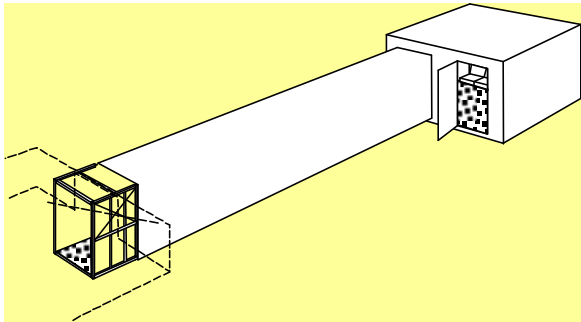

Field work



Mean emission factors for open burning

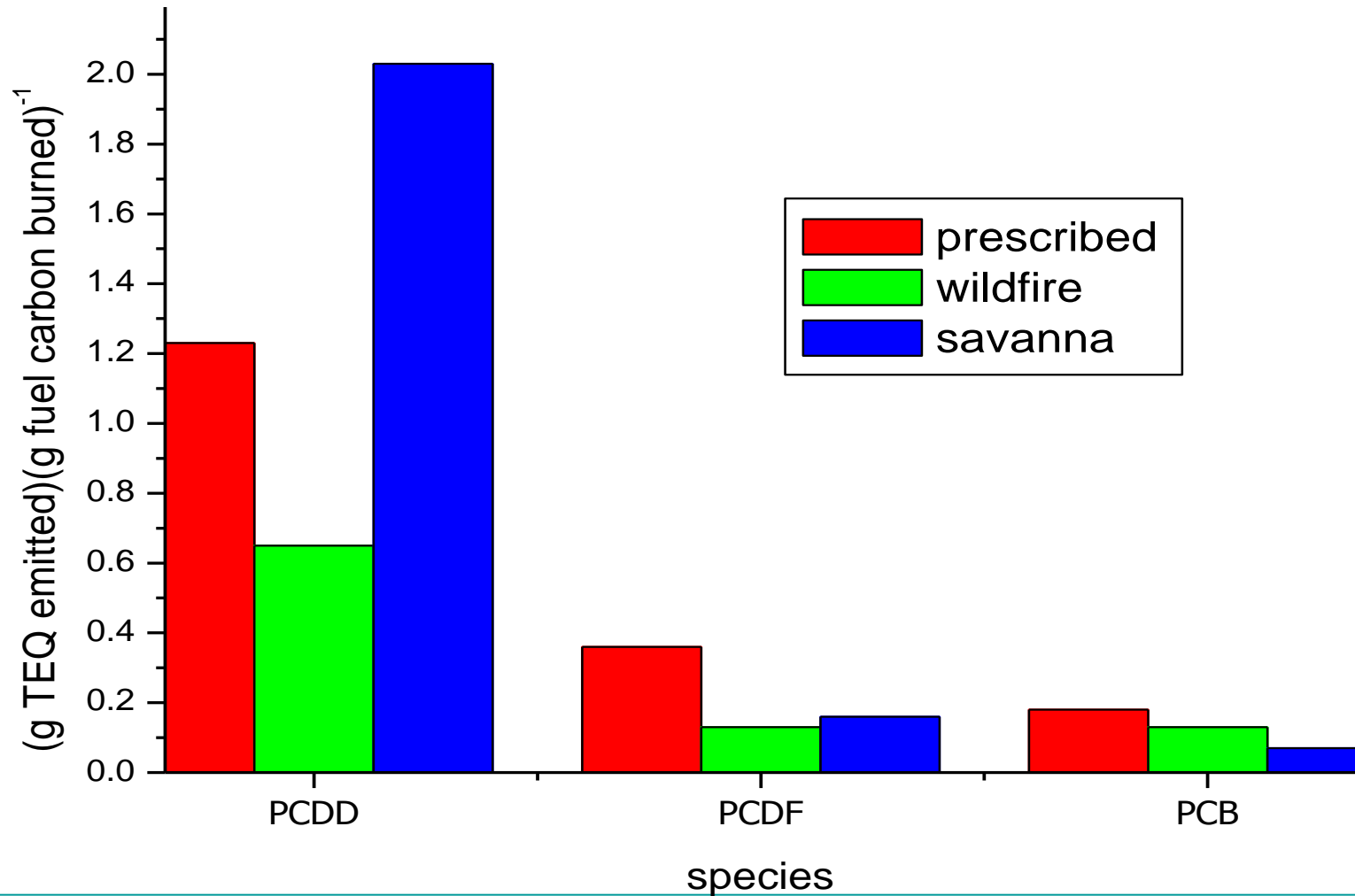

Desk audit v field results

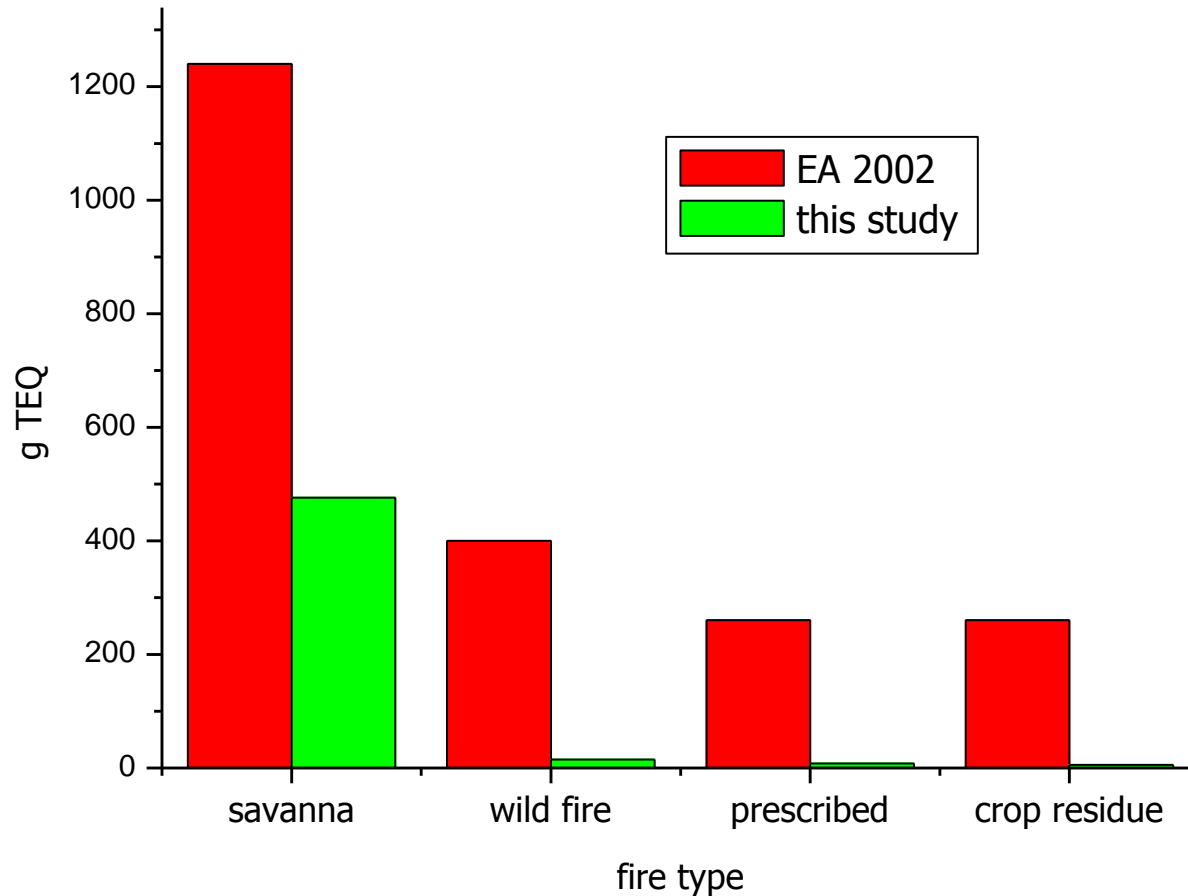

Compare NDP study with US-EPA studies (prior to 2006)

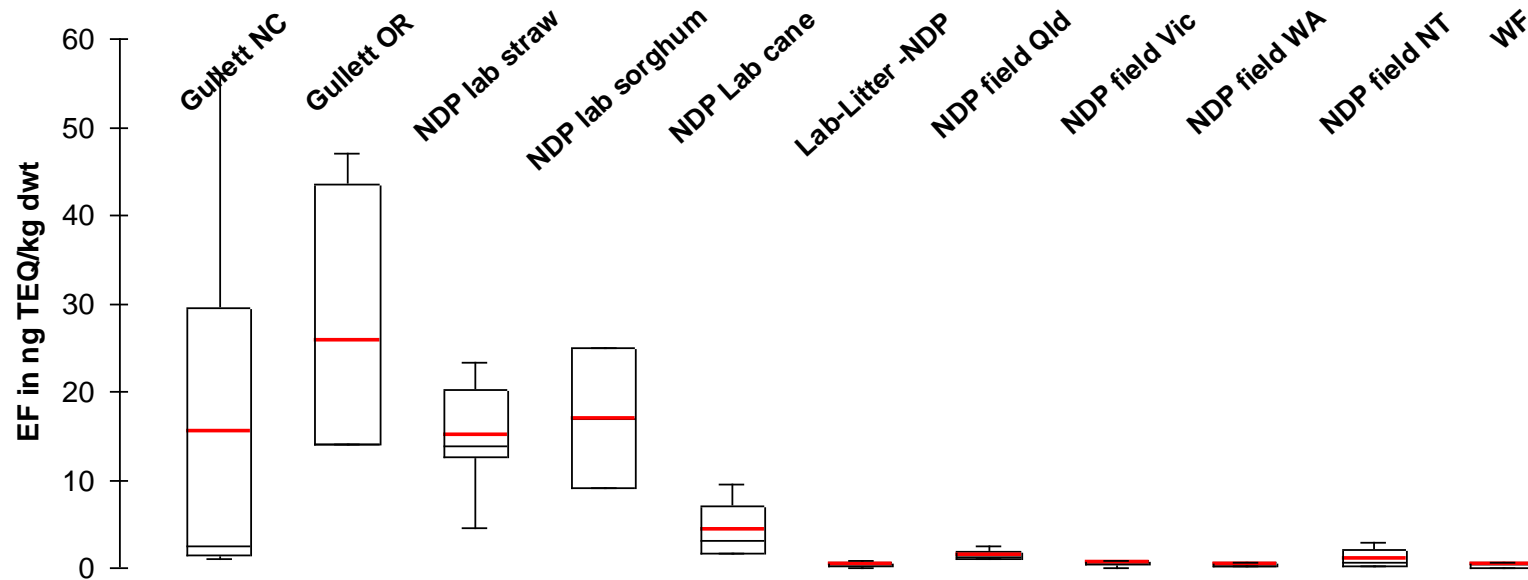

- US-EPA & lab studies higher Emission Factor
- US-EPA & Lab studies MEAN >> MEDIAN
- EF of UNEP tool kit open biomass burning
5 ng TEQ/kg dwt (forest & grass)
30 ng TEQ/kg dwt agricultural fires

Some Outcomes of the NDP study

Laboratory results suggest artefacts include:

- EFs are overestimated (by a lot!!!)
- Cong/Hom profiles are very different

What is going on?

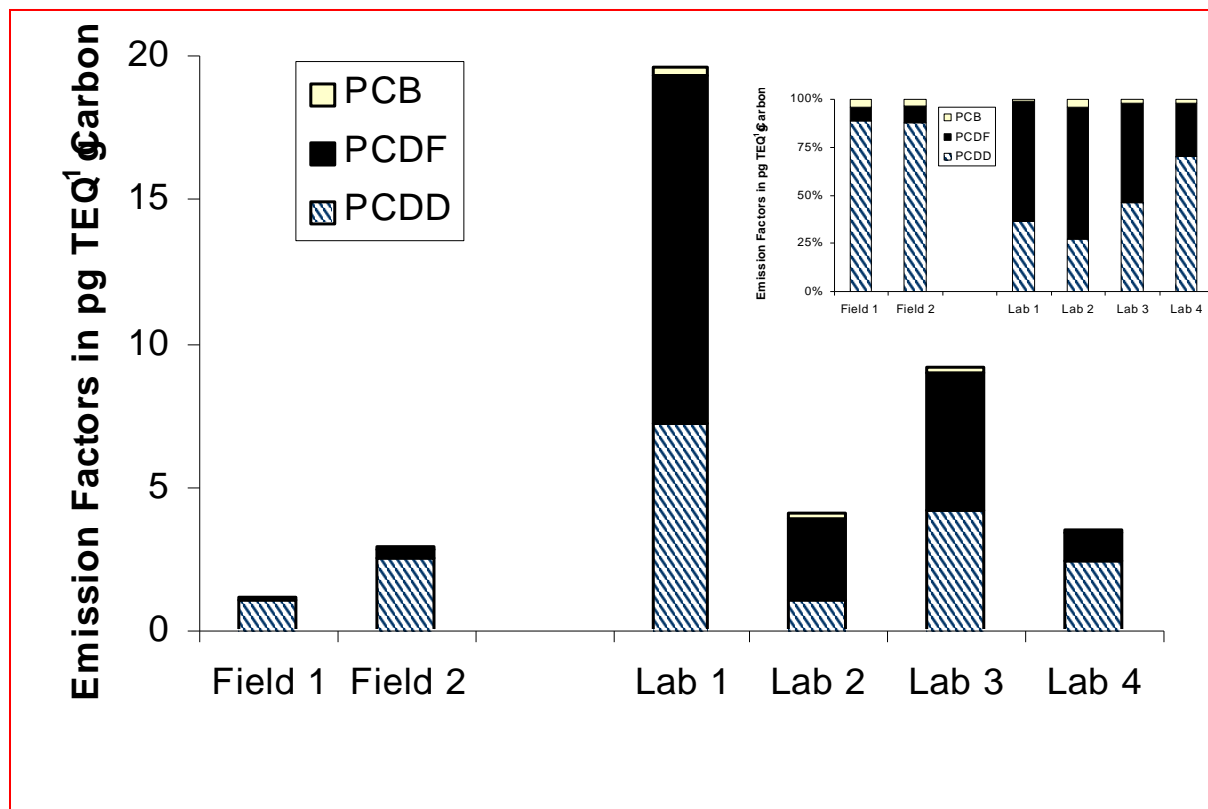

Additional work to clarify (from 05)



15 more fires from 8 Sites

Next generation
sampler

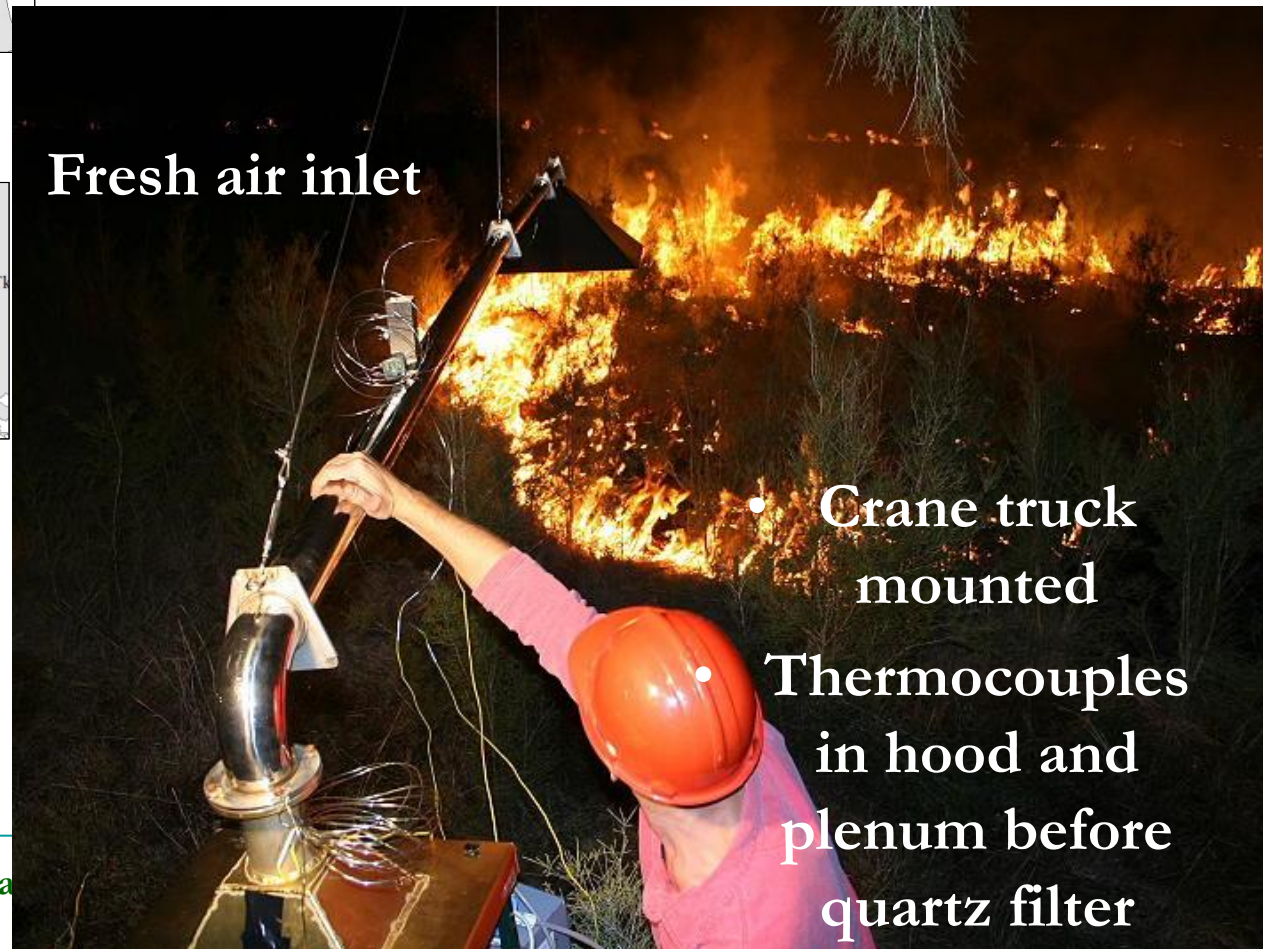

Fresh air inlet

- Crane truck mounted
- Thermocouples in hood and plenum before quartz filter

Research

<http://recctox.mum.cz>

**We provoked an artefact → put the hood too close
→ EF increase**

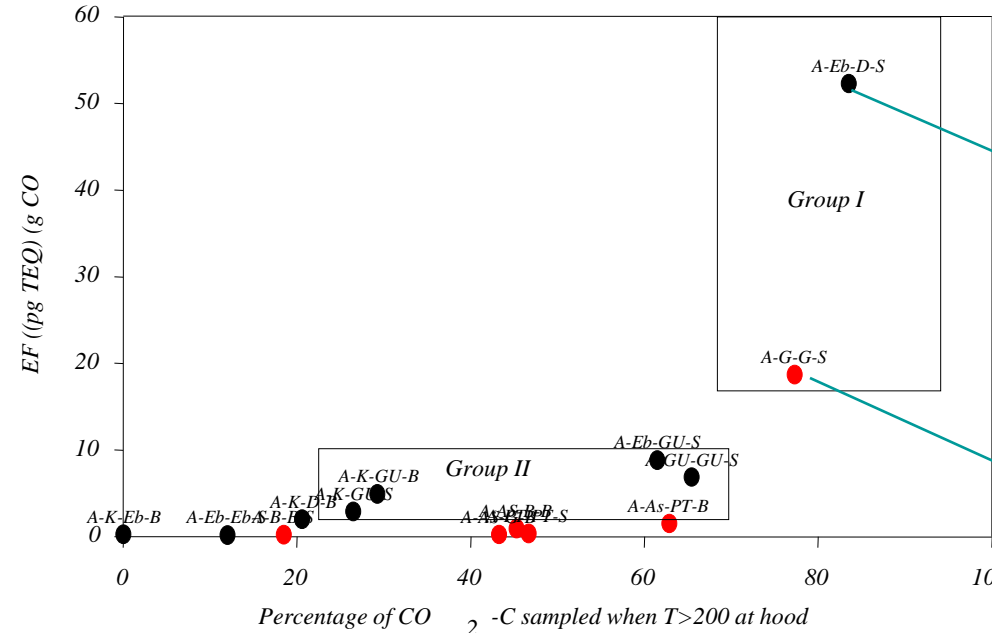

Hot Hood and Lab study group together

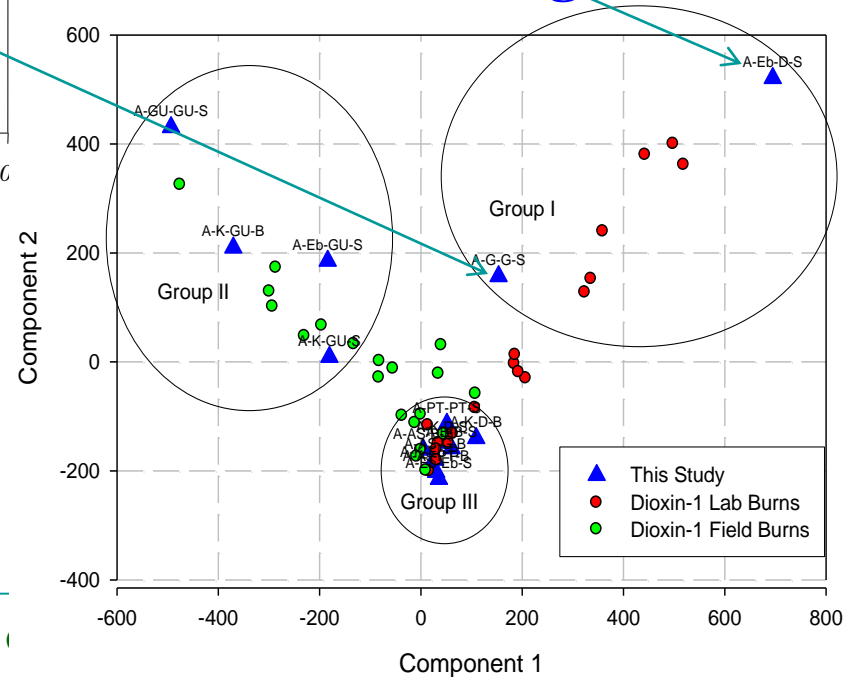

More evidence that Efs are low

We collected routine ambient air samples during bushfire season

The NE fire plume impacted this site

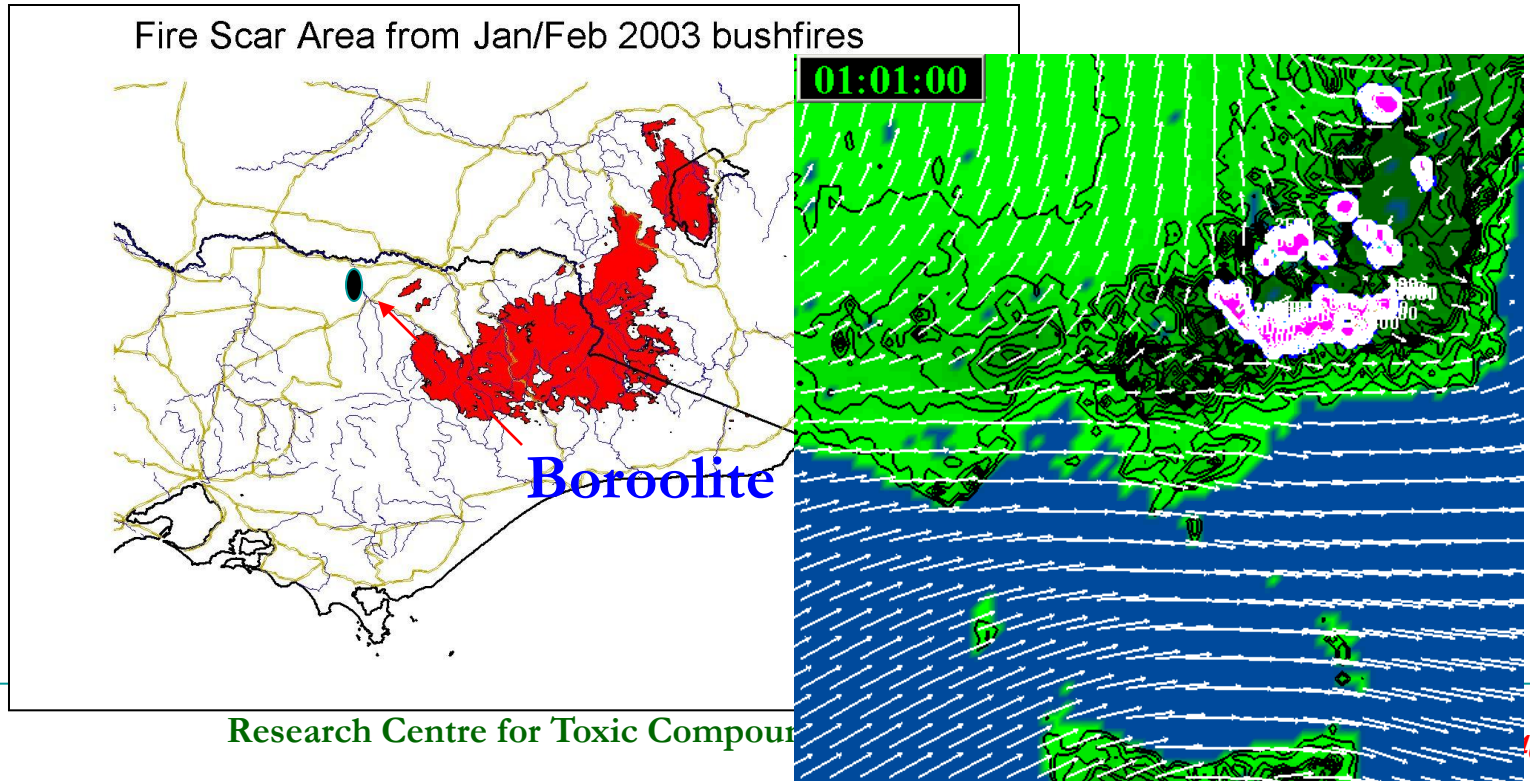

The smoke plume from the NE fires impacted Boroolite in Jan/Feb 2003 with extremely high TSP and NSS-K recorded. PCDD/PCDF concentrations were at background concentrations

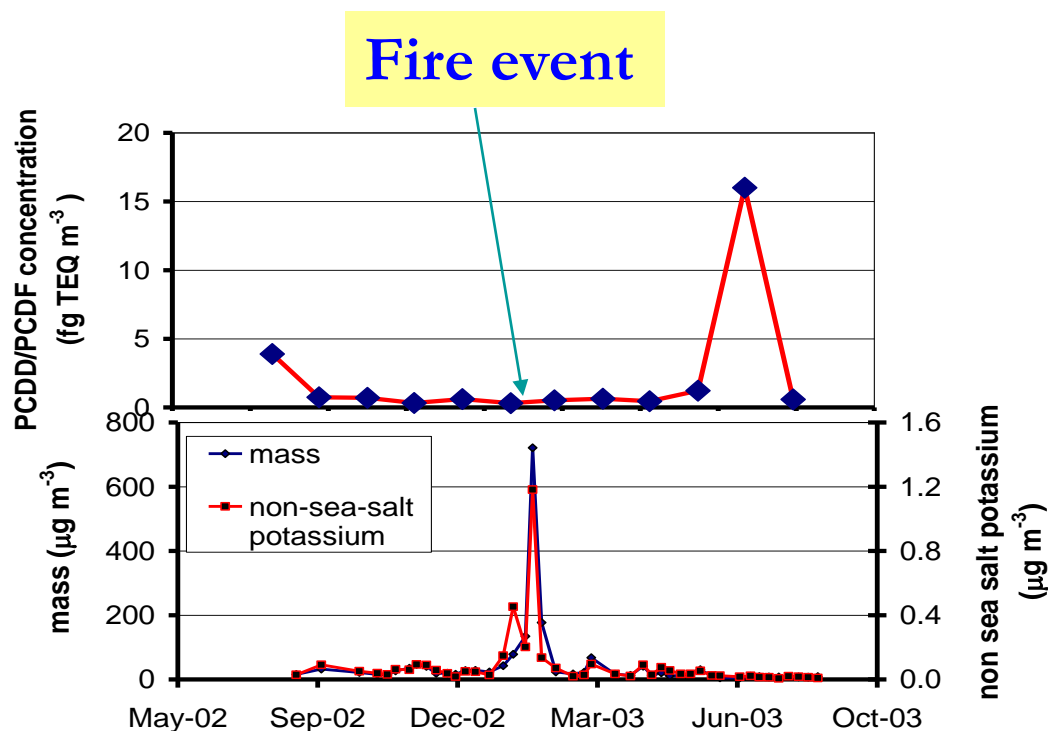

Results further reduced our emission estimates (no inclusion of hot hood data)

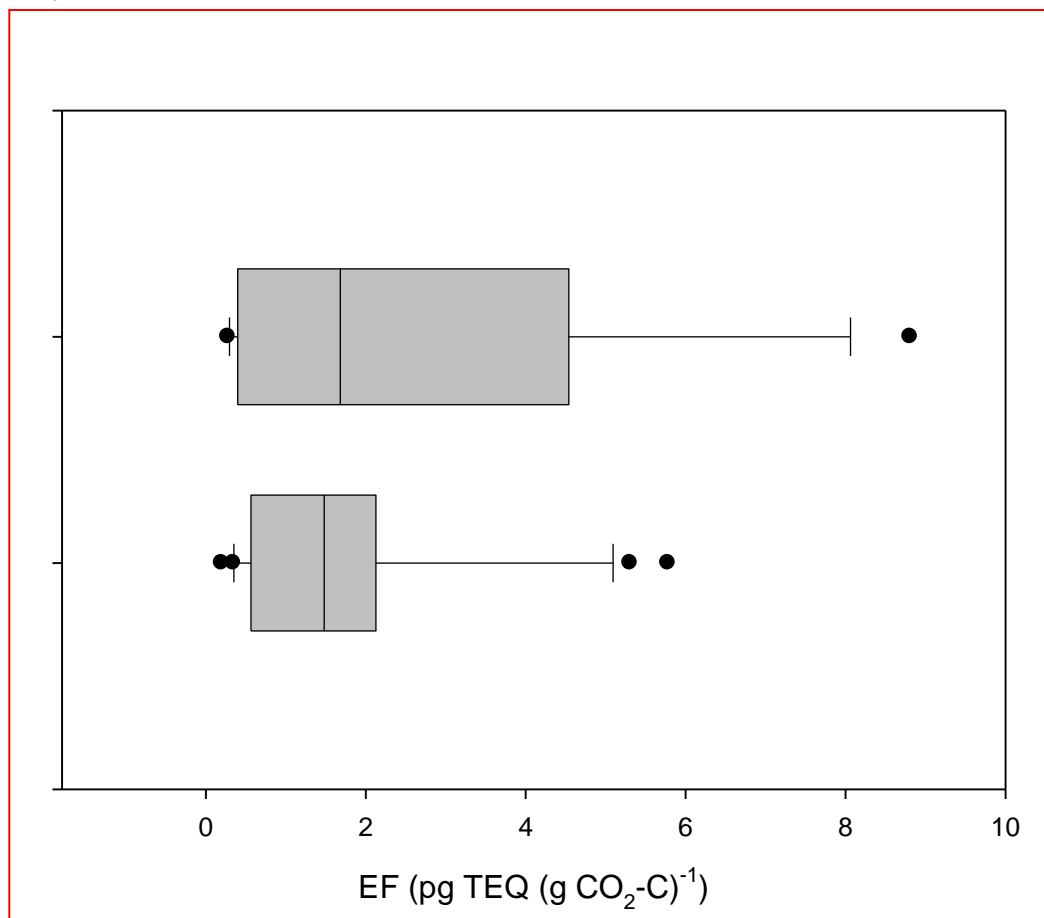

Revised emission estimates (05)

- ↪ Use field-measured emission ratios (means and SDs)
- ↪ Use Monte Carlo analysis with identical uncertainty settings as currently used in NGGI for all but PCDD/PCDF ERs

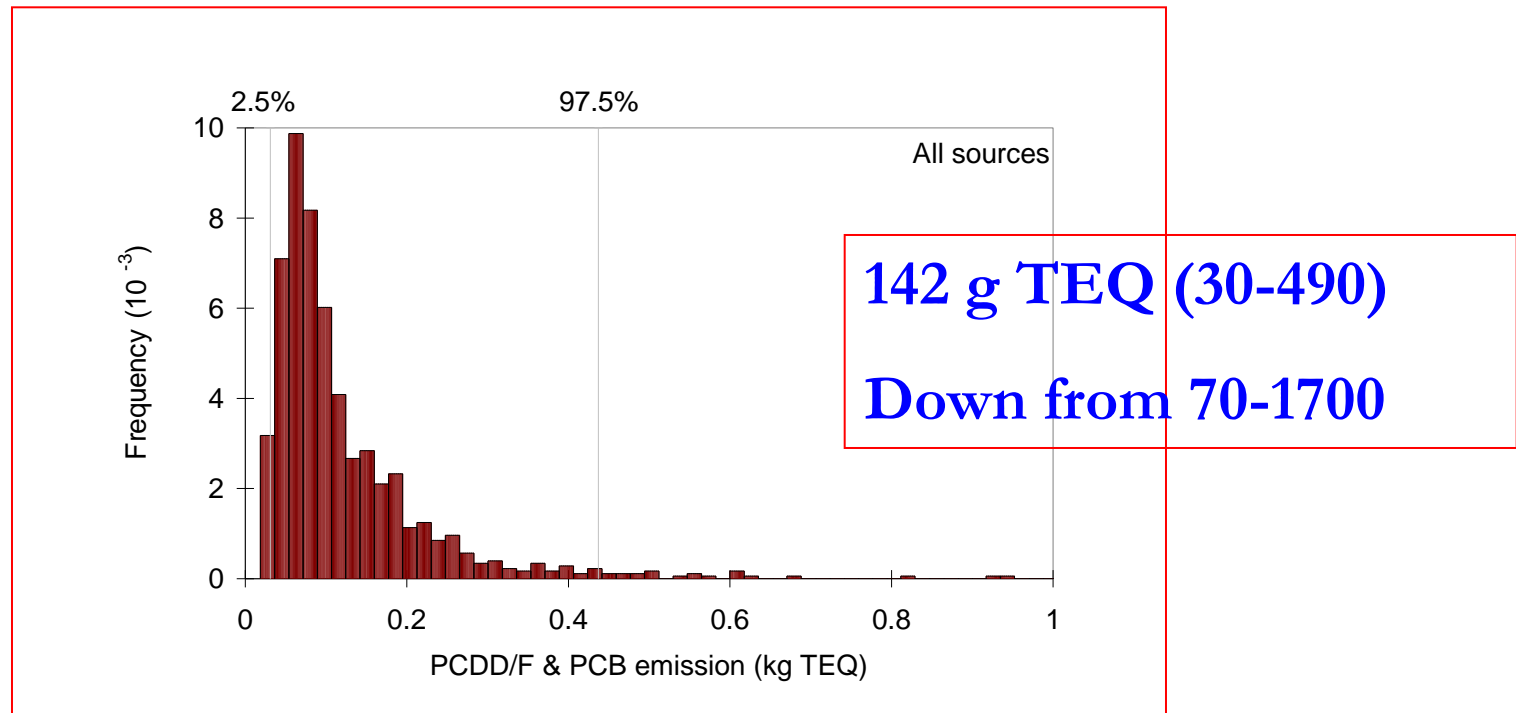

Revision of Emission budget

New estimate 70 % lower than previous estimate

Estimated Emission of DLs into Air from 'Bushfires'

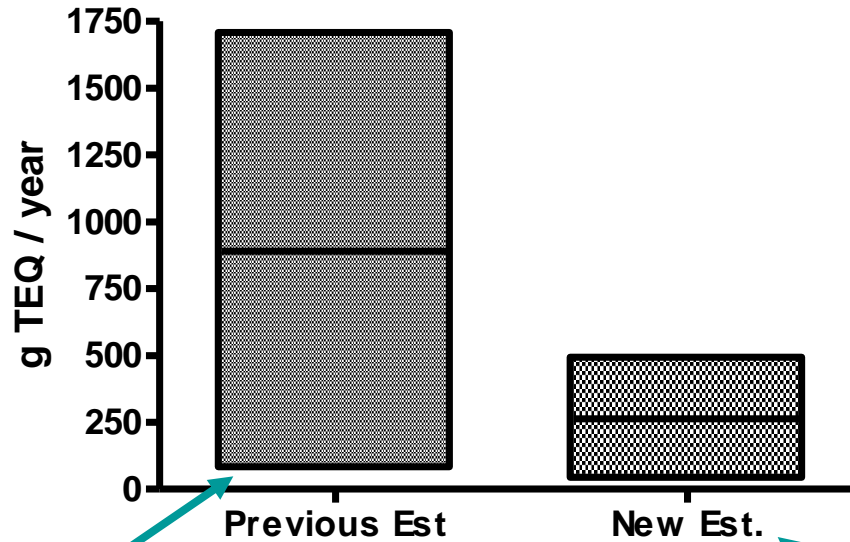

EA Study, 1998

NPD Study, 2003

Other sources

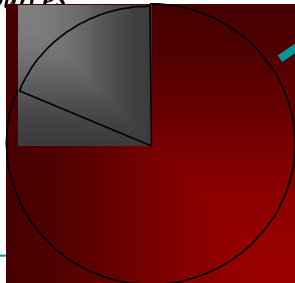

bushfire

Other sources

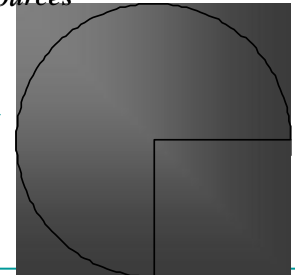

bushfire

Research Centre for Toxic Compounds in the Environment

<http://recetox.muni.cz>



Sources and Trends

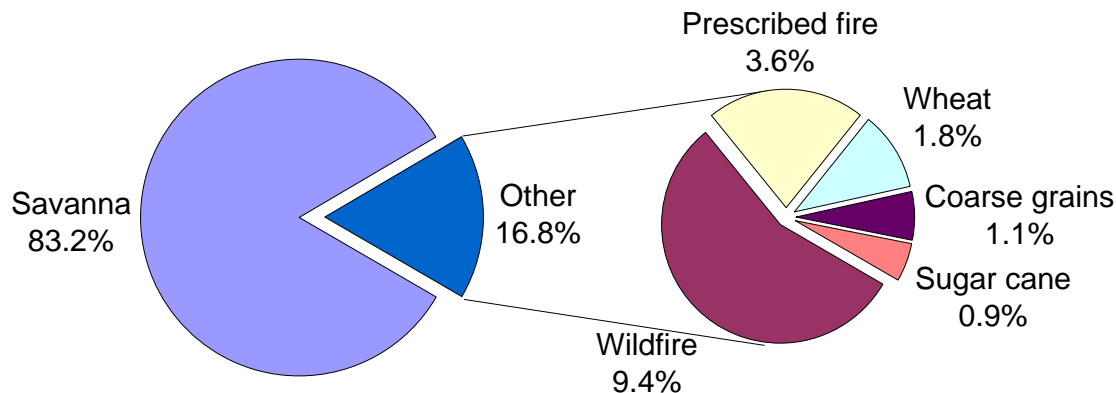

mass emissions, 1994

Emissions are mostly from savanna fires.

2000-2003 were active fire years, >4 times greater than 1990.

Other bushfire activity declined slightly from 1990 to 2001.

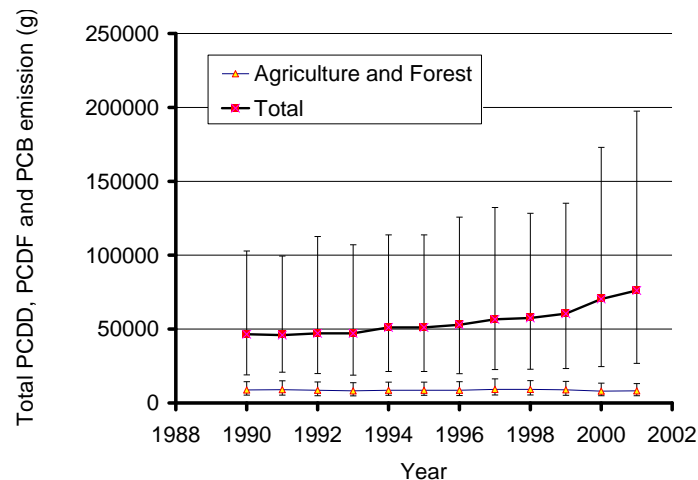

What is happening???

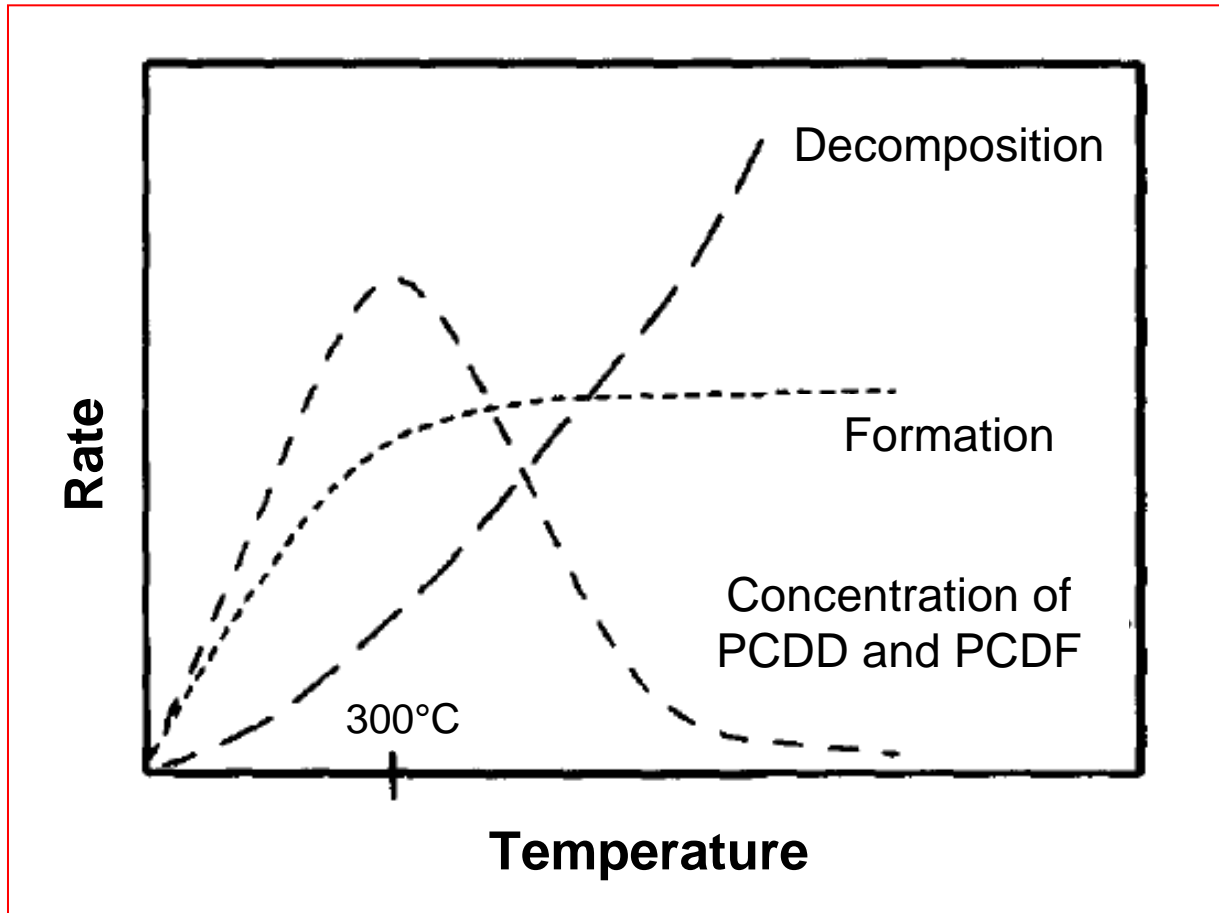

(Adapted from Wehrmeier et al. 1998)

Stanmore (2004) tries to summarise the 'unsummarizable' formation of PCDDs and PCDFs

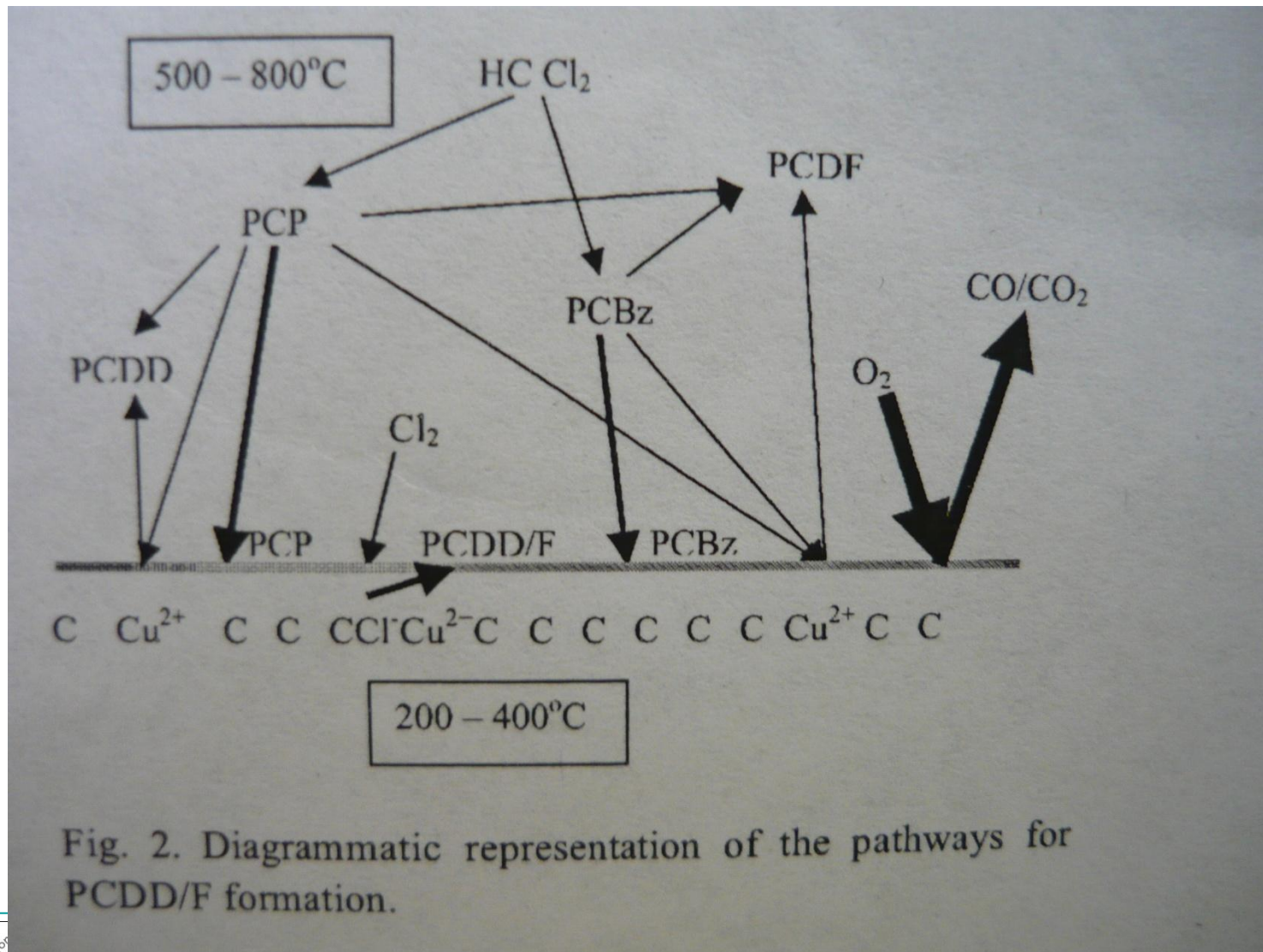
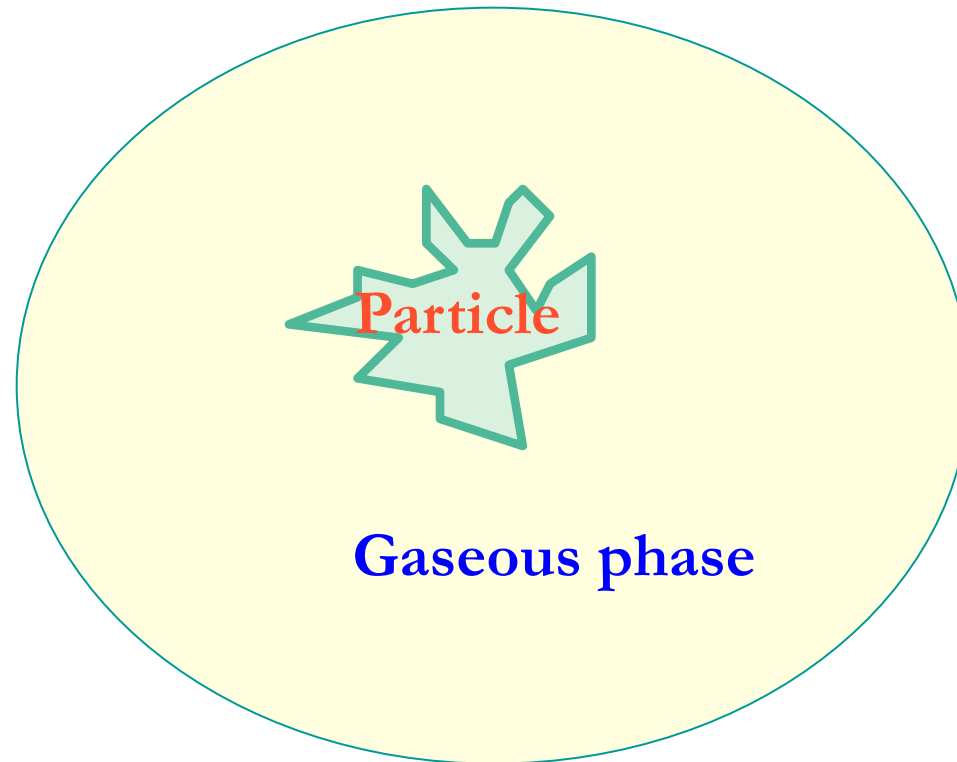

Fig. 2. Diagrammatic representation of the pathways for PCDD/F formation.

My RISKY attempt to take this back apart



2 principle formation types

Formation in the GAS

'HOMOGENOUS' FORMATION

500 – 800°C

Homogenous formation
not relevant (here)

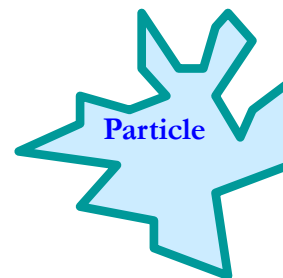

Formation on
particle surface

**'HETEROGENOUS'
FORMATION**
200 – 500°C



Research Centre for Toxic Compounds in the Environment

GAS

<http://recetox.muni.cz>

Heterogeneous Formation (Dioxins/Furans)

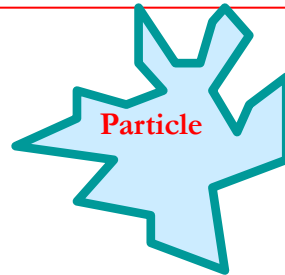

**'HETEROGENOUS'
FORMATION**
200 – 500°C

From Precursors

i.e. condensation of
chlorophenols &
chlorobenzenes

De - Novo

Cl₂ substitution
of carbons (typically
Aromatics)

Chlorination

Cl₂ substitution
of 'parents'

Dioxin dominated

Furans dominated

Research Centre for Toxic Compounds in the Environment

<http://recetox.muni.cz>

POPs Stockpiles

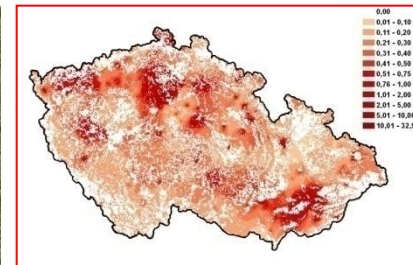
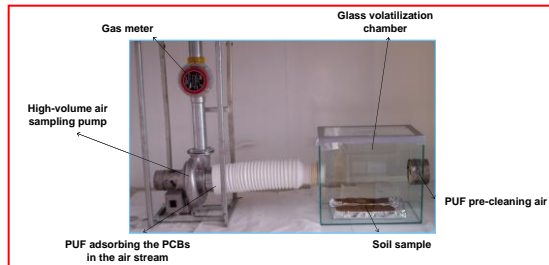
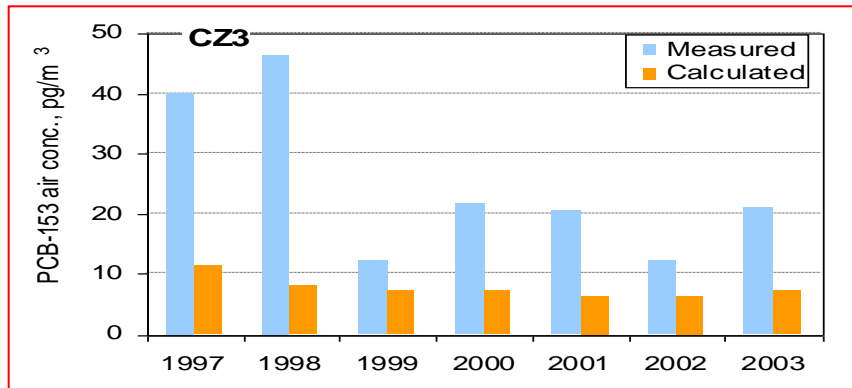
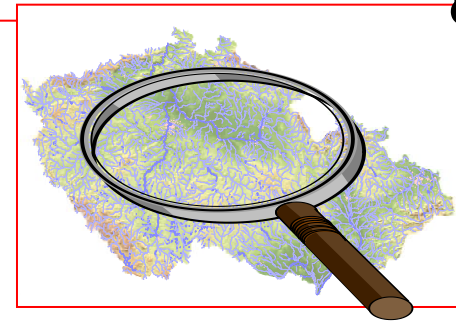
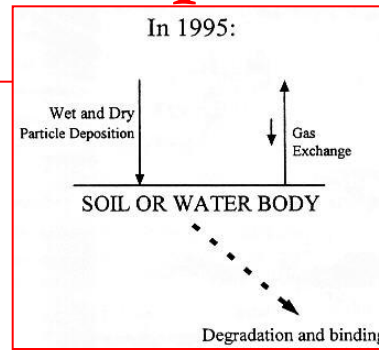
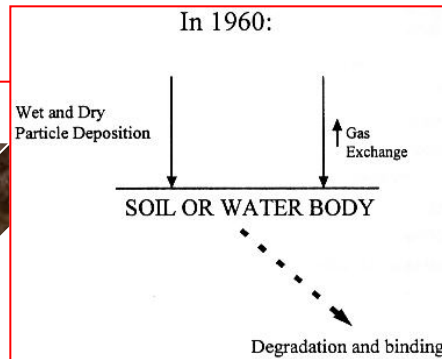
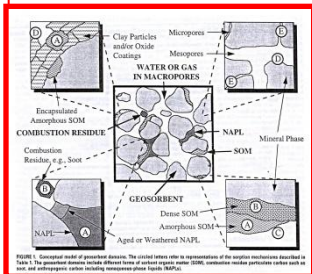

POPs Stockpiles – estimation of soil burden and evaporation fluxes from soils

Stockpiles of POPs in the soil [t] - area of the Czech Republic

PCB118	19.06
PCB101	25.48
PCB52	15.52
PCB28	13.57
PCB180	63.25
PCB153	61.39
PCB138	82.44
PCBs	280.70

DDTs	1 669.11
HCHs	303.23
HCB	120.96

Annual emitted amount of Σ PCBs from industrial sources - 48 kg

- ↖ PCB 153: 61.39 t
- ☞ Evaporation from soils in the CR
- ↖ 22 kg/y for PCB 153 / 0°C
- ↖ 65 kg/y for PCB 153 / 20°C



INVESTICE DO ROZVOJE VZDĚLÁVÁNÍ

**Inovace tohoto předmětu je spolufinancována
Evropským sociálním fondem a státním rozpočtem
České republiky**