

New Developments in Capillary Electrophoresis with focus on Bioanalysis

Lecture 3

Christian Nilsson

Lecture today - Content

- Example of protein adsorption.
- Example of lipid analysis.
- Introduction to microchip electrophoresis.
- Example of miniaturized analysis.

Protein CE

- Advantages compared to slab gel
 - Automation
 - Quantitation
 - Fast
 - High efficiency

Protein CE

- Disadvantages:
 - Protein adsorption
 - Can be prevented by coating of the capillary wall. However, the reproducibility of the coating procedure and the stability of coating have to be considered.
 - Adsorption of proteins decrease reproducibility.
 - Reproducibility?

Protein adsorption

- Adsorption on the negatively charged surface of the capillary wall.
- Especially problematic for basic proteins.
- However, due to a non-uniform charge distribution protein can adsorb even with a negative net charge.

Protein adsorption

Percent recovery of proteins of varying pI values on an uncoated fused silica capillary at pH 7.0^a measured by the Towns and Regnier procedure^b [14]

Protein	pI value	%Recovery
Lysozyme	11.1	0
Cytochrome c	10.2	0
Ribonuclease A	9.3	0
Chymotrypsinogen	9.2	0
Myoglobin	7.3	63
Conalbumin	6.3	66
Carbonic anhydrase	6.2	72
β -Lactoglobulin B	5.2	74
β -Lactoglobulin A	5.1	76
Ovalbumin	4.7	81
Pepsin	3.2	90

^a Determined using two detectors 60 cm apart on a 75 μ m i.d. fused silica capillary. Conditions: 0.01 M phosphate buffer pH 7.0; detection at 214 nm; 300 V/cm; 30 μ A.

^b Section 3.2.1.

Protein adsorption

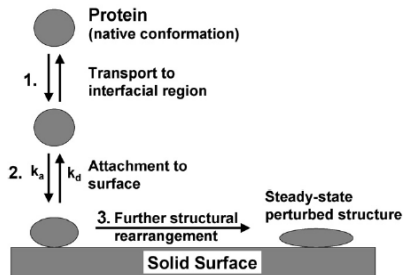

Capillary wall coating

- Review article
- Lucy et al., J. Chromatogr. A, 2008, 1184, 81-105

Example of lipids analysis

- Non-aqueous CE (NACE).
- Separation of hydrophobic compounds

Analysis of lipids

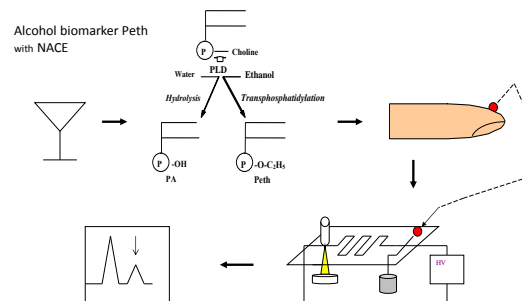

Analysis of alcohol biomarker Peth with NACE

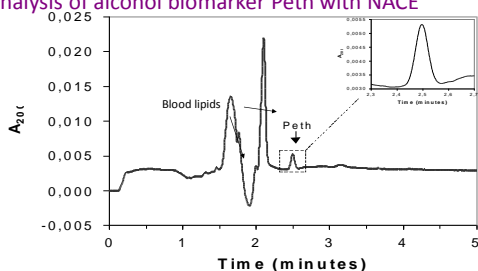

Non Aqueous Capillary Electrophoresis of the new Ethanol Consumption Biomarker Biphosphatidylethanol

Microchip electrophoresis

- First chip analysis published in 1979.
 - Stanford
 - Chip GC
- Next breakthrough in the beginning of the 90s.
 - Liquid chromatography
 - Microchip Electrophoresis
- Microfabrication techniques were developed for electronics.

Microchip electrophoresis

- Rapid development of the technique in 1990s.
- Now:
 - Integration of different functions.
 - Development of specific applications.
- Integration of functionalities on a single device minimize transfer steps.

Microchip electrophoresis

- Development of micro total analysis system (lab-on-a-chip).
 - All necessary analytical functions on a single chip.

Diagnostics



Microchip electrophoresis

- Can pattern many different channels
 - Possibility for high throughput parallel analysis.
- More flexible than CE.
- Electrophoresis and electroosmotic flow a good alternative for microchip analysis due to the small dimensions.

Microchip electrochromatography

- A pressure-driven flow is easier to control.
- An electroosmotic flow is easy to apply and no pump is necessary.
 - No problems associated with increased backpressure due to small channel dimensions.

Microchip construction

- First glass was used as substrate.
- The fabrication methods were already developed.
- Glass has excellent optical properties
 - Transparent at all useful wavelengths.
- Glass has similar surface chemistry as fused silica.
 - Methods for surface modification in CE can be applied also here.

Glass Microchip

- The devices are fabricated one by one.
 - High manufacturing cost per chip.
- Glass is expensive.
- Glass is fragile and easily broken.
- Research to develop polymeric microchips.

Polymeric microchips

- Less expensive.
- Easier to fabricate.
 - High throughput fabrication.
 - Low cost material.
- Less known about the surface chemistry.

Polymer microchips

- However, detection can be problematic for protein analysis.

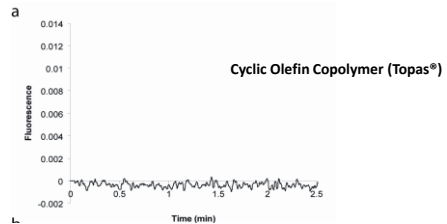

Microchip CE - Injection

- In CE, injection is performed by moving the capillary to the sample solution, which is not possible with a microchip method.
- New injection protocols.

Microchip CE – Integration of functionalities

- Solid phase extraction.
- Two dimensional separation.
- Gradient systems.

Microchip CE - Injection

- Gated injection
- Pinched injection

Microchip CE – Gated injection

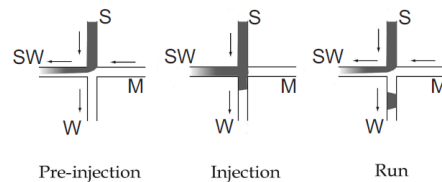

Changing the applied voltages to inject.

Injection dependent on the electrophoretic mobility of the analytes.

Microchip CE – Pinched injection

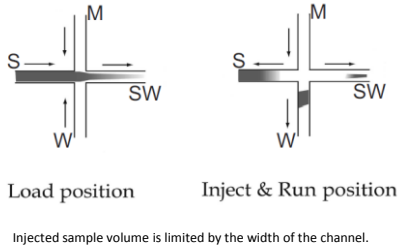

Microchip CE - Detection

- Small detection volume.
- Few microchip CE approaches use UV detection.
- Laser-induced fluorescence is often used due to its high sensitivity.
- However, most analytes require modification to allow fluorescence detection.
- Other detection techniques include electrochemical detection and mass spectrometry.

Microchip CE – Z-shaped detection cell

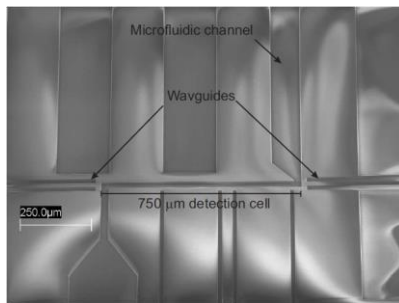

Microchip CE – Electro spray MS

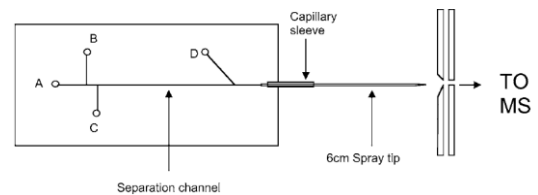

Microchip electrochromatography

- First conducted in 1994 in open-tubular format.
 - The surface of the microchip was modified by C18 material for reversed phase separation of neutral analytes.

Microchip electrochromatography

- An advantage with the microchip format is the possibility to produce tailor-made microchips.
 - For example an array of pillars in the separation channel.
 - More homogenous separation column
 - Smaller structures enable a larger surface area.

Microchip electrochromatography

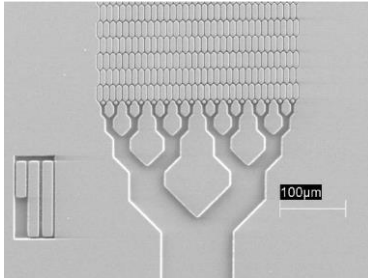

Microchip CE – DNA separation

- Use of a polymeric gel.
- Laser induced fluorescence for detection.
- Shorter separation column compared to CE give a shorter analysis time.

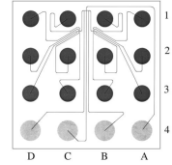

Microchip CE – DNA separation

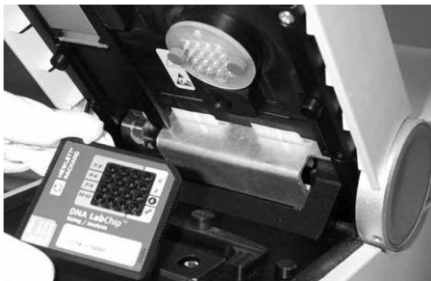

Example of commercial instrument.

Microchip CE – Amplification of DNA

- Polymerase chain reaction (PCR) for amplification of DNA.
- Miniaturization of PCR reduce the amplification time.

Conventional PCR

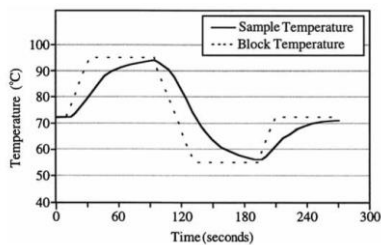

The temperature of the sample need time to adjust.
This time is reduced by miniaturize the technique.

Microchip PCR

- The cycle time can be significantly reduced.
- As an example infrared heating was used

Microchip CE – Protein Separation

- Fluorescent labeled proteins.
 - Labeling might be inhomogeneous.
- Development systems for determining enzyme kinetics and activities.

Single Cell Analysis

- For analysis of variability among cells.

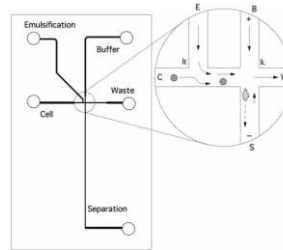

Separation in polymer capillary

Cyclic Olefin Copolymer (Topas®)

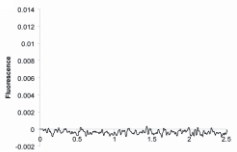

Without nanoparticles

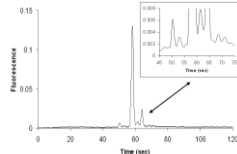

With nanoparticles

GFP variants

In Topas® Capillary

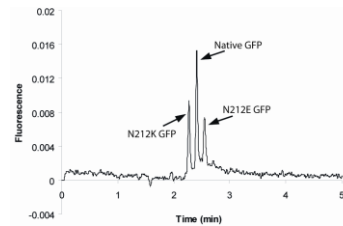

With nanoparticles

Separation on polymer chip

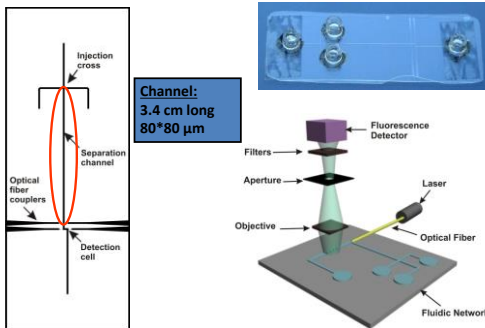

Separation on polymer chip

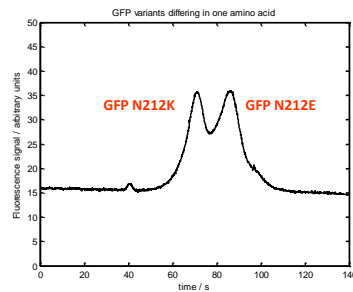

Acoustic Levitation wall-less test tube

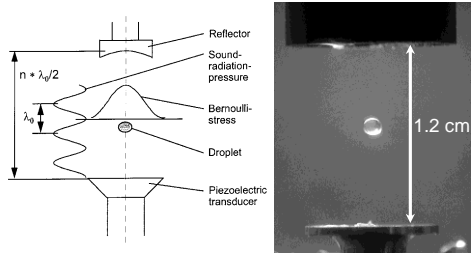

Levitated 500 nL drop

Acoustic Levitation

- Miniaturisation Benefits (volume range pL-μL)
- The Surrounding Gaseous Medium the Only Contacting Surface
- Stable Sample Position
- No Special Sample Properties
- Easy access to sample

Ink jet methods

Flow-through Drop-on-Demand Dispenser

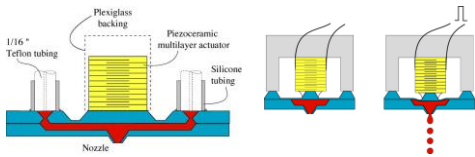

- Fabricated in silicon
- 250-100 nL inlet to nozzle
- Piezoelectric multilayer element for actuation
- Nozzle dimensions 30-50 μm
- Typical droplet volume: 50-100 pL
- Dispense rate up to 9 kHz

Flow-through Drop-on-Demand Dispenser

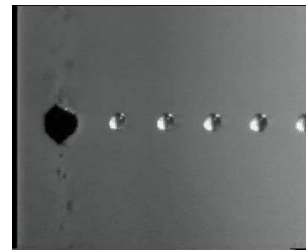

Instrumental Set-up

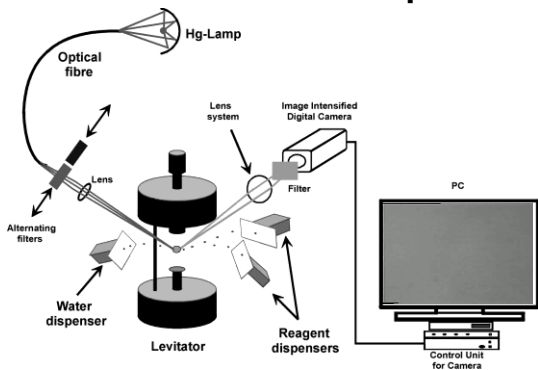

Adipocyte Reactions Single Cell

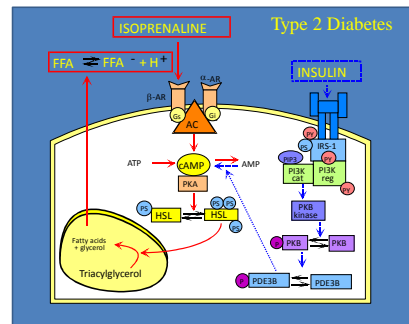

Adipocyte Lipolysis

