

# SEDIMENTY

# Glacigenní sedimenty

# Původ glaciálního ledu

- Největší zdroj ledu: sníh
  - Snow to firn to ice
  - Influence of snow type and locale
- (Milankovic: Chladná léta podporují růst ledu)



# Typy ledovců

- **Icesheet (ledový příkrov):** large **continental ice mass** that does not cover the whole area within its borders
- **Icecap (ledový pokryv):** **almost continental in size**, but nothing projects above ice
- **Icefields & valley glaciers (ledová pole a údolní ledovce):** icefields found in high mountains, with **large valley glaciers** spilling from them
- **Mountain glaciers:** small ice masses, **cirque glaciers (karové ledovce)**

# Kontinentální ledovec



18,000 Years  
Before Present

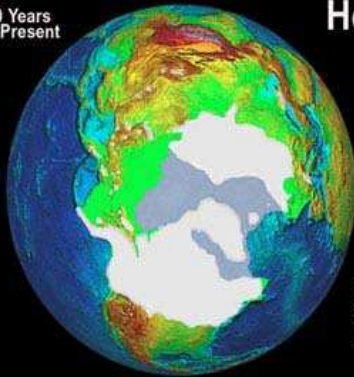

Northern  
Hemisphere

Ice Coverage

Legend



Modern  
Day  
(August)

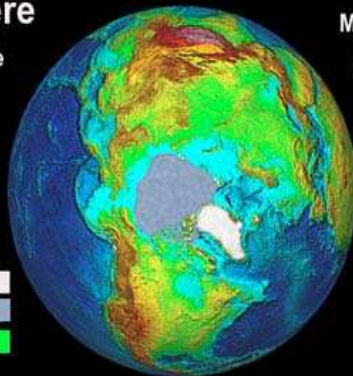

Note: Modern sea ice  
coverage represents  
summer months.



18,000 Years  
Before Present

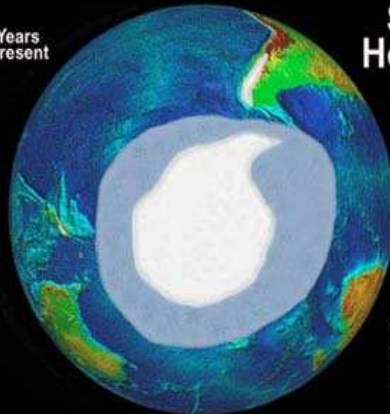

Southern  
Hemisphere

Ice Coverage

Legend



Modern  
Day  
(August)

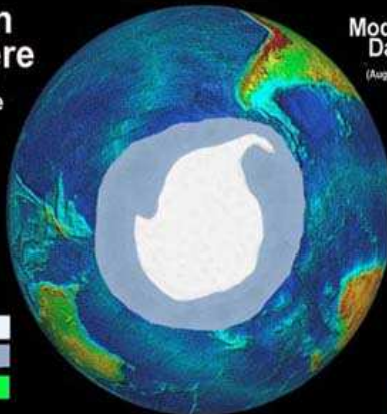

# Kontinentální zalednění: morfologie

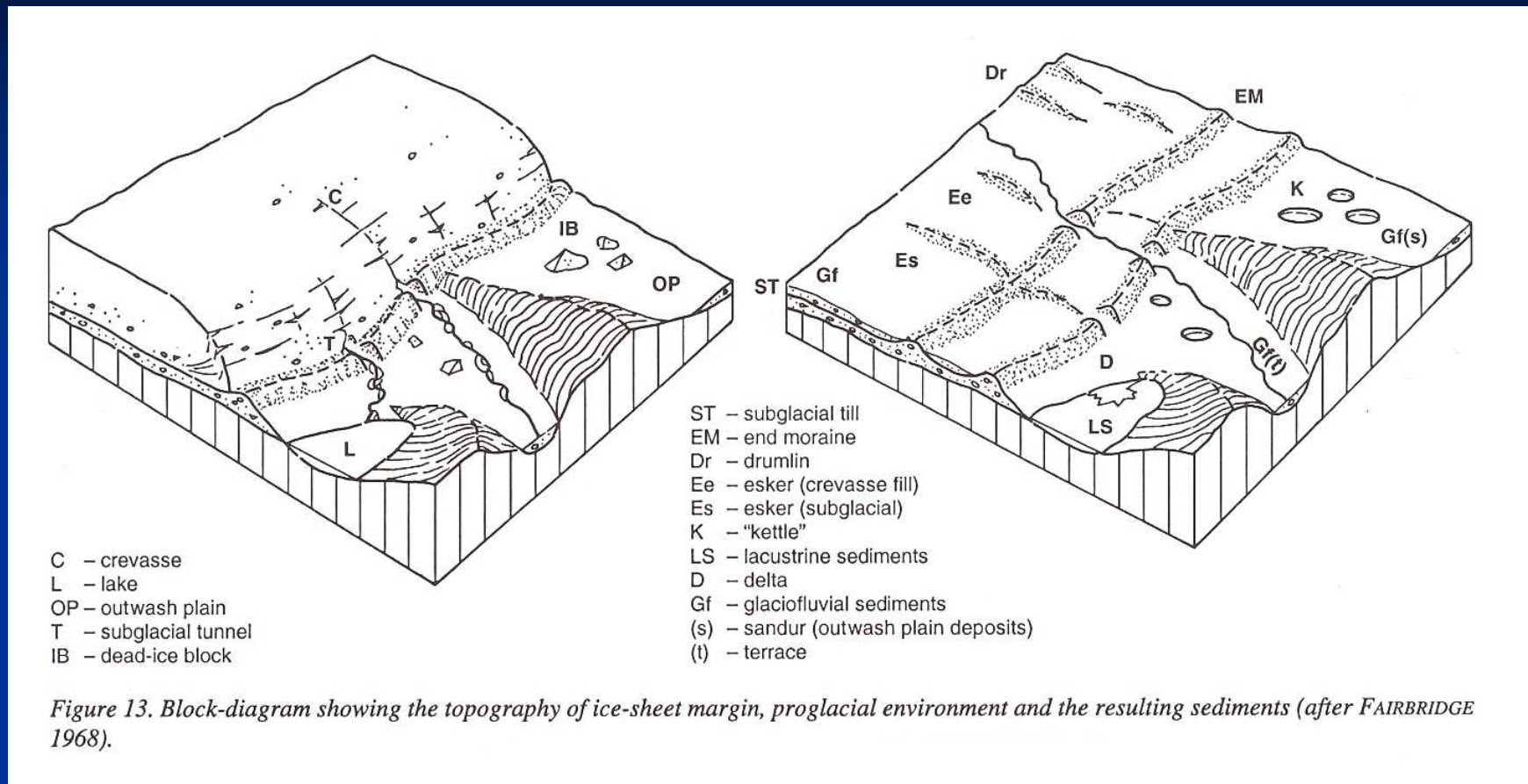

*výplavová planina (sandur)* – mírně ukloněná planina tvořená glaciofluviálními uloženinami v předpolí pevninského ledovce; vzniká splynutím plochých náplavových kuželů ledovcových toků

*kotle (kettles)* – okrouhlé deprese zpravidla vyplněné vodou; vznikají roztáním mrtvého ledu pohřbeného v glaciofluviálních sedimentech

*eskery* = přímé nebo klikaté valy vznikající fluviální sedimentací v ledovcových tunelech

*drumlin* = oválný pahorek tvaru obrácené kávové lžičky; drumliny vznikaly při pohybu ledovce nahrnutím tillu

*till* = nevrstevnatá směs ledovcového materiálu obsahující všechny zrnitostní frakce od balvanů až po jíl

*moréna* = akumulace horninového materiálu deponovaná při okrajích ledovce

*boční moréna, koncová (terminální) moréna, spodní moréna*

# Tvary kontinentálního zalednění



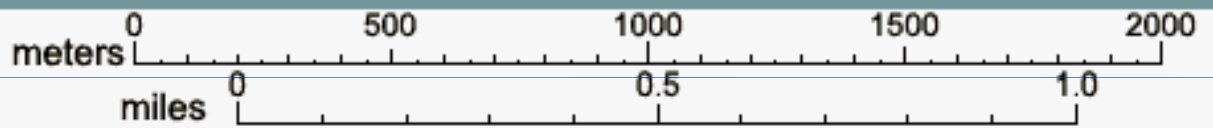
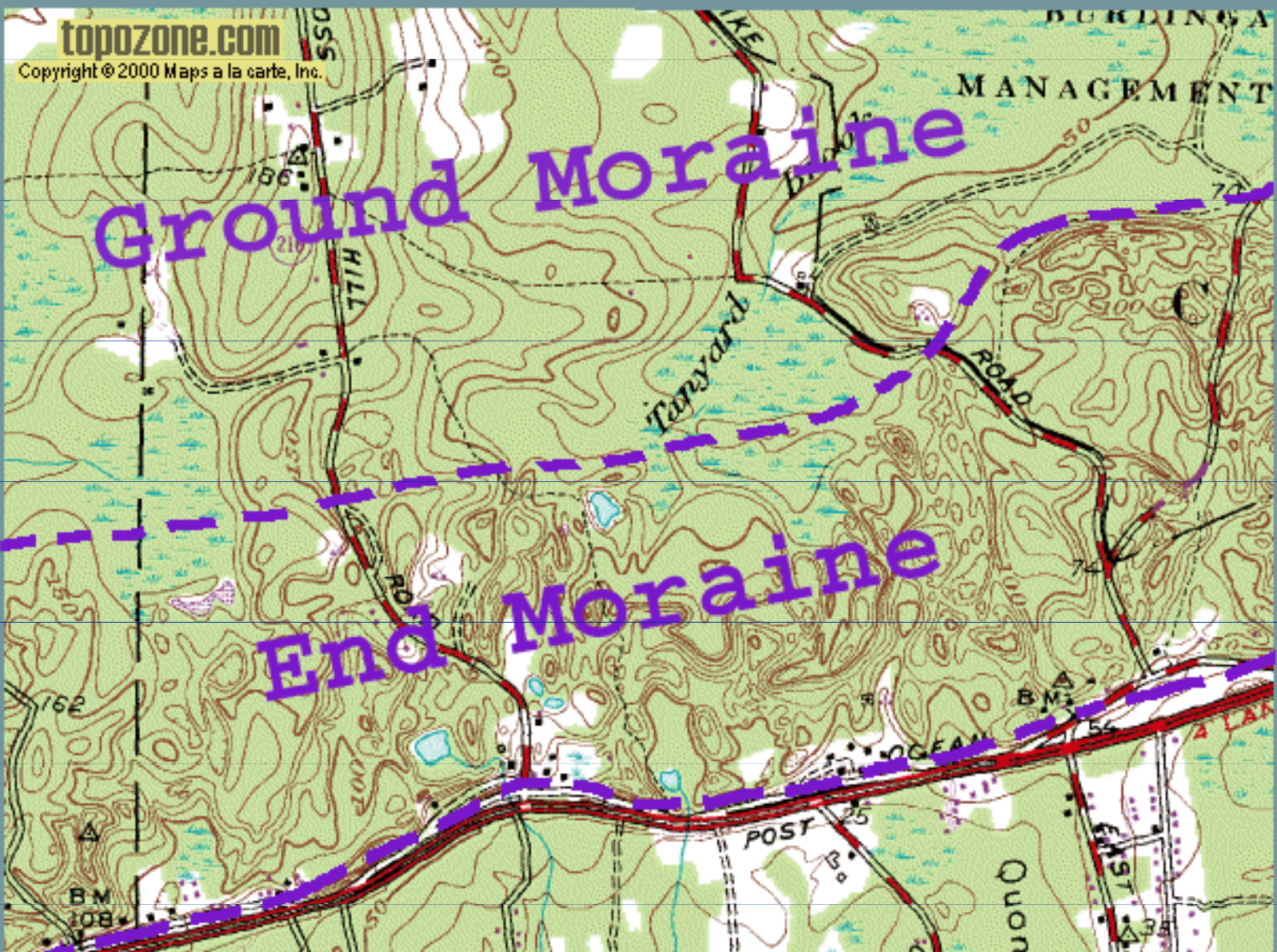

Map center is UTM 19 272796E 4582287N - QUONCHONTAUG quad



# Kontinentální zalednění v ČR

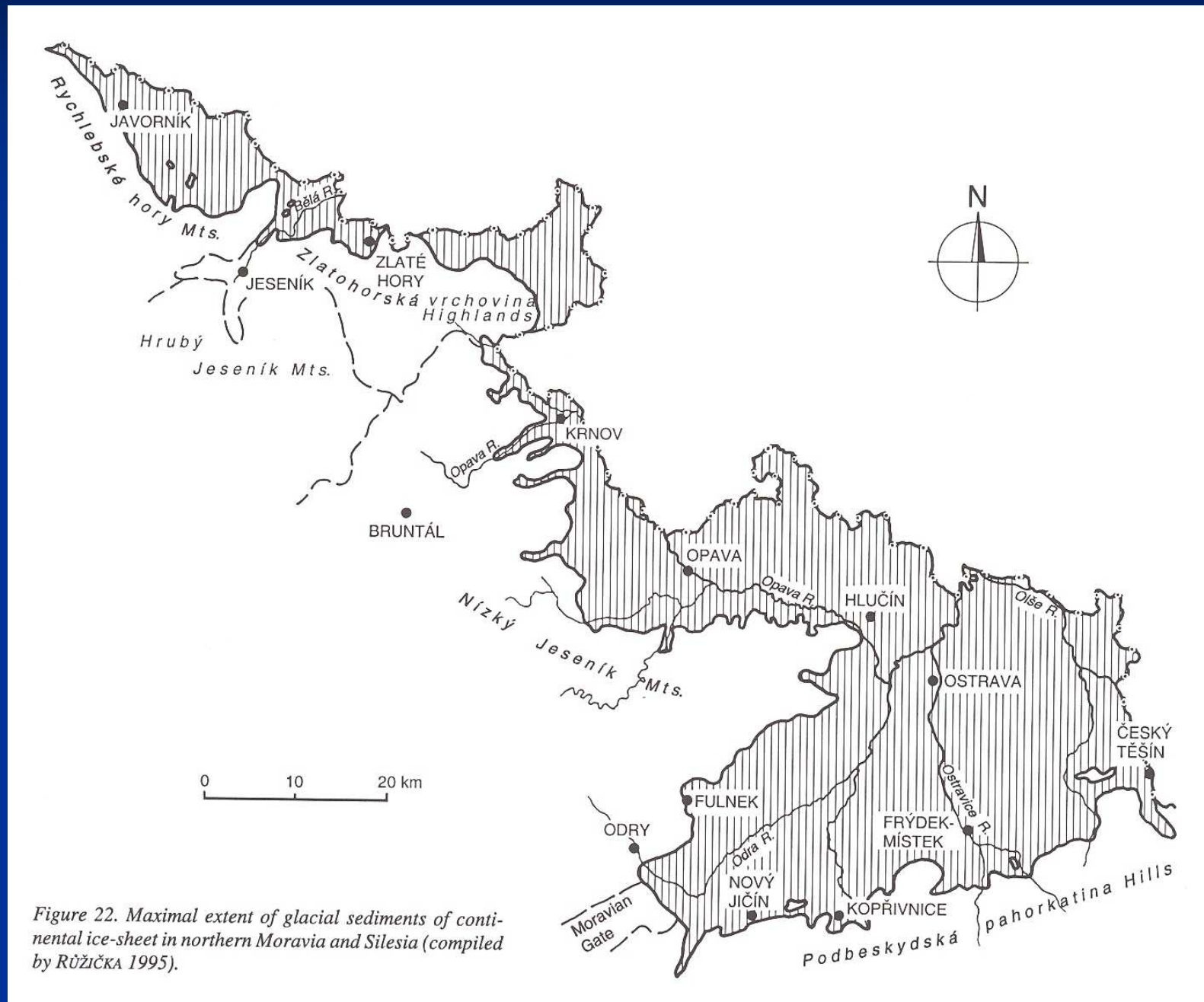

# Kontinentální zalednění v ČR

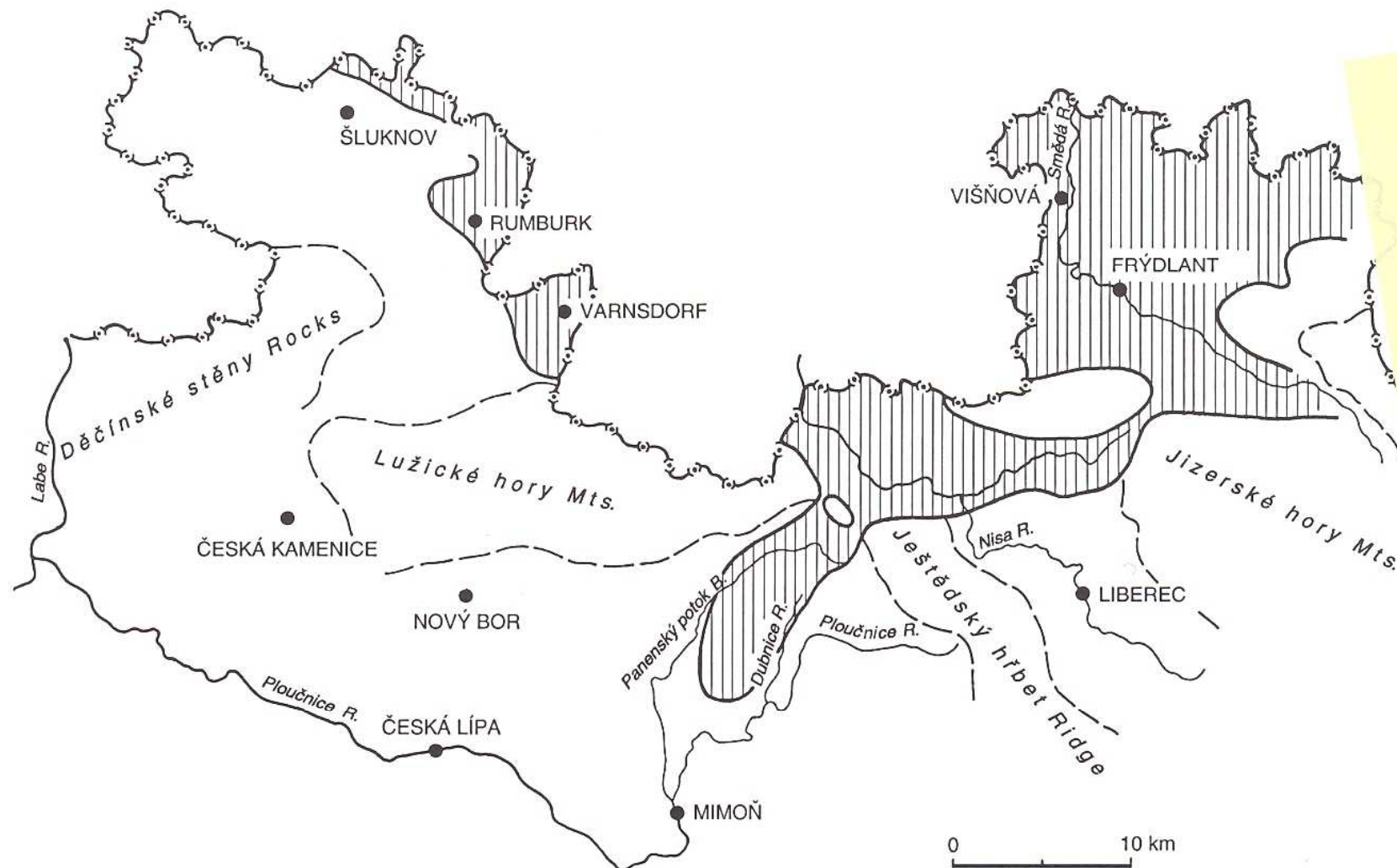

Figure 23. Maximal extent of glacial sediments of continental ice-sheet in northern Bohemia (after KRÁLÍK 1989, supplemented and modified by M. Růžička).

# Horské zalednění: hlavní rysy

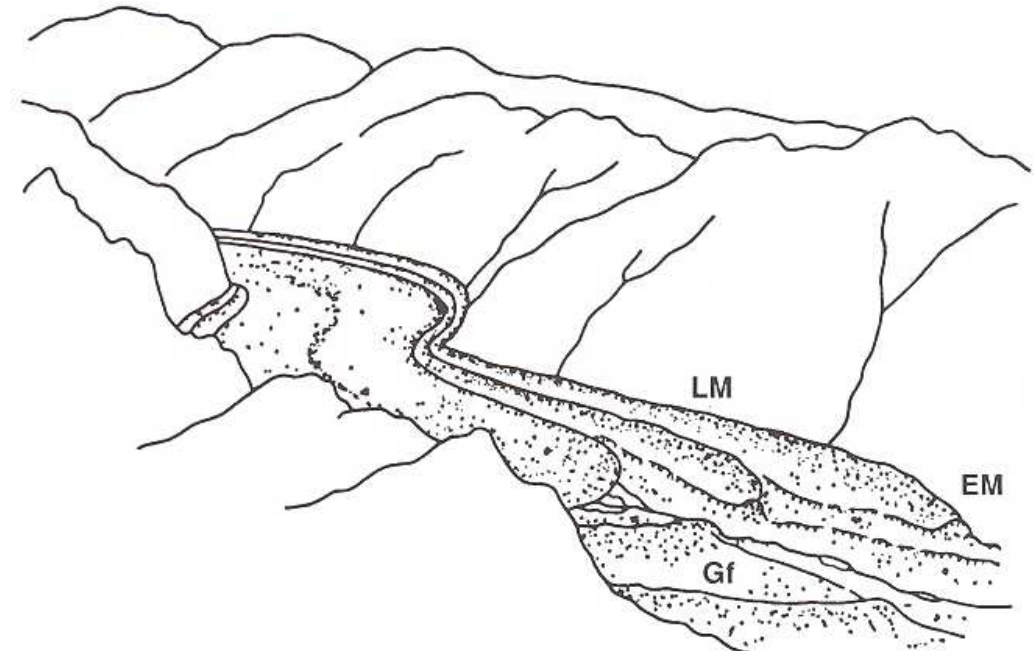
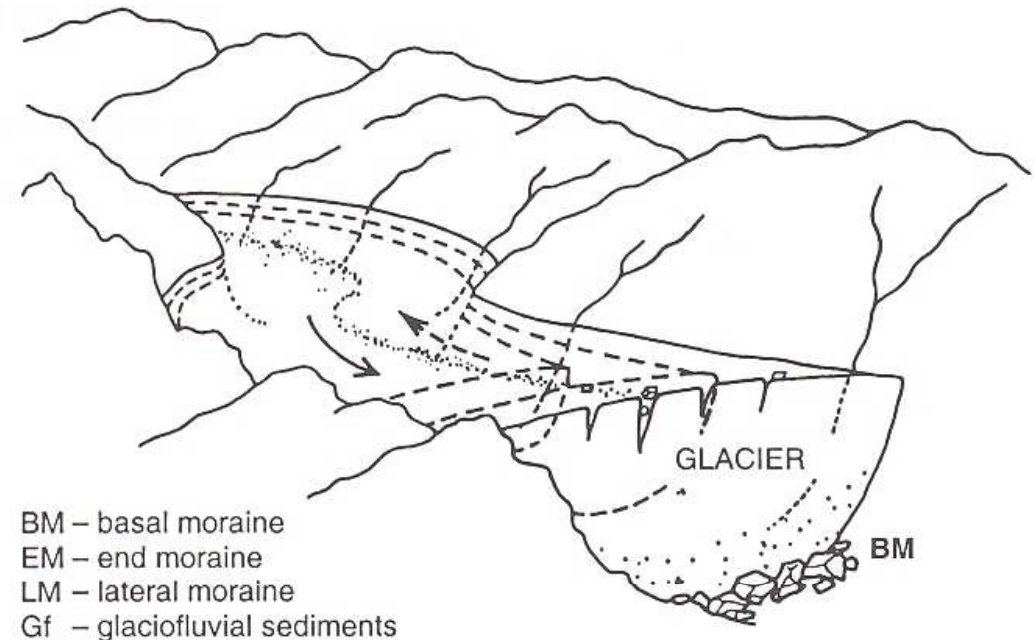
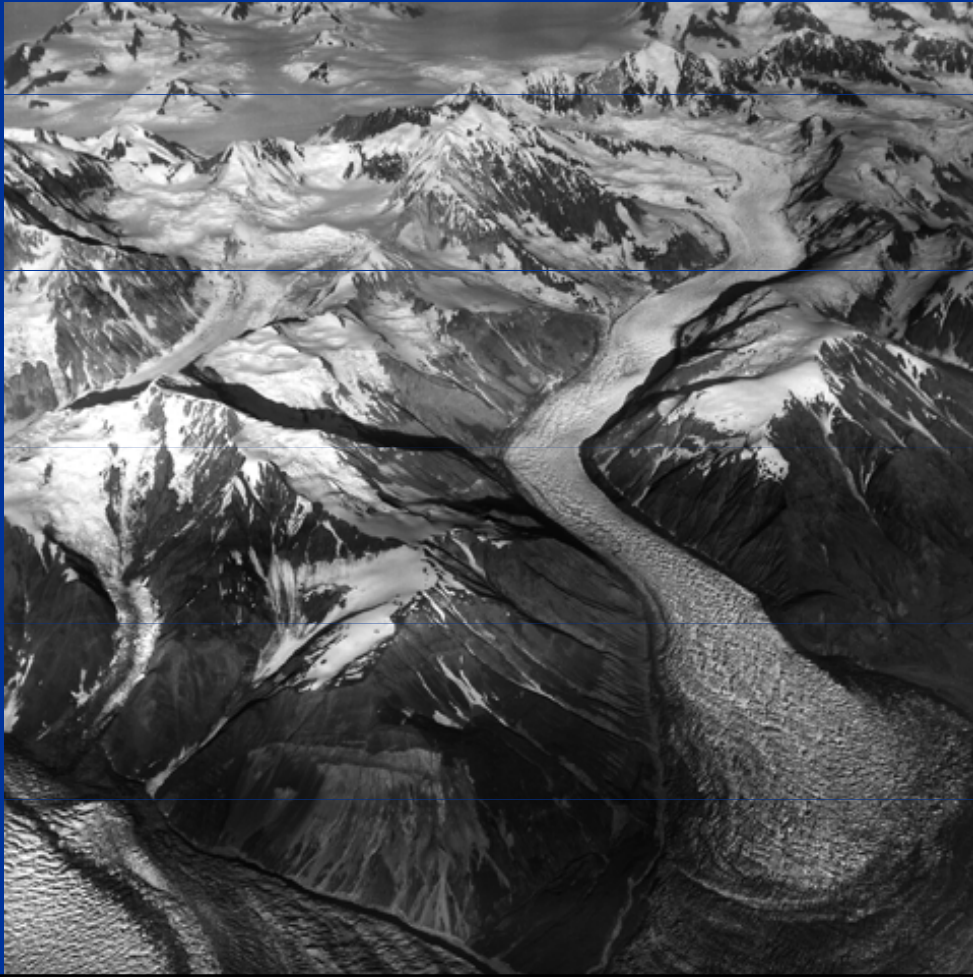

Figure 14. The morphology of a valley glacier and its deposits (schematic representation).

# Horské zalednění

*horn* = ostrý vrchol který vznikl na kontaktu tří nebo více karů

*kar* = zdrojová oblast ledovce; amfiteatrální sníženina vzniklá přetvořením údolního uzávěru mrazovým zvětráváním a činností ledovce

*arête* = úzký rozeklaný hřbet který vznikl protnutím svahů dvou karů

## Features of Alpine Glaciation

- a. Horn
- b. Col
- c. Arête
- d. Cirque
- e. Glacial Trough
- f. Crevasse
- g. Hanging Valley

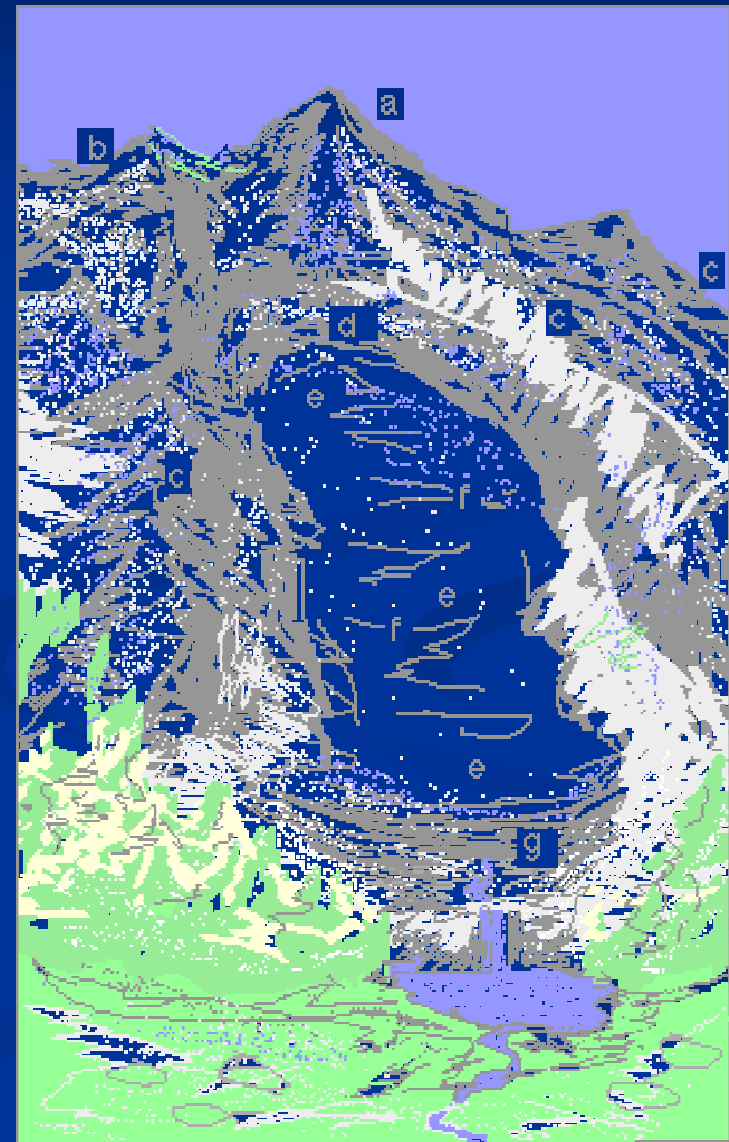

# Tvary horského zalednění



# Horn: Matterhorn



# Údolí tvaru U



# Morény





## ■ Laguna Torre, morénové jezero



# Morény



# Alpine Glaciers

- Glacier fluctuations provide information about past climate change.
- Glacier fluctuations depend on ice movement and ice mass balance: increased net accumulation leads to glacier advancement.
- Ice mass balance depends on rates of snow accumulation and ablation (removal of snow via melting, evaporation, sublimation, avalanching or wind deflation).

# Alpine Glaciers (cont.)

- The equilibrium-line altitude (ELA) marks the area where accumulation equals ablation.
- ELA responds to changes in winter precipitation, summer temperature, and wind's strength.
- Climate has a strong effect on modern ELA.

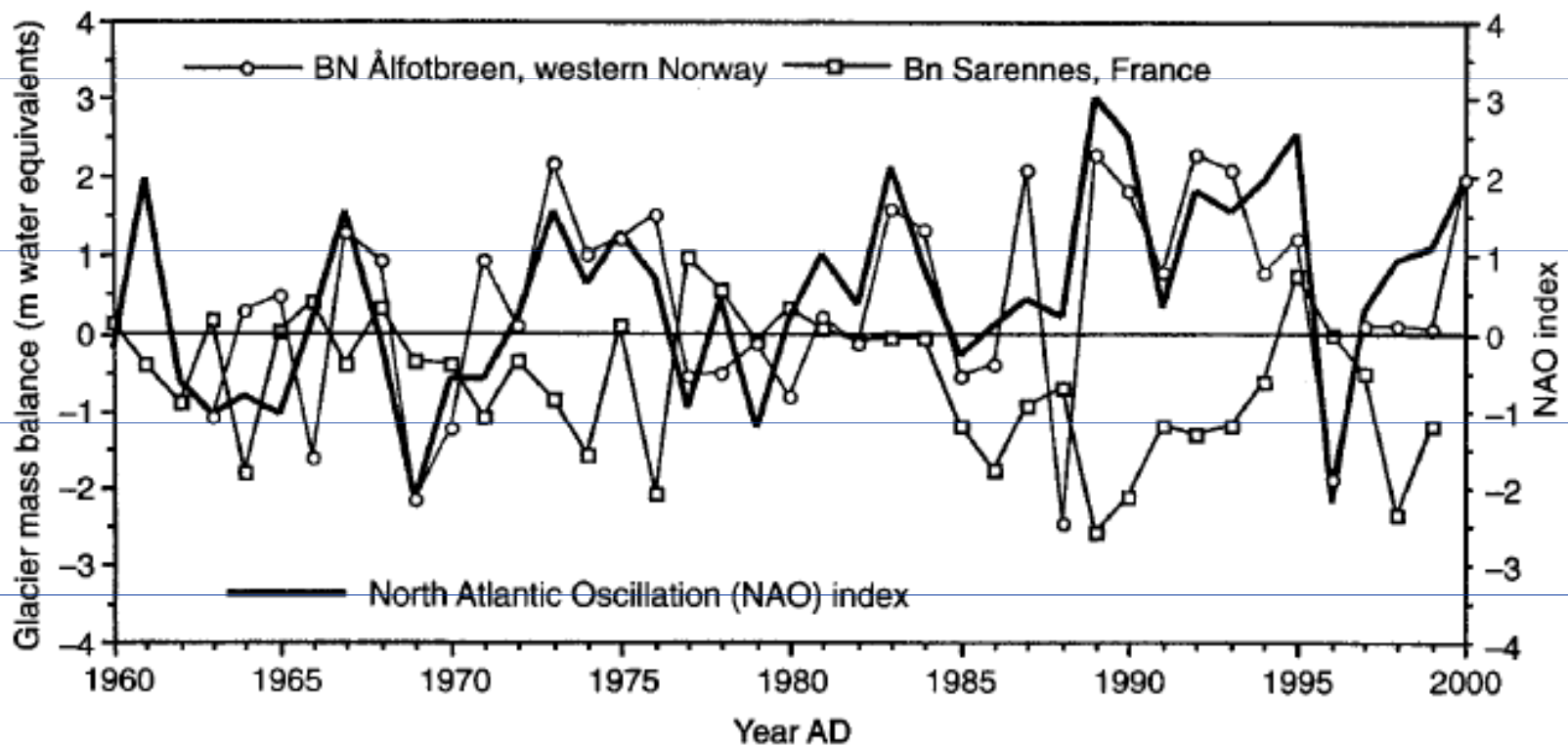

**Figure 18.5** The annual net mass balance of Ålfotbreen, western Norway (data: Kjølmoen 1998 with later updates), annual net mass balance of Sarennes Glacier in SE France (data: World Glacier Monitoring Service) and the North Atlantic Oscillation index (Jones et al., 1996 with later updates).

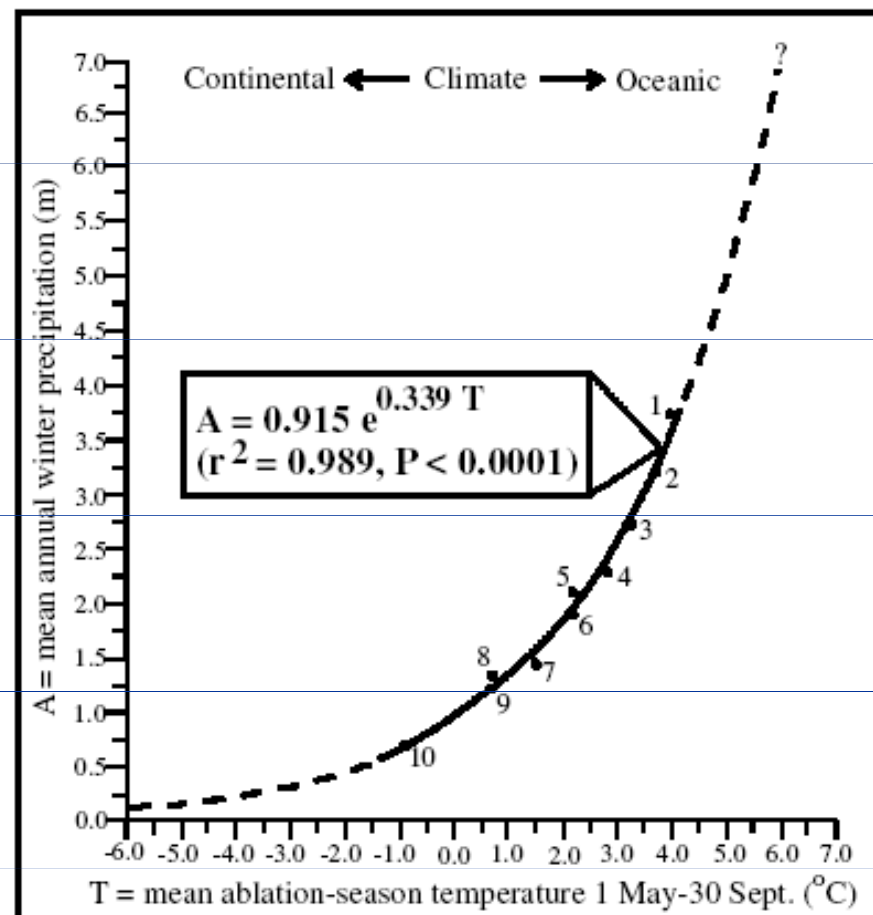

**Figure 2** The non-linear (exponential) relationship between mean ablation-season temperature (1 May to 30 September) and winter precipitation (1 October to 30 April) at ELAs of 10 Norwegian glaciers: (1) Ålfotbreen; (2) Engabreen; (3) Folgefonna; (4) Nigardsbreen; (5) Tunsbergdalsbreen; (6) Hardangerjøkulen; (7) Storbreen; (8) Austre Memurubreen; (9) Hellstugubreen; (10) Gråsubreen. After Dahl *et al.* (1997).



*Figure 5: A photograph from August 1995 showing snow and firn line of Austre Okstindbreen at around 1250 metres elevation. The location and view direction of this photo is marked in Figure 3. The flow direction is to the right and crevasses can be seen. The firn line follows the same shape as the 1250-metre line. The snow line, which was located at 1250 metres in August 1995, was much higher at about 1300 metres in August 1994, i.e. the year represented by Figure 3.*

# Reconstruction of paleo-ELA

- Paleo-ELA = maximum elevation of lateral moraines.
- Theoretically, deposition of lateral moraines only occurs in the ablation zone.

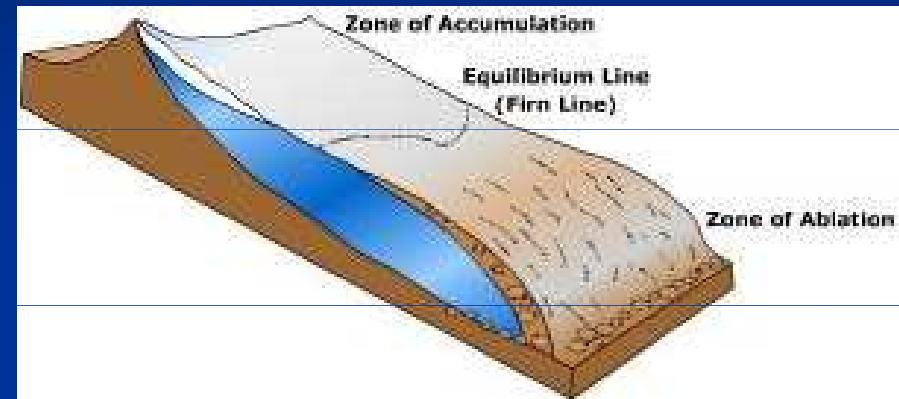



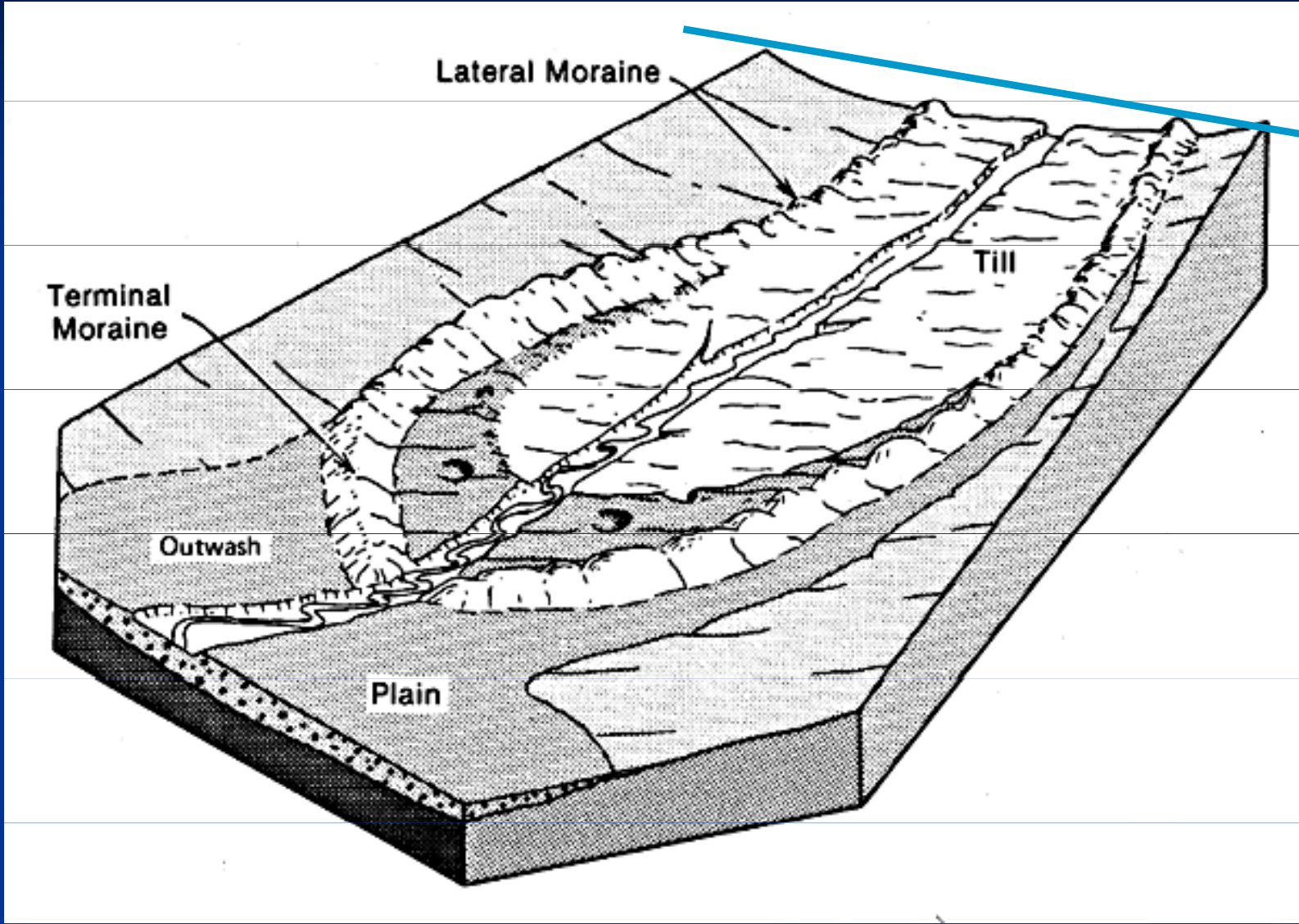

ELA

Photographs or field evidence are used to reconstruct lateral moraines and their maximum elevations.



# ELA- based paleoclimatic reconstructions

- ELAs provide information on temperature and precipitation.
- However, there is a time lag or response time (short for steep, fast-flowing glaciers).
- Response time is the time a glacier takes to adjust to a change in mass balance.
- Response time for alpine glaciers ranges from tens to hundreds of years.

# Dating of moraines

- Radiocarbon ages. However, it takes some time for organic matter to accumulate on the moraines.
- Lichenometry. However, the reliability of this technique is uncertain.
- Cosmogenic isotopes. Relatively new technique.

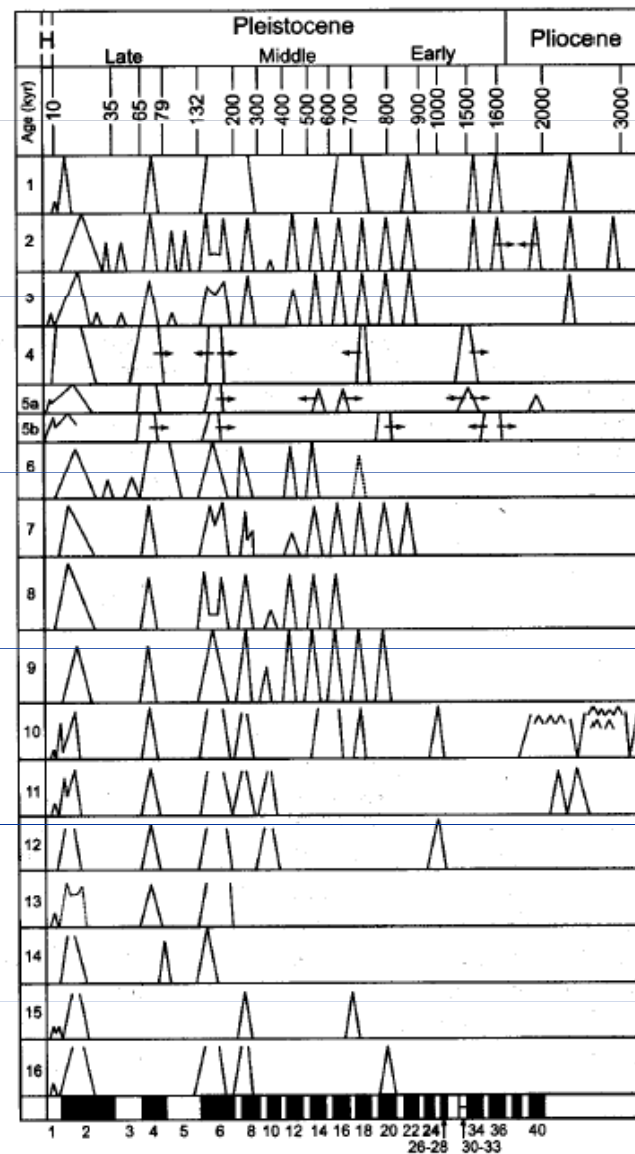

**FIGURE 7.15** Summary diagram showing the principal episodes of glaciation in the northern and southern hemispheres over the past ~3 M years based on glacial geologic studies in the various regions indicated. Ice advances are indicated schematically by an upward pointing triangle, the relative dimensions of which signify the magnitude of each ice advance. Note that timescale (shown at top) is nonlinear; marine oxygen isotope stages are indicated at bottom with even-numbered stages (times of major ice accumulation on the continents) shaded (however, note that not all such stages are equal in magnitude — see section 6.3.2). Arrows indicate dating uncertainties; in spite of these, numerous episodes of globally significant ice advances are clearly identifiable. 1 = U.S. Cordilleran ice sheet; 2 = U.S. mountain glaciers; 3 = U.S. Laurentide ice sheet; 4 = Canadian Cordilleran ice sheet; 5 = Canadian Laurentide ice sheet (a = SW margin, b = NW margin); 6 = N.E. Russia; 7 = Poland/western (former) Soviet Union; 8 = N.W. Europe; 9 = European Alps; 10 = Southern Andes; 11 = New Zealand; 12 = Tasmania; 13 = Southern Ocean and sub-Antarctica; 14 = Antarctica (Ross Embayment); 15 = New Guinea; 16 = E. Africa (simplified from charts accompanying Bowen *et al.*, 1986; Clapperton, 1990).

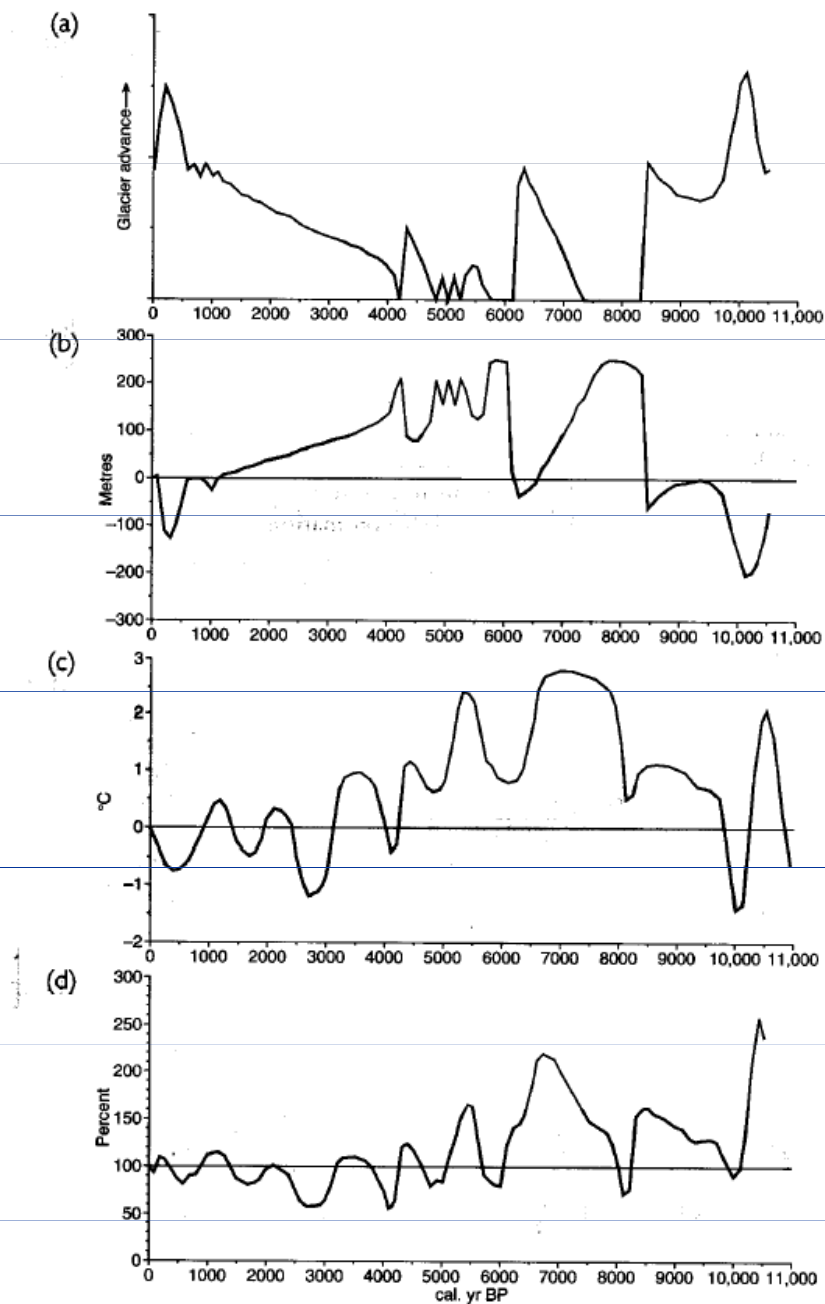

**Figure 18.4** (a) Holocene glacier variations of Hardangerjøkulen (Dahl and Nesje, 1994); (b) Holocene equilibrium-line altitude (ELA) variations at Hardangerjøkulen (Dahl and Nesje, 1996); (c) Holocene July temperature variations based on chironomids (non-biting midges) from lake sediments at Finse north of Hardangerjøkulen (Velle, 1998). Due to poor age control in the upper part, the curve has been tuned towards a pine-tree curve for southern Norway (Lie *et al.*, unpublished); (d) Holocene variations in winter precipitation (in per cent, 100 per cent = 1961–1990 normal) in the Hardangerjøkulen area (Dahl *et al.*, unpublished data).

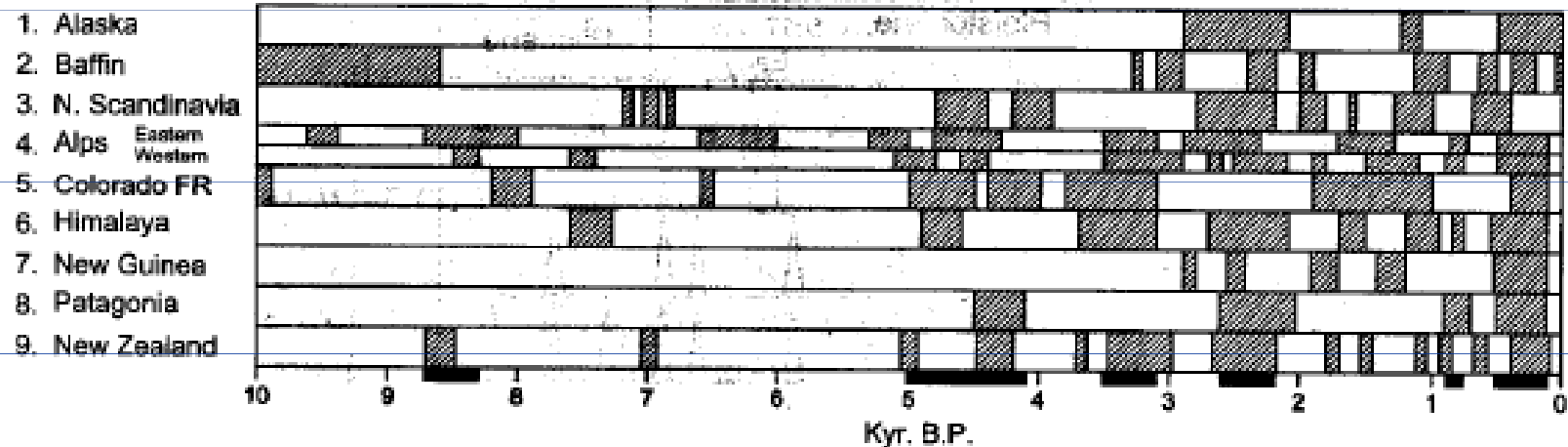

**FIGURE 7.16** Summary of glacier expansion phases in different areas of the world during the Holocene. This compilation shows the complexity of the records and the difficulty of discerning worldwide synchronous episodes on this timescale (possible times of widespread advances are indicated by black bars at bottom of figure). This difficulty may be due to climatic fluctuations that are regional, not hemispheric or global in extent, or to poor dating, or to problems inherent in a discontinuous and incomplete data set. A general absence of glacier advances in the early to mid-Holocene is apparent, as is the onset of Neoglaciation after ~5000 yr B.P. (Grove, 1988).

# Importance of records from alpine glacier

- Glacier fluctuations contribute information on how rapid climate change occurs and the range of these changes.
- ELAs have changed considerably at many timescales: glacial/interglacial, millennial (Holocene), and seasonal.
- ELAs of most modern alpine glaciers have shifted upwards during the 20<sup>th</sup> century.



# Horské zalednění v ČR

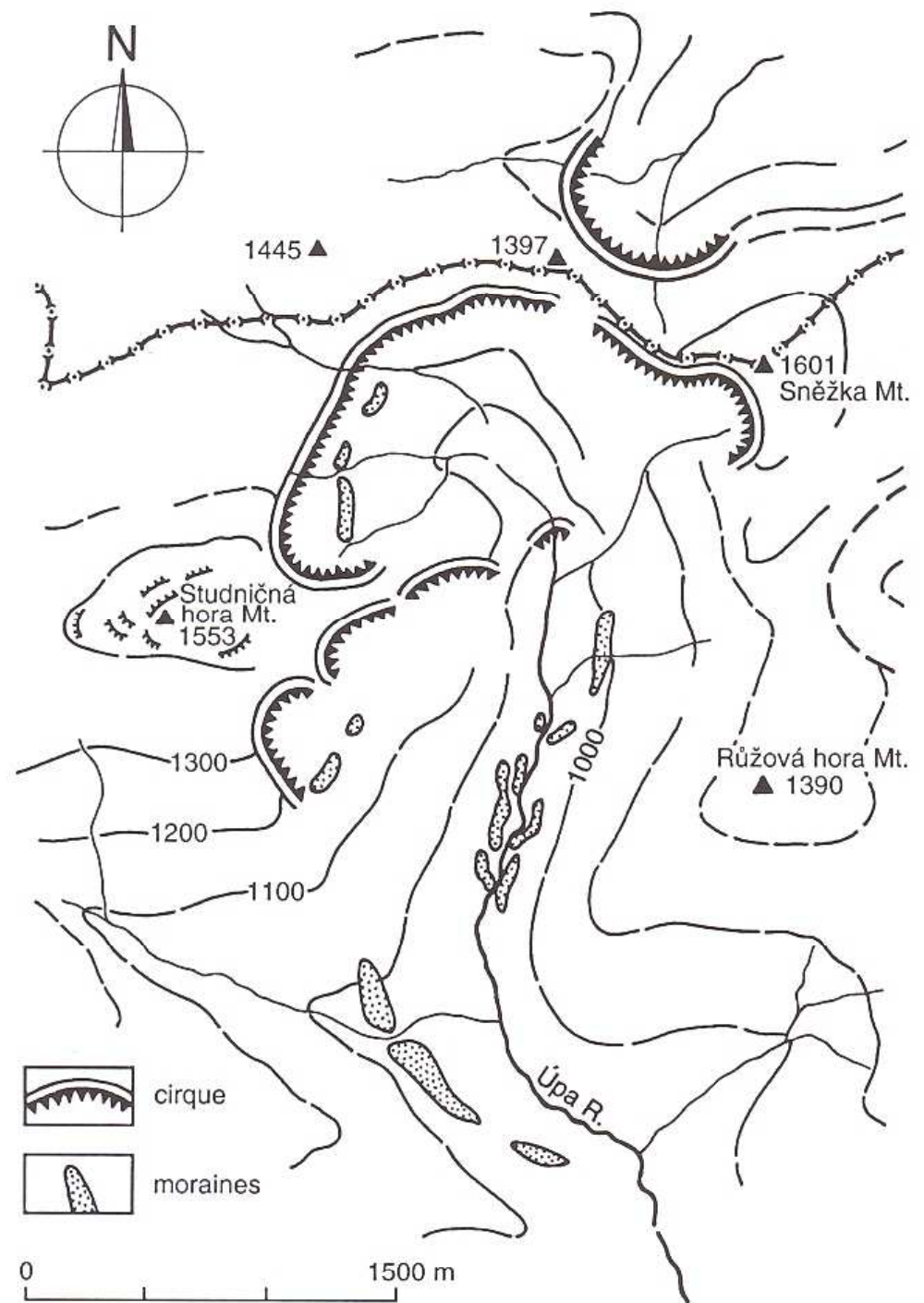

Figure 20. Cirques and valley glacier moraines in Úpa valley, Krkonoše Mts. (KUNSKÝ 1948, modified).

# Glaciální transport

## ■ Subglaciální

-rounded & flattened

-most materials comminuted to very small terminal grades if transported long distances

## ■ Englaciální

-can be transported long distances

## ■ Superglaciální

-broken down by freeze-thaw in angular blocky fragments

# Glaciální depozice

- *till* = nevrstevnatá směs ledovcového materiálu obsahující všechny zrnitostní frakce od balvanů až po jíl
- bazální: basal or lodgement till
  - compact, generally fine-grained material
- englaciální: till or outwash
- superglaciální
  - ablační till
    - coarse-grained
  - outwash: generally sandy to coarse material

# Facie glacigenních sedimentů

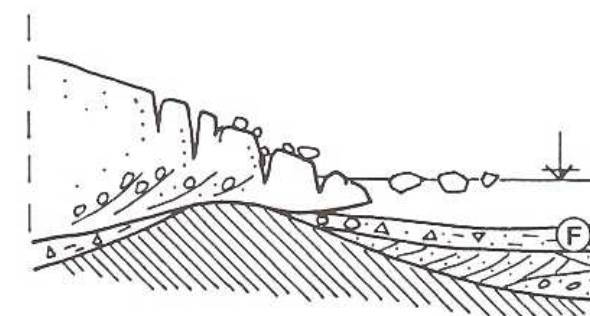
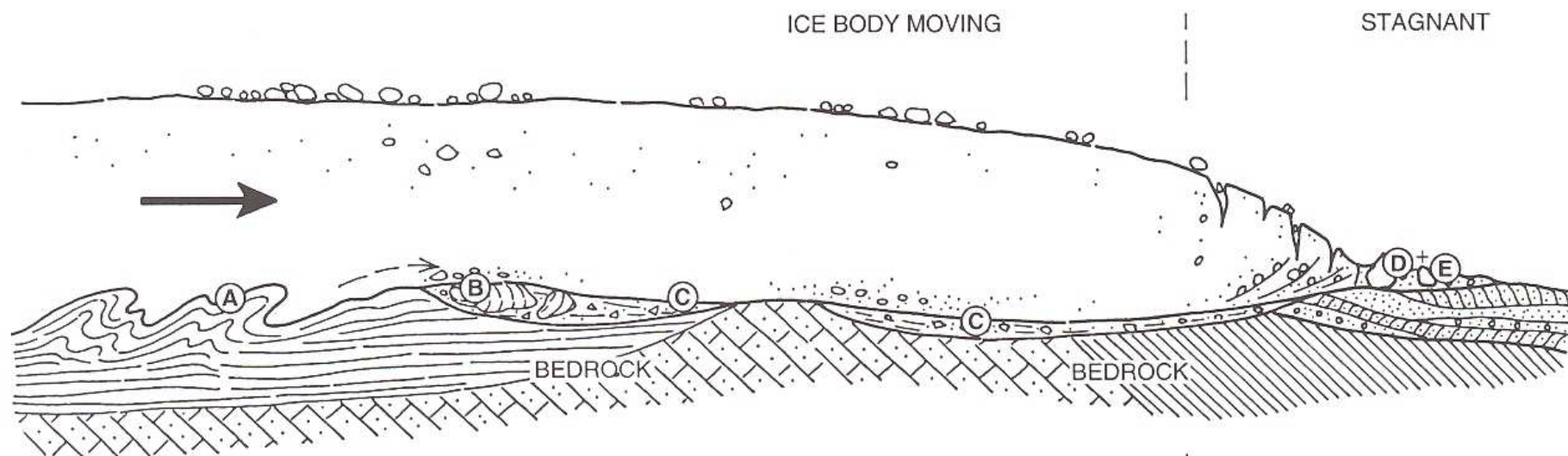
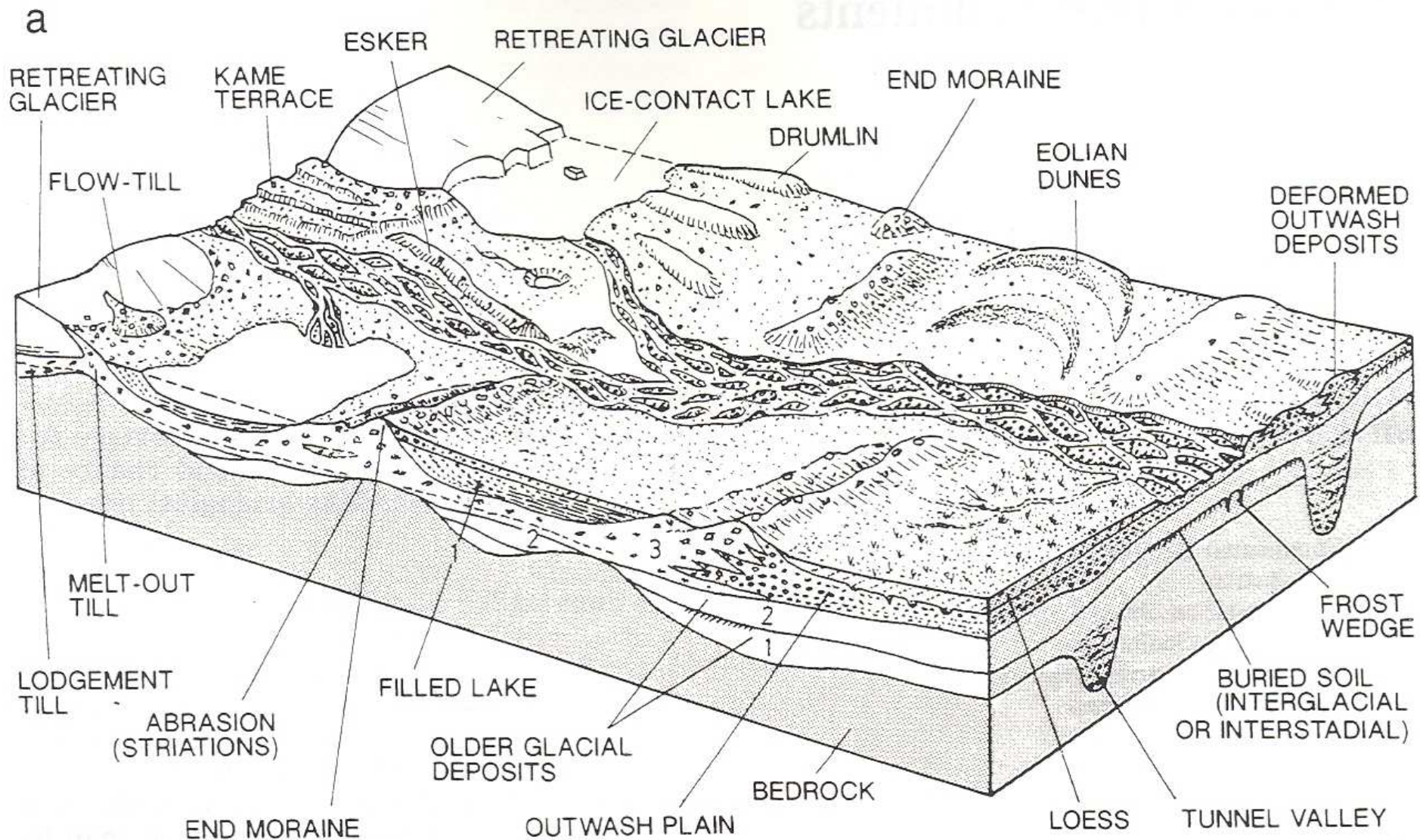
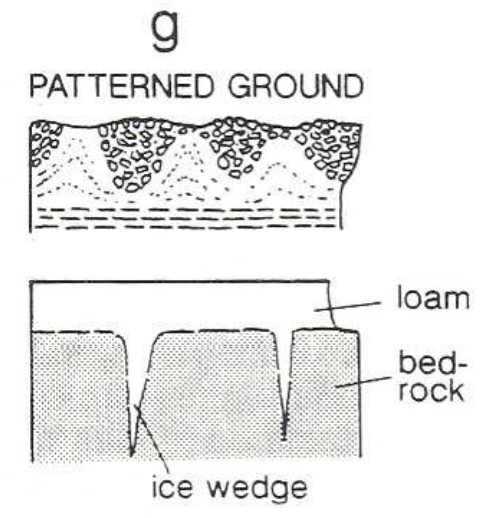
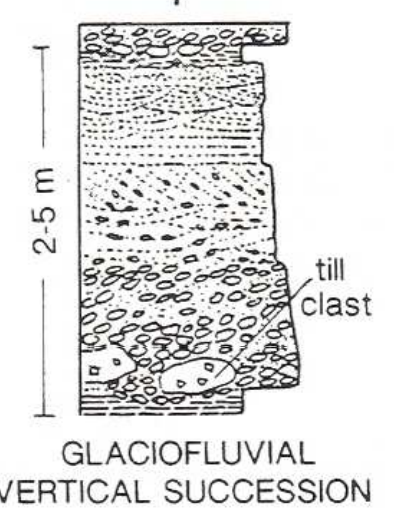
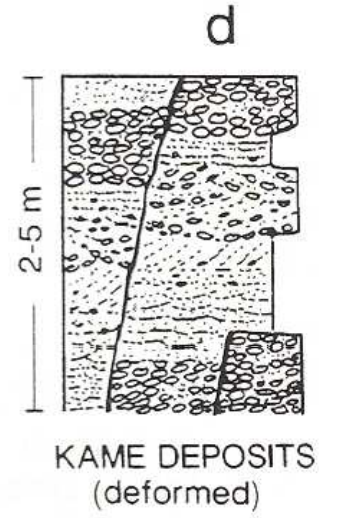
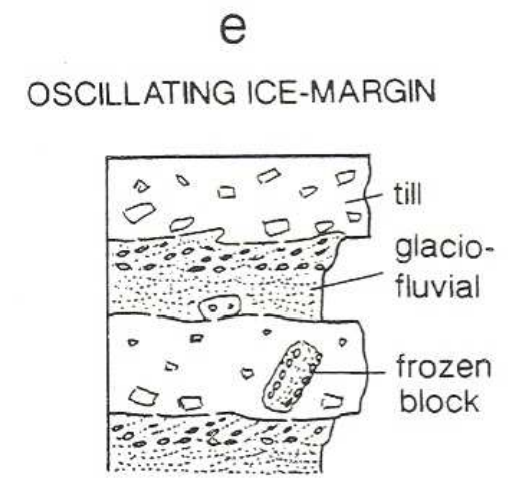
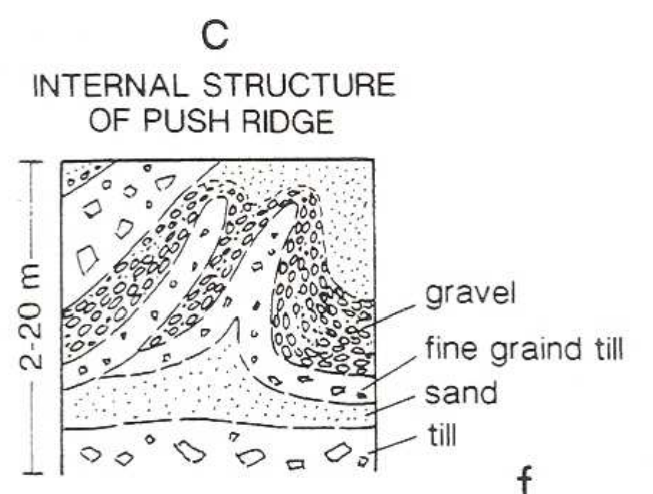
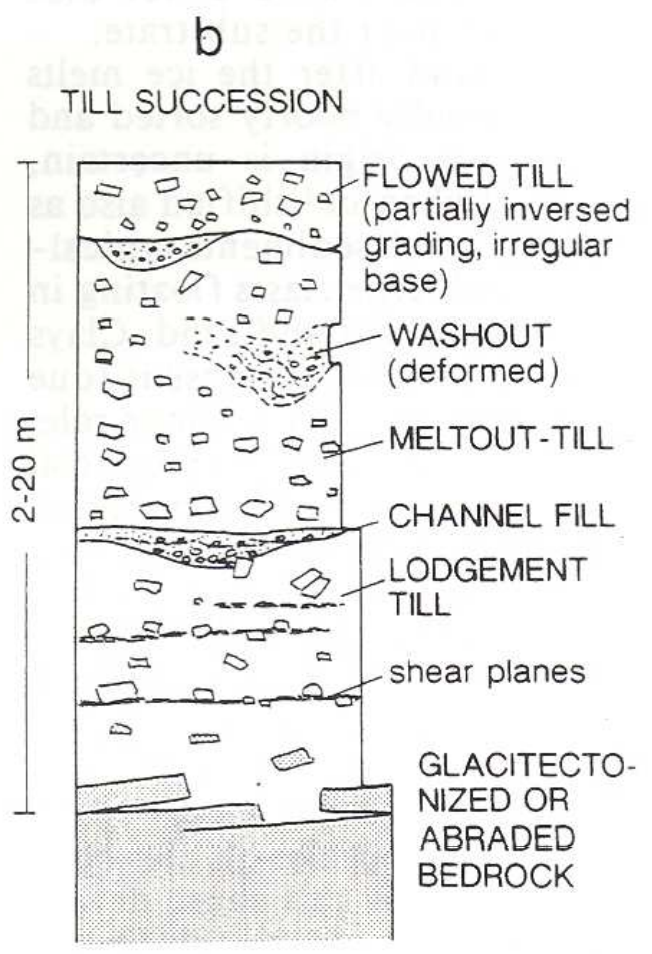
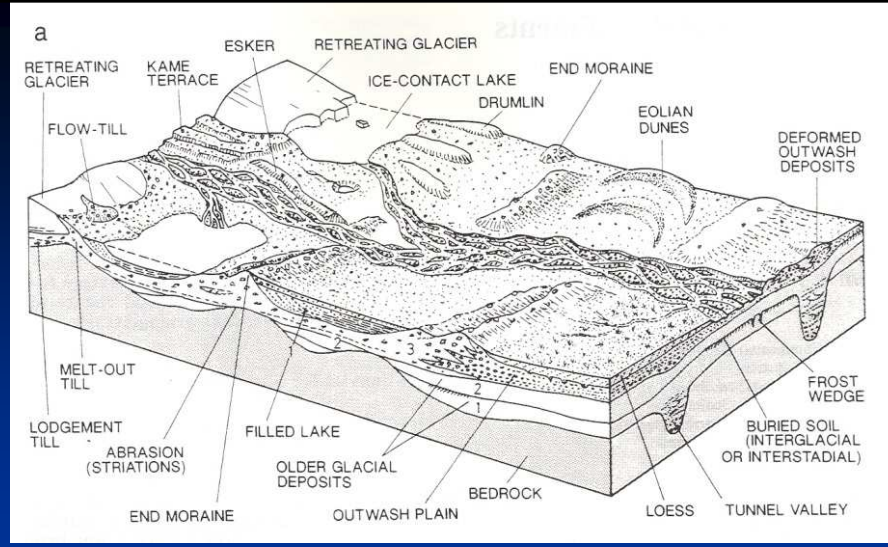

Figure 15. Deposition of different till types and their relation to the ice-body (M. Růžička, unpublished). A – bedrock deformed by ice in move, B – deformation till, C – subglacial till (lodgement and/or melt-out type), D – supraglacial melt-out till, E – flow till, F – subaquatic melt-out till.

# Faciální model kontinentálních glacigenních sedimentů







**53.** Morphologically distinct **rampart of an end-moraine**;  
older retreat stage of the last glaciation  
*Locality:* Obří Důl valley, Krkonoše Mts.  
*Photo by:* M. Růžička 1995



**56.** A detail of Plate 55, **till of an end-moraine**  
*Texture:* sandy stone gravel with blocks  
*Structure:* chaotic, no preferred orientation of clasts  
*Stratigraphy:* retreat stage of the last glaciation – Upper Pleistocene  
*Locality:* River Labe valley, Krkonoše Mts.  
*Photo by:* M. Růžička 1999



**55. Rampart of an end-moraine**  
*Texture:* sandy stone gravel with blocks, mostly angular clasts  
*Structure:* chaotic  
*Stratigraphy:* retreat stage of the last glaciation – Upper Pleistocene  
*Locality:* River Labe valley, Krkonoše Mts.  
*Photo by:* M. Růžička 1999

# Souvky

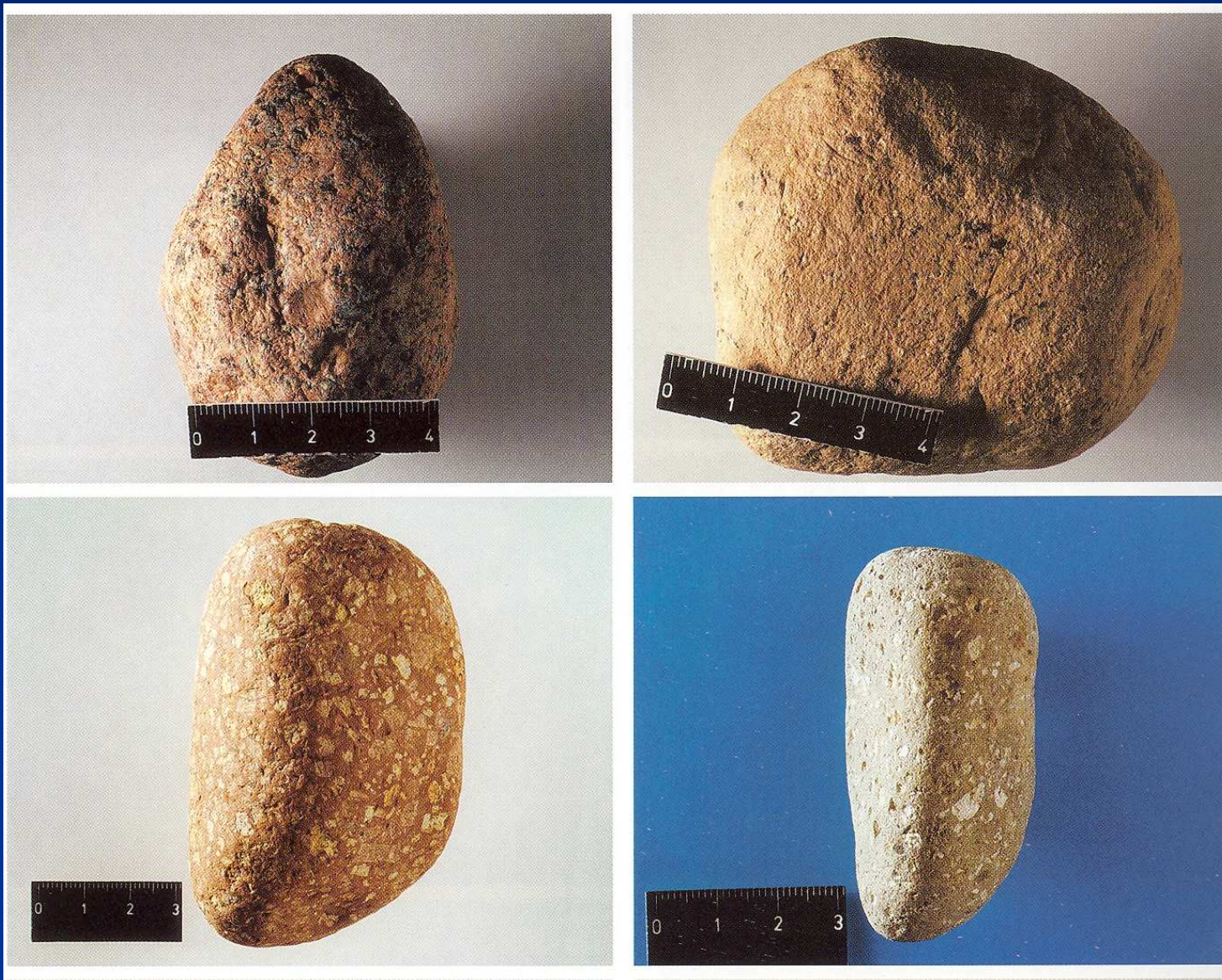





# Till

## 65. Lodgement till

*Texture:* clayey-silty sand, fine sand prevails, admixture of fine gravel clasts

*Structure:* massive, with signs of parallel stratification (deformed partly due to stresses exerted by younger ice advance); elongated pebbles show preferred orientation

*Stratigraphy:* Elsterian glaciation (the grey colouring is described as typical of Elsterian tills)

*Locality:* Kobeřice – open gypsum mine (Opava District)

*Photo by:* O. Holásek 1994



## 68. Lodgement till

The wavy base of the till layer is sloping down in the direction of the ice-sheet movement. The stratification at the base of the till suggests higher deposition rate in the lee-side of the underlying Pliocene sandy silts.

*Texture:* clayey-silty sand, mostly fine grained with admixture of gravel

*Structure:* massive with parallel stratification signs, distinct preferred orientation of elongated clasts

*Comment:* the surface of underlying sandy silt has been fragmented and loosened by the ice movement

*Stratigraphy:* Older Saalian (Palhanec) Glaciation

*Locality:* Chuchelná (Opava District)

*Photo by:* M. Růžička 1996



# Glacimarine sediments

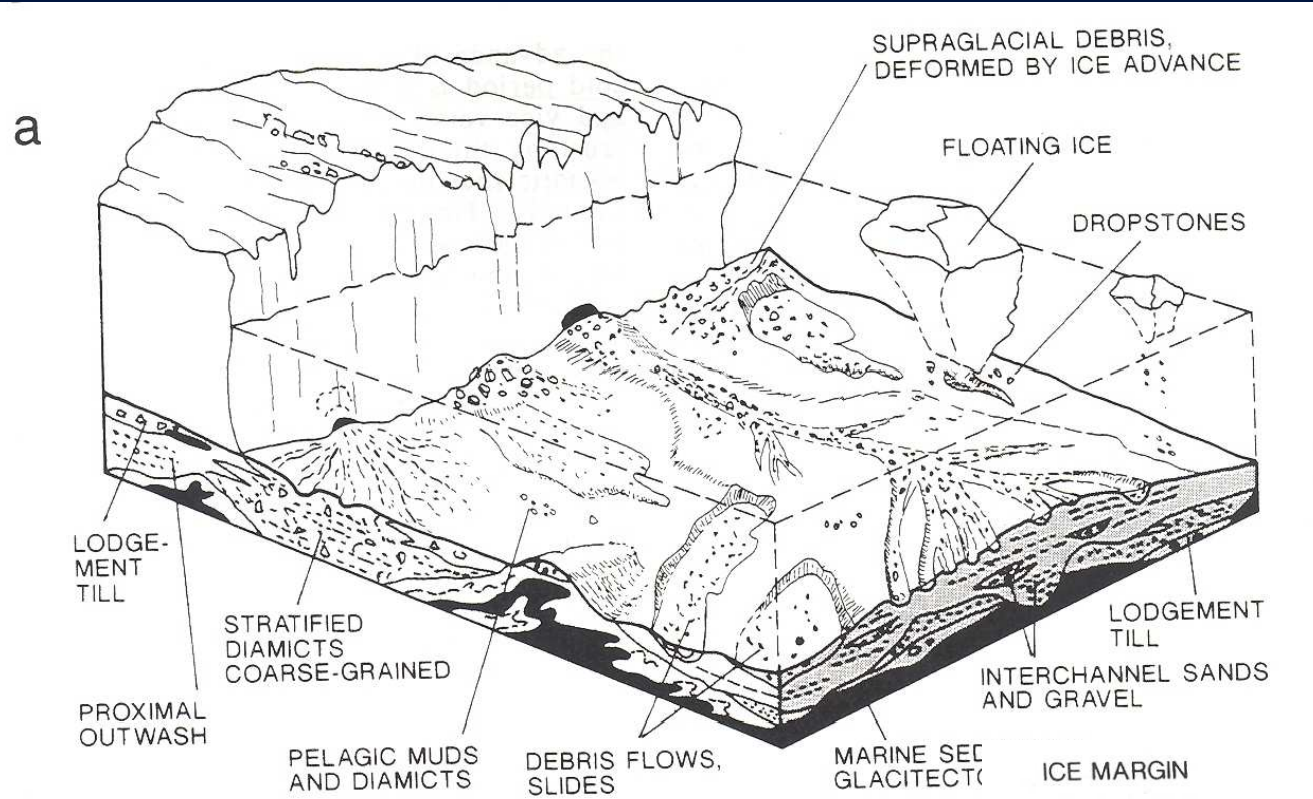

**ICE MARGIN**

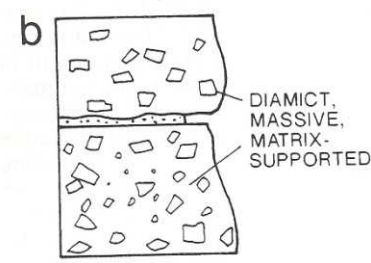

PROXIMAL → DISTAL

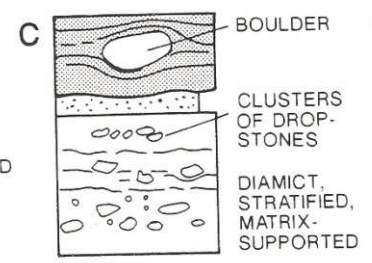

DISTAL

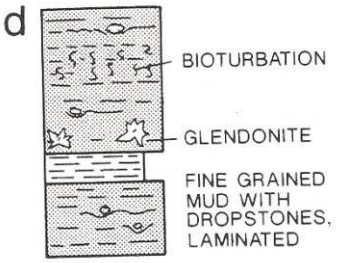

EFFECTS OF CURRENTS AND WAVES

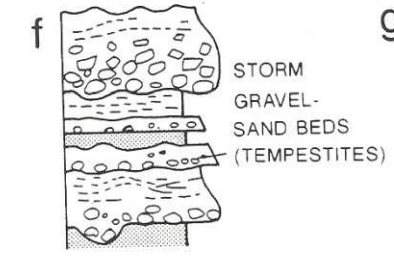
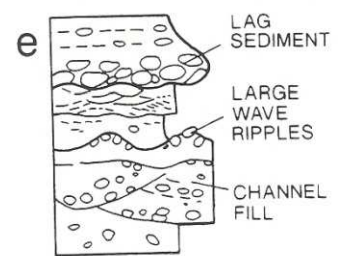

GRAVITY MASS MOVEMENTS

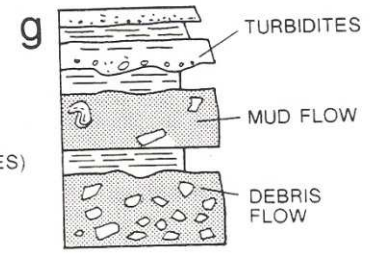

# Kvartérní kontinentální zalednění na severní Moravě

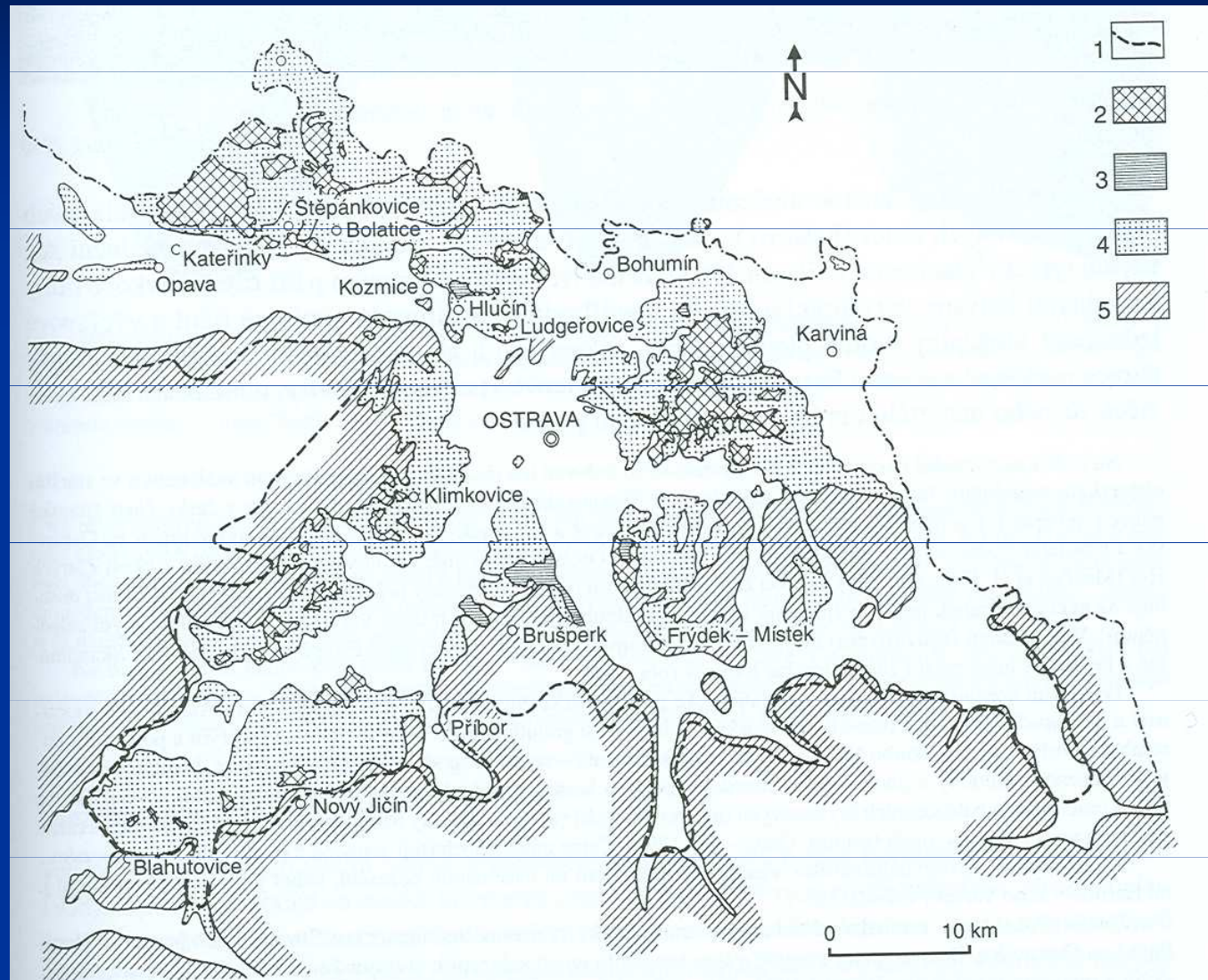

Obr. 264. Rozsah maximálního zalednění na severní Moravě a ve Slezsku. 1 – hranice největšího rozsahu saalského zalednění; 2 – souvkové hlíny; 3 – glacialakustrinní jíly a varvity; 4 – glacialakustrinní písky; 5 – horniny skalního podkladu (J. Macoun et al. 1965).

# EOLICKÉ SEDIMENTY

The image features a solid blue background. In the center, the text "EOLICKÉ SEDIMENTY" is written in a white, serif, all-caps font. Below the text, there are faint, stylized white wavy lines that resemble sand dunes or sedimentary layers, extending from the right side towards the center.

# Eolické sedimenty

- Písek, prach
- Ukládaná pod přímým vlivem činnosti větru (proudící vzduch) bez ovlivnění tekoucí nebo stojatou vodou
- tj. zachovávají si rysy typické pro eolické prostředí

# Eolické prostředí

- Aridní prostředí (pouště a polopouště): cca 34% povrchu souše (recent)
- 20 – 45% plochy pouští je pokryto „písečnými moři“ (ergy)
- Od (sub)tropického pásma až po polární oblasti
- V geologické minulosti se plocha pouští měnila
- (pleitocén – plocha pouští větší, subtropické pámo posunuté k vyšším zeměpisným šířkám)

# Recentní eolická prostředí

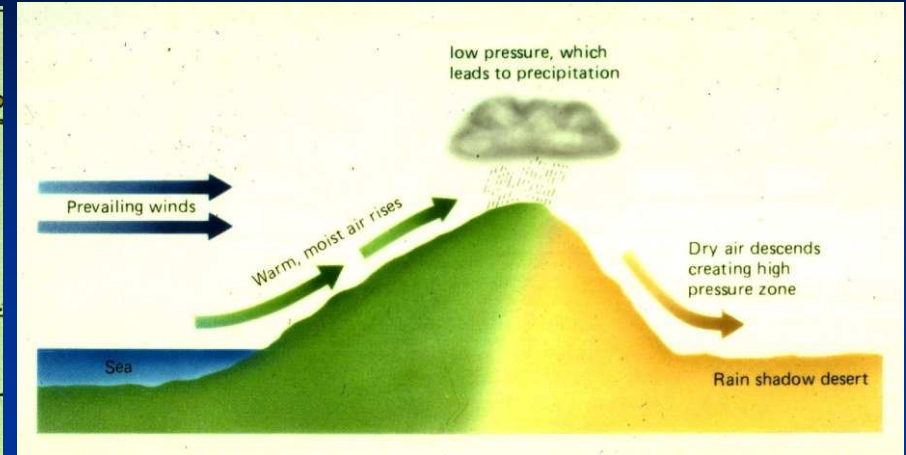
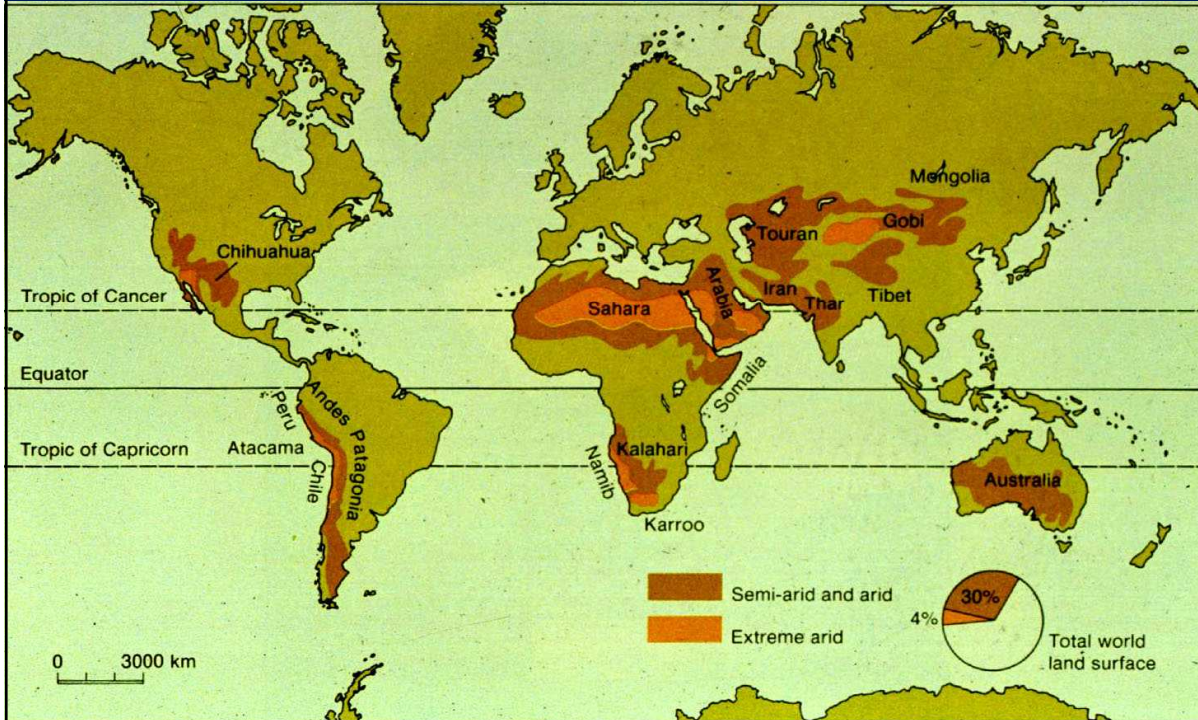

## Srážkový stín

### Why we get more deserts

In the subtropics-falling air is cold and dry,  
Warm air rise and is moist- hits higher altitudes and  
Causes precipitation as it cools

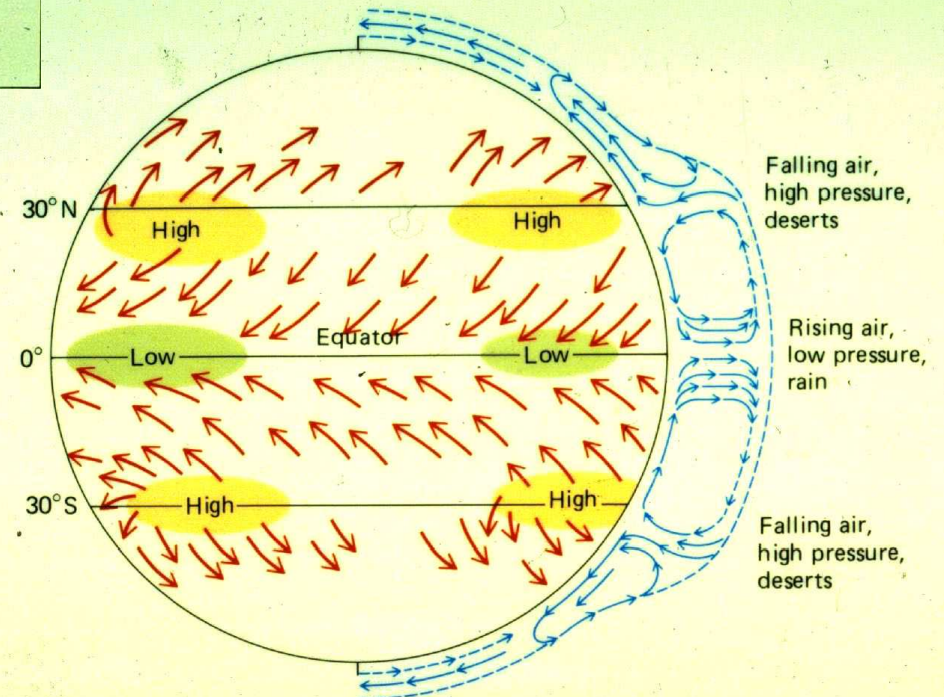

# Globální distribuce recentních eolických sedimentů

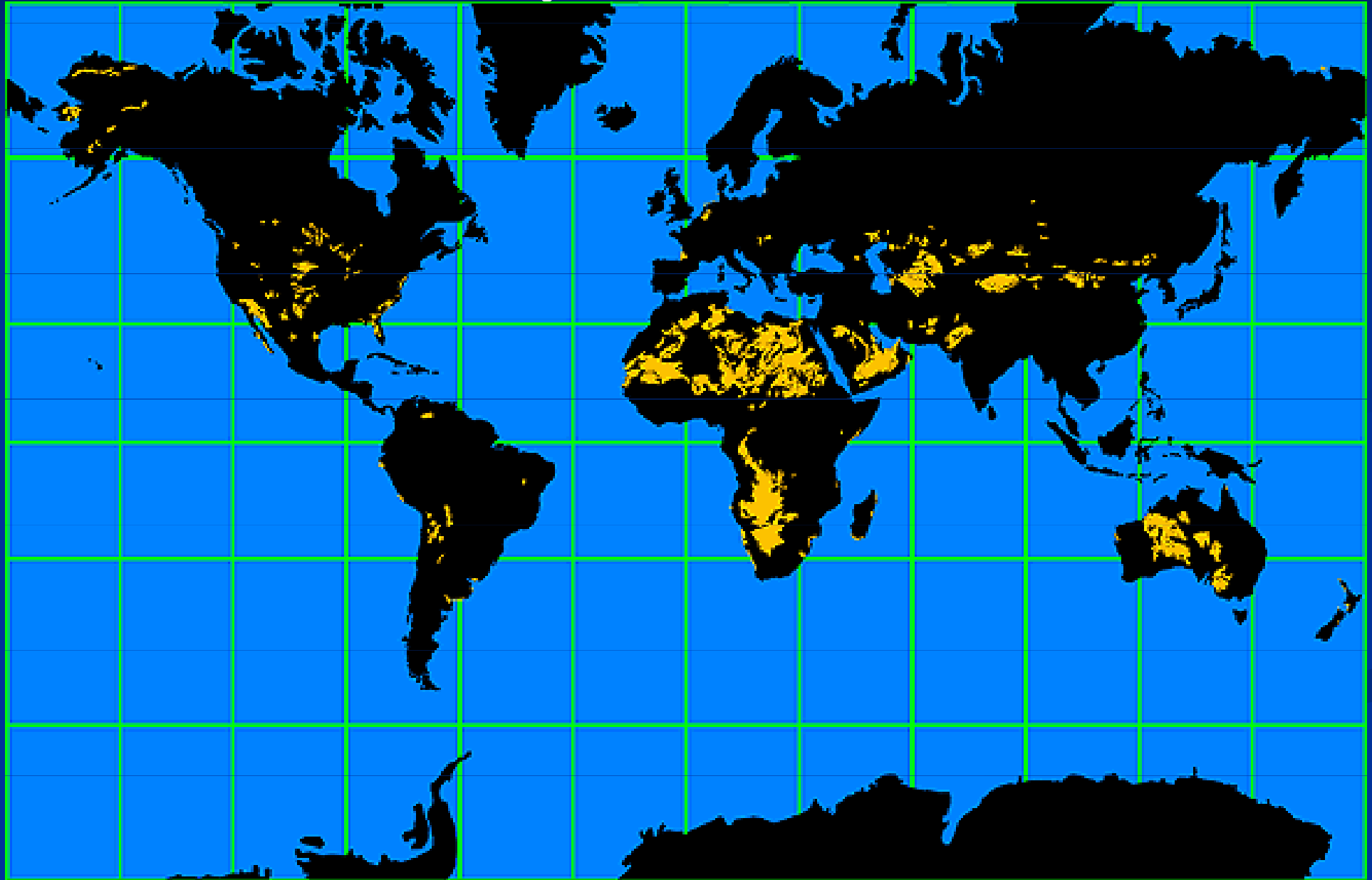



# Větrná eroze a transport

- Odvalování, klouzání
- Saltace
- Suspenze

Závislé na velikosti částic

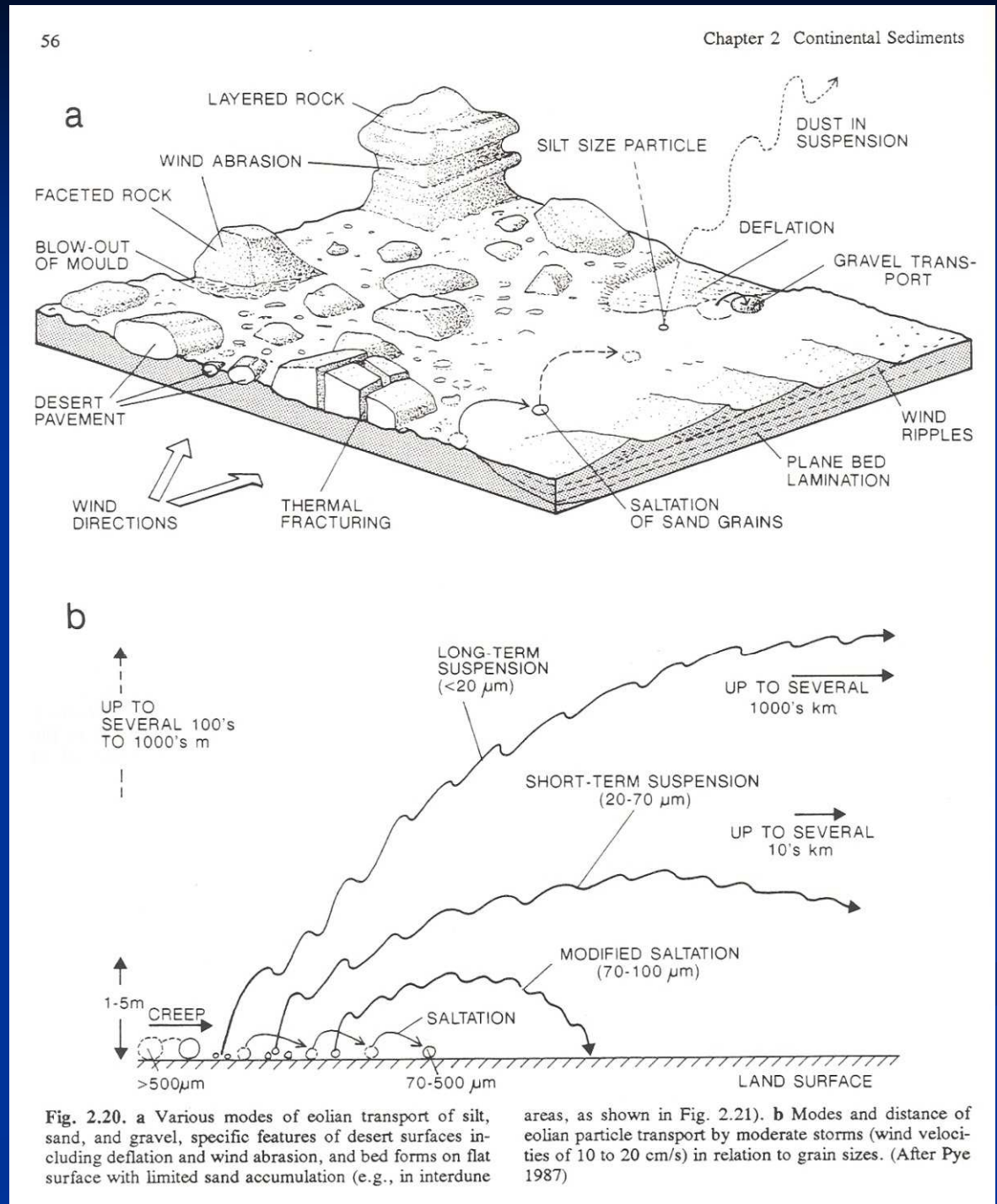

# Fyzikální principy transportu hraniční vrstvy (boundary layer)

## HRANIČNÍ VSTVA V NEWTONOVSKÝCH KAPALINÁCH (VZDUCH, VODA)

*Hraniční vrstva: zóna zpomalení kapaliny v blízkosti kontaktu s pevnou látkou, se kterou je kapalina v relativním pohybu*

Rychlostní profil proudící kapaliny na hraniční vrstvě

$$\tau = \eta \frac{dU}{dy}$$

$\tau$  = smykové napětí

$\eta$  = kinematická viskozita

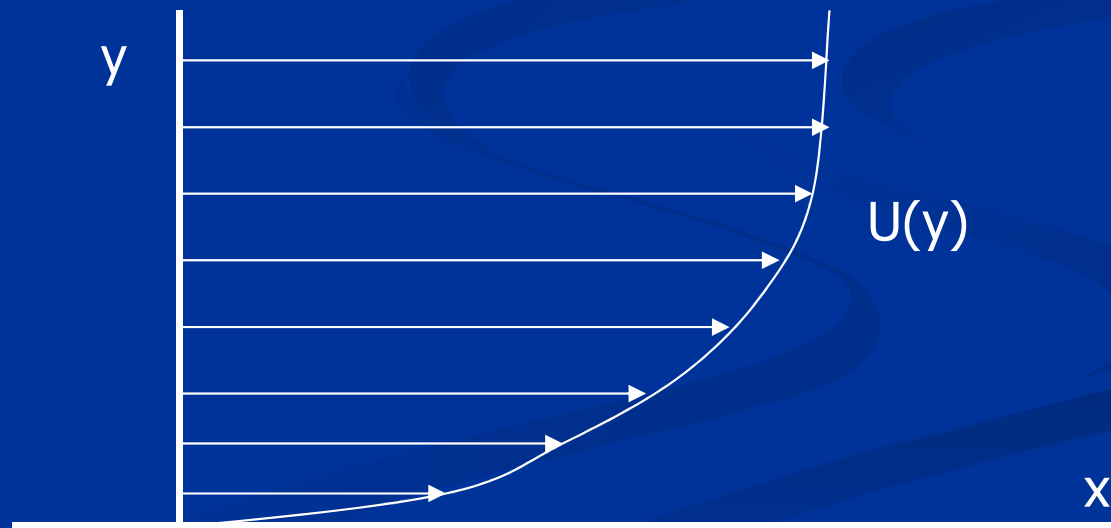

# Proudění vzduchu

- Water and air are fluids
- But air is less dense (so higher velocities required)
- Suspension and saltation
- Prahová rychlost větru 1 cm nad povrchem

$$u = 0,06 \sqrt{(\rho_s - \rho_f)gD}$$

$u$  = prahová rychlost

$\rho_s$  = hustota částice

$\rho_f$  = hustota fluida (vzduchu)

$g$  = gravitační zrychlení

$D$  = průměr částice

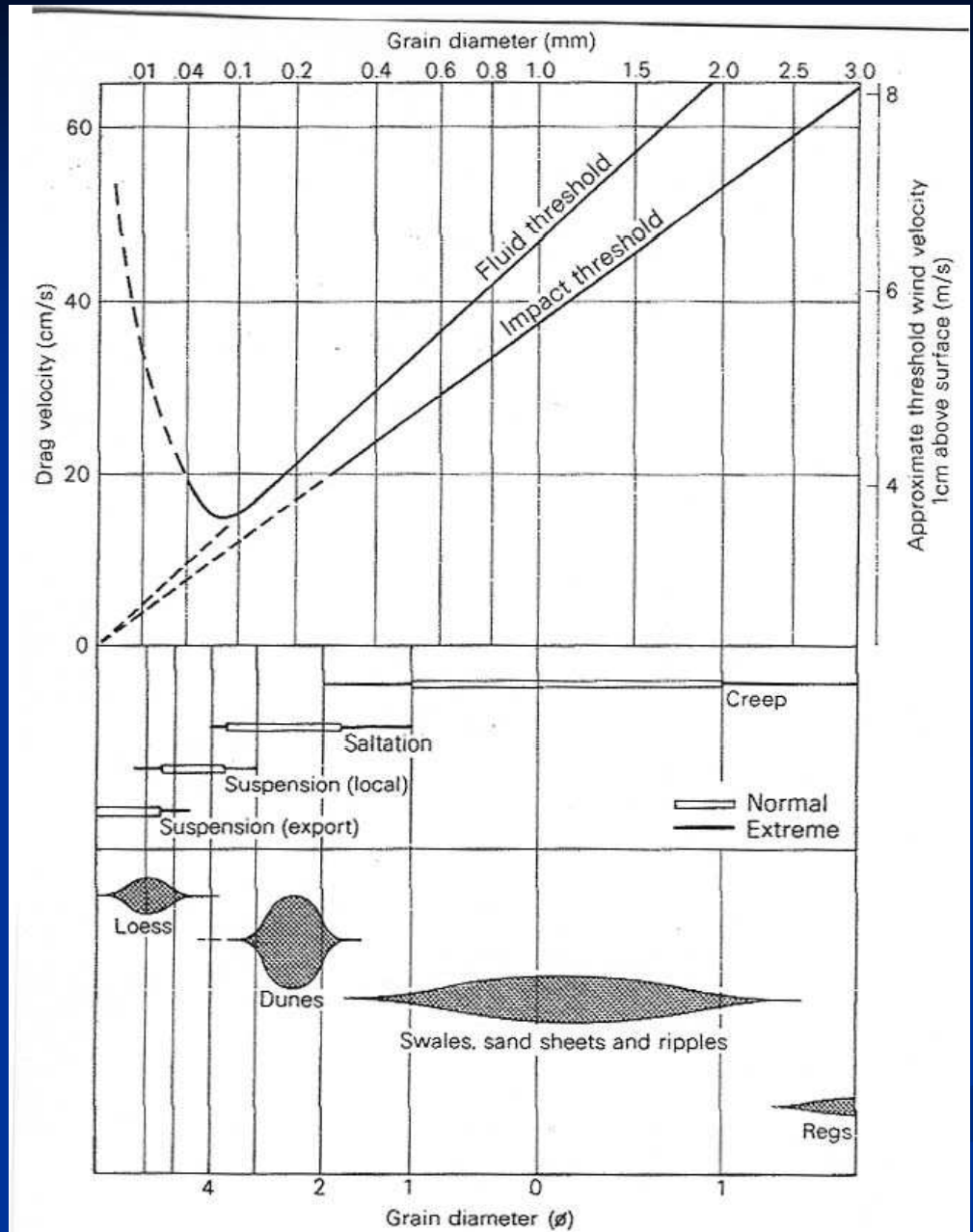

65. Relationships between grain size, fluid and impact threshold wind velocities, characteristic modes of aeolian transport, and resulting size-grading of aeolian sand formations. After Bagnold, 1941, and Folk, 1971a.

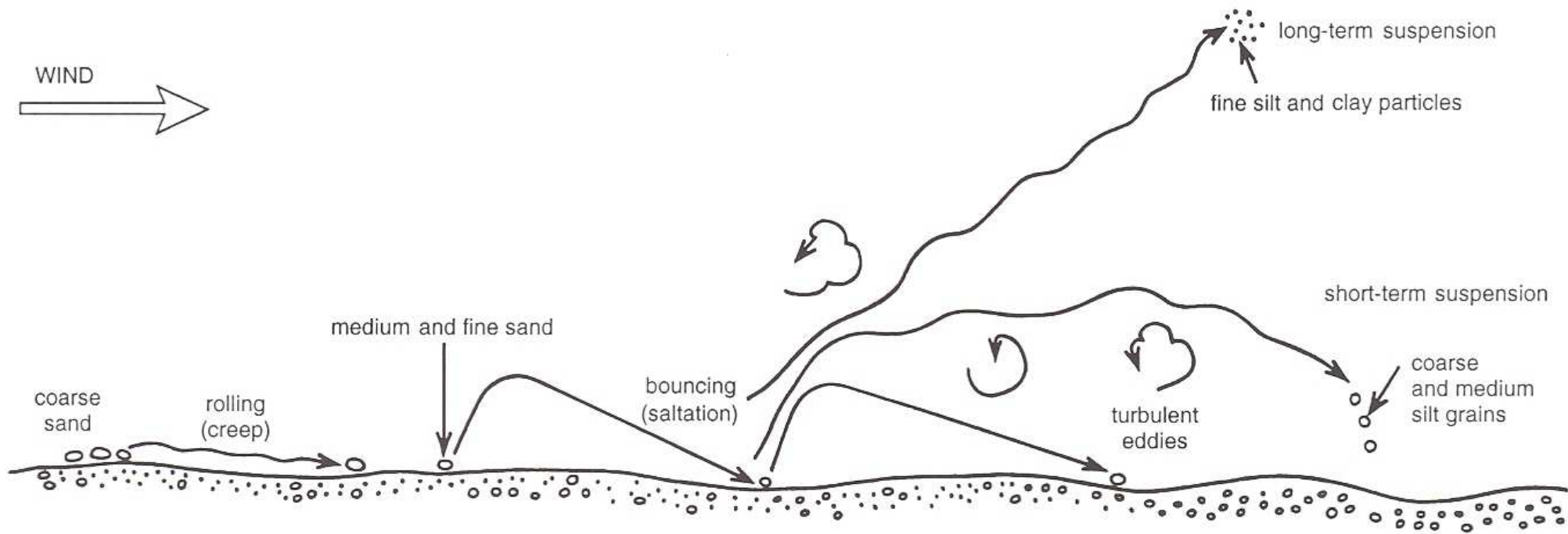

Figure 25. Schematic diagram showing the principal modes of aeolian transport and sedimentation (PYE and TSOAR 1987, modified).

# Písčitá frakce

## základní tvar povrchu: duna

### SEPARACE TOKU

V hraniční vrstvě částice ležící nejbliže podloží (dnu) nebo přímo na dně mají **nejnižší kinetickou energii**

Tyto částice budou silně ovlivněny při změně rychlosti toku (zpomalení, zrychlení) nebo v místě změny sklonu dna

**Zpomalení / ohyb dna směrem dolů** -> tyto částice se zastaví nebo se dokonce začnou pohybovat pět, nahromaděná kapalina nutí hlavní tok téci výše ode dna a vyvine se zpětný proud – **separace proudu**

**Proudnice** se oddělí ode dna

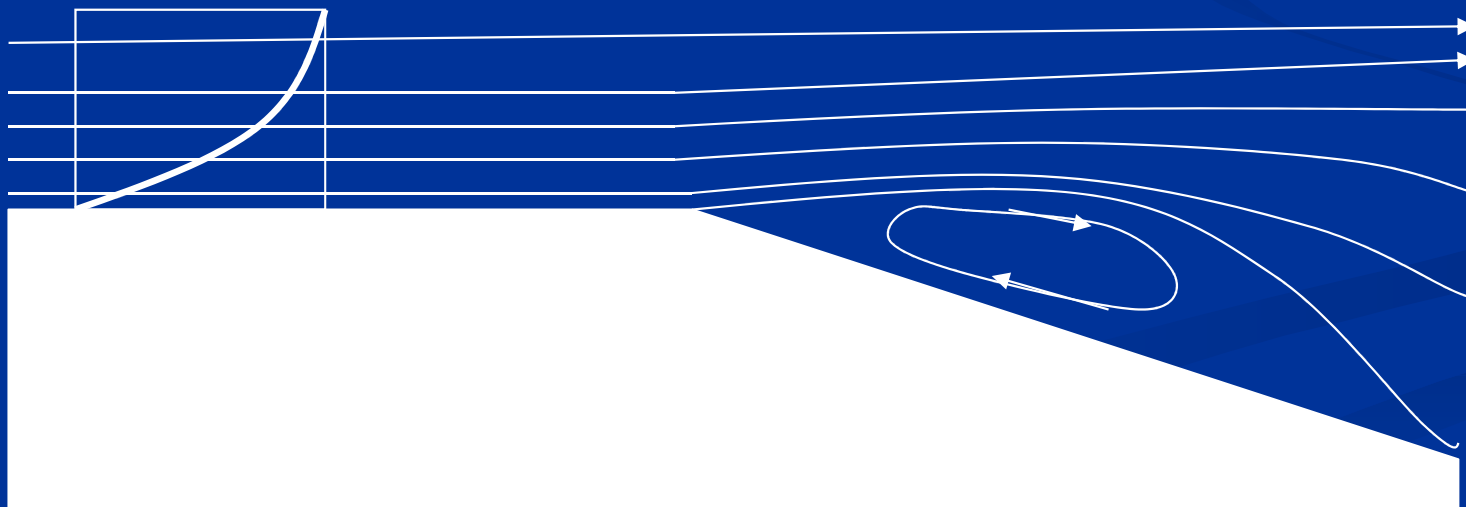
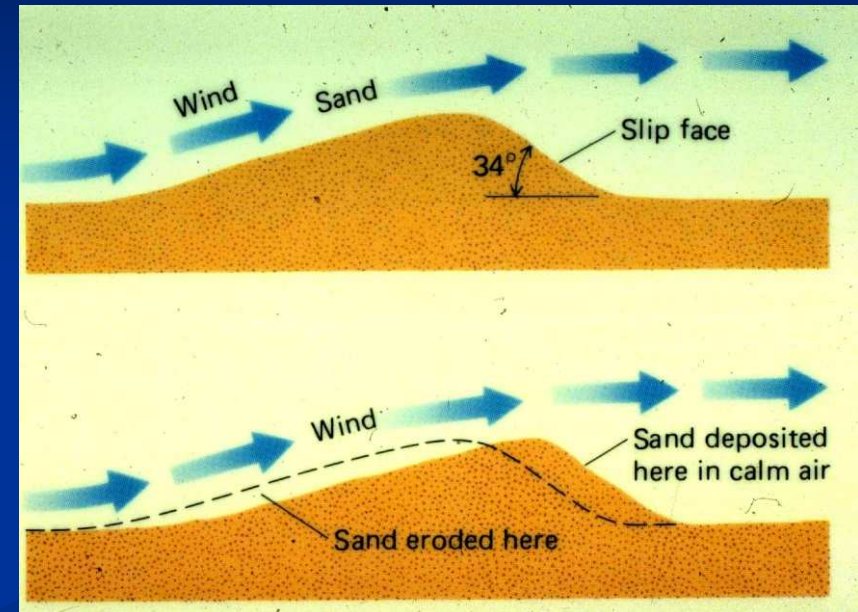

# Nebraska sand hills



(NASA)



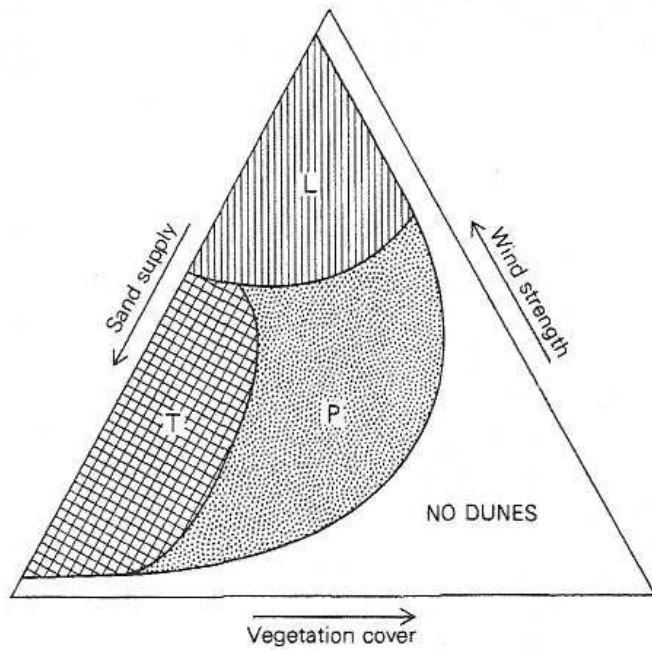

74. Relationships between dune form and the factors of sand supply, wind strength and vegetation in the Great Plains, United States. L = longitudinal, T = transverse, and P = parabolic forms. After Hack, 1941.

## Texturní charakteristika:

Planární šikmé zvrstvení

Čeřinové zvrstvení (šplhavé čeřiny)

Laminární zvrstvení

Chaotické (zrnotoky na závětrné straně duny)

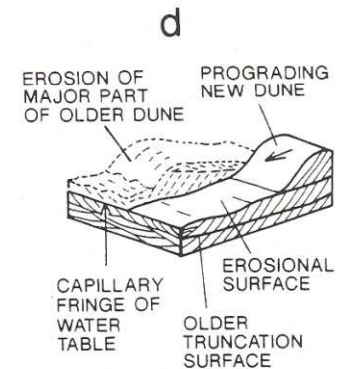
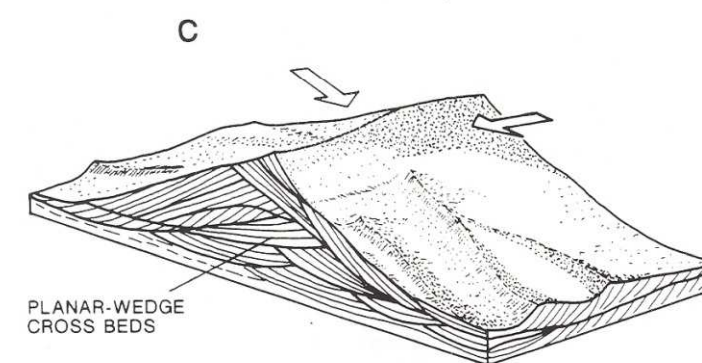
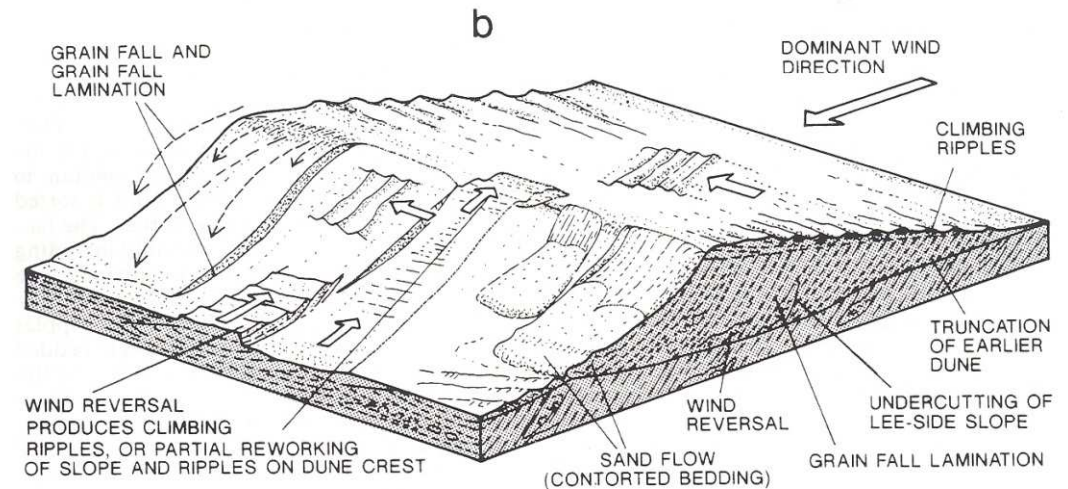
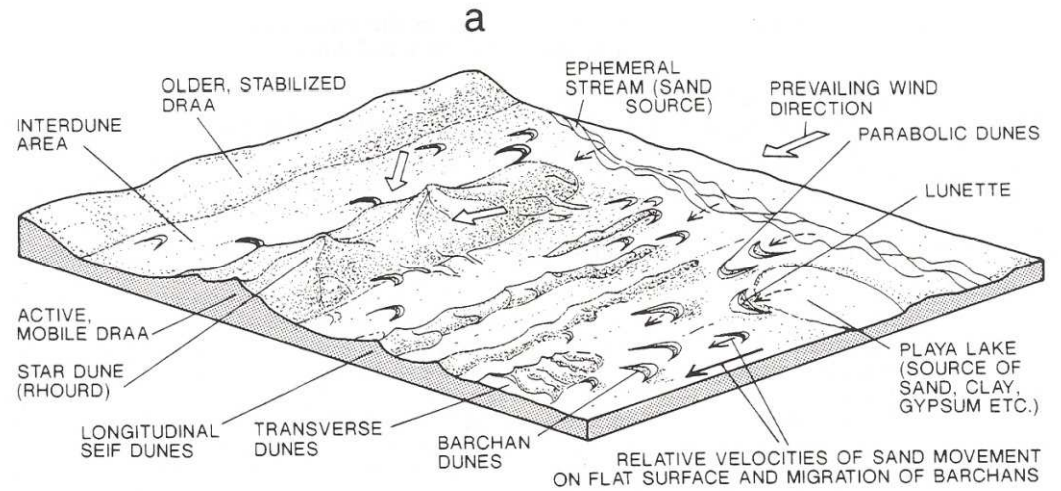



**181. Sand dunes** in the River Lužnice valley; height of dunes 3.5 m

*Locality:* Pískový vrch near Vlkov (Třeboň District)

*Photo by:* E. Růžičková 1997



**184. A complex of aeolian sands** forming a thick sheet

*Texture:* mostly medium grained sand with subordinate interlayers of well sorted coarse sand and/or fine gravel (pebbles < 5 mm)

*Structure:* stratified, parallel, thin bedded, lamination in places, laminae wavy or rippled

*Locality:* sand pit in Travčice near Terezín

*Photo by:* J. Kadlec 1997



# Spraš

## Definice

Yellowish-buff unstratified silt, sometimes calcareous, well sorted, with a modal grain size in the range 0.02-0.5 mm, and with pronounced vertical structure

# Spraš

- Loess: wind-blown deposit comprised predominantly of silt-size particles (20-60  $\mu\text{m}$ ).
- Loess deposits cover  $\sim 10\%$  of the surface of the planet. They are up to  $\sim 300$  m in thickness in China.
- Loess deposits typically exhibit varying stages of soil development.

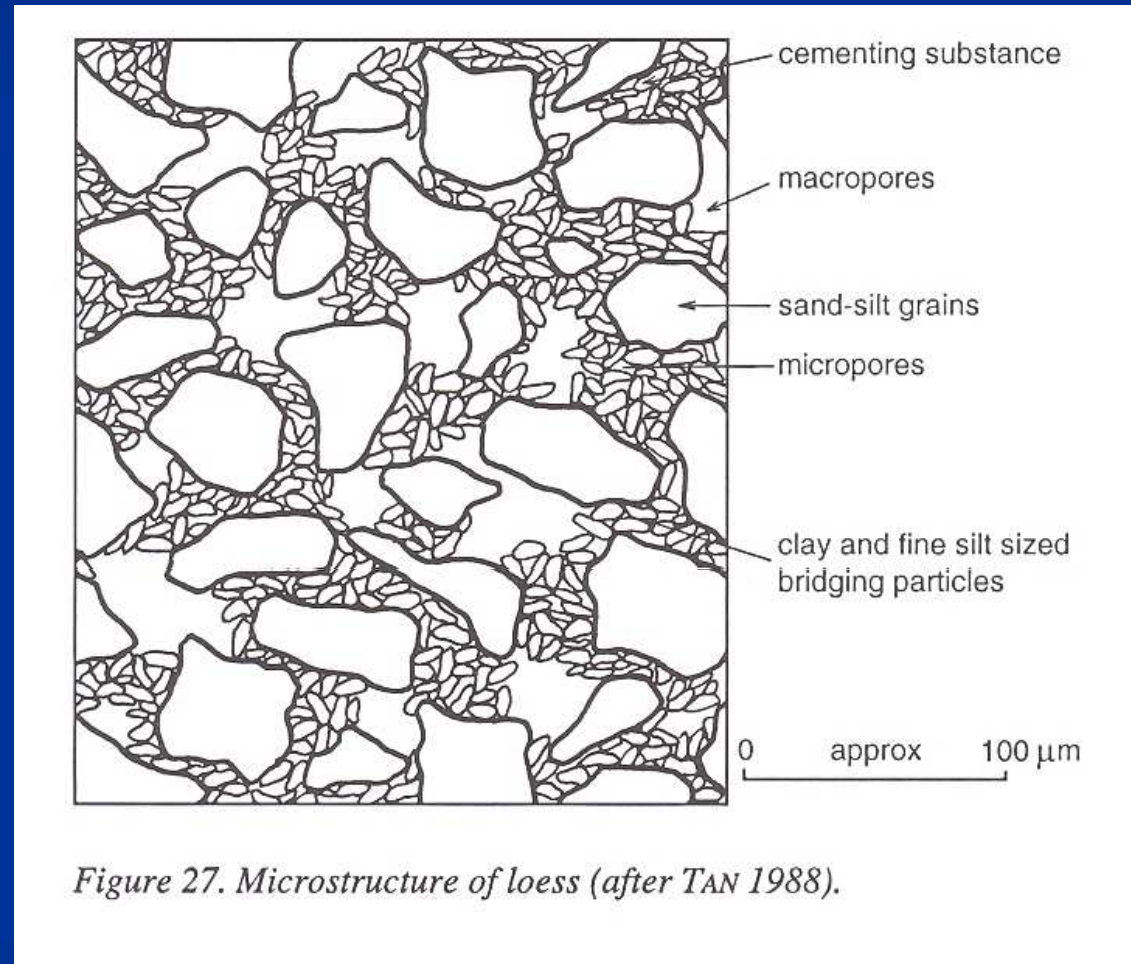



**145. Loess, a detail of the Plate 144**

Basal part of the chernozem fossil soil

Thin bedding to lamination parallel to the slope surface; typical prismatic jointing, the joint surfaces are sheathed with a white film of calcium carbonate

*Locality:* Praha-Sedlec

*Photo by:* A. Zeman 1997



**146. Loess**

A lee-side accumulation on a smooth south-eastern slope

*Texture:* calcareous silt

*Structure:* layering parallel to the slope in general, massive or thin bedded in individual layers

*Stratigraphy:* Upper Pleistocene

*Locality:* Kutná Hora-Sedlec

*Photo by:* A. Zeman 1997



### 166. Loess

Same as Plate 164, a position displaying a well marked parallel orientation of mica (← the arrow is perpendicular to the lamination) and with a snail shell partly filled with the loess  
Magnification 26.9x, crossed polars



# Globální distribuce sprašových sedimentů

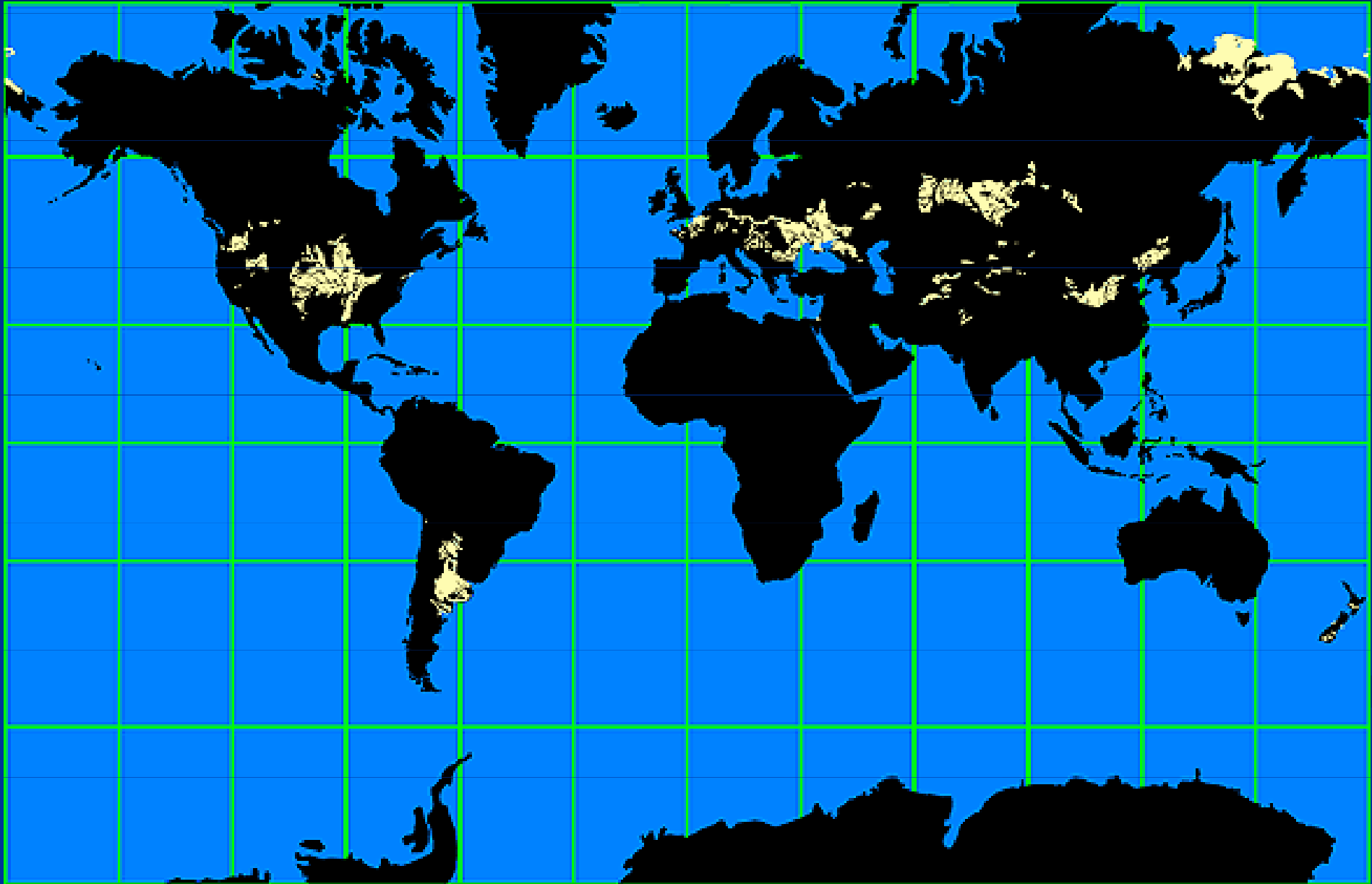

# Quaternary Eolian Deposits

(Adapted from  
Thorp et al 1951)

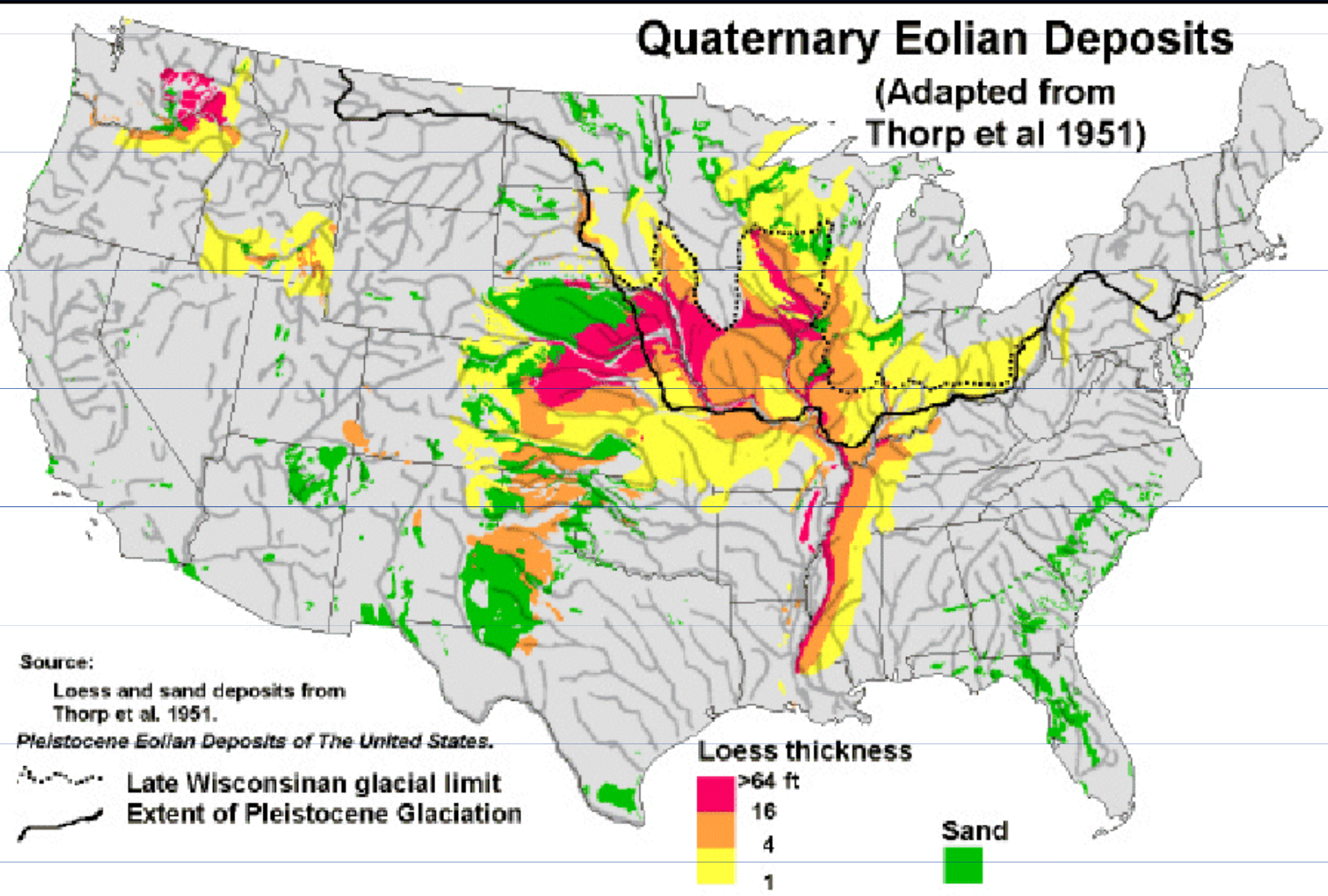





Source:

Loess and sand deposits from  
Thorp et al. 1951.

*Pleistocene Eolian Deposits of The United States.*

-  Late Wisconsin glacial limit
-  Extent of Pleistocene Glaciation

Loess thickness

-  >64 ft
-  16
-  4
-  1

Sand



# Kvartérní produkce sedimentů prachové frakce

- Evidence of ice-driven response found in China
  - Plateaus of wind-blown silt
  - Deposited by strong winds and dry conditions
- Loess deposition post-dates weathered soil at 2.75 mya
  - Onset of dry conditions at glacial inception
  - 100,000 year cycle over last 0.5 my

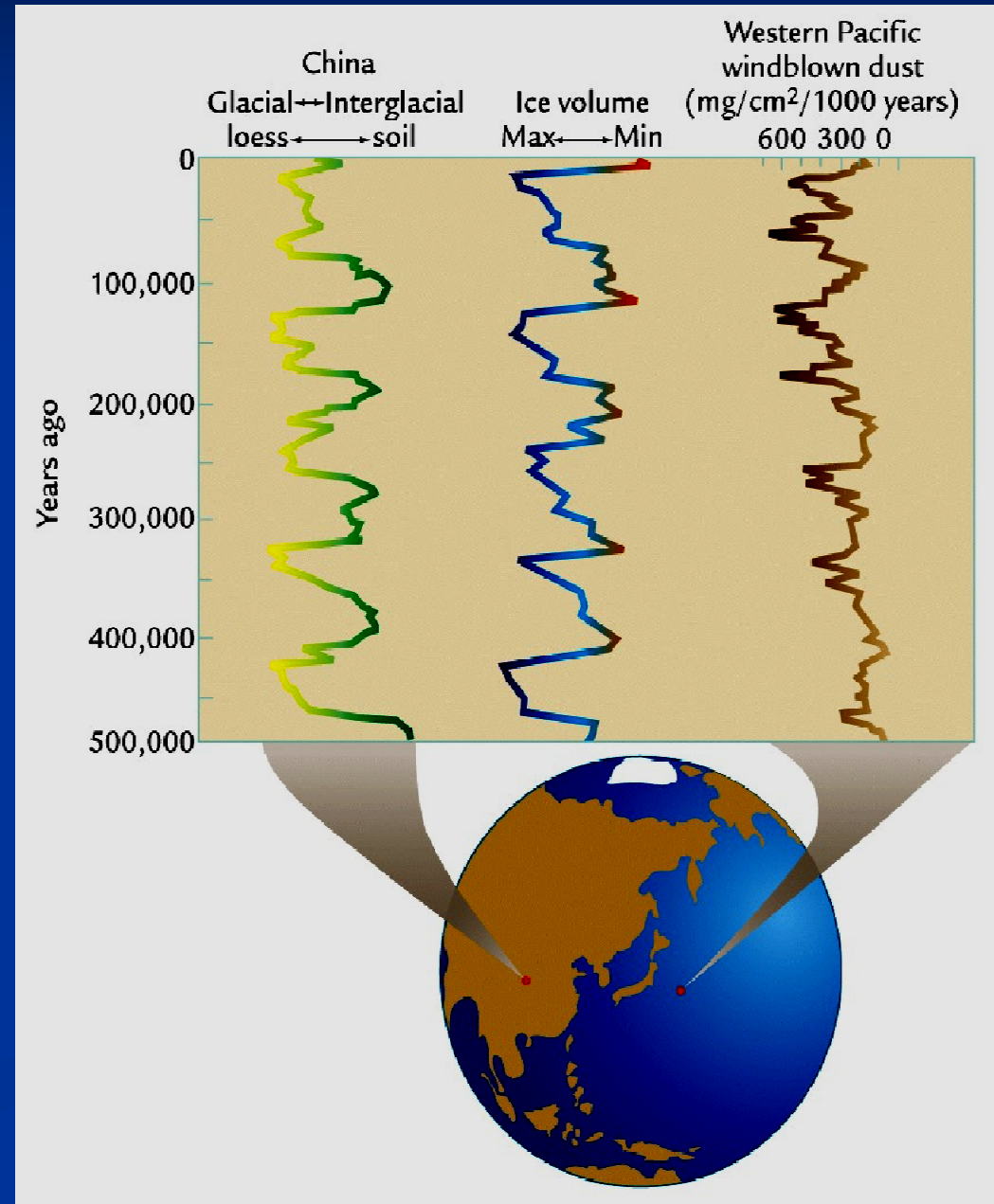

# Vznik spraší

- Related to four events:
  - Dust formation
  - Transport
  - Deposition
  - Post-depositional changes





# Vznik spraší

## ■ Formation

- Metamorphic rocks have silt-size minerals that are expelled during erosion.
- Weathering and soil formation fracture coarse grains, creating silt particles.
- Transformation of clay particles can produce silt-size minerals.
- Glacial grinding, eolian abrasion, frost weathering, salt weathering.

# Vznik spraší

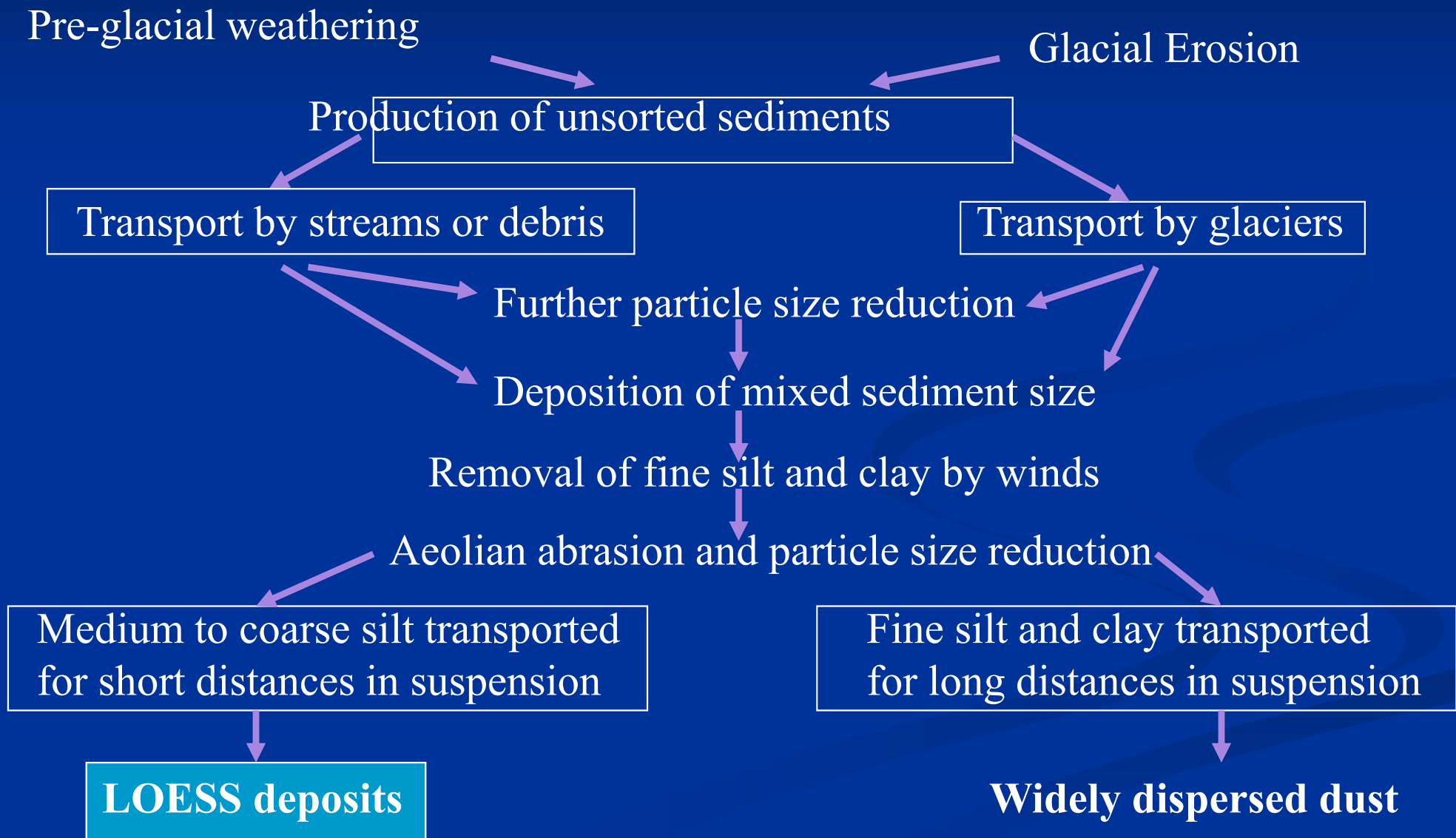

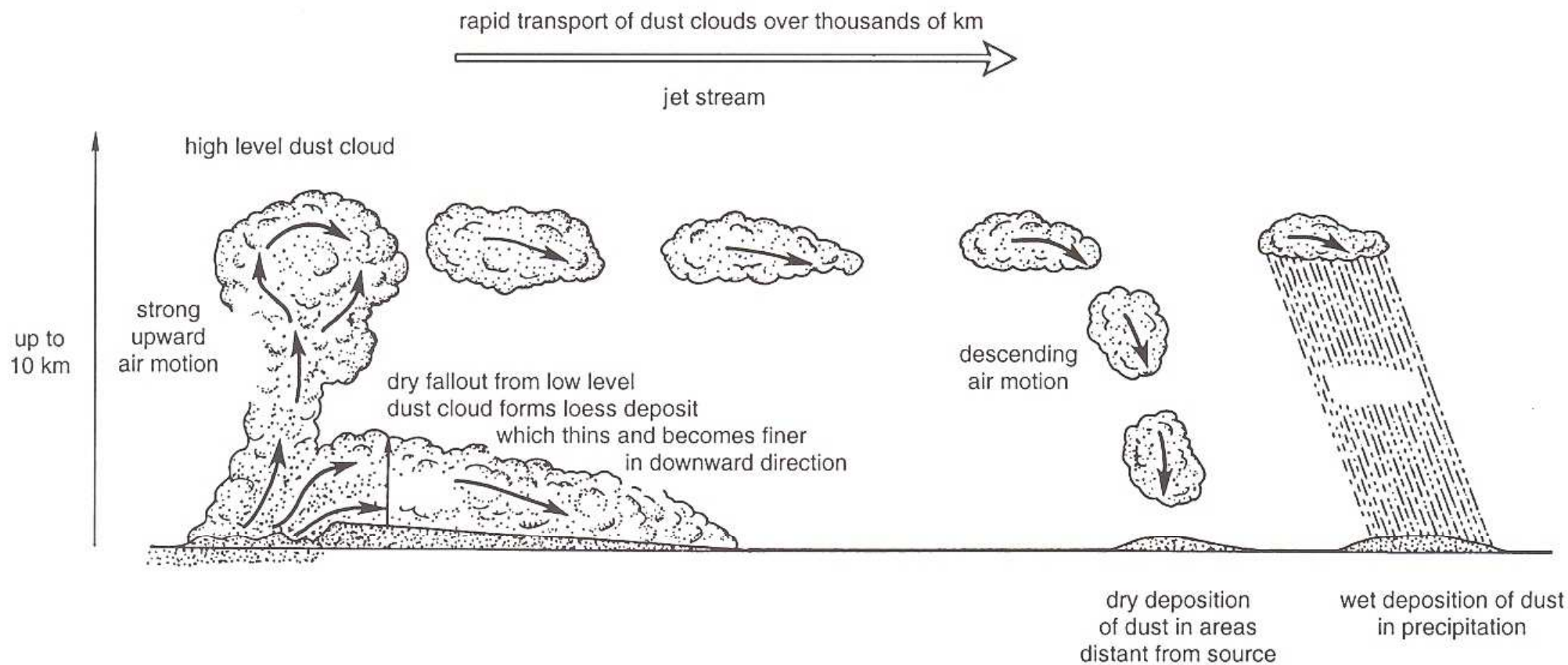

Figure 26. Diagram showing two transport models of aeolian silt (after PYE 1995).

# Vznik spraší

- Transport/Deposition
  - Wind (streams?)
    - Strength
    - Direction
    - Vegetation
- Post-depositional changes
  - Soil formation
    - Temperature
    - Rainfall
    - Slope
    - Vegetation



# Chronologie sprašových usazenin

- Stratigraphy
- Radiocarbon
- Magneto-stratigraphy
- Correlation (marine isotope record).

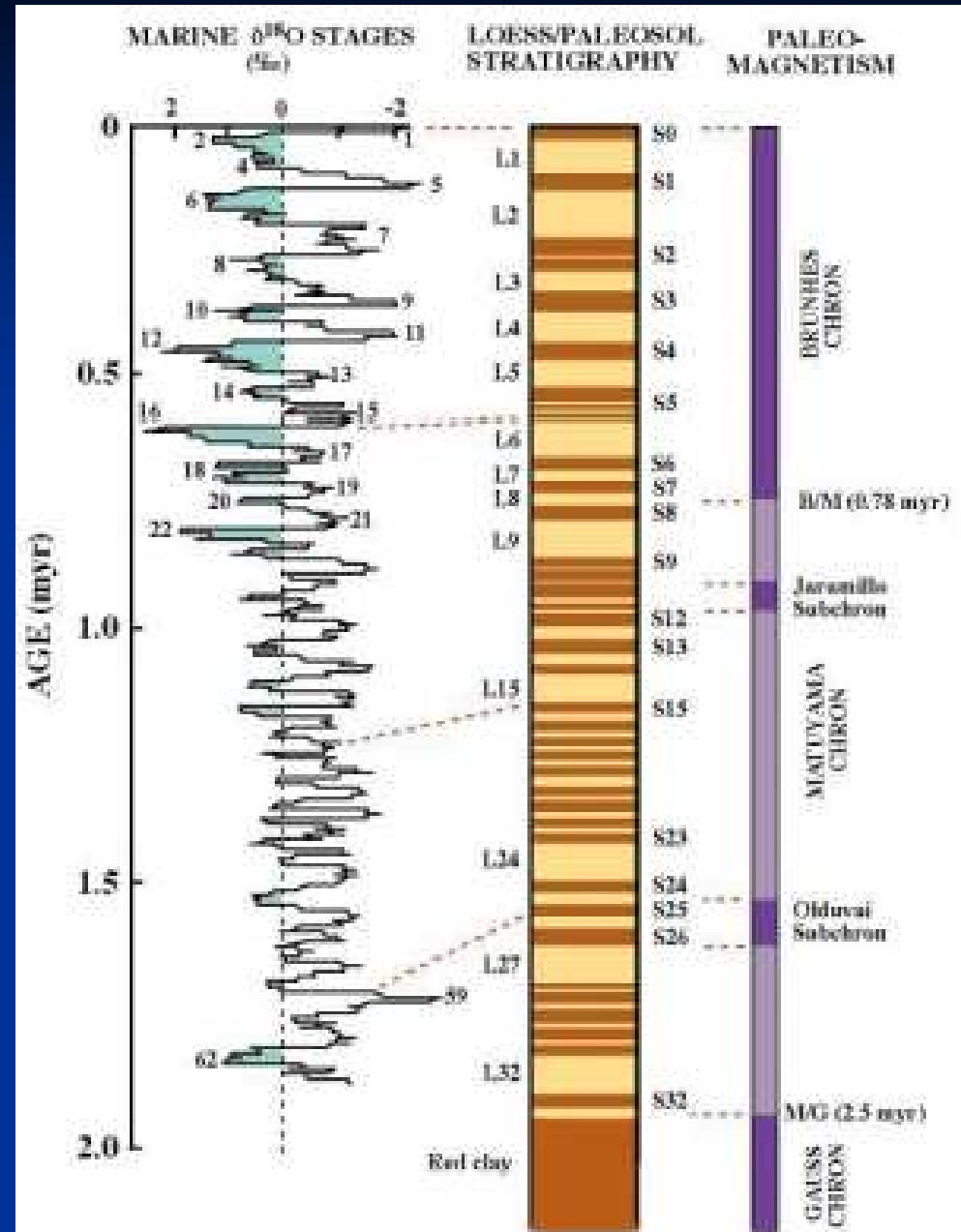

(after Rutter et al., 1991)

[http://depts.washington.edu/uwpcol/mages/loess\\_marine.gif](http://depts.washington.edu/uwpcol/mages/loess_marine.gif)

# Paleoklimatologie spraší

- Grain size (wind direction/strength).
- Soil type (vegetation, rainfall).
- Magnetic susceptibility (source and post-depositional changes).
- Pollen (vegetation).
- Land snails (temperature, rainfall).



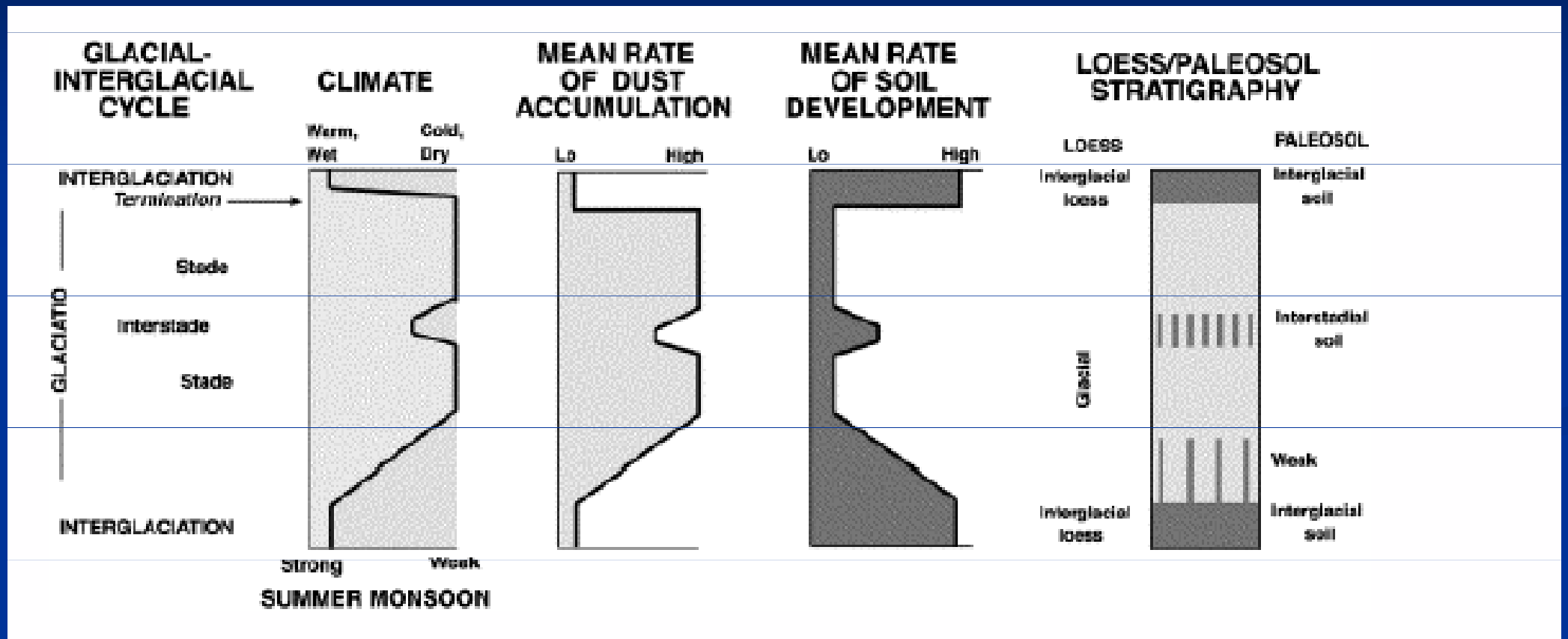

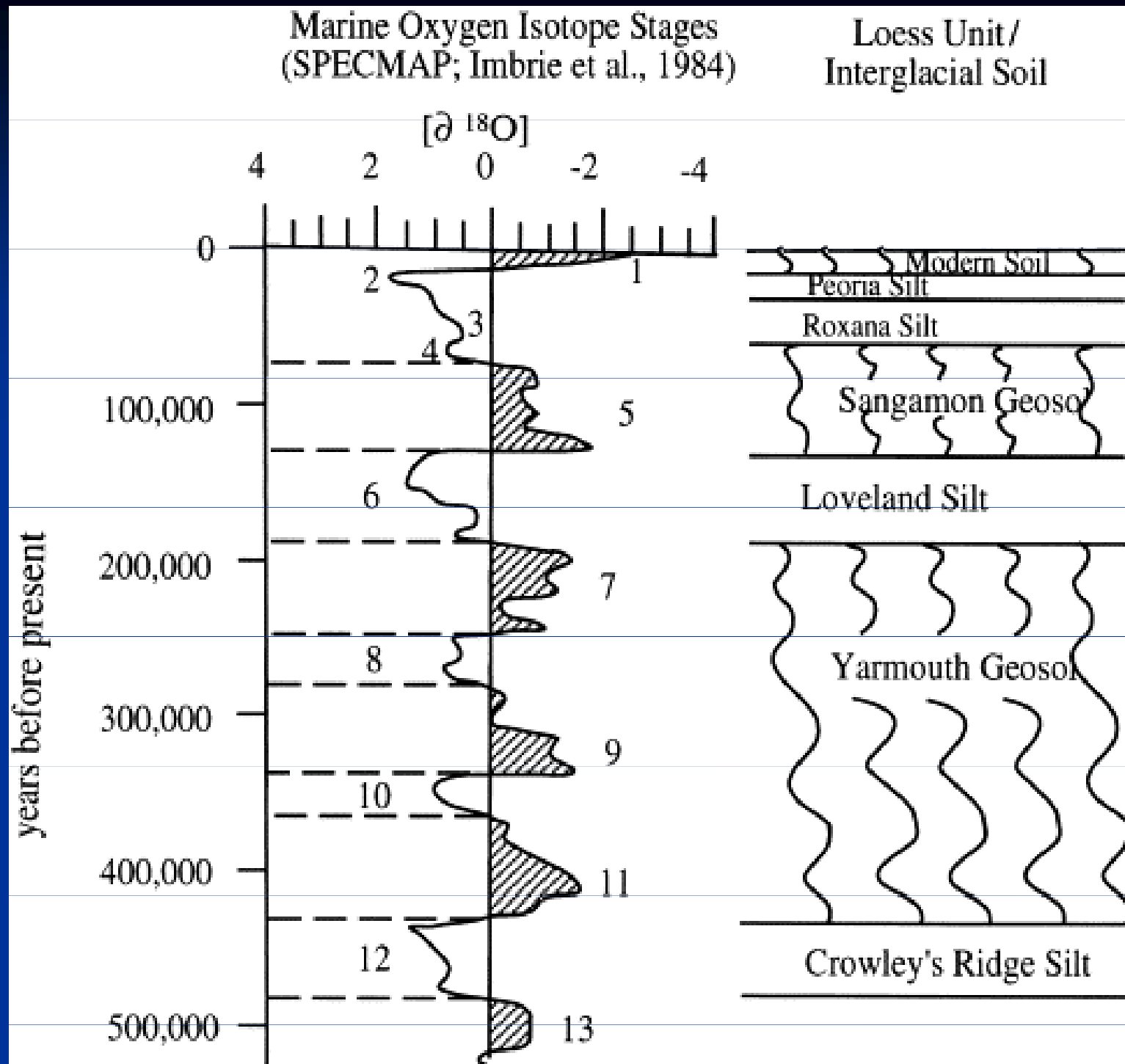

Loess–paleosol sequence at Thebes, Illinois



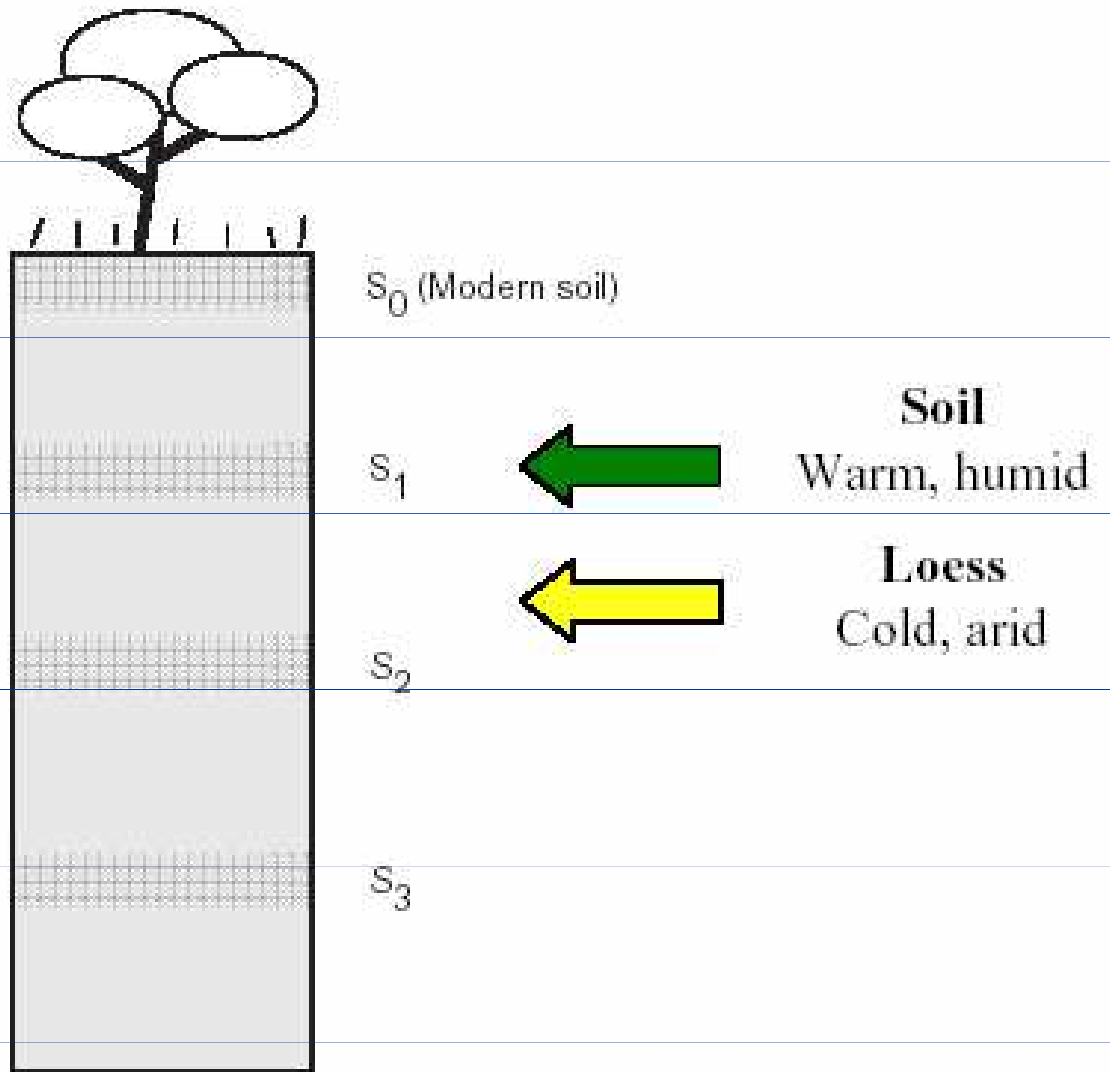

Late Pleistocene -Holocene loess, Burzahom, Kashmir

**STRATIGRAPHY**

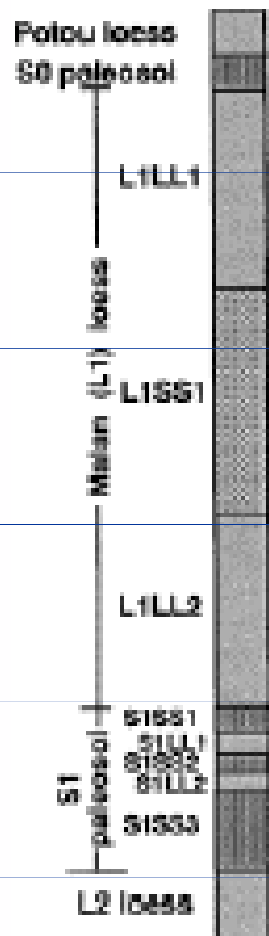

**MAGNETIC SUSCEPTIBILITY (SI units)**

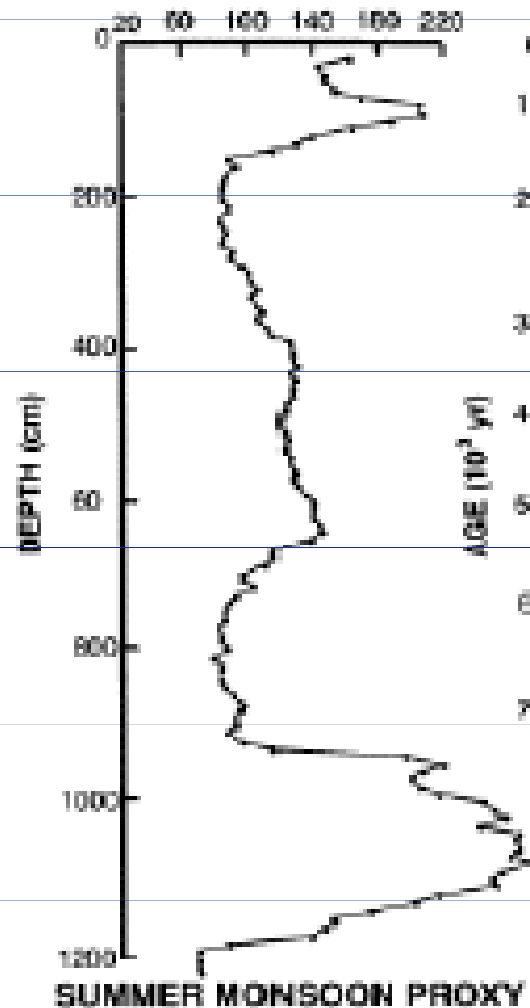

**QUARTZ FRACTION MEDIAN DIAMETER (µm)**

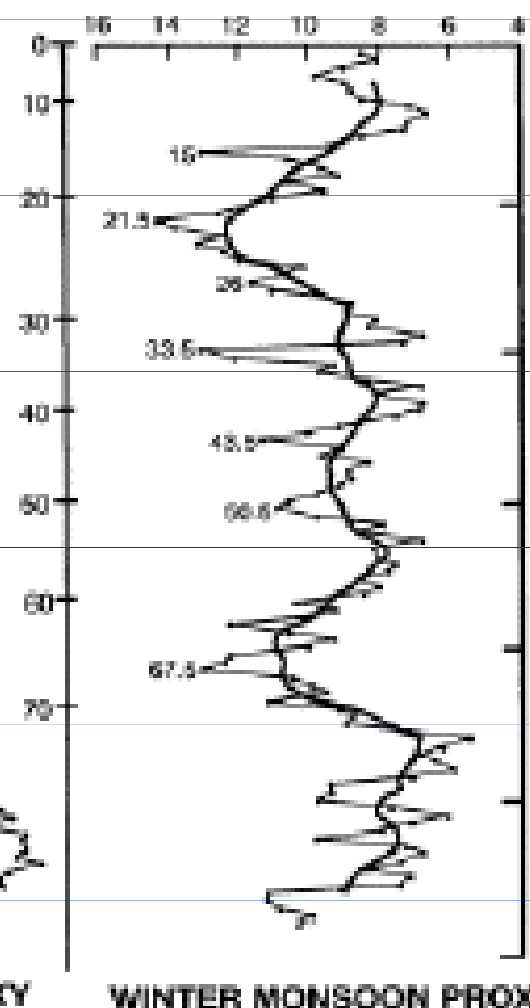

**NORTH ATLANTIC HEINRICH EVENTS (10<sup>3</sup>yr)**

- H1 — (15)
- H2 — (21)
- H3 — (27)
- H4 — (35.5)
- H5 — (50)
- H6 — (67)

SUMMER MONSOON PROXY

WINTER MONSOON PROXY

# Magnetická susceptibilita

- Spraš: relativně nízká MS
- Paleosol: relativně vysoká MS

## Příčiny

- Relative enrichment of magnetic minerals due carbonate leaching. (BUT it only accounts for a small increase).
- Diluting effect by influx of weak magnetic minerals. (BUT believed to be insignificant).
- Pedogenic formation of magnetic minerals.
- Variable sources of magnetic minerals.
- Ultra-fine magnetic particles produced from decomposition of vegetation. (BUT its significance is unknown).
- Frequent fires in loess. (BUT no evidence of frequent fires).

## Magnetic susceptibility of the Chinese loess

*warm, humid climate*

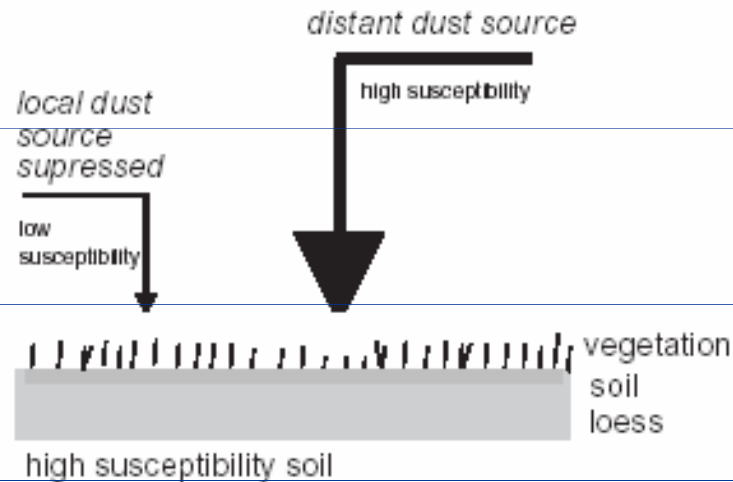

*cold, arid climate*

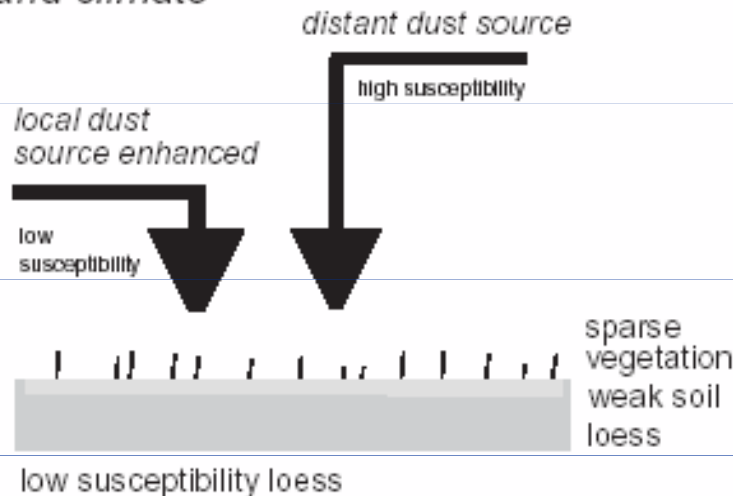

From information in Kukla (1988)

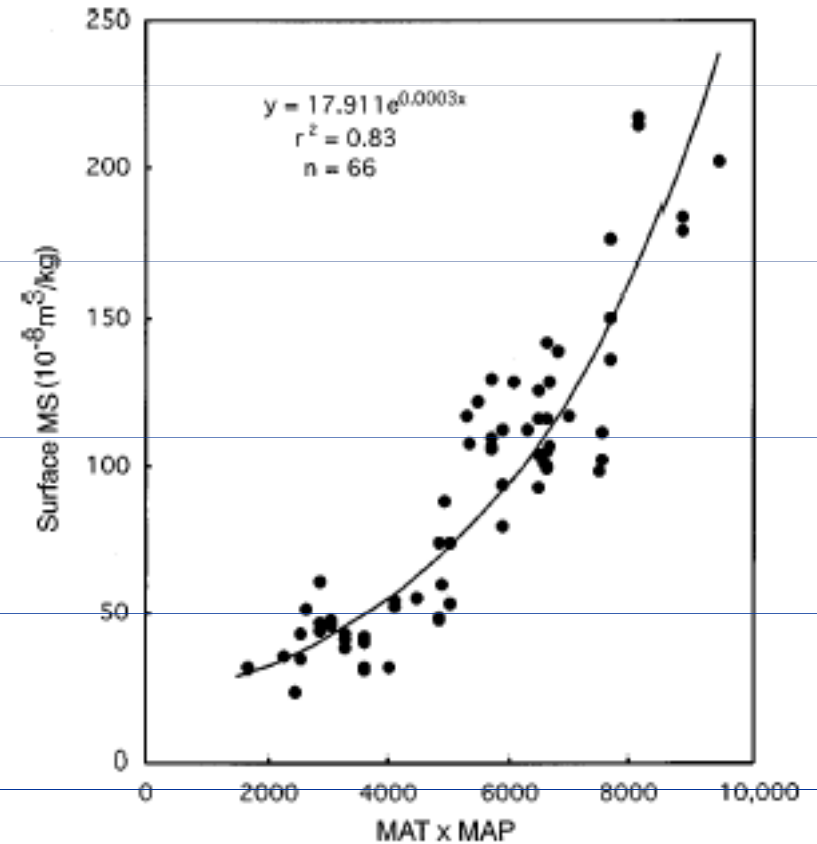

FIG. 8. Surface MS plotted as a function of MAT x MAP ( $^{\circ}\text{C mm}$ ).

Studies on modern soils show a positive relationship between magnetic susceptibility (MS) and mean annual temperature (MAT) and precipitation (MAP).

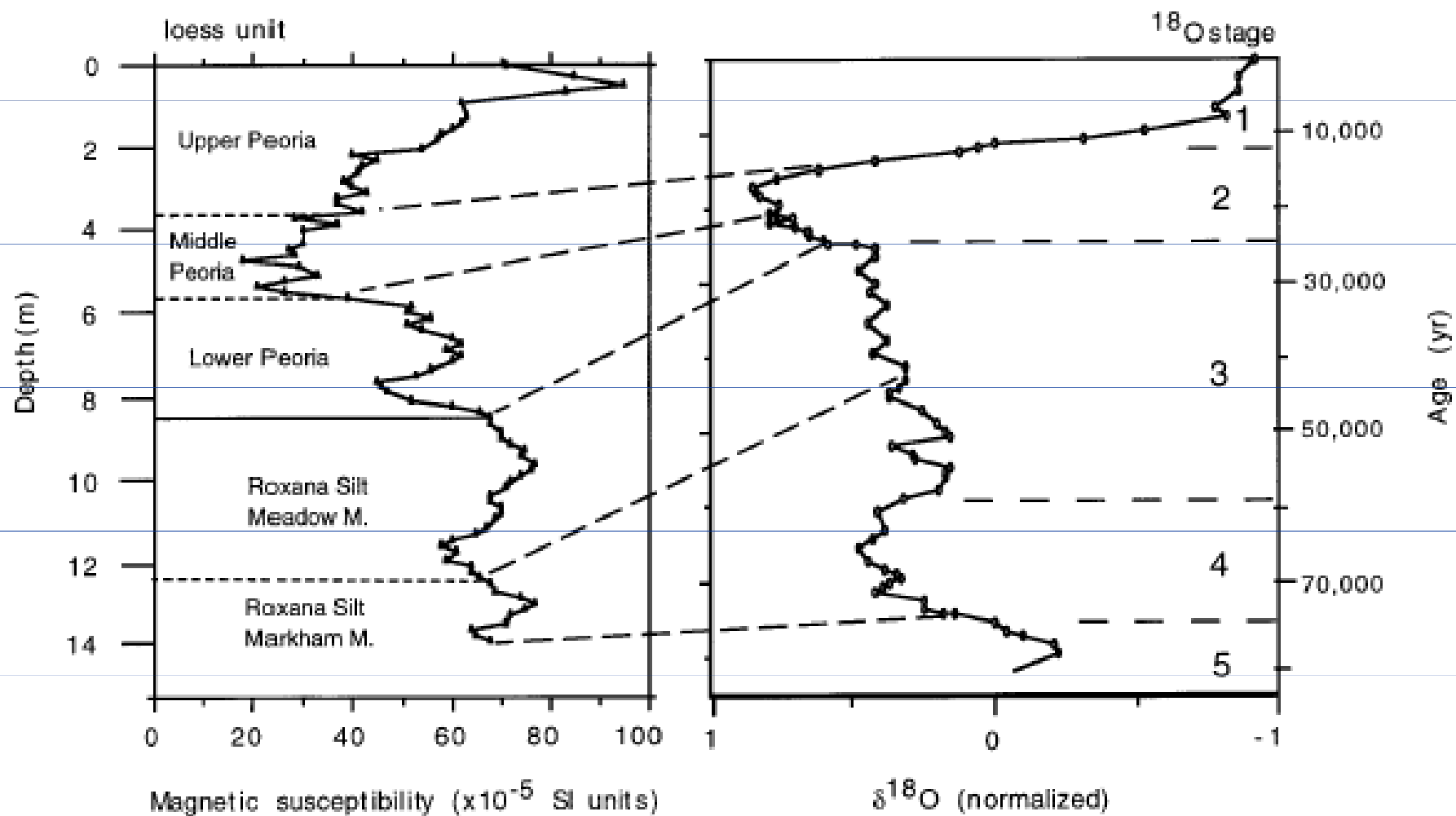

FIG. 7. Magnetic susceptibility from the G-56 core (left) and the oxygen isotope record from deep sea Indian Ocean sediments (right; from Martinson *et al.*, 1987). Correlations are based upon ages estimated from loess units (Fig. 6) in comparison with the high resolution orbitally tuned chronology devised by Martinson *et al.*, 1987.

# LAKUSTRINNÍ SEDIMENTY

# Jezerní systémy

*Otevřené systémy*

*Oligotrofní, dobře prokysličené*

• *Roční varvy*

• *turbidity*

*Uzavřené systémy:*

*Eutrofní, špatně prokysličené*

• *Organická hmota*

• *Evapority*

• *karbonáty*

## a "OPEN" LAKE SYSTEMS

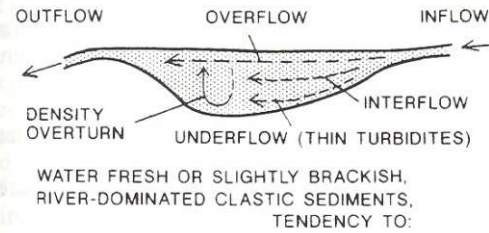

### a1 OLIGOTROPH

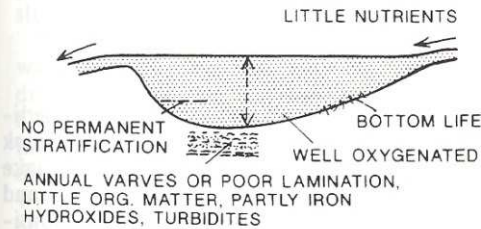

## b "CLOSED" LAKE SYSTEMS

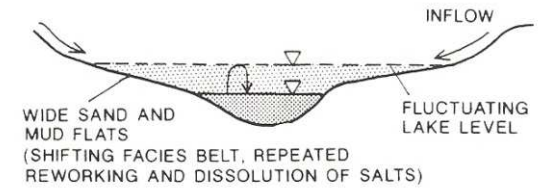

### b1 EUTROPH

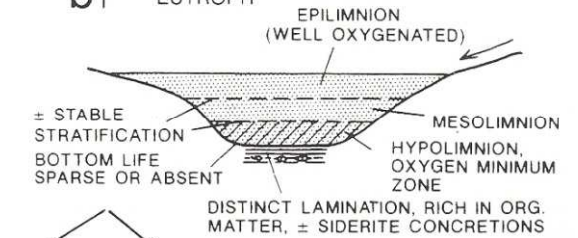

### b2 PERENNIAL LAKES

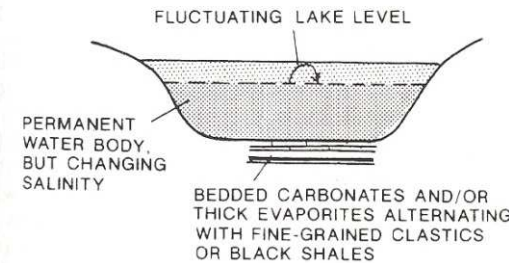

### b3 EPHEMERAL LAKES (PLAYA, INLAND SABKHA)

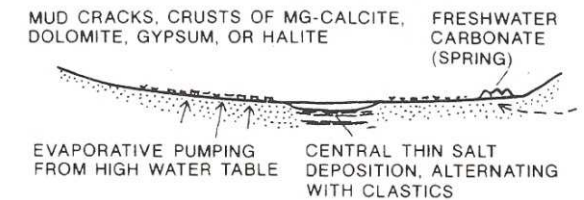

### b4 WATER TABLE BELOW LAKE FLOOR

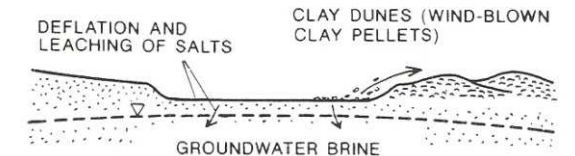

### a2 LAKE CHAIN (IN SEMIARID TO ARID REGION)

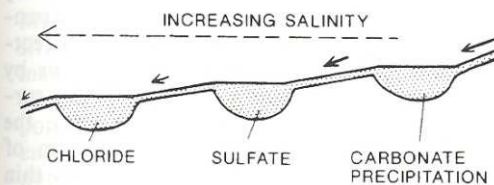

## C SEA-LAGOON-LAKE SYSTEM

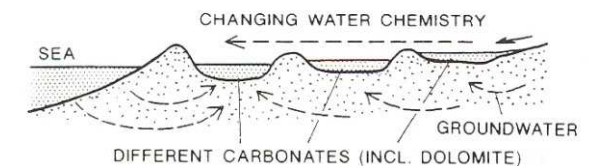

# Otevřený jezerní systém postglaciální výplň jezera

Lake Sediments

83

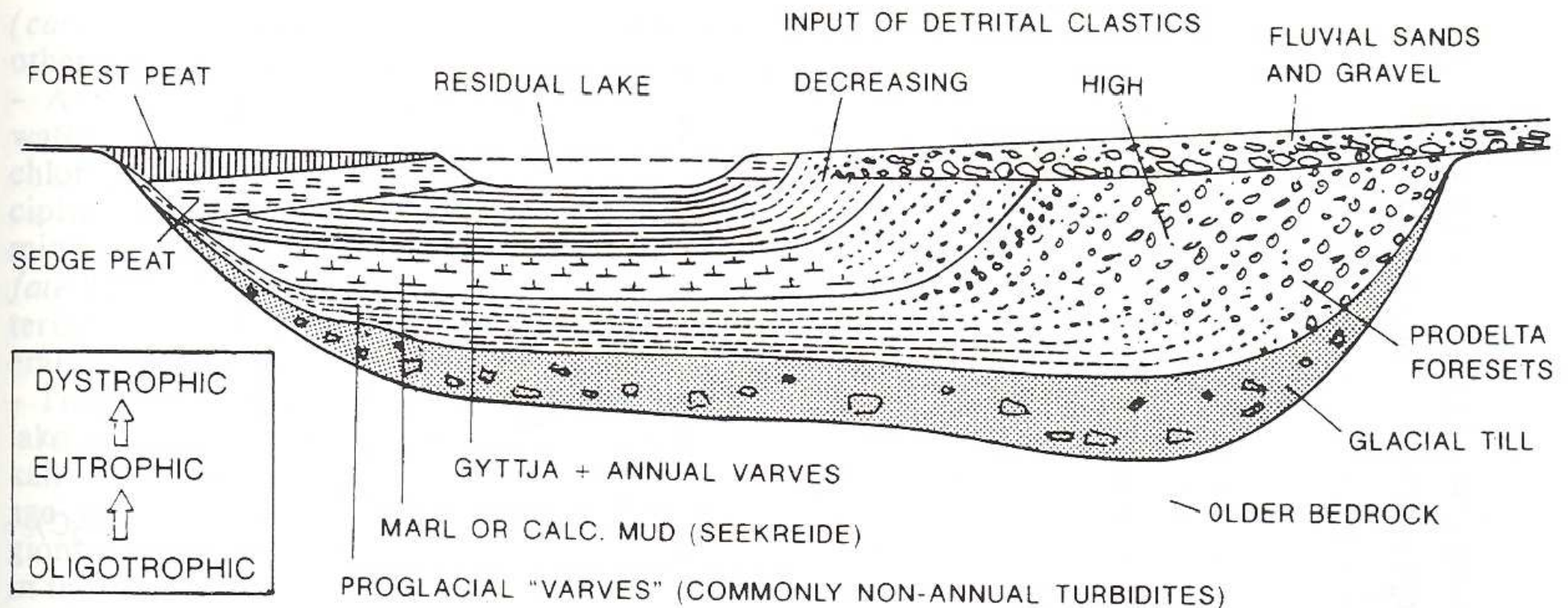
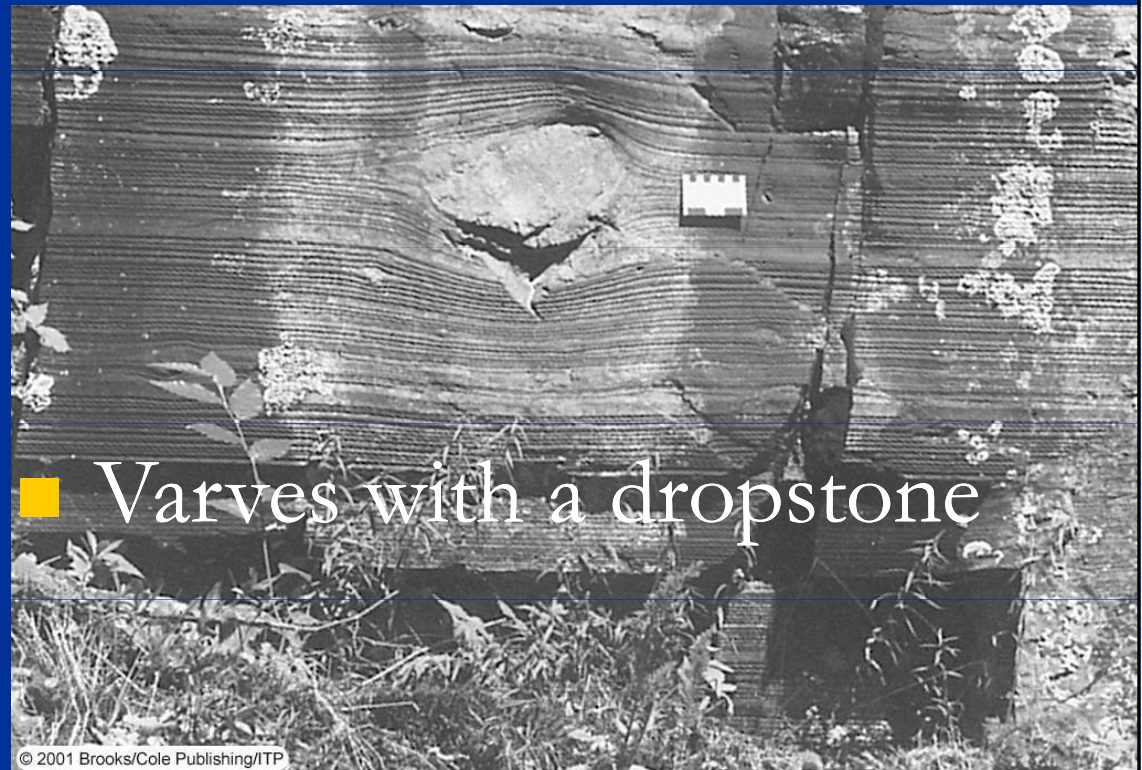

Fig. 2.29. Generalized scheme of the post-glacial sediment fill of a glacier-shaped lake. (After Dean 1981). It is assumed that the input of detrital clastics decreases with time and finally ends



# Varvy

- The light-colored layer of silt and clay
  - formed during the spring and summer
  - and the dark layer made up of smaller particles
  - and organic matter formed during the winter
  - when the lake froze over
- Varved deposits
  - may also contain
  - gravel-sized particles,
  - known as dropstones,
  - released from melting ice



# STOKESŮV ZÁKON

$$u = \frac{1}{18} \frac{\rho_s - \rho_f}{\eta} g D^2$$

$u$  = rychlost usazování

$\rho_s$  = hustota pevné částice

$\rho_f$  = hustota kapaliny

$g$  = gravitační zrychlení

$D$  = průměr částice

$\eta$  = kinematická viskozita

Zrnitostní frakce: silt – jíł

Silt klesá ke dnu rychleji

Jíł klesá ke dnu pomaleji

# OTHER NUMERICAL DATING TECHNIQUES

## VARVE CHRONOLOGY



# RTG densitometrie varvitũ

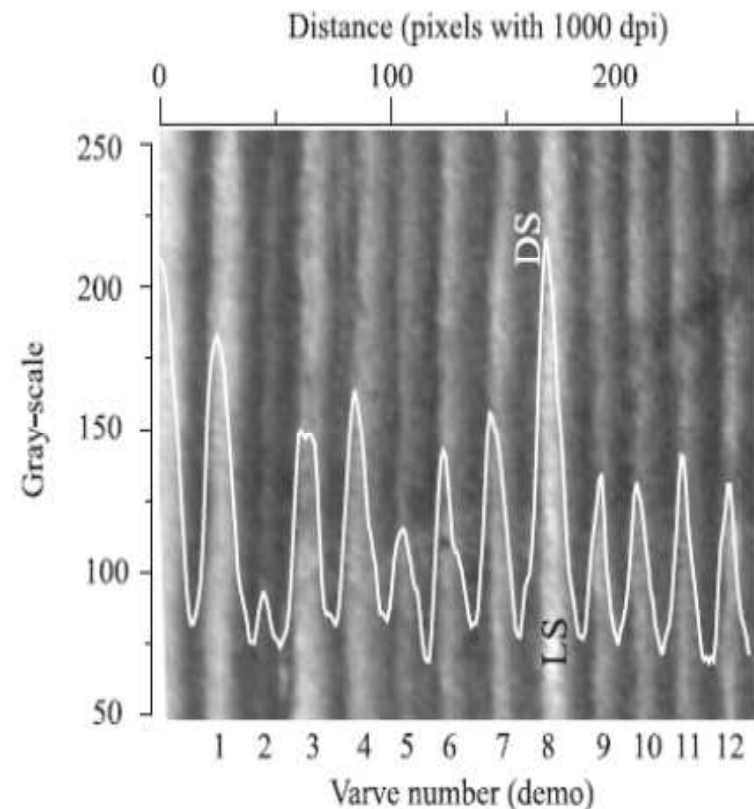
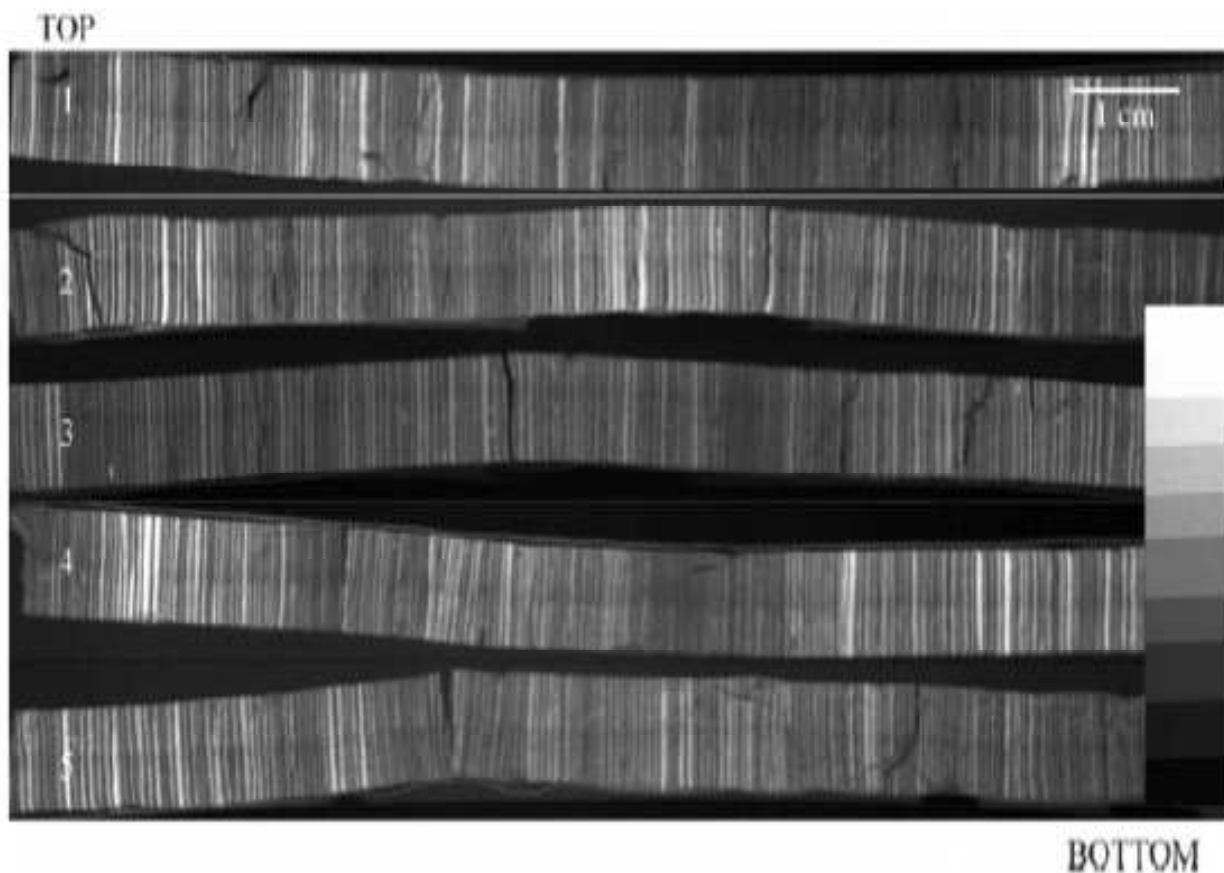
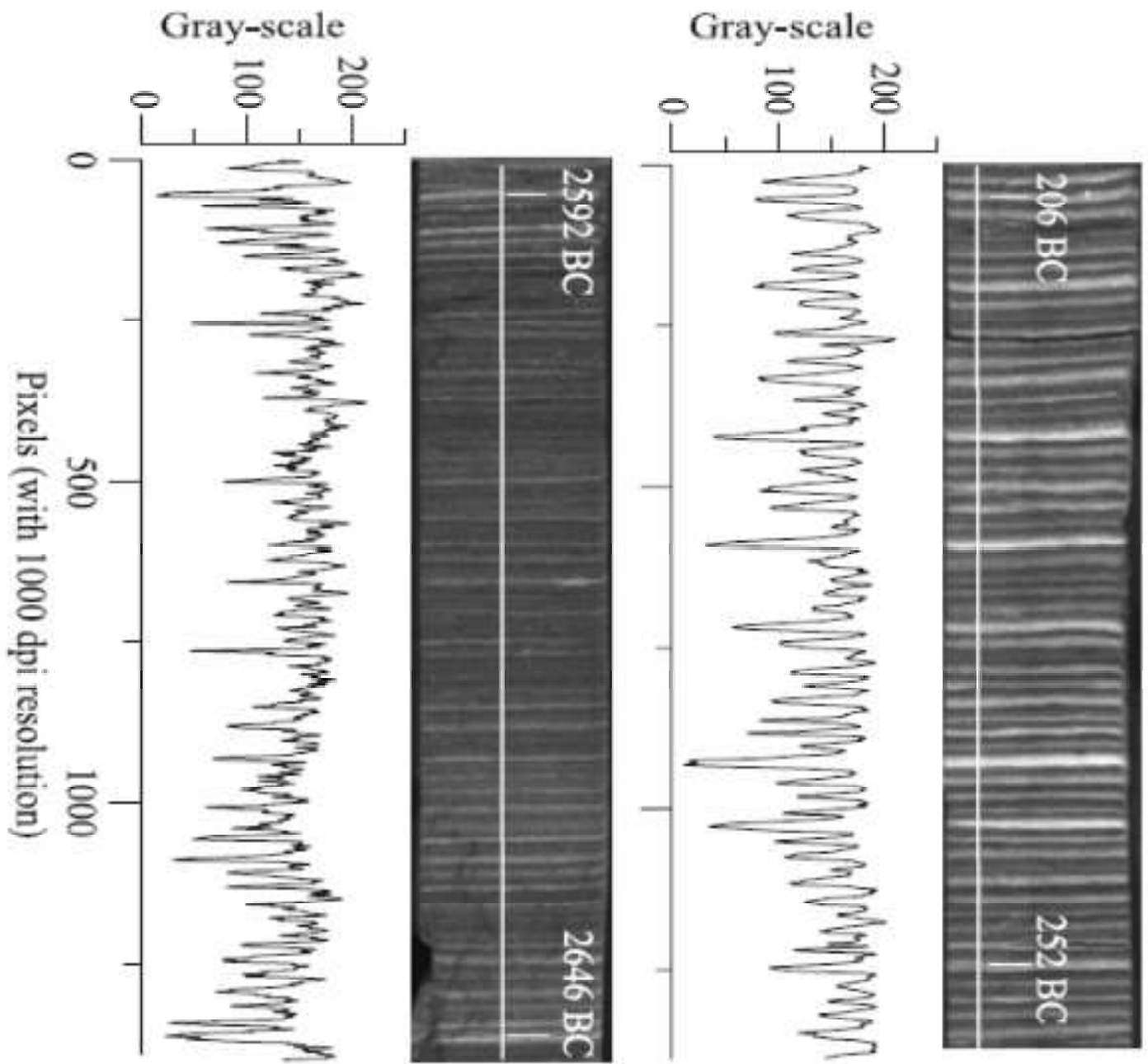

Figure 3. X-ray images of clastic-organic varves from Lake Nautajärvi representing the period from ca. AD 200 to 600 BC. Radiographs are taken from epoxy-embedded slabs of uniform 2-mm thickness. A calibration sample made of glass is seen in the right-hand corner.



*Figure 5.* Two X-ray radiographs from 206 to 252 BC and 2592 to 2646 BC of Lake Nautajärvi sediment show that the visually striking components, mineral-rich and organic laminae, are far from perfect throughout the sequence for studies of automated line-scan image analysis. Therefore, it is also necessary to estimate the error in the varve chronology.

# Chronologie varvitù

- Deglaciation in Scandinavia
  - Based primarily on varve chronologies.

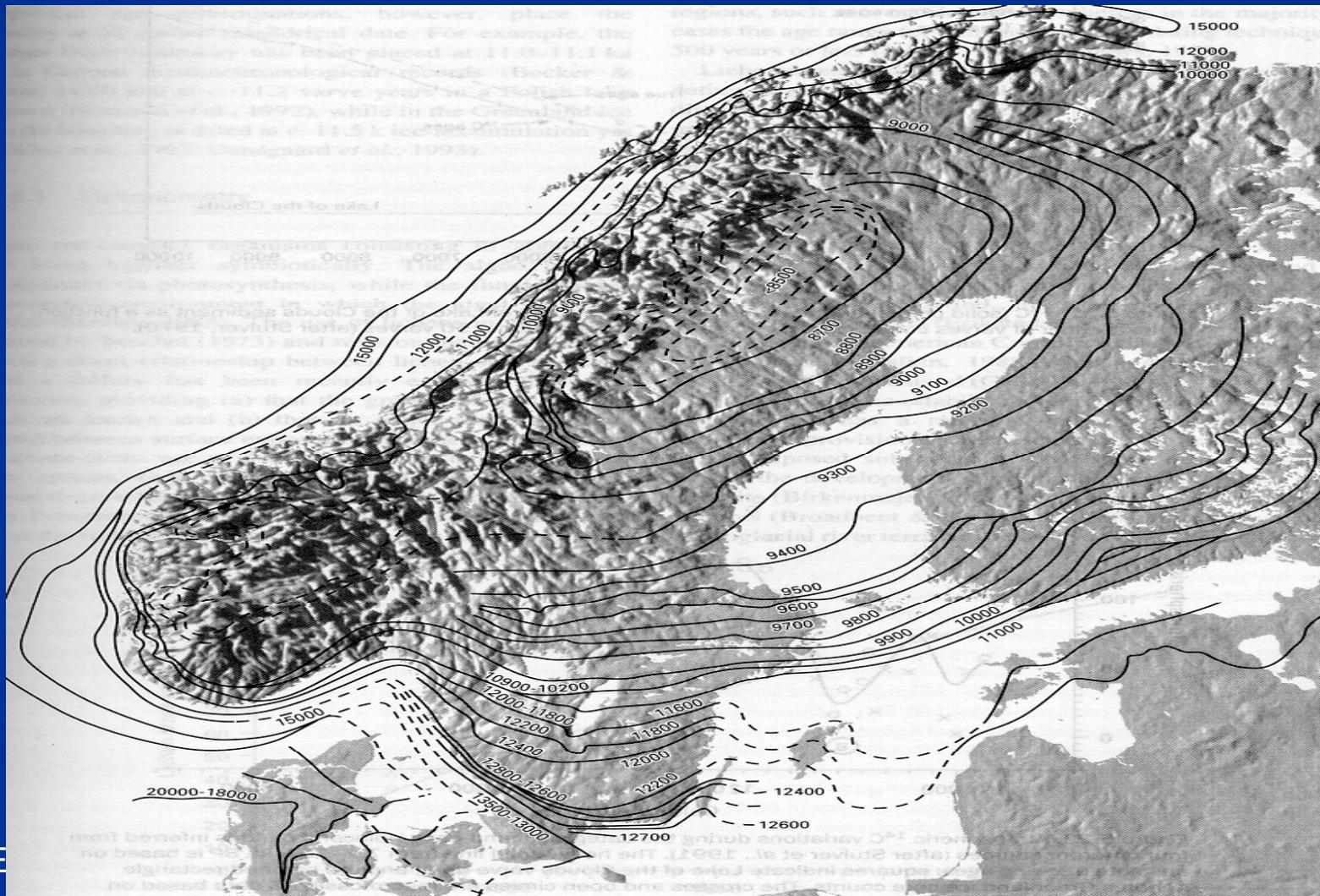



Tree Rings



Varves



Speleothems

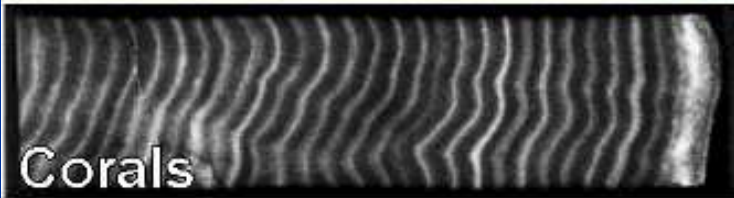

Corals



Ice Cores

PAGES Newsletter 11: 2-3, 2003

# Varvy a “varvovité“ sedimenty

- Více „varvů“ za jednu sezónu : ???
- Hustotní proudy !

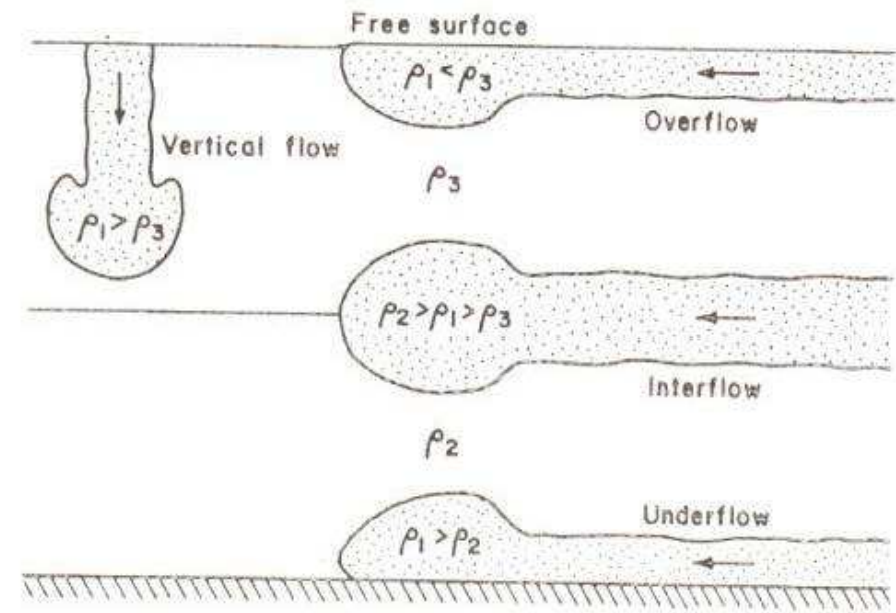

Fig. 1-25. Principal types of gravity current.



# Hyperpyknické proudy

hlava – tělo – ocas

Rychlost šíření hyperpyknického proudu

$$U_h = k \left| \frac{(\rho_1 - \rho_2)g}{\rho_2} h_2 \right|^{1/2}$$

Rychlost nezávislá na velikosti zrna

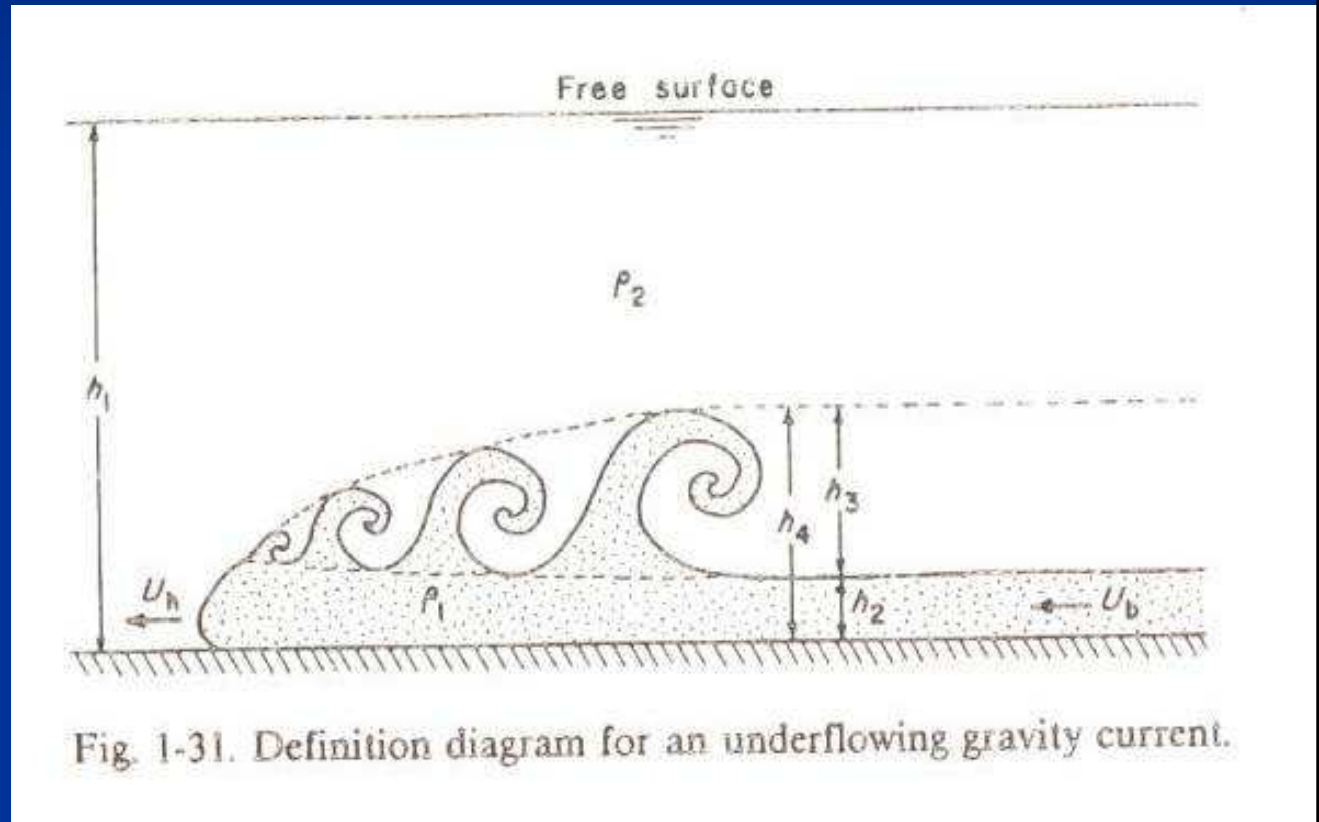

Fig. 1-31. Definition diagram for an underflowing gravity current.

- Turbidity: Jezera, která nezamrzají
- Varvity: jezera, která periodicky zamrzají, klimatický indikátor

# Brněnská přehrada

Jezerní  
(přehradní)  
sedimentace

Svahová  
sedimentace

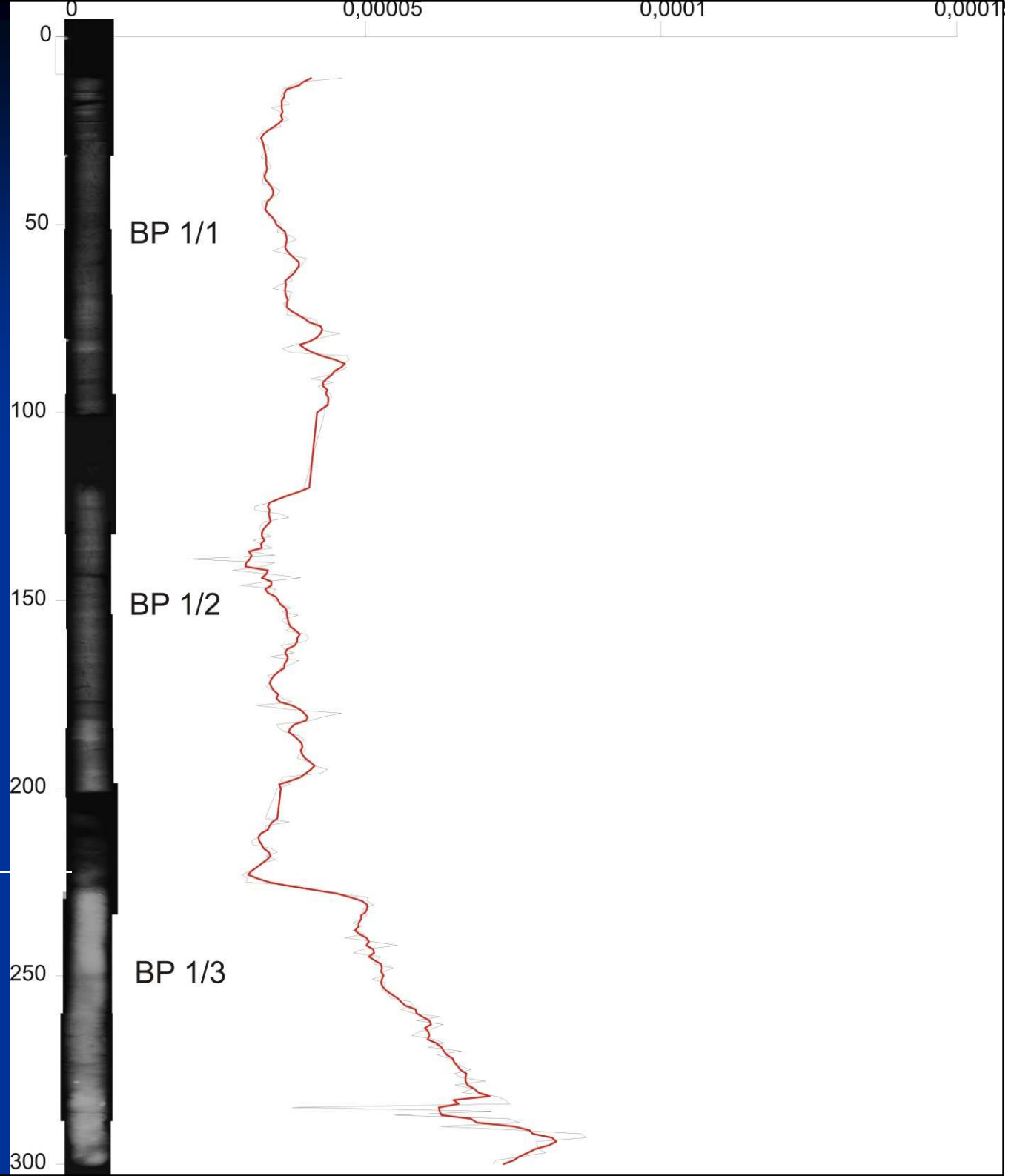

# Mrtvé rameno Čert'ák (U. Hradiště) povodňové vrstvy v sedimentech jezera

Čca 80 metrů podélně s průběhem mrtvého ramene

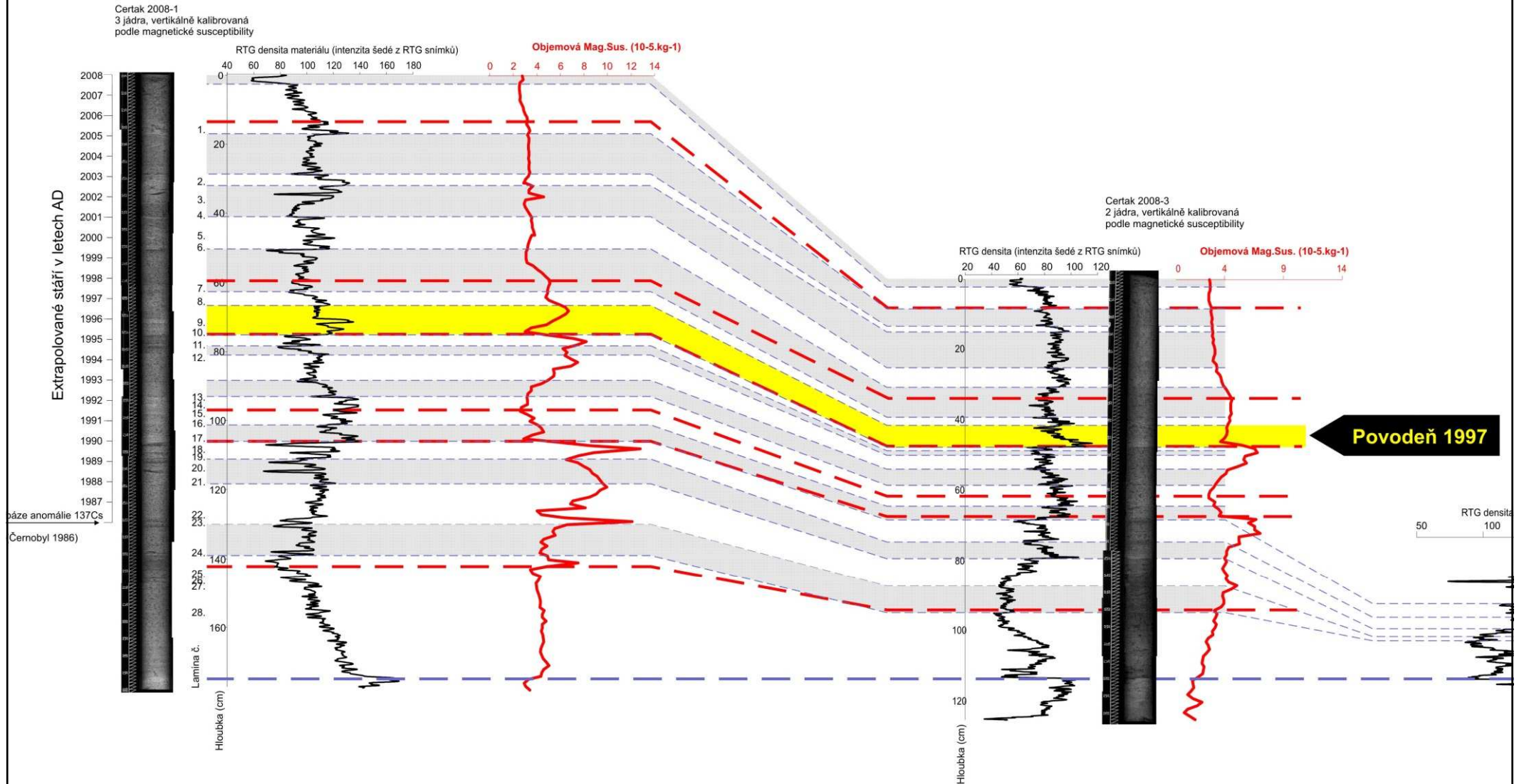

# Korelace jezerních sedimentů se sprašemi jezero Bajkal, klimatické archívy

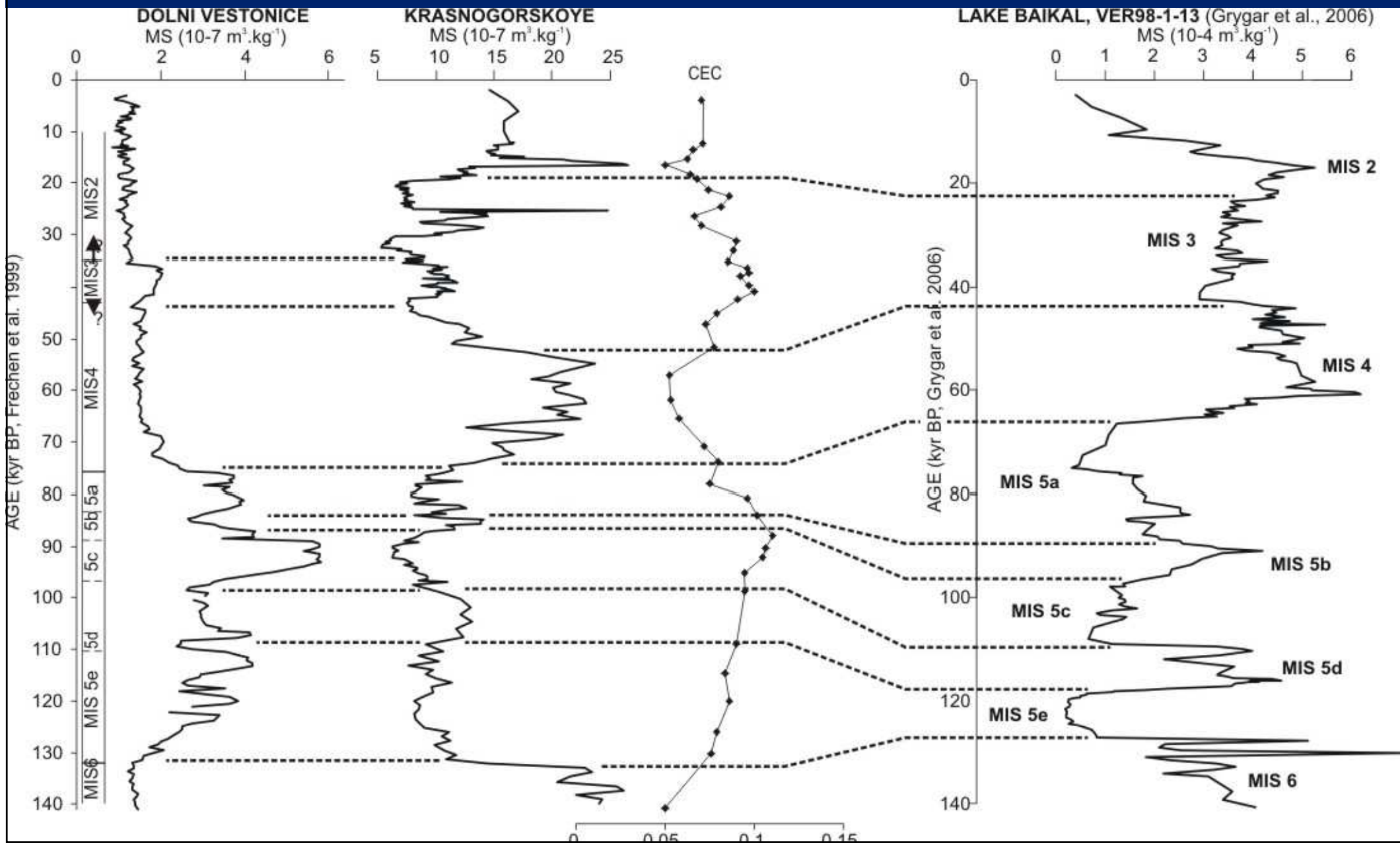

# FLUVIÁLNÍ SEDIMENTY



# SPÁDOVÁ KŘIVKA

A stream in balance with its surroundings is called a **graded stream**. Such a stream balances erosion, sediment transport, and sediment deposition along its length, and has a smooth concave-upward profile from beginning to end. Examples of two graded streams are shown below.

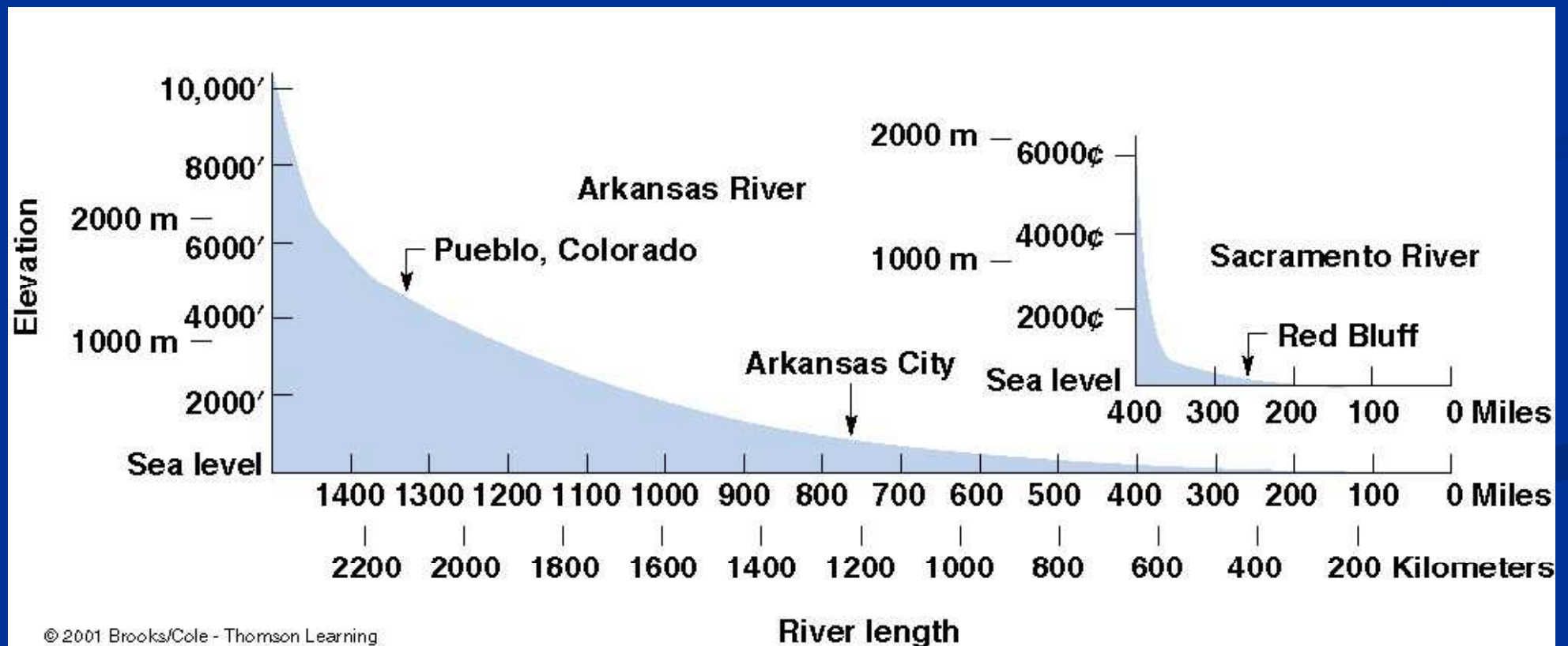

# FLUVIÁLNI EROZE

**Erosion** by streams has shaped the land surface worldwide over geologic time. This spectacular gorge in Colorado is entirely a product of stream erosion acting over several millions of years.

The ability of a stream to erode relates to two things:

1. **Velocity** -- the speed of the water, generally measured in feet per second.
2. **Discharge** (průtok) - the total amount (volume) of water carried by the stream. Discharge is generally measured in cubic feet per second, or cfs.









## PRŮTOK vs. NASYCENÍ SEDIMENTEM

This graph shows the connection between discharge and the amount of sediment a stream can carry (sediment derived from erosion of the stream's banks and channels).

A 10x increase in discharge corresponds to a nearly 100x increase in erosion and sediment load carried.

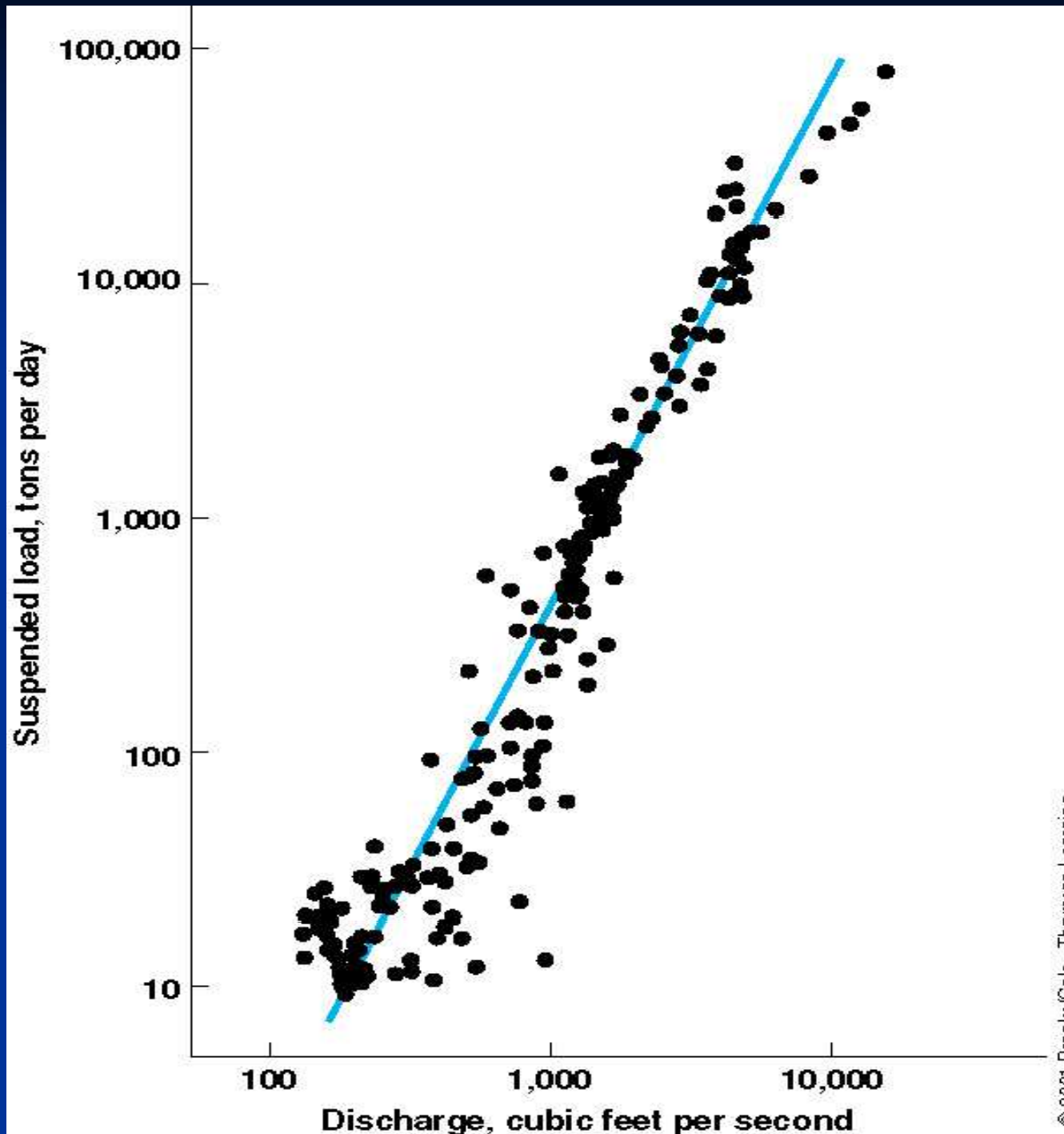

# ŘÍČNÍ SYSTÉMY PODLE SPÁDU

- Aluviální systémy
- Divočící řeky
- Meandrující řeky
- Říční delty

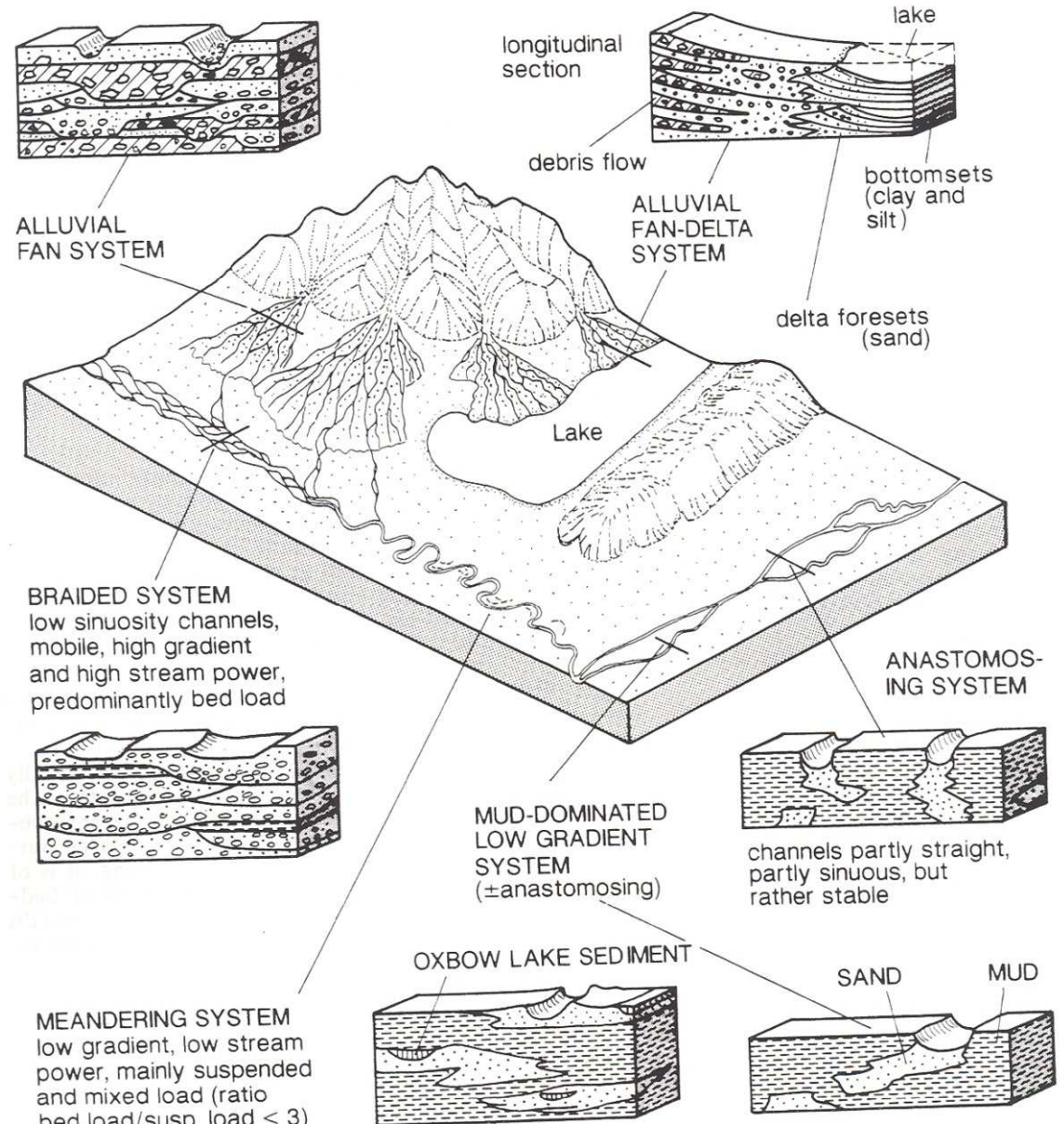
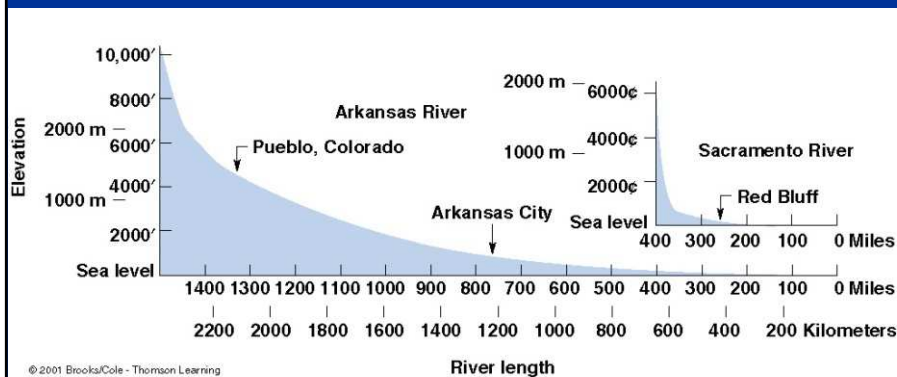

Fig. 2.8. Principal types of fluvial systems and generalized characteristics of their cross sections (vertical scale exaggerated)

In arid areas, like in the desert mountains next to Death Valley, CA in this photo, streams flow only intermittently after heavy rain storms. After heavy rains, water charges down the canyons as **flash floods**, carrying large amounts of sediment as **debris flows** (recall Chapter 7: Mass Wasting). As the debris flows slow down, this sediment is deposited to form **alluvial fans** -- broad sloping sheets of coarse sediment at the mouths of mountain canyons.



This air photo of the Missouri River beautifully shows the main **meandering channel** and the adjacent **floodplain** (the band of darker land along the channel).

Farms and fields produce the patchy appearance of the floodplain here. The fertile soil of floodplains is intensively farmed throughout the world. Intensive human use of floodplains is one of the problems we will consider later in this lesson.

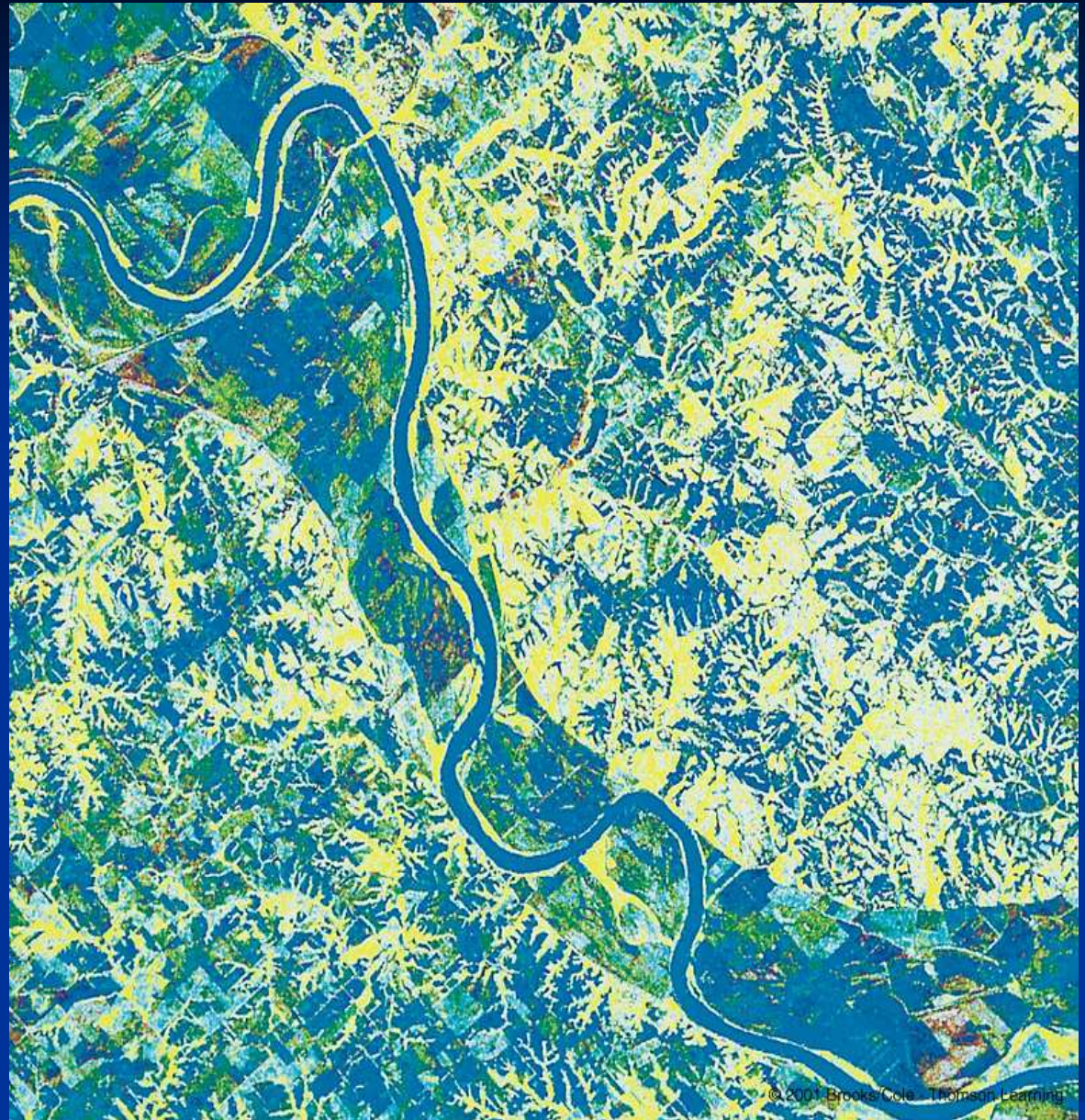

Sediment particles of many types and sizes are transported by streams.

**Deltas** are deposits of stream sediment that form where streams end at standing bodies of water, like oceans or lakes.

The Mississippi River Delta shown here is an example.

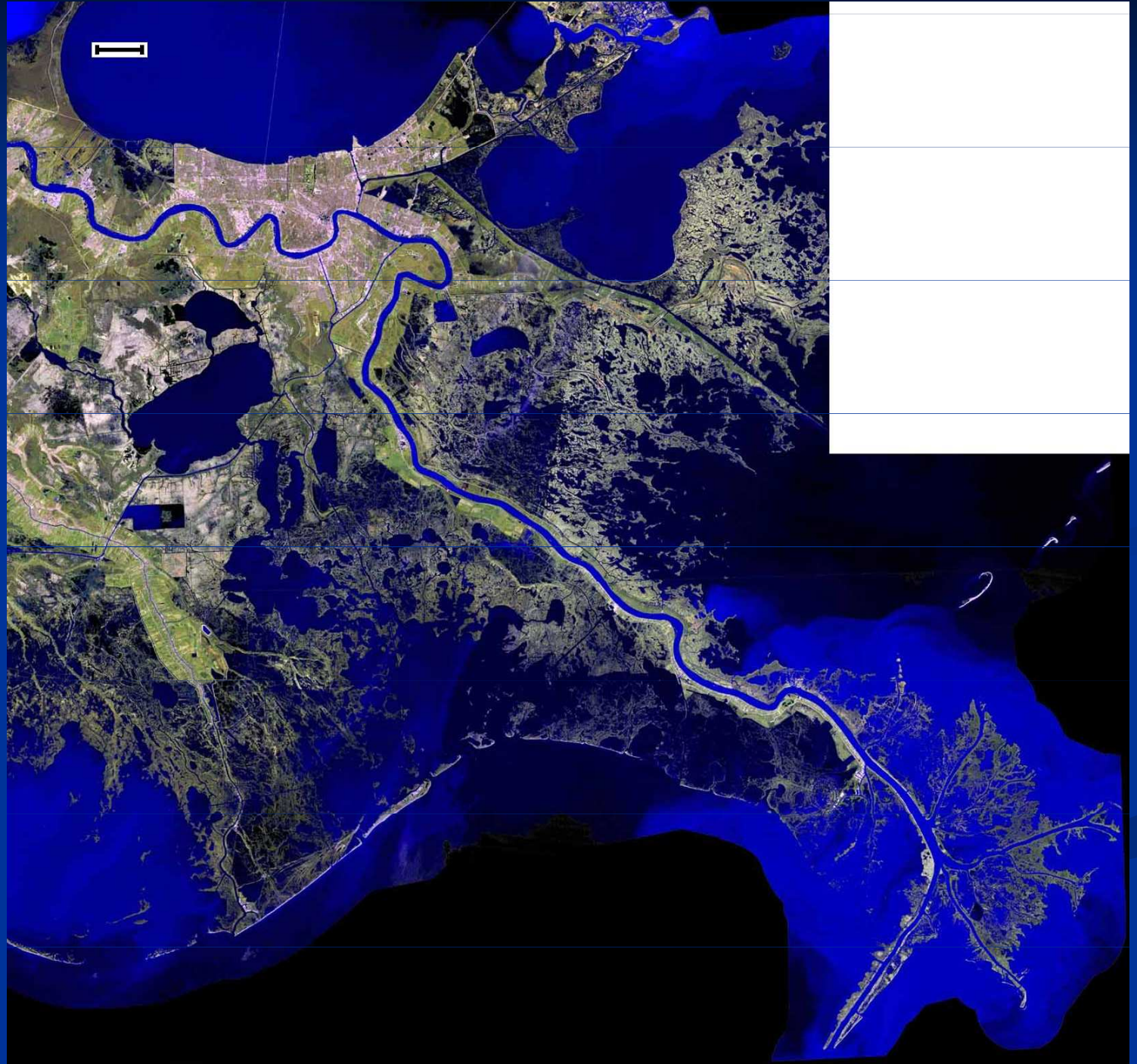

# Fluviální eroze vs. sedimentace: estuarinní systémy → deltové systémy

## ■ Mekong River

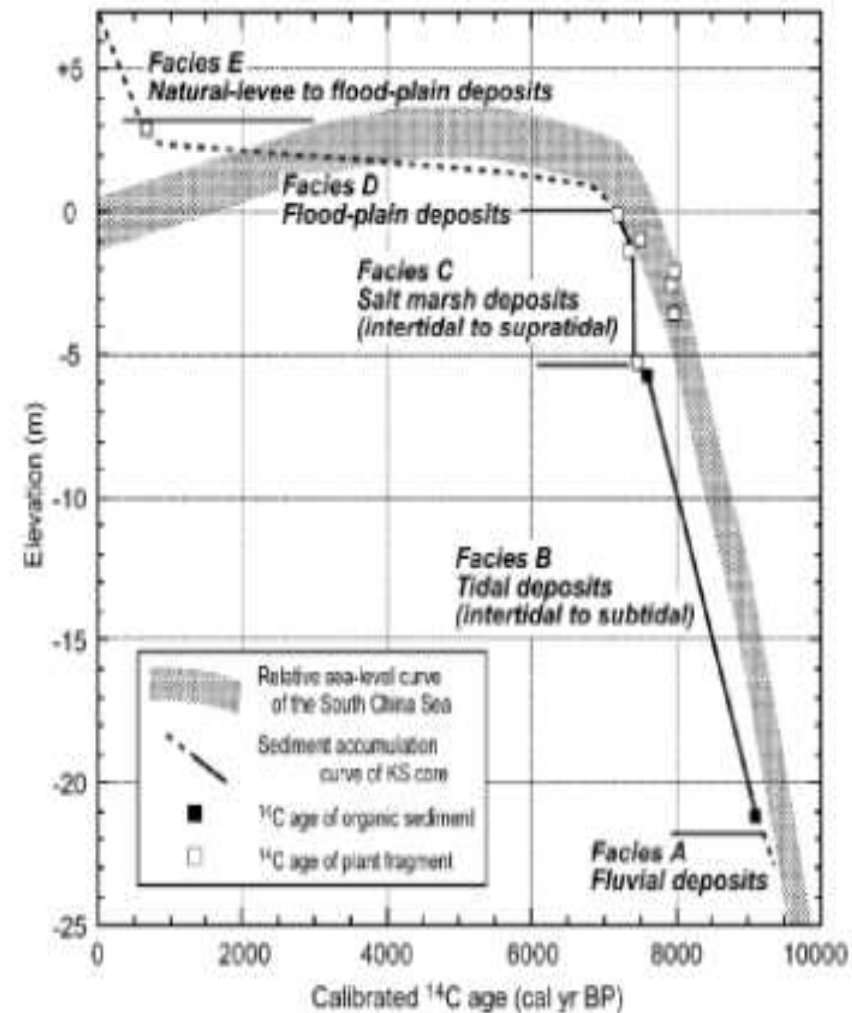
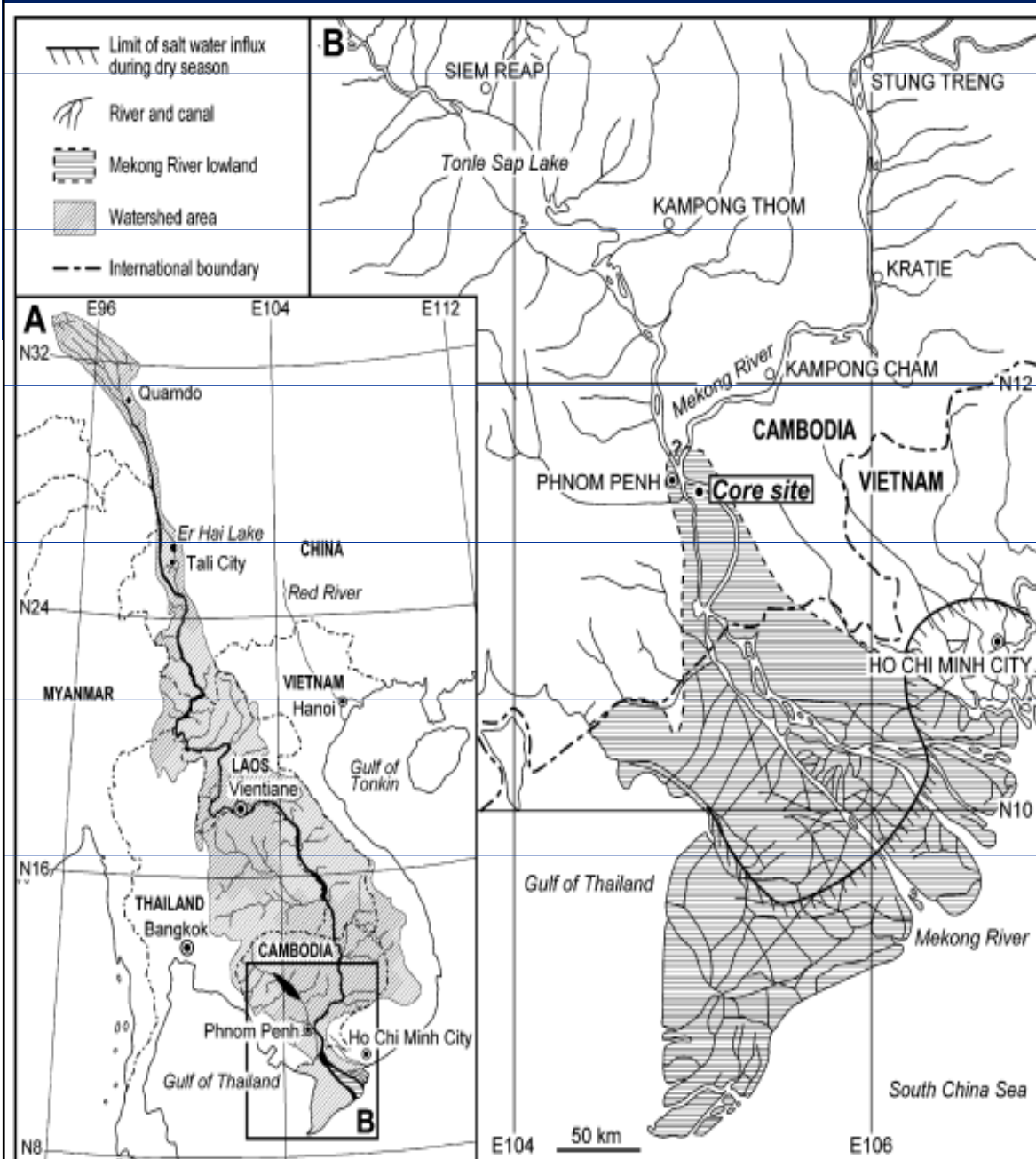

# Hydrodynamika rozhraní kapalina – nesoudržný sediment Jednosměrné proudění

- **Unidirectional flow** leads predominantly to asymmetric bedforms (two- or three-dimensional) or plane beds
  - Current ripples
  - Dunes
  - Plane beds
  - Antidunes



## 1. Erosion in the trough of a bedform

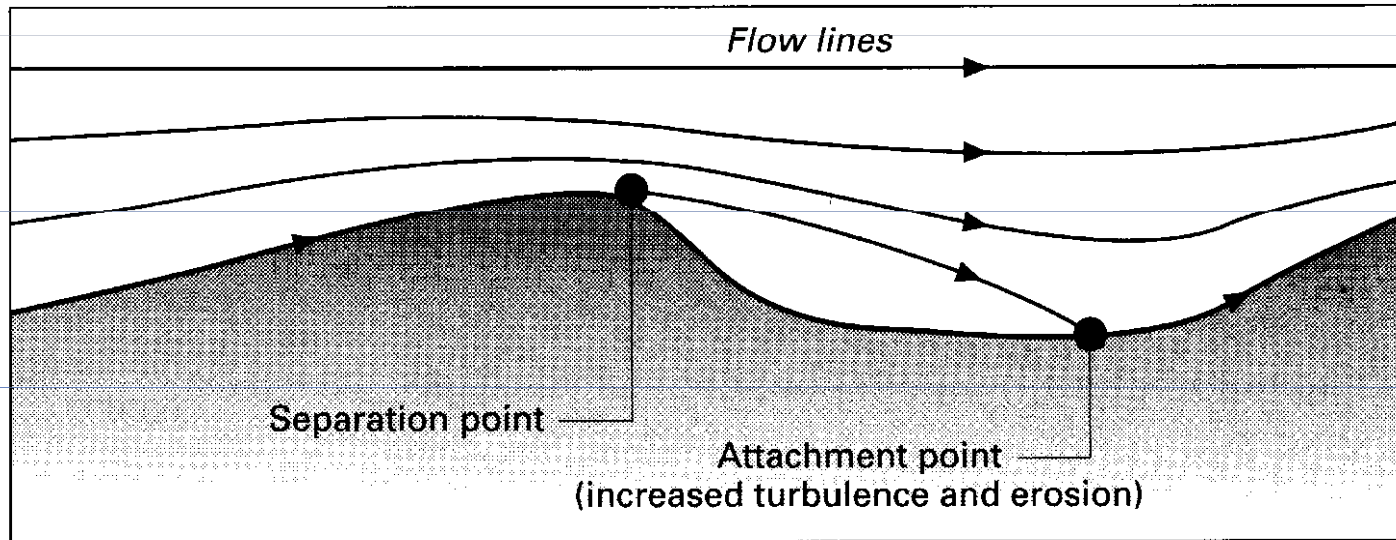

## 2. Development of counter-currents in lee of bedform

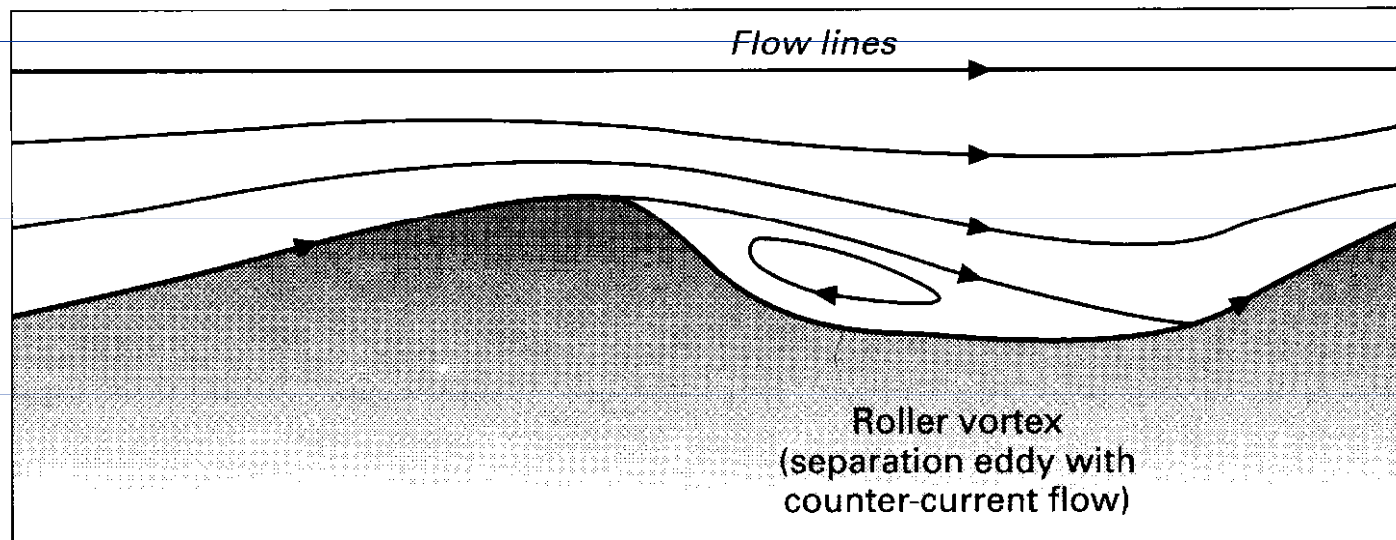

→ *Flow direction*

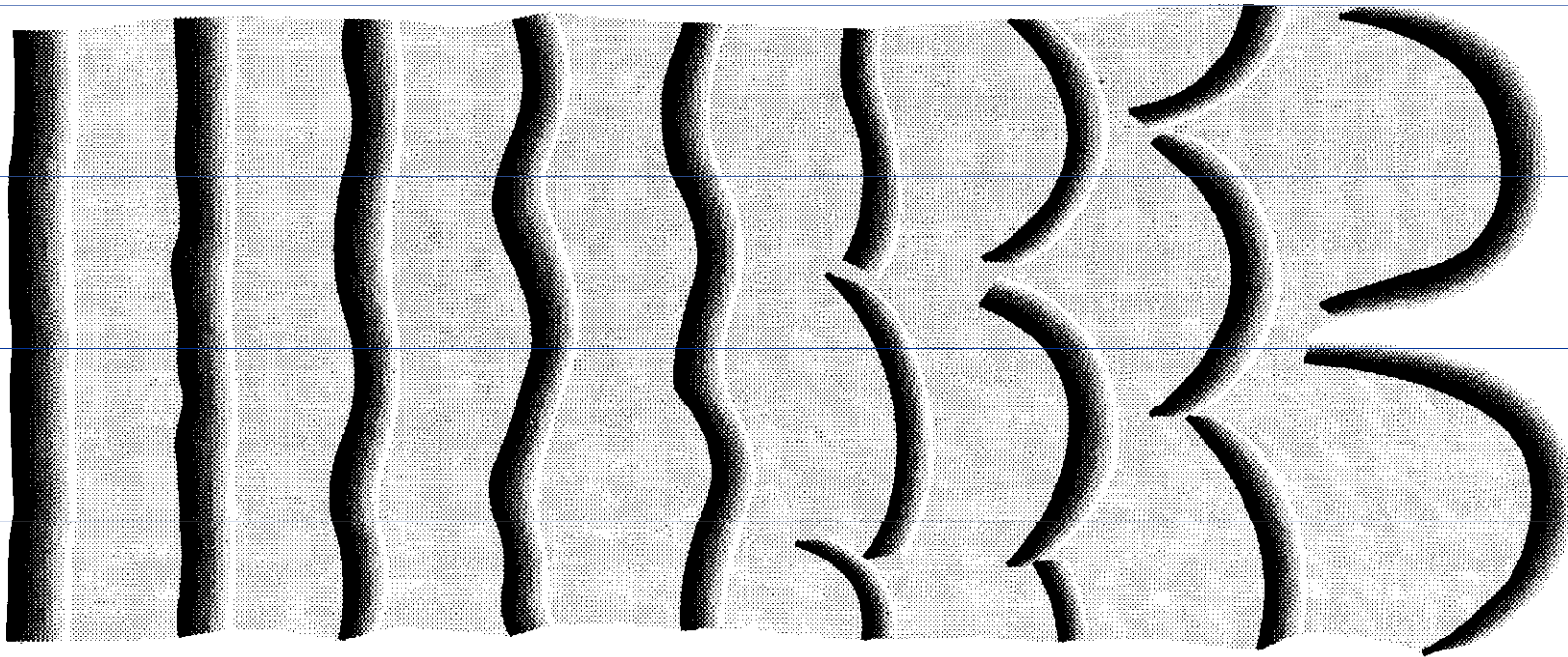

————— Straight ————— Sinuous ————— Isolated (linguoid) —————





**Animation**



# Antiduny

- Jednosměrné vodní proudění s volným povrchem – ve fázi s povrchovým prouděním kapaliny
- Stacionární (nemigrují) nebo migrují proti směru proudění
- Sedimentace na návětrné straně, eroze na závětrné straně
- $L \leq 10m$

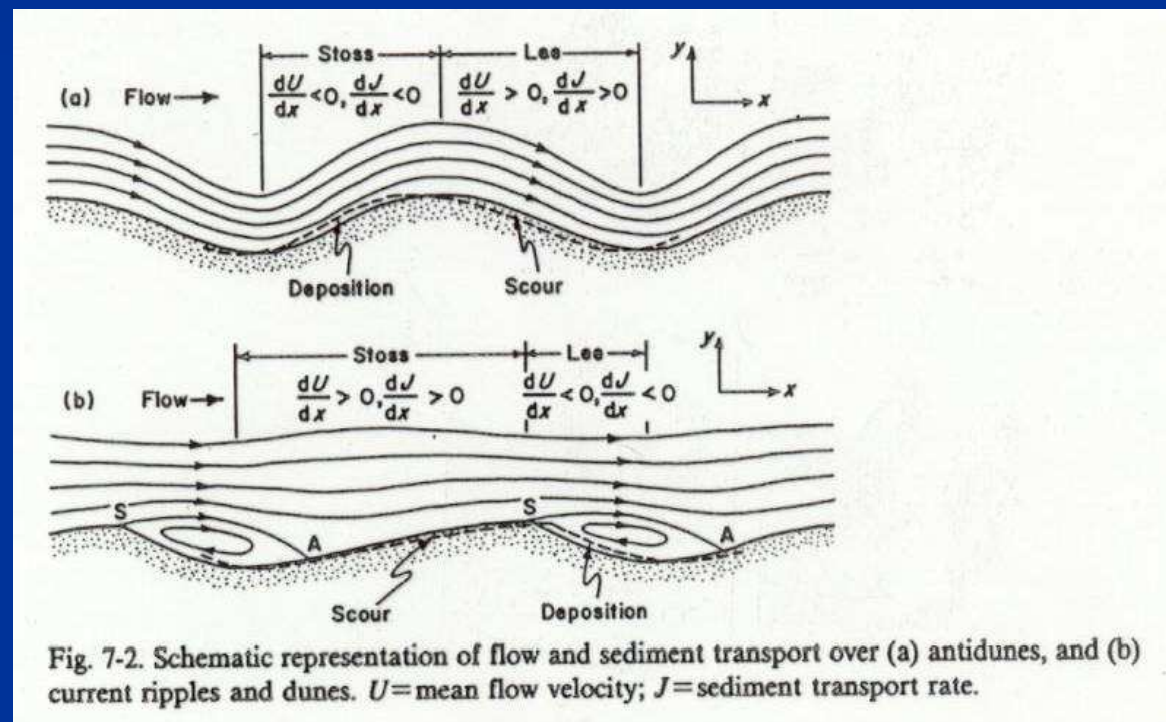

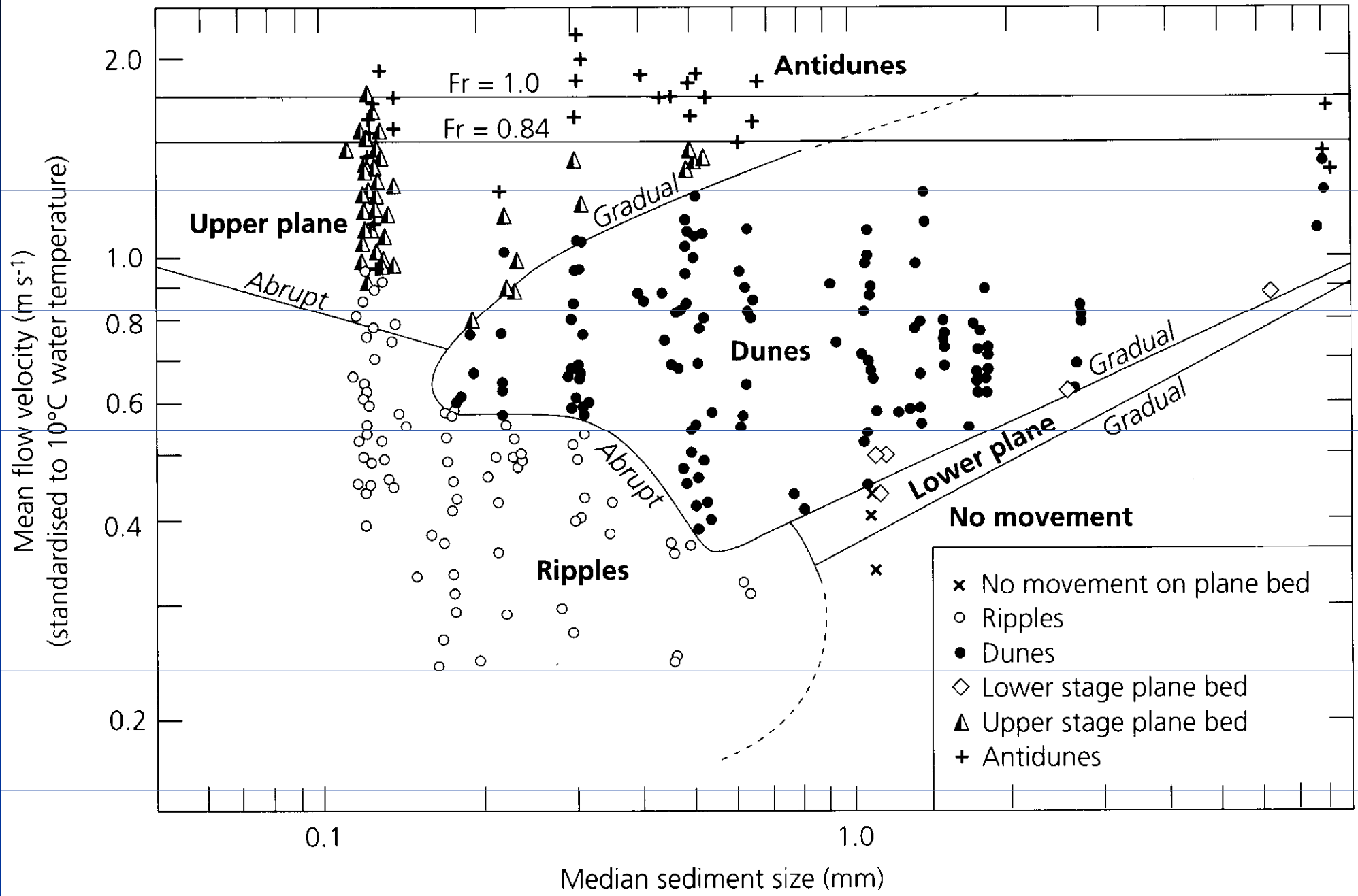

# Oscilační proudění

- **Oscillatory flow** due to waves causes predominantly symmetric bedforms (wave ripples)

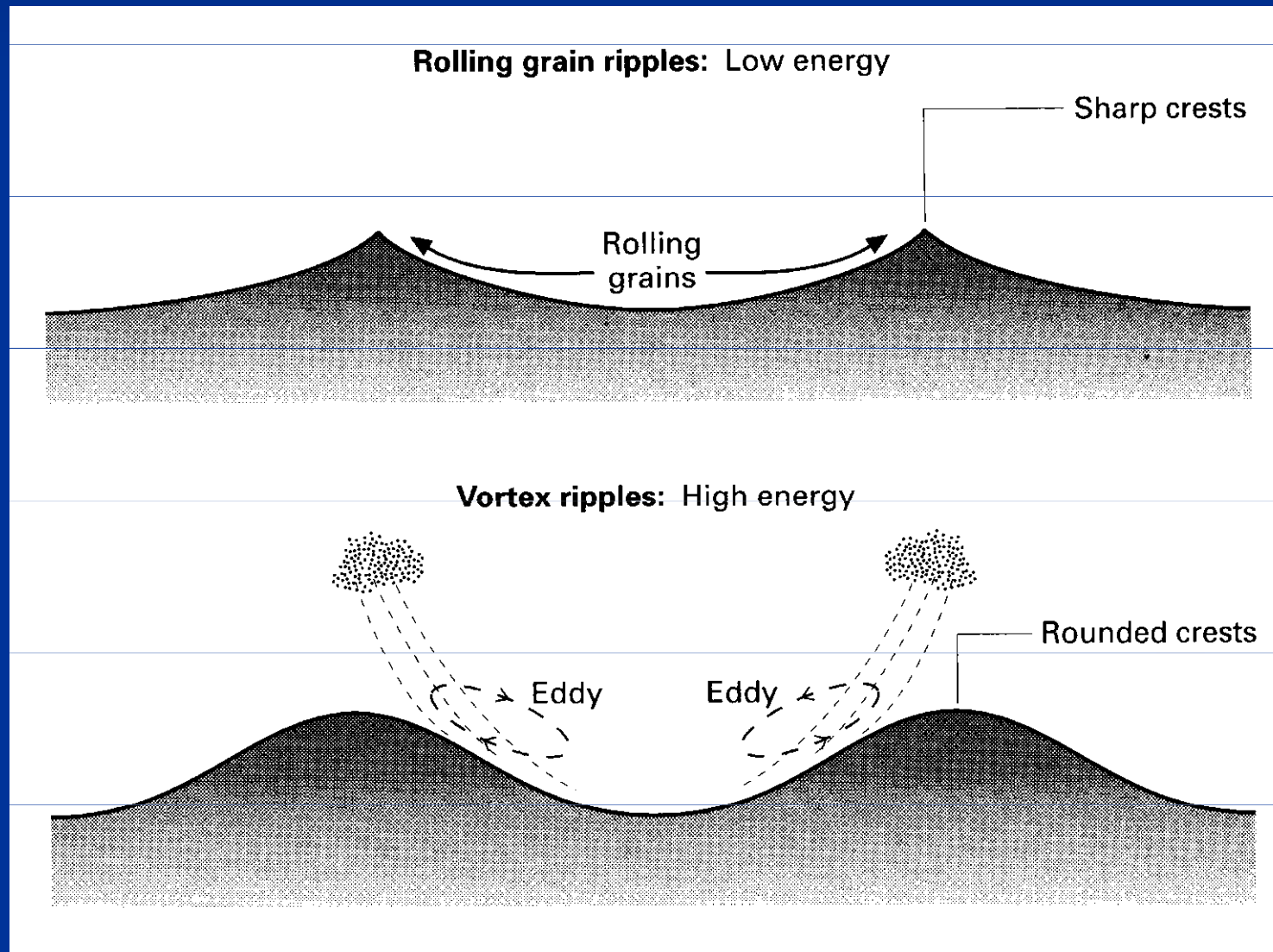





# Rychlost proudění vs. velikost zrna

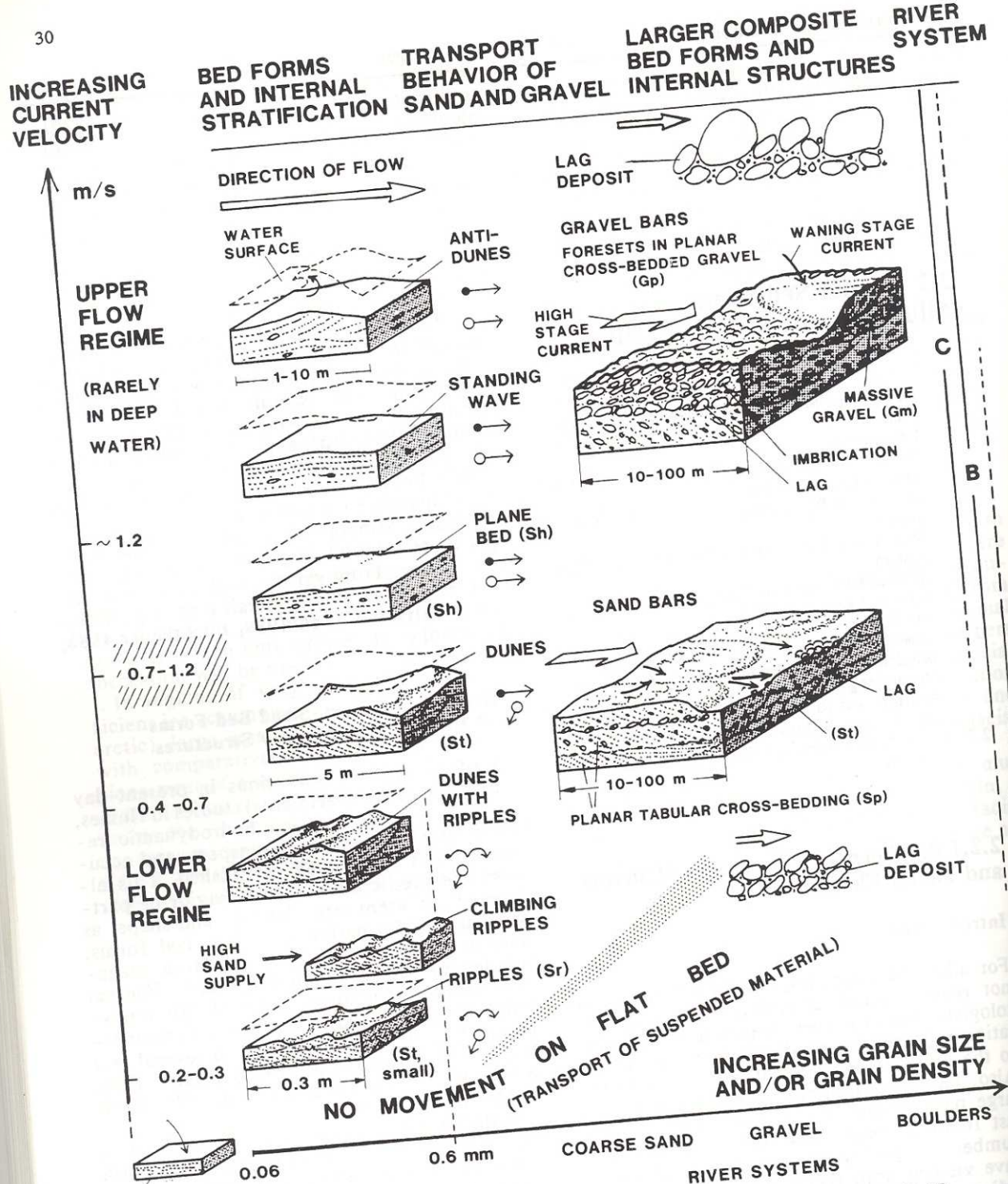

# Textury: Planární šikmé zvrstvení

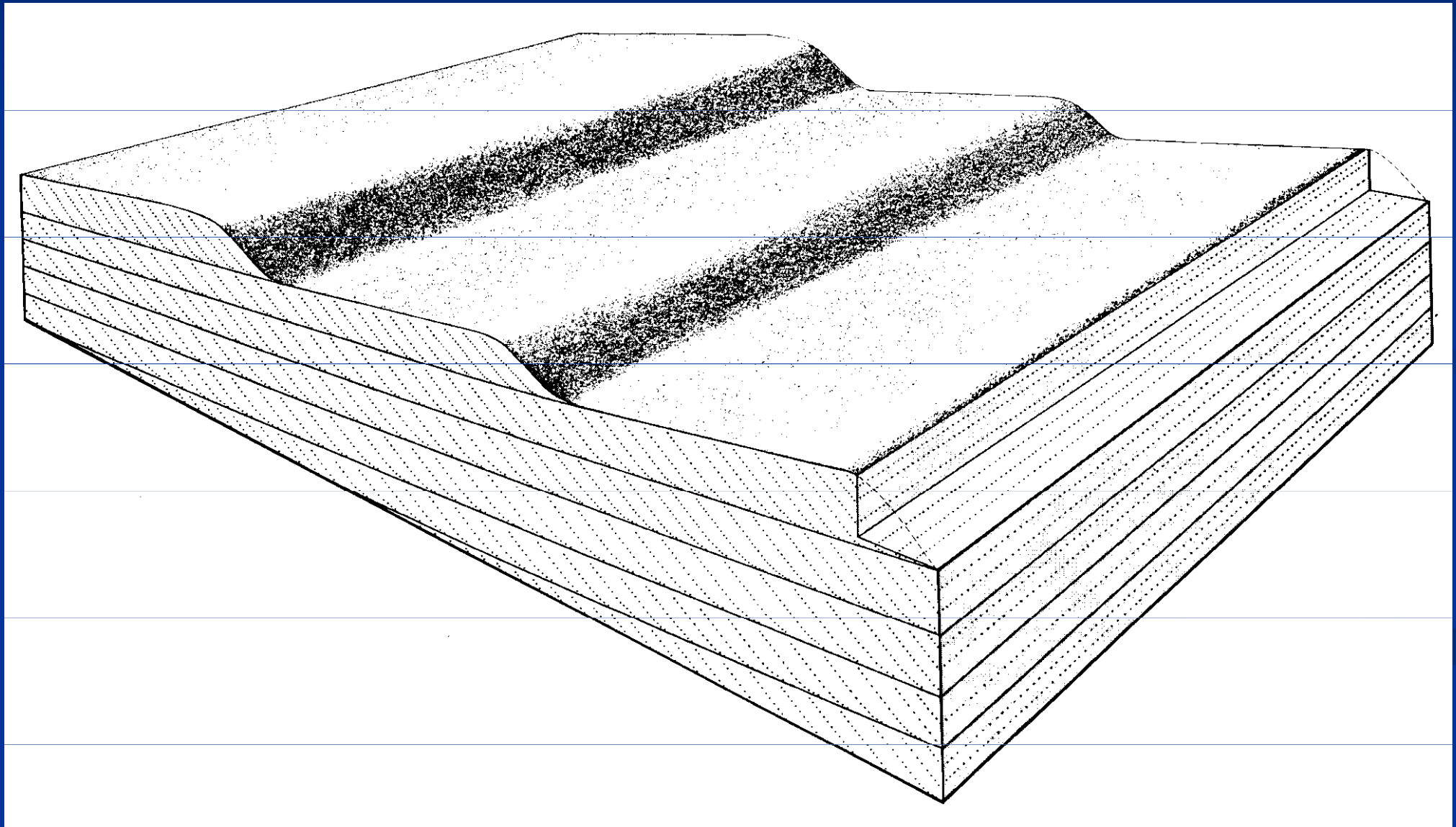

# Textury: Výmolové šikmé zvrstvení

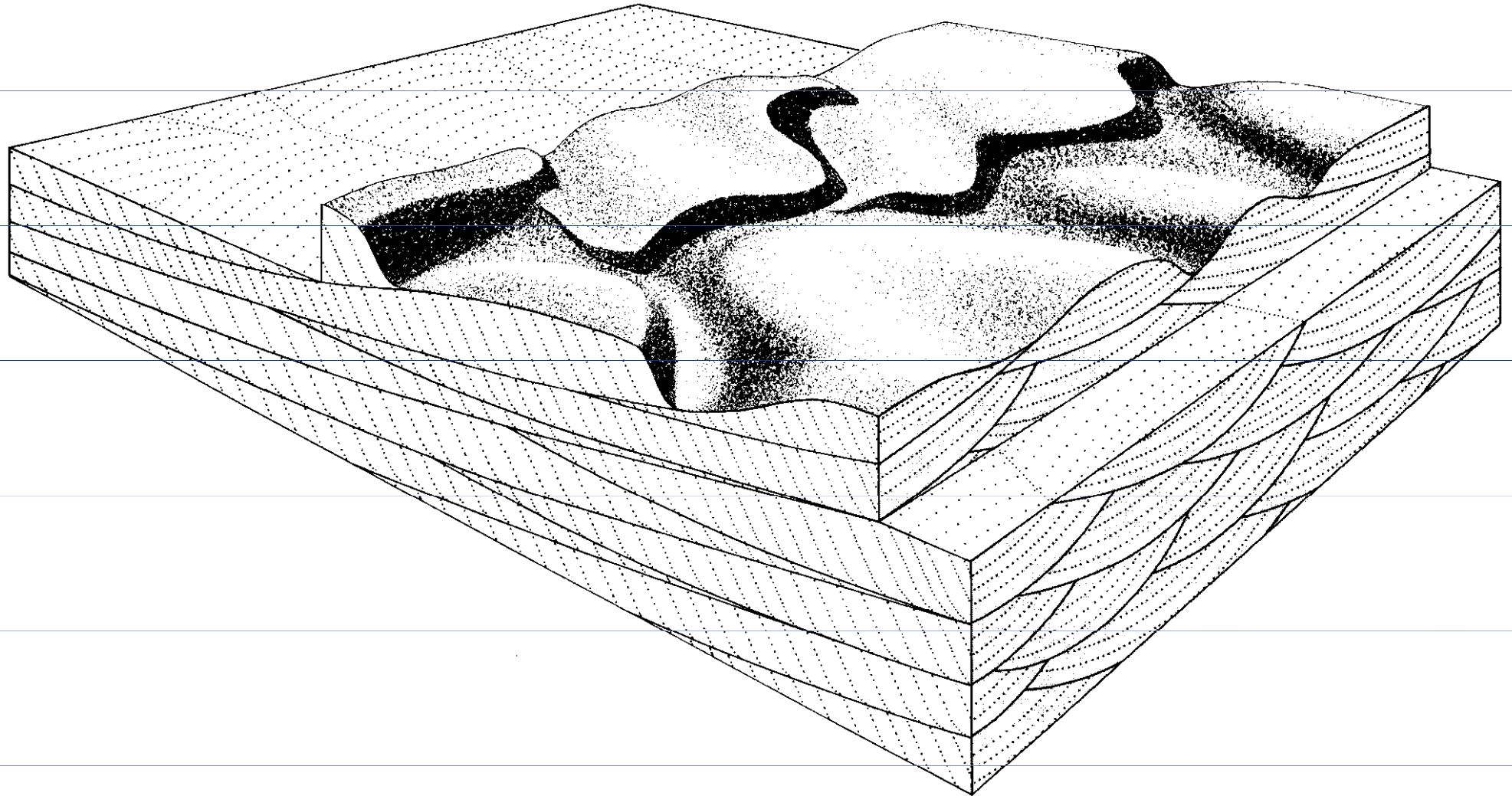







# Fluviální prostředí

- Channel patterns (fluvial styles) of alluvial rivers are commonly classified as:
  - **Braided rivers**
  - **Meandering rivers**
  - **Straight rivers**
  - **Anastomosing rivers**
- Fluvial style is primarily controlled by specific stream power  $\omega$  ( $\text{W m}^{-2}$ ) and bed-load grain size, but also by bank stability and the amount of bed load (but **not** the proportion of suspended load!)

$\rho$ =fluid density;  $Q$ =discharge,  $\omega = \frac{\rho g Q s}{w}$  (gradient);  $w$ =channel width



# Stavební prvky fluviálních systémů

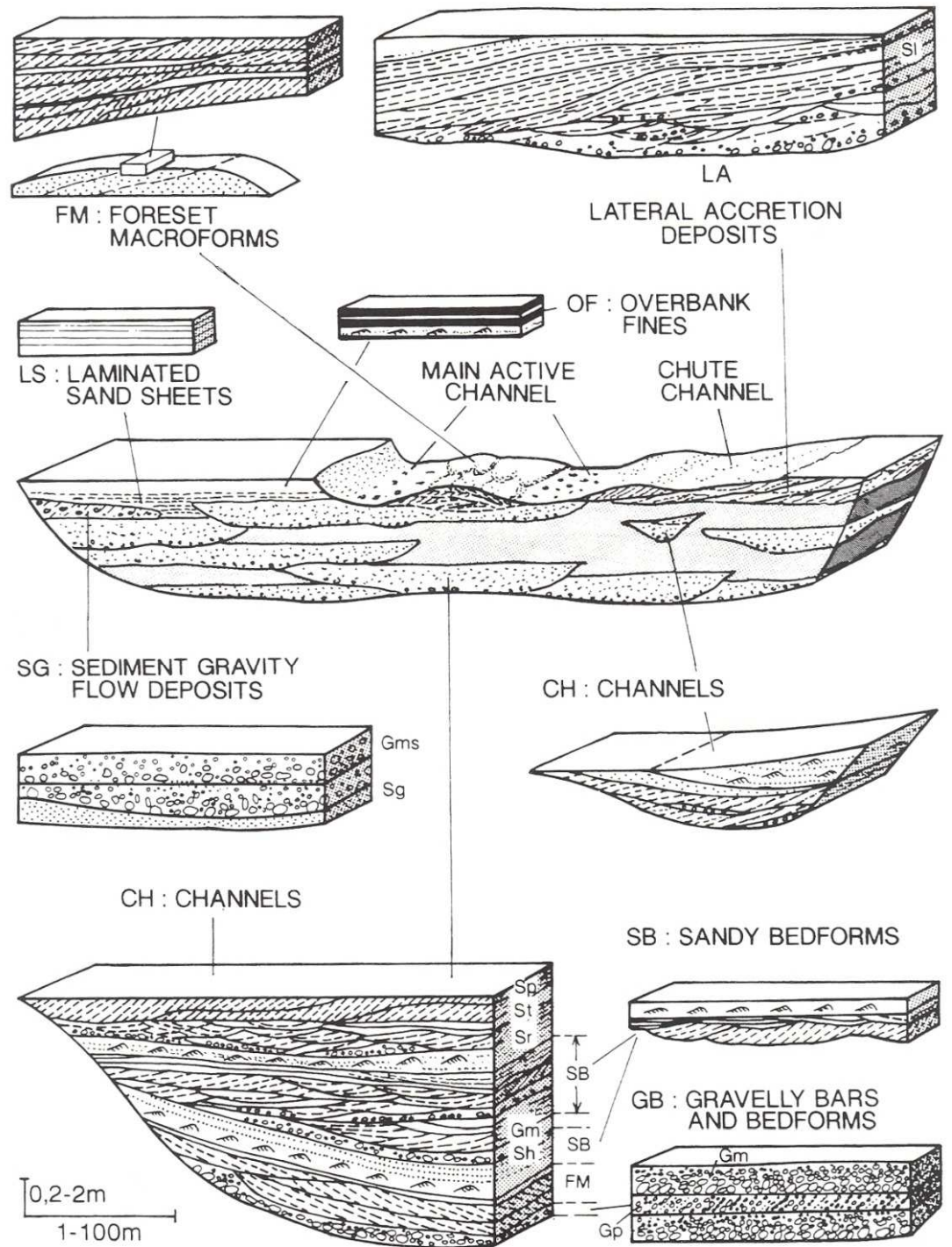

# Aluviální vějíř

- **Lateral accretion** (boční akrece) involves higher-order bounding surfaces dipping perpendicular to paleoflow direction and associated lower-order bounding surfaces; in the case of **downstream accretion** higher-order bounding surfaces dip parallel to paleoflow direction
- Kanály
- Gravitační sedimenty (úlomkotoky)

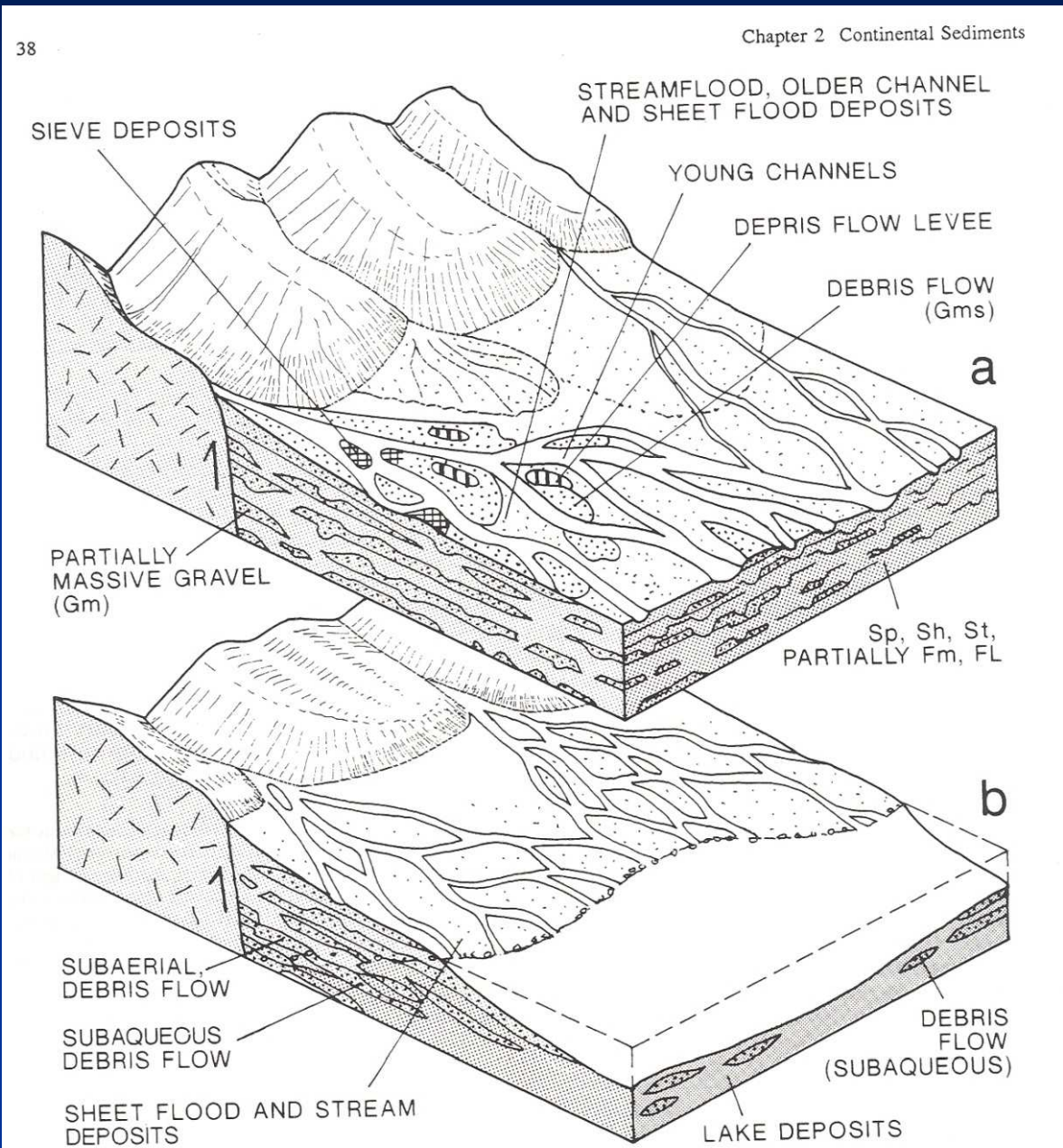

Fig. 2.11. Simplified facies models of a alluvial fan (proximal to mid fan region) and b fan delta. See Table 2.1 for explanation of symbols

# Divočící řeky

- Braided rivers are characterized by a dominance of braid bars exhibiting both lateral and downstream accretion; meandering rivers primarily contain point bars with lateral accretion; in straight (and most anastomosing) rivers bars are commonly almost absent
- **Bars (valy)** are sandy or gravelly macroforms in channels that are emergent, mostly unvegetated features at low flow stage, and undergo submergence and rapid modification during high discharge

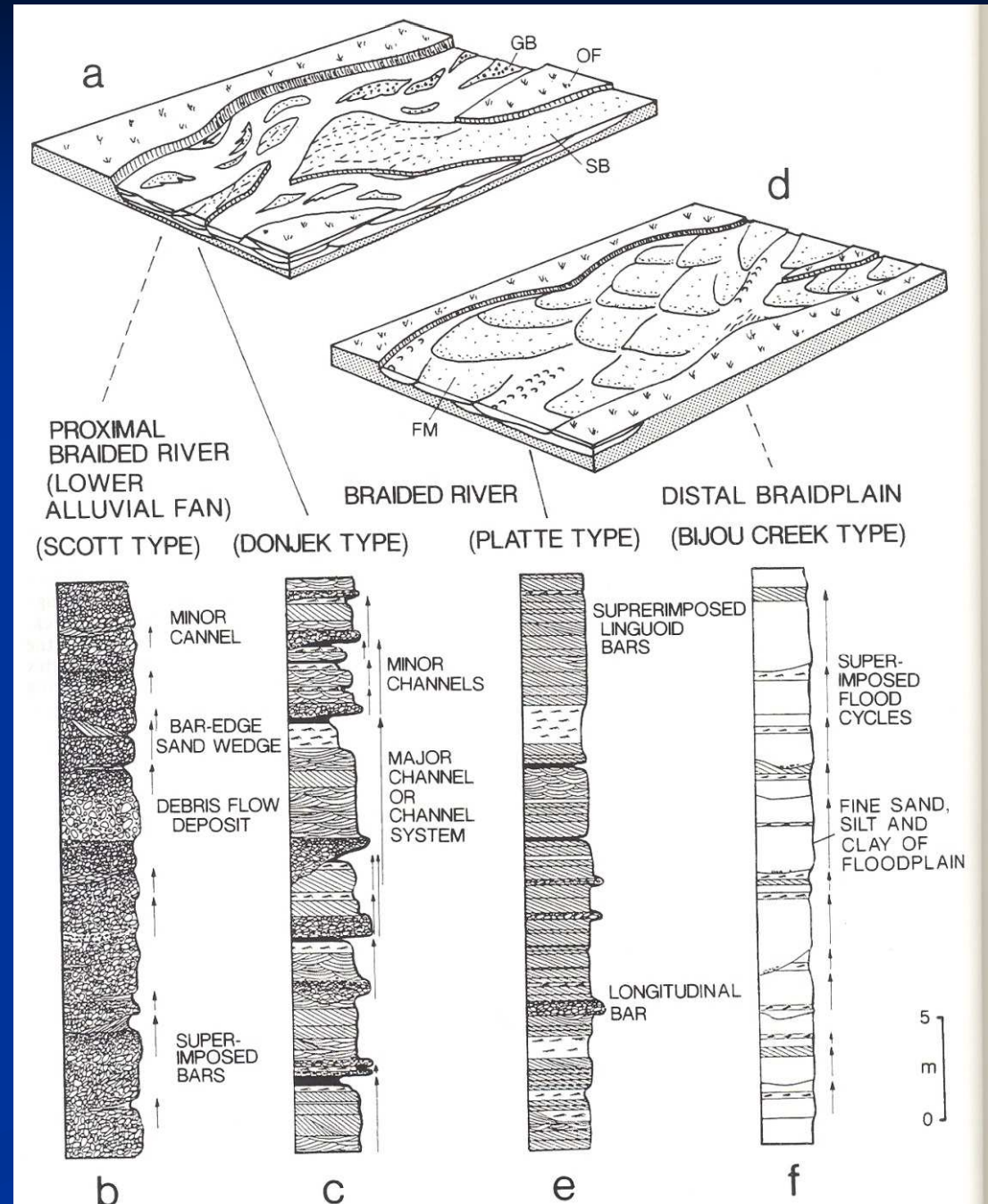

Fig. 2.15a-f. Braided river systems. a-c Proximal to middle reaches, gravel-dominated (b), or sand-dominated (c) with minor proportion of gravel. d-f Distal, sand-dominated system with wide channels and flat, linguoid sand bars (d and e), or wide floodplain rarely inundated by flash floods (f). (After Miall 1985)

ated system with wide channels and flat, linguoid sand bars (d and e), or wide floodplain rarely inundated by flash floods (f). (After Miall 1985)





# Meandrující řeky

- **Point bars** (jesešní valy) form on inner banks and typically accrete laterally, commonly resulting in lateral-accretion surfaces; mid-channel or **braid bars** accrete both laterally and downstream
- Kanály, opuštěné kanály
- Přelivové sedimenty
- Povodňové roviny

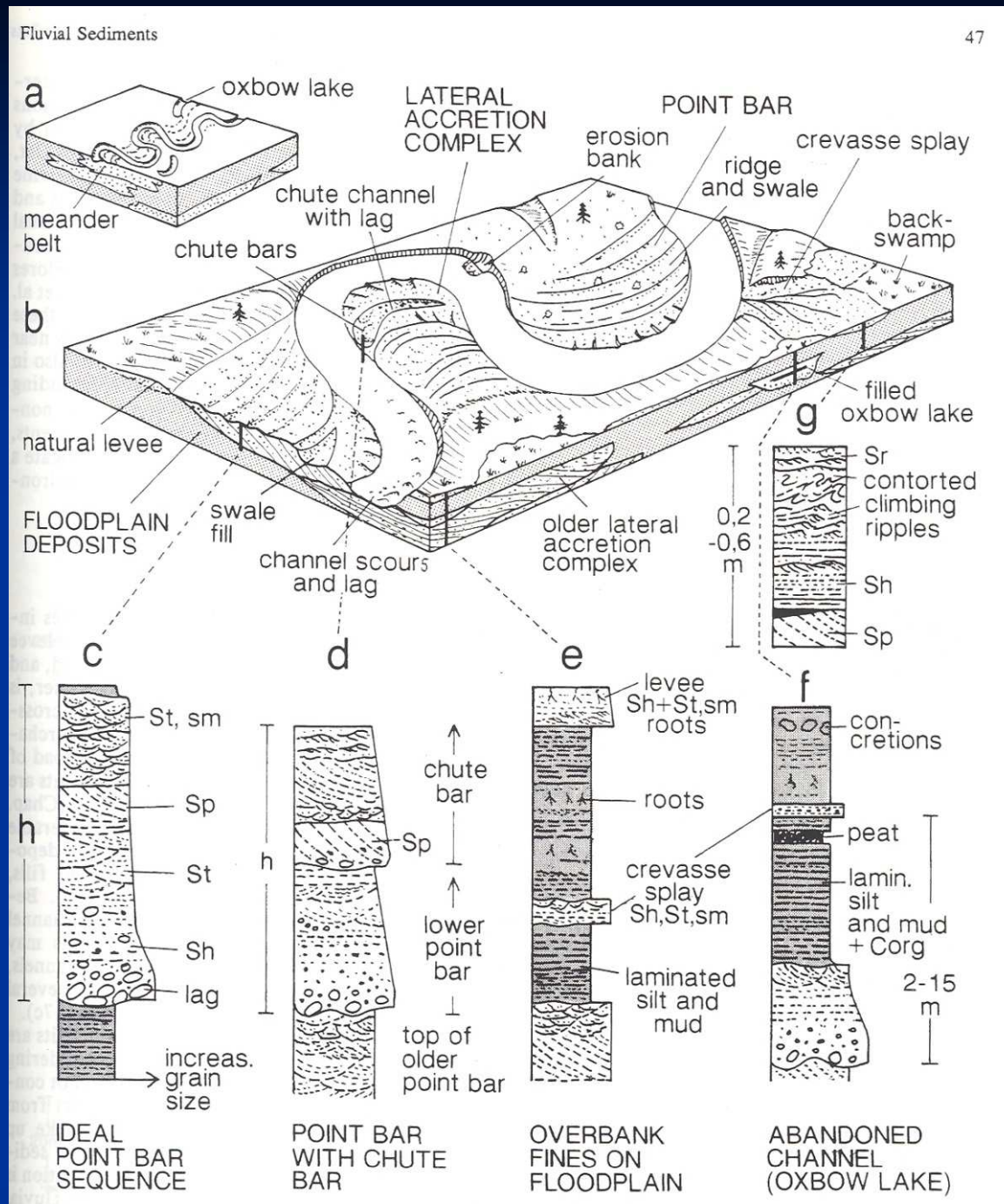
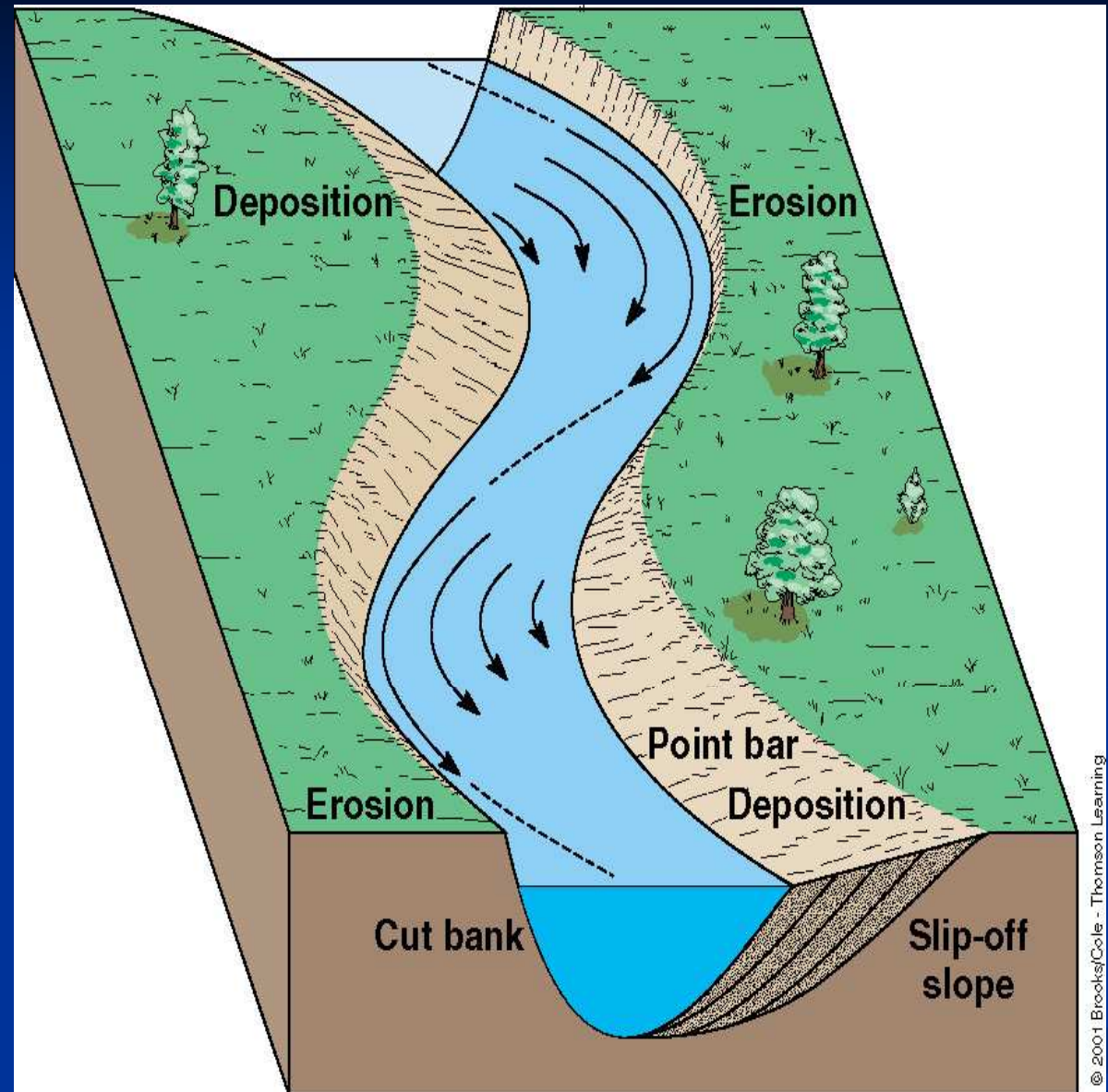

Fig. 2.16a-h. Meandering river system. **a** Formation of sandy meander belt within a flood basin. **b** Different sub-environments of meandering channel. **c-g** Characteristic vertical sections of the youngest sediments of the flood basin. **h** One fluvial cycle (autocyclic). See Table 2.1 for explanation of symbols; *sm* small-scale. (Based on different sources, e.g., Walker and Cant 1984; Galloway 1985; Miall 1985)

As shown by the photo in the previous slide, many streams naturally **meander** (form curving, S-shaped bends).

Stream channels tend to meander more and more over time. The reason is because **streams erode on the outsides of curves** (fastest water flow), and **deposit sediment on the insides of curves** (slowest water flow).

The eroding outside part of the curve is called the **cut bank**. The inside part of the curve where sediment is deposited is called the **point bar**.



## Mrtvé rameno (Oxbow lake)

A long-term result of erosion of cut banks (outsides of bends) is that a stream may eventually cut through the neck of a tight meander, abandoning part of its channel, and forming a feature called an **oxbow lake**.

The figure here shows the steps in this process.

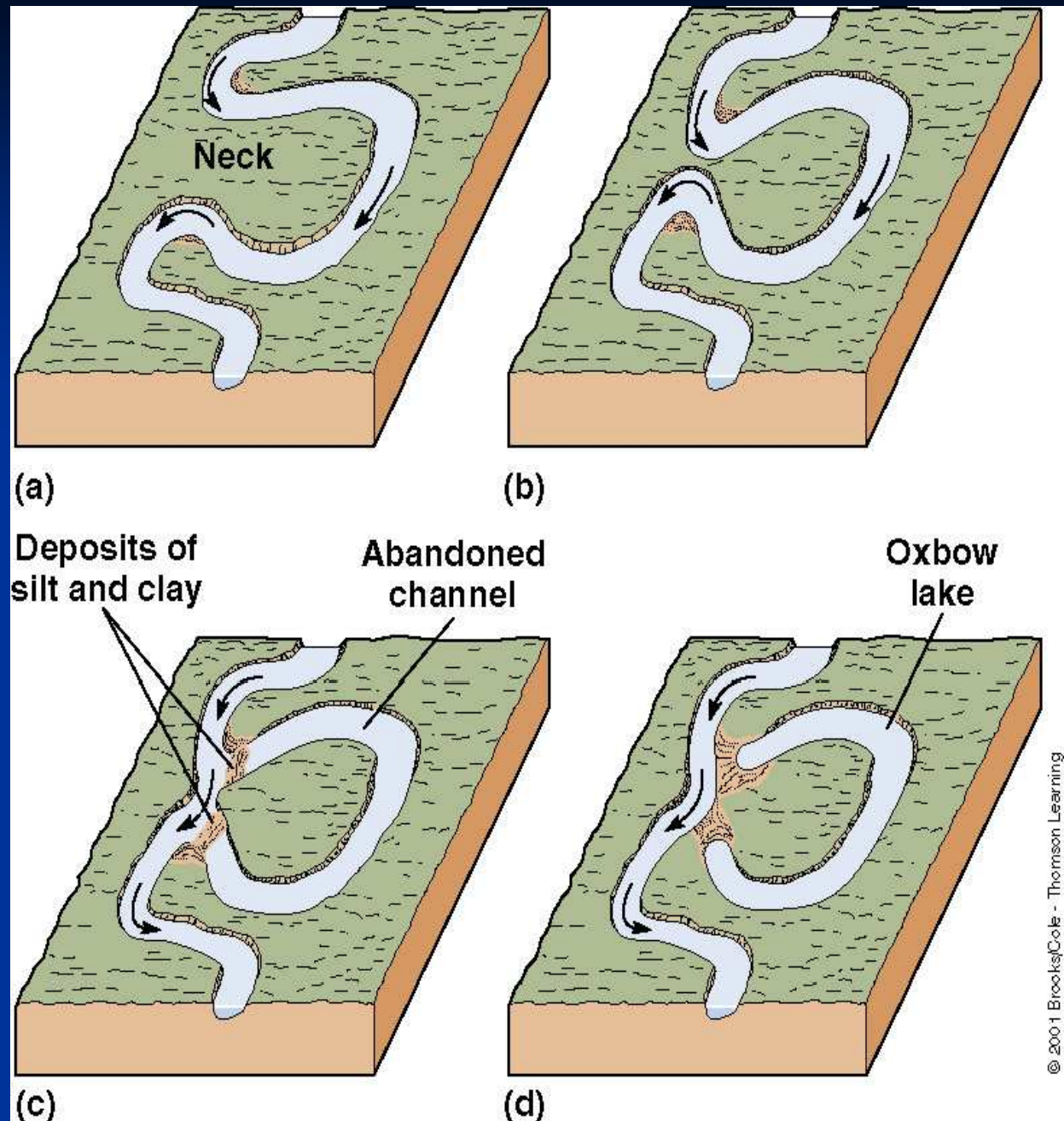



This air photo shows an **oxbow lake**. (The main channel is out of view to the right.) The curving “scars” on the land show the progressive migration of the meandering channel over time.



# Litovelské Pomoraví



Note on this figure the locations of the levees.

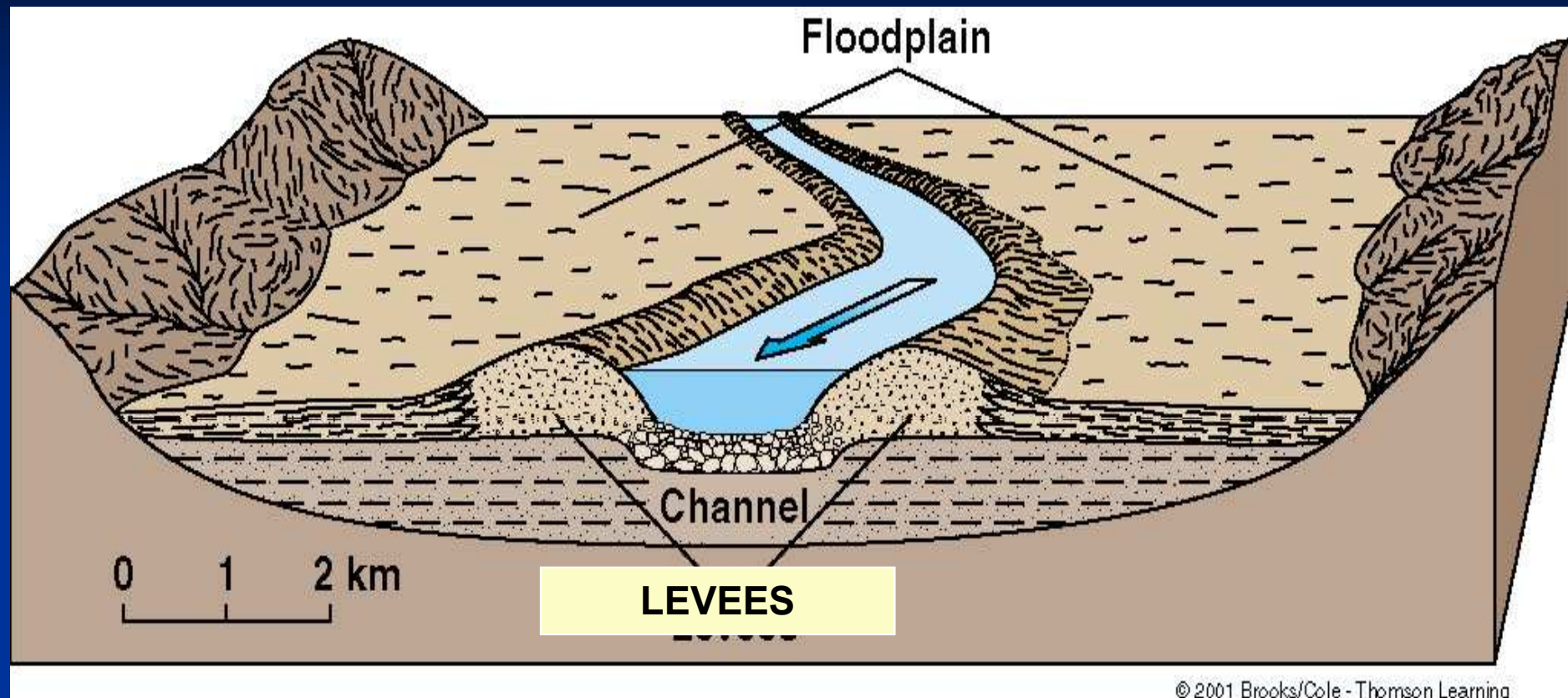

As a stream rises prior to flooding, its increased velocity and discharge allow it to carry more and more sediment. When the stream crests its banks and spills out onto the floodplain, the water slows down, depositing ridges of sediment along the banks called levees. The levees are often the highest places on the floodplain.



**22. Large scale trough cross bedding** (sandy bedforms)  
*Texture:* sand with pebbles passing into sandy pebble gravel in the upper part of the section  
*Structure:* trough cross bedding  
*Stratigraphy:* Lower Pleistocene terrace of the River Vltava  
*Locality:* Libčice (Praha Západ District)  
*Photo by:* J. Kadlec 1997



### 11. River channel fill

Upper part of the section

Channel fill: **gravel bar (GB) overlain by lateral accretion deposits (LA), channel fill covered by gravelly and sandy bedforms (SB)**

*Texture:* medium grained sandy gravel (GB), medium to coarse sand (LA), intercalation of sand and sandy gravels (SB)

*Structure:* the sands filling the channel are cross bedded, gently dipping sand laminae are formed by lateral accretion in the inner part of the river meander, GB – planar cross bedding, SB – horizontal stratification

Lower part of the section

**Sandy and gravelly bedforms**

*Texture:* coarse sand with the occasional admixture of pebbles

*Structure:* faint planar cross-bedding

*Stratigraphy:* Middle Pleistocene terrace of the River Vltava

*Locality:* Hostín u Vojkovic (Mělník District)

*Photo by:* J. Kadlec 1997



### 3. River channel fill

**Sandy and gravelly bedforms**

*Texture:* alternation of medium to coarse sand and sandy pebble gravel

*Structure:* planar cross-bedding

*Stratigraphy:* Middle Pleistocene terrace of the River Vltava

*Locality:* Straškov (Litoměřice District)

*Photo by:* J. Kadlec 1997

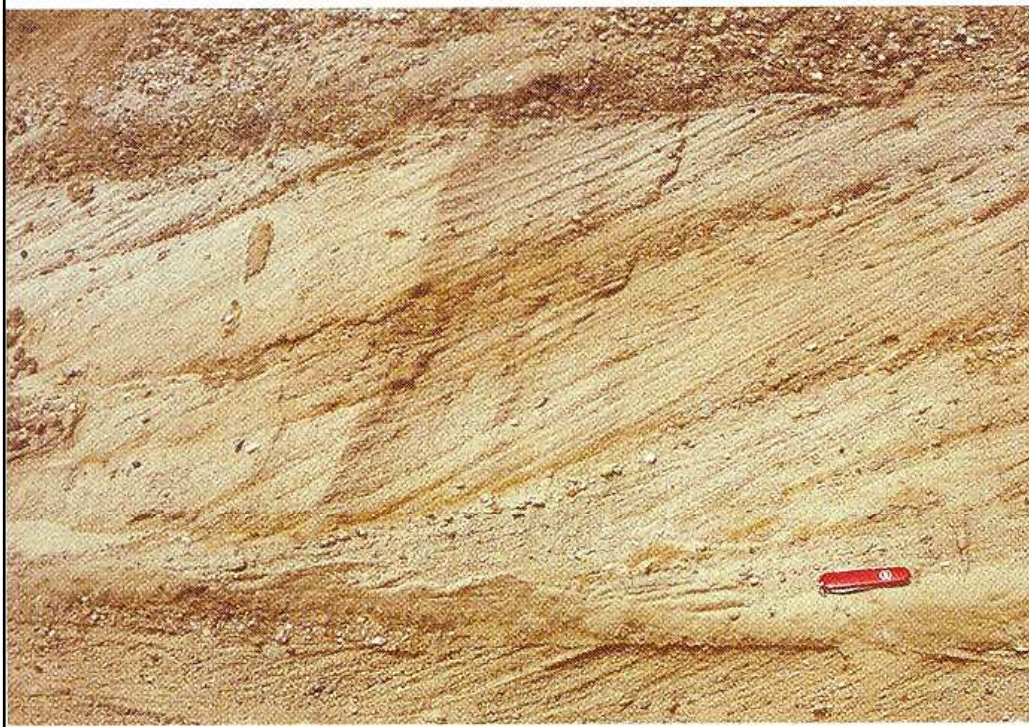

## 8. Downstream accretion deposits

*Texture:* medium to coarse sand with an admixture of gravel

*Structure:* planar cross-bedding

*Stratigraphy:* Lower Pleistocene terrace of the River Vltava

*Locality:* Libčice nad Vltavou (Praha Západ District)

*Photo by:* J. Kadlec 1997



## 1. River channel fill

Upper part of the section

### Sandy and gravelly bedforms

*Texture:* alternation of coarse sand and medium grained sandy gravel

*Structure:* trough cross-bedding

Middle part of the section

### Downstream accretion deposits

*Texture:* coarse sand and gravelly sand

*Structure:* planar cross-bedding

*Stratigraphy:* Middle Pleistocene terrace of the River Labe

*Locality:* Tišice (Mělník District)

*Photo by:* J. Kadlec 1997

# Říční terasy

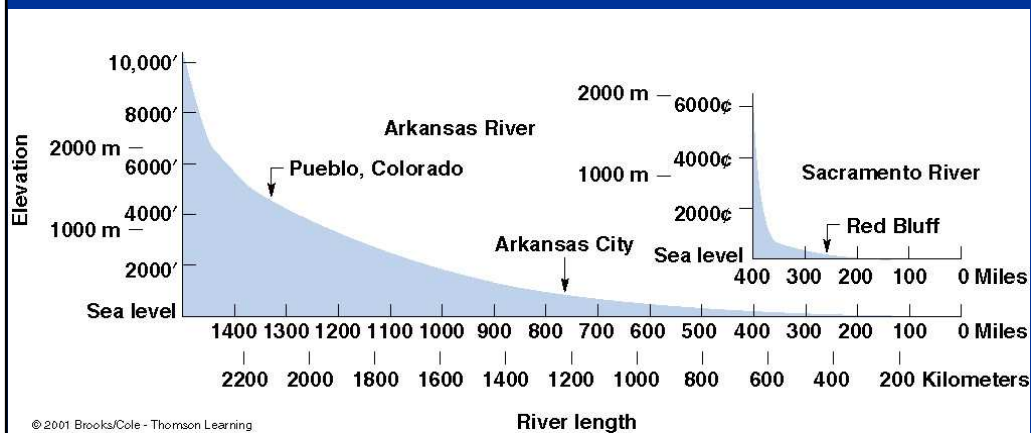
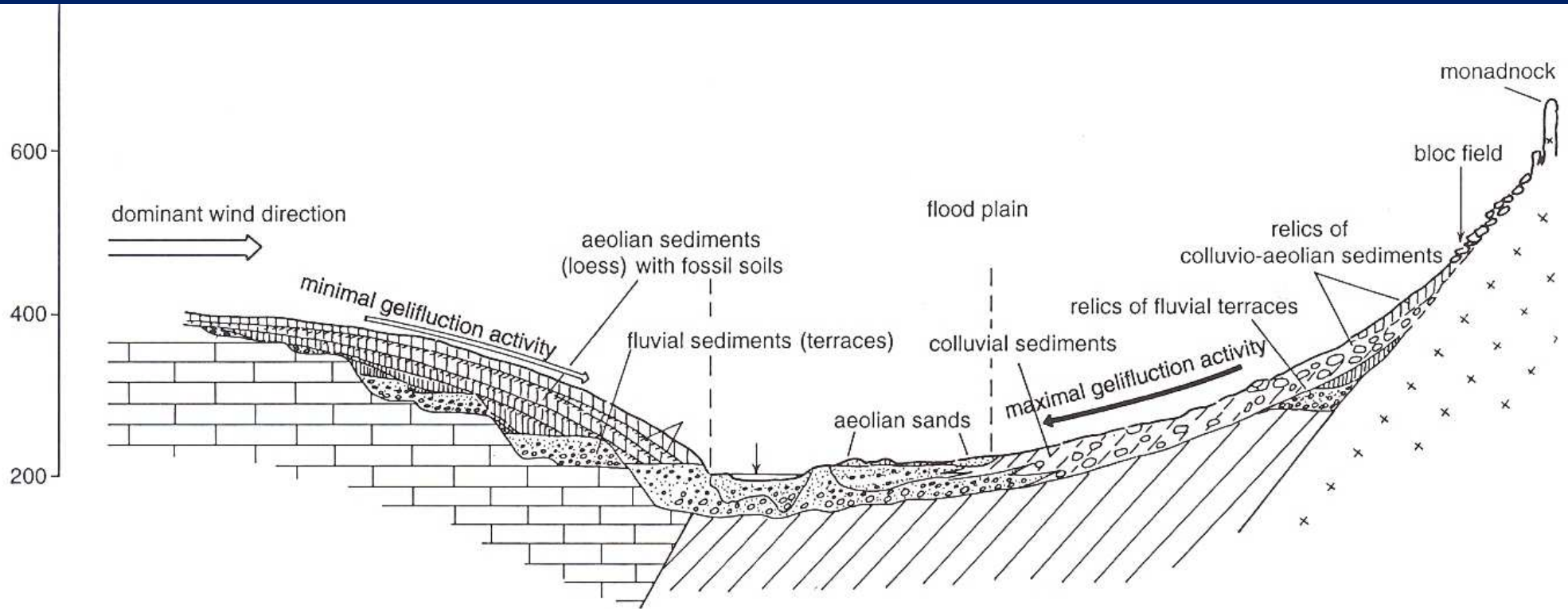

# Holocenní sedimentační systémy řeky Moravy

## HISTORICKÁ FAKTA / INTERPRETACE / TRADICE (.)

- Niva Moravy osidlována od neolitu
- Přítomnost údolních svrchnopleistocenních teras v podloží aktivních holocenních niv (degradace → agradace)
- Změny v nivě v důsledku antropogenní činnosti – zvýšení rychlostí sedimentace (zahliňování) např. v době Velké Moravy
- Řeka Morava – anastomozující systém (holocenní změna meandrujícího systému na anastomozující)

## OTÁZKY (?)

- **Nastala skutečně holocenní změna režimu sedimentace Moravy (na bázi holocénu, během holocénu, antropogenní činností?)**

## CÍLE A METODY (!)

- **Mapování fluviálních facií pomocí mělkých geofyzikálních metod**
  - Elektrická odporová tomografie (ERT) – měření měrného odporu hornin, který je závislý na zrnitosti, minerálním složení, obsahu vody
  - Dipólové elektromagnetické profilování (DEMP) – měření vodivosti hornin – převrácená hodnota odporu
- **Stratigrafie vrtů**
- **Datování**
  - $^{14}\text{C}$  (AMS)

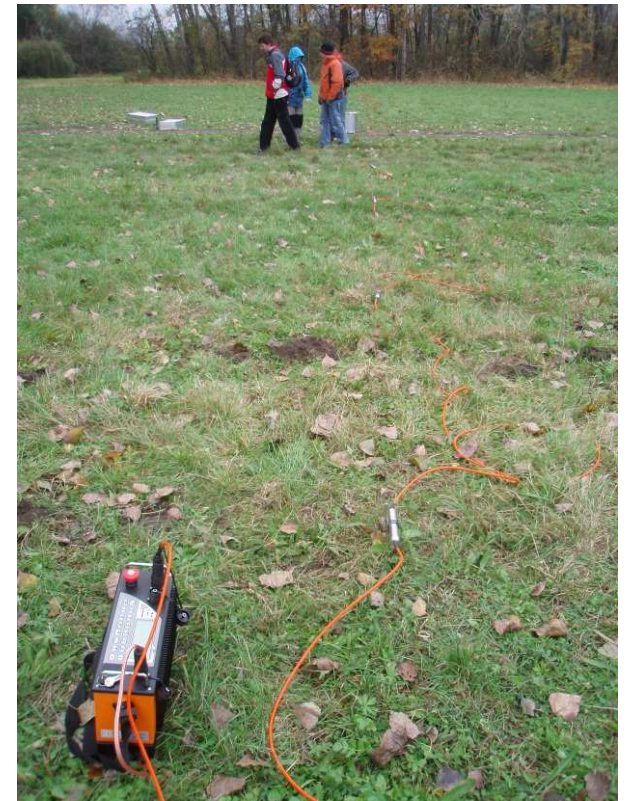



# Aktivní niva Moravy:

- Hornomoravský úval
- Mohelnická brázda

Nízké sklony svahů ( $< 0,15^\circ$ )

Zlomově omezená příkopová propadlina

Lokality v nivě Moravy a přítoků (Oslava)

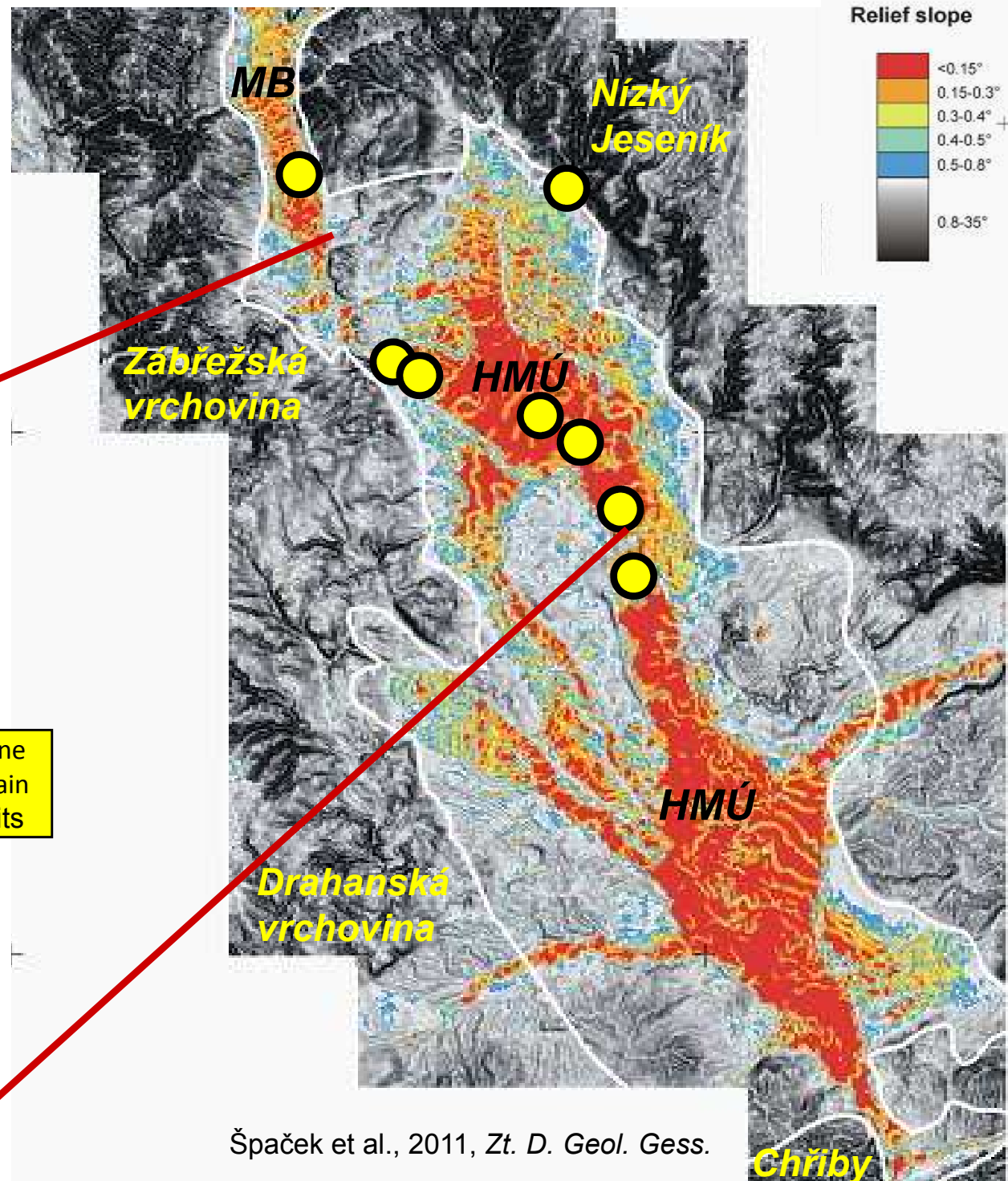
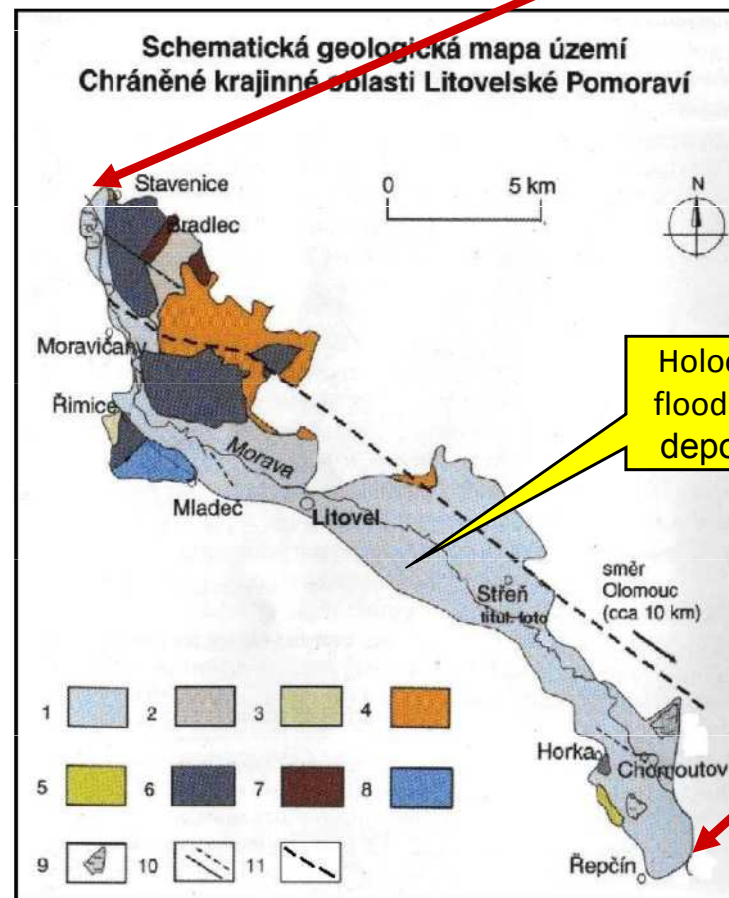

## Stavební prvky fluviálního systému

- Vegetační příznaky
- Historické ortofotomapy

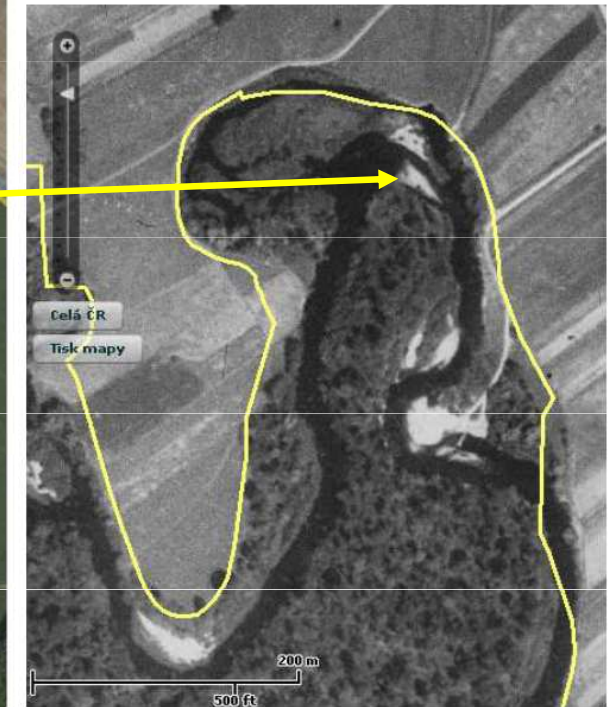
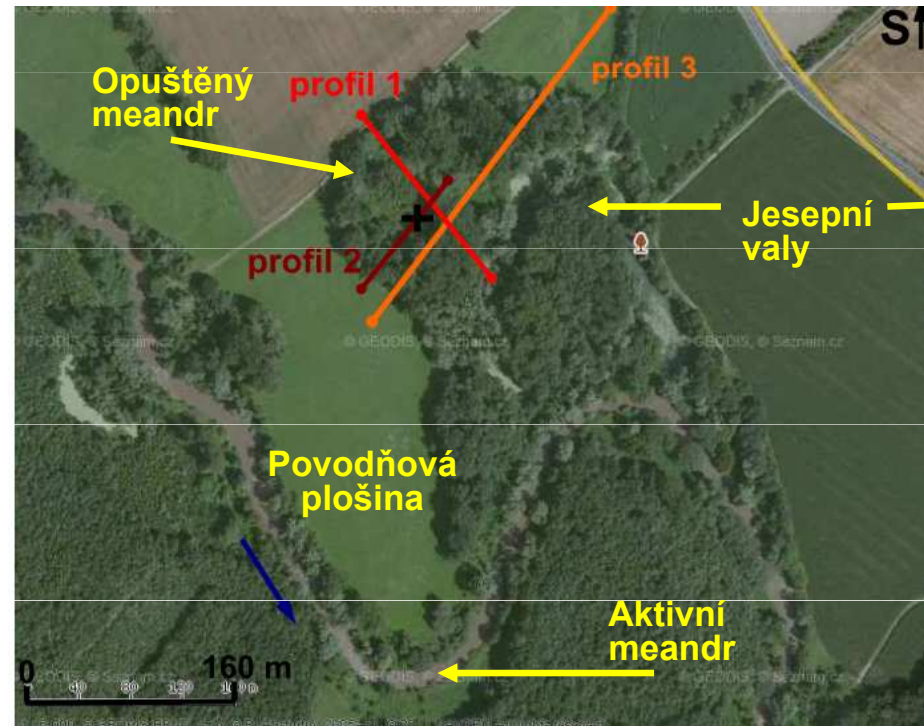

- opuštěné meandry
- aktivní meandry
- jesepní valy
- povodňové plošiny

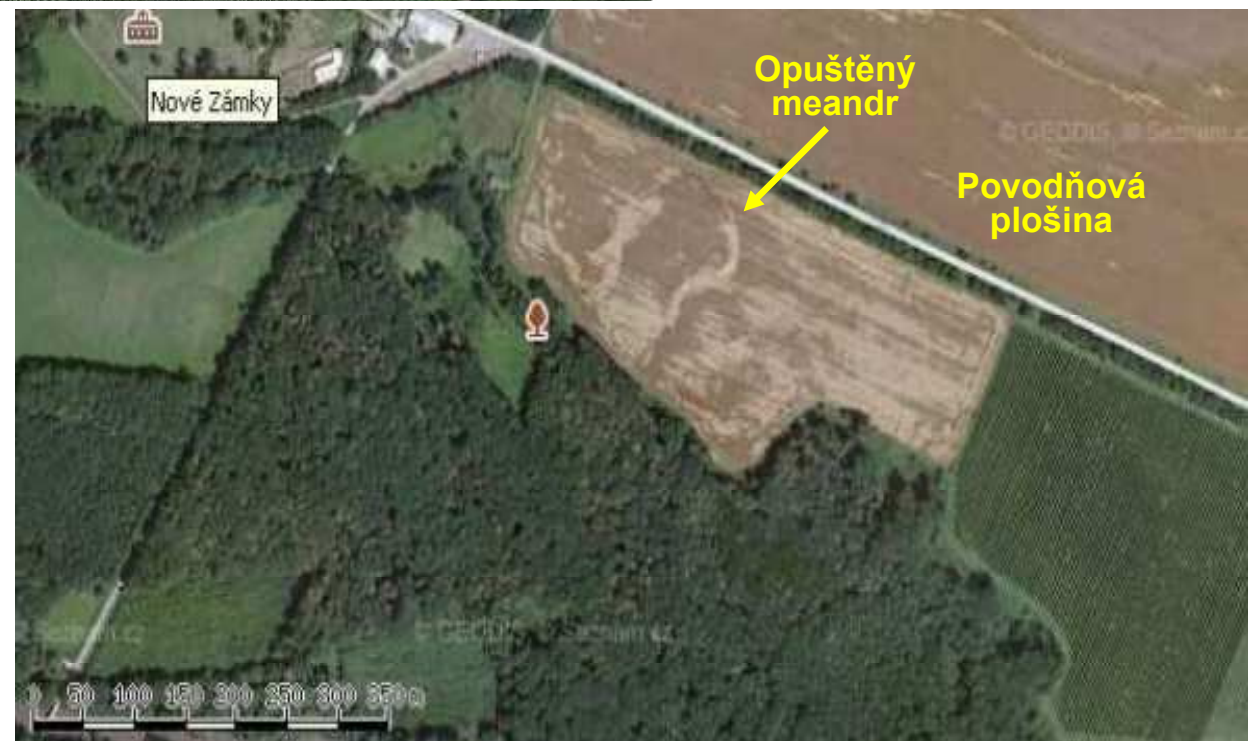

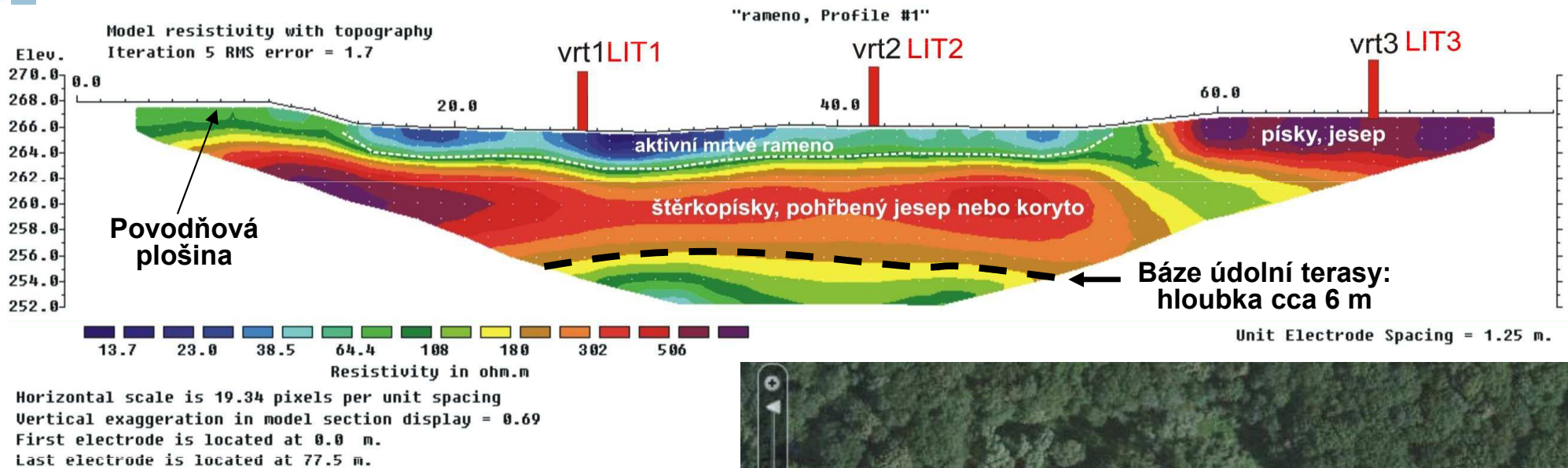

## Litovelské luhy

- aktivní poloslepé rameno
- Jeseňní val, štěrkopísky: resistivita 350 – 550 ohm.m
- Opuštěný meandr: silty, jíly: resistivita 10 – 50 ohm.m
- Povodňová plošina: silty, jíly: resistivita 60 – 80 ohm.m

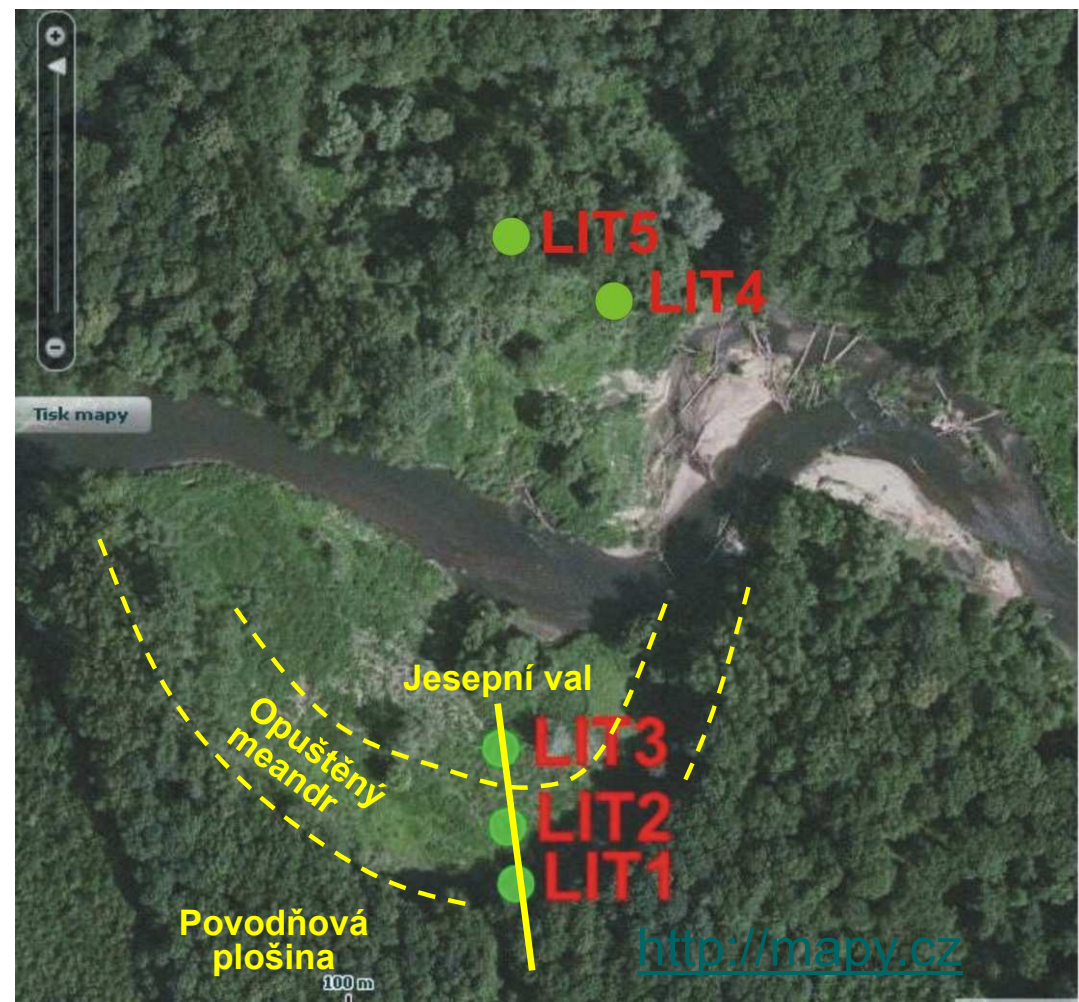

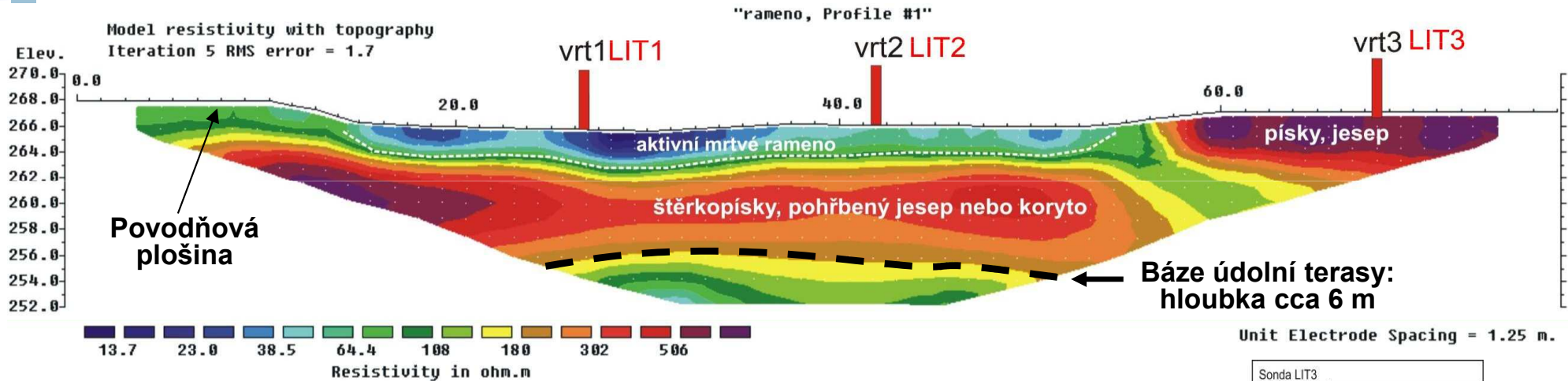

Unit Electrode Spacing = 1.25 m.

Horizontal scale is 19.34 pixels per unit spacing  
Vertical exaggeration in model section display = 0.69  
First electrode is located at 0.0 m.  
Last electrode is located at 77.5 m.

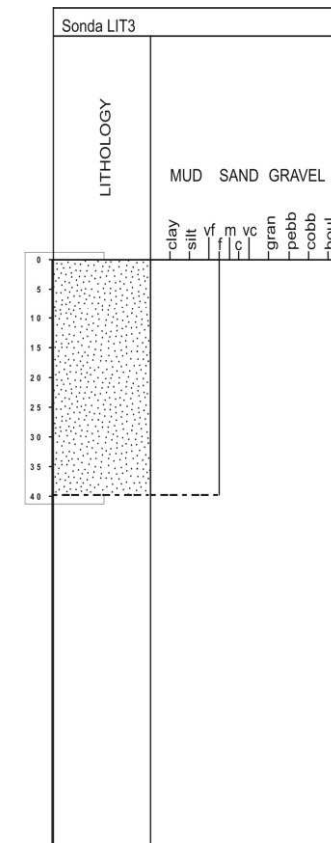
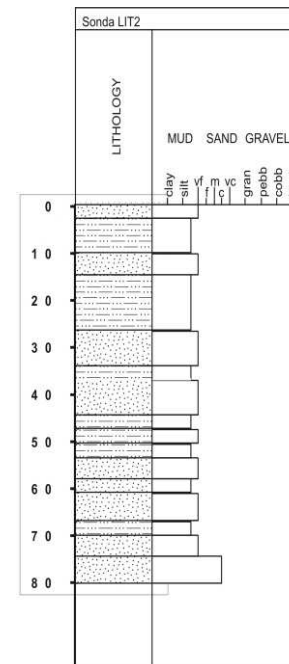
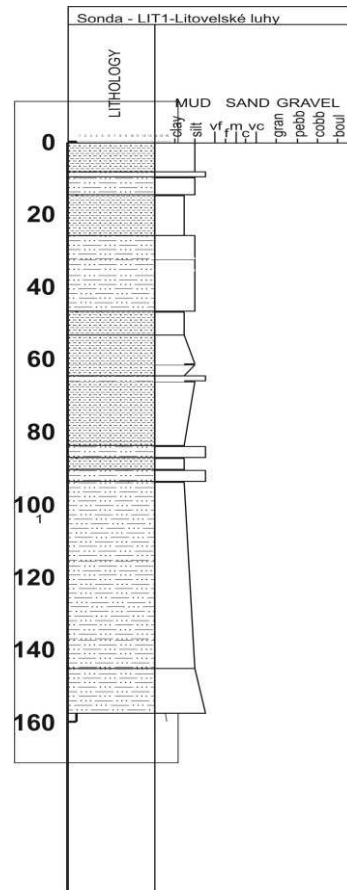

*Mapa vodivosti (DEMP)  
Olomouc – Bázlerova pískovna  
povodňová plošina*



zdánlivá vodivost [mS/m]

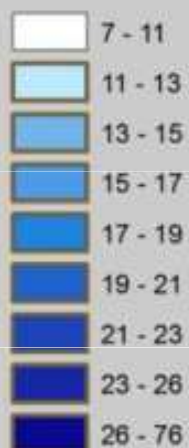

- - - nárazový hřbet  
- - - hřebety jesepních valů

protínání starších  
struktur mladším  
meandrem

nejmladší  
oblouk meandru

opuštěné  
koryto

přelivové sedimenty

0 10 20 40 60 80 100 m

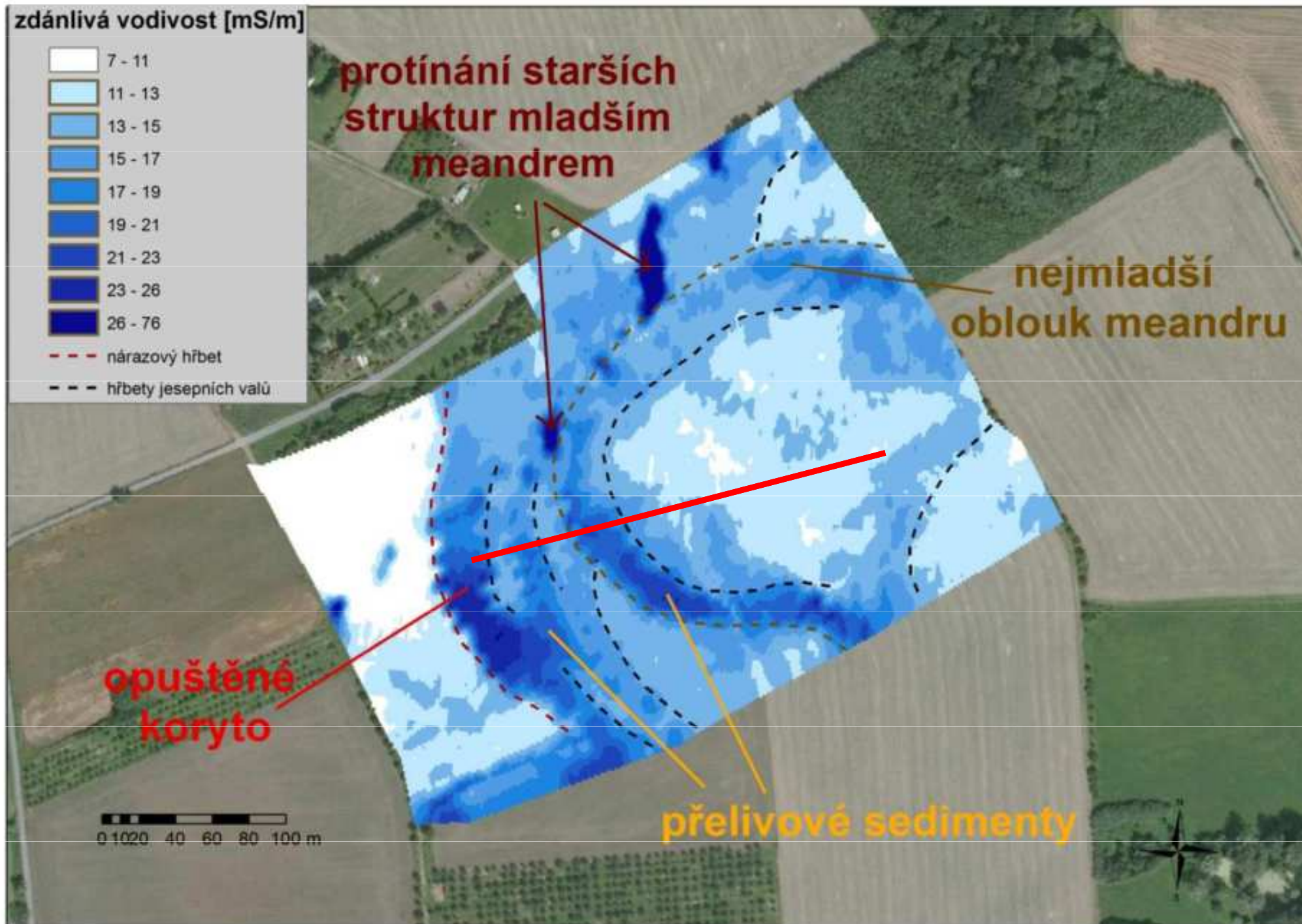

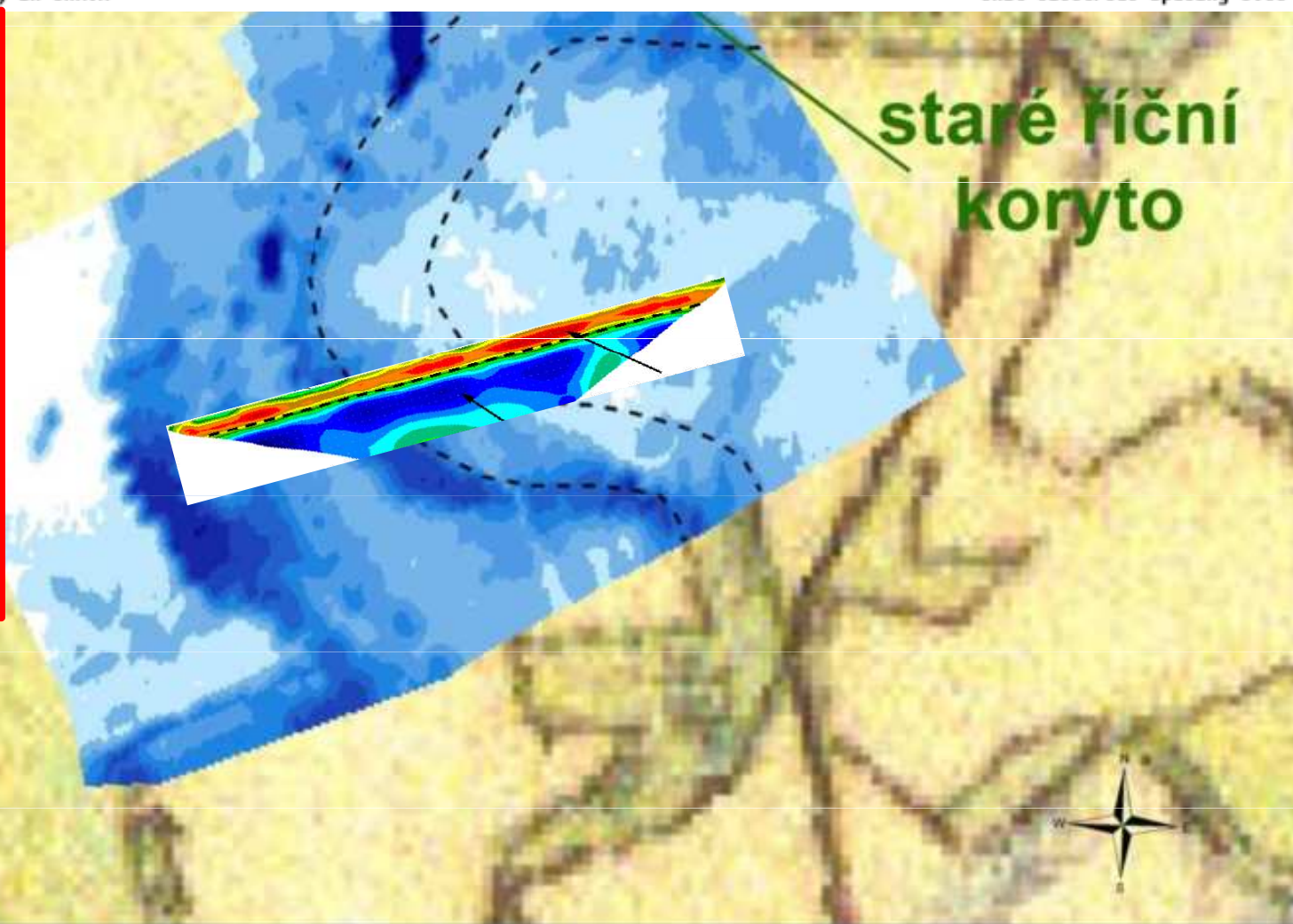
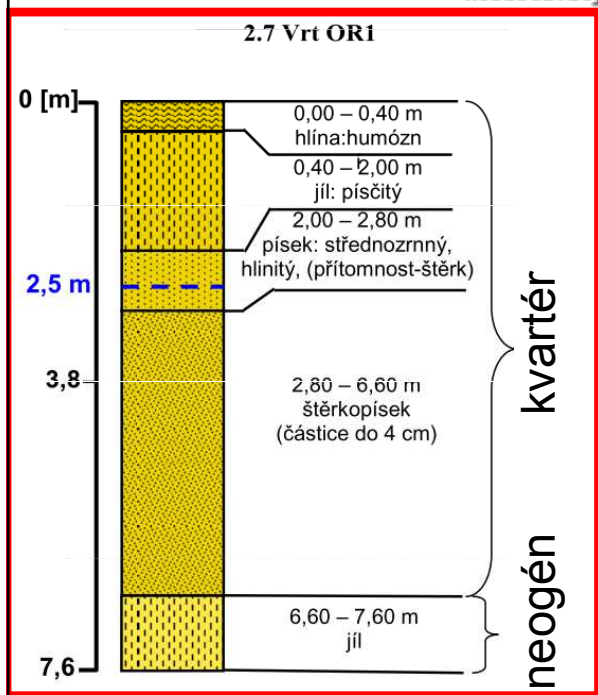
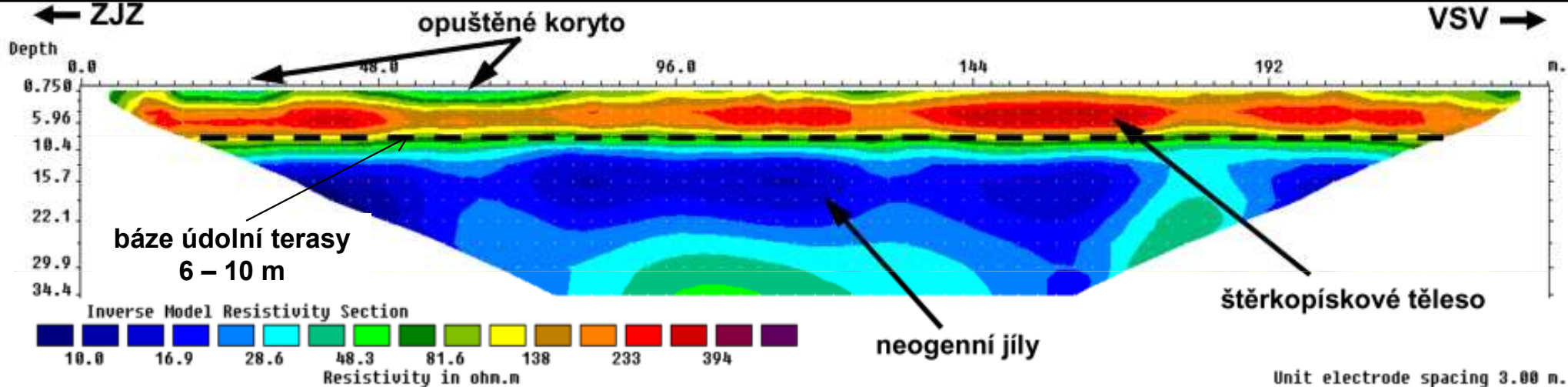

## Doubravice

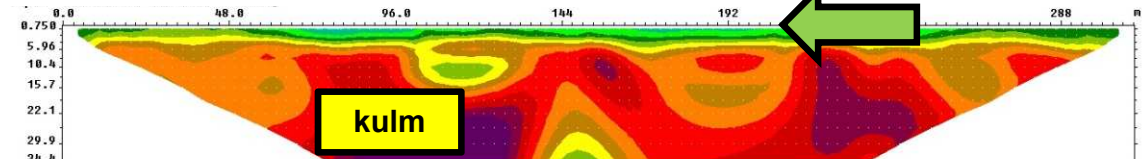

## Litovel

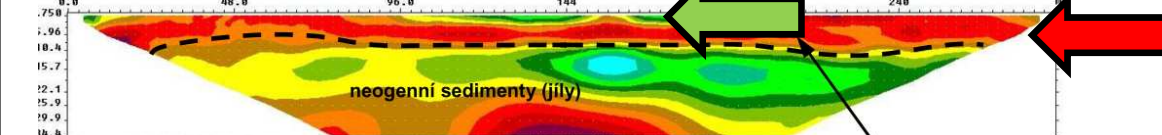

## Nové Zámky 1

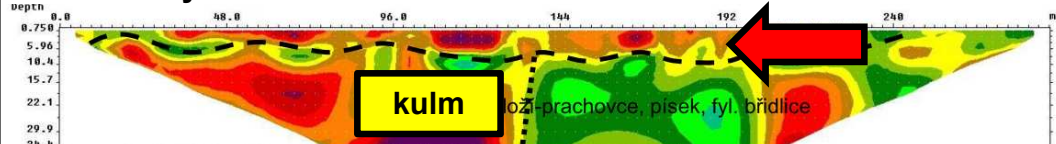

## Nové Zámky 2

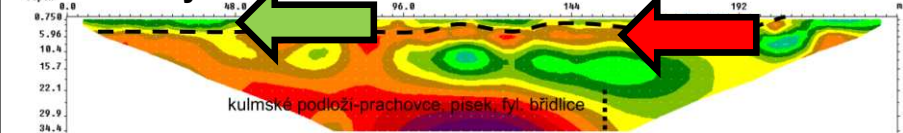

## Štěpánov

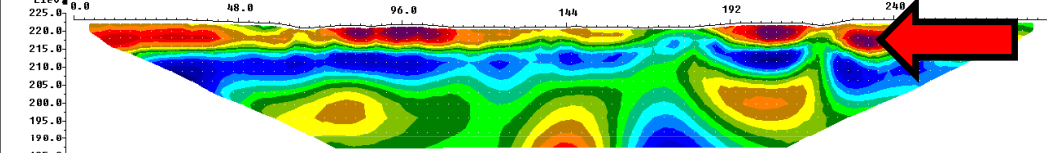

## Chomoutov

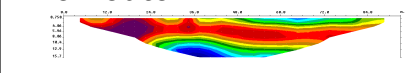

## Štěpánov 2

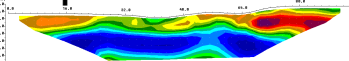

## Olomouc - Řepčín

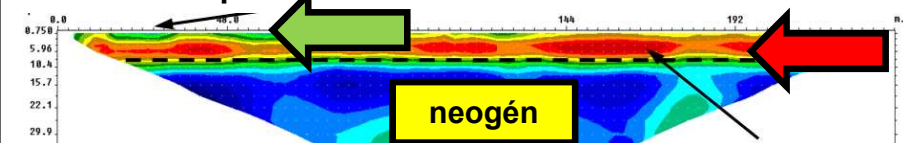

## Holice

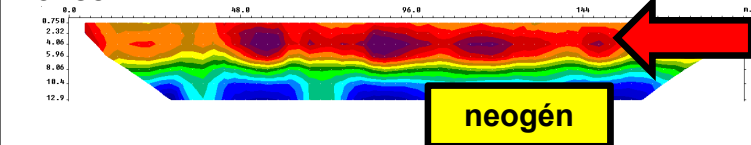

## Jednotná stratigrafie

1. Předkvartérní podloží: různé rezistivity → neogén, kulm
2. Kvartér: vysoká rezistivita, štěrkopísková laterálně akreční tělesa = meandrování, horizontální báze těles → báze údolní terasy 6 – 10 m
3. Kvartér: nízká rezistivita, povodňové sedimenty, vertikální akrece
4. **Stáří ??**



# Faciální modely fluviálních systémů

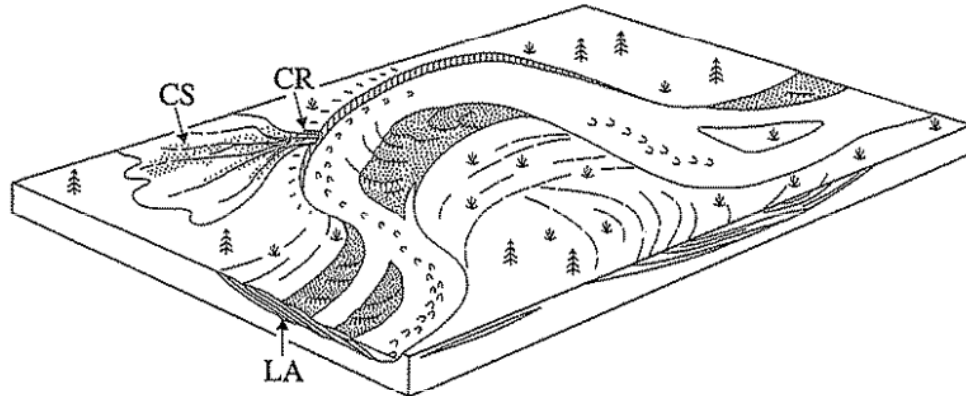

*Písčité meandrující systémy*

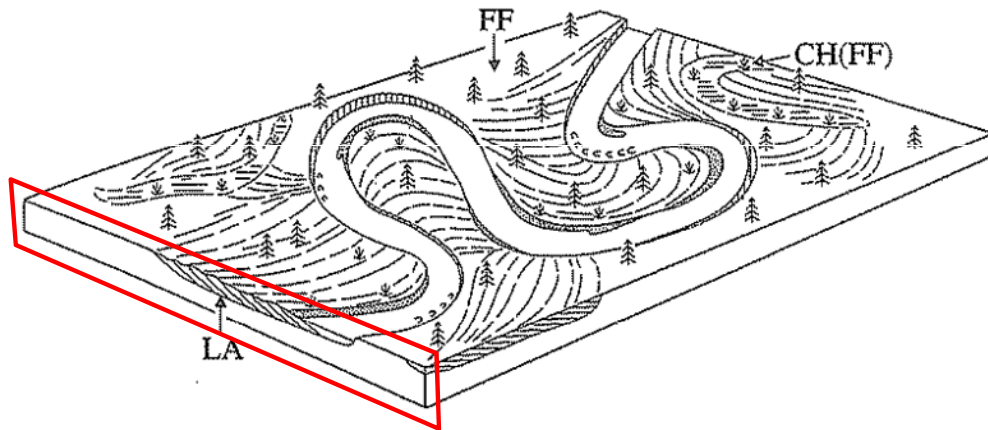

*Jemnozrnné meandrující systémy*

- LA : laterálně akreční tělesa*
- CR : průvalová koryta*
- CS : průvalové sedimenty*
- FF : povodňové sedimenty*
- CH(FF) : výplně opuštěných koryt*

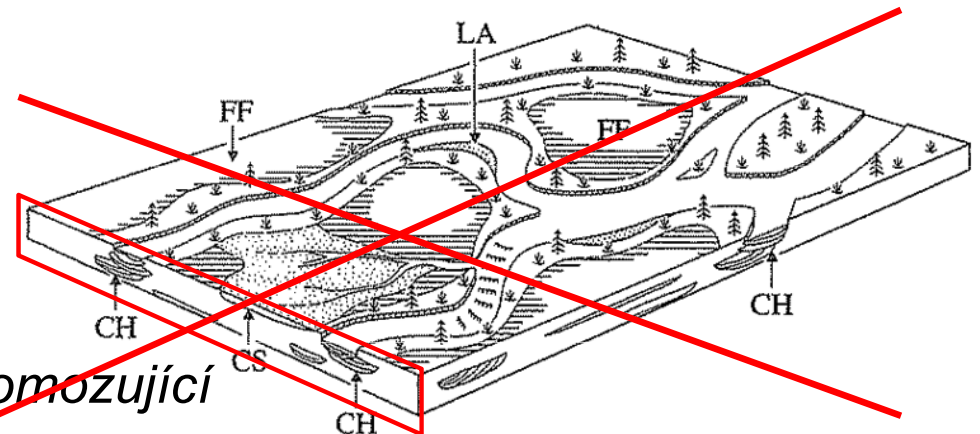

*Anastomozující systémy*

# $^{14}\text{C}$ (AMS) datování

- Rozsah dat: 0,13 – 6,14 kyr BP
- Hloubkový rozsah: 0,76 – 3,3 m, neplatí superpozice
- Shluky dat: laterální pozice, nikoli hloubka
- → neustálá laterální akrece a recyklace holocenního materiálu (mladší atlantik – historická doba)

$^{14}\text{C}$  age distribution

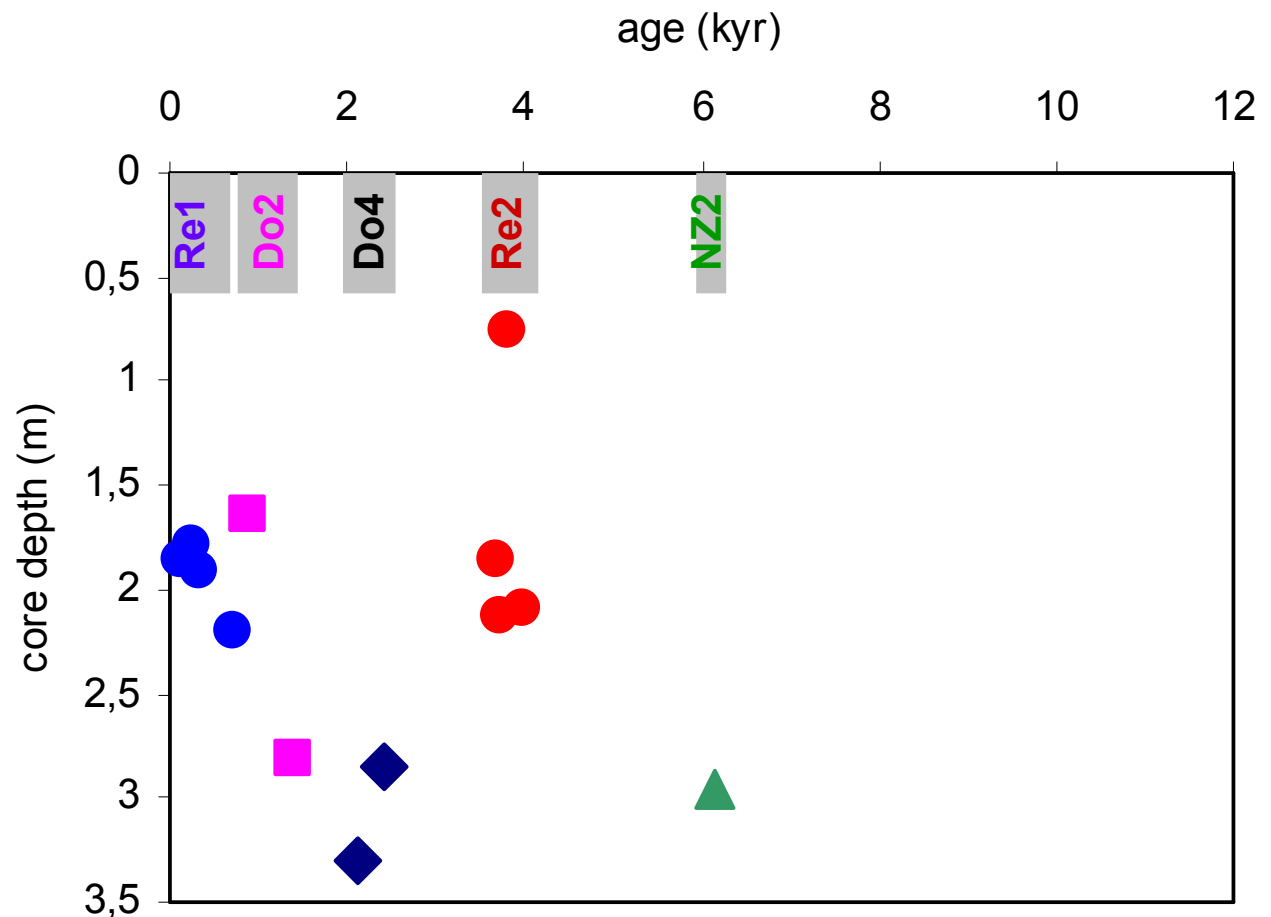

# JESKYNNÍ SEDIMENTY

# Kras

- Krasové jevy
  - ◆ Water reacts with carbon dioxide to form weak carbonic acid which then attacks limestone
    - ◆  $\text{H}_2\text{O} + \text{CO}_2 \Rightarrow \text{H}_2\text{CO}_3 + \text{CaCO}_3 \Rightarrow \text{Ca}^{++} \text{HCO}_3^-$
- Caves (jeskyně)- natural underground cavities and most common geological product of limestone dissolution
- Speleotémy - speleotherms are deposits on cave surfaces in a variety of forms: travertine, Stalactite, Stalagmite, banded draperies or drip curtains
- Růst speleotémů: depends on the solution and porosity of surface material, climate, topography, and vegetation

# Světové rozšíření krasu

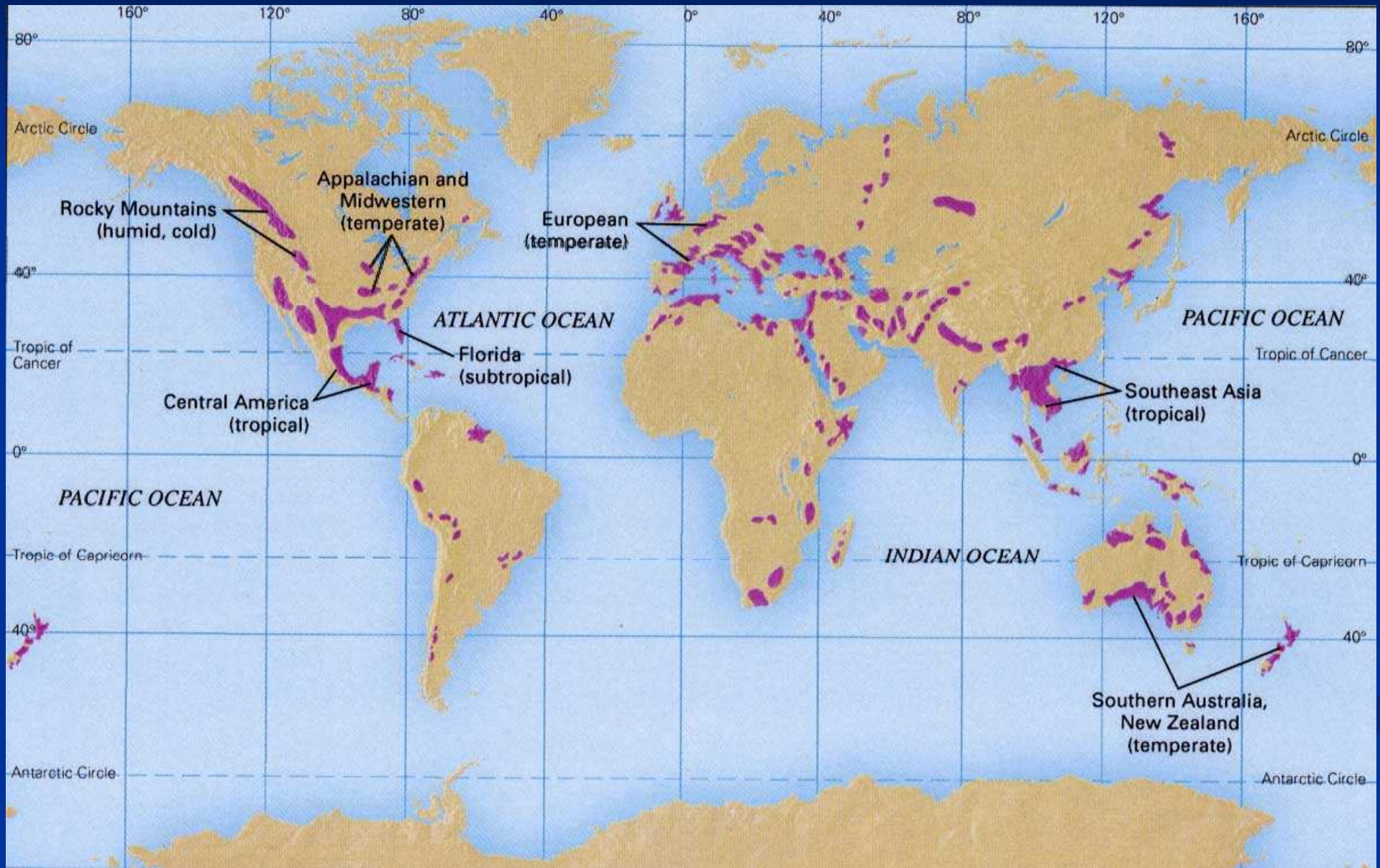

# Topografie krasu

Surface expression of the geology of dissolved limestone and work of near surface water

- Cave and Karsts landscapes are extremely sensitive- so need to be protected
- Landform
  - ◆ Sinkholes (závrty) -circular surface depression
  - ◆ Disappearing Streams (ponory) - flow through sinkholes may emerge as spring several kilometers away
  - ◆ Natural Bridge (skalní mosty)- series of neighboring sinkholes expand and join together

# Typical landforms associated with karst topography

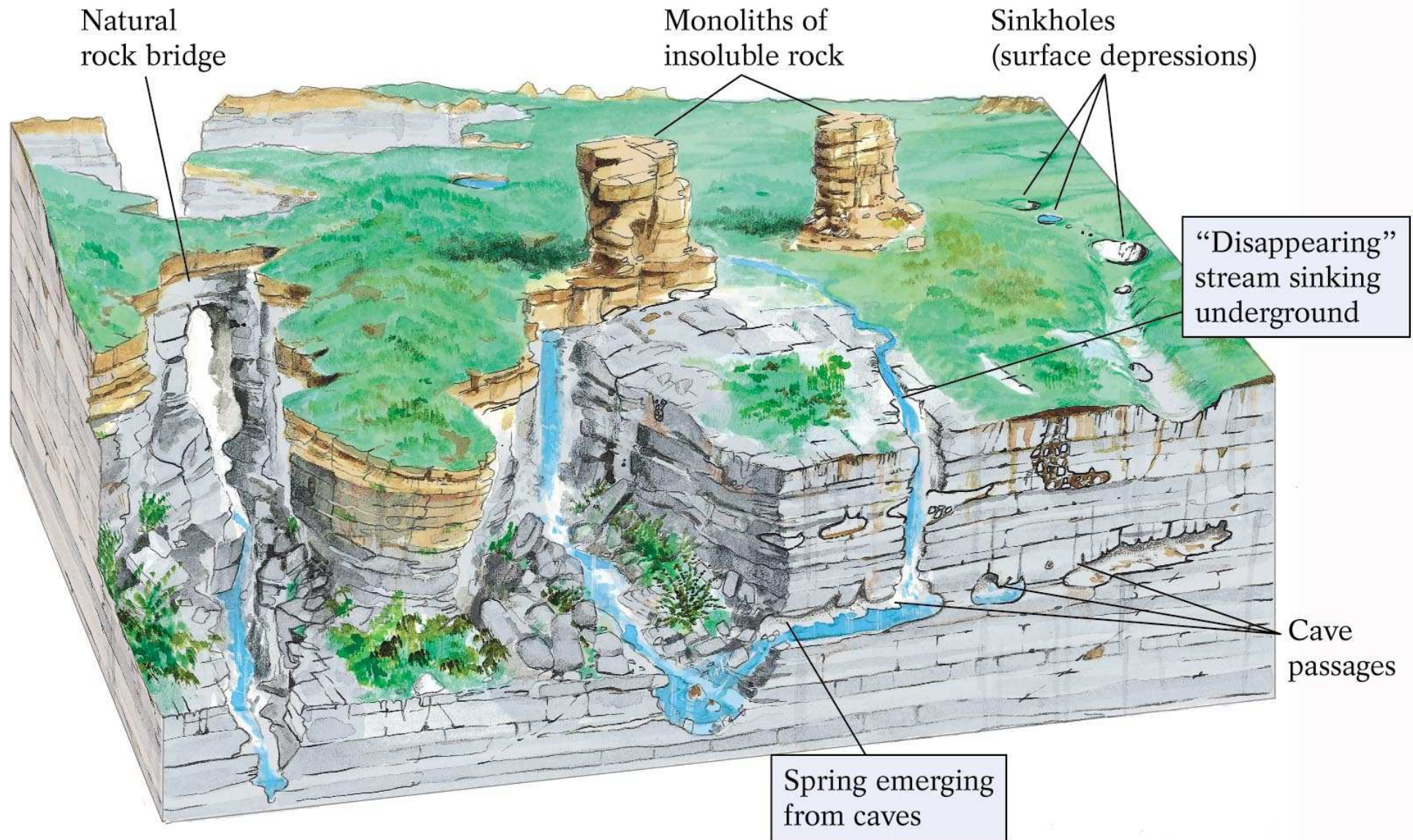

# State 1 of cave formation

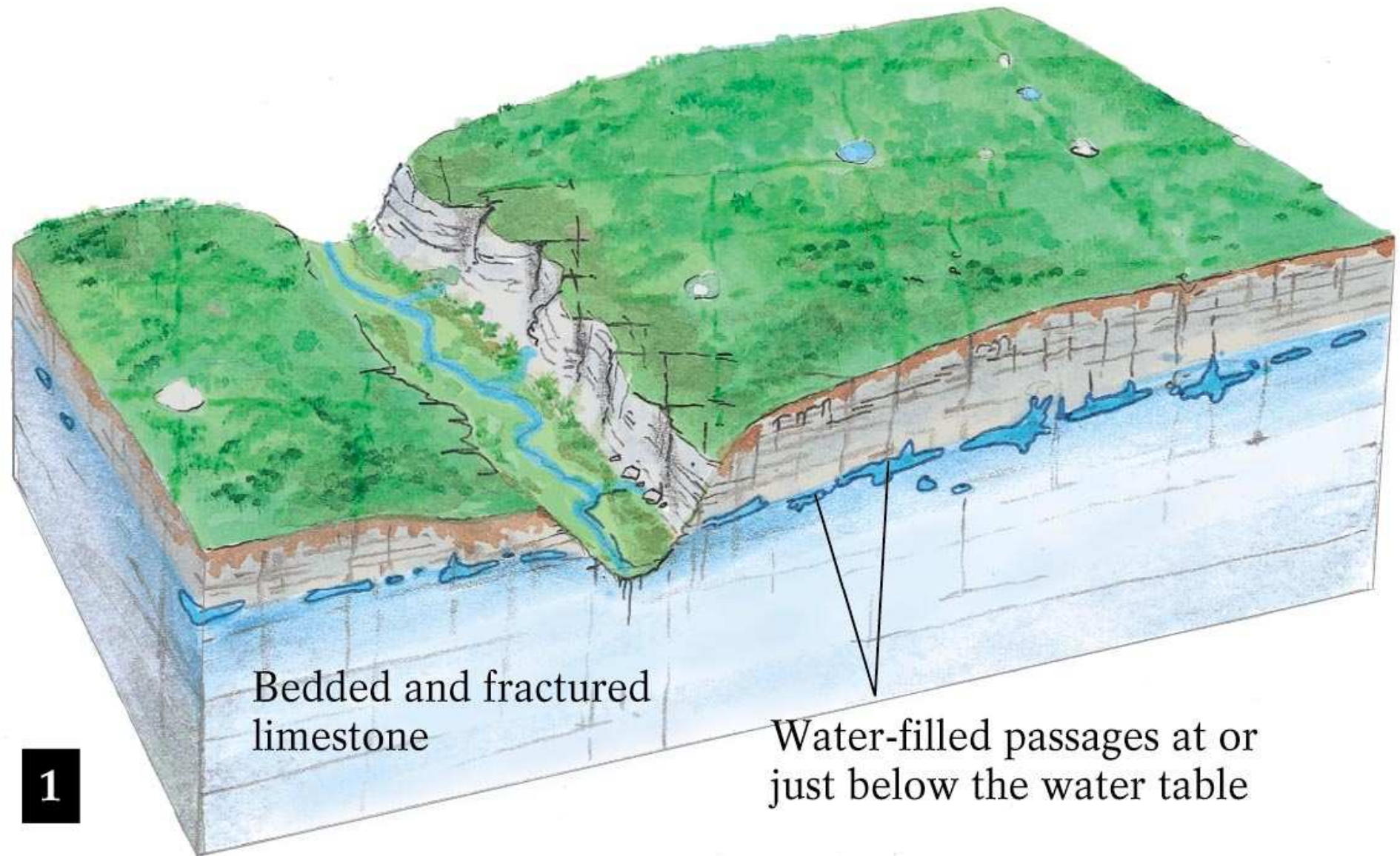



# State 2 of Cave formation

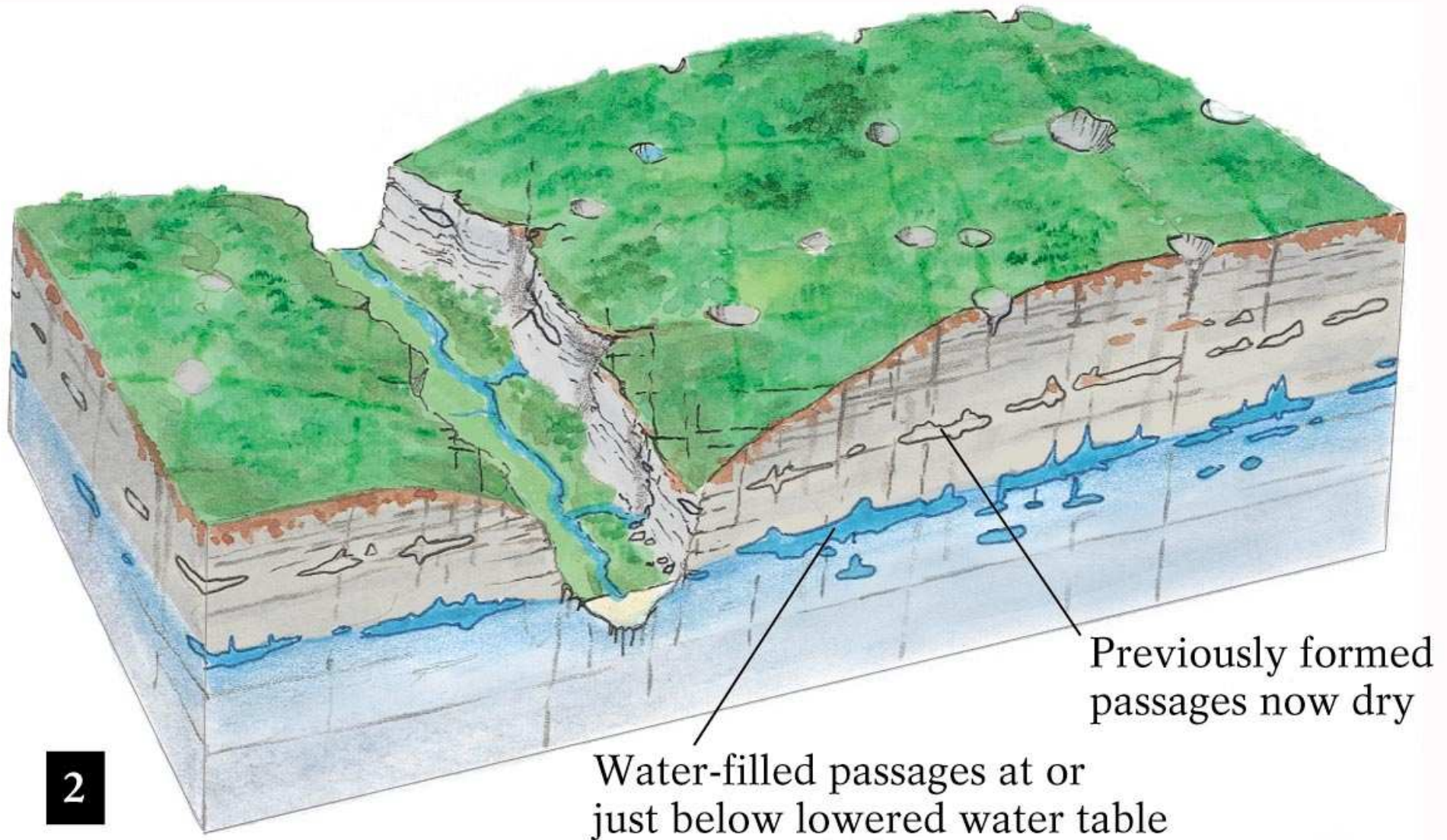

# Cave morphology

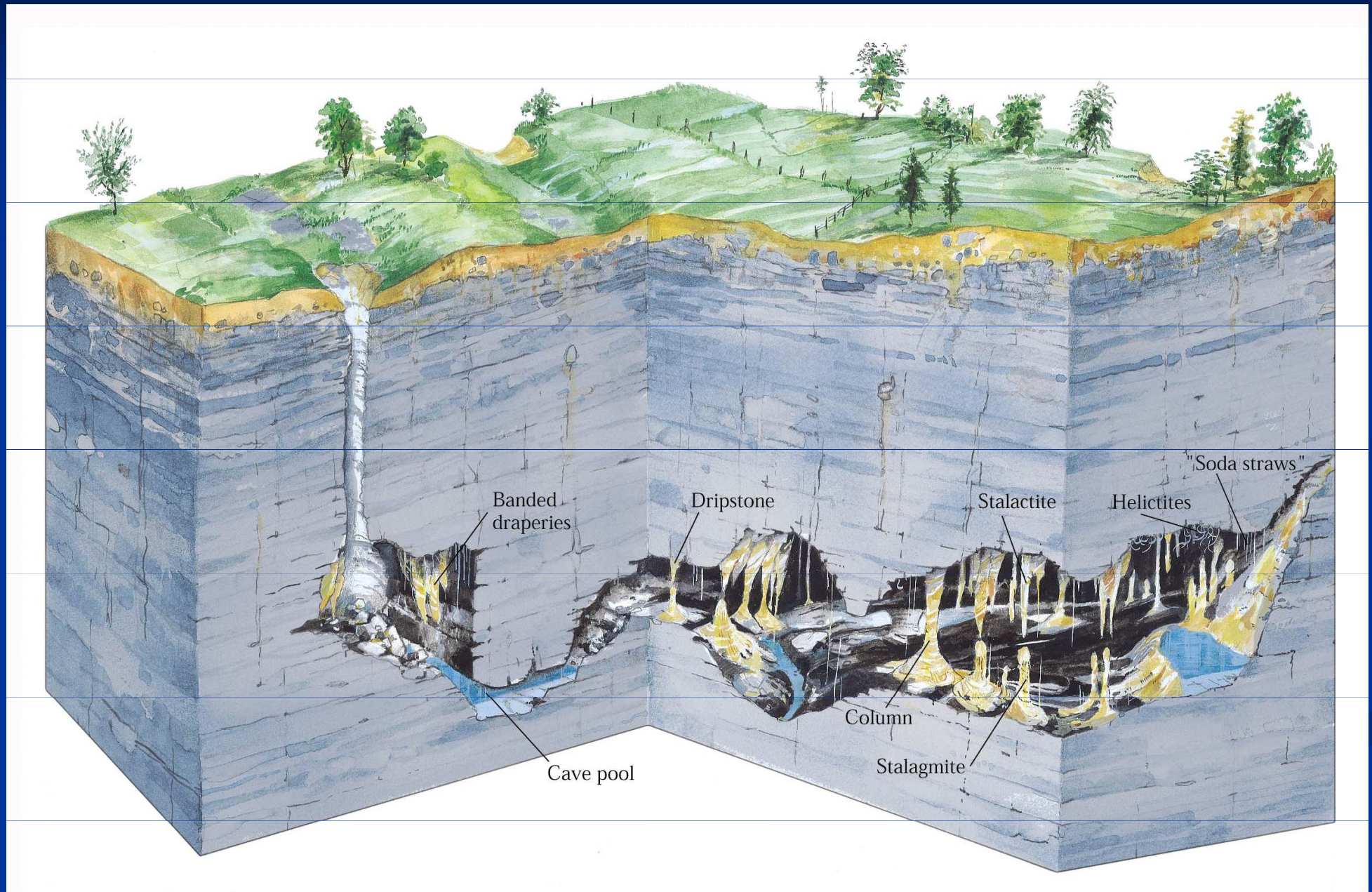

# Speleotémý

- Commonly known as stalagmites and stalactites.
- Like trees, speleothems form growth rings that develop over hundreds or thousands of years.
- Growth rate depends on amount and rate of precipitation and on cave temperature and humidity.

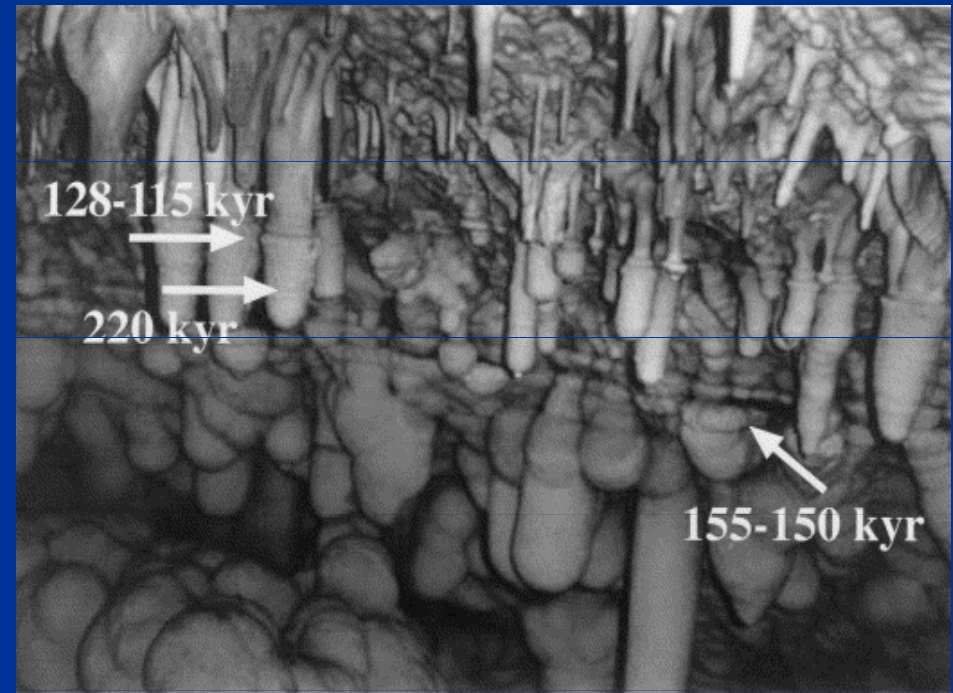

# Růst speleotémů a klima

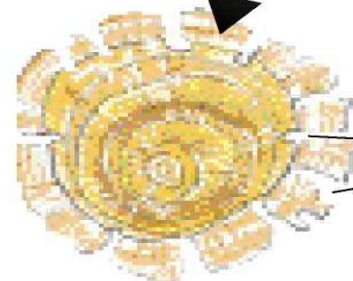
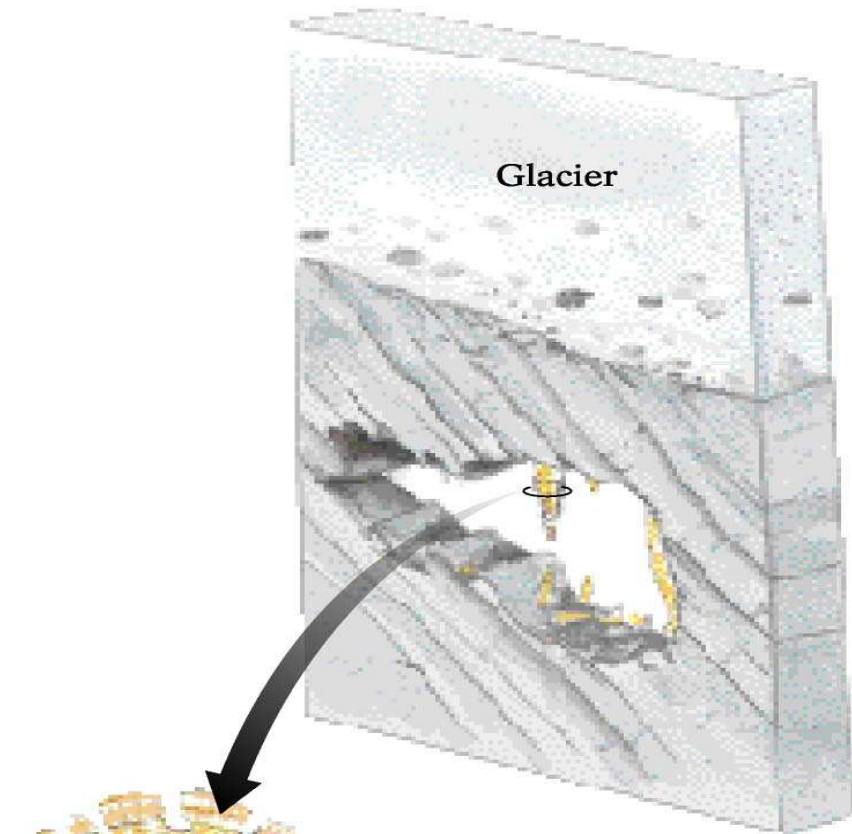

Surface of speleothem etched/cracked

Cross section of speleothem

**(a) Glacial or cold climate**

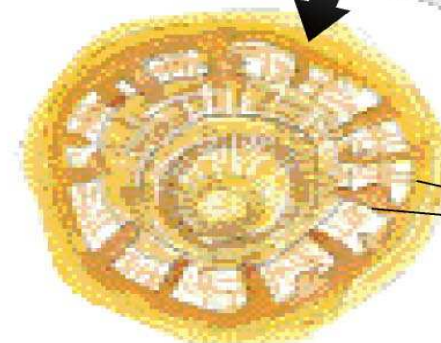
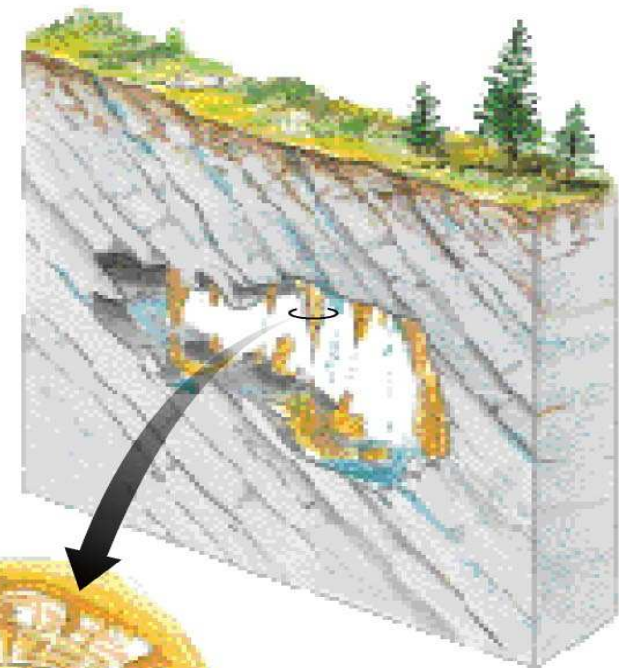

New growth layers on etched speleothem

Cross section of speleothem

**(b) Nonglacial or warm climate**

# Vzestup a pád mořské hladiny

Speleothem grows



No speleothem growth

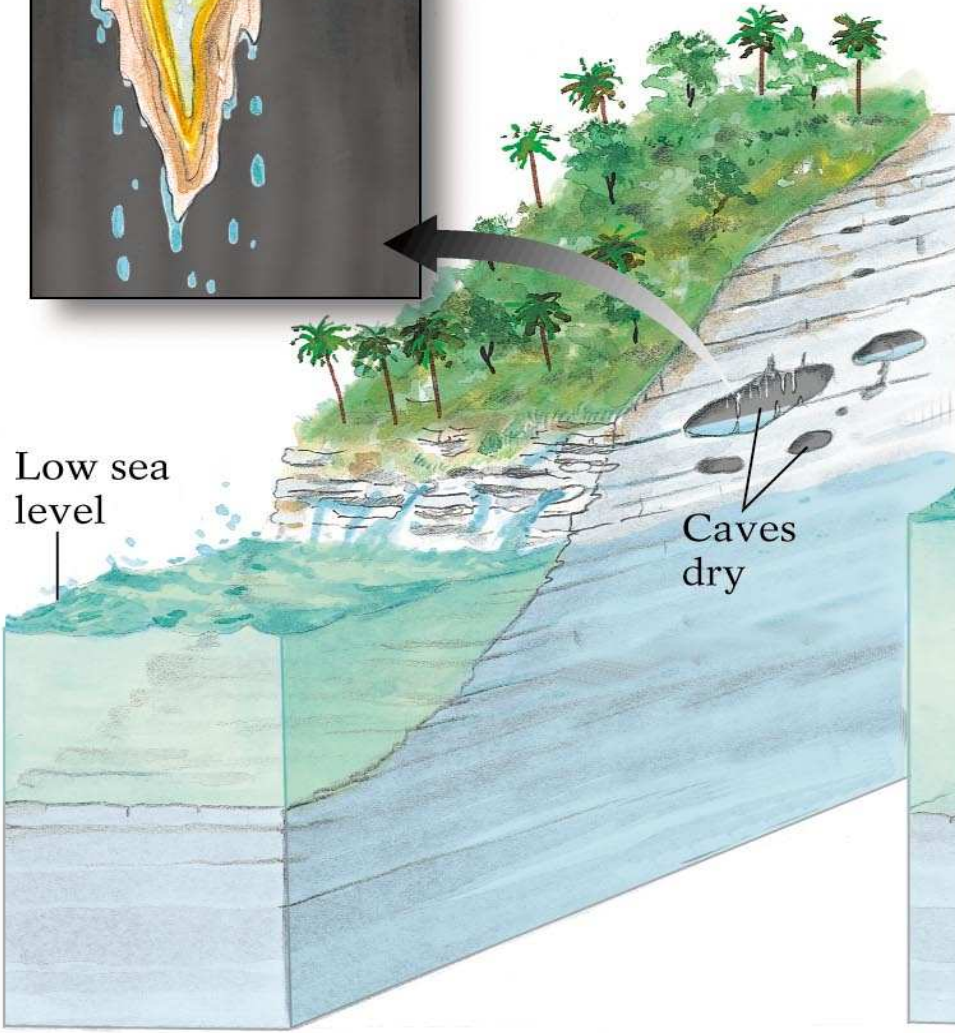
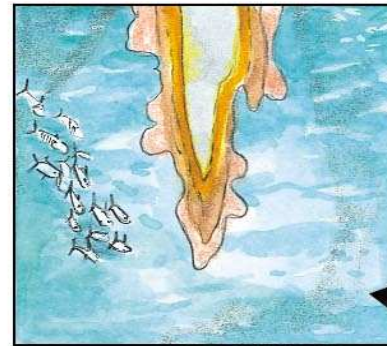

Low sea level

Caves dry

(a) Glacial period

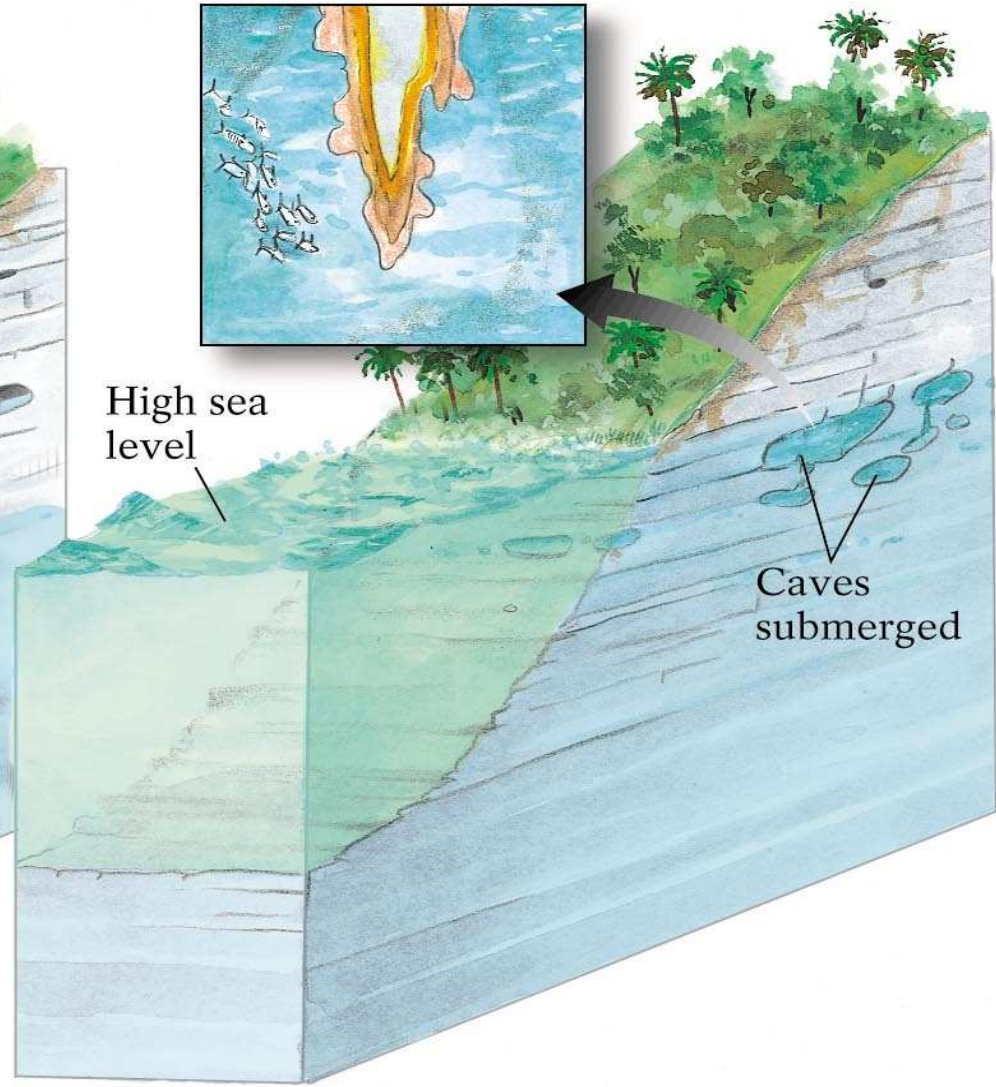

High sea level

Caves submerged

(b) Warm period

# Datování speleotémů

- Dating of speleothems is based on U-Th series.
- Theoretical precision:  $<1\text{‰}$  (10 yr in 10 kyr). Realistically, precision is better than 1% (100 yr in 10 kyr).

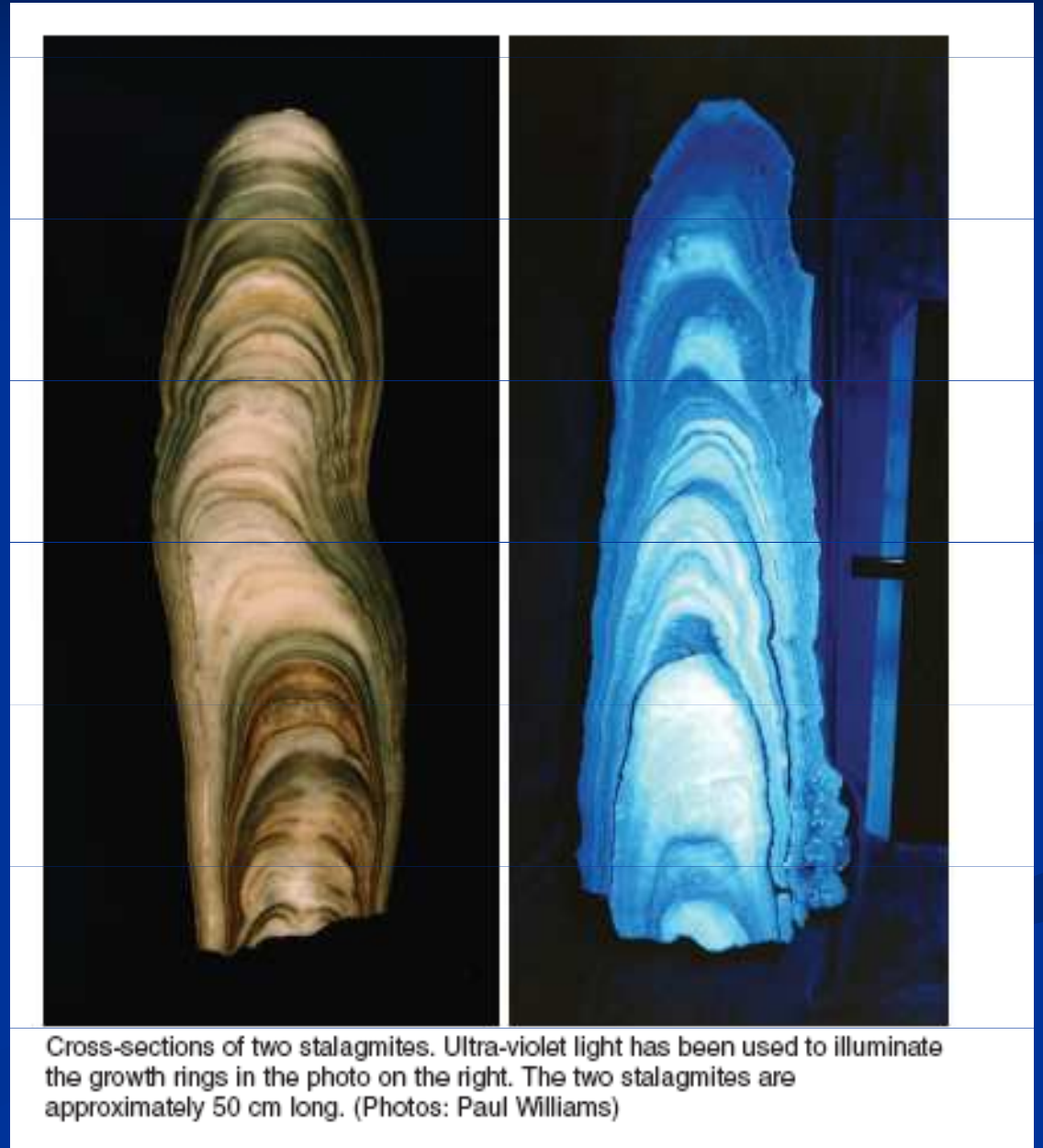

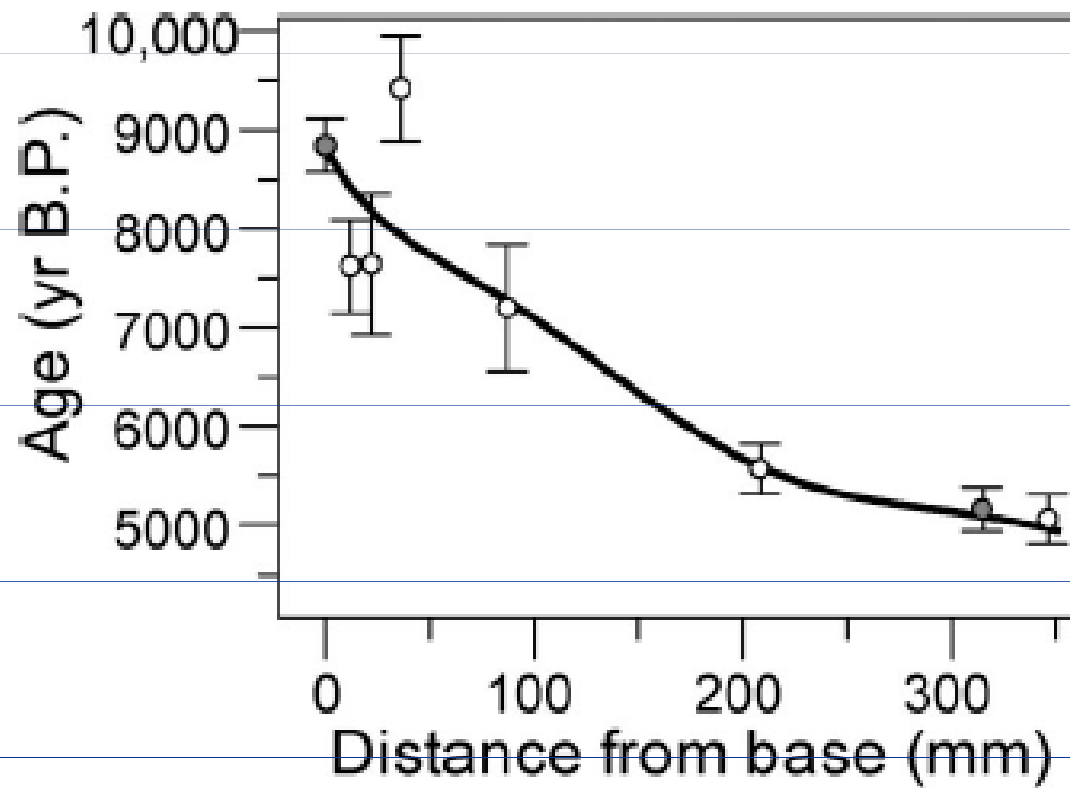

Figure 1. Age vs. depth plot for stalagmite V1. Filled circles are ages derived from three-point isochrons. Solid black line is fifth-order polynomial best-fit age model, visually weighted to most robust age determinations (isochron-based ages and those with smallest error bars).

# Speleotémy: použití v paleoklimatologii

- Carbon and oxygen isotopes of calcite reflect vegetation and climate, respectively.
- Growth rate appears to reflect precipitation.
- Recent techniques: Mg/Ca, radiocarbon.



# Speleotémy-izotopy kyslíku

- Oxygen isotopes in speleothem calcite ultimately come from rainwater.
- Some researchers argue that oxygen isotope ratios in rainwater depend on temperature.
- Others argue that the isotope ratios depend on rainfall amount, particularly in tropical regions.
- Also, some argue that the isotope ratios depend on evaporation taking place in soils or in the cave.

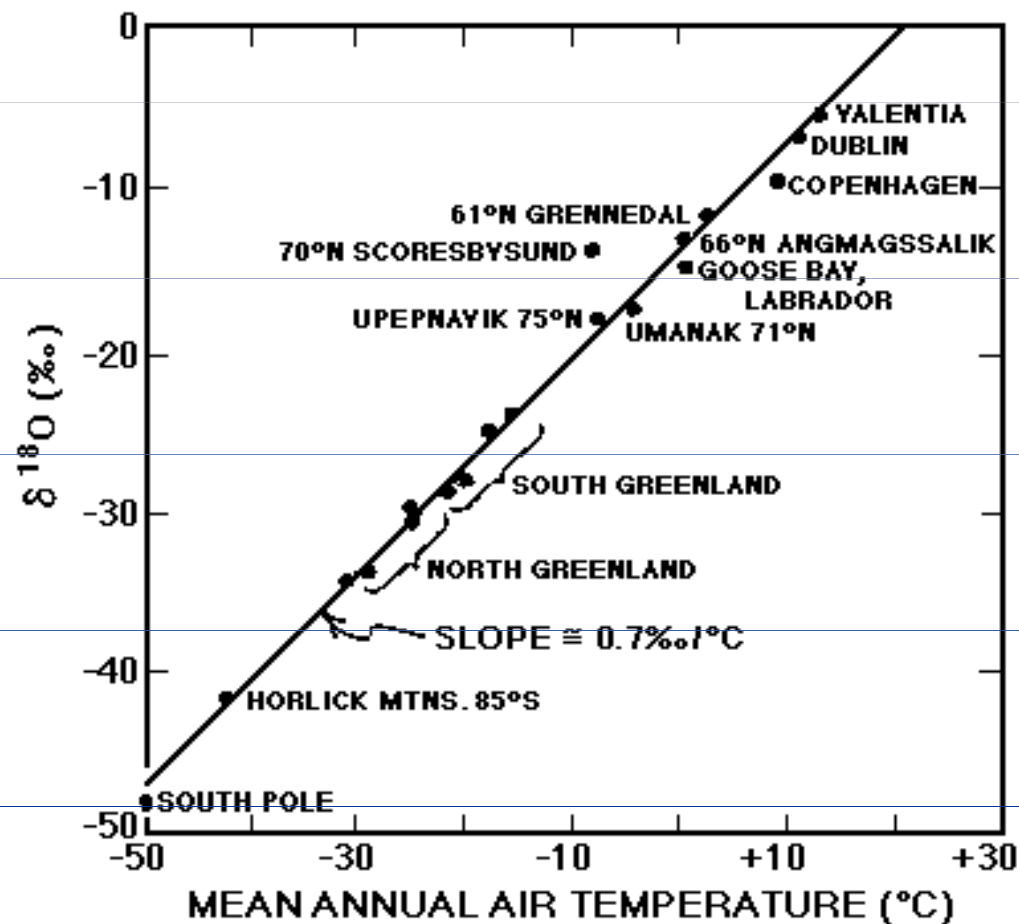

$$\delta^{18}\text{O} = \frac{^{18}\text{O}/^{16}\text{O} \text{ sample} - ^{18}\text{O}/^{16}\text{O} \text{ std.}}{^{18}\text{O}/^{16}\text{O} \text{ std.}} \times 1000$$

Broecker, W.S. The Glacial World According to Wally,  
 Copyright © 1993 by Eldigio Press.  
 Reproduced by permission.

# Speleotémy-izotopy kyslíku

- Colder climate = lower  $\delta^{18}\text{O}$  values.
- Speleothem  $\delta^{18}\text{O}$ -MAT relationship is  $\sim 0.35$  per mil/ $^{\circ}\text{C}$ .

Coldest

Warmest

$\sim 4^{\circ}\text{C}$

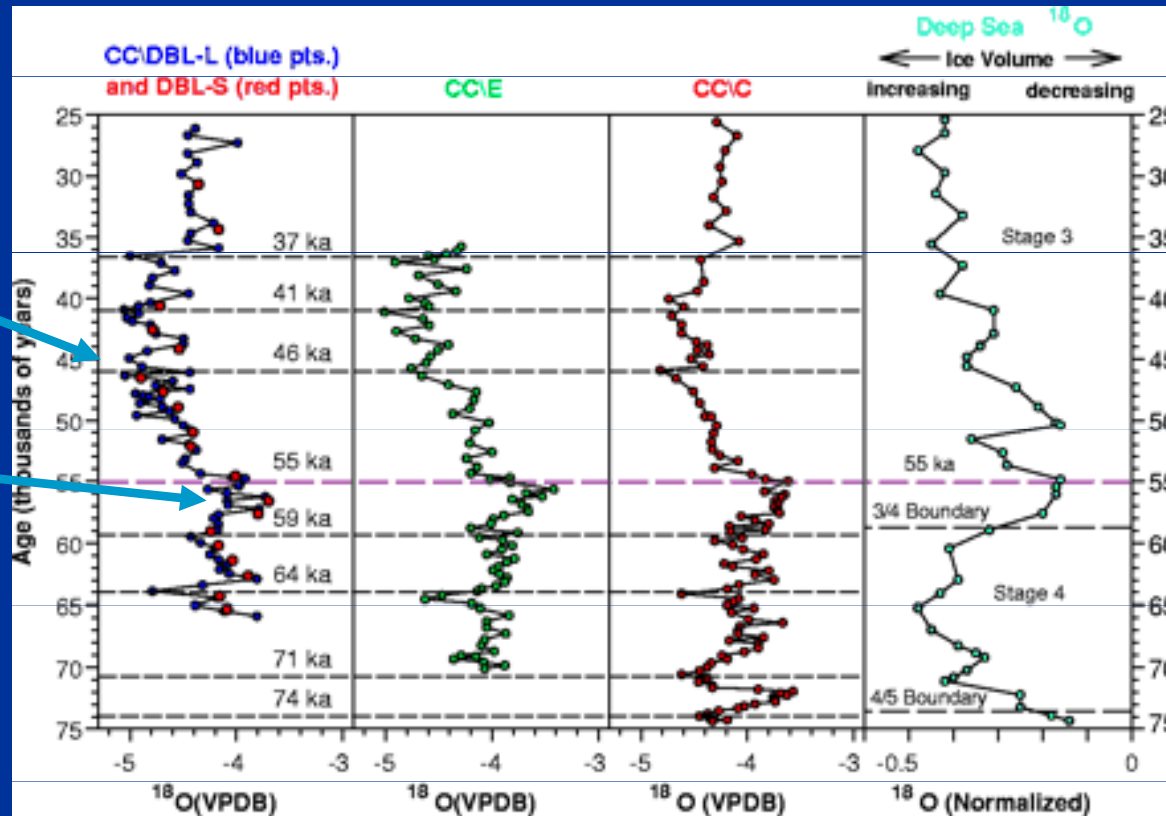

Dorale et al., 1998.

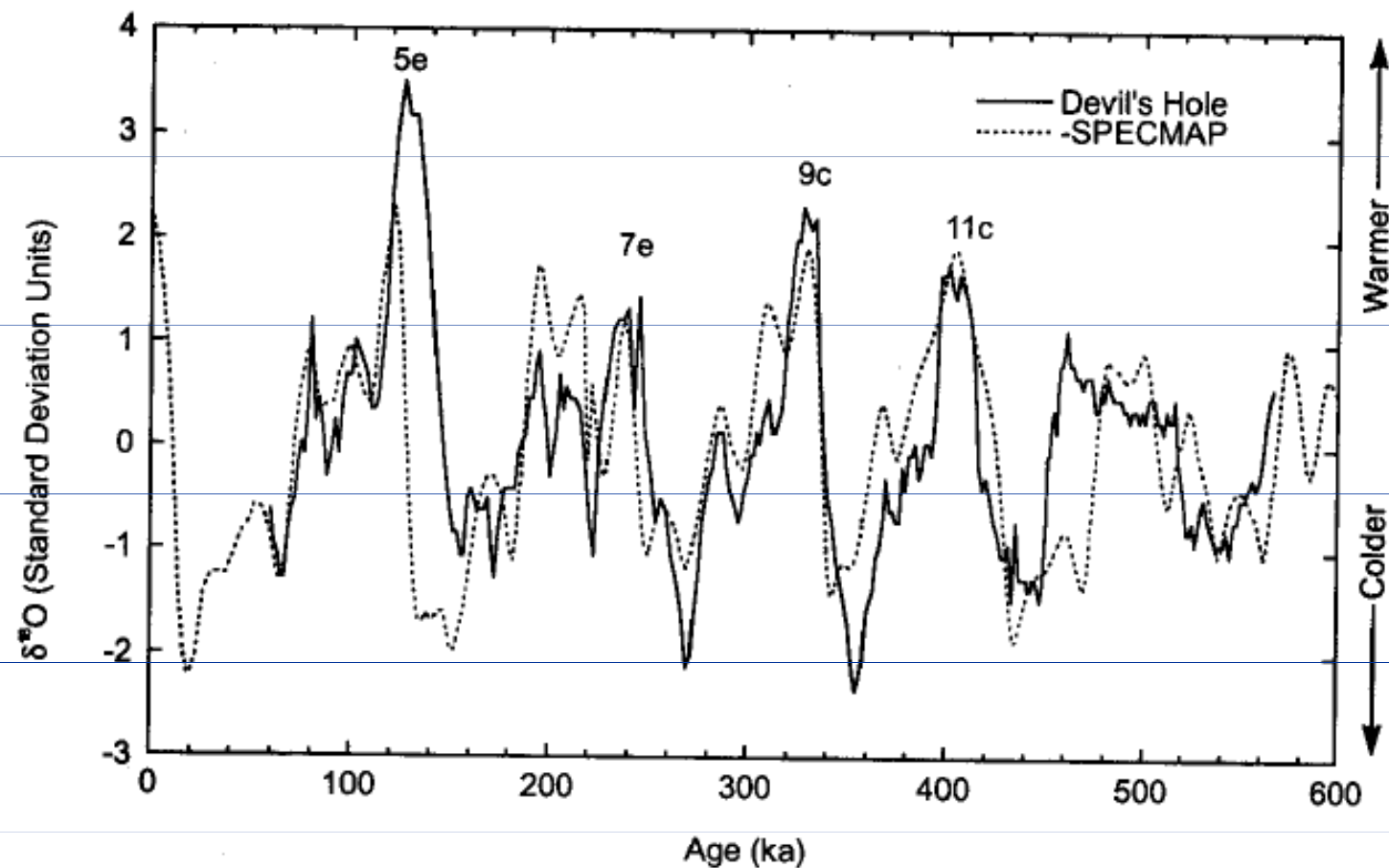

**FIGURE 7.32** The  $\delta^{18}\text{O}_c$  record in a calcite vein from Devil's Hole, Nevada compared to the SPECMAP marine isotope record. Selected marine isotope substages are numbered. Values are expressed as departures from the overall mean of each series, in standard deviation units (computed over the full record). The value of zero thus represents the mean for each record. Note that the sign of the SPECMAP time series has been reversed so that interglaciations appear as peaks (Winograd *et al.*, 1997).

# Speleothem-carbon isotopes

- It appears that speleothem carbon isotopes primarily come from plants above the cave.
- Based on photosynthetic pathways, there are two major groups of land plants: C3 and C4 plants.
- **C4 plants:** warm season grasses adapted to high temperatures and relatively drier climates.
- **C3 plants:** Trees, shrubs, and cool season grasses.

# Speleothem-carbon isotopes

- C4 grasses show high  $\delta^{13}\text{C}$  values.
- C3 plants show low  $\delta^{13}\text{C}$  values.
- Speleothem high  $\delta^{13}\text{C}$  values are then interpreted to indicate more C4 grasses.

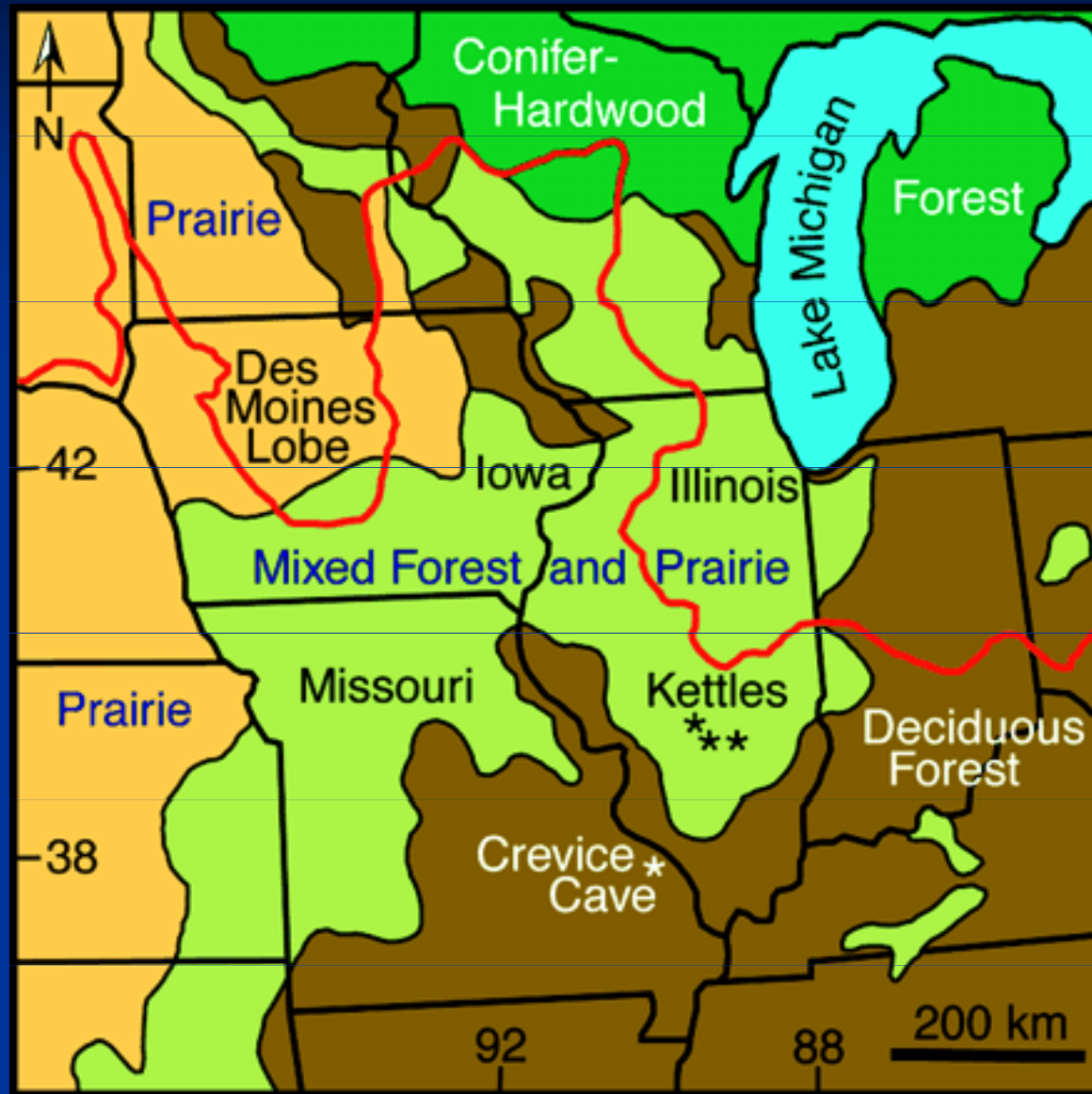

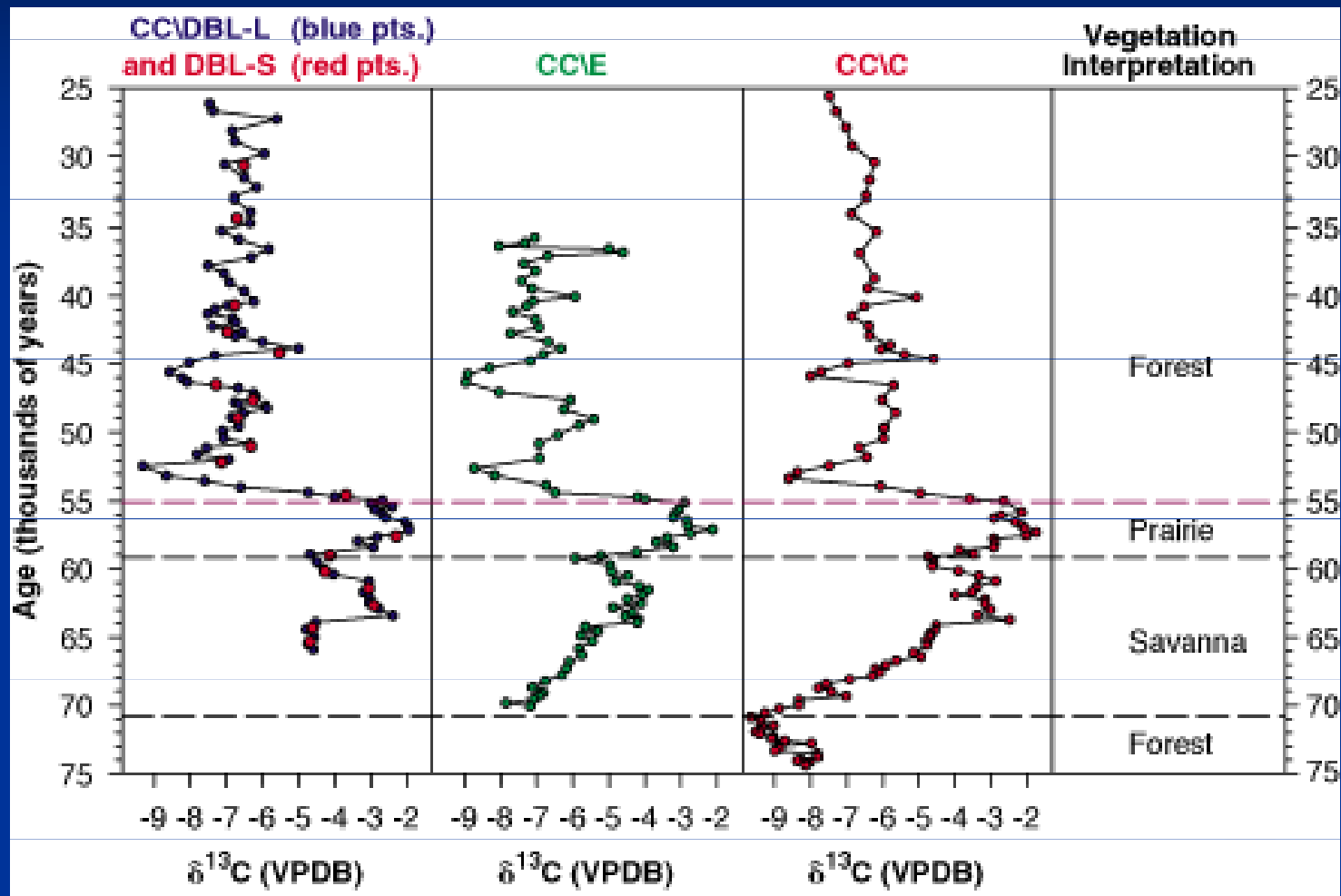

Crevice Cave, MO (Dorale et al., 1998)



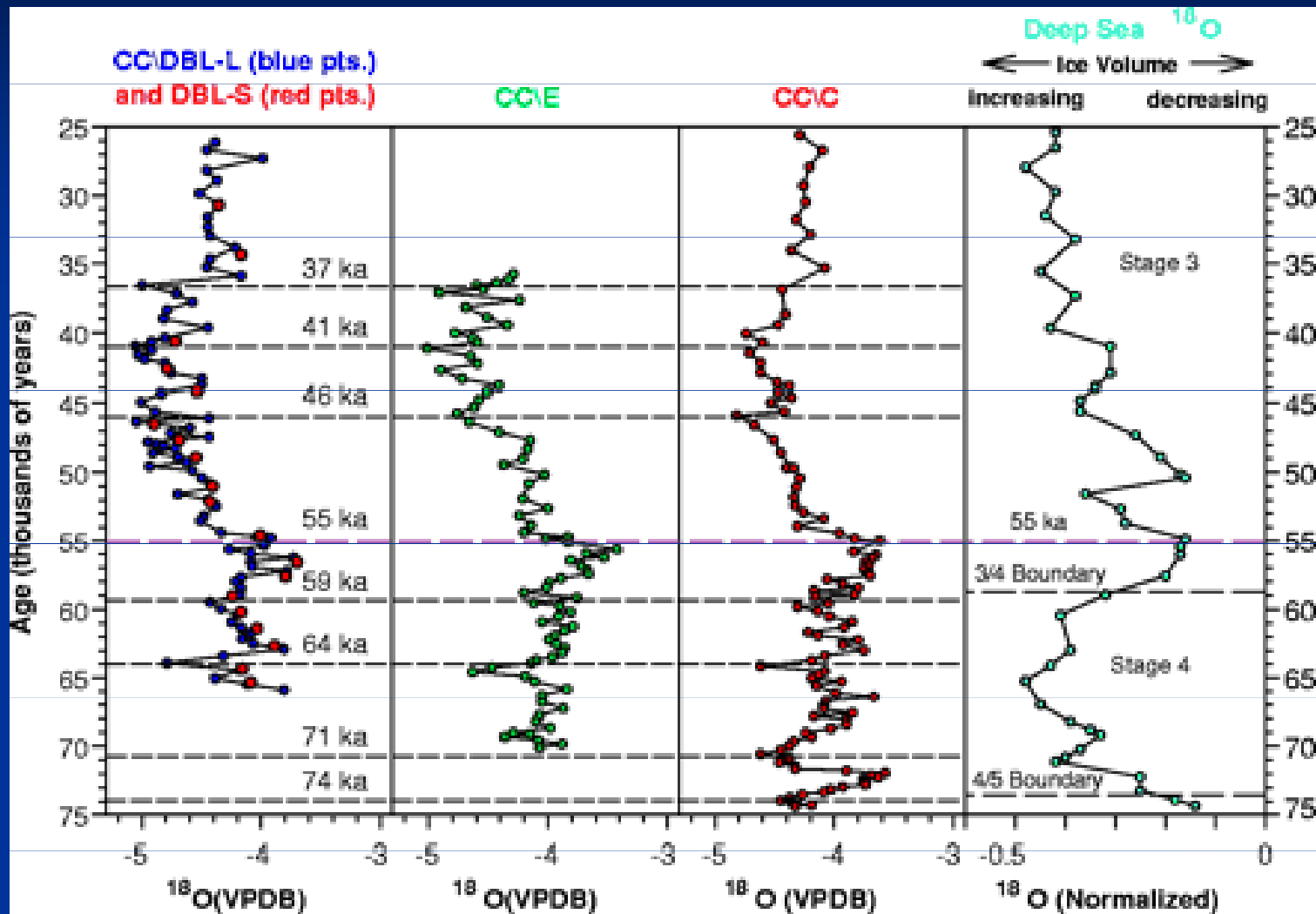

Crevice Cave, MO (Dorale et al., 1998)

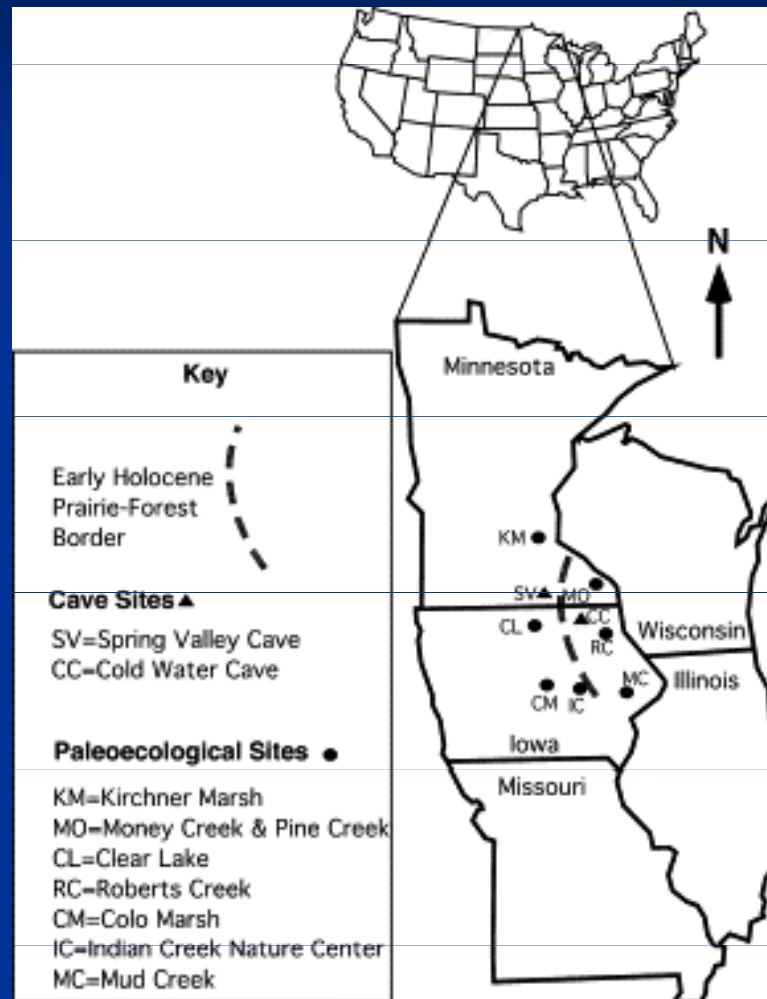

### Speleothem Isotopes from Sites on Opposite Sides of the Ecotone

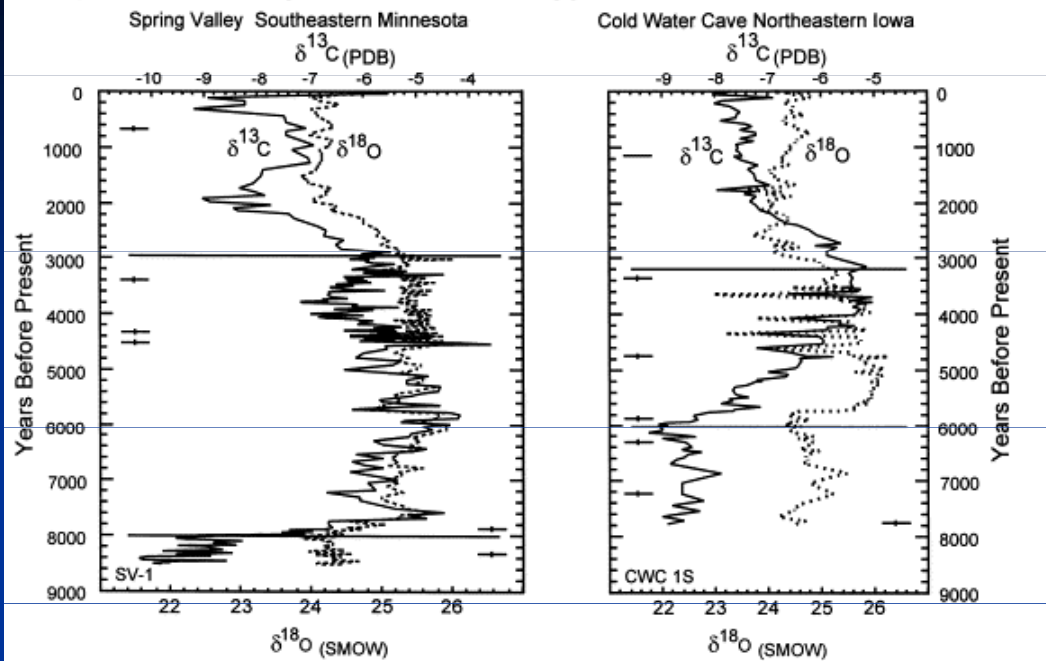

### Tree and Herb Pollen from Sites on Opposite Sides of the Ecotone

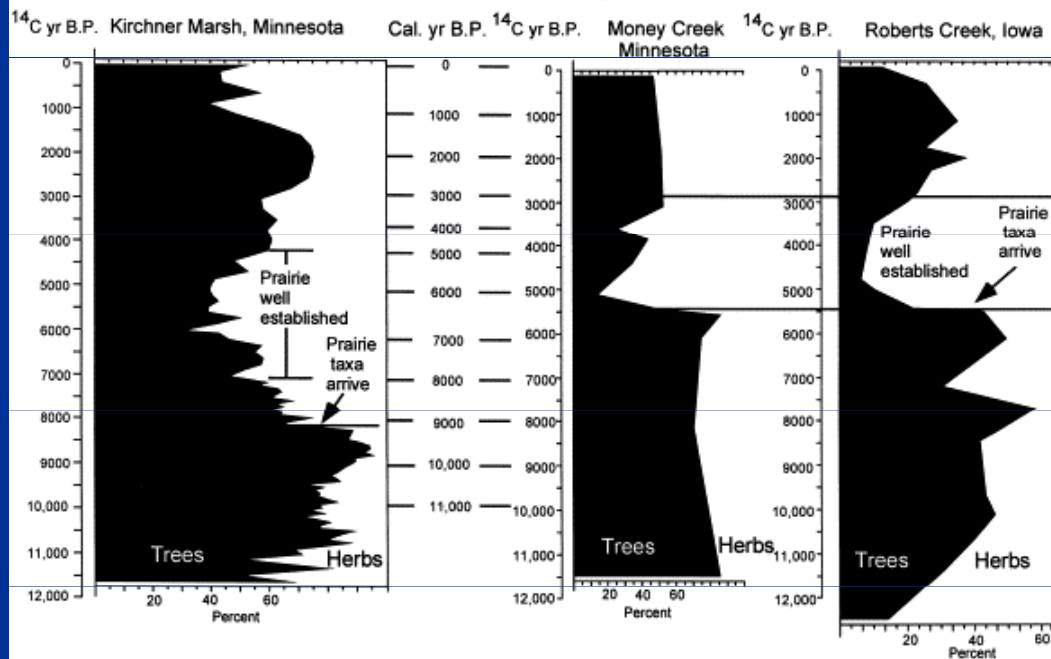

# SVAHOVÉ SEDIMENTY

- G - cirque glacier with moraines
- T - talus
- GR - relics of older glaciation moraines
- BF - block field
- S - scree
- AF - alluvial fan
- TC - talus cone
- L - landslide

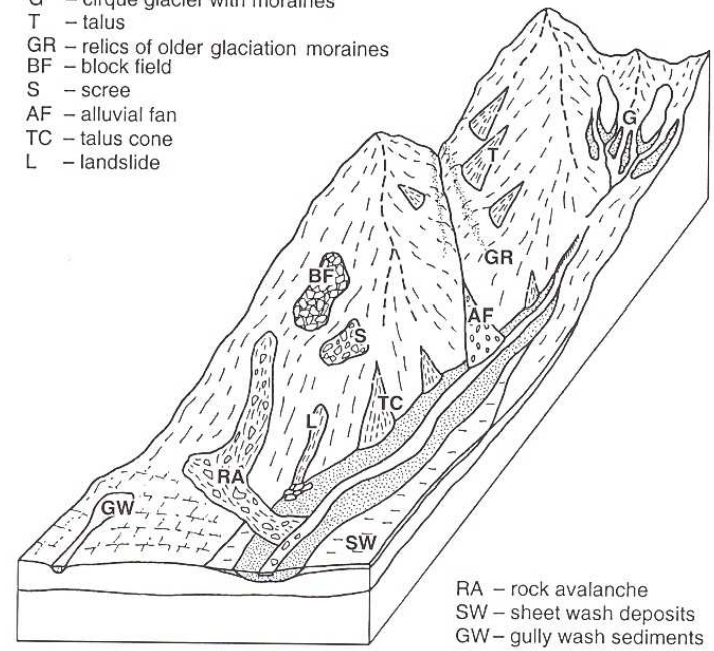

- RA - rock avalanche
- SW - sheet wash deposits
- GW - gully wash sediments

Figure 35. Types of deposits in mountain and hill landscape (SELBY 1994, modified).

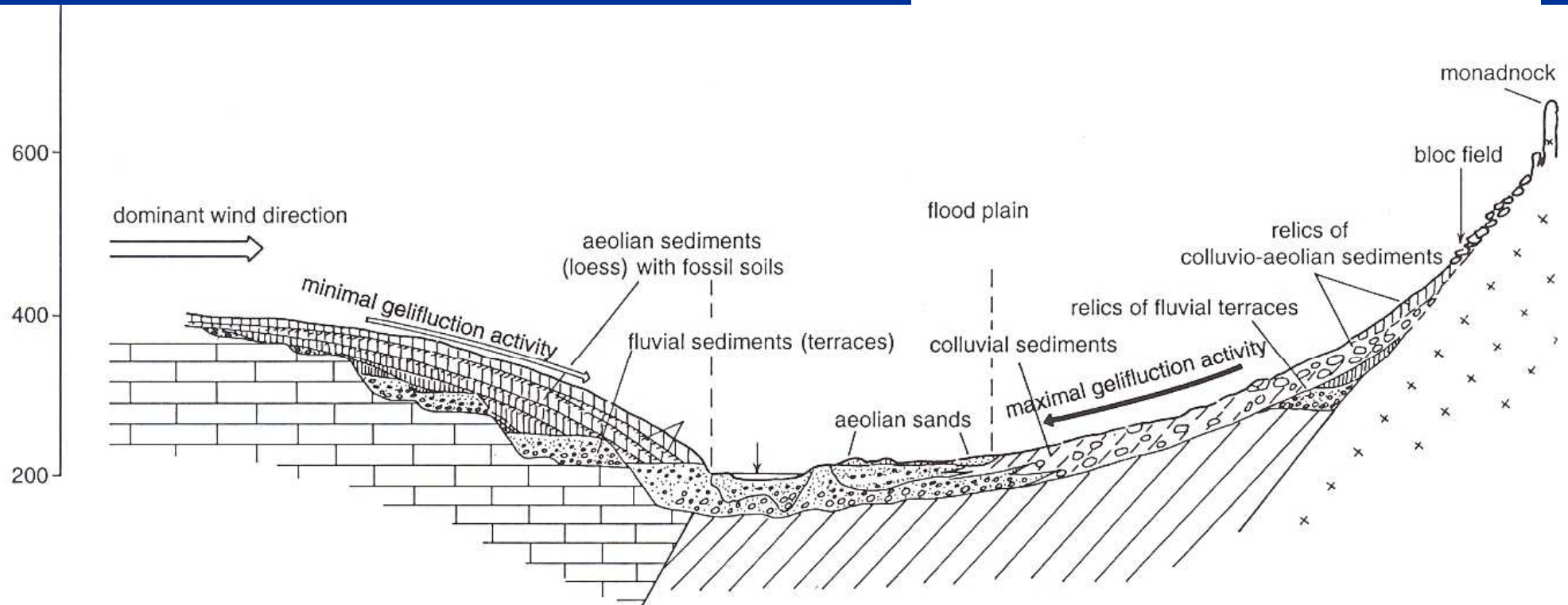

# Kamenná moře

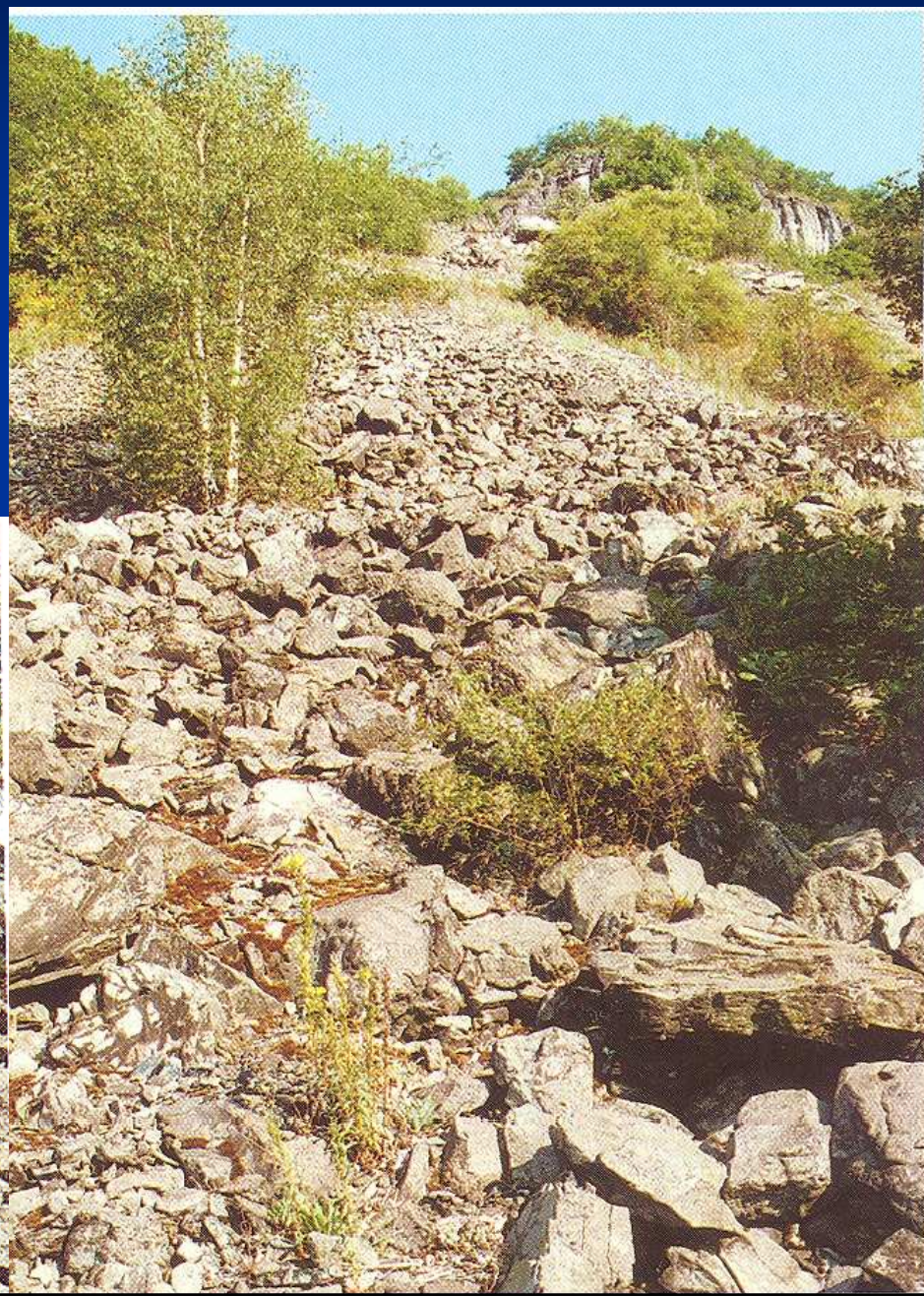

# Sesuvy (debris flows), deluvia

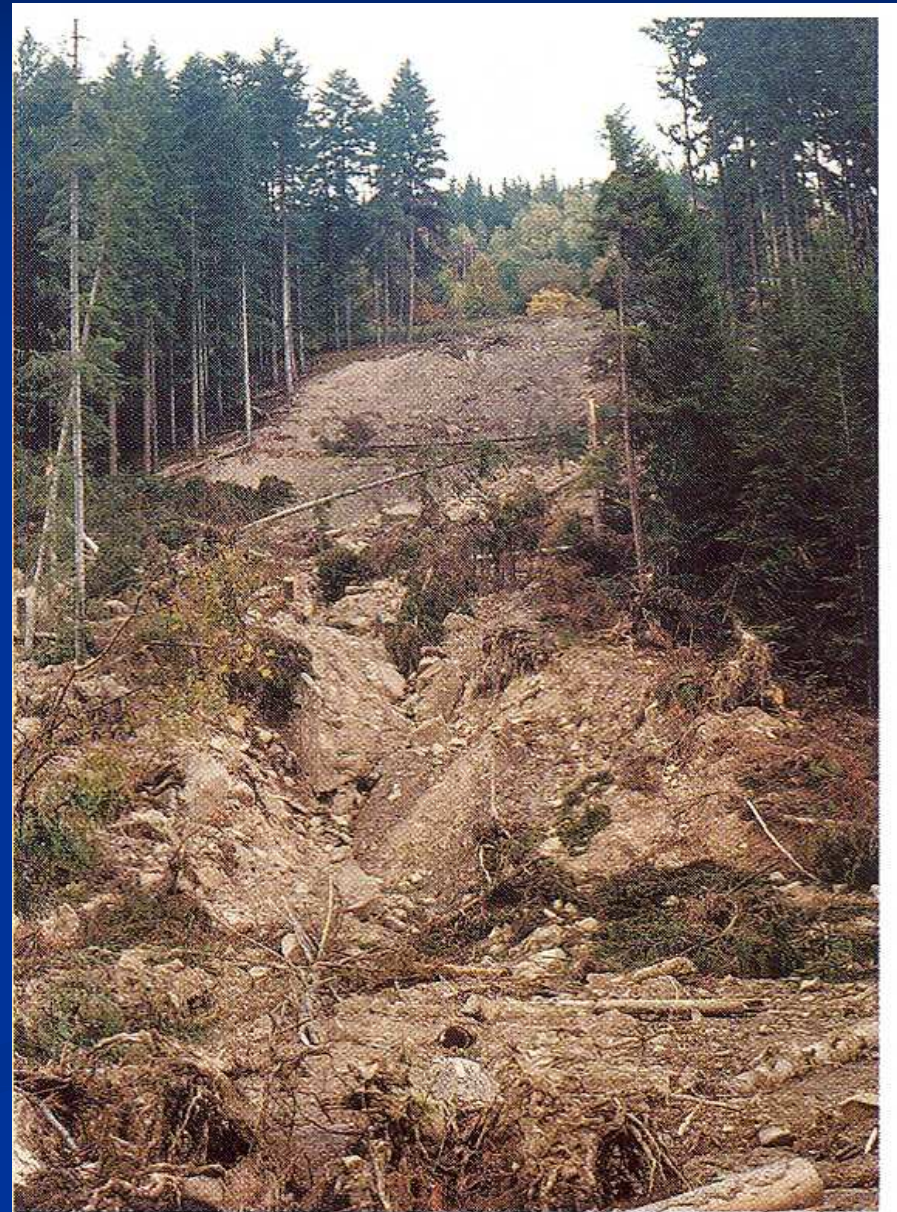
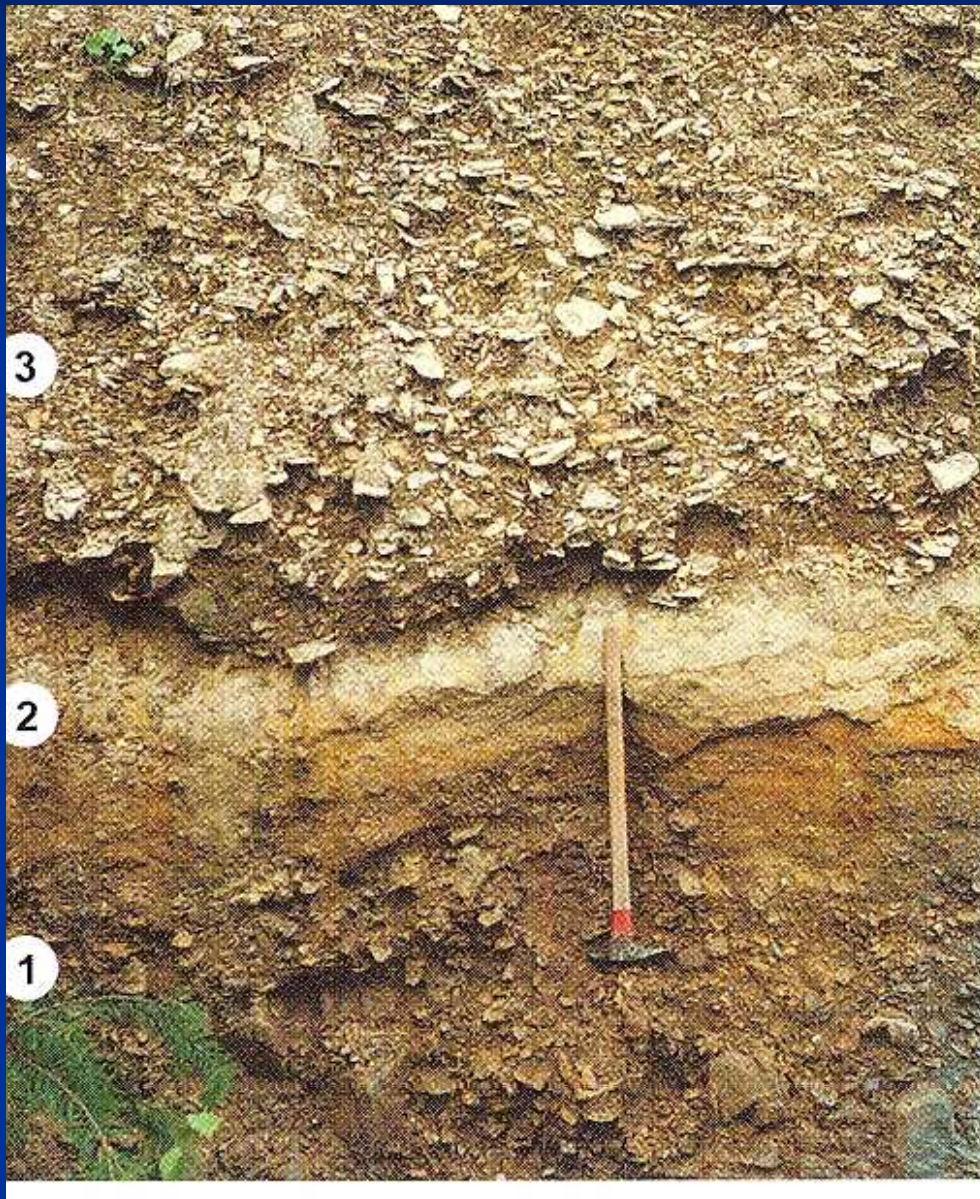

# Soliflukce



## 254. Gravitational creep gelifluction sediment

Coarse sand (totally disintegrated syenite porphyry) with “floating” stones and blocks of less weathered parent rock; the gelifluction process is marked by stratification with distinct planes of discontinuity

*Stratigraphy:* Pleistocene

*Locality:* Bošice (Prachatice District)

*Photo by:* M. Růžička 1997



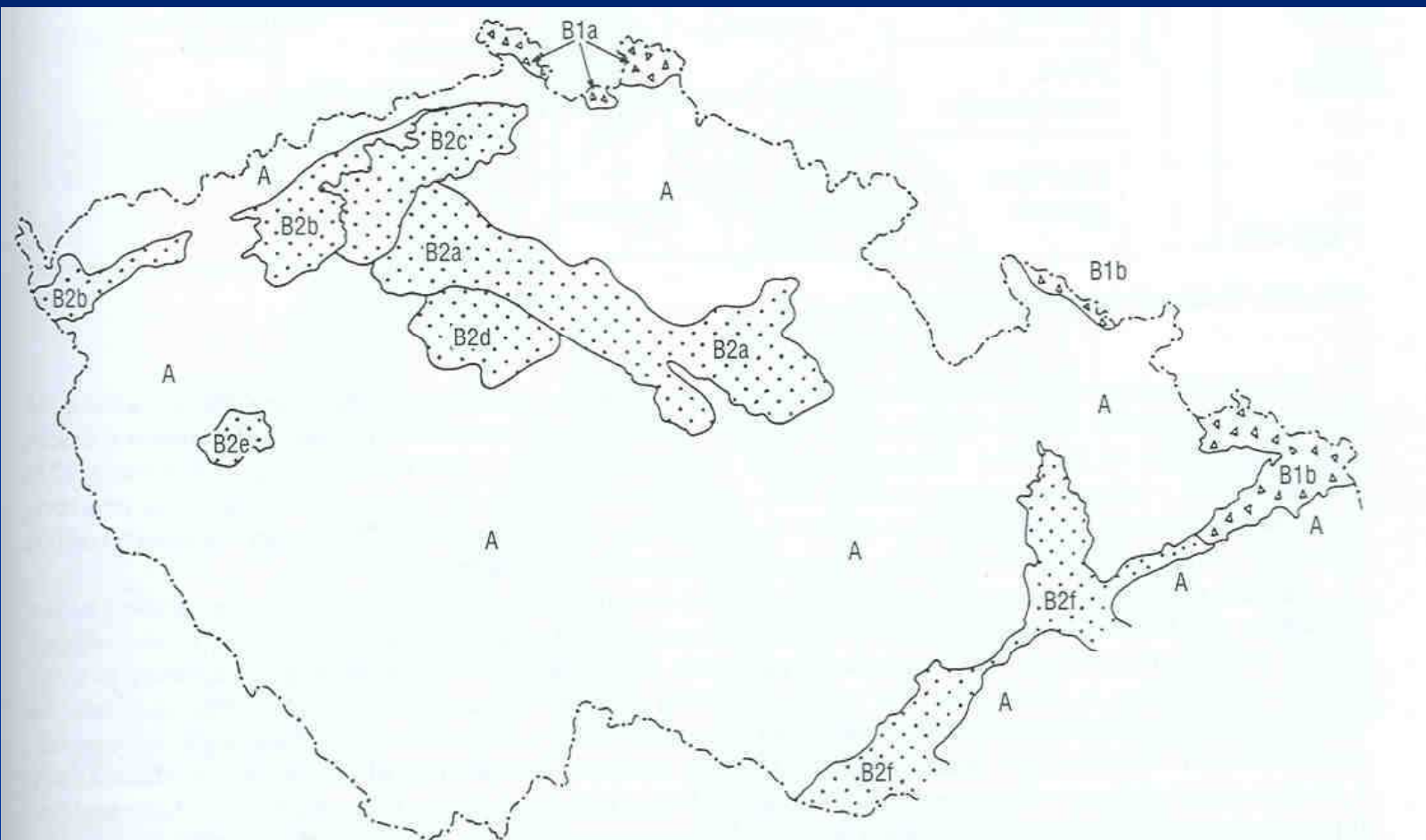

Obr. 262. Kvartér Českého masivu. A – denudační oblasti; B – akumulační oblasti: B1a – oblast kontinentálního zalednění severních Čech, B1b – oblast oderská. Extraglaciální oblasti: B2a – Polabí, B2b – podkrušnohorské pánve, B2c – České středohoří, B2d – Pražská plošina, B2e – Plzeňská kotlina, B2f – moravské úvaly (podle usnesení Čs. stratigrafické komise, J. Tyráček – M. Růžička 1992).