

Persistent organic pollutants - sample analysis



Jana Klánová

klanova@recetox.muni.cz

1. Environmental analytical chemistry

Specific features, general scheme

2. Sampling

Sampling plan, strategy, sampling protocol, sample size and quality, transport, storage

3. Sample preparation

Extraction of solid (Soxhlet, automatic extraction, MAE, ASE, SFE) and liquid (L-L, SPE, SPME, head-space) samples, fractionation and clean-up (column chromatography, gel permeation)

4. Analytical techniques

Chromatographic techniques, principals, instrumentation, HPLC, GC, GC-MS

5. Persistent organic pollutants

Priority pollutants (PCBs, PCDDs/Fs, PAHs, pesticides), emerging pollutants (SCCPs/MCCPs, antibiotics, degradation products)

6. QA/QC

Calibration, limit of detection and quantification, internal and recovery standards, blanks, certified reference materials, interlaboratory calibration tests, method validation and verification, GLP

Environmental science brings together scientists from many fields to perform complex studies of various environmental compartments, processes, and interactions.

They may include:

- **water and food quality monitoring**
- **level of contamination of environmental compartments**
- **ozone depletion as a result of the presence of certain chemicals in the atmosphere**
- **regional contamination studies**
- **evaluation of the impact of local sources of pollution**
- **toxicity of chemical compounds as a function of their chemical structure**
- **impact of chemical substances on living organisms**
- **bioavailability**
- **bioaccumulation**
- **biotic and abiotic transformations**
- **transport of pollutants in the environment**
- **global fate of pollutants**
- **international directives and their impact on the global contamination**
- **remediation actions and their quality control**
- **sustainable development**

Most of them involve the chemical analysis as one of necessary steps.

Environmental analytical chemistry challenges:

- **international conventions focus attention on the new groups of pollutants**
- **old contamination brings the problem of residue analyses**
- **lowering limits as well as environmental levels require low detection limits**
- **large-scale monitoring is crucial for the studies of the long-range transport**
- **development of new sampling techniques is encouraged**
- **increasing number of samples stresses the need for automatization**
- **fate studies require understanding of distribution processes and equilibria**
- **photochemical reaction complicate the sampling and data interpretation**
- **consideration of both, analytical and toxicological data is important for successful risk assessment**
- **methods of biochemistry and molecular-biology are often implemented in toxicological studies**
- **international studies require standardization of all procedures**

There are several steps necessary for environmental contamination control:

- **problem definition**
- **screening of the situation, data interpretation**
- **evaluation of the extent of the problem**
- **selection of the best procedure to monitor the situation**
- **evaluation of the present state and future development**
- **exposure evaluation and risk assessment**
- **suggestion of correcting measures or remediation activities**
- **new directives to control the situation**
- **monitoring designed to evaluate effectiveness of measures**

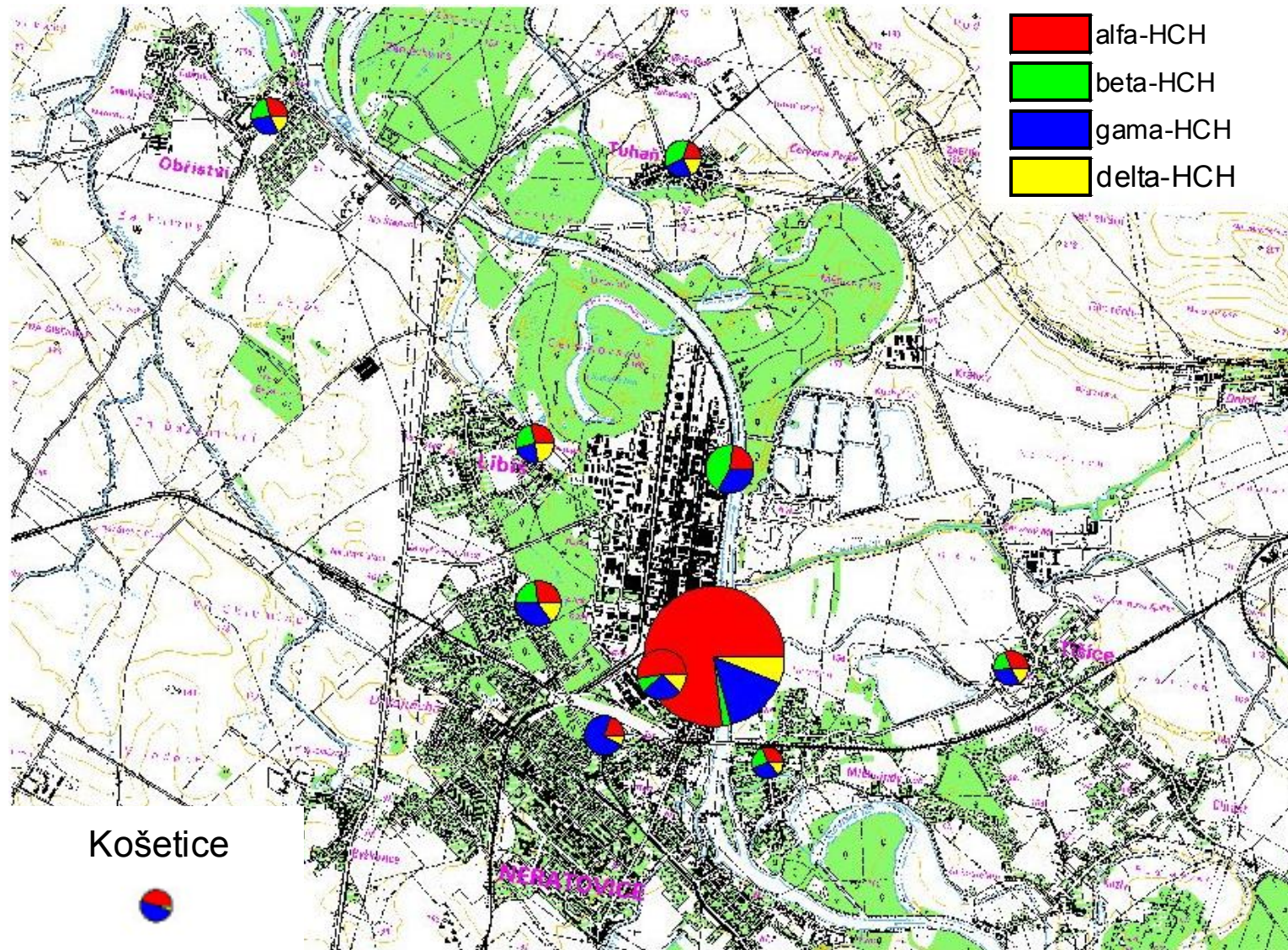

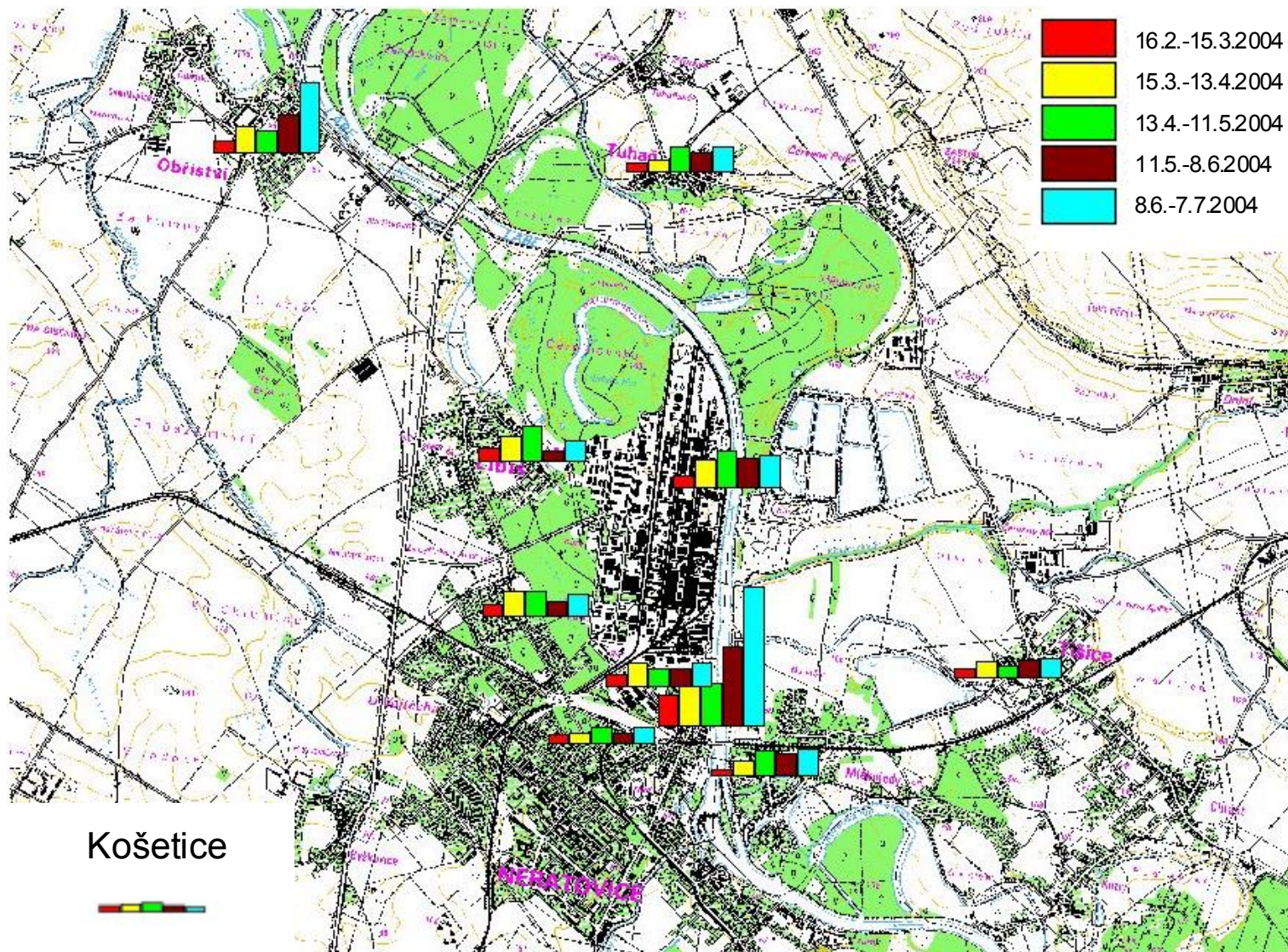

Specific problems of environmental analysis

- **low homogeneity of samples (soil)**
- **low stability of samples (biota)**
- **various matrices (methods for extraction of analytes from matrices)**
- **wide range of analytes (method development)**
- **wide range of concentration (robust methods)**
- **monitoring on the levels close to the detection limits (high deviations)**
- **risk of secondary contamination**
- **price of ultra-trace analysis (instrumentation, chemicals, standards)**

General scheme of environmental analysis

- Sampling**
- homogenization
 - conservation
 - transport
 - storage

- **Sample preparation**
 - extraction
 - clean-up
 - selective elution
 - concentration
 - derivatization

- **Sample analysis**
- **Data interpretation**

Sampling – documentation required

sampling plan (a goal, selection of sampling sites, analytes, sampling method, number of samples, sampling period and frequency, safety procedures), seeks the balance between the value of data and its price

- **standard operational procedure** for sampling various matrices (sampling devices, steps involved in collecting of representative sample -homogenous, of reasonable size and stability, quality of transport and storage)
- **sampling protocols** (name and number of the sample, sampling site, matrix, date of sampling, local conditions and measurements, methods, sample size, responsible person)

Sampling site 1. DEZA

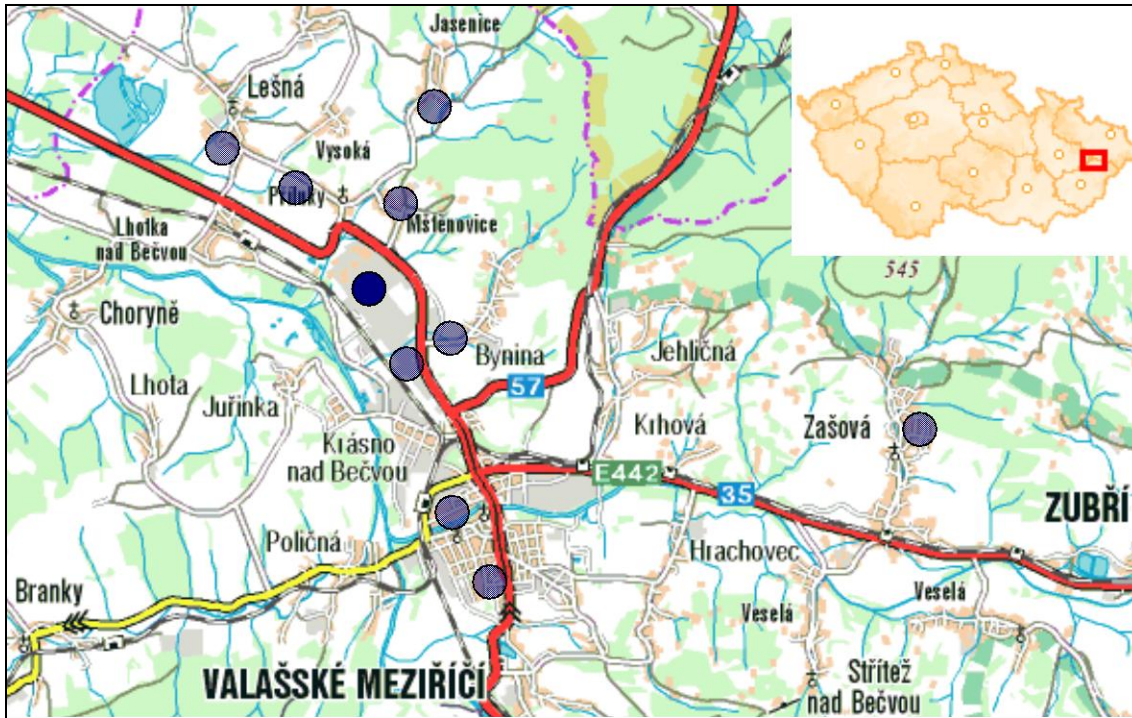

GPS:

49°29'48''

17°57'14''

245 m

Local conditions:

Sampling Techniques

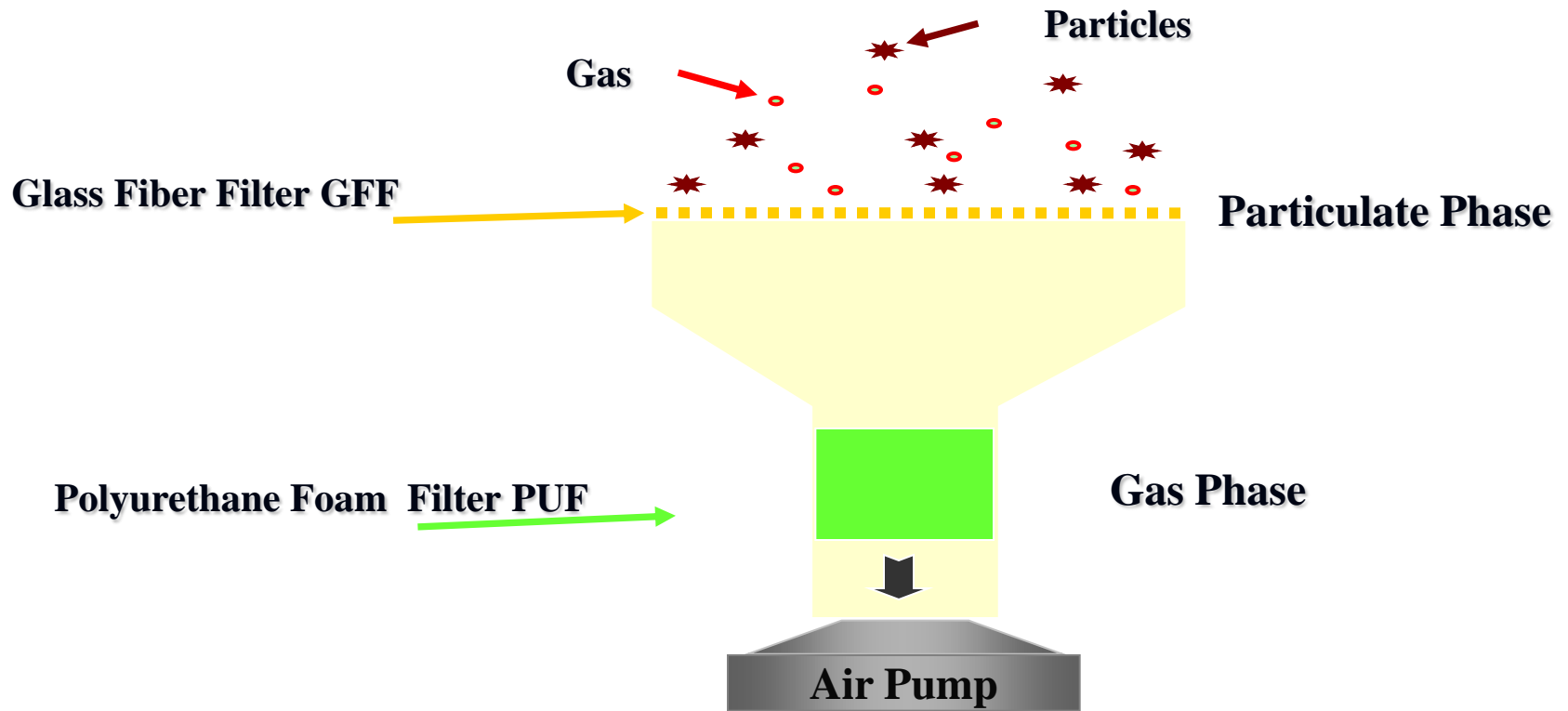

High-Volume sampler

Passive sampling

Can environmental concentrations of pollutants be calculated from the analyte levels accumulated in an integrative passive sampler?

- Calibration conditions should approximate field conditions
- Performance Reference Compounds

Calibration of a passive sampler in a flow-through system

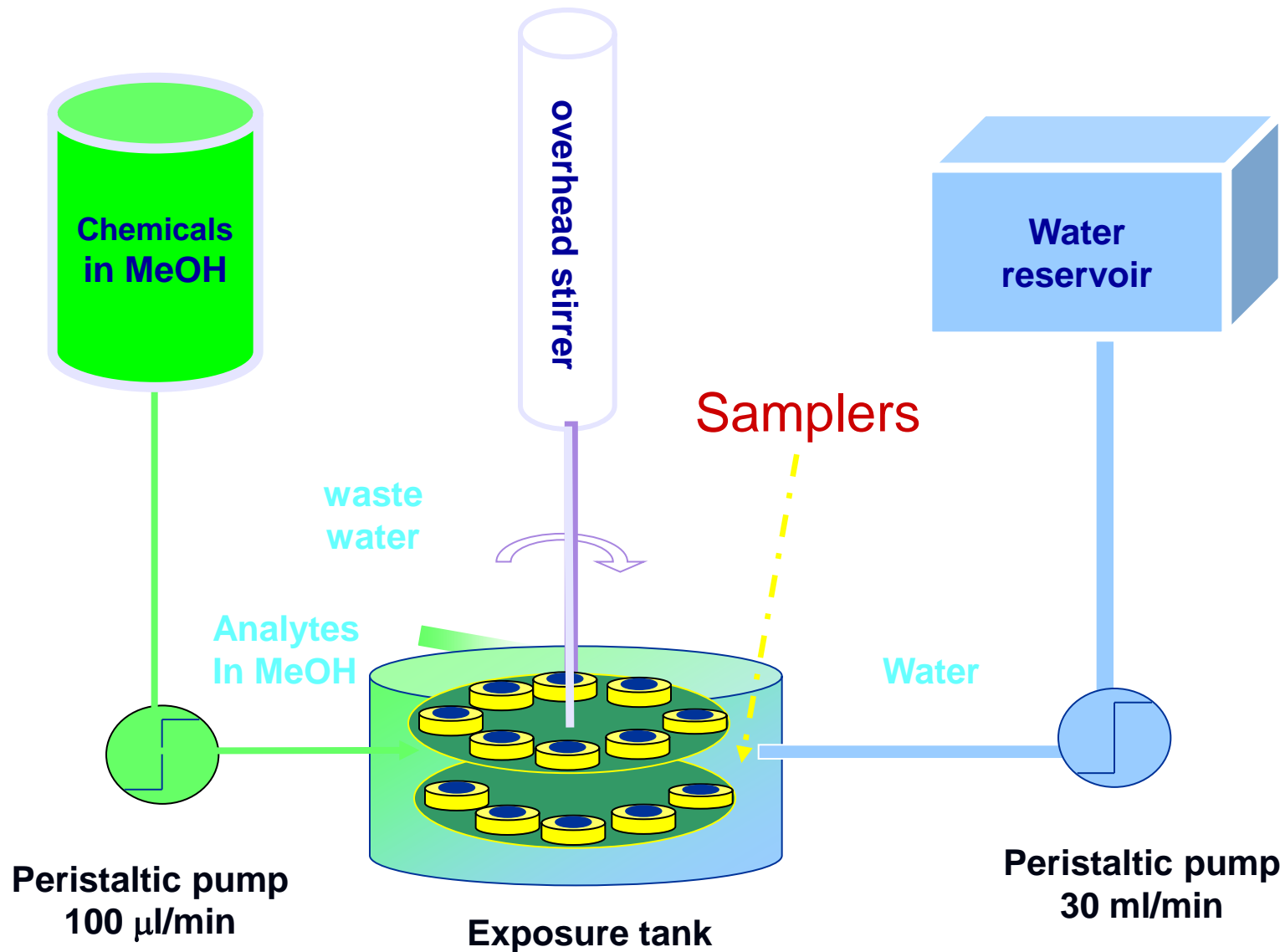

Sampling rates of PAHs

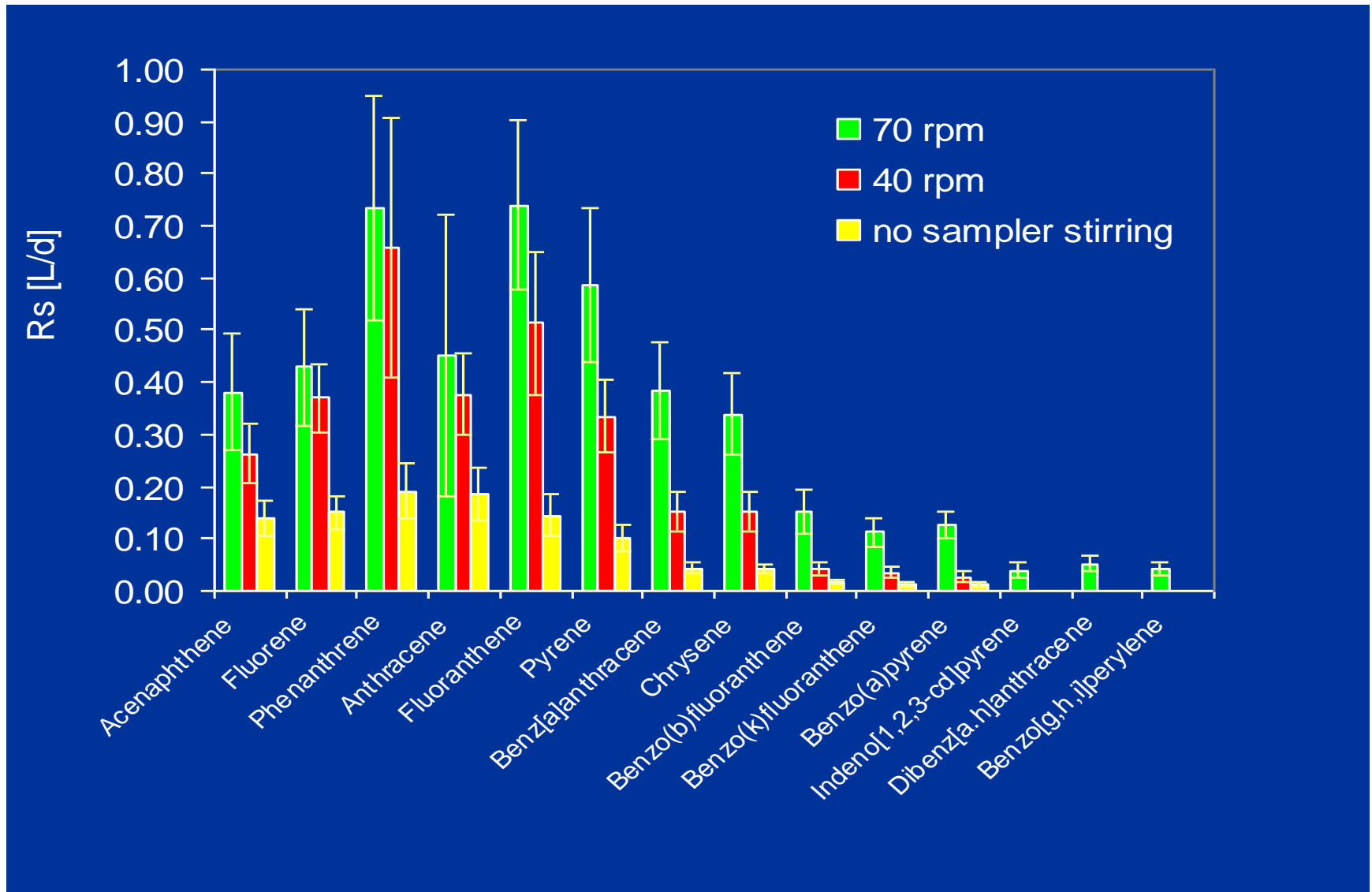

Performance reference compounds

PRCs are non-interfering compounds added to the sampler prior to exposure.

They are used for in situ calibration approach, where the rate of PRC loss during an exposure is related to the target compound uptake.

This is accomplished by measuring PRC loss rates during calibration studies and field exposures.

Use of performance reference compounds

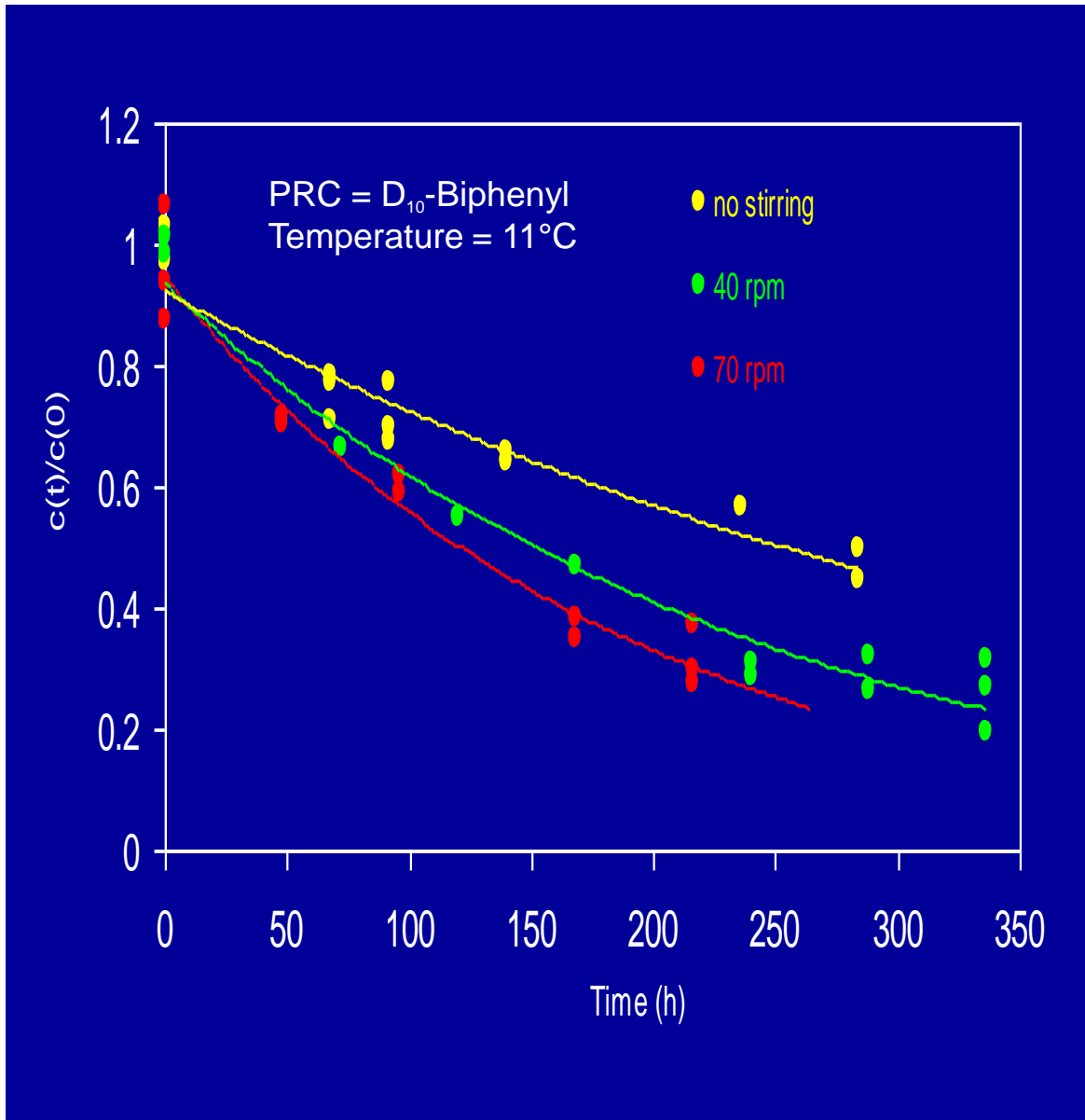

Preparation of the sample before extraction

Soil samples

- **lyofilization or air-drying**
- **sieving (< 2mm) and homogenization**
- **appropriate storage (protected from sunlight, heat and humidity)**

Sediment samples

- **stone and water removal, lyofilization or air-drying**
- **grating and sieving (<63um), homogenization**
- **powder copper treatment for sulphur removal**

Plant samples

- **lyofilization or air-drying**
- **grating, homogenization**

Animal samples

- **lyofilization or**
- **homogenization of a wet sample with sodium sulphate**

Extraction and clean-up

The goal: transfer of analytes to the chemical phase suitable for analysis, removal of interferences and pre-concentration of the sample.

Extraction techniques:

- solvent extraction (Soxhlet, automatic Soxtec, MAE, ASE, SFE)
- liquid-liquid extraction
- solid phase extraction and microextraction (SPE, SPME)
- semipermeable membrane separation
- head space analysis

Clean-up techniques

- sulphuric acid treatment
- column liquid chromatography (silica gel, alumina, florisil)
- gel permeation chromatography

Solid sample extraction

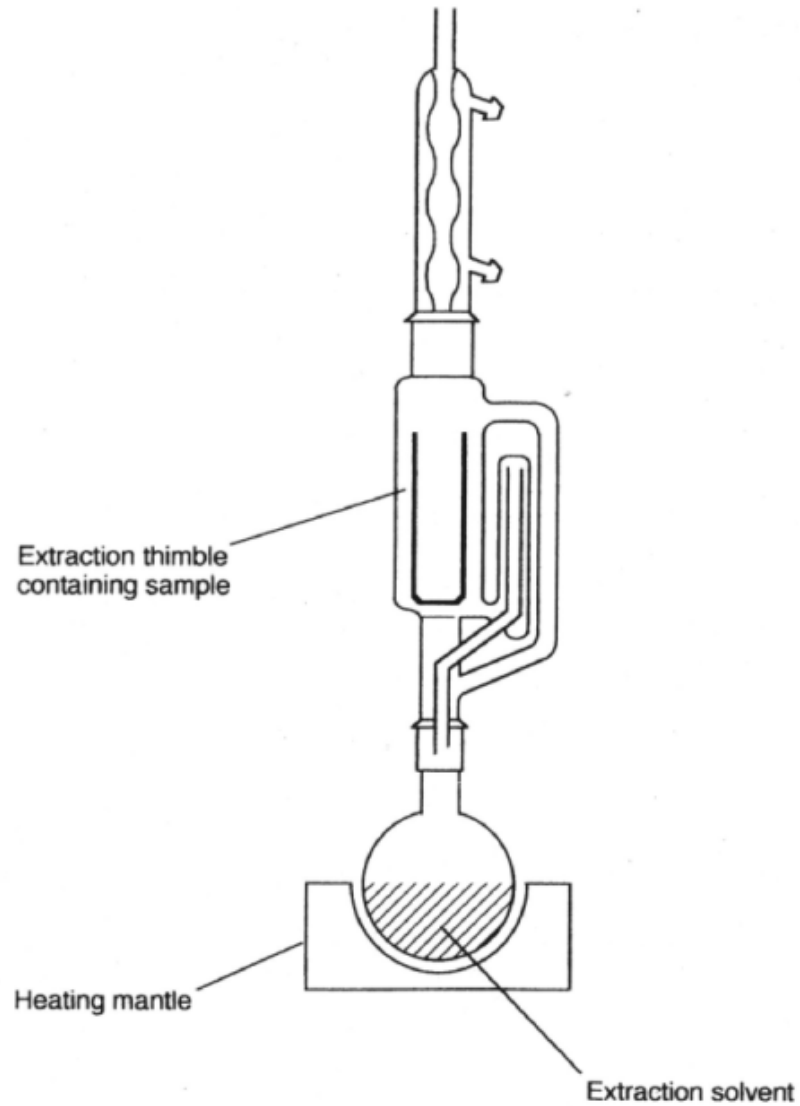

Schematic of a Soxhlet extraction system.

Liquid sample extraction

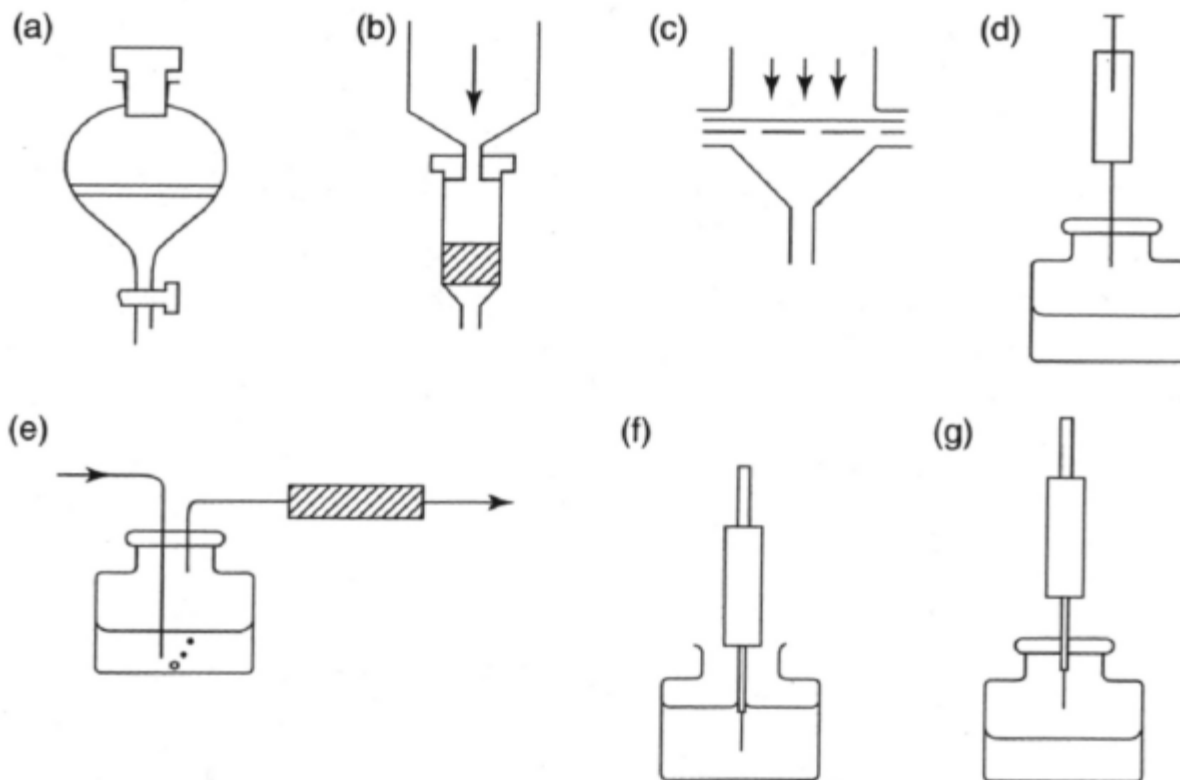

Summary of extraction methods: (a) solvent extraction; (b) solid-phase extraction – cartridge; (c) solid-phase extraction – disc; (d) head-space analysis; (e) purge and trap; (f) solid-phase microextraction – direct; (g) solid-phase microextraction – head-space.

Air samples

- filters from high volume samplers or passive samplers are extracted as solid samples (Soxhlet, MAE, ASE, SFE)

Water samples

- direct analysis of the samples with high concentration of pollutants
- head space, SPE, L-L

Soil and sediment samples

- Soxhlet, MAE, ASE, SFE
- powder copper treatment for the sulphur removal in sediment samples

Biotic samples

- high molecular compounds removal by gel permeation chromatography and column chromatography

Presence	Availability	Activity
Total mass	Fraction of total mass	Measure that drives diffusion and partitioning
How much is there?	How much is available for ... ?	How high is the diffusive pressure into other media?
Exhaustive Extraction	Depletive Extraction/ Sampling	Equilibrium Sampling Devices

Supercritical Fluid Extraction (SFE)

High pressure CO₂ (100 to 400 bar, 40 to 150 °C) is pumped through a sample, and extracted analytes are collected in a suitable solvent for GC analysis.

Why to use supercritical carbon dioxide?

- CO₂ is a lipophilic solvent much like biological lipids in polarity
- PAH solubilities in CO₂ are proportional to those in water, but ca. 10⁴ higher
- pressure and temperature gradients enable the extraction of both, non-polar and polar compounds
- mild SFE can be used to predict bioavailability of compounds

Earthworm Mortality Depends on Available PAHs (measured by SFE), not on Total PAH Concentrations

Soil	Total PAH (ug/g soil)	Available Fraction (SFE)	Available Total PAH (ug/g C)	Mortality %
CG15	1020	0.25	1040	0
OG14	168	0.46	2720	0
CG11	15600	0.06	3280	0
CG12	3790	0.16	7880	0
OG17	17200	0.27	9720	0
OG5	1870	0.41	11100	0
OG10	42100	0.33	16300	0
CG3	4100	0.83	45700	100
OG18	17300	0.74	50100	100

S. B. Hawthorne, C. B. Grabanski, D. J. Miller

Flow chart of a clean-up procedure for stack emission samples

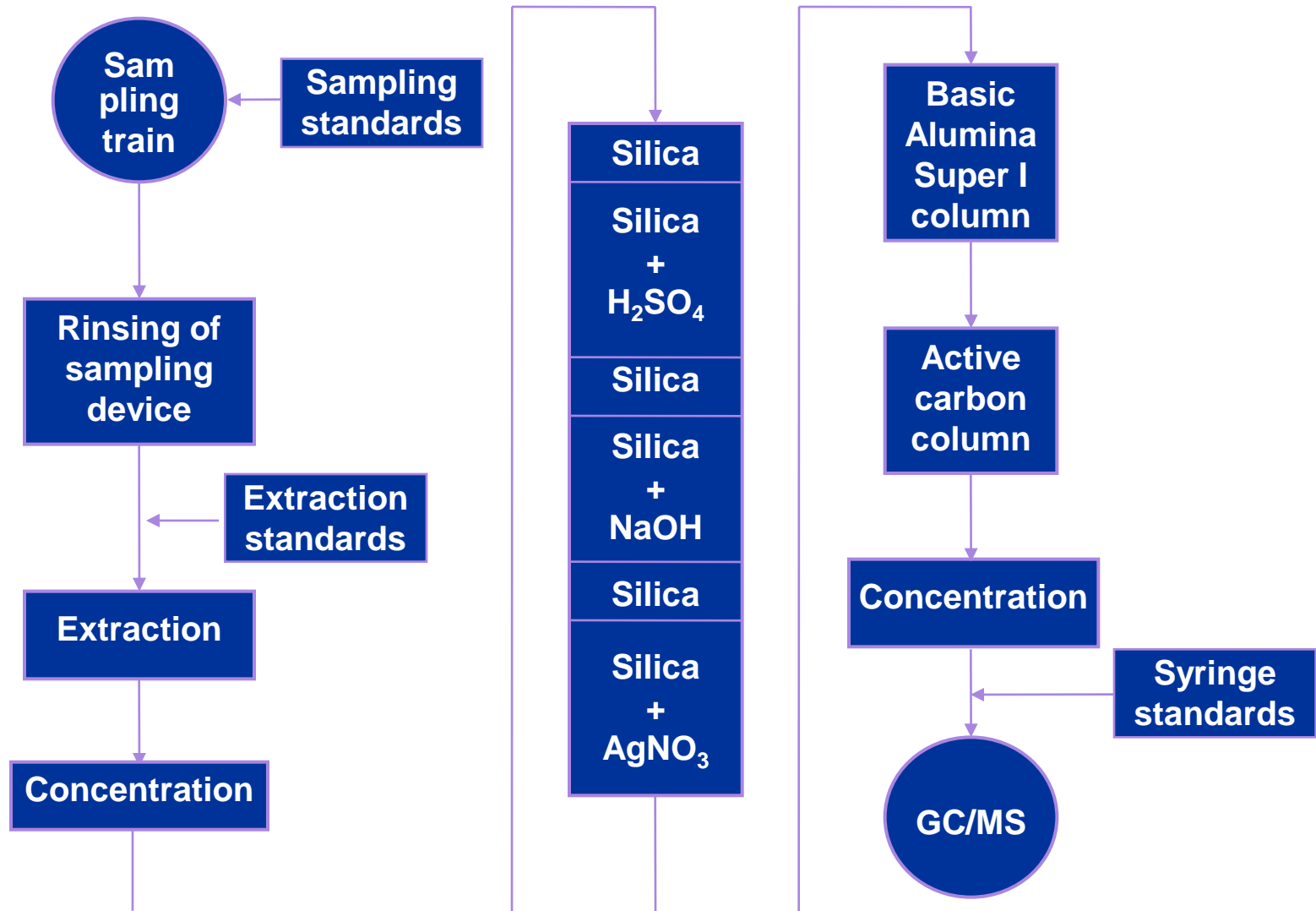

Priority pollutants

- polychlorinated biphenyls
- polychlorinated dibenzo-*p*-dioxins and furans
- organochlorinated pesticides and their metabolites
- polyaromatic hydrocarbons
 - aromatics and nitro-aromatics
- chlorinated benzenes
- fenol and chlorinated fenols
- halogenated alkans

Polychlorinated biphenyls

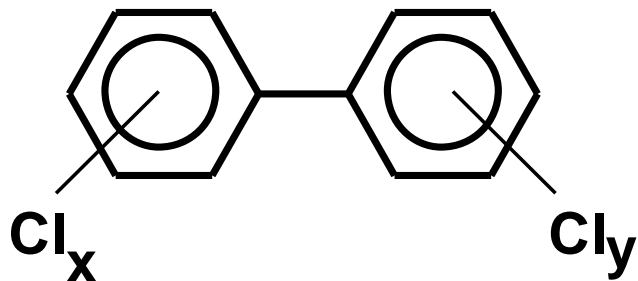

- sulphuric acid treatment
- silica gel column chromatography
- activated carbon for non-ortho PCBs
- GC-ECD, GC-MS, GC- HRMS

IUPAC numbering and substitution pattern of PCB congeners

No.	Structure	No.	Structure	No.	Structure	No.	Structure
<u>Monochlorobiphenyls</u>		<u>Tetrachlorobiphenyls</u>		<u>Pentachlorobiphenyls</u>		<u>Hexachlorobiphenyls</u>	
1	2	52	2,2',5',5'	105	2,3,3',4,4'	161	2,3,3',4,5',6'
2	3	53	2,2',5',6'	106	2,3,3',4,5'	162	2,3,3',4',5,5'
3	4	54	2,2',6,6'	107	2,3,3',4,5'	163	2,3,3',4',5,6'
<u>Dichlorobiphenyls</u>		55	2,3,3',4'	108	2,3,3',4,5'	164	2,3,3',4',5',6'
4	2,2'	56	2,3,3',4'	109	2,3,3',4,6'	165	2,3,3',5',5',6'
5	2,3	57	2,3,3',5'	110	2,3,3',4,6'	166	2,3,4,4',5,6'
6	2,3'	58	2,3,3',5'	111	2,3,3',5,5'	167	2,3',4,4',5,5'
7	2,4	59	2,3,3',6'	112	2,3,3',5,6'	168	2,3',4,4',5',6'
8	2,4'	60	2,3,4,4'	113	2,3,3',5',6'	169	3,3',4,4',5,5'
9	2,5	61	2,3,4,5'	114	2,3,4,4',5'	<u>Heptachlorobiphenyls</u>	
10	2,6	62	2,3,4,6'	115	2,3,4,4,6'	170	2,2',3,3',4,4',5'
11	3,3'	63	2,3,4,5'	116	2,3,4,4,5,6'	171	2,2',3,3',4,4',6'
12	3,4	64	2,3,4,6'	117	2,3,4',5,6'	172	2,2',3,3',4,5,5'
13	3,4'	65	2,3,5,6'	118	2,3',4,4,5'	173	2,2',3,3',4,5,6'
14	3,5	66	2,3',4,4'	119	2,3',4,4,6'	174	2,2',3,3',4,5,6'
15	4,4'	67	2,3',4,5'	120	2,3',4,5,5'	175	2,2',3,3',4,5',6'
<u>Trichlorobiphenyls</u>		68	2,3',4,5'	121	2,3',4,5',6'	176	2,2',3,3',4,6,6'
16	2,2',3	69	2,3',4,6'	122	2',3,3',4,5'	177	2,2',3,3',4',5,6'
17	2,2',4	70	2,3',4,5'	123	2',3,4,4,5'	178	2,2',3,3',5,5',6'
18	2,2',5	71	2,3',4',6'	124	2',3,4,5,5'	179	2,2',3,3',5,6,6'
19	2,2',6	72	2,3',5,5'	125	2',3,4,5,6'	180	2,2',3,4,4',5,5'
20	2,3,3'	73	2,3',5,6'	126	3,3',4,4,5'	181	2,2',3,4,4',5,6'
21	2,3,4	74	2,4,4,5'	127	3,3',4,5,5'	182	2,2',3,4,4',5',6'
22	2,3,4'	75	2,4,4,6'	<u>Hexachlorobiphenyls</u>		183	2,2',3,4,4',5',6'
23	2,3,5	76	2',3,4,5'	128	2,2',3,3',4,4'	184	2,2',3,4,4',6,6'
24	2,3,6	77	3,3',4,4'	129	2,2',3,3',4,5'	185	2,2',3,4,5,5',6'
25	2,3',4	78	3,3',4,5'	130	2,2',3,3',4,5'	186	2,2',3,4,5,6,6'
26	2,3',5	79	3,3',4,5'	131	2,2',3,3',4,6'	187	2,2',3,4',5,5',6'
27	2,3',6	80	3,3',5,5'	132	2,2',3,3',4,6'	188	2,2',3,4',5,6,6'
28	2,4,4'	81	3,4,4,5'	133	2,2',3,3',5,5'	189	2,3,3',4,4',5,5'
29	2,4,5	<u>Pentachlorobiphenyls</u>		134	2,2',3,3',5,6'	190	2,3,3',4,4',5,6'
30	2,4,6	82	2,2',3,3',4'	135	2,2',3,3',5,6'	191	2,3,3',4,4',5',6'
31	2,4',5	83	2,2',3,3',5'	136	2,2',3,3',6,6'	192	2,3,3',4,5,5',6'
32	2,4',6	84	2,2',3,3',6'	137	2,2',3,4,4,5'	193	2,3,3',4',5,5',6'
33	2',3,4	85	2,2',3,4,4'	138	2,2',3,4,4',5'	<u>Octachlorobiphenyls</u>	
34	2',3,4'	86	2,2',3,4,5'	139	2,2',3,4,4',6'	194	2,2',3,3',4,4',5,5'
35	3,3',4	87	2,2',3,4,5'	140	2,2',3,4,4',6'	195	2,2',3,3',4,4',5,6'
36	3,3',5	88	2,2',3,4,6'	141	2,2',3,4,5,5'	196	2,2',3,3',4,4',5,6'
37	3,4,4'	89	2,2',3,4,6'	142	2,2',3,4,5,6'	197	2,2',3,3',4,4',6,6'
38	3,4,5'	90	2,2',3,4,5'	143	2,2',3,4,5,6'	198	2,2',3,3',4,5,5',6'
39	3,4,5'	91	2,2',3,4,6'	144	2,2',3,4,5',6'	199	2,2',3,3',4,5,6,6'
<u>Tetrachlorobiphenyls</u>		92	2,2',3,5,5'	145	2,2',3,4,6,6'	200	2,2',3,3',4,5,6,6'
40	2,2',3,3'	93	2,2',3,5,6'	146	2,2',3,4,5,5'	201	2,2',3,3',4,5,5',6'
41	2,2',3,4	94	2,2',3,5,6'	147	2,2',3,4,5,6'	202	2,2',3,3',5,5',6,6'
42	2,2',3,4'	95	2,2',3,5,6'	148	2,2',3,4,5',6'	203	2,2',3,4,4',5,5',6'
43	2,2',3,5	96	2,2',3,6,6'	149	2,2',3,4,5',6'	204	2,2',3,4,4',5,6,6'
44	2,2',3,5'	97	2,2',3',4,5'	150	2,2',3,4,6,6'	205	2,3,3',4,4',5,5',6'
45	2,2',3,6	98	2,2',3',4,6'	151	2,2',3,5,5',6'	<u>Nonachlorobiphenyls</u>	
46	2,2',3,6'	99	2,2',4,4,5'	152	2,2',3,5,6,6'	206	2,2',3,3',4,4',5,5',6'
47	2,2',4,4'	100	2,2',4,4,6'	153	2,2',4,4,5,5'	207	2,2',3,3',4,4',5,6,6'
48	2,2',4,5	101	2,2',4,5,5'	154	2,2',4,4',5,6'	208	2,2',3,3',4,5,5',6,6'
49	2,2',4,5'	102	2,2',4,5,6'	155	2,2',4,4',6,6'	<u>Decachlorobiphenyls</u>	
50	2,2',4,6	103	2,2',4,5,6'	156	2,3,3',4,4,5'	209	2,2',3,3',4,4',5,5',6,6'
51	2,2',4,6'	104	2,2',4,6,6'	157	2,3,3',4,4,5'		
				158	2,3,3',4,4,6'		
				159	2,3,3',4,5,5'		
				160	2,3,3',4,5,6'		

Organochlorinated pesticides

(DDT, HCH, hexachlorobenzene, toxaphene, aldrin, dieldrin, endrin, endosulfane, chlordane)

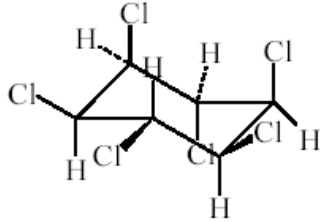
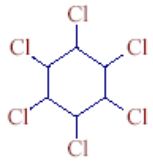

- for HCHs and DDTs analytical procedures similar to PCBs
- GC-ECD, GC-MS, NCI-MS, HRMS

HCH

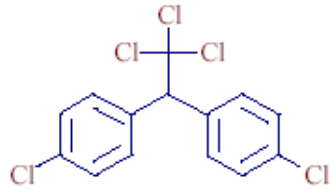

p,p'-DDT

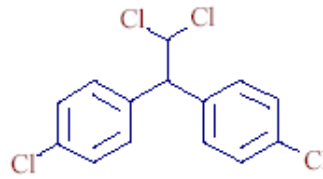

p,p'-DDD



p,p'-DDE

- analytical procedures similar to PCBs for toxaphene,
- sulphuric acid has to be omitted for aldrin or endosulfane
- GC-MS, NCI-MS, HRMS

Polychlorinated dibenzodioxins and dibenzofurans

- combined modified silica gel clean-up
- fractionation on alumina/florisil column
- non-ortho PCBs separation on activated carbon column
- HRGC-HRMS
- kapillary columns 50-60m (DB-5, DB-17, DB-DIOXIN)
- EI, NCI
- SIM
- MS-MS

Polyaromatic hydrocarbons

- silica gel column chromatography
- GC-MS, FLD-HPLC

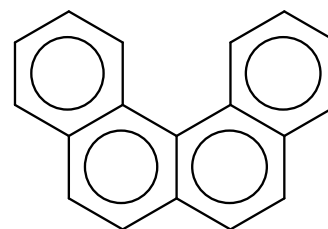
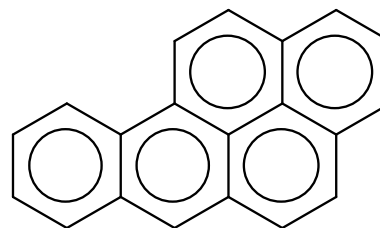

Sample analysis

Chromatographic separation (GC, HPLC) is the most common technique for the analysis of environmental samples.

It is a physical method based on the distribution of compounds between two phases (stationary and mobile). Process of continuous sorption and desorption of compounds in contact with the stationary phase is responsible for different migration times and for separation of analytes.

Two dimensional (GC-GC) and two modal (HPLC-GC) chromatography provide even more sophisticated tools for environmental analysis

GC-MS, HPLC-MS and HRMS enable the trace and ultra-trace analysis

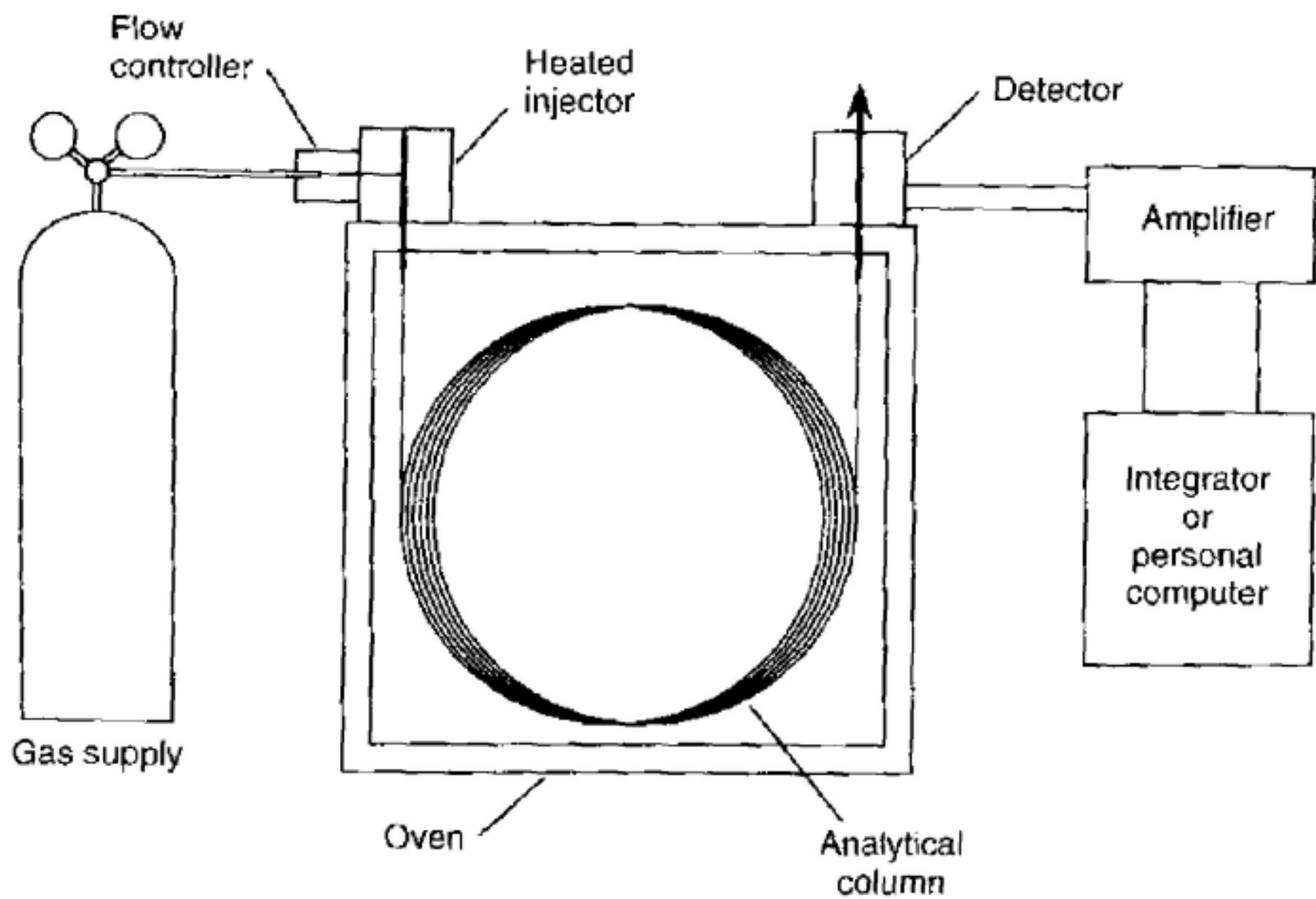

Figure 4.4 Major components of a gas chromatograph.

GC separation:

Non-polar stationary phase (e.g. DB-5) – used for the samples of animal origin and higher chlorinated congeners

Polar phase (e.g. SP-2330) – used for environmental samples (good separation but shorter lifetime)

Splitless, on-column or large-volume injection

Direct connection of the column to the ion source

*out of
splitless
injector*

*to mass
spectrometer*

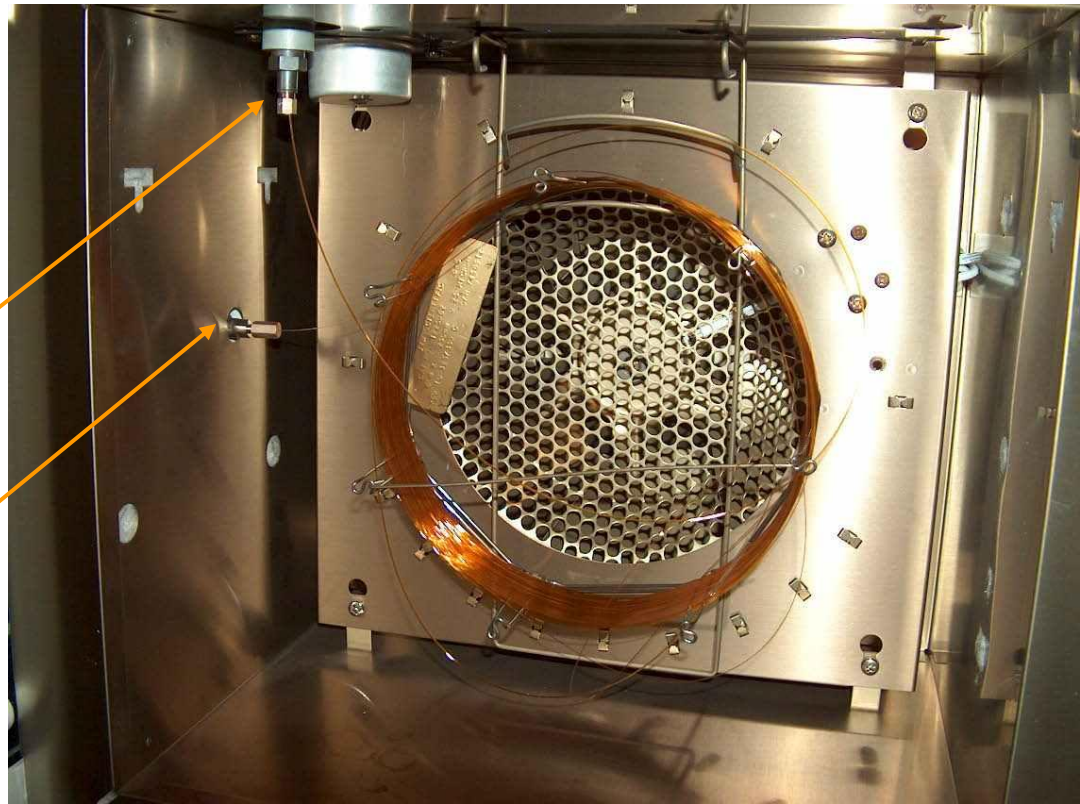

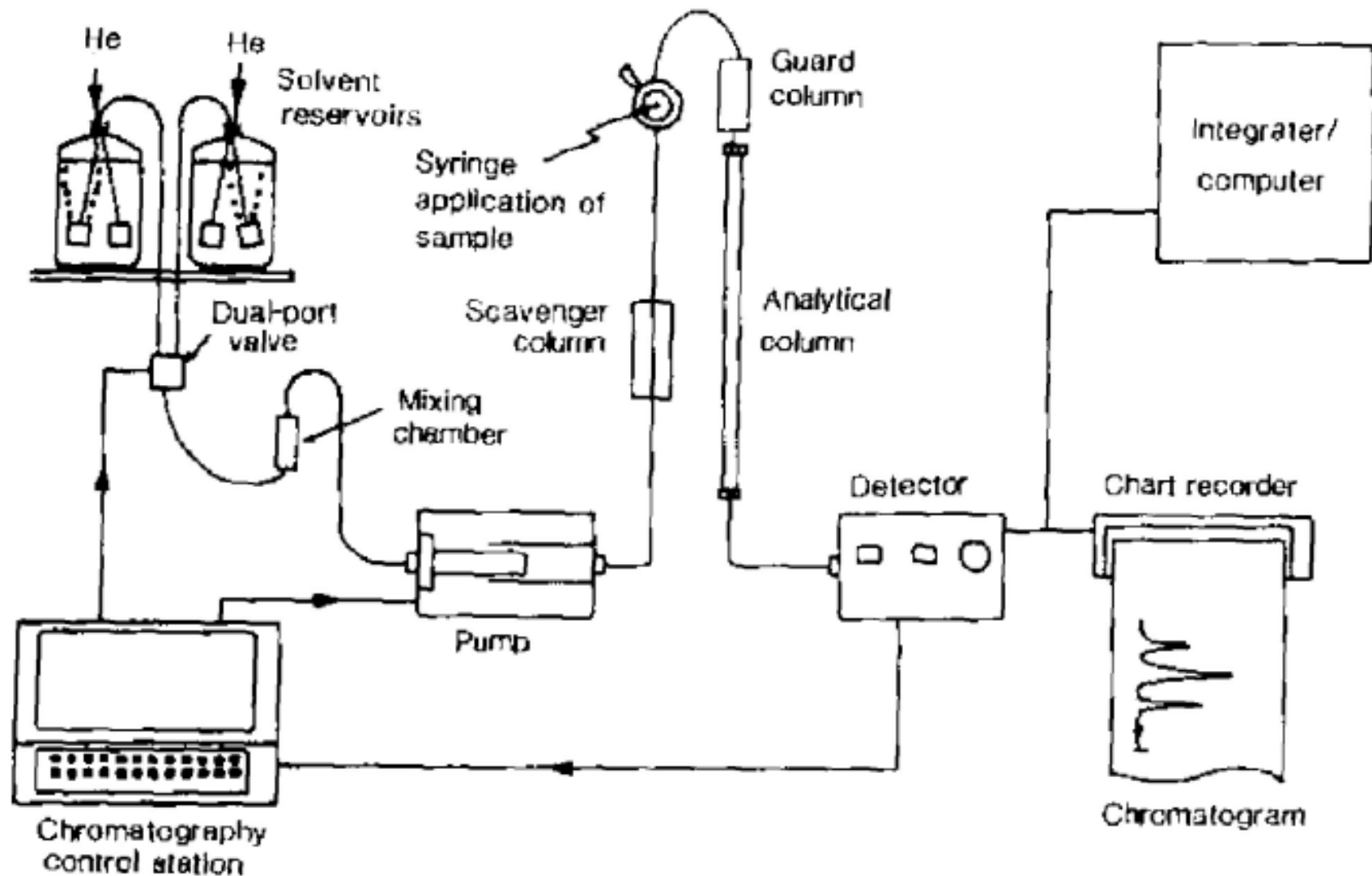

5.7 Schematic diagram of a binary (two-solvent) HPLC system. Source: Fifield, F.W. Kealey, D. (1995) *Principles and Practice of Analytical Chemistry*, 4th edition, Blackie Academic & Professional, Glasgow.

Chromatogram

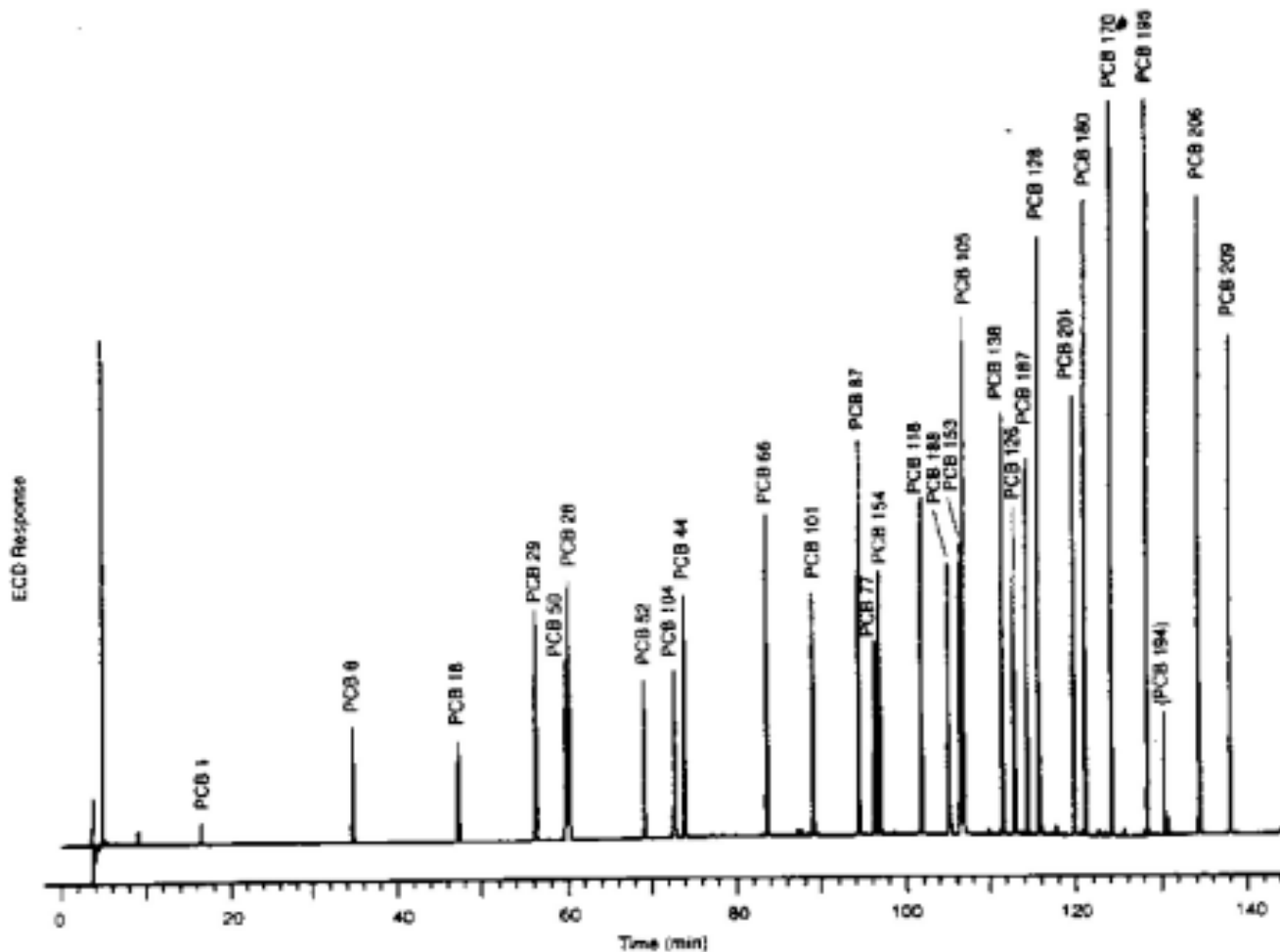
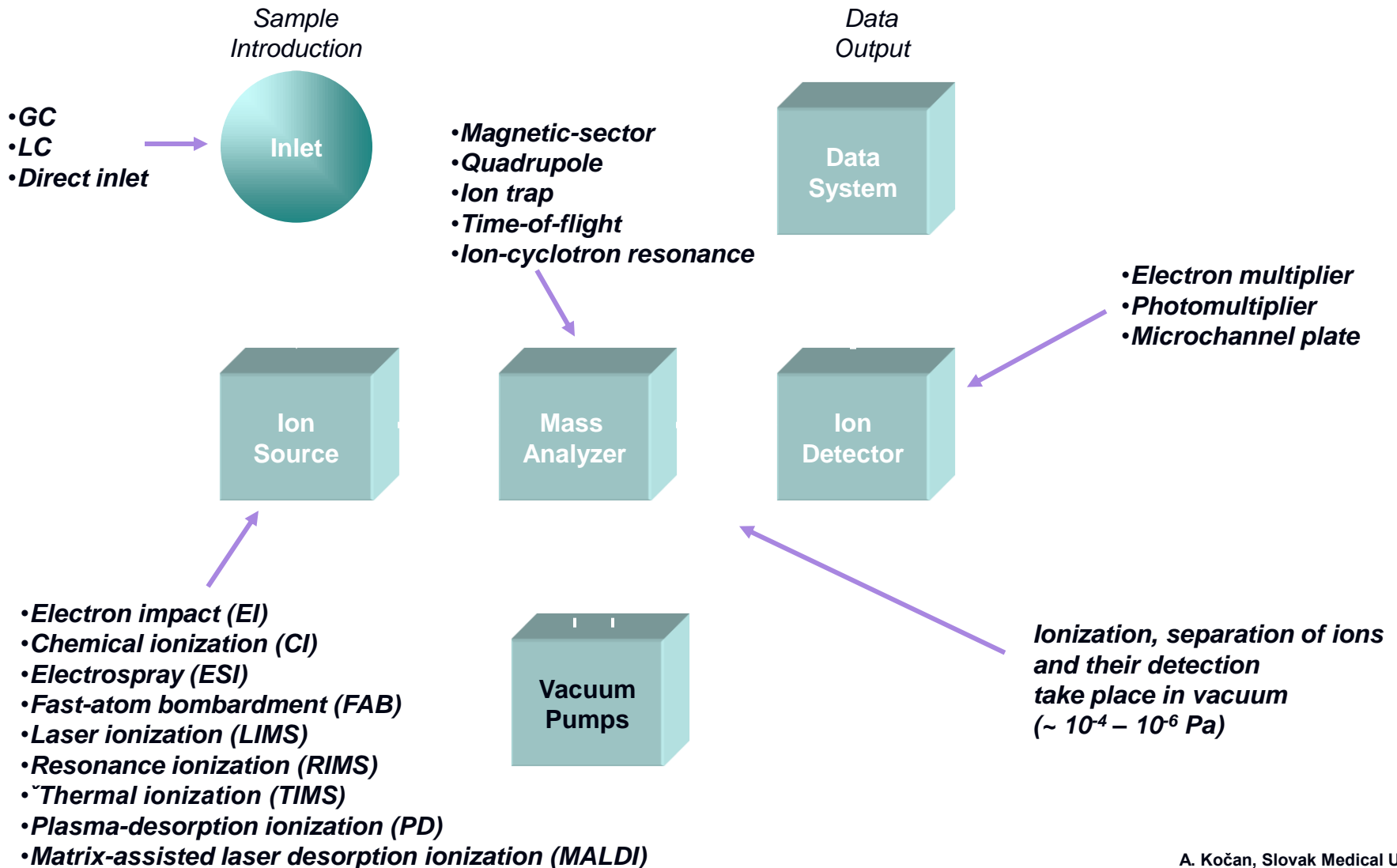

Figure A-1. Chromatogram of NIST SRM 2262 by GC-ECD using a 0.25-mm i.d. x 60-m fused silica capillary column with a 5% phenyl-substituted methylpolysiloxane phase (0.25 μ m film thickness) (DB-5, J&W Scientific, Folsom, CA) Temperature Program: 150 $^{\circ}$ C (40 min) to 220 $^{\circ}$ C (0 min) at 1 $^{\circ}$ C/min to 280 $^{\circ}$ C (25 min) at 3 $^{\circ}$ C/min.

Mass Spectrometer

- All the MS systems compose of the following parts:



Electron Impact Ionization Source

10 to 20 eV out of those 70 eV are transferred to the molecules during the ionization process;

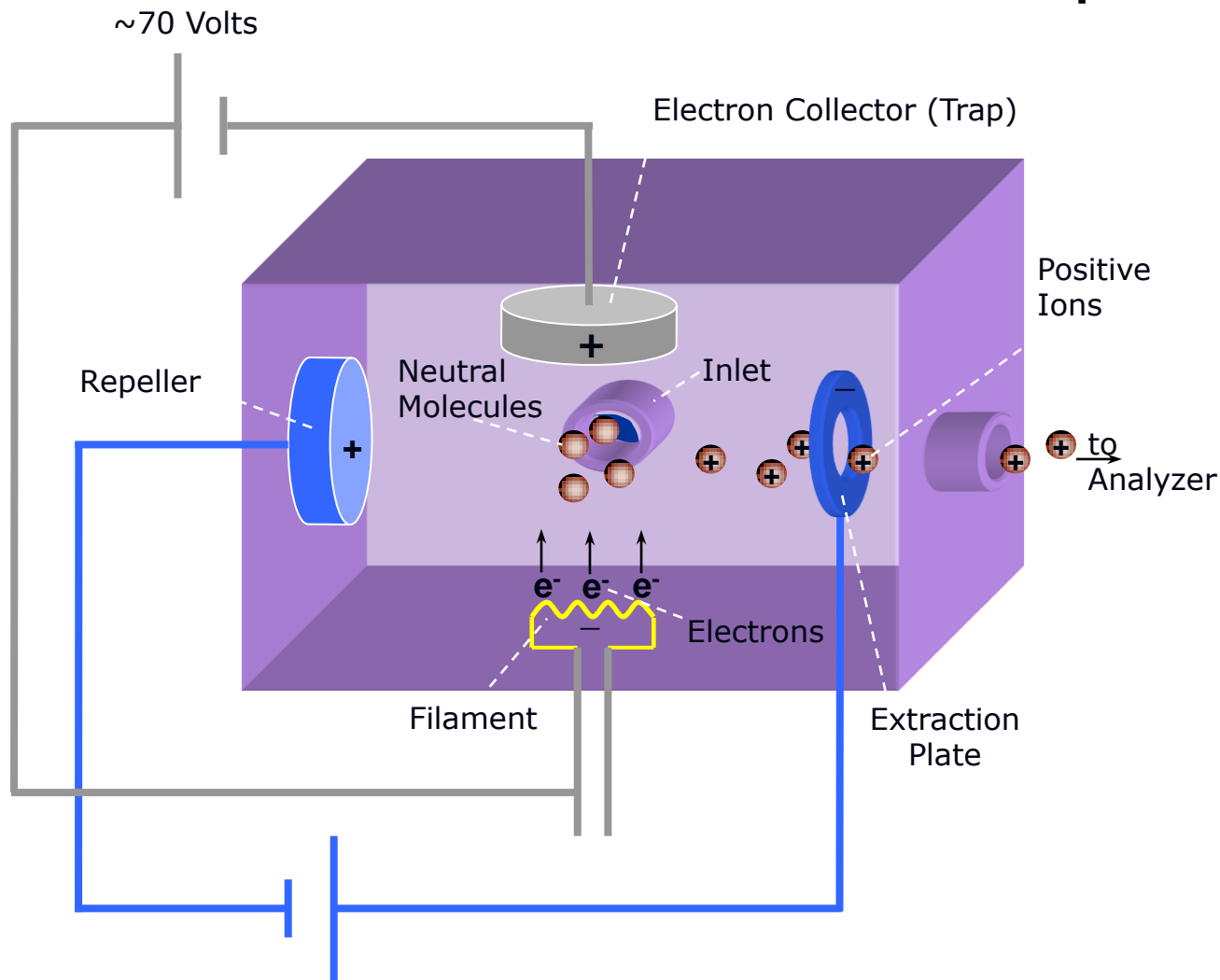

Since ~ 10 eV are enough to ionize most organic molecules the excess energy leads to extensive fragmentation;

Hence EI is classified as a „hard“ ionization technique

The fragmentation gives structural information

Quadrupole Mass Filter

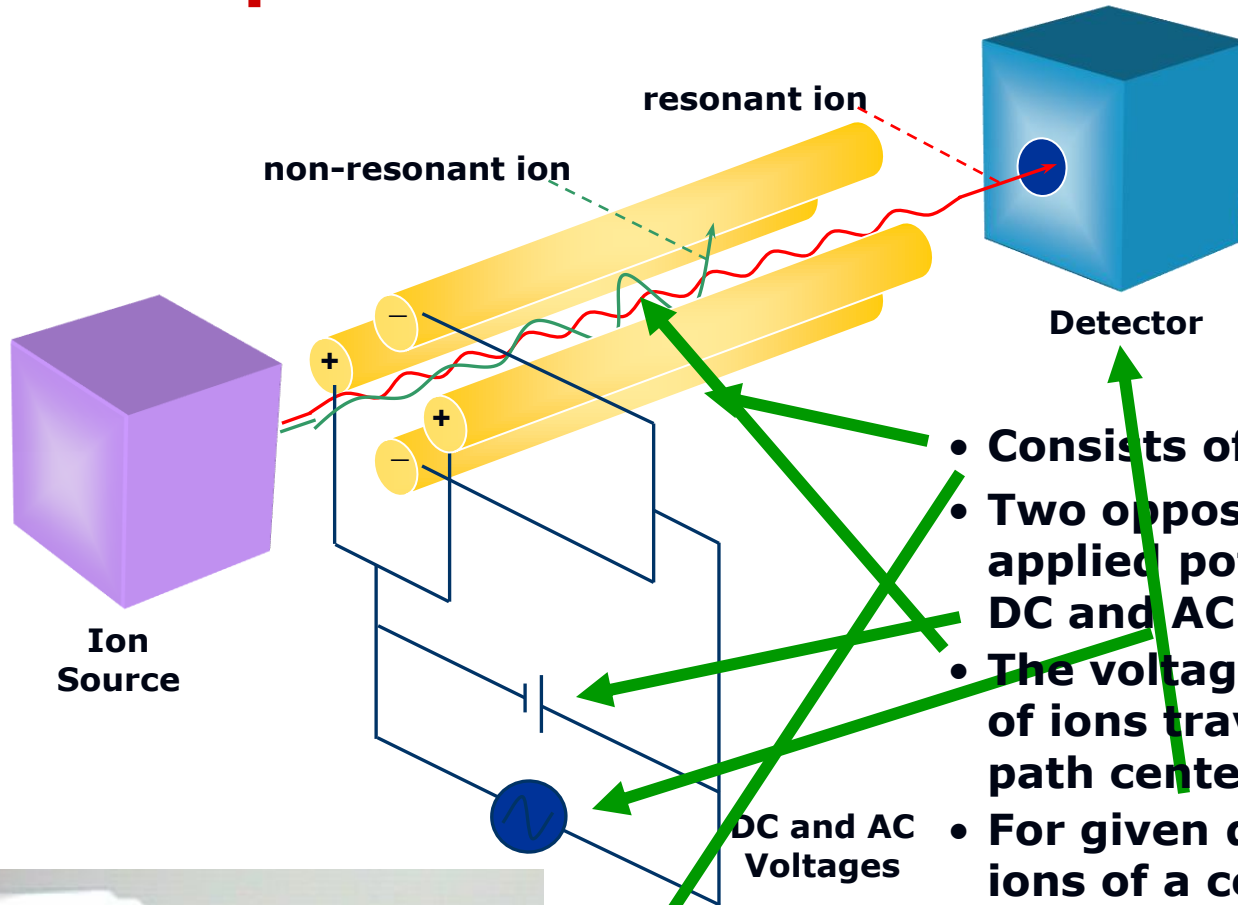

- Consists of 4 parallel metal rods.
- Two opposite rods have an applied potential combined from DC and AC voltages.
- The voltages affect the trajectory of ions traveling down the flight path centered between the rods.
- For given dc and ac voltages, only ions of a certain mass-to-charge ratio pass through the filter and all other ions are thrown out of their original path.
- A mass spectrum is obtained by monitoring the ions passing through the quadrupole filter as the voltages or frequency on the rods are varied.



Ion Trap Mass Spectrometry



Wolfgang Paul
1989 Nobel Prize
for Physics „for
the development
of the ion trap
technique“

- The ion-trap analyzer consists of 3 electrodes with hyperbolic surfaces to trap ions in a small volume – the central ring electrode and 2 adjacent endcap electrodes. A mass spectrum is obtained by changing the electrode voltages to eject the ions from the trap.
- The advantages of the ion-trap mass spectrometer include compact size, and the ability to trap and accumulate ions to increase the signal-to-noise ratio of a measurement.
- This technique can be used easily in the MS/MS (MS^n) mode

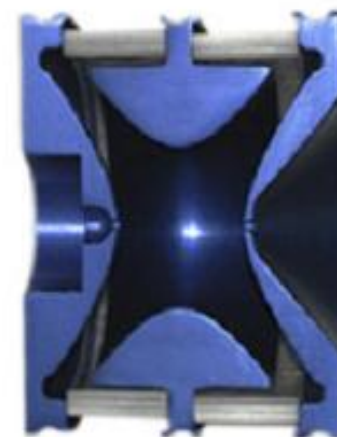
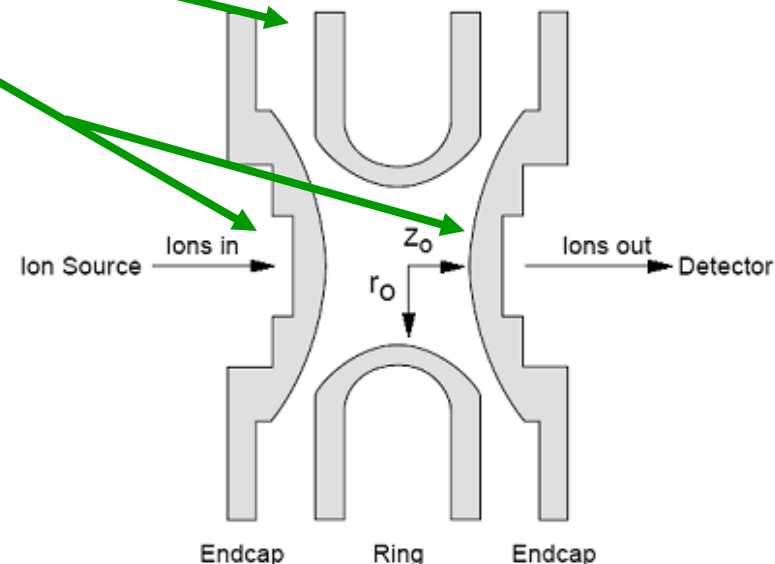

Time-Of-Flight Mass Spectrometry (TOFMS)

- It uses differences in transit time through a drift region to separate ions of different masses
- An electric field accelerates all ions into a field-free drift region with the same initial kinetic energy for all the ions produced
- It operates in a pulsed mode so ions must be produced or extracted in pulses
- Since the ion kinetic energy is $0.5mv^2$, lighter ions have a higher velocity than heavier ions and reach the detector sooner (e.g., ions of m/z 500 arrive in $\sim 15 \mu s$ and m/z 50 in $\sim 4.6 \mu s$)
- By TOF-MS, up to 50 000 full spectra can be measured in a second
- Since full spectra are available, peak deconvolution software enabling to differentiate non-separated GC peaks may be applied
- The TOF ultra-fast scanning is suitable for fast GC where peak widths can be much less than a second

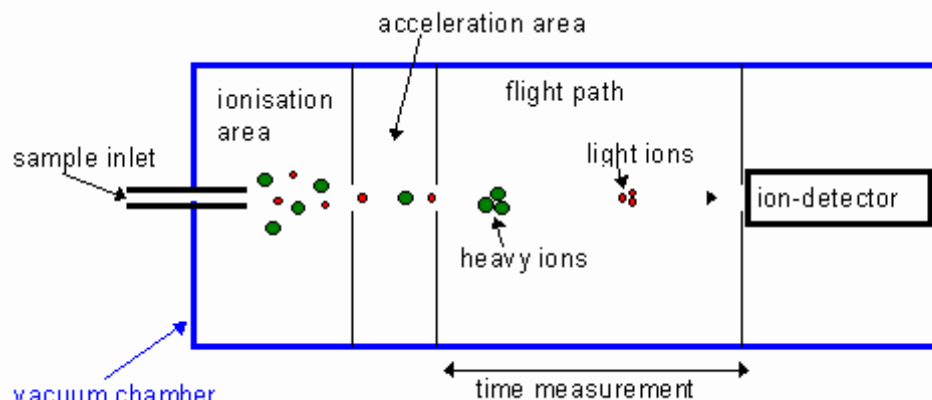
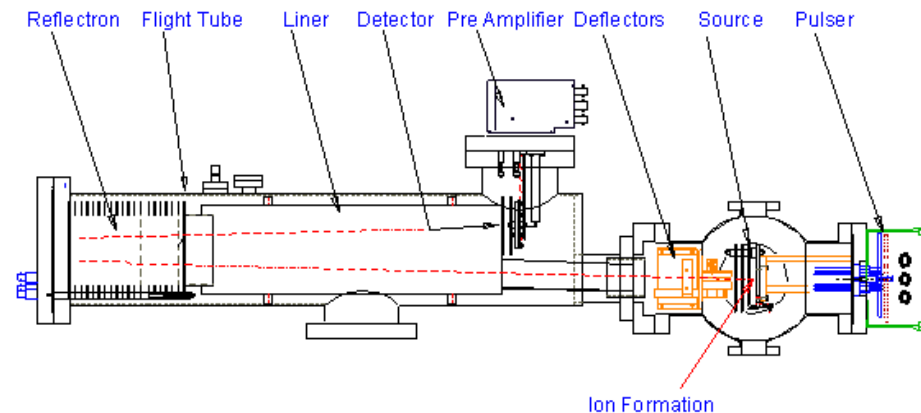

Magnetic Sector Mass Analyzer

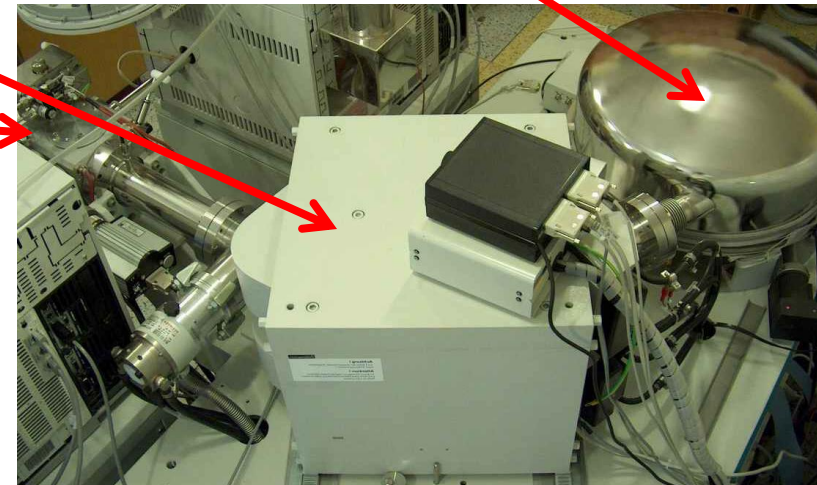
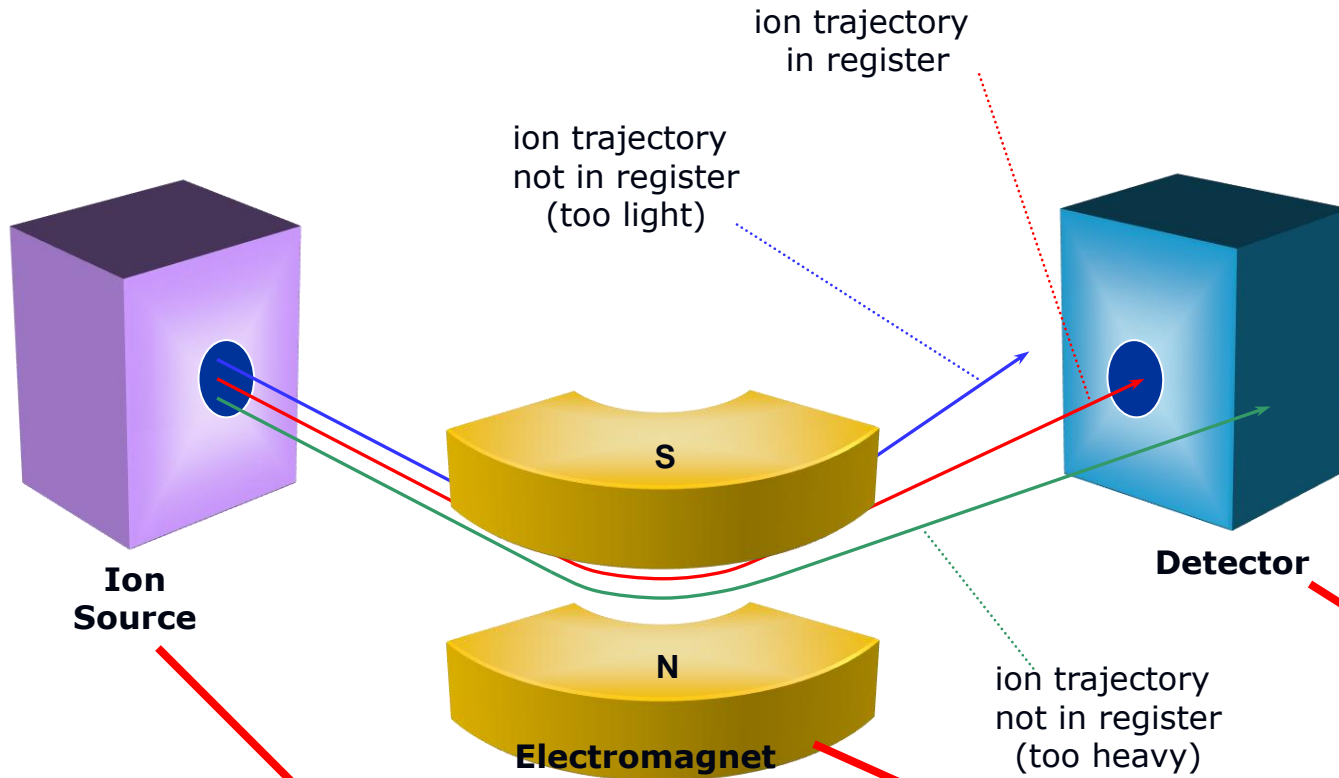

Mass spectra

Abundance

Scan 1136 (18.002 min): 02021.D (-)

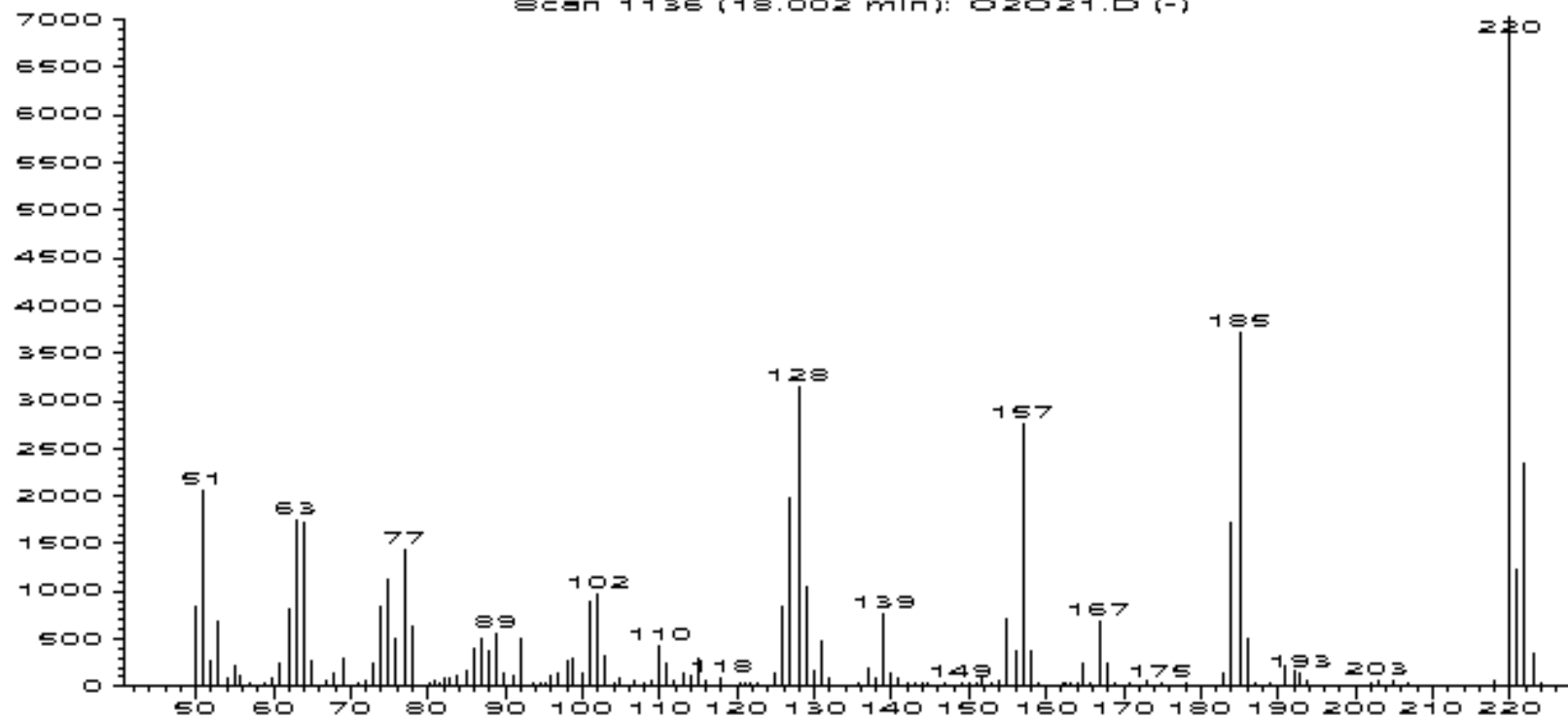

m/z-->

- The **scanning** mode provides mass spectra. They are recorded (scanned) at regular intervals (typically 0.5 – 1 /s; much faster if TOFMS is used) during the GC separation and stored in the instrument data system for subsequent qualitative or quantitative evaluation.
- From mass spectra, it is often possible to deduce structural features (mass spectral interpretation) but this requires experience and can be very time-consuming, particularly as a complex mixture might contain hundreds of components.

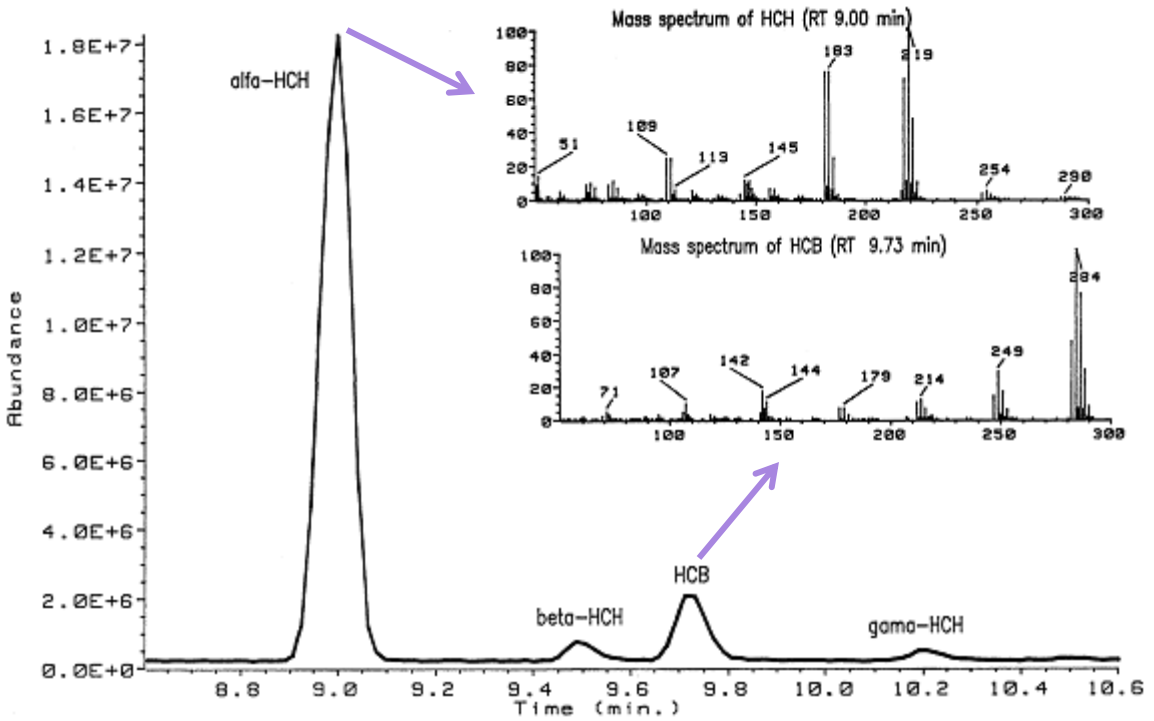

- The spectra can also be compared with those stored in mass spectral libraries. Although library searching is a very useful and timesaving technique, it is important to remember that such searches do not identify compounds – analysts do!

What is the SIM (or MID) Mode in Mass Spectrometry ?

- SIM (Selected Ion Monitoring) or MID (Multiple Ion Detection) is much more sensitive technique suitable for trace quantitative analysis. Here, instead of scanning a whole spectrum, only a few ions (generally, the most abundant but characteristic selected from the mass spectrum) are detected during the GC run.
- This can result in as much as a 500-fold increase in sensitivity, at the expense of selectivity. Depending on the analyte, low picogram to even low femtogram amounts can be measured using this powerful technique.
- Stable isotope-labeled internal standards can be employed.

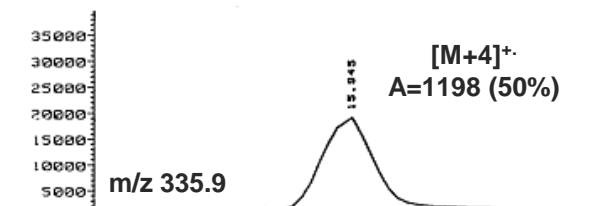
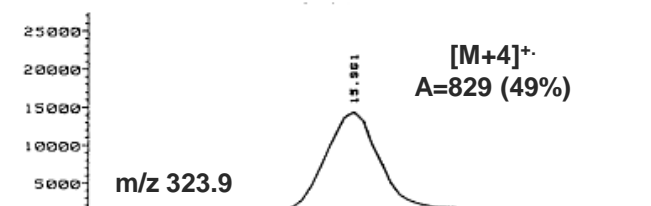
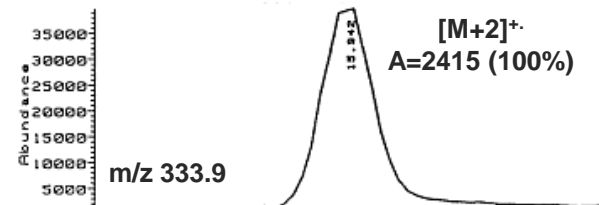
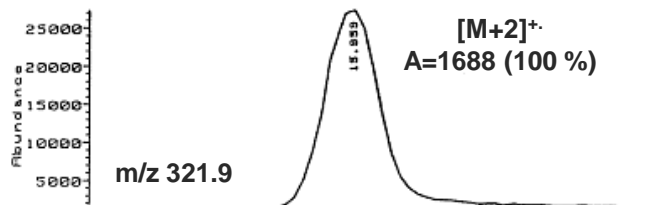
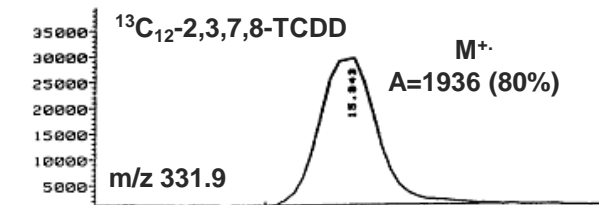
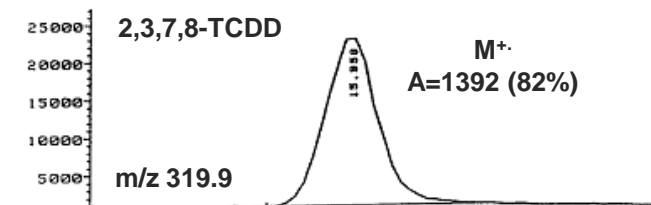
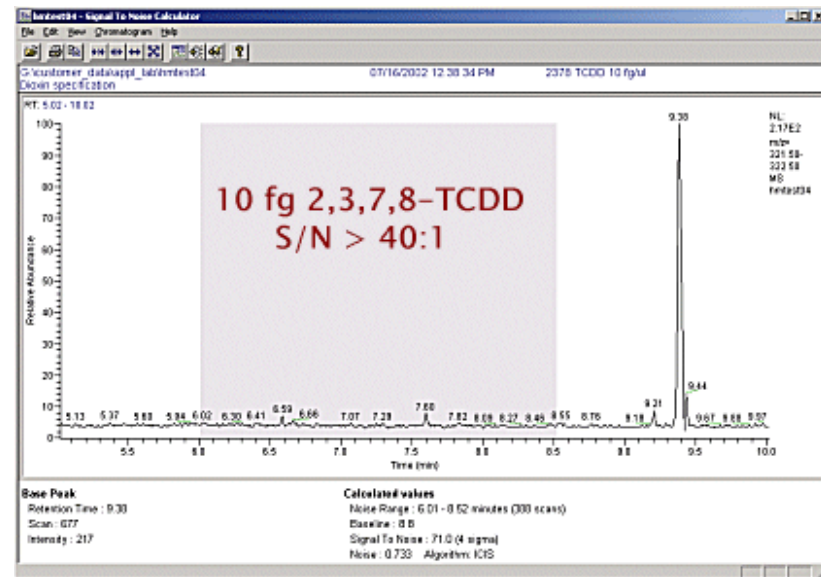

**HRMS/LRMS-SIM
chromatogram from the
analysis of 2378-TCDD in a
soil extract by the isotope
dilution method**

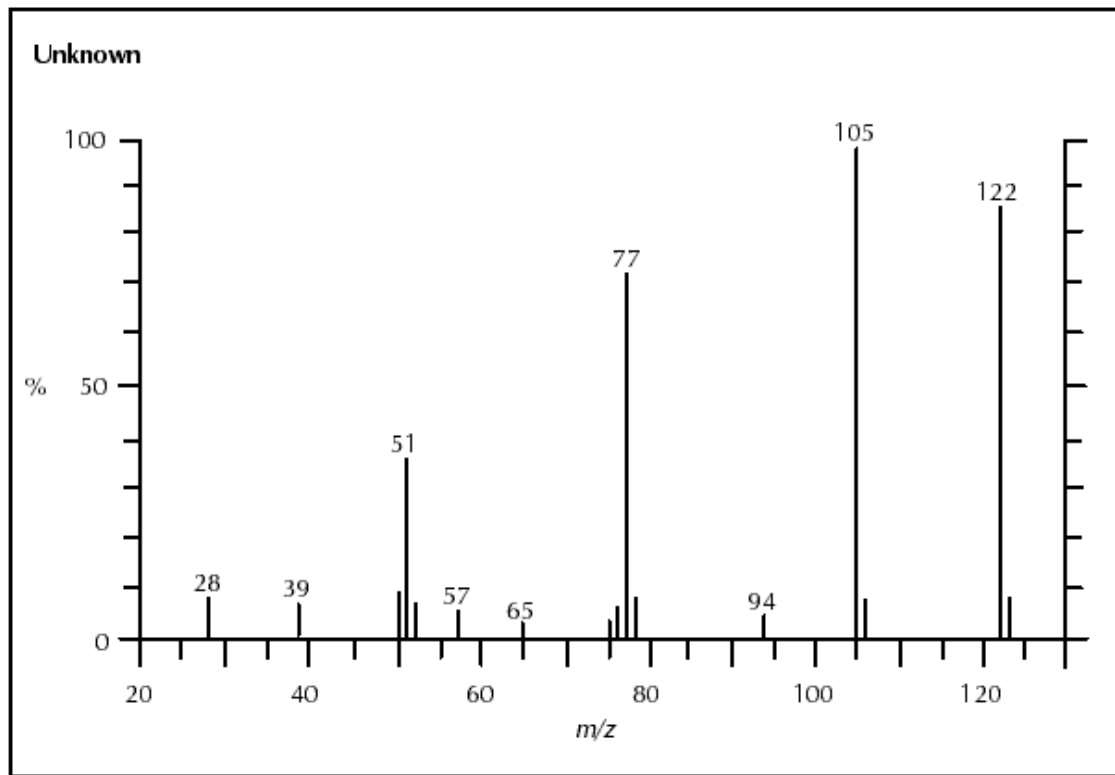

Some formulae corresponding to nominal $m/z = 122$

Formulae	Actual mass
$C_4H_4N_5$	122.046668
$C_4H_{10}O_4$	122.057903
$C_6H_4NO_2$	122.024201
$C_6H_6N_2O$	122.048010
$C_6H_8N_3$	122.071819
<u>$C_7H_6O_2$</u>	<u>122.036776</u>
<u>C_7H_8NO</u>	<u>122.060585</u>
$C_7H_{10}N_2$	122.084394
$C_8H_{10}O$	122.073161
$C_8H_{12}N$	122.096970
C_9H_{14}	122.109545

These are based on the following relative atomic masses:

C =	12.0000000
H =	1.0078246
N =	14.0030738
O =	15.9949141

- In general, more ions have the same nominal mass
- To distinguish between them certain MS resolution is needed

- For example, to separate these 2 ions we need a resolution of 5 124

$$R = 122 / (122.060585 - 122.036776) = 5\ 124$$

Conversion of Analytical Results into the Toxic Equivalent (TEQ)

- This conversion is based on the assumption that all the 2,3,7,8-substituted PCDDs and PCDFs (17 cong.), as well as the dioxin-like PCBs (12 cong.), bind to the same receptor, the Ah receptor, and show comparable qualitative (toxic) effects, but with different potencies

- These differences in toxicity are expressed in the toxic equivalency factors (TEFs)

Congener	I-TEF	WHO-TEF	Congener	I-TEF	WHO-TEF
2378-TCDD	1	1	2378-TCDF	0.1	0.1
12378-PeCDD	0.5	1	23478-PeCDF	0.5	0.5
123478-HxCDD	0.1	0.1	12378-PeCDF	0.05	0.05
123678-HxCDD	0.1	0.1	123478-HxCDF	0.1	0.1
123789-HxCDD	0.1	0.1	123789-HxCDF	0.1	0.1
1234678-HpCDD	0.01	0.01	123678-HxCDF	0.1	0.1
OCDD	0.001	0.0001	234678-HxCDF	0.1	0.1
			1234678-HpCDF	0.01	0.01
			1234789-HpCDF	0.01	0.01
			OCDF	0.001	0.0001

- TEF of the most toxic 2378-TCDD = 1

$$TEQ = (PCDD_i \times TEF_i) + (PCDF_i \times TEF_i) + (PCB_i \times TEF_i)$$

Quality assurance/quality control (QA/QC)

Quality assurance

Preventive measures (quality of facilities, personnel and education, equipment and service, calibration, internal and recovery standards)

Quality control

Control measures (internal – blank and reference material analyses, external – interlaboratory comparison, audit)

Reasons

- repeatability of measurements**
- comparison of results between laboratories**
- political and economical importance of results**

Terminology

Calibration

Limit of detection and quantification

Sensitivity and specificity

Accuracy, trueness, precision

Method validation and verification

Internal standards

Recovery and surrogate recovery standards

Certified reference materials

interlaboratory calibration tests,

GLP

Standard operational procedure

- **General information (terminology, principles, range of use, limitations, safety procedures, toxicology, waste treatment)**
- **Directives**
- **Consumables and chemicals (glass, standards, solvents, reference materials)**
- **Equipment (sampling and analytical equipment, service)**
- **Calibration (standards, procedures)**
- **Analytical scheme (method validation and verification)**
- **Quality control (internal - blank, reference material, external – intercalibration)**
- **Data interpretation**
- **Annexes**

Mokr - pdy 2002 - 4

vyhodnoceno: 25.4.2003

Koncentrace ng/g

slo vzorku	bluen	02-753	02-752	02-740	02-741	02-742	02-743	02-744	02-745	02-746	02-747	02-748	02-749	02-750	02-751	
Lokalita	GC blank	Lab. blank	RM	454 Hosten	ihlky	332 Vodojem	Velk Bata1	Velk Bata2	Prostřed kopec	420Vel Bata	Chlumeck 1	Chlumeck 2	Hork mysl.	Nov pole	jižn CVM	LOQ
slo zadav				303S	304S	305S	306S	307S	308S	309S	310S	311S	312S	313S	314S	
Datum odb				14.11.02	14.11.02	14.11.02	14.11.02	14.11.02	14.11.02	14.11.02	14.11.02	14.11.02	14.11.02	14.11.02	14.11.02	KALIB30
Navž ka (g)	5,0	5,0	5,0	5,0	5,0	5,0	5,0	5,0	5,0	5,0	5,0	5,0	5,0	5,0	5,0	5,0
Ředn	1	1	1	1	1	1	1	1	1	1	1	1	1	1	1	1
Naftalen	0,10	1,86	26,74	12,5	6,6	7,5	5,2	5,5	11,8	13,5	7,1	6,6	8,6	5,9	8,5	0,10
Acenaftyle	-	0,02	0,58	0,8	0,3	0,7	0,4	0,5	2,2	1,8	0,6	0,5	1,2	2,4	0,8	0,10
Acenaften	-	0,04	1,22	1,4	0,3	1,4	1,6	0,6	5,3	3,4	2,5	0,8	2,0	5,4	1,2	0,10
Fluoren	-	0,04	2,26	1,7	0,6	1,4	1,3	0,7	4,9	3,8	2,0	1,0	2,2	4,7	1,5	0,10
Fenantren	-	0,12	23,96	24,9	6,4	20,5	18,8	8,4	69,1	59,4	14,2	13,6	29,5	109,3	16,8	0,10
Antracen	-	-	1,12	2,0	0,4	1,9	3,4	1,1	6,1	5,2	2,1	1,4	2,9	16,9	1,8	0,10
Fluoranten	-	-	27,78	68,2	13,7	58,0	42,0	24,2	213,0	162,5	40,7	37,6	82,5	450,2	42,9	0,10
Pyren	-	-	19,38	50,5	9,7	45,6	35,4	20,2	159,3	123,6	32,0	28,6	63,8	377,2	33,0	0,10
Benz(a)ant	-	-	4,60	17,9	2,9	14,4	14,7	9,1	61,5	49,3	18,3	13,1	26,3	206,3	13,6	0,10
Chrysen	-	-	11,50	32,4	7,3	25,6	18,4	12,2	102,6	75,9	22,3	16,8	41,2	204,2	20,0	0,10
Benzo(b)flu	-	-	18,30	61,0	11,7	32,2	23,6	20,4	169,5	128,2	28,0	29,4	67,7	261,1	31,2	0,10
Benzo(k)flu	-	-	6,04	18,1	3,8	14,4	11,0	7,9	56,4	41,9	13,0	11,2	22,4	134,8	11,6	0,10
Benzo(a)py	-	-	8,34	27,6	3,5	23,6	20,3	13,3	92,8	71,6	24,2	18,4	38,4	285,9	21,3	0,10
Indeno(123	-	-	8,22	33,1	6,4	21,4	14,8	11,1	98,7	72,0	22,6	19,6	41,0	216,1	20,7	0,10
Dibenz(ah)	-	-	0,82	2,7	0,6	2,4	1,6	0,9	7,1	8,3	1,8	2,3	4,1	25,8	1,8	0,10
Benzo(ghi)	-	-	11,26	29,7	5,3	20,6	14,8	11,4	83,9	61,4	19,4	16,3	36,0	181,8	18,5	0,10
Suma PAH	0,10	2,08	172,12	384,5	79,5	291,6	227,3	147,5	1144,2	881,8	250,8	217,2	469,8	2488,0	245,2	1,60
100% D-PAH	2 000	2 000	2 000	2 000	2 000	2 000	2 000	2 000	2 000	2 000	2 000	2 000	2 000	2 000	2 000	
ředn	1	1	1	1	1	1	1	1	1	1	1	1	1	1	1	
D8-naftalen	0%	0%	88%	72%	79%	66%	65%	80%	62%	66%	21%	61%	75%	81%	81%	
D10-fenant	0%	0%	90%	77%	91%	68%	72%	86%	77%	79%	88%	79%	85%	94%	92%	
D12-peryle	0%	0%	86%	74%	34%	67%	73%	86%	83%	83%	89%	82%	93%	101%	96%	

GC blank slep vzorek pstroje GC-MS - nstřik čistho rozpouštdla do plynovho chromatografu

Lab. blank laboratorn slep vzorek - analyzovan celm analytickm postupem s čistmi rozpouštdly a vemi použitmi materily

GPC blank slep vzorek GPC chromatografu

blank, GF blank ternn slep vzorky - pasivn odbr na polyuretanovou pnu a sklenn vlkno

CRM analza certifikovanho referennho materilu

RM analza laboratornho referennho materilu

NQ nekvantifikovno - analyt byl pekryt interferentem

LOQ meze stanovitelnosti

