

# Fyziologie působení farmak a toxických látek

Endokrinní disrupce - obratlovci

# Endokrinní disrupce

- endokrinní disruptor - látka, která interferuje se syntézou, sekrecí, transportem, vazbou na receptor, aktivitou receptoru nebo eliminací hormonu v těle;
- dosud byla pozornost věnována hlavně látkám interferujícím s pohlavními hormony - estrogeny a androgeny, a thyroïdními hormony;
- řada pesticidů či jejich metabolitů je v exp. podmínkách schopná chovat se jako estrogeny, antiandrogeny apod. - problematické koncentrace a epidemiologické studie;

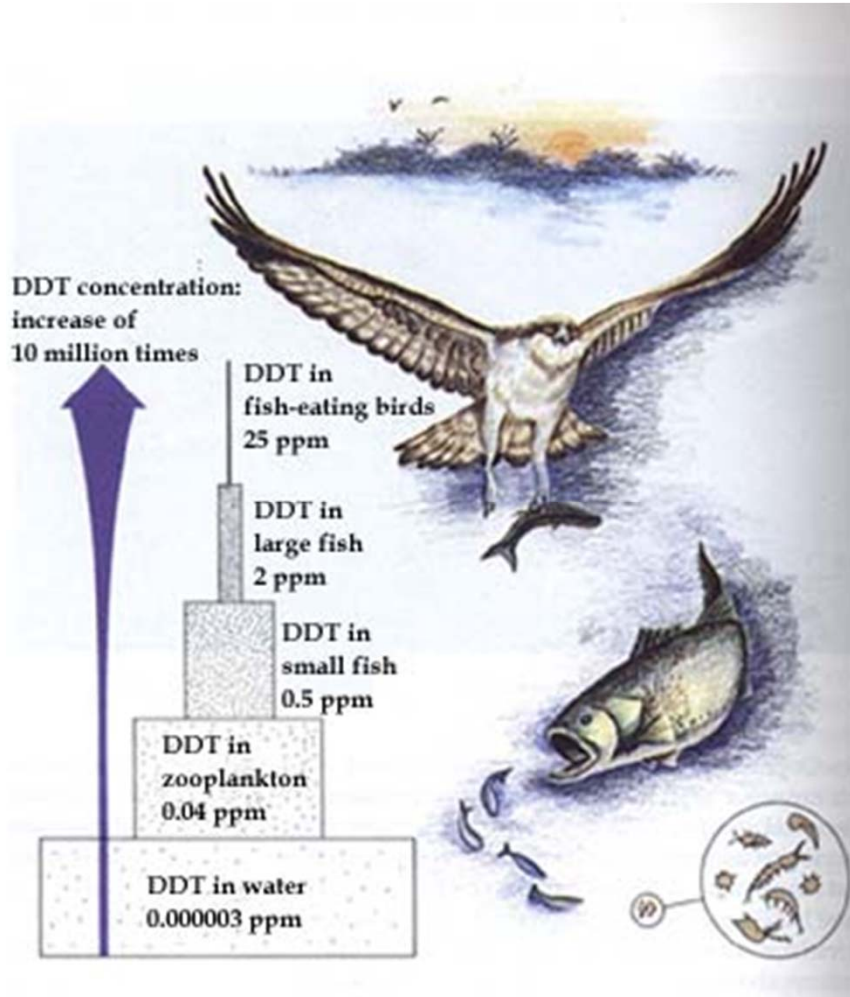
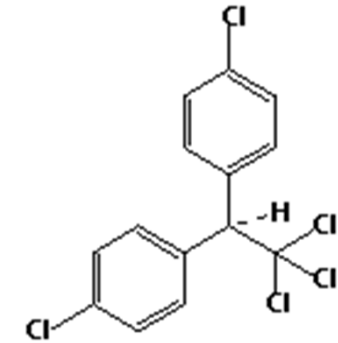
## Výzkum endokrinní disrupce je soustředěn do dvou oblastí:

- obratlovci, kteří alespoň část svého životního cyklu tráví ve vodním prostředí - ryby, obojživelníci - expozice vodou, potravou;
- terestričtí obratlovci - expozice především v rámci potravního řetězce;

Nejohroženější skupina - vrcholoví konzumenti - dravci.

<http://www.epa.gov/endo/>

# Biomagnifikace a bioakumulace



- 1,1,1-trichlór-2,2-bis(4-chlórphenyl)ethan;
- syntetizován v 19. století – insekticidní účinky popsány v roce 1939; v roce 1948 obdržel P. H. Müller Nobelovu cenu za medicínu;
- využití k likvidaci komárů – eradikace malárie na rozsáhlých územích;
- v roce 1972 bylo jeho používání v USA a řadě dalších zemí postupně zakázáno, nicméně v řadě rozvojových zemí se používá dodnes; WHO nedávno schválila jeho použití v oblastech s vysokým výskytem komárů přenášejících malárii – indoor appl.



## Endocrine Disruption in Wildlife

- Eggshell thinning in raptors from **DDT**
- Beak, skeletal, reproductive abnormalities from **PCBs** (bald eagles, gulls, cormorants)
- Intersex fish below UK sewage effluents from **estradiol, alkylphenols**
- Decreased plasma sex steroids, egg and gonadal size; delayed sexual maturity from **dioxin** below paper mills (Great Lakes white suckers)
- Poorly developed testes, small penises, low testosterone; abnormal ovaries; males with high estradiol; poor hatchling success from **DDE** (Lake Apopka alligators)

## Endocrine Disruption in Lab

- Masculinization of females by **kepone, DDT, methoxychlor**
- Disruption of estrous cycle by **atrazine, choroquine**
- Hypospadias, vaginal pouches, reduced sperm production in males exposed to **vinclozolin in utero**
- Impaired testosterone synthesis, and spermatogenesis; decreased anogenital distance, delayed testis decent, impaired and feminized behavior of rats by **dioxin**
- Acceleration of puberty and loss of fertility in females by **many estrogenic chemicals**
- Delay of puberty, binding to androgen receptor; nipple retention in males by **many estrogenic chemicals**
- Atrophy of the thymus by **PCBs and dioxin**

## Evidence for ED in Humans

- Genital malformation (boys), vaginal cancer, infertility (girls) exposed in utero to **DES**
- Neurological effects, decreased growth, developmental abnormalities (e.g., penis size) in children exposed in utero to **PCBs**
- Altered girl/boy ratio after population exposure to **dioxin** (Saveso, Italy)
- Shortened lactation associated with **DDE**
- Decreased sperm count and quality
- Increased prostate, testicular, breast cancer

## Human Breast Cancer

- Breast cancer has increased

**but**

- Epidemiological studies are conflicting -  
It is not possible to assign a specific  
chemical or physical cause at this time
- **Better animal models are needed to  
predict human risk**

## Human Sperm Counts

Carlsen et al, 1992 meta-analysis: 61 studies

- Suggests 50% decline in count, volume
  - Decline seen in both Europe and US
- but
- Large geographic variation among studies
  - Potential selection bias, other confounders

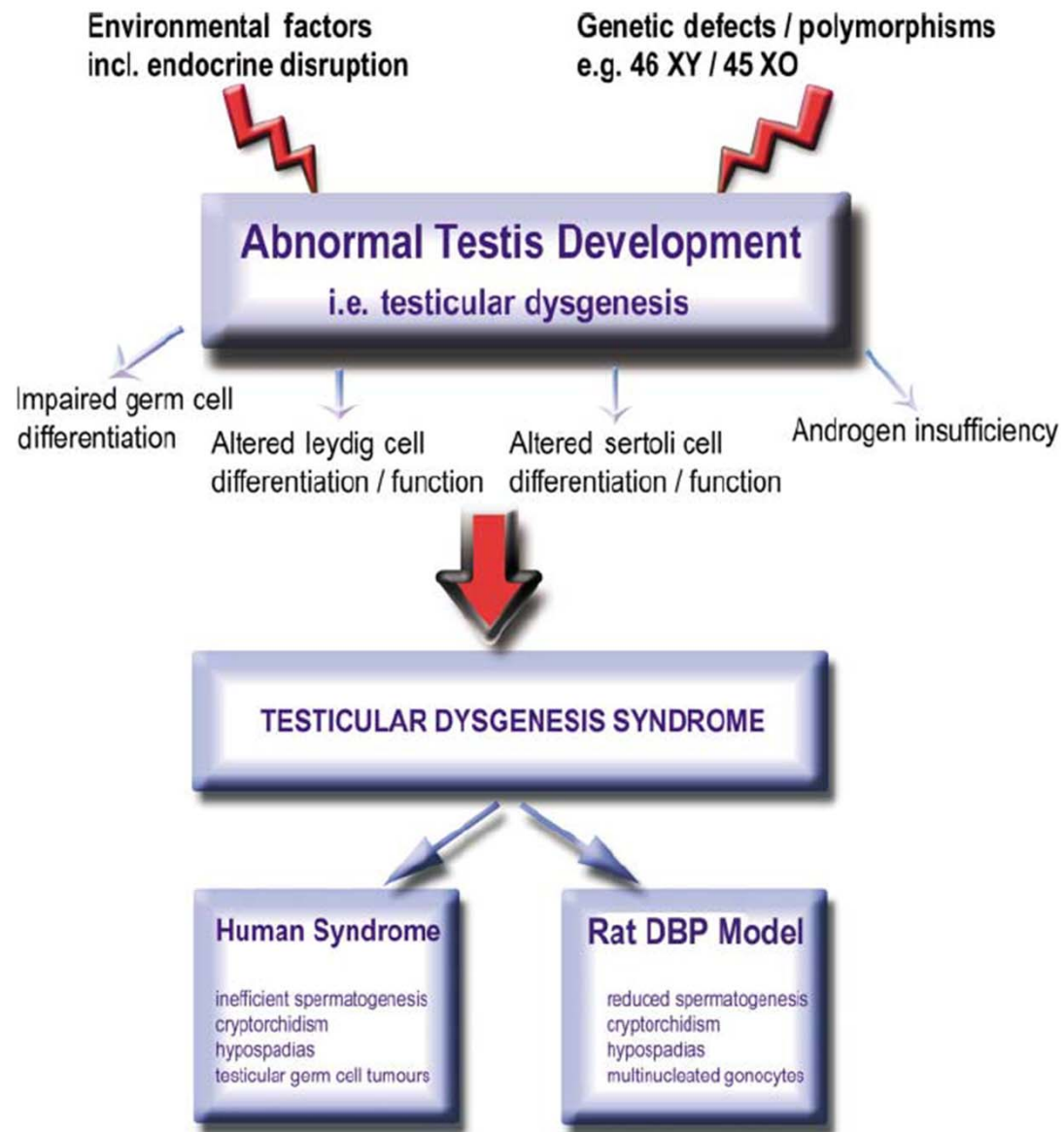
**A large, carefully controlled prospective study is needed for confirmation**

# Testicular Cancer

- Increase in testicular cancer observed in most countries
  - Affects mostly ages 15-45
  - Year of birth, birth weight, genital tract abnormalities are risk factors
  - Evidence suggests high estrogen environment during fetal life may be involved
- but
- No increase in testicular cancer in DES sons



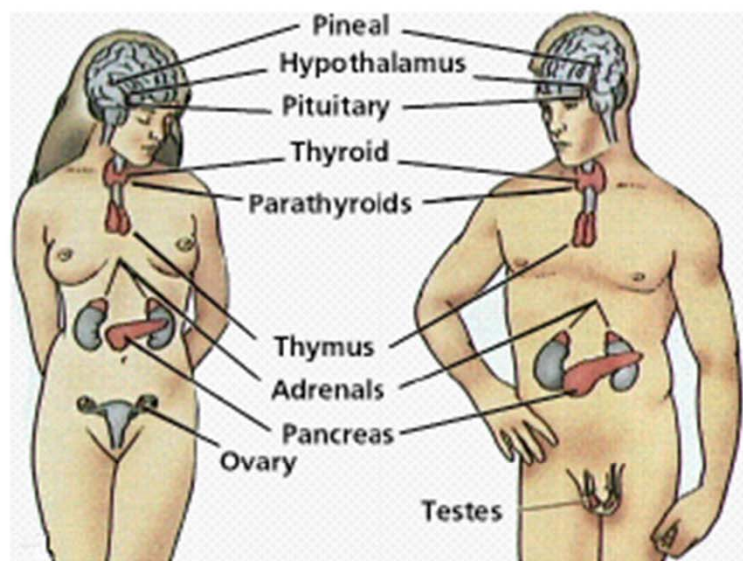
# TDS = testicular dysgenesis syndrome



**Figure 1** Schematic representation of the potential pathogenic links between testis development and the clinical manifestations of testicular dysgenesis syndrome (TDS). The similarities in the pathologies induced by *in utero* dibutyl phthalate (DBP) administration and human TDS are compared.

## Endocrine (hormonal) system regulates

- **Metabolic function and equilibrium**
- **Reproduction**
- **Growth/development**



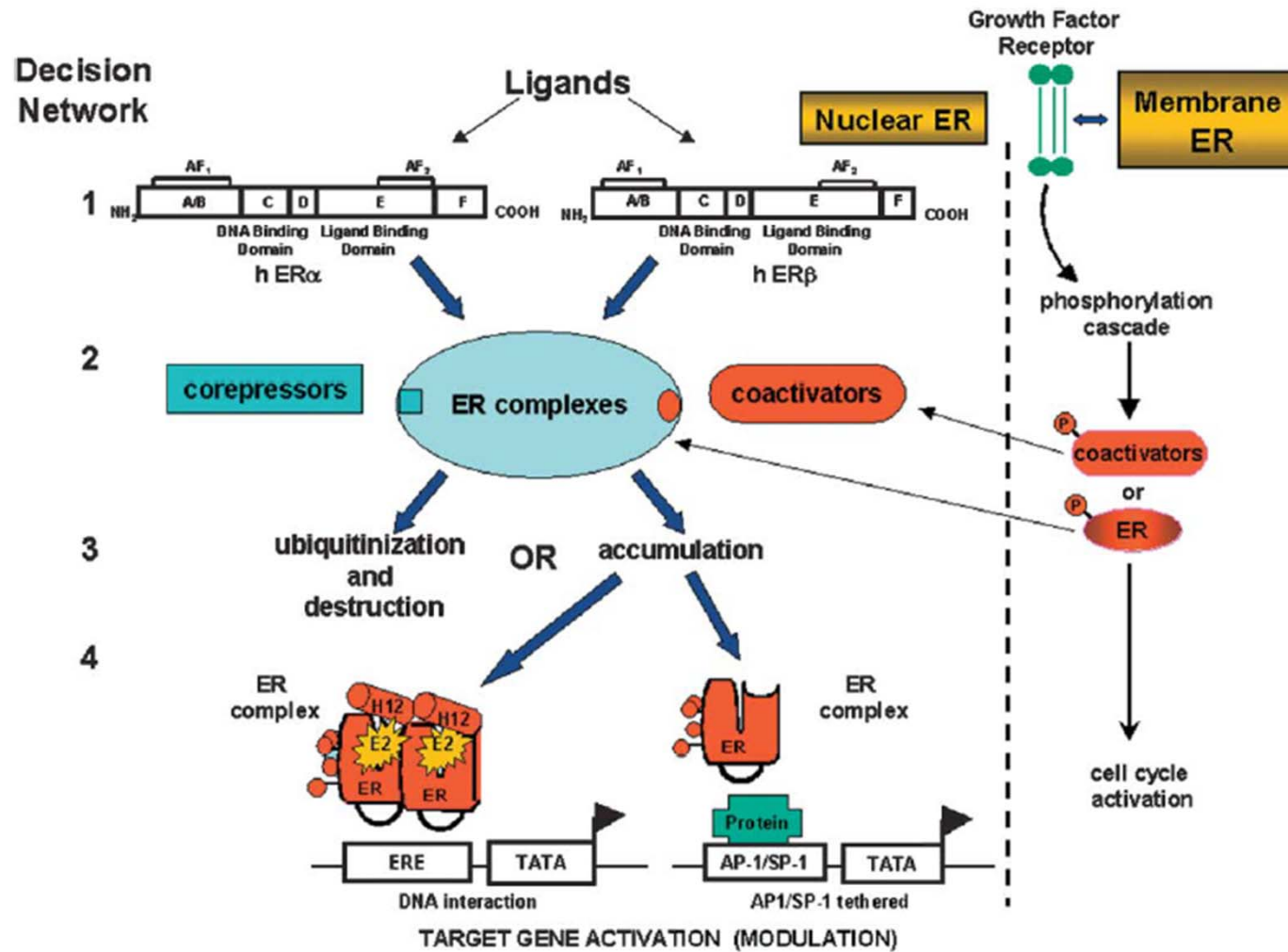
**There are over 50 different hormones**

# Environmental estrogens (xenoestrogens)

- Sources
  - pesticides
  - plastics
  - pharmaceuticals
  - some cleansers
  - contraception
- vs. phytoestrogens
  - antiherbivore compounds in many plant species
  - lignans (many fruits, vegetables), isoflavones (soy)



# Možnosti účinků environmentálních estrogenů na buněčné úrovni



## Environmentální estrogeny:

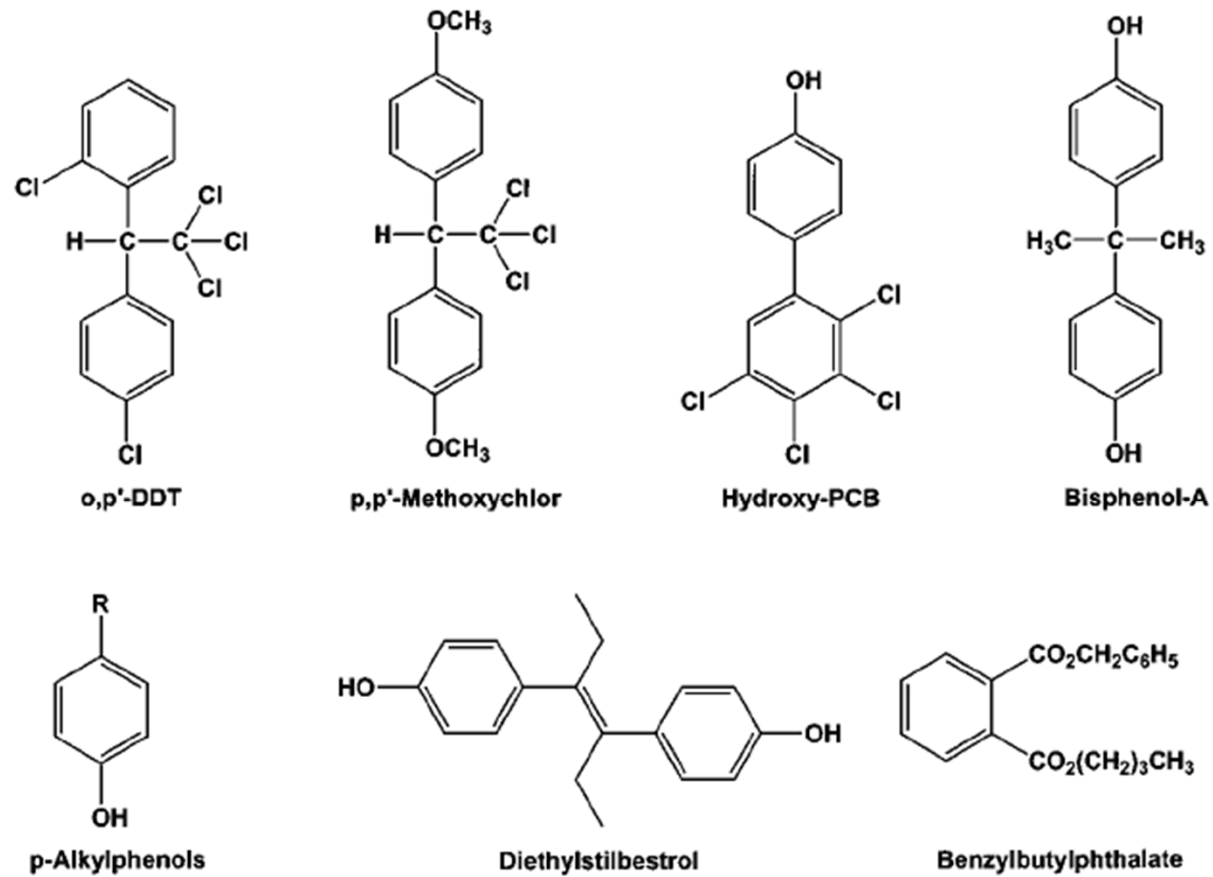


Figure 2 Structures of some xenoestrogens.

## Environmentální antiandrogeny:

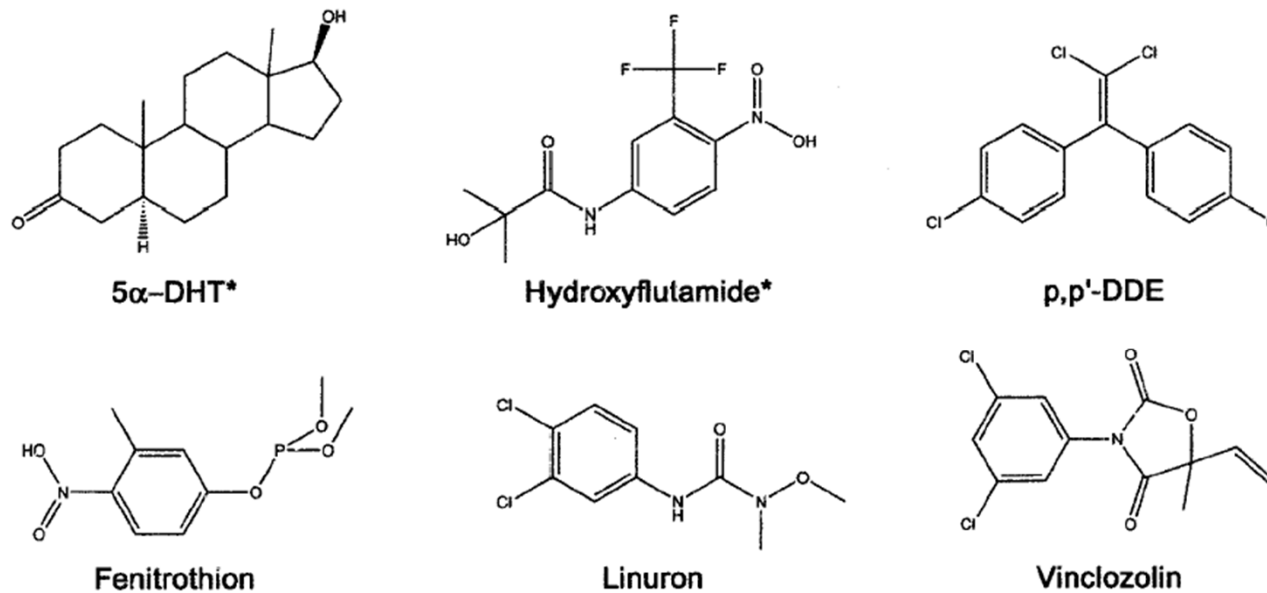


FIG. 2. Structural diversity among environmental chemicals reported to be antiandrogenic. The steroidal androgen, 5α-dihydroxytestosterone (5α-DHT) and its pharmaceutical antagonist, hydroxyflutamide, are shown for comparison. *p,p'*-DDE is a persistent contaminant, while the remaining are currently used pesticides: fenitrothion, an insecticide; linuron, an herbicide; and vinclozolin, a fungicide.

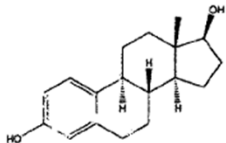
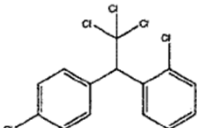
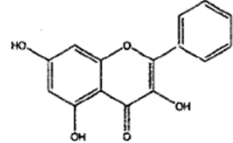
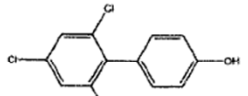
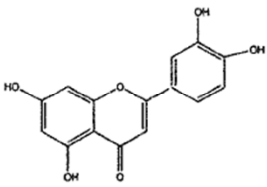
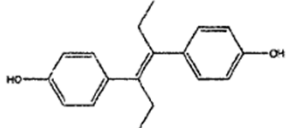
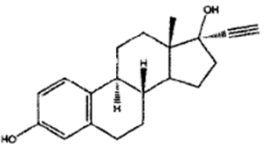
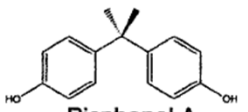
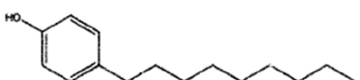
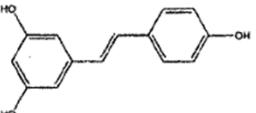
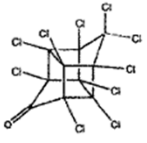
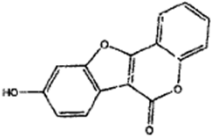
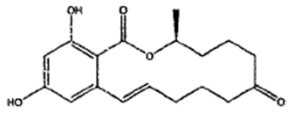
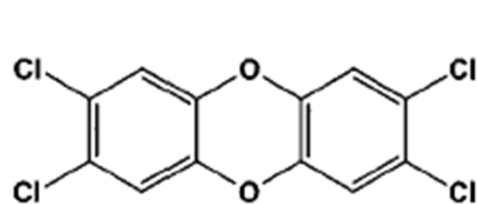
Steroids	Pollutants	Plant Products
 <p data-bbox="651 427 801 459">17β-Estradiol</p>	 <p data-bbox="1093 432 1144 459">DDT</p>	 <p data-bbox="1368 443 1630 475">Genistein (isoflavone)</p>
<p data-bbox="618 555 875 587">Pharmaceuticals</p>	 <p data-bbox="1093 639 1144 667">PCB</p>	 <p data-bbox="1384 707 1585 738">Luteolin (flavone)</p>
 <p data-bbox="645 778 846 810">Diethylstilbestrol</p>  <p data-bbox="645 970 846 1002">Ethynyl Estradiol</p>	 <p data-bbox="1059 815 1193 847">Bisphenol A</p>  <p data-bbox="1037 991 1193 1023">Nonylphenol</p>	 <p data-bbox="1368 938 1630 970">Resveratrol (stilbene)</p>
<p data-bbox="618 1082 875 1114">Fungal Products</p>	 <p data-bbox="1070 1225 1160 1257">Kepone</p>	 <p data-bbox="1361 1161 1630 1193">Coumestrol (coumarin)</p>
 <p data-bbox="667 1281 837 1313">Zearalenone</p>		

FIG. 5. Chemicals found in the environment reported to be estrogenic. This list is not comprehensive, but illustrates representative structures of estrogenic compounds from various sources. Information on these compounds is contained in the text.

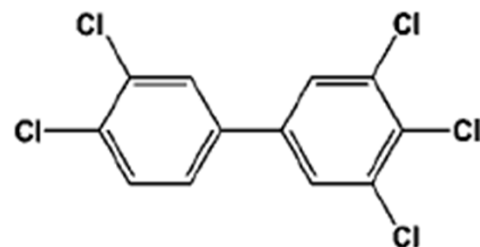
## Xenoestrogens and xenoandrogens can:

- Mimic or partly mimic the sex steroid hormones estrogens and androgens (the male sex hormone) by binding to hormone receptors or influencing cell signaling pathways. Those that act like estrogen are called **environmental estrogens**.
- Modify the making and function of hormone receptors.
- Block, prevent and alter hormonal binding to hormone receptors or influencing cell signaling pathways. Chemicals that block or antagonize hormones are labeled **anti-estrogens** or **anti-androgens**.
- Alter production and breakdown of natural hormones.

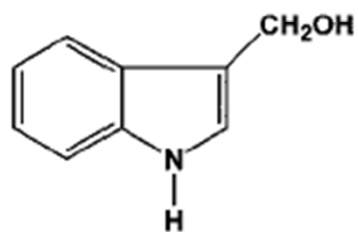
## Interakce AhR a ER:



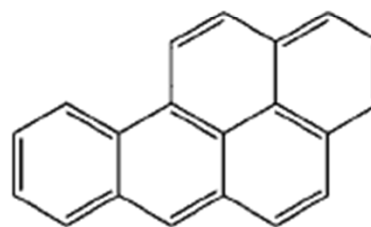
2,3,7,8-TCDD



3,3',4,4',5-pentaCB

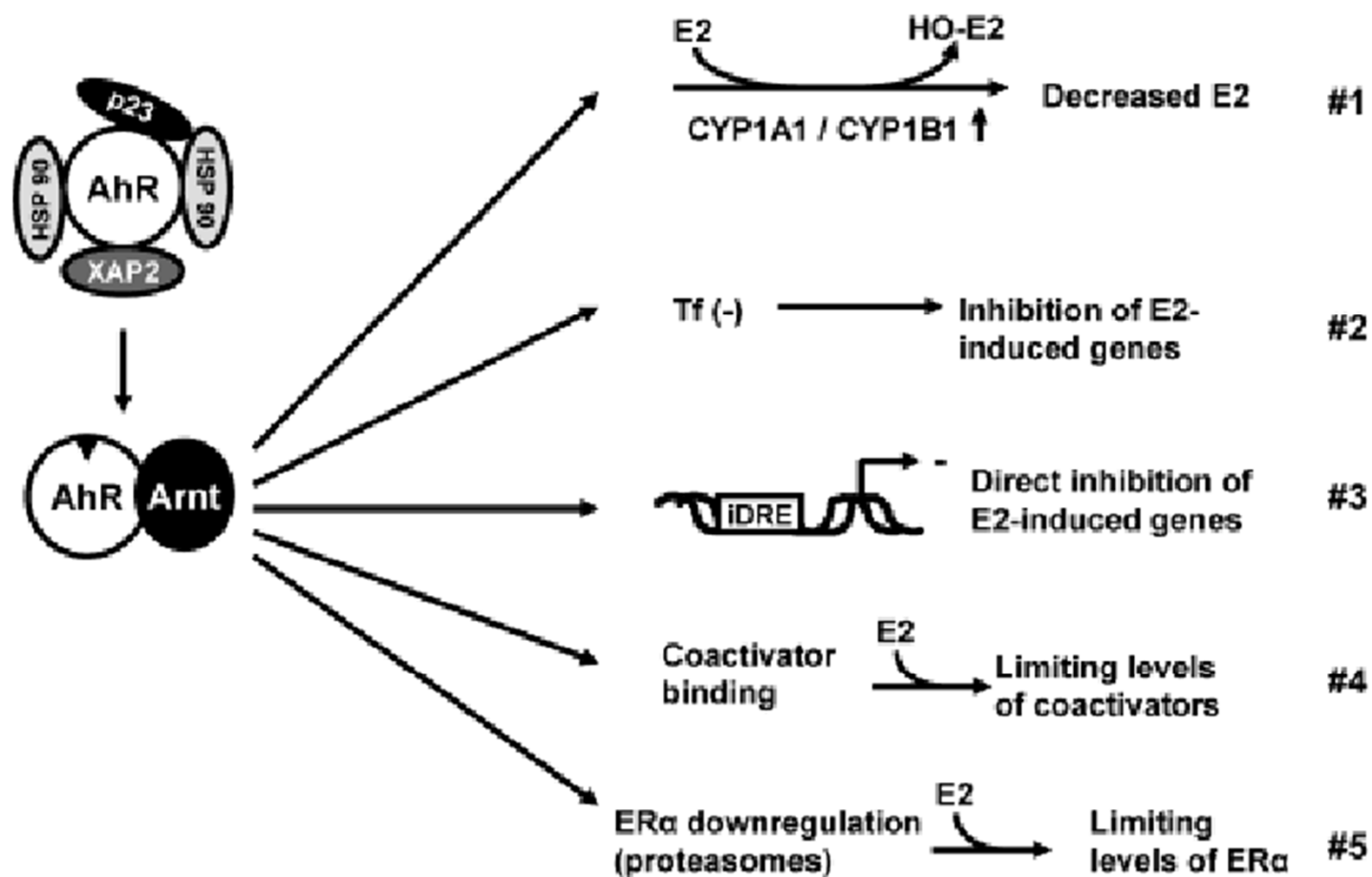


I3C



BaP

Figure 5 2,3,7,8-Tetrachlorodibenzo-*p*-dioxin (TCDD) and related compounds that bind to the AhR.



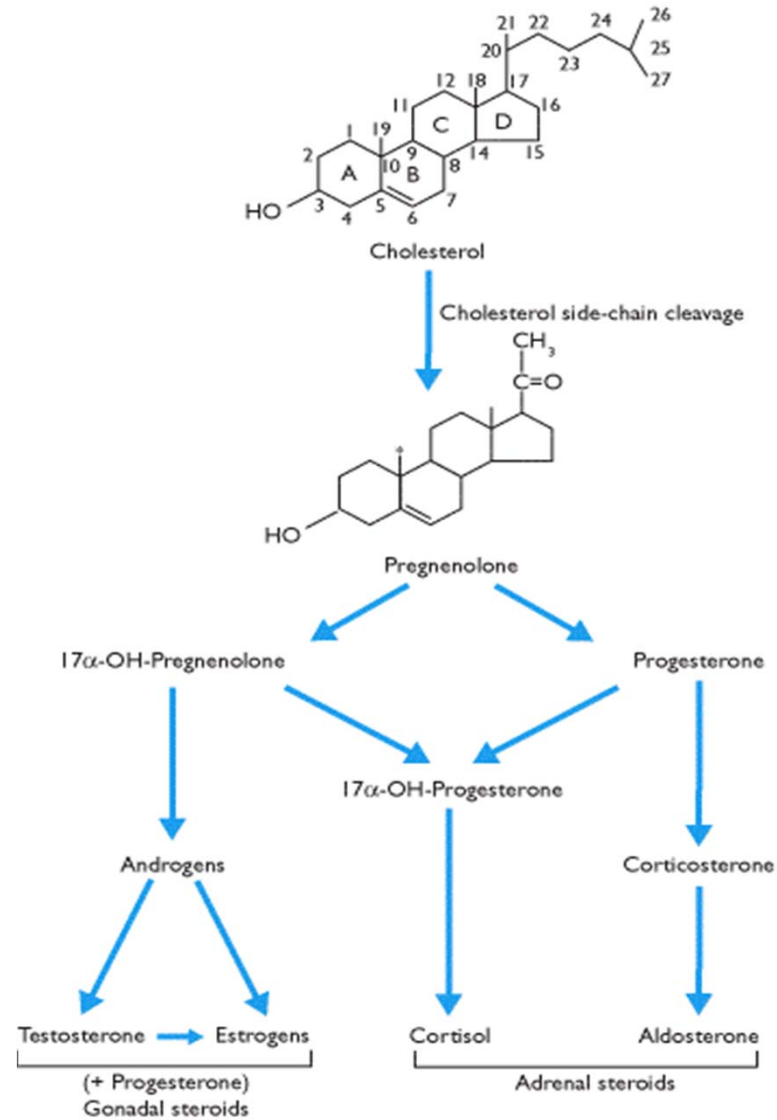
**Figure 3.** Proposed mechanisms of inhibitory AhR-ER $\alpha$  cross-talk (123-126).

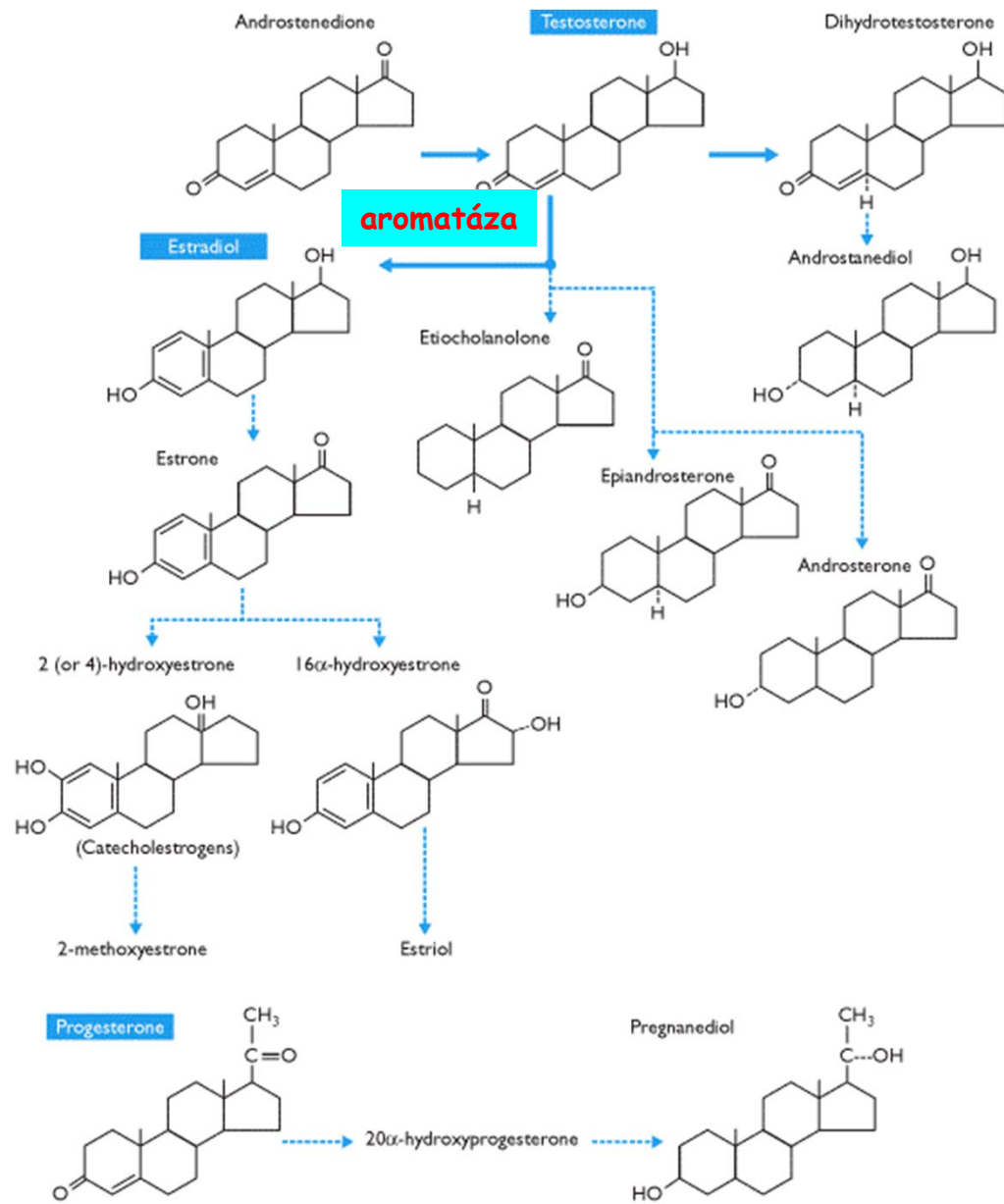
## Hormonální přípravky jako EDs - ethinylestradiol

- Male fish living near municipal sewage outlets in England had both male and female sex characteristics and their livers produced vitellogenin, a female egg-yolk protein not normally found in males
- cancers of the female and male reproductive tract
- malformed Fallopian tubes, uterus and cervix
- altered bone density and structure
- abnormal blood hormone levels
- reduced fertility
- altered sexual behavior
- modified immune system



## Biosyntéza steroidních hormonů a endokrinní disrupce:



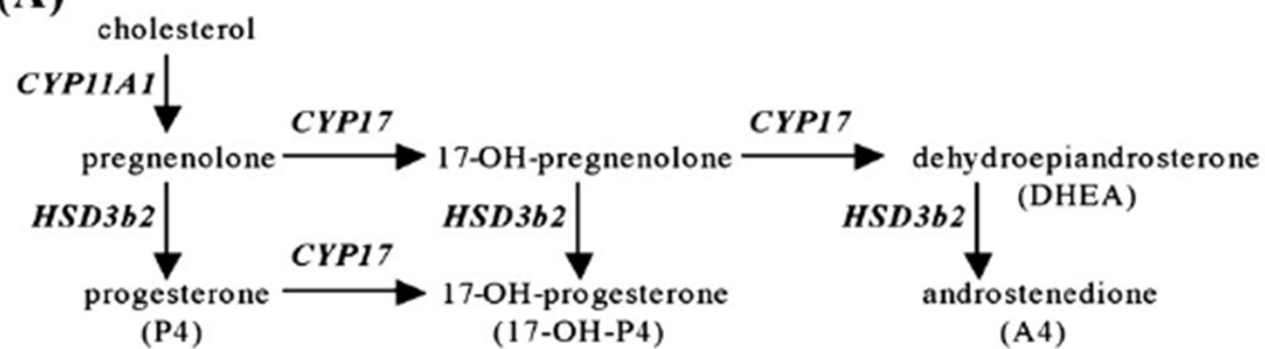
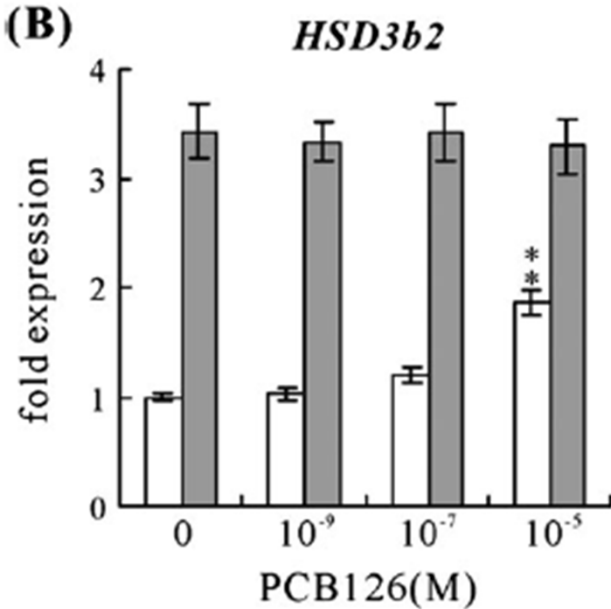
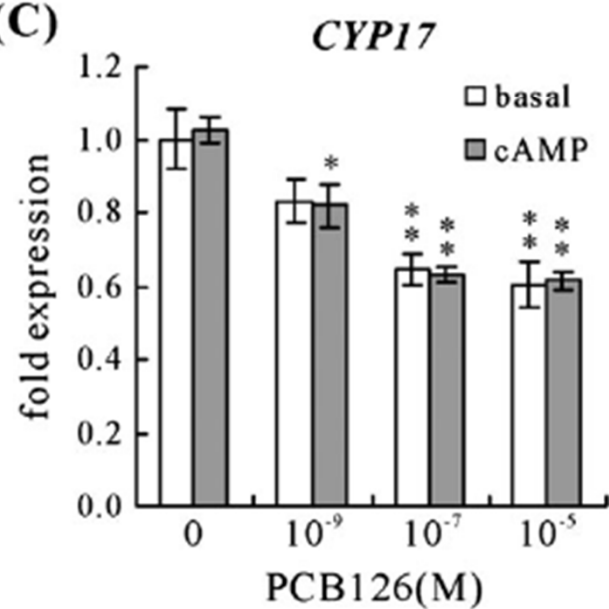


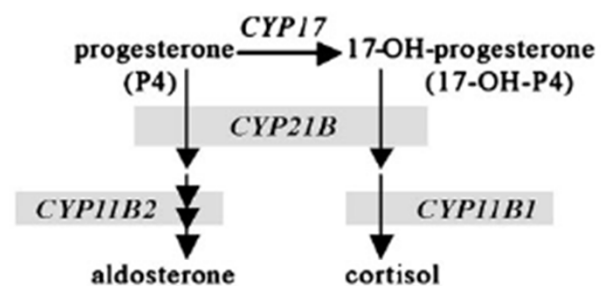
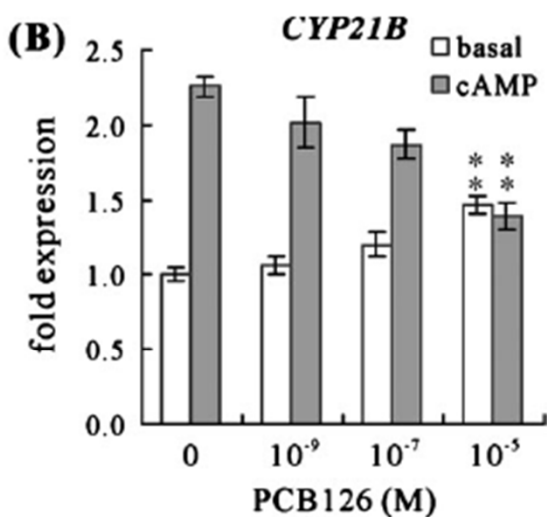
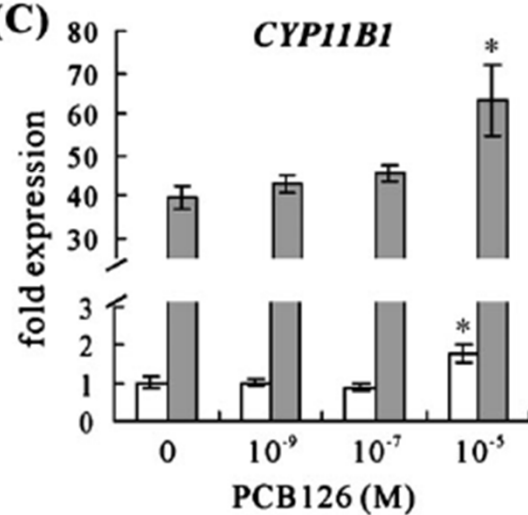
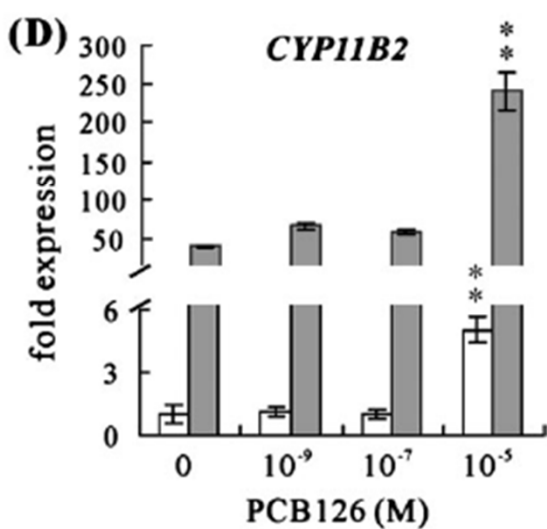
**In vitro model:**

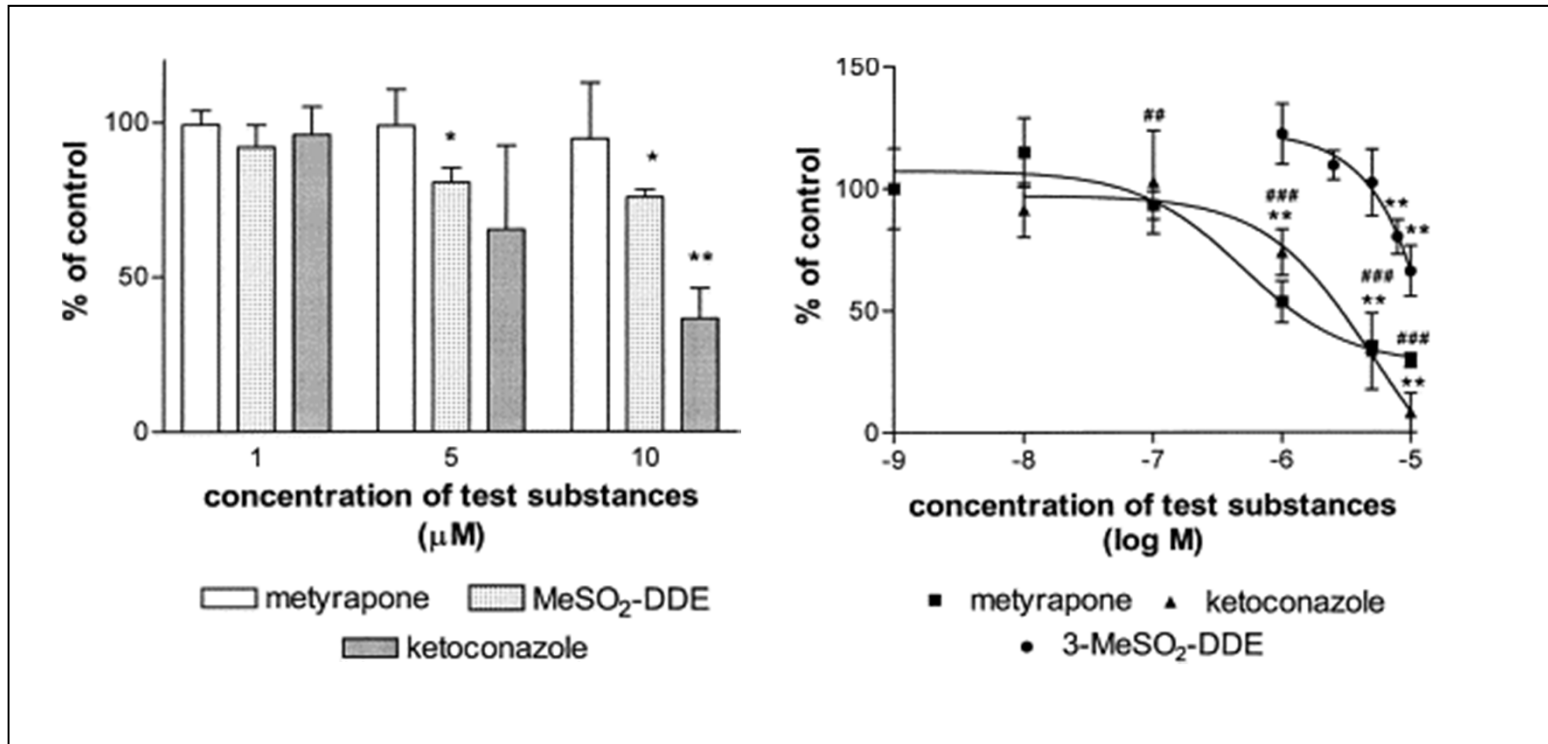
**buňky H295R**

Buněčná linie odvozená od karcinomu kůry nadledvinek, která je schopna in vitro produkovat většinu steroidogenních enzymů:

- aktivita enzymů;
- exprese enzymů na úrovni mRNA a proteinu

**(A)****(B)****(C)**

**(A)****(B)****(C)****(D)**



Effects of test substances on cortisol and 11-deoxycortisol formation in H295R cells, assumed to represent CYP11B and CYP21 activity.

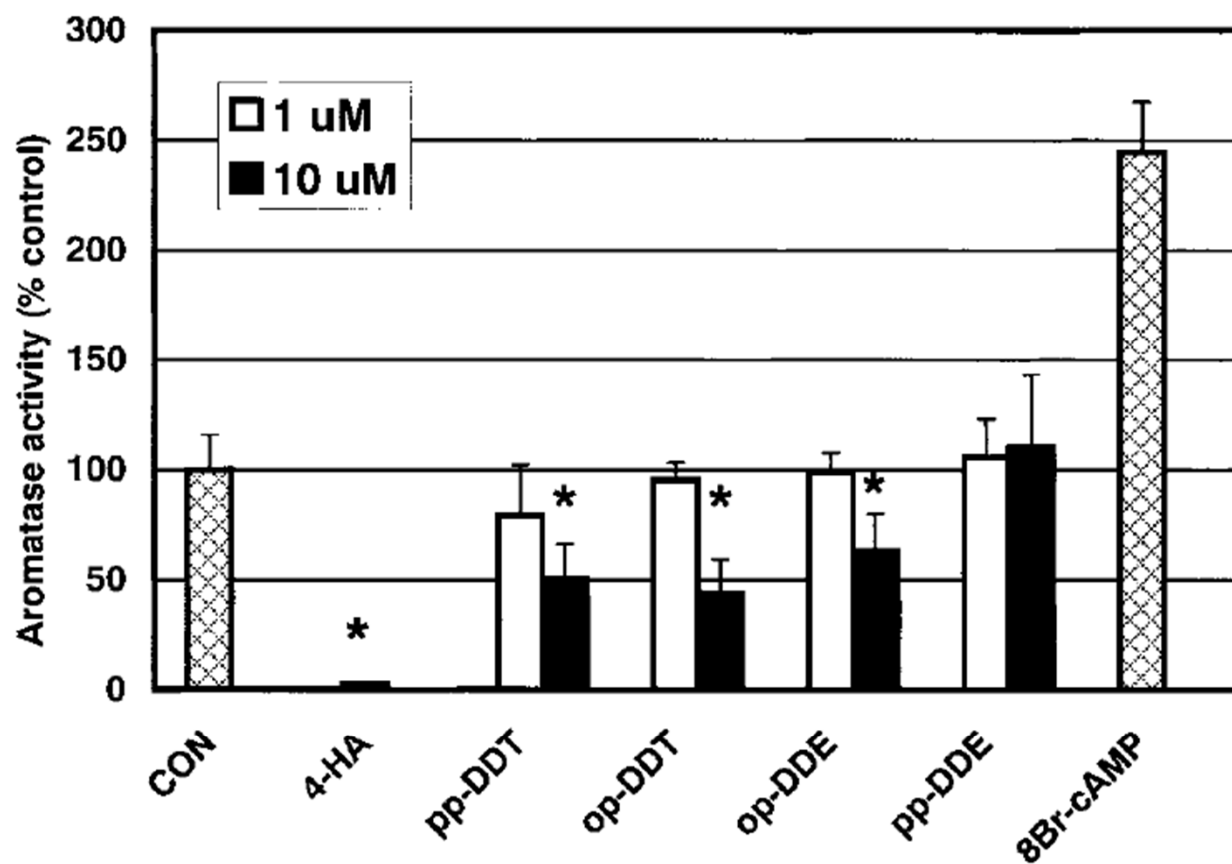


FIG. 2. Effect of 4-hydroxyandrostenedione (4-HA; 1  $\mu$ M), DDT, three of its metabolites (1 or 10  $\mu$ M) or 8-bromo-cyclic adenosine monophosphate (8Br-cAMP; 300  $\mu$ M) on aromatase activity in H295R cells. Exposures were for 24 h, in quadruplicate. \*Significantly lower than control.

## Testy estrogenity a antiestrogenity

In vitro assay	Measured endpoint	Advantages	Limitations
E-Screen	Proliferation of ER $\alpha$ -positive cells	Measures physiological endpoint of estrogen action, measures estrogens and antiestrogens	No defined ER expression, no mechanistic data
Ligand-binding (EDSTAC) <sup>a</sup>	Binding affinity to ER $\alpha$ or ER $\beta$	Simple, high-throughput method	Does not measure ER activation, does not measure physiological response
ER-binding to ERE	Binding affinity of ER $\alpha$ or ER $\beta$ to ERE	High-throughput method, various EREs can be used	Does not measure ER activation, low sensitivity, does not measure physiological response
GST pull-down/FRET/two-hybrid assay	Ligand-dependent association of ER $\alpha$ or ER $\beta$ with co-activators	Analysis of molecular interaction, defined ER subtype or ER domain as well as co-activators can be used, measures estrogens and antiestrogens	Does not measure direct ER activation, low throughput, does not measure physiological response
Transactivation assay in yeast or mammalian cells (EDSTAC) <sup>a</sup>	ER $\alpha$ or ER $\beta$ mediated activation of reporter	High-throughput method, measures estrogens and antiestrogens, can be done in metabolic competent cells to account for (anti)-estrogenic metabolites	Does not measure physiological response
Analysis of gene expression	Expression of ER-regulated genes	Analysis of physiological response, versatile, measures estrogens and antiestrogens	Low throughput
Analysis of enzyme activity	Activity of ER-regulated enzymes	Analysis of physiological response, measures estrogens and antiestrogens	Cell lines or primary cell cultures with active marker enzymes suitable only
Analysis of steroidogenesis (EDSTAC) <sup>a</sup>	Induction/inhibition of estrogen biosynthesis	Analysis of physiological response, measures ER-independent pathways	Cells with active steroidogenesis suitable only



## Mikrobiální syntéza androgenů??

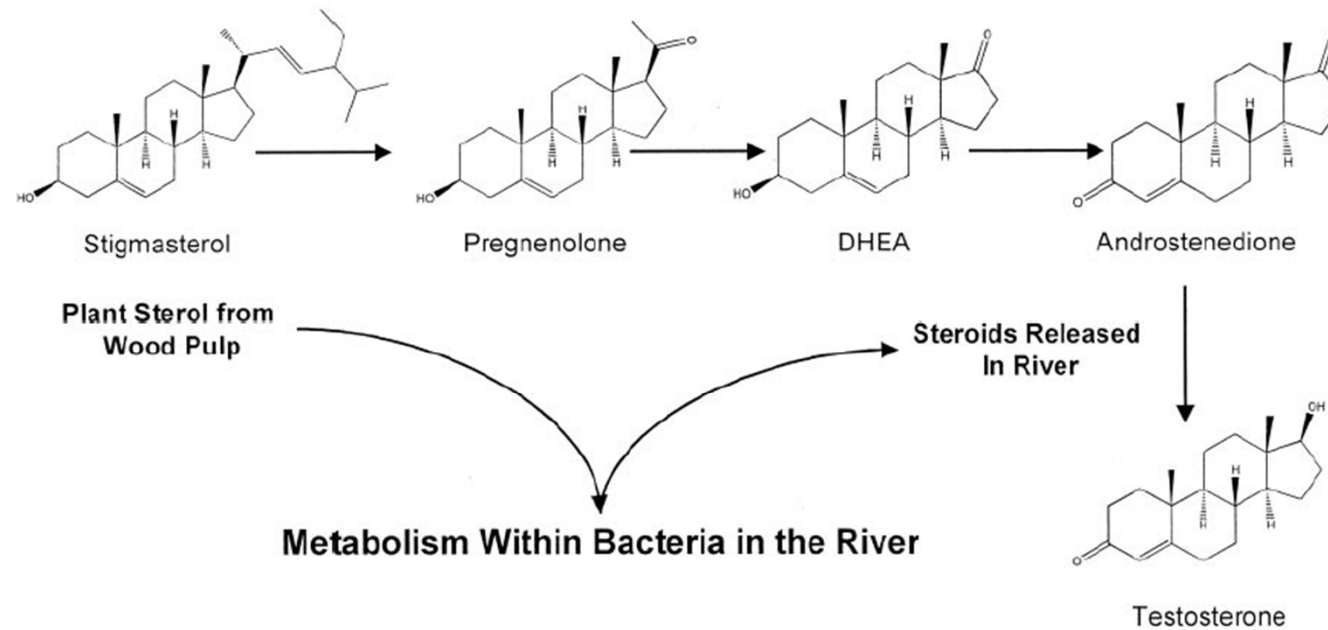


FIG. 3. The production of androgenic compounds by bacteria. Stigmasterol, a major plant sterol found in wood pulp, is efficiently metabolized to androgenic steroids such as androstenedione by the bacteria, *Mycobacterium smegmatis*. *M. smegmatis* form extensive colonies, or “bacterial mats,” at the effluent site of pulp and paper mills. The natural plant sterol, stigmasterol, contained in the pulp effluent is converted by *M. smegmatis* into androstenedione, which is released into the river or stream. Female mosquito fish exposed to these androgens develop male structures. (See Refs. 34, 35, and 36 for details.)

Většina látek narušujících androgenní dráhy jsou  
antiandrogeny!!!!

## Anti-androgenic compounds in the environment

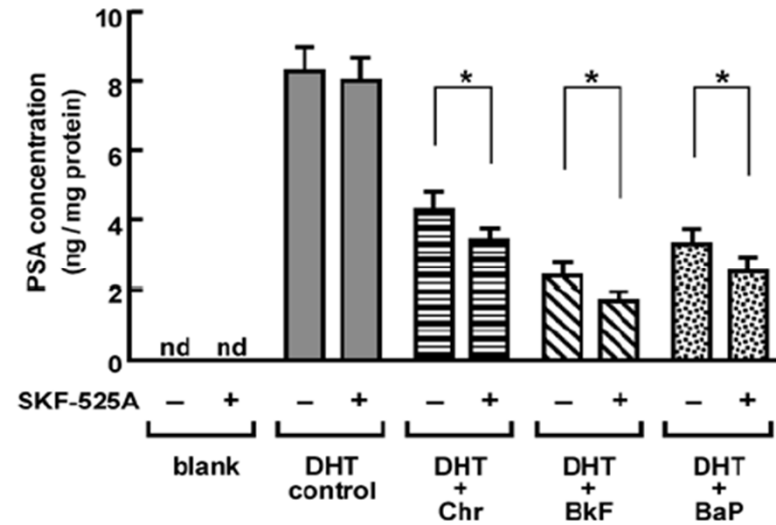
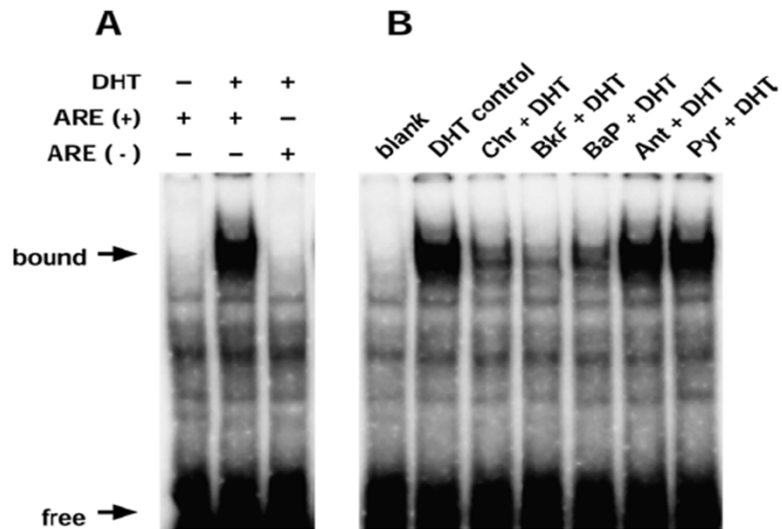
There are a number of commonly used environmental chemicals that have been identified as having anti-androgenic properties. These chemicals have been administered to pregnant rodents during the period of reproductive tract development. When the male pups were examined, they displayed many of the abnormalities associated with flutamide administration.

Some chemicals (vinclozolin, procymidone, linuron, p,p'-DDE (1,1,1-dichloro-2,2-bis(pchlorophenyl)ethane) act as androgen receptor antagonists, others (phthalate esters) reduce androgen synthesis, but it is likely that other modes of action are also involved in the toxicity induced by these compounds.

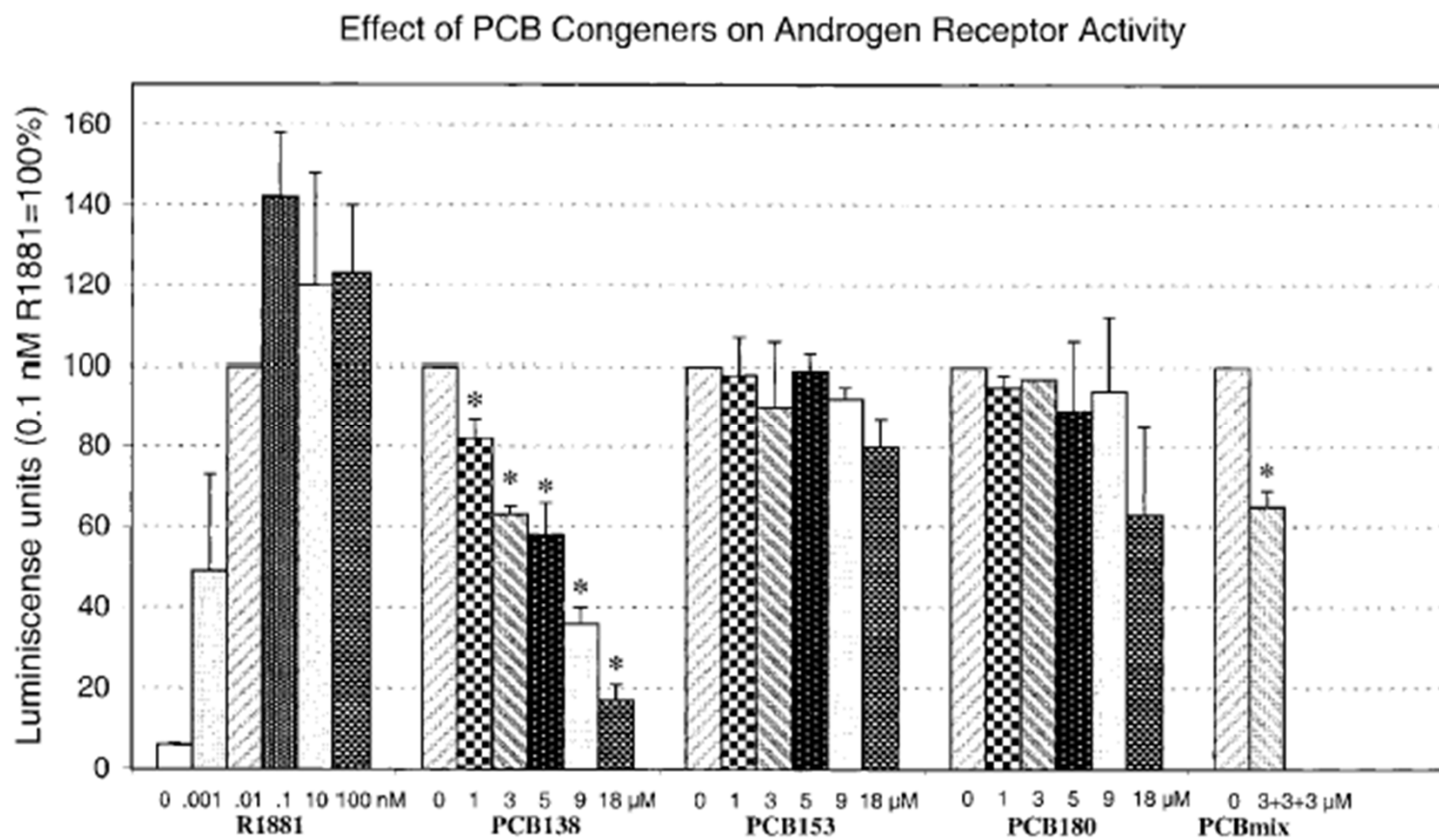
There are major problems in comparing the published studies of the effects of anti-androgenic compounds / inconsistent protocols.

**Human impact????**

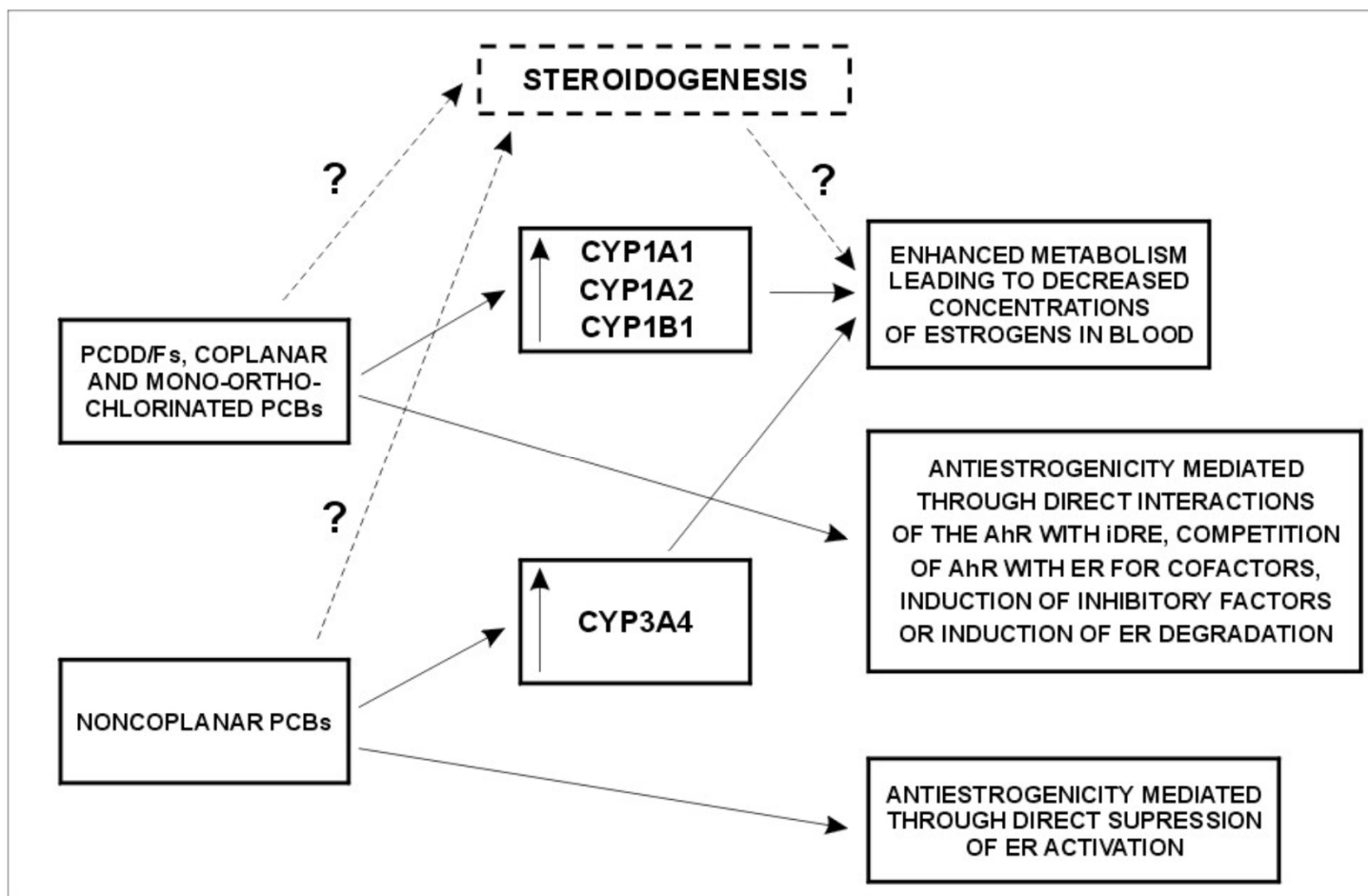
## Polycyklické aromatické uhlovodíky mají antiandrogenní účinek:



## Antiandrogenní účinky PCB:

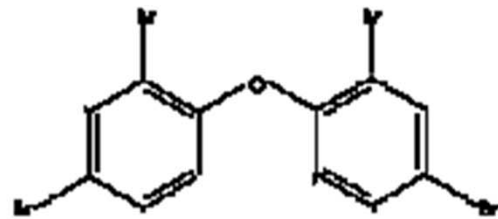


## Interakce polutantů s endokrinní dráhou = velmi složitý proces:

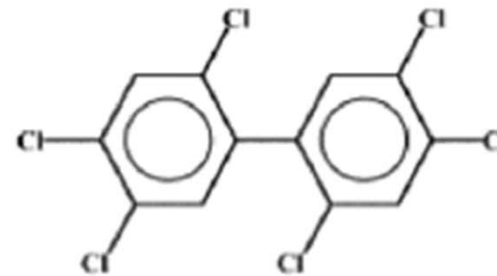


## Bromované zpomalovače hoření - nový typ endokrinních disruptorů??

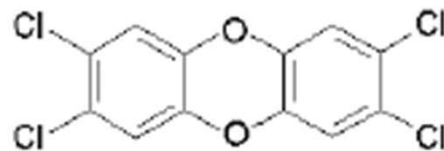
Structure compared to PCBs, dioxin, thyroxin



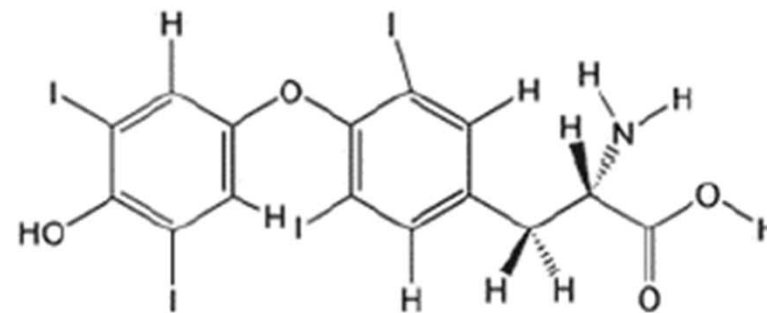
BDE-47



PCB



2,3,7,8-TCDD  
(dioxin)



Thyroxin (T4)

## Efekty spojené s deregulací hladiny retinoidů:

- Funkce RA;
- Vznik končetin;
- Vývoj nervové soustavy;
- Vývojové abnormality obojživelníků;
- Narušení hladin vitamínu A;

## Struktura a syntéza kyseliny retinové

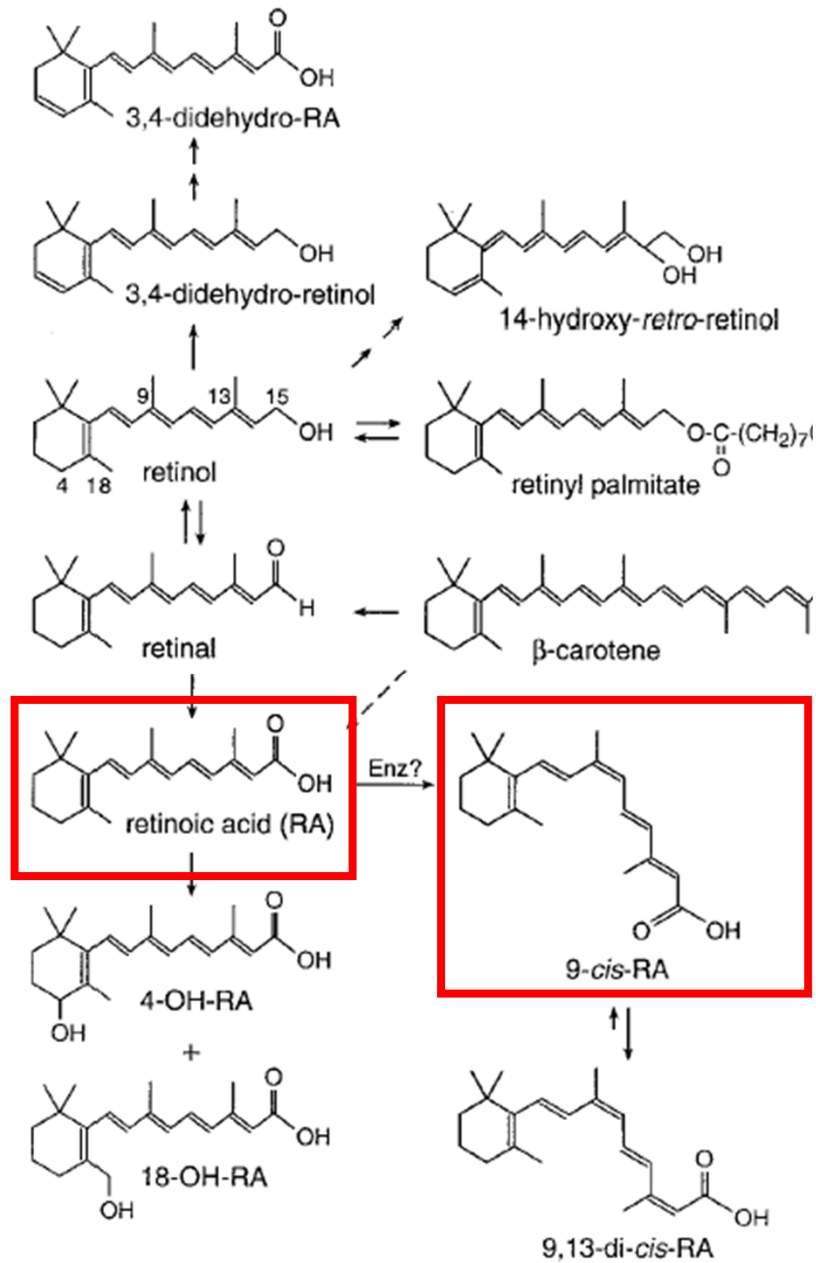


FIG. 2. Structures of naturally occurring retinoids.

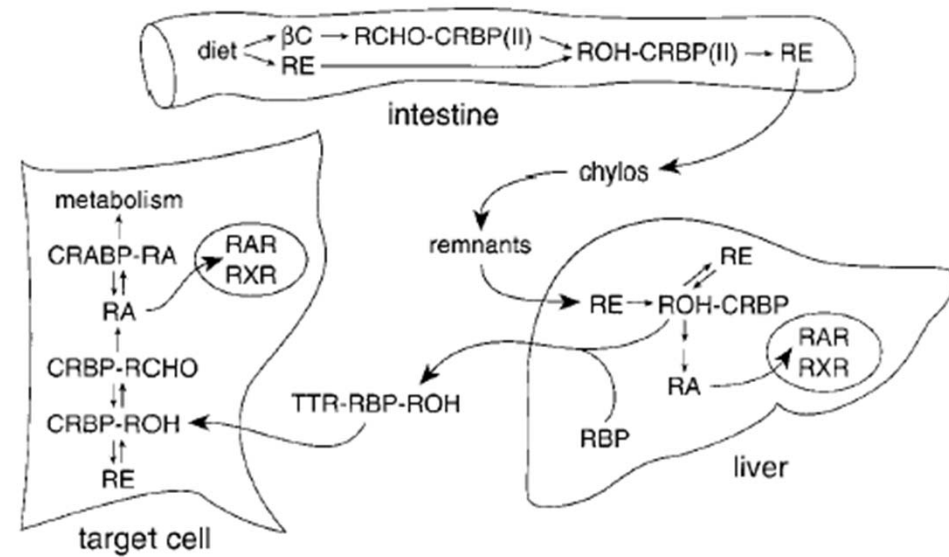


FIG. 3. Absorption, distribution, and metabolism of naturally occurring retinoids.



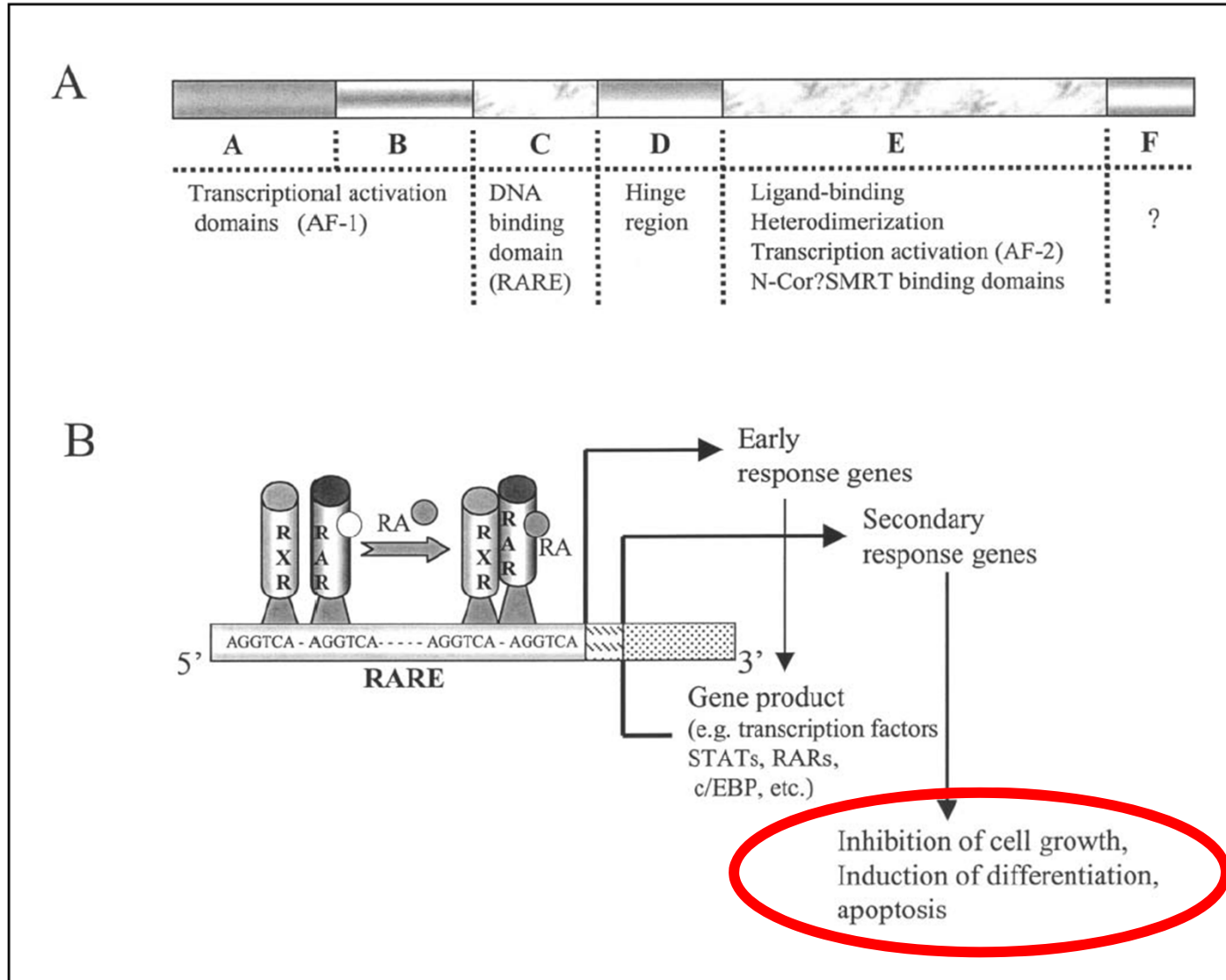


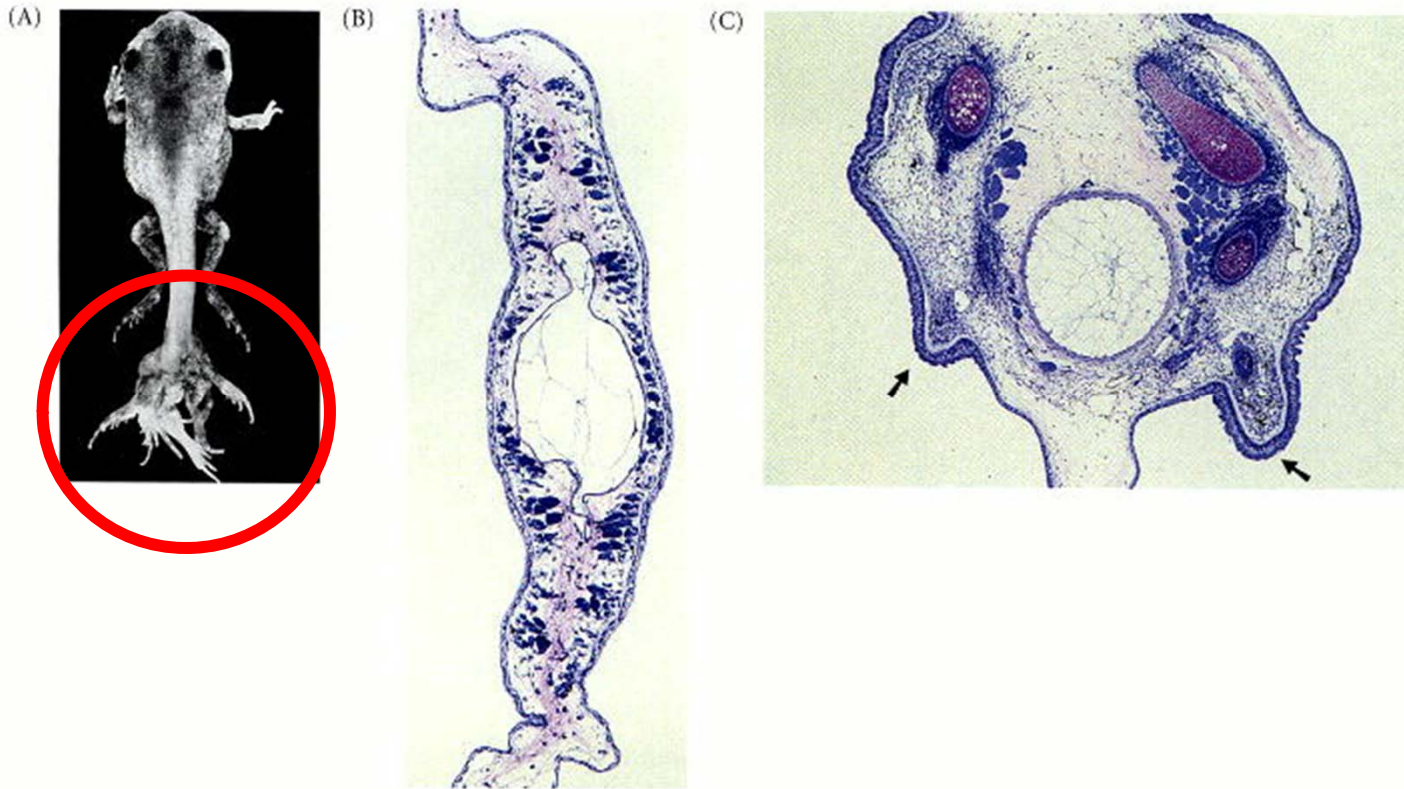
Fig. 1 - Structure and functions of retinoid receptors. A) Schematic representation of retinoid receptor protein depicting various functional domains. B) A molecular model for retinoid action. The liganded RAR forms heterodimer with RXR, binds to specific regulatory sequences (RARE) in the promoter region of target genes. Transactivation of such early response genes is a primary event of retinoid action. In addition to this, the products of early response genes can activate the transcription of secondary genes. Transactivation of these genes therefore represents secondary action of retinoids since their transcription requires protein synthesis. This cascade of gene events leads to secondary and tertiary events that eventually produce a phenotype that is characteristic of retinoid action.

- Abnormalities caused by exogenous agents (certain chemicals or viruses, radiation, or hyperthermia) are called **developmental disruptions**. The agents responsible for these disruptions are called **teratogens**. Most teratogens produce their effects only during certain critical periods of development. The most critical time for any organ is when it is growing and forming its structures. Different organs have different critical periods, but the time from period from day 15 through day 60 of gestation is critical for many human organs.
- **Retinoic acid is important in forming the anterior-posterior axis of the mammalian embryo and also in forming the limbs**. In these instances, retinoic acid is secreted from discrete cells and works in a small area. However, if retinoic acid is present in large amounts, cells that normally would not receive such high concentrations of this molecule will respond to it. **Inside the developing embryo, vitamin A and 13-*cis*-retinoic acid become isomerized to the developmentally active forms of retinoic acid, all-*trans*-retinoic acid and 9-*cis*-retinoic acid. Some of the Hox genes have retinoic acid response elements in their promoters.**
- In the early 1980s, the drug Accutane® (the trade name for isotretinoin, or 13-*cis*-retinoic acid) was introduced as a treatment for severe acne. Women who took this drug during pregnancy had an increased number of spontaneous abortions and children born with a range of birth defects.

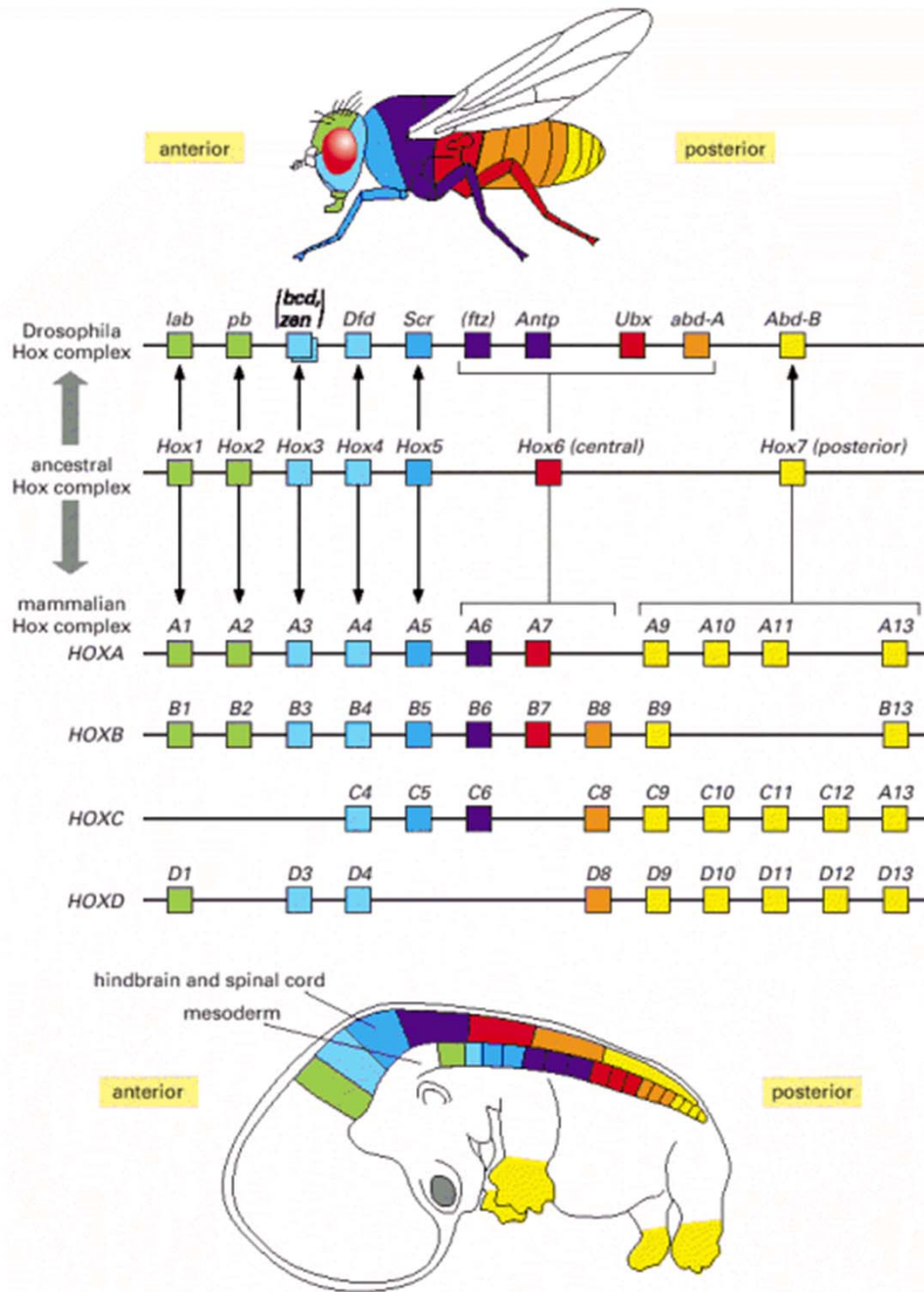
# RA reguluje vznik a vývoj končetin

There are discrete positions where limb fields are generated. Researchers have precisely localized the limb fields of many vertebrate species. Interestingly, in all land vertebrates, there are only four limb buds per embryo, and they are always opposite each other with respect to the midline. **Although the limbs of different vertebrates differ with respect to which somite level they arise from, their position is constant with respect to the level of Hox gene expression along the anterior-posterior axis.** For instance, in fishes (in which the pectoral and pelvic fins correspond to the anterior and posterior limbs, respectively), amphibians, birds, and mammals, the forelimb buds are found at the most anterior expression region of *Hoxc-6*, the position of the first thoracic vertebra.

**Retinoic acid appears to be critical for the initiation of limb bud outgrowth**, since blocking the synthesis of retinoic acid with certain drugs prevents limb bud initiation, suggested that **a gradient of retinoic acid along the anterior-posterior axis might activate certain homeotic genes in particular cells and thereby specify them to become included in the limb field.**



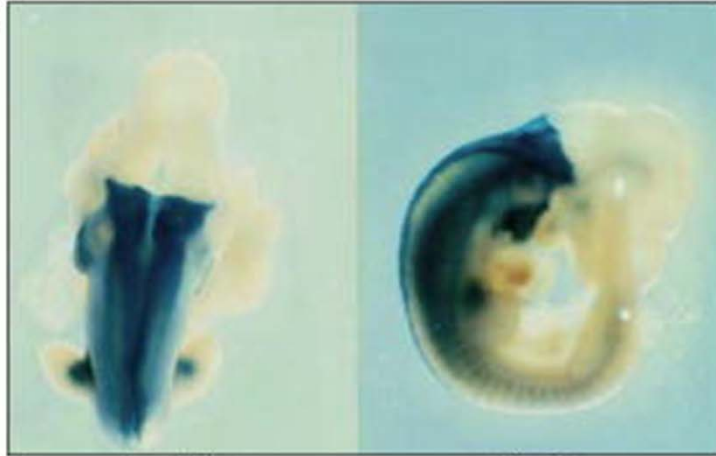
Legs regenerating from **retinoic acid-treated tadpole tail**. (A) The tail stump of a balloon frog tadpole treated with retinoic acid after amputation will form limbs from the amputation site. (B) Normal tail regeneration in a *Rana temporaria* tadpole 4 weeks after amputation. A small neural tube can be seen above a large notochord, and the muscles are arranged in packets. No cartilage or bone is present. (C) A retinoic acid-treated tadpole tail makes limb buds (arrows) as well as pelvic cartilage and bone. The cartilaginous rudiment of the femur can be seen in the right limb bud.



The Hox complex of an insect and the Hox complexes of a mammal compared and related to body regions.



Hoxb-2



dorsal view

side view

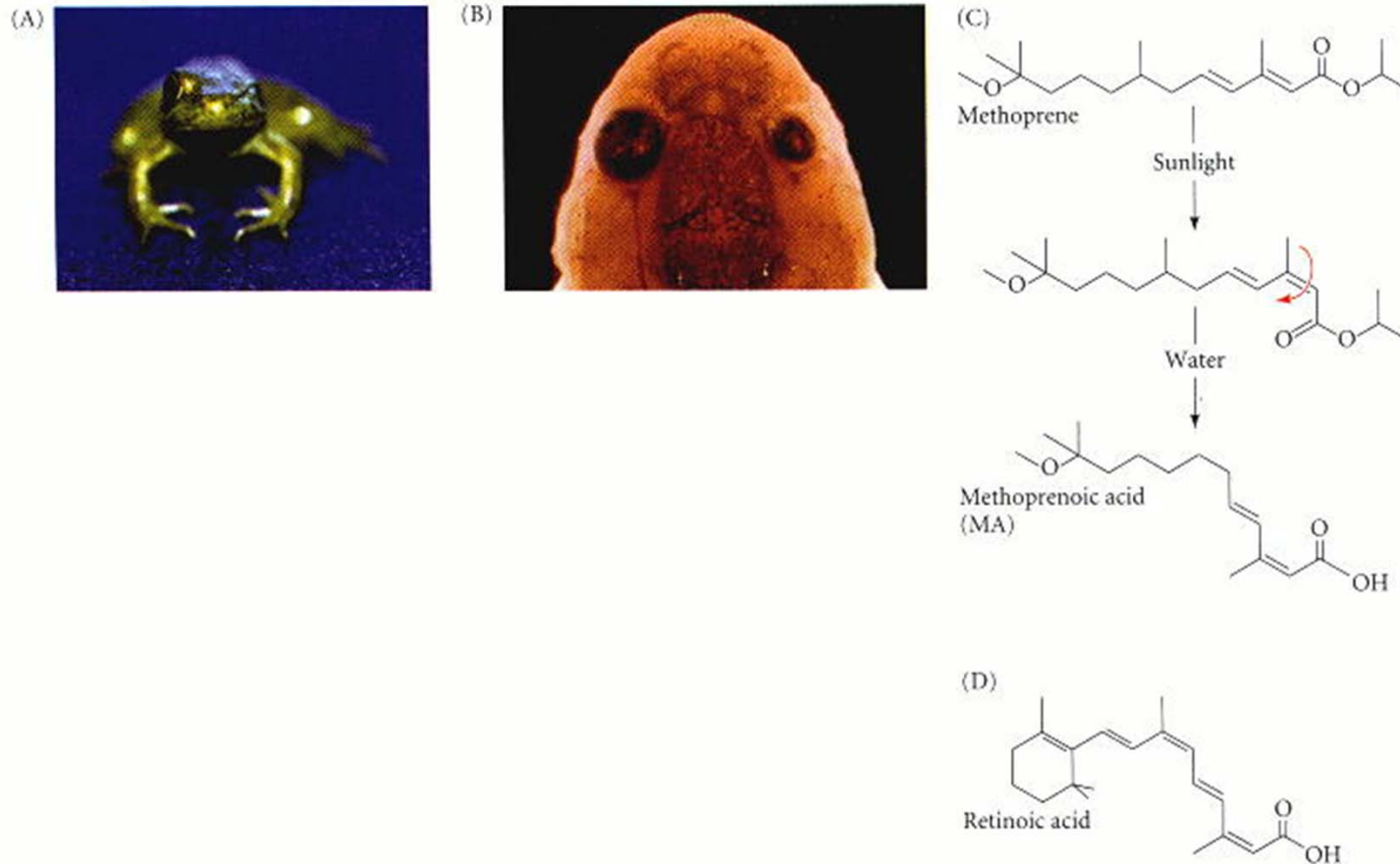
Hoxb-4



dorsal view

side view

Expression domains of Hox genes in a mouse. The photographs show whole embryos displaying the expression domains of two genes of the HoxB complex (*blue* stain). These domains can be revealed by *in situ* hybridization or, as in these examples, by constructing transgenic mice containing the control sequence of a Hox gene coupled to a *LacZ* reporter gene, whose product is detected histochemically. Each gene is expressed in a long expanse of tissue with a sharply defined anterior limit. The earlier the position of the gene in its chromosomal complex, the more anterior the anatomical limit of its expression. Thus, with minor exceptions, the anatomical domains of the successive genes form a nested set, ordered according to the ordering of the genes in the chromosomal complex.

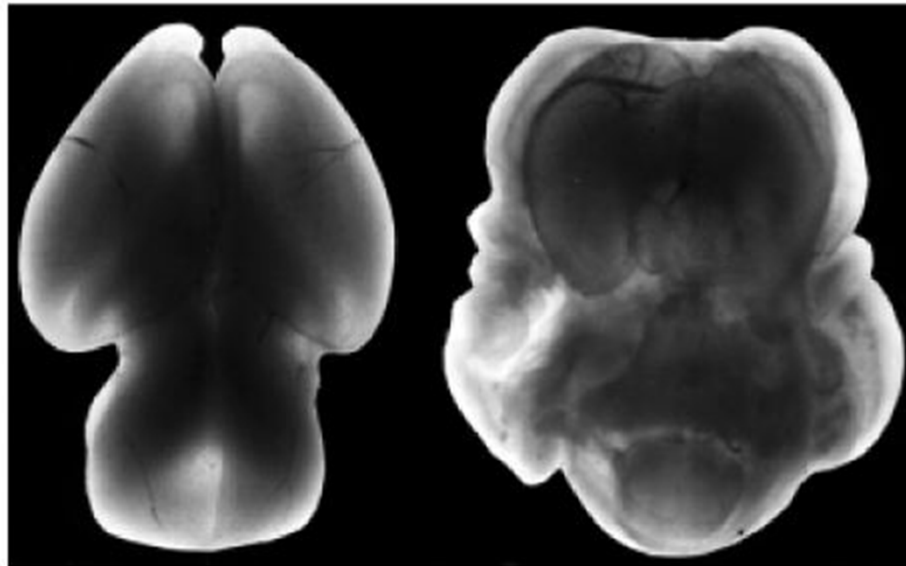


Teratogenesis in frogs. (A) Wild green frog (*Rana clamitans*) with an eye deformity, collected in New Hampshire in 1999 by K. Babbitt. (B) *Xenopus* tadpole with eye deformities caused by incubating newly fertilized eggs in water containing methoprenic acid, a by-product of methoprene. (C) One of several pathways by which methoprene can decay into teratogenic compounds such as methoprenic acid. (D) An isomer of retinoic acid showing the structural similarities to methoprenic acid.

## RA reguluje vývoj CNS



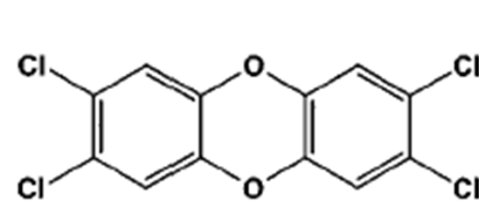
Top panel: At left, retinoic acid activates gene expression in a subset of cells in the normal developing forebrain of a midgestation mouse embryo (blue areas indicate  $\beta$ -galactosidase reaction product, an indicator of gene expression in this experiment); at right, after maternal ingestion of a small quantity of retinoic acid (0.00025 mg/g of maternal weight), gene expression is ectopically activated throughout the forebrain.



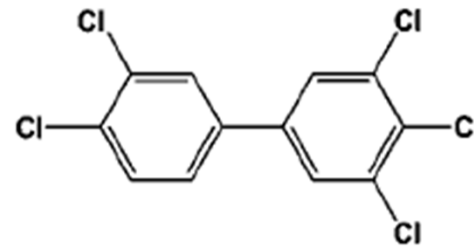
Bottom panel: At left, the brain of a normal mouse at term; at right, the grossly abnormal brain of a mouse whose mother ingested this same amount of retinoic acid at mid-gestation.



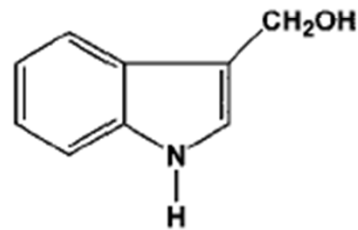
**PHAHs a PAHs narušují funkci a strukturu štítné žlázy a hladiny thyroïdních hormonů a retinoidů**



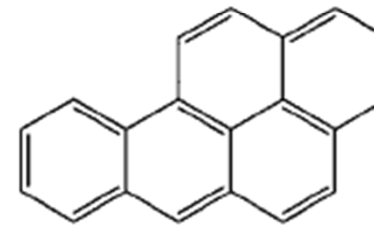
**2,3,7,8-TCDD**



**3,3',4,4',5-pentaCB**



**I3C**



**BaP**

*Figure 5* 2,3,7,8-Tetrachlorodibenzo-*p*-dioxin (TCDD) and related compounds that bind to the AhR.

TABLE 1. Alterations in thyroid gland morphology, thyroid hormones and retinoid levels in marine mammals associated with exposure to polyhalogenated aromatic hydrocarbons.

Species	Study location	Associated contaminants	Tissue sampled	Thyroid/retinoid changes	References
Harbor seal <sup>a</sup> ( <i>Phoca vitulina</i> )	North Sea	PCBs <sup>b</sup>	thyroid gland	thyroid colloid depletion interfollicular fibrosis	Schumacher et al., (1993)
Harbor porpoise ( <i>Phocoena phocoena</i> )					
Beluga whale ( <i>Delphinapterus leucas</i> )	St. Lawrence Estuary, Quebec	PCBs other OCs <sup>c</sup>	thyroid gland	thyroid abscesses thyroid adenoma	De Guise et al., (1995)
Northern elephant seal ( <i>Mirovanga angustirostris</i> )	California	PCBs p,p'-DDE <sup>d</sup>	plasma	↓ retinol ↓ TT <sub>4</sub> <sup>e</sup> , TT <sub>3</sub> <sup>f</sup>	Beckmen et al., (1997)
Harbor seal ( <i>Phoca vitulina</i> )	captive	PCBs p,p'-DDE	plasma	↓ retinol ↓ TT <sub>4</sub> , FT <sub>4</sub> <sup>g</sup> , TT <sub>3</sub>	Brouwer et al., (1989)
Harbor seal ( <i>Phoca vitulina</i> )	captive	PCBs dioxin TEQ <sup>3h</sup>	plasma	↓ retinol ↓ TT <sub>4</sub> , TT <sub>3</sub> <sup>j</sup>	De Swart et al., (1994, 1995)
Grey seal <sup>l</sup> ( <i>Halichoerus grypus</i> )	Norway	PCBs	plasma	↓ TT <sub>4</sub> , FT <sub>4</sub>	Jenssen et al., (1995)
Grey seal <sup>k</sup> ( <i>Halichoerus grypus</i> )	United Kingdom	PCB 169	plasma	↓ TT <sub>3</sub> :TT <sub>4</sub>	Hall et al., (1998)

TABLE 3. Alterations in thyroid gland morphology and retinoid levels in fish associated with exposure to polyhalogenated aromatic hydrocarbons and polynuclear aromatic hydrocarbons.

Species	Study location	Associated contaminants	Tissue sampled	Thyroid/retinoid changes	References
Salmon species ( <i>Oncorhynchus</i> sp.)	Great Lakes	unknown factor	thyroid gland	thyroid hypertrophy, hyperplasia	Sonstegard et al., (1976)
White sucker ( <i>Catostomus commersoni</i> )	Montreal, Quebec	coplanar PCBs <sup>a</sup>	liver	↓ retinol ↓ retinyl palmitate	Spear et al., (1992) Branchaud et al., (1995)
Lake sturgeon ( <i>Acipenser fulvescens</i> )	Montreal, Quebec	PCBs	intestine	↓ retinyl palmitate ↓ dehydroretinyl palmitate	Ndayibagira et al., (1994)
Lake sturgeon ( <i>Acipenser fulvescens</i> )	St. Lawrence River, Quebec	coplanar PCBs	liver	↑ RA <sup>b</sup> metabolism ↓ retinoids	Doyon et al., (1999)
Brown bullheads ( <i>Ameiurus nebulosus</i> )	Great Lakes	PAHs <sup>c</sup>	liver	↓ retinyl palmitate ↓ dehydroretinyl palmitate	Arcand-Hoy et al., (1999)

TABLE 2. Alterations in thyroid gland morphology, thyroid hormones and retinoid levels in free-ranging avian species associated with exposure to polyhalogenated aromatic hydrocarbons.

Species	Study location	Associated contaminants	Tissue sampled	Thyroid/retinoid changes	References
Herring gulls ( <i>Larus argentatus</i> )	Great Lakes	PHAHs <sup>a</sup>	thyroid	↑ thyroid mass thyroid hyperplasia	Moccia et al., (1986)
Herring gulls ( <i>Larus argentatus</i> )	Great Lakes	PHAHs	liver	↓ retinyl palmitate	Government of Canada, (1991)
Herring gulls ( <i>Larus argentatus</i> )	Great Lakes	2,3,7,8-TCDD <sup>b</sup>	liver	↓ retinol ↓ retinyl palmitate	Spear et al., (1986, 1992)
Herring gulls ( <i>Larus argentatus</i> )	Lakes Huron, Erie, Ontario	2,3,7,8-TCDD ΣPCDDs + PCDFs <sup>c</sup> dioxin TEQs <sup>d</sup>	egg yolk	↑ retinol: retinyl palmitate	Spear et al., (1990)
Great blue herons ( <i>Arca herodias</i> )	St. Lawrence River, Quebec	ΣPCBs 105 + 118 <sup>e</sup> ΣPCBs 105 + 118 TEQs <sup>f</sup>	egg yolk	↓ retinyl palmitate	Boily et al., (1994)
Cormorants ( <i>Phalacrocorax carbo</i> )	Netherlands	PCBs <sup>g</sup> PCDDs PCDFs	egg yolk liver plasma	↓ FT <sub>4</sub> <sup>h</sup> ↑ EROD <sup>i</sup>	van den Berg et al., (1994)
Herring gulls ( <i>Larus argentatus</i> )	Great Lakes	PCBs <sup>j</sup>	plasma <sup>k</sup>	↓ retinol	Grasman et al., (1996)
Caspian terns ( <i>Sterna caspia</i> )					
Common terns ( <i>Sterna hirundo</i> )	Belgium Nether- lands	mono-ortho PCBs PCDDs PCDFs	egg yolk plasma liver	↓ retinyl palmitate <sup>l</sup> ↓ TT <sub>3</sub> <sup>m</sup> , TT <sub>4</sub> <sup>n</sup> , FT <sub>4</sub> ↑ plasma retinol to yolk sac retinyl palmitate	Murk et al., (1996)
Herring gulls ( <i>Larus argentatus</i> )	Great Lakes	PCBs, DDE, <sup>o</sup> dieldrin, mirex	liver	↓ retinyl palmitate	Fox et al., (1998)
Tree swallows <sup>p</sup> ( <i>Tachycineta bicolor</i> )	Great Lakes St. Lawrence River basin	Ah-inducing chemicals <sup>q</sup>	liver	↓ retinol ↑ EROD	Bishop et al., (1999)

## PHAHs moduluji hladiny retinoidů - mobilizace zásob vitamínu A v játrech

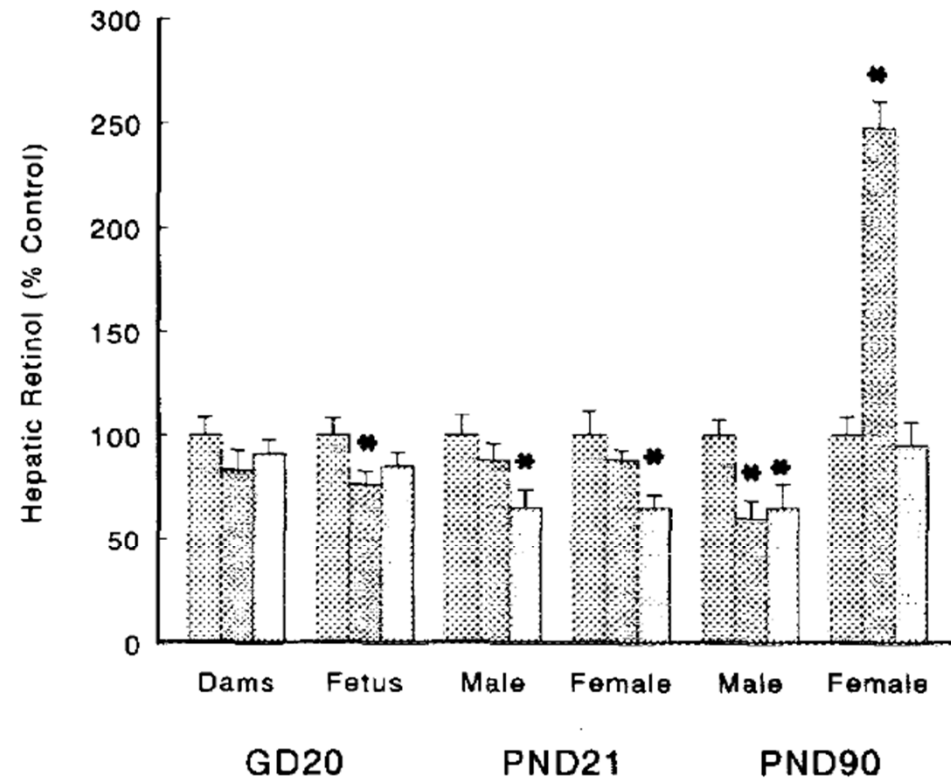


FIG. 3. Hepatic retinol concentrations, expressed as percentage of control values, mean  $\pm$  SEM, from dams, their fetuses ( $N = 6$ ), male and female neonates ( $N = 8-10$ ), and adult offspring ( $N = 10$ ) following maternal exposure to 0  $\square$ , 5  $\blacksquare$ , or 25  $\boxtimes$  mg Aroclor 1254/kg on Days 10-16 of gestation. \*Indicates a significant difference from controls,  $p < 0.05$ . GD20, Gestation Day 20; PND21, Postnatal Day 21; PND90, Postnatal Day 90.

## BPA moduluje hladiny retinoidních receptorů v průběhu embryogeneze - myši

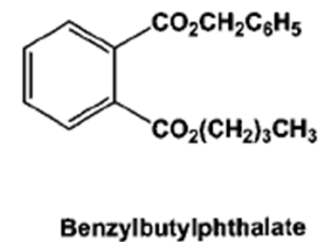
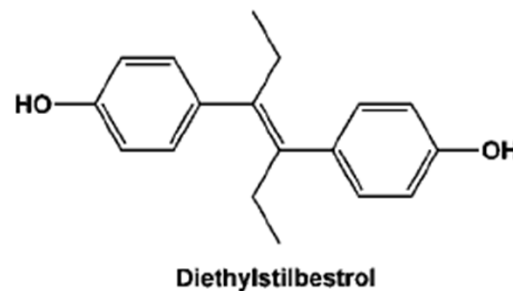
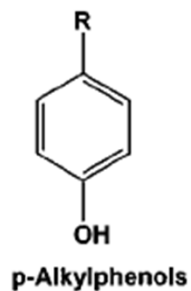
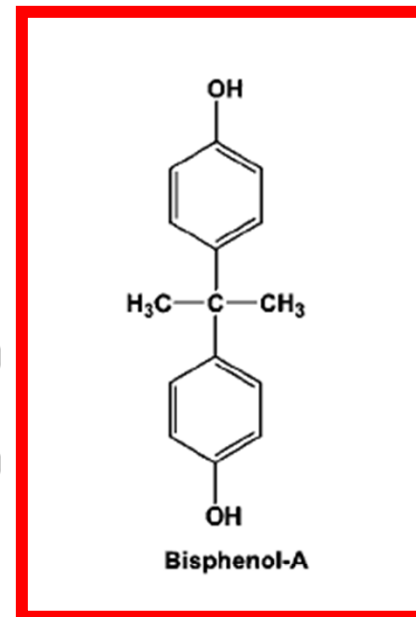
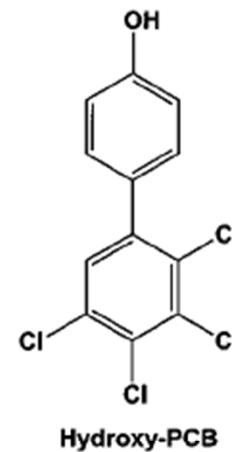
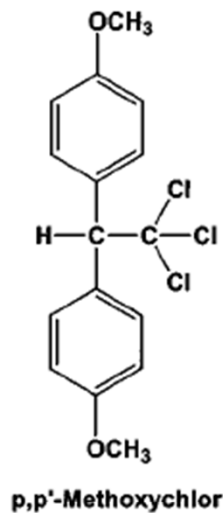
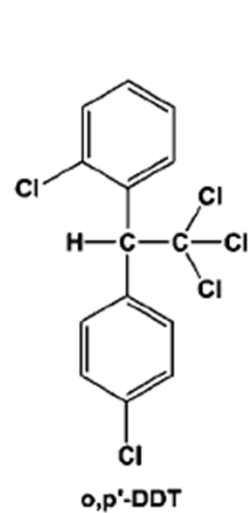


Figure 2 Structures of some xenoestrogens.

## Funkce thyroidních hormonů v ontogenezi a vliv organických polutantů:

- Funkce thyroidních hormonů v metamorfóze
- Funkce thyroidních hormonů ve vývoji nervové soustavy;

Hypotéza - environmentální polutanty jako kauzální faktor neurologických poruch (autismus, poruchy učení, hyperaktivita, nádorová onemocnění, juvenilní formy diabetes);

## T3 a T4 mají zásadní význam pro iniciaci metamorfózy obojživelníků

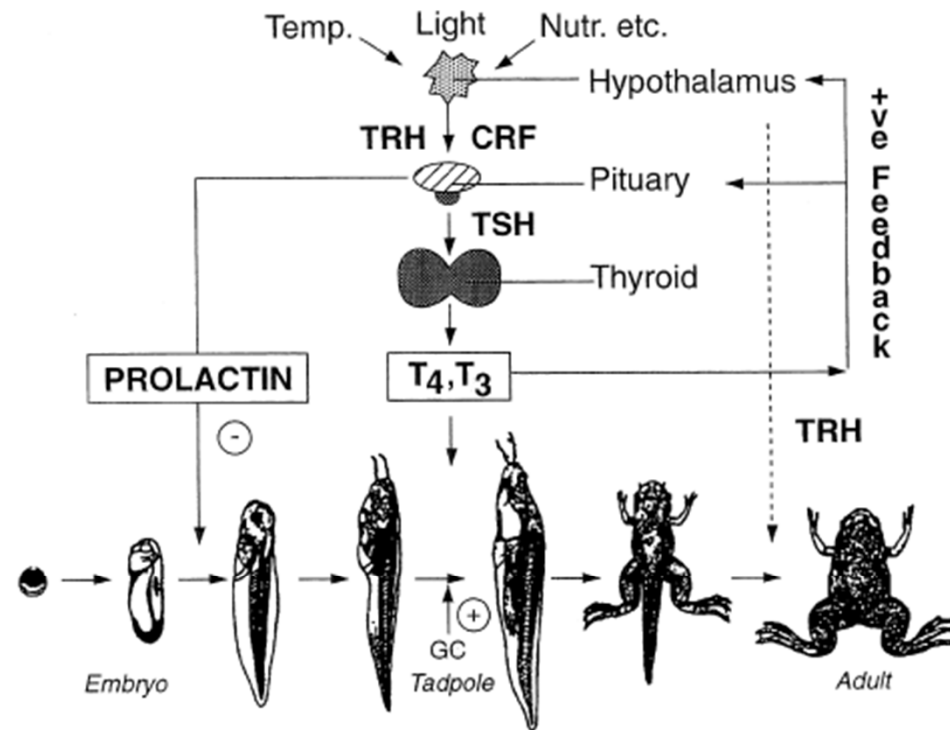
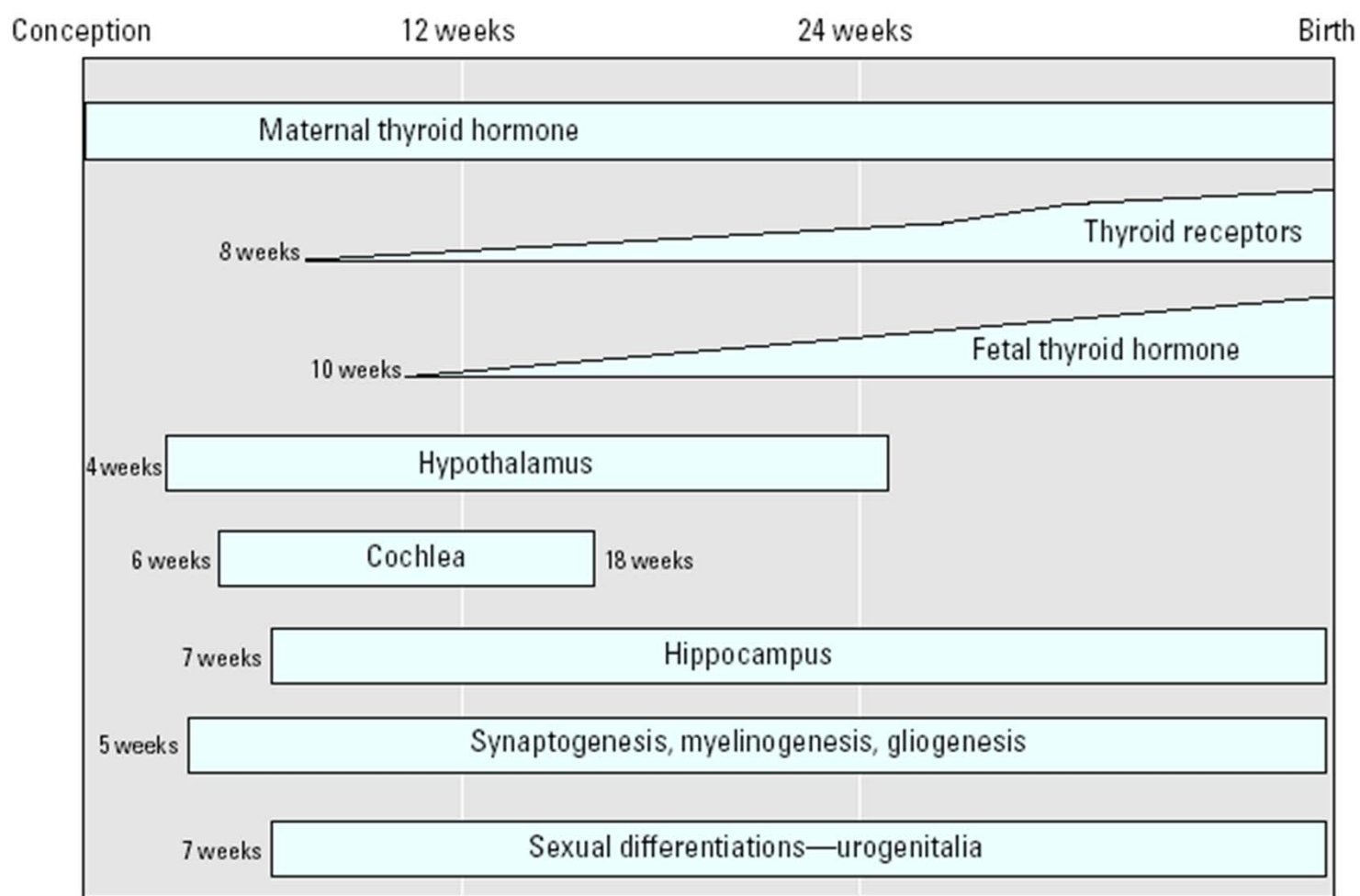


Fig. 1. Schematic representation of the hormonal regulation of amphibian metamorphosis. In response to environmental cues, the dormant thyroid gland of the tadpole is activated to produce the thyroid hormones T<sub>4</sub> and T<sub>3</sub> by the hypothalamic and pituitary hormones TRF, CRF and TSH. Thyroid hormone (TH) is obligatorily required to initiate and maintain the metamorphosis, its action being potentiated by glucocorticoid hormone and retarded by prolactin. Nutr., nutritional factors; TRH, thyrotrophin-releasing hormone; CRF, corticotrophin-releasing factor; TSH, thyoid-stimulating hormone; T<sub>4</sub>, L-thyroxine; T<sub>3</sub>, triiodo-L-thyronine; GC, glucocorticoid hormone.

Table 1  
Diversity of morphological and biochemical responses to thyroid hormone during amphibian metamorphosis

Tissue	Response	
	Morphological	Biochemical
Brain	Restructuring; axon guidance and growth; cell turnover	Cell division; apoptosis; protein synthesis
Liver	Functional differentiation; restructuring	Induction of albumin and urea cycle enzymes; larval–adult haemoglobin switch
Eye	Repositioning; new retinal neurones; altered lens	Visual pigment switch; induction of $\beta$ -crystallin
Skin	Restructuring; keratinisation; granular gland formation	Induction of collagen, 63 kDa keratin, magainin
Limb bud, lung	De novo morphogenesis of bone, skin, muscle, nerve, etc.	Cell proliferation; gene expression
Tail, gills	Total tissue regression and removal	Programmed cell death; induction of lytic enzymes
Intestine, pancreas	Major remodelling of tissues	New structural and functional constituents
Immune system	Redistribution of immune cell populations	Aquisition of new immunocompetence
Muscle	Growth, differentiation, apoptosis	Induction of myosin heavy chain





**Figure 1.** Role of thyroid hormones in fetal neurologic development in relation to timing of several landmark stages of development. Figure adapted from Howdeshell (2002).

Although it has been known for a century that hypothyroidism leads to retardation and other serious developmental effects, the role of thyroid hormones in brain development is still not completely understood. It is also accepted that thyroid hormones transferred from the mother to the embryo and fetus are critical for normal brain development, even though the thyroid gland of a fetus starts producing thyroid hormones at about 10 weeks.

**We now recognize that only a slight difference in the concentration of thyroid hormones during pregnancy can lead to significant changes in intelligence in children.**

## Možné mechanismy disrupce funkce thyroïdních hormonů

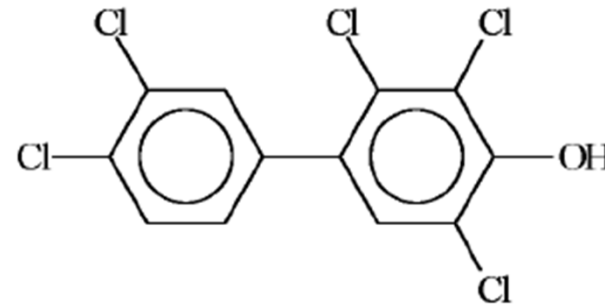
- Inhibition of active transport of inorganic iodide into the follicular cell
- Interference with the sodium/iodide transporter system
- Inhibition of thyroid peroxidases to convert inorganic iodide into organic iodide to couple iodinated tyrosyl moieties into thyroid hormone
- Damage to follicular cells
- Inhibition or enhancement of thyroid hormone release into the blood
- Inhibition or activation of the conversion of T4 to T3 by 5' - monodeiodinase at various sites in the body, for example, the fetal brain
- Enhancement or interference of the metabolism and excretion of thyroid hormone by liver uridine diphosphate
- Interference with transport of thyroid hormones
- Vitamin A (retinol) disturbances
- Blocking of or interfering with thyroid receptors

## Mechanisms of Action of Thyroid-Disrupting Chemicals

The complexity of the development of both the neurologic and thyroid systems offers numerous opportunities for chemicals to interfere as the systems develop, mature, and function. Briefly, there are chemicals that interfere with iodine uptake (the herbicides 2,4-D and mancozeb, several PCB congeners, and thiocyanates) and peroxidation at the molecular level (the herbicides aminotriazole and thioureas, the insecticides endosulfan and malathion, and PCBs). They also interfere with the protein transporter that provides a pathway for iodine to enter the cell (military and aerospace chemicals, perchlorates). Certain antagonists (PCBs, the herbicides aminotriazole and dimethoate, and the insecticide fenvalerate) prevent the release of thyroid hormone from the cell and inhibit conversion of T4 to triiodothyronine (T3). Various chemicals enhance excessive excretion of thyroid hormones, some through activation of the cytochrome P450 system (dioxin, hexachlorobenzene, and fenvalerate). Some PCBs, phthalates, and other widely used chemicals compete for sites on the thyroid transport proteins that deliver thyroid hormones throughout the body. New research focuses on the role of chemicals as they interfere with vitamin A (retinols). retinols, a process essential for thyroid hormone expression.

## Hydroxylované PCB

During normal enzyme detoxification of PCBs in the maternal liver, certain PCB congeners are hydroxylated. This metabolic step enhances the binding affinity of the hydroxylated PCBs to TTR. Through their high-affinity binding the hydroxylated congeners displace essential fT4 that must get to the fetal brain to be converted to fT3. Hydroxylated PCBs also interfere with the normal excretion of thyroid hormones by inhibiting their sulfation. PCB hydroxylates also have estrogenic and antithyroid properties.



4-OH-PCB107

## Thyroidní disrupce u volně žijících obratlovců:

### Obojživelníci

Gutleb and co-workers did a series of exposure studies with *Xenopus laevis* and *Rana temporaria*. They found increased incidence of mortality in tadpoles weeks after they ceased dosing the animals. Over an 80-day period, 47.5% of the tadpoles died. The *X. laevis* exposed to 7.7 pM and 0.64 nM PCB 126 exhibited swimming disorders prior to death. Both increased mortality and reduced T4 concentrations occurred in a dose-response manner in *X. laevis*. Severe eye and tail malformations increased in the froglets in a dose-response manner after approximately 60-68 days.

### Ptáci

Thyroid hormones in birds have been investigated for their role in migration and courtship. Preventing migrating species from breeding out of season is especially critical for their survival. From the 1950s through to the 1970s, fish-eating birds in the Great Lakes were experiencing very poor reproductive success. Keith suggested that the high embryo mortality and low chick survival in herring gulls nesting in upper Green Bay in the mid 1960s was both the result of a) the effects of the chemical residues from the mother on the embryo and b) the effects of the adult's contamination on its parental behavior.

## Ryby

Migration of salmonids is linked with THs effecting a sequence of behaviors. In the laboratory, increases in T4 led to less display of aggressive behavior such as territoriality. Elevated concentrations of both T3 and T4 reduced the fishes' preference for shade to more open areas (phototaxis). T3 treatment caused the fish to swim with the current rather than against the flow (rheotaxis).

## Savci

PCBs and dioxins have been shown to alter thyroid function in rodents by multiple mechanisms, including direct toxic effects on the thyroid gland, induction of thyroid hormone metabolism via the UDP-glucuronyl transferases, and interactions with thyroid hormone plasma transport proteins, particularly transthyretin. A number of investigators have evaluated the effects of maternal PCB exposure on thyroid function of rat pups. Pup serum thyroxine (T4) levels are markedly reduced by PCB or dioxin exposure, but the levels of the active form of the hormone, triiodothyronine (T3), are generally unchanged, or only slightly reduced. A relationship between exposure to dioxins and PCBs and alterations in thyroid hormones has also been reported in human infants. Infants exposed to higher levels of PCBs and dioxins had lower free T4 levels and higher thyroid-stimulating hormone levels.

## PPAR

- Deregulace PPAR a reprodukce
- PPAR a karcinogenita



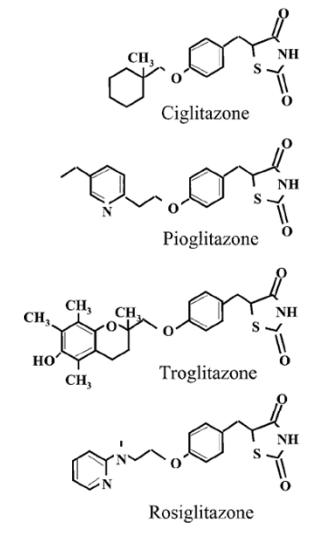
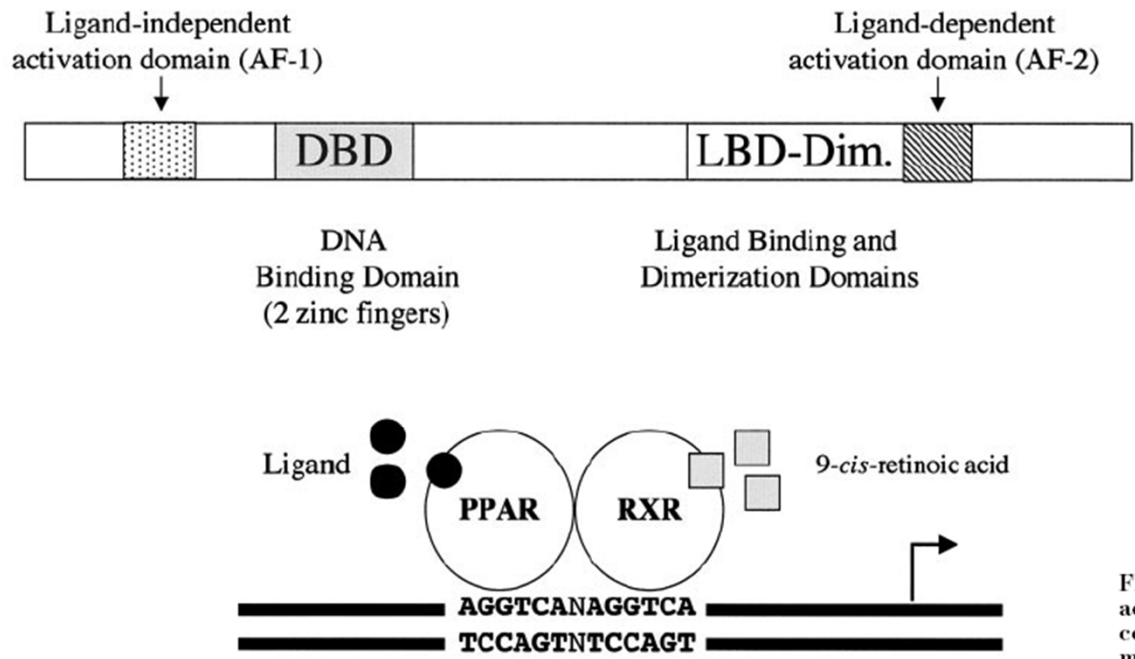
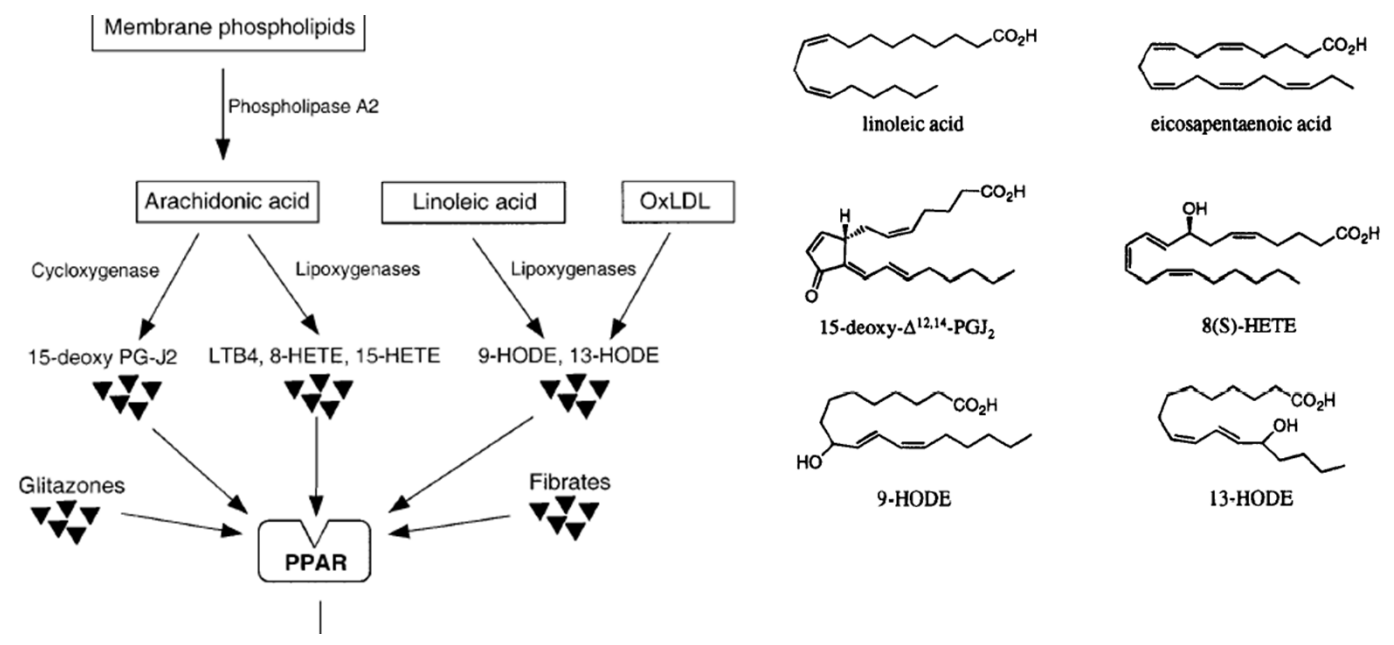
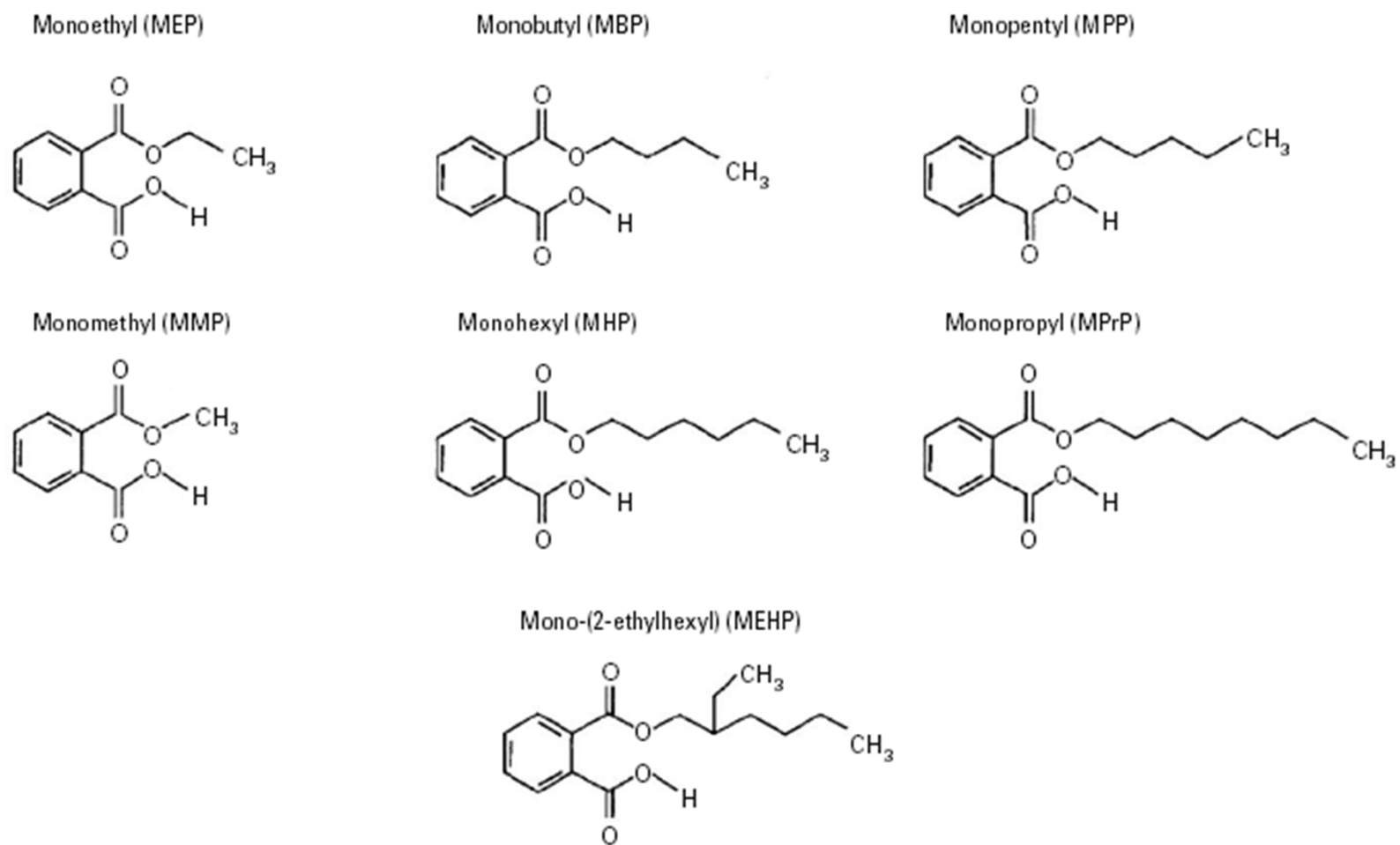


FIG. 1. General structure and mechanism of action of PPARs. PPAR isoforms share a common domain structure and molecular mechanism of action.



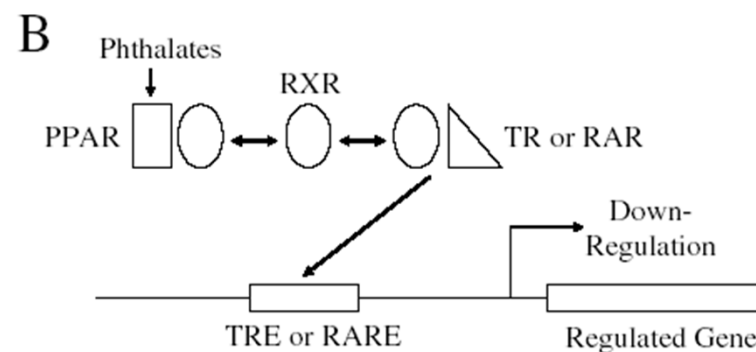
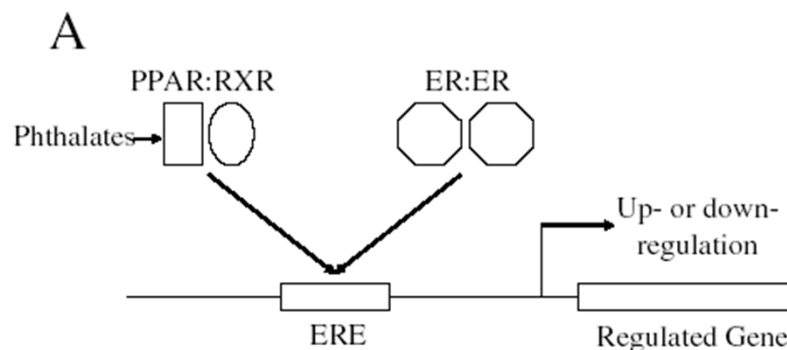


**Figure 1.** Structurally related phthalate monoesters. Diesters of *o*-phthalic acid are quickly metabolized *in vivo* to their active metabolites, the monesters. The length and structure of the side chain is important for toxicity.

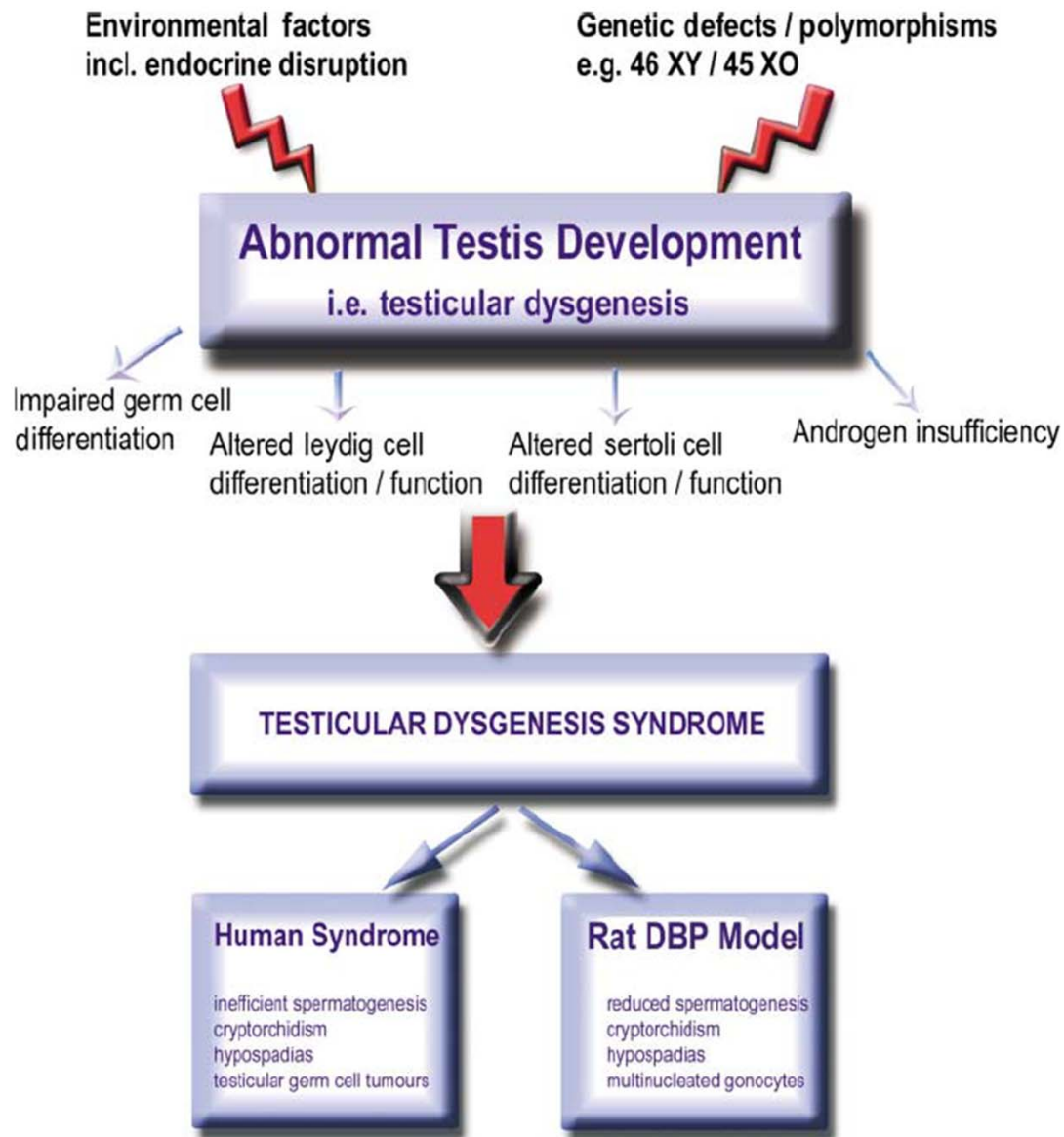
## Ftaláty jako ligandy PPAR – efekty na samčí a samičí reprodukční systém

**TABLE 1**  
**Summary of Effects of *in Utero* Exposure to Phthalates on the Developing Male Reproductive Tract**

Endpoint measured <sup>a</sup>	DBP	DEHP	BBP	DINP
<b>Testis</b>				
↓ Weight	+	+	+	-
↓ Sperm number	+	+	+	
Degeneration/atrophy of seminiferous tubules	+	+	+	
Leydig cell hyperplasia/aggregates	+	+	+	
Leydig cell adenoma	+	+		
Cryptorchidism	+	+	+	
<b>Sex organs</b>				
Epididymis: ↓ wt, agenesis/malformed	+	+	+	-
Penis: delayed/incomplete preputial separation, hypospadias, ↓ wt of glans	+	+	+	-
Prostate: ↓ wt, agenesis	+	+	+	-
Seminal vesicle: ↓ wt	+	+	+	-
Vas deferens: ↓ wt, malformed/agenesis	+			
<b>Miscellaneous</b>				
Anogenital distance (↓)	+	+	+	+
Nipple retention	+	+	+	



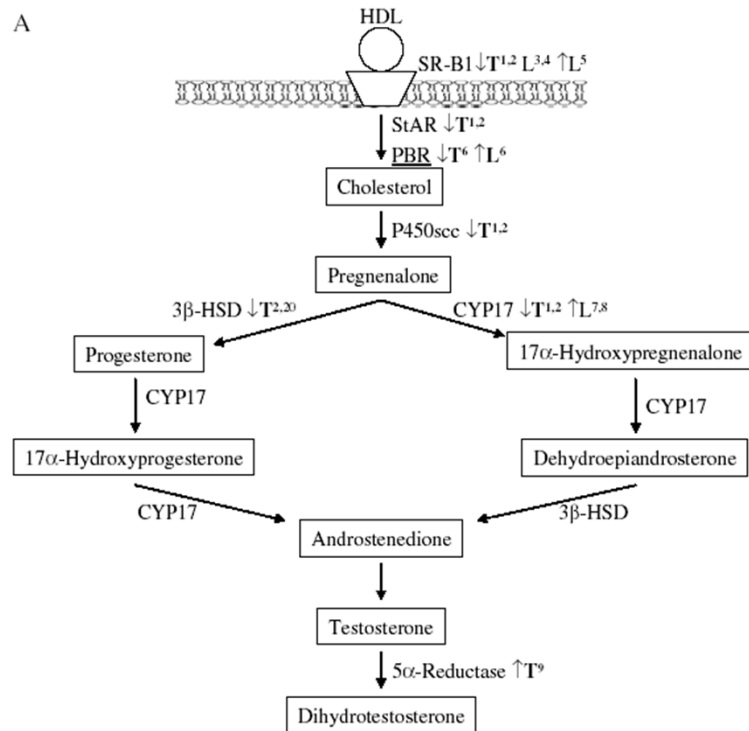
# TDS = testicular dysgenesis syndrome



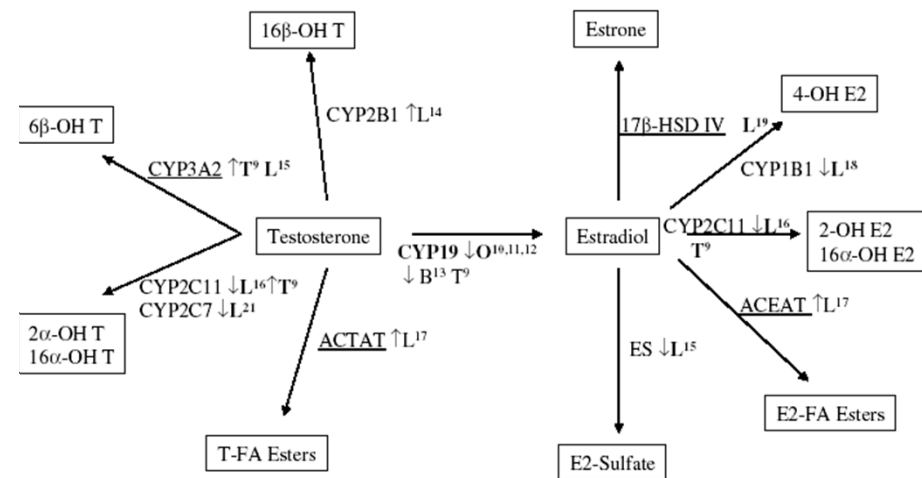
**Figure 1** Schematic representation of the potential pathogenic links between testis development and the clinical manifestations of testicular dysgenesis syndrome (TDS). The similarities in the pathologies induced by *in utero* dibutyl phthalate (DBP) administration and human TDS are compared.

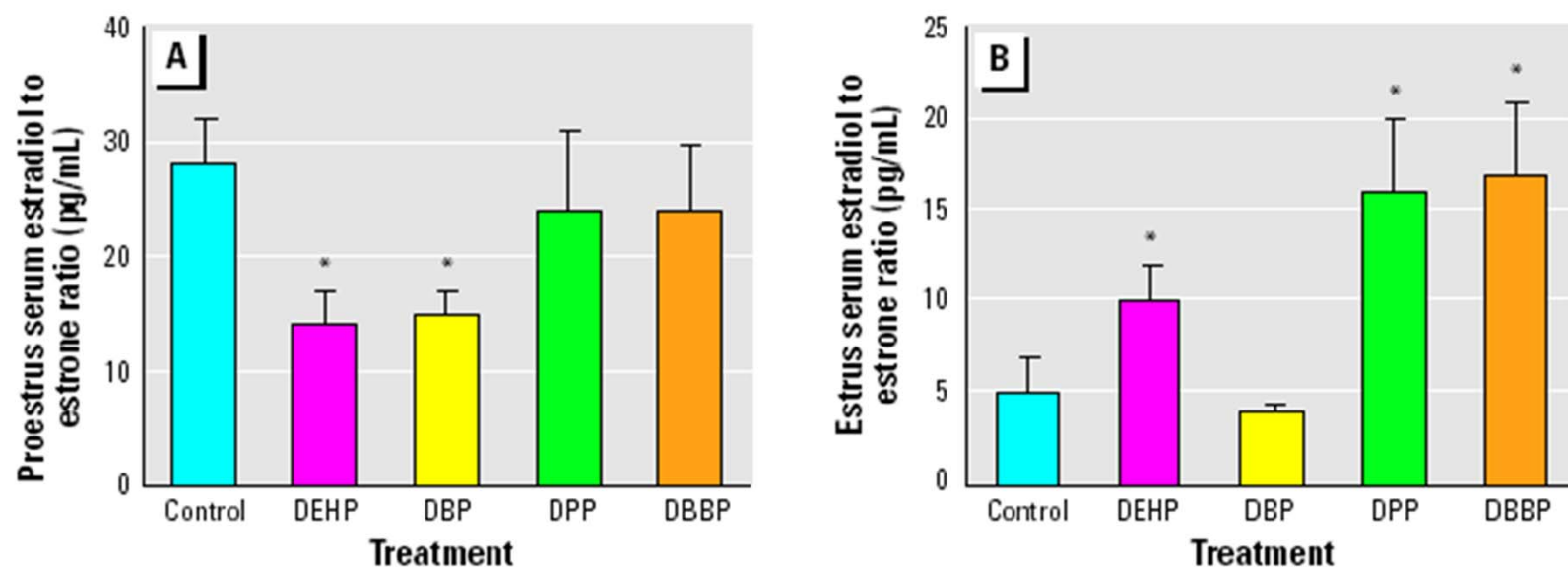
# Ftaláty modulují expresi enzymů kontrolujících syntézu a odpouštění steroidních hormonů

A



B

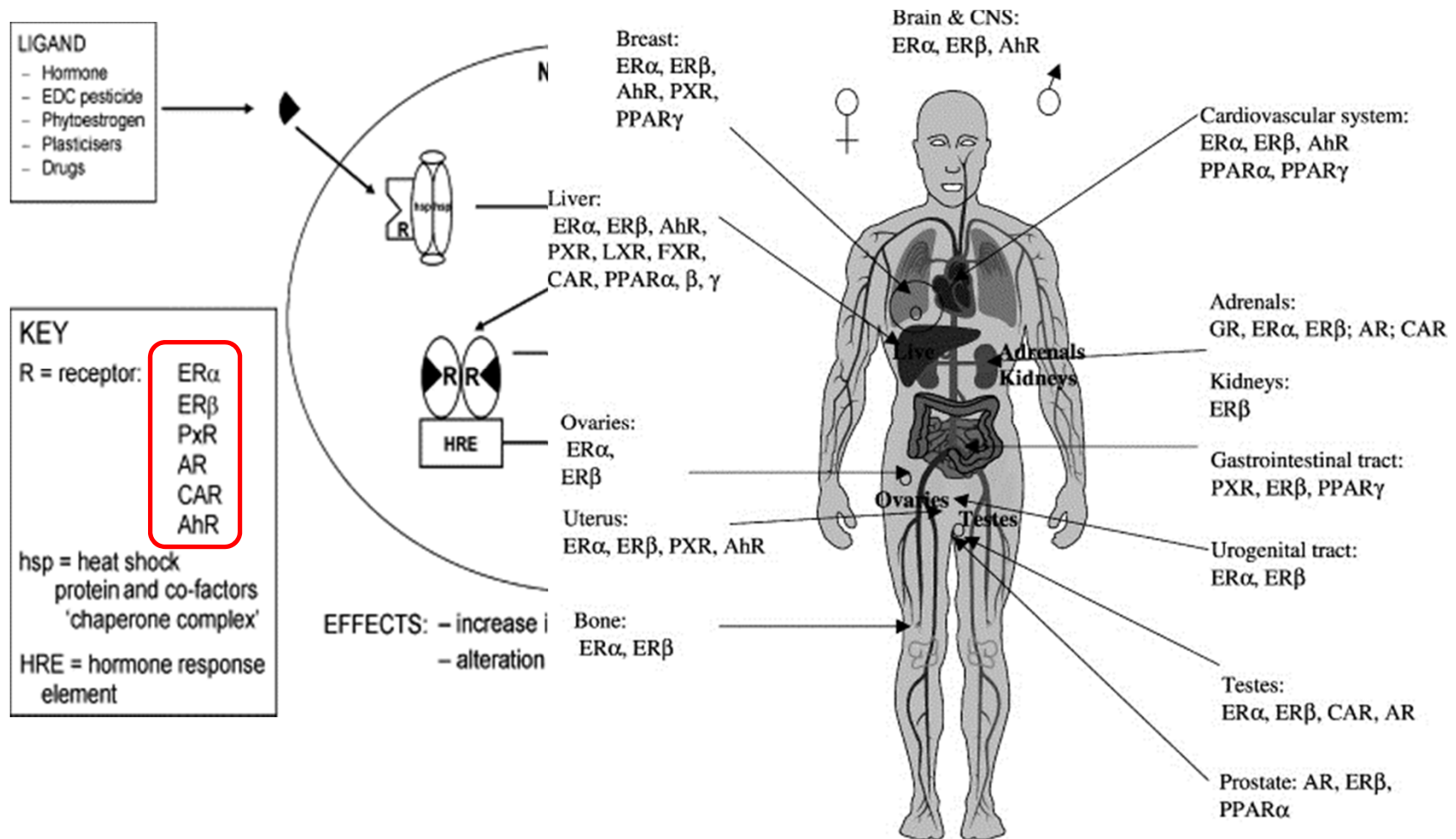




**Figure 2.** Phthalate effects on serum estradiol and estrone levels at (A) proestrus and (B) estrus. Adult 90-day-old female Sprague-Dawley rats ( $n = 12$  per group) were treated with corn oil vehicle or 1,000 mg/kg of DEHP, DBP, DPP, or DBBP in corn oil given daily by gavage beginning at vaginal metestrus. Rats were killed at vaginal proestrus ( $n = 6$  per treatment) or estrus ( $n = 6$  per treatment) 8 or 9 days after dosing began, following methodology described by Davis et al. (1994a).

\*Significantly different compared to control,  $p < 0.05$ .

# Modulace exprese/aktivity biotransformačních enzymů xenobiotiky

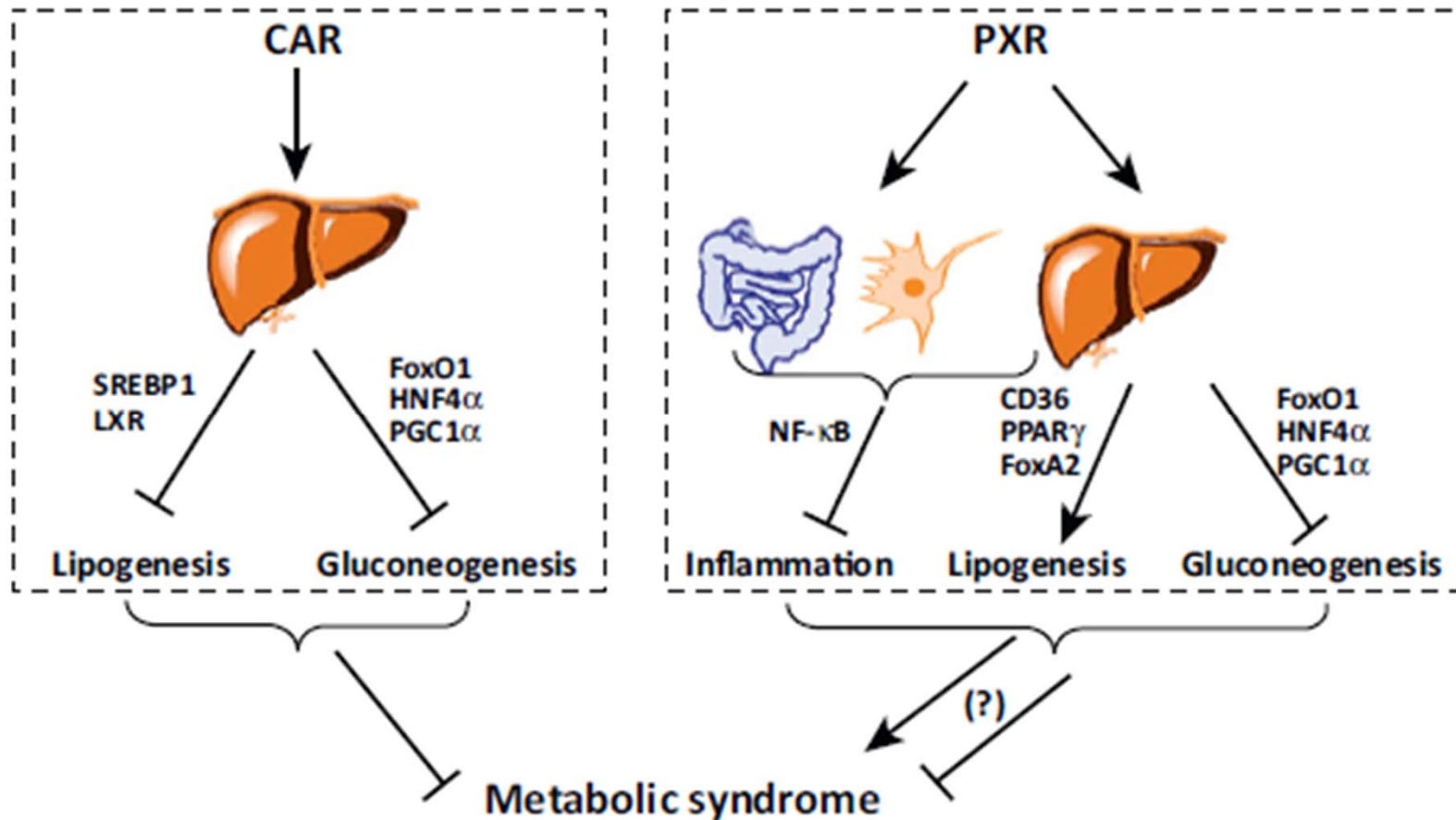


# Základní funkce CAR a PXR

- PXR a CAR slouží především jako senzory umožňující eliminaci toxických produktů metabolismu endobiotik a xenobiotik; i díky regulaci překrývajících se skupin genů;
- **mají také široké spektrum účinků v regulaci fyziologických funkcí různých orgánů – metabolismus lipidních sloučenin a udržování homeostáze metabolismu glukózy; to může přispívat k toxickým účinkům některých jejich ligandů;**
- CAR koordinuje regulaci exprese řady XME v hepatocytech – CYPy, transferázy, ale i transportéry, jako je např. OATP2 a usnadňuje tak eliminaci toxických látek i léčiv v játrech;
- PXR je především ústřední regulátor CYP3A isozymů, reguluje také exprese řady dalších enzymů a transportérů, jako jsou karboxylesterázy, alkoholdehydrogenázy, GST, UGT, SULT, P-gp, MRP i OATP2;

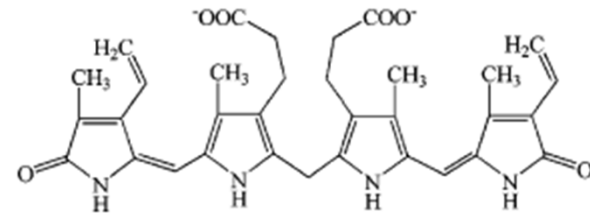


# CAR a PXR hrají roli jak v metabolismu xenobiotik, tak v energetickém metabolismu



# CAR a metabolismus bilirubinu

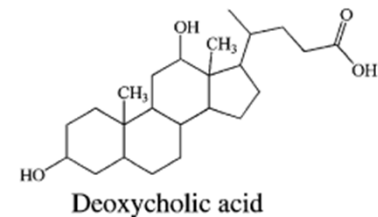
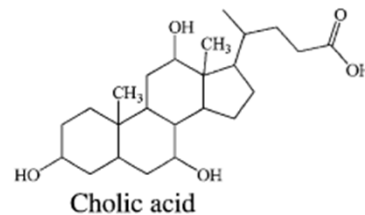
- bilirubin je jeden z nejvíce toxických produktů endogenního metabolismu; hlavní cestou detoxikace je glukuronidace prostřednictvím UGT1A1 a vzniklý metabolit je pak exkretován pomocí MRP2;
- ligandy CAR jsou napomáhají eliminaci bilirubinu prostřednictvím indukce UGT1A1 a MRP2 (ale i OATP2, GST A1);



Bilirubin

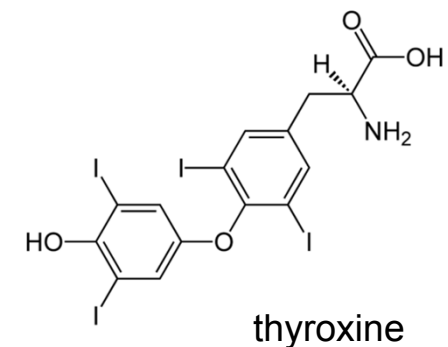
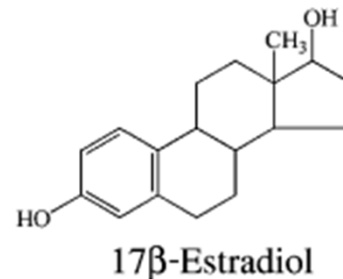
# CAR a PXR – kontrola homeostáze žlučových kyselin

- žlučové kyseliny hrají zásadní roli v eliminaci nabytečného cholesterolu i solubilizaci, absorpci a transportu dietárních lipidů ve střevech; jedná o potenciálně toxické detergenty – proto je jejich produkce velmi přísně kontrolována; vedle toho představuje tvorba žluči významnou cestu eliminace xenobiotik i velkých hydrofóbních endogenních produktů;
- u myší indukuje CAR enzymy a transportéry podílející se na eliminaci žlučových kyselin (Cyp3a11, Sult2a1, Mrp3); PXR pravděpodobně může hrát roli ochrannou – reguluje Cyp3a11 (myš), CYP3A4, SULT a OATP2 – podporují metabolismus a transport žlučových kyselin;
- PXR i CAR pravděpodobně působí v součinnosti s FXR (farnesoid X receptor) – receptor žlučových kyselin – regulace CYP7A1 (cholesterol-7- $\alpha$ -hydroxyláza);



# CAR, PXR a steroidní/thyroidní hormony

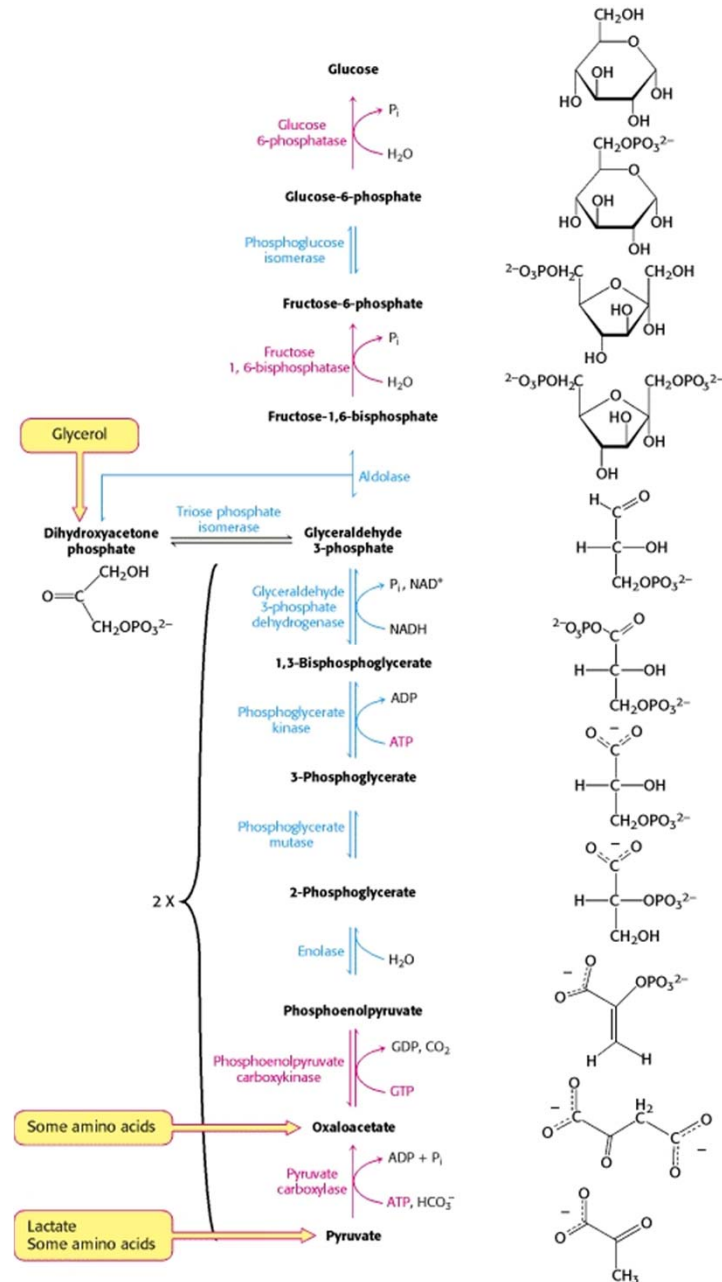
- CAR indukuje CYP2B – metabolizace androgenů/estrogenů; UGT1A1 – glukuronidace estrogenů; může indukovat sulfataci steroidů; tyto procesy vedou ke zvýšenému katabolismu steroidů;
- aktivace PXR – zvýšení hladiny kortikoidů – indukce enzymů podílejících se na jejich syntéze (CYP11A1, 11B1, 11B2); modulace katabolismu steroidů skrz indukci CYP3A4;
- aktivace CAR vede ke snížení sérové hladiny T4 – úloha enzymů II. fáze v poklesu T4 není jasná?



# CAR, PXR a glukoneogeneze/metabolismus lipidů

- aktivátory PXR a CAR potlačují expresi genů podílejících se na glukoneogenezi v játrech což je spojeno se snížením hladiny glukózy v krvi; pravděpodobným mechanismem je potlačení aktivity transkripčních faktorů/ko-faktorů podílejících se na jejich transkripční regulaci (např. FoxO1);
- PXR může zvyšovat syntézu triglyceridů v játrech a zároveň potlačovat  $\beta$ -oxidaci a ketogenezi; vzhledem k tomu, že  $\beta$ -oxidace je nutná pro produkci ATP a NADH, může to souviset s represí glukoneogeneze, která je vyžaduje;

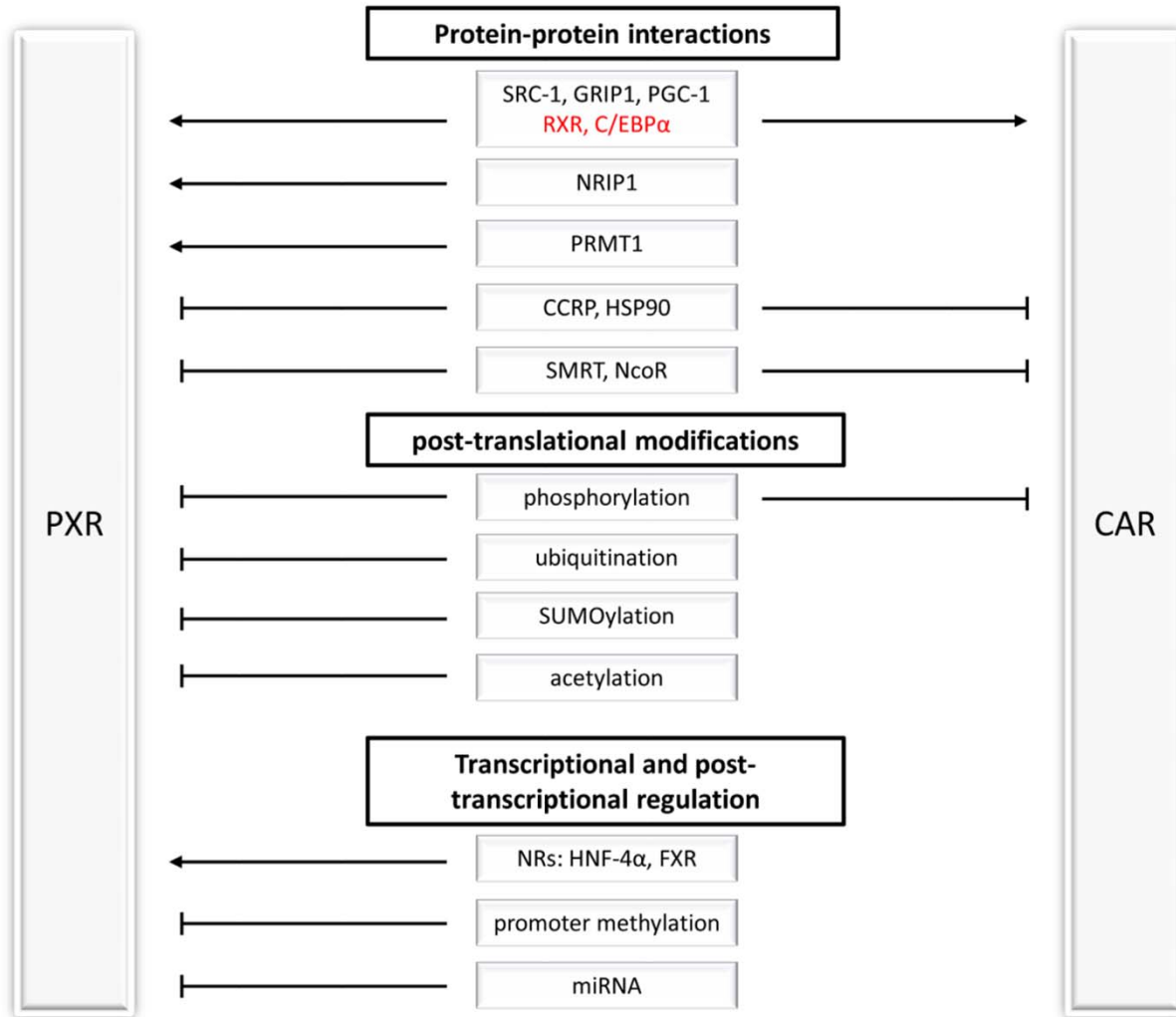
*Biochemistry. 5th edition.  
Berg JM, Tymoczko JL, Stryer L.  
New York: W H Freeman; 2002.*



# CAR, PXR – jejich interakce a interakce s dalšími jadernými receptory

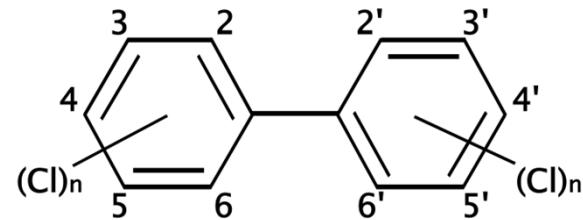
- PXR a CAR indukují expresi *CYP3A* a *CYP2B* genů; přestože původně byly tyto geny považovány za specifické biomarkery obou receptorů, ukazuje se že existuje značný překryv ve spektru indukovaných genů – funkční redundance PXR a CAR; regulace CAR se jeví jako specifitější, ale na druhou stranu může být aktivován i nepřímo prostřednictvím sloučenin, které způsobují jeho jadernou translokaci;
- v posledních letech byla publikována řada prací naznačujících také rozsáhlý cross-talk mezi CAR, PXR a AhR – PXR může indukovat AhR a PXR ligandy tak mohou nepřímo regulovat expresi řady genů kontrolovaných AhR;
- žlučové kyseliny aktivují ve fyziologických koncentracích PXR i FXR; *CYP3A4* může být indukován i FXR; kontrola toxicity žlučových kyselin – indukce PXR vede k represí *CYP7A1* – rate-limiting enzym syntézy žlučových kyselin z cholesterolu;
- jaterní X receptory ( $LXR\alpha$  a  $\beta$ ) – aktivovány oxysteroly, koordinace metabolismu cukrů a lipidů; někteří modeloví agonisté LXR mohou indukovat i PXR (indukce *CYP3A4*, *CYP2B6*);

# CAR, PXR – regulate activity



# CAR, PXR – působení toxikantů

- karcinogeneze – fenobarbital, aktivátor CAR, indukuje tvorbu nádorů jater u experimentálních hlodavců – látky indukující CAR by tak mohly být potenciálními karcinogeny;
- **nedioxinové polychlorované bifenyly – PCB** – indukce CYP2B a 3A v játrech hlodavců; karcinogenní při dlouhodobé expozici;



- hypotéza – PCB, bromované zpomalovače hoření se mohou na modulaci rozvoje obezity, metabolického syndromu a diabetes ???;