

LANDSCAPE

VISIBILITY MAPPING:

THEORY and PRACTICE.

John P. Felleman 1979
School of Landscape Architecture
State University of New York
College of Environmental Science
and Forestry
Syracuse, New York

This research was sponsored by
the New York Sea Grant Institute
under a grant from the Office of
Sea Grant, National Oceanic and
Atmospheric Administration (NOAA),
US Department of Commerce.

FORWARD:

An undertaking of this magnitude, covering two and a half part-time years, involves many participants. I would like to thank Dave Harper and John Warbach of the School of Landscape Architecture for their continued support. Students (present and former) who have assisted in this effort, and the Port Bay Visibility Case Study, include: Varda Wilensky, Rick Dumont, Molly Burgess, Pete Jackson, Doug Johnson, Dennis Jud, and Mark Holzman.

In particular, this study owes its existence to the many practicing professionals and academics who have created a new and exciting field out of whole cloth in a very short period.

The logical structures and conclusions which have been developed to organize the material are my own. The data used is primarily from project reports, at best a "secondary" source. I apologize at the outset for occasionally bending square pegs into round holes, and excising information from its context. If it stimulates thought and discussion, the artistic license is worthwhile.

John Felleman
Syracuse, Summer 1979

CONTENTS

Contents

List of Figures

- I. Introduction
- II. Visibility Mapping - A Working Model
- III. Data Assembly
- IV. Viewshed Deliniation Processes - Stationary
- V. Viewshed Deliniation Processes - Moving
- VI. Output - Plan Views and Perspectives
- VII. Conclusions

Appendix A

References

FIGURES

1. Visibility in Environmental Land Management
2. Visual Transmission
3. Point Light Source Model
4. Visibility Model
5. Landscape Continuum
- 6a. Distance Zones
- 6b. Distance Zones - Perspective
7. Visibility Factors - Open Water
8. Solar Position
9. Seasonal Light Conditions - General
10. View "Of" and "From" Road
11. Skylining
12. Water Influence Zone
13. Enclosure - Massachusetts
- 14a. Enclosure - Hudson Valley
- 14b. Enclosure - Ross County, Ohio
15. Vista Points
16. Viewer Positions
17. Viewer/Distance Distribution
18. Viewshed Limit Accuracy
19. Plan/Perspective
20. Detailed Field Sketch
21. Photo Reference Sketch - Plan and Section
22. Artist Photo Rendering
23. Digitized Elevations
24. DMA Landform Truncation
25. Digitizing Flowchart
26. Terrain Facets
27. USGS Legend
28. LUNR - Area and Point Data
29. NYS Functional Highway Classification
30. View Position Types
- 31a. Observer Environment Conditions
- 31b. Complexity of Visual Field and Edge
32. Field Mapping Accuracy
33. Full Scale View Simulation
34. Projectile Trajectory
35. Plan/Section
36. Military Crest
37. Scenic Overlook
- 38a,b,c Viewshed from Sections

- | | | | |
|-----|-------------------------------------|-----|--|
| 39. | Similar Triangles | 59. | Roadside Visibility |
| 40. | Topographic Model | 60. | Site Visibility - Summer |
| 41. | Illuminated Model | 61. | Site Visibility - Winter |
| 42. | Modelscope Photo | 62. | Field Sketch Panorama |
| 43. | Intermediate Sightline
Points | 63. | Panoramic Photographic
Sequence |
| 44. | Effects of Distance | 64. | View Orientation Vectors |
| 45. | Selected View Lines | 65. | Overlapping Viewsheds |
| 46. | Extent of Views | 66. | Weighted Overlapping
Viewsheds |
| 47. | Roadway Distance Zones | 67. | Overlay Analysis Mapping |
| 48. | Threshold View Angles | 68. | Illustrative Perspective
and Section |
| 49. | Water Based View Angles | 69. | Orthographic Projection |
| 50. | PREVIEW Terrain Plot | 70. | Highspeed Printer Tonal
Map |
| 51. | Slope Fitting | 71. | Line Plotter Visual Map |
| 52. | Relative Aspect | 72. | Grid Perspective with
Diagonal Enhancement |
| 53. | Driver View Cones | 73. | Hidden Line Section Perspective
perpendicular to Line-of-Sight. |
| 54. | Weighted View Cone | 74. | PREVIEW Surface Feature
Plot |
| 55. | Times Seen Map | 75. | Computer Generated Structures |
| 56. | Continuous Road View
Methodology | | |
| 57. | Highway Filmstrip | | |
| 58. | Roadway Visibility | | |

- 76. Highway Perspective
- 77. Outline Perspective
- 78. Fuel Break Computer
Montage
- 79. Highway Computer Montage
- 80. Birdseye Project Cell
Visibility
- 81. NY Sea Grant Visibility
Test Composite Map

I INTRODUCTION

I INTRODUCTION

Vision plays a central role in man's environmental behavior. It has been estimated that approximately ninety percent of our sensory stimulation is visual. Throughout the evolution of culture, landscape visibility has been a major determinant of the location and physical form of human settlements. Examples include defense fortifications, dominant religious structures, navigational aids, and recreation site development.

The comprehensive management of environmental resources encompasses critical stages of resource analysis, land planning and project design. As illustrated in Figure 1, each of the interfaces between these stages incorporates visibility information. These include: scenic assessment, project location, impact analysis, activity allocations, and performance criteria.

Visibility deals with both the geographic extent of surfaces which can be seen, and the legibility of features which, in composite visibility mapping, provides the basis for human perception and cognition

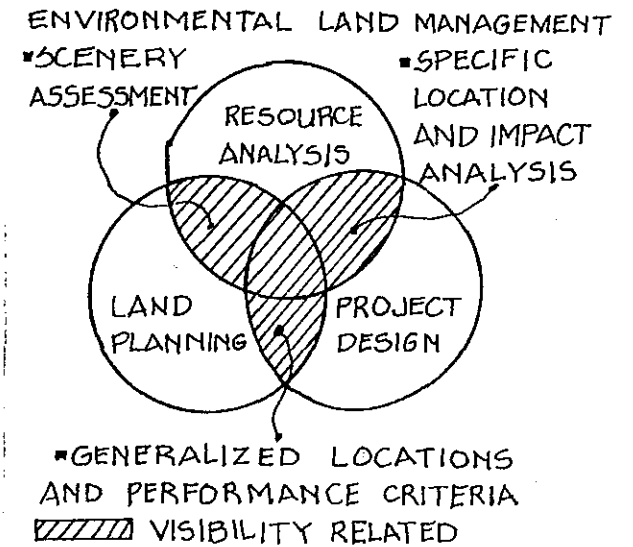

Figure 1: Visibility in Environmental Land Management.

of landscapes. Geographic extent of visibility is the primary emphasis of this monograph.

Historically, development siting and design decisions utilized a limited, intuitive approach to resource analysis. Visibility information was often developed in-situ, by means of direct terrain observations. In the twentieth century, as accurate topographic maps and remote sensing information became available, more sophisticated, off-site methods of visibility mapping evolved. The recent momentum given to environmental studies, particularly aesthetic concerns, by the National Environmental Policy Act (N.E.P.A.) has led to the widespread use of visibility mapping techniques.

In the context of coastal aesthetic research conducted for the New York Sea Grant Program, a wide range of theoretical studies, and project reports were reviewed. The author found that although a variety of methods were apparently being used by design and resource professionals to map visibility, the published documentation exhibited a widespread lack of clarity in both conceptual logic, terminology, and methodological approaches.

Many of these studies appeared to be underfunded, resources expended did not reflect the significance of the information, and some were

clearly isolated from or "tacked on" to a more comprehensive study. In contrast, some excellent prototypical state-of-the-art applied visibility analyses are beginning to emerge from the public and private sectors.

The purposes of this report are threefold:

- a. To develop a coherent, conceptual construct of landscape visibility mapping;
- b. To systematically articulate the alternative methods of data organization, and visibility mapping through the use of selected illustrated examples; and
- c. To foster improved integration of visibility information into complex resource planning and project design.

The body of this report is presented in six parts. Section II contains a working definition of a comprehensive visibility model. Section III includes a discussion of data assembly for the elements of the visibility model; while Section IV is focused on line-of-sight processing methods for stationary positions; and Section V for moving observers. Visibility study outputs, plan views and perspectives, are discussed in Section VI, while some brief conclusions are identified in Section VII.

ENVIRONMENTAL MODEL

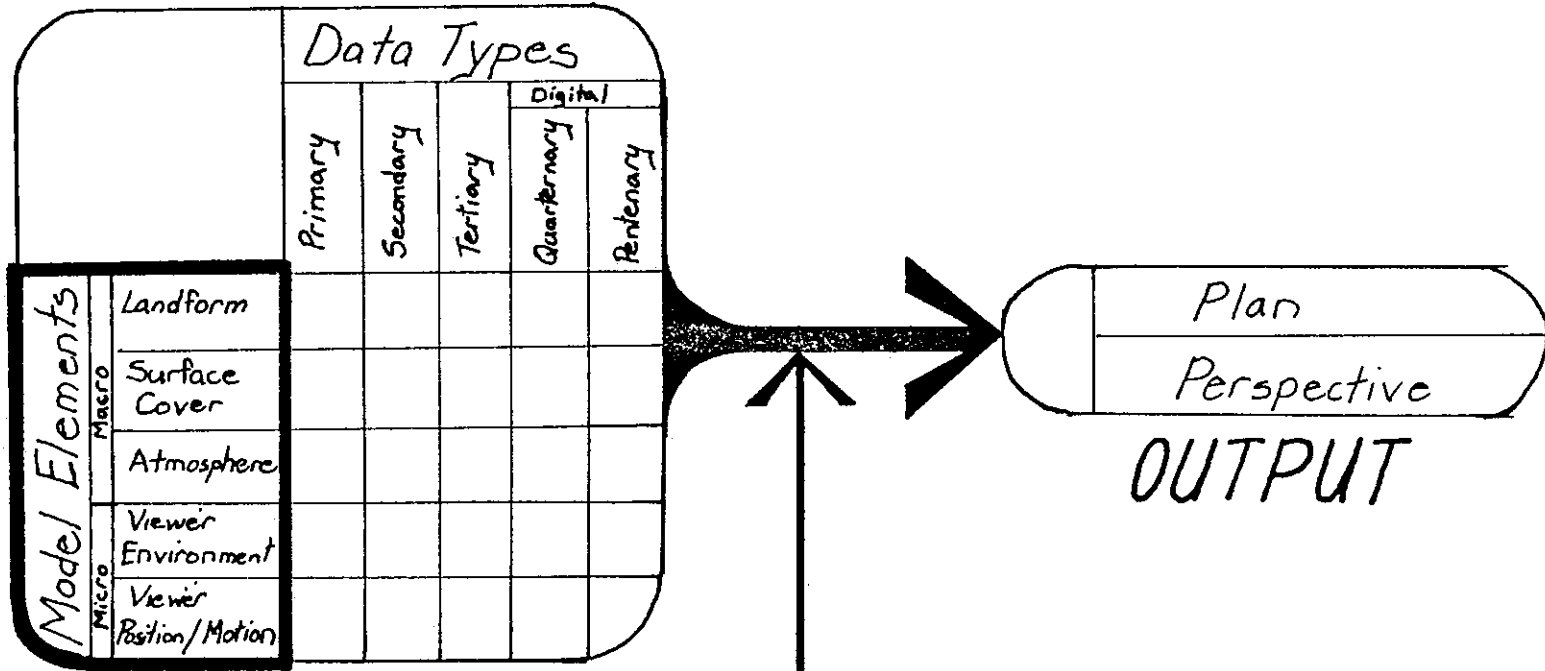

	Stationary	Moving
Direct		
Physical Analog		
Digital		

SIGHTLINE PROCESSES

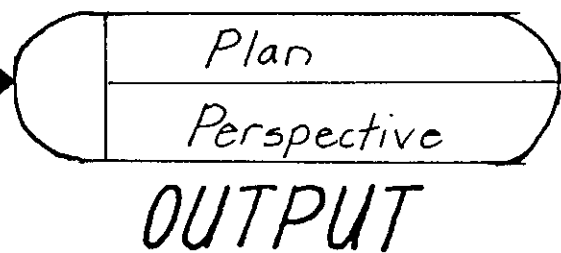

|| VISIBILITY MAPPING -
A WORKING MODEL

II VISIBILITY MAPPING - A WORKING MODEL

A. INTRODUCTION

Many primitive peoples have conceived of sight as a physical process which emanates from the human eye, as shown in Fig. 2. Although modern physics has shown the reverse is true (light enters the eye from external sources) the primitive approach is ideal for understanding the geographic extent of visibility. (Note: A visibility analysis of a smoke stack could "look" at the stack from the adjacent environment, or "look" from the stack into the environment.)

Consider building a scale three-dimensional model of a real landscape. The model is placed in a dark room, and a tiny light source is placed on the model's surface at the position of an observer. The surfaces which are directly illuminated represent the locus of all visible points, the "viewshed".

In the model, the configuration of the surfaces blocks the light from reaching the dark (hidden) areas. This blocking is called "interposition". If we then project the illuminated viewshed vertically

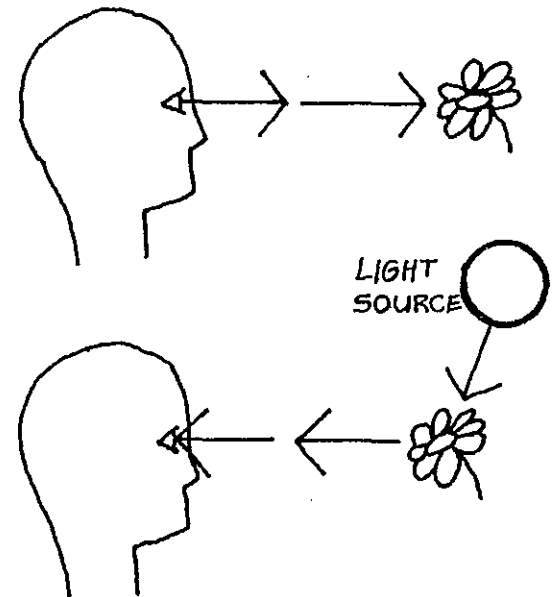

Figure 2: Visual Transmission.

to a horizontal plane, we have constructed a scale "potential visibility map". This is shown in Fig. 3.

The infinite number of light rays in the above example are analogous to "lines of sight" passing from observer to the environment. A major issue in visibility analysis is to selectively reduce the number of such lines investigated to a representative, manageable set.

The word "potential" is used above to clarify the difference between the simulation and the complexities of the real environment. A more comprehensive model of visibility mapping is shown in Fig. 4. Each of the elements is discussed below.

B. MACRO LANDSCAPE

Landforms and surface features are the primary elements of interposition. They also provide the visual content which is the basis for scenery analysis. The role of landforms in the context of scenic evaluations has been extensively explored in previous N.Y. Sea Grant work (Felleman, 1977).

Landforms - Landforms include terrain and surface water features. Visually significant characteristics include size, shape, distance from observer, and aspect (orientation relative to solar position and observer location). In large scale, rugged landscapes, landforms tend to provide

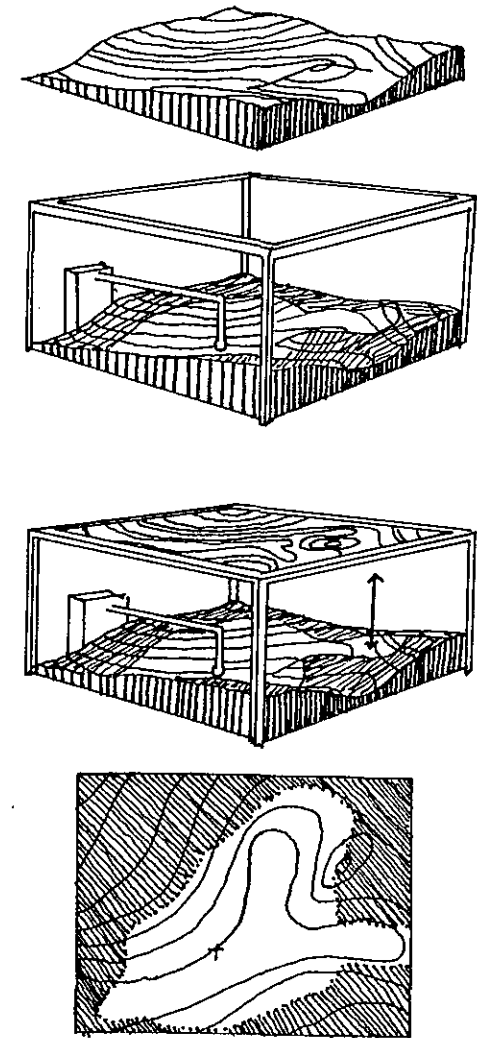

Figure 3: Point Light Source Model.

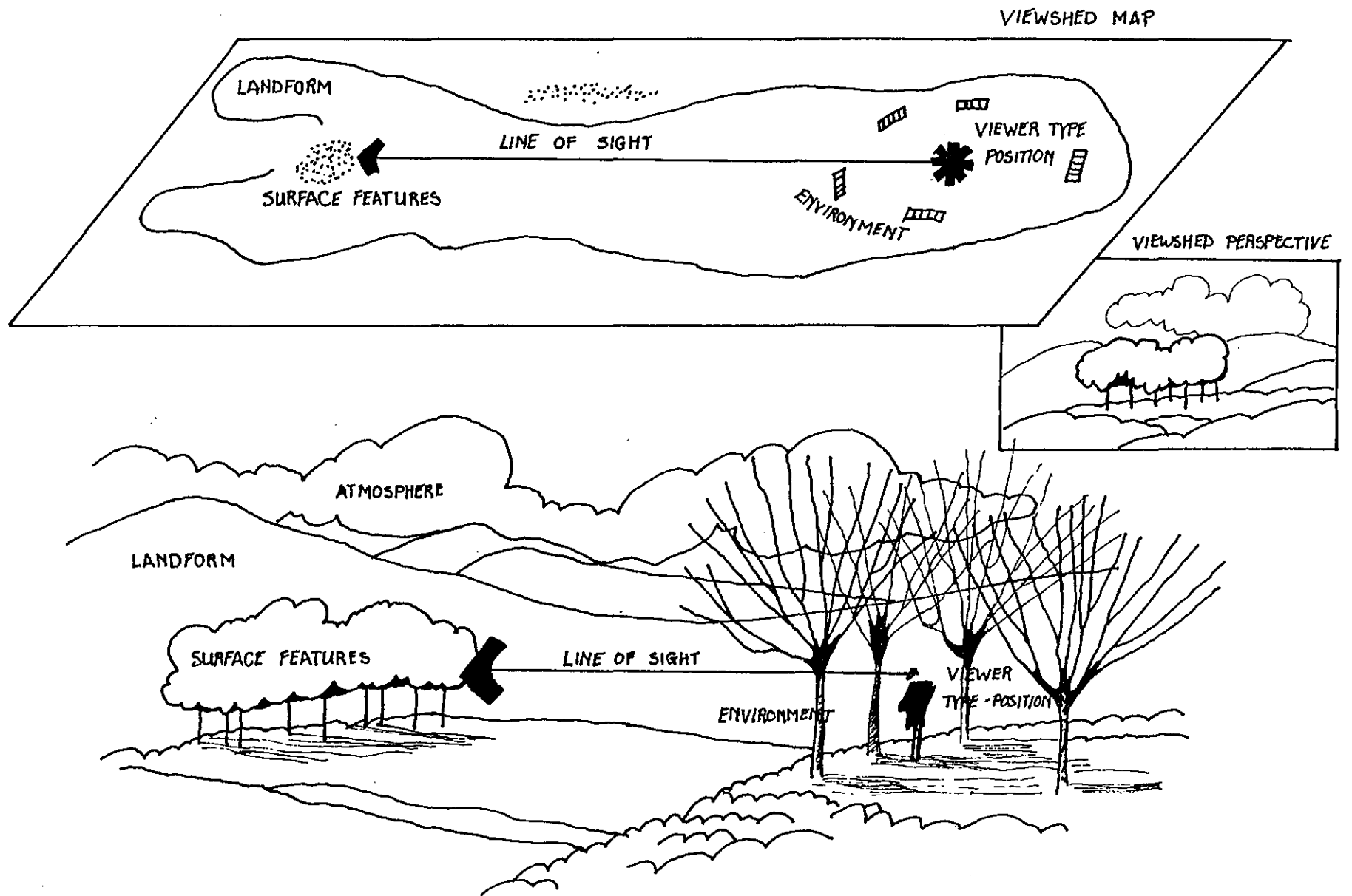

Figure 4: Visibility Model.

the majority of interposition determinants. A frequently used simplification of the visibility model utilizes only landform, observer, lines of sight, and viewshed record. The latter is properly called a "Potential Topographic Viewshed" to clarify its limited scope.

Surface Features - Surface features include vegetation and built forms. Regional scenic studies have developed the general principle that as the scale of landforms decreases, the visual significance of surface features increases (see Figure 5) (Research Planning and Design Associates, 1972, p.N-19).

In addition, field research regarding scale and distance, indicates that the significance of surface features will decrease as sight-line distance increases from foreground, to midground, to background (see Figures 6a, 6b) (Litton, 1968). A New England highway study revealed that land development types could be identified at a maximum of 1 km (0.5 km mean) (Jacobs and Way, 1969).

In a significant water related analysis, the combination of earth curvature and light refraction are shown to reduce the apparent height of water surface objects (See Figure 7) (Roy Mann Associates, July, 1975a, p.293). (See also discussion in Section IV-D).

Landforms are generally static within the time frame of a project oriented visibility study. A major earth moving project would be an

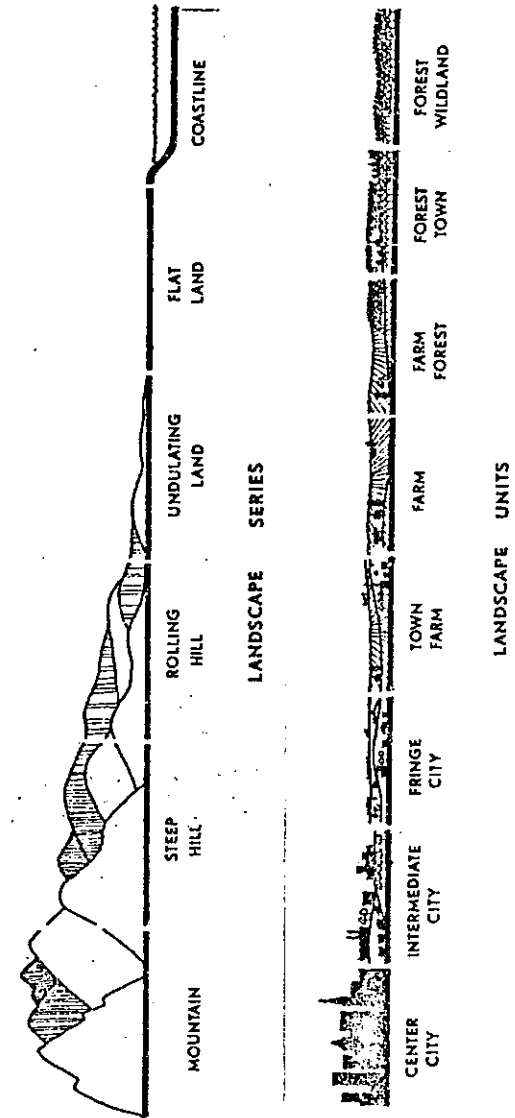

Figure 5: Landscape Continuum.

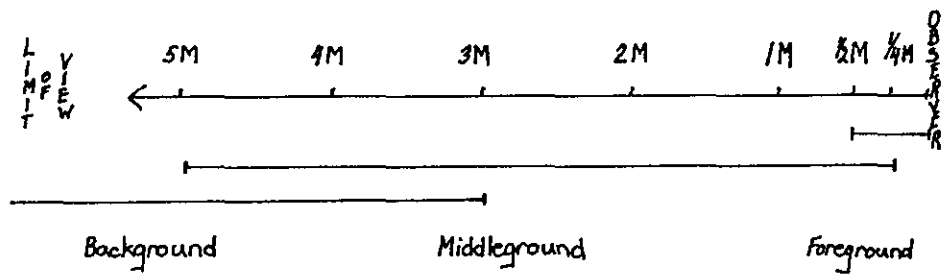

Figure 6a: Distance Zones.

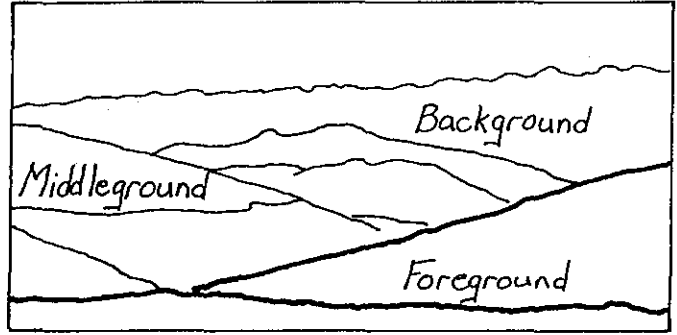

Figure 6b: Distance Zones - Perspective.

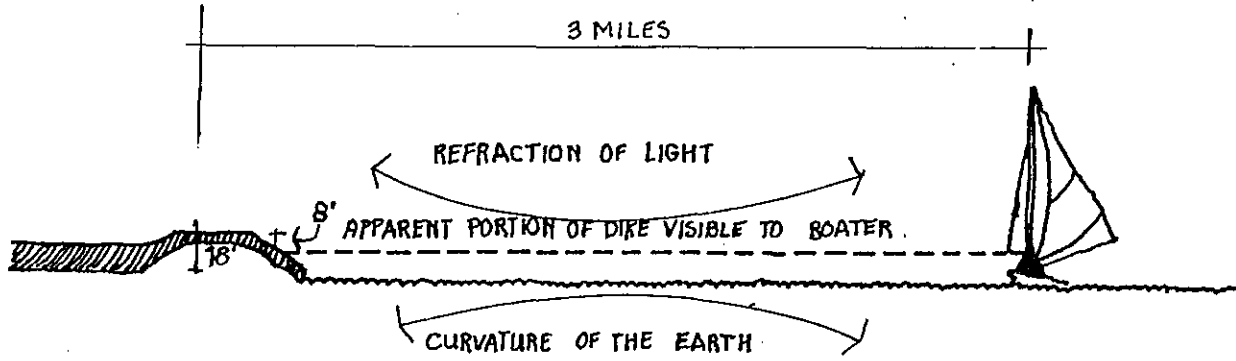

Figure 7: Visibility Factors - Open Water.

example of the exception to this statement. However, the temporal dimension is highly relevant in the treatment of surface features as the seasonal attributes of vegetation and land development changes. A comprehensive visual analysis would include a representative treatment of expected surface feature conditions which are relevant during a project's short-term implementation stage, and its long-term useful life.

Atmosphere - Atmosphere characteristics are a continuously variable element in visibility studies. Lighting conditions, clouds and precipitation can all modify the potential topographic and surface feature visibility. This is important to both viewshed and scenic analyses.

A dramatic visual analysis of Boston from major highways in day and night conditions illustrates an extreme example of variable lighting conditions (Appleyard & Lynch, 1964). The significance of terrain aspect, sun angle, and observer position in viewing surface features is illustrated in Figures 8 and 9 (U.S. Forest Service, 1972, p.12). Aesthetic field research has shown that coastal haze and fog is a frequent factor modifying on-site visibility (Felleman, 1979).

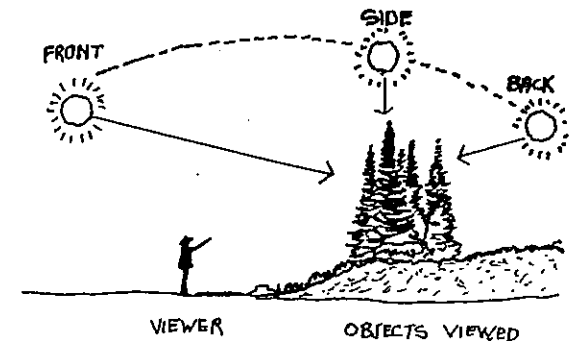

Figure 8: Solar Position.

SEASONAL LIGHT CONDITIONS - GENERAL

	transition period		transition period	
	WINTER	SPRING	SUMMER	FALL
Color Hue	Minimum	Maximum	Medium	Potential Maximum
Color Value	Maximum	Medium	Medium	Potential Maximum
Sun Angle	Lowest	Medium Increasing	Highest	Medium Decreasing
Daylight Time	Shortest	Increasing	Longest	Decreasing
Probable Light Variations	Medium	High	Low	High
Mean Shadow Lengths	Maximum	Medium Decreasing	Shortest	Medium Increasing

Figure 9: Seasonal Light Conditions - General.

C. OBSERVER

As noted earlier, a major consideration in designing a visibility study is to effectively select a representative set of lines-of-sight to be investigated. Particular views may be highly significant because of their frequency of occurrence, the unique content of the scene, or a combination of these factors. Frequency of occurrence is typically associated with concentrations of observers. In addition, for projects which will generate new viewers the analysis should include views of the project and from the projects. Figure 10 depicts "views of the road" and "from the road".

Type and Quantity - Type and quantity of viewers is often interpreted from activity patterns such as residential clusters, recreation sites, and major vehicular routes. The U.S. Forest Service has identified three functional criteria for analyzing observers: number, view duration, and scenic concern (recreation, residential, other) (U.S. Forest Service, 1974, p.18). In an analysis of proposed cooling tower alternatives for a Hudson River power plant, analysts quantified and weighted residential, auto, rail, and boat viewers within the potential viewshed influence zone (Jones and Jones, 1975). In a transmission line study, the number of observers was factored by ... "An attention analysis, (which) addresses

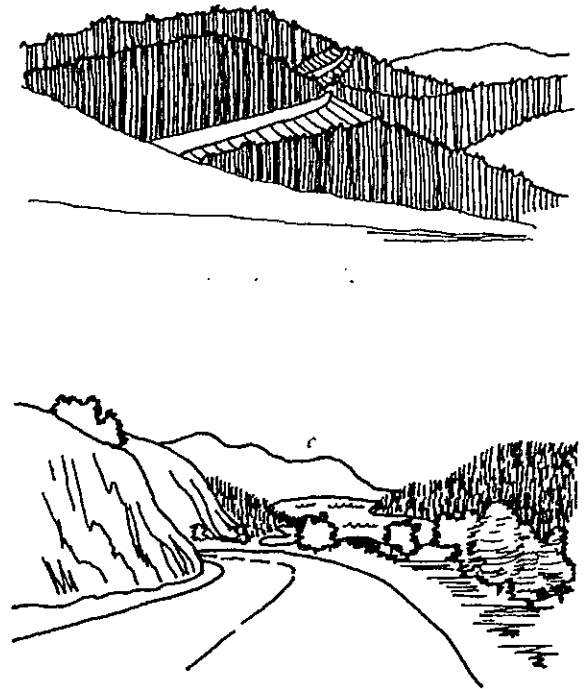

Figure 10: View "Of" and "From" Road.

how many of the potential viewers will be preoccupied with other aspects of the landscape ..." (Carruth, et al., 1977, p.32). Attention may also be used as a design principle in providing sequential variety (Pragnell, 1970, p.38).

Unique Scenes - Resource and scenery studies must often deal with the protection of unique and sensitive landscapes. In a remote wilderness area for example, it might be important to protect a view of a unique feature for potential, aesthetically sensitive viewers years or even generations in the future. In this case viewsheds are mapped from significant landscape features to identify potential view influence zones.

Examples of visually significant landscape features include: hill-tops and skylines, water features, enclosed valleys, vista points, and unique resources. In one of the earliest visually related guidelines, the Federal Power Commission stated that rights of way should not cross ridgelines parallel to the line-of-sight, and that structures should not be placed at the crest of a hill (Federal Power Commission, 1970). This logic is based on our perceptual use of skylines to provide constant orientation, combined with the high degree of visual contrast given to objects silhouetted against the sky. (See Figure 11).

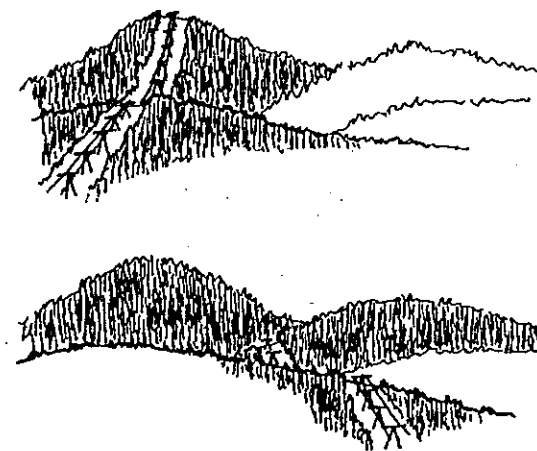

Figure 11: Skylining.

There is a general consensus that the presence of water greatly enhances the scenic quality of a view. In addition, water features often provide opportunities for extended, unobstructed views. In a comprehensive study, a hierarchical classification of water-related features was proposed: the landscape unit, setting unit, and waterscape unit (Litton, et al., 1974). The latter includes the adjacent upland slopes which are visually related to the water surface (see Figure 12).

The pioneering N.Y. Hudson River Valley Commission had a flexible jurisdictional limit based on the water-surface viewshed. This approach has been used in studies of the Potomac and Lake Tahoe, and has been incorporated in federal and state, wild and scenic river legislation.

Enclosure is another scenically positive landscape attribute. Potential for open views within an enclosed valley was a central concept in the classification of Massachusetts's scenic highways (see Figure 13). This concept has also been incorporated in studies of the Hudson Valley (see Figure 14a) (Harper, 1978, p.38), and Ross County, Ohio (see Figure 14b) (Kobayashi, 1975, p.160).

Scenic turnouts, recreation trails, and residential sites are all enhanced by location at points in the terrain where broad vistas

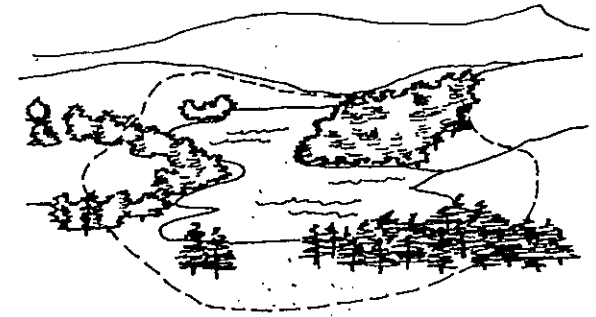

Figure 12: Water Influence Zone.

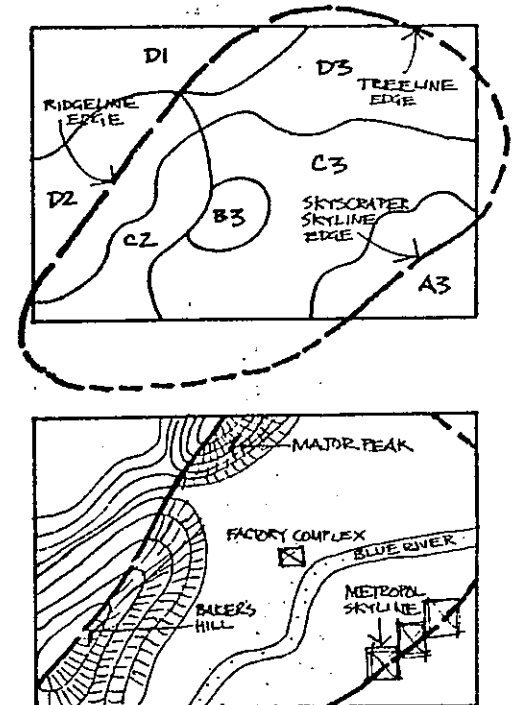

Figure 13: Enclosure - Massachusetts.

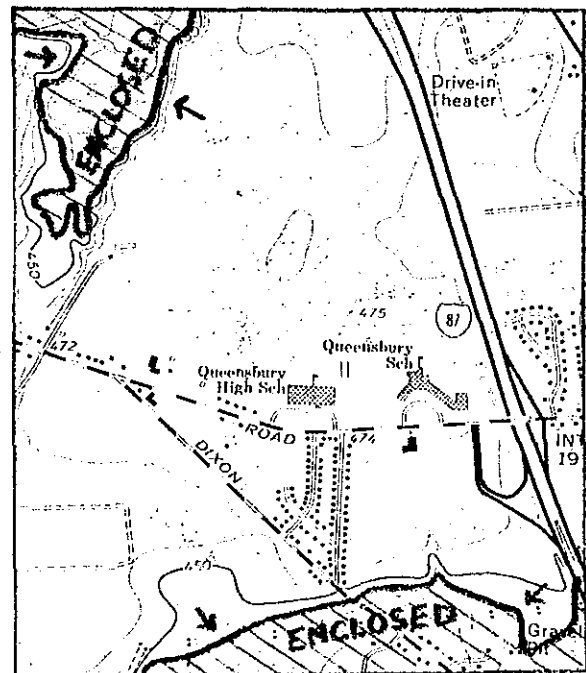
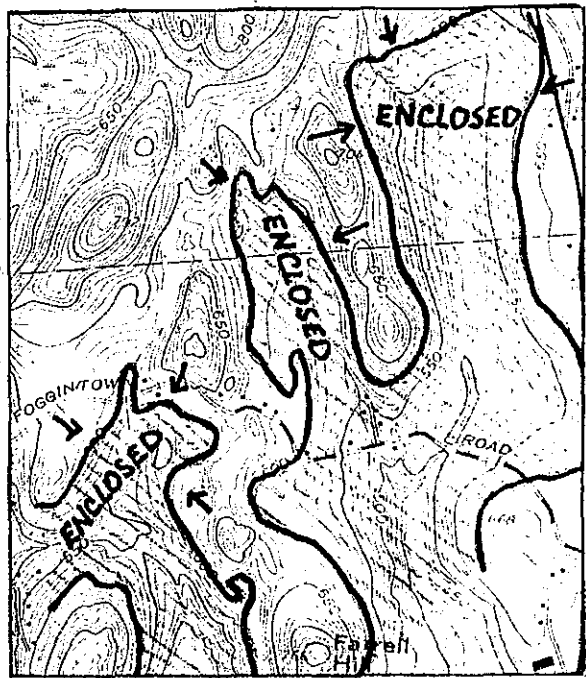

Figure 14a: Enclosure - Hudson Valley.

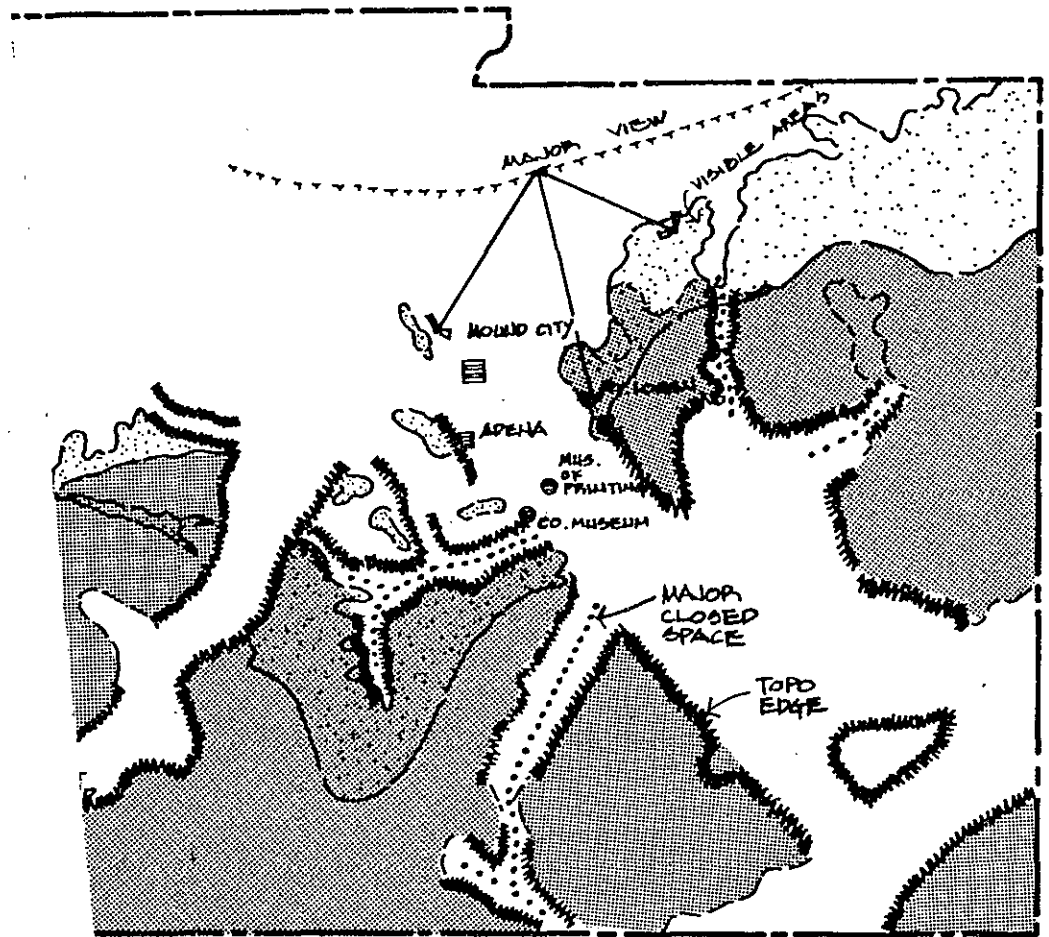

Figure 14b: Ross County - Ohio.

are available. In rugged terrain, peaks and ridgelines often provide maximum views; while in more logically mature land forms, maximum views tend to occur where steep side slopes end at the base of the rounded terraces and crowns. (See Military Crest, Section IV.) (See Figure 15.)

Position and Motion - Viewshed and view content are functions of viewer position and motion. Three prototypical viewer positions relative to the vertical composition of the scene have been identified: superior (above), normal (intermediate), and inferior (below). (See Figure 16) (Litton, 1968, p.7).

A matrix of viewer positions and distance zones developed to aid in the selection of scenic impact analysis locations, is shown in Figure 17 (Battelle, 1974, p.97).

The relationships of viewer motion and visibility have been extensively studied from the perspectives of ground and air traffic safety. Unlike the stationary position which is typically presumed to have a 360° potential viewshed, medium and high speed motion has been shown to limit the normal cone of vision particularly for the driver. The concept of view cone is discussed in Section V.

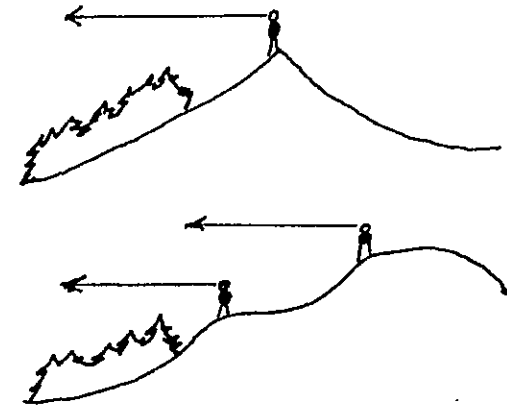

Figure 15: Vista Points.

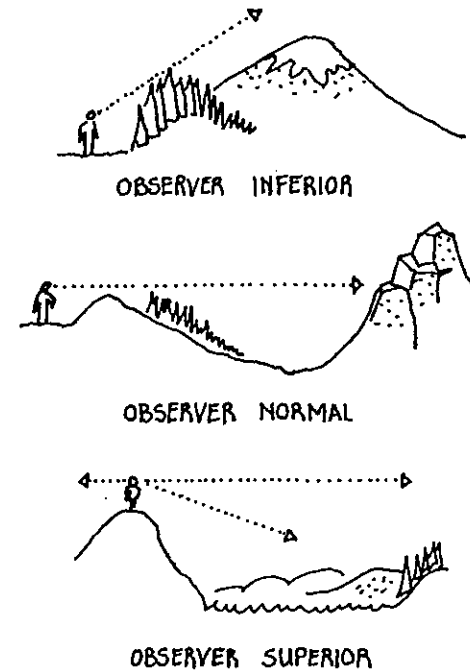

Figure 16: Viewer Positions.

Observer Environment - Observer environment includes both observer container (vehicle, building windows...) if any, and the immediate natural and built landscape. Although conceptually these factors are a localized continuum of the Macro Landscape surface described above, it is analytically useful to differentiate immediate foreground objects.

Both observer containers and immediate landscape are often design variables which may be studied in detail such as window orientation and screening plantings. Because these features may not be visually opaque or continuously solid, view "filtering" as well as interposition may occur. Many impact studies now incorporate seasonal "foliate" and "defoliate" visibility analyses.

In addition, the accuracy and scale of data needs may be very different for immediate and macro landscapes. For example, a forest mass on a topographic map may correctly define a hillside midground skyline condition while the map may not have any indication of a single roadside hedge which effectively blocks or filters views from the route.

D. PROCESSES

Lines of Sight - All viewshed delineation methods make use of one or more line-of-sight techniques. These may be generally grouped into: field approaches, physical analogs, and numerical simulations. Field

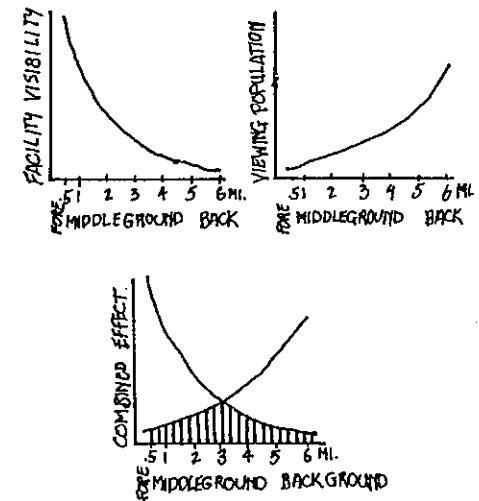

TABLE 15. Idealized Viewpoint Distribution: Natural Draft Cooling Tower Alternative (12 Final Viewscapes Required).

Distance	Observer Inferior	Observer Normal	Observer Superior
Foreground 0-1/2 Miles	1	.	.
Middleground 1/2-5 miles	1	6	1
Background >5 miles	.	2	1

Figure 17: Viewer/Distance Distribution.

approaches are the traditional in-situ "actual views". Modern adaptations include the use of airplanes, helicopters and balloons, as well as photographic recording techniques to expand the scope and content of the method.

Physical analogs primarily include interpretation of topographic maps by means of cross sections, vertical stereo air photo interpretation, and the use of terrain models utilizing periscope optics (model scope) or point light sources. The latter was briefly described in the introduction (see Figure 3). Numerical simulations utilize digital computers to "pass" line-of-sight vectors from the selected observer positions to intercept a numerical (x,y,z) approximation of the macro landscape.

Recording - The locus of lines-of-sight must be recorded in a format which is compatible with the resource analysis, planning, or design data needs. Limits of visibility may be recorded directly in the landscape by the placement of markers. More typically, plan view maps and perspectives are prepared which depict the viewshed limits and view content, respectively. It is important in processing data to articulate both the type and quality of view limit so that subsequent interpretations are properly founded. For example, recording should differentiate between moving and stationary views, the presence or absence of seasonal

vegetation considerations (such as filtering), and the geographic specificity ("hard", "soft", "ambiguous") of the viewshed limit delineation. The latter is illustrated in Figure 18.

Computerized resource studies typically require numerical inputs of visibility. These can range from a single +,- (visible, not visible) to sophisticated geographic matrices of "weighted scores" which incorporate the area of view, distance, slope/aspect, and number and types of observers (see Section IV-D). Although mapped visibility is useful to the interpreter, actual computer format is typically tabulated cards or tapes. Perspectives are highly useful in illustrating the content of scenes due to the ease of reader legibility (see Figure 19) (Roy Mann Associates, Dec., 1975, p.77).



Figure 18: Viewshed Limit Accuracy.

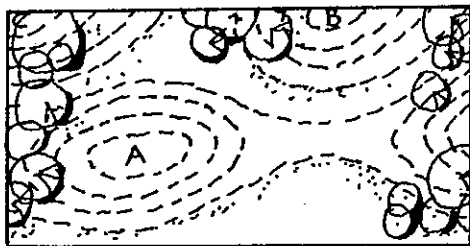

PLAN

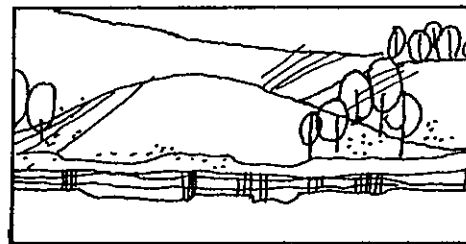

PERSPECTIVE

Figure 19: Plan/Perspective.

ENVIRONMENTAL MODEL

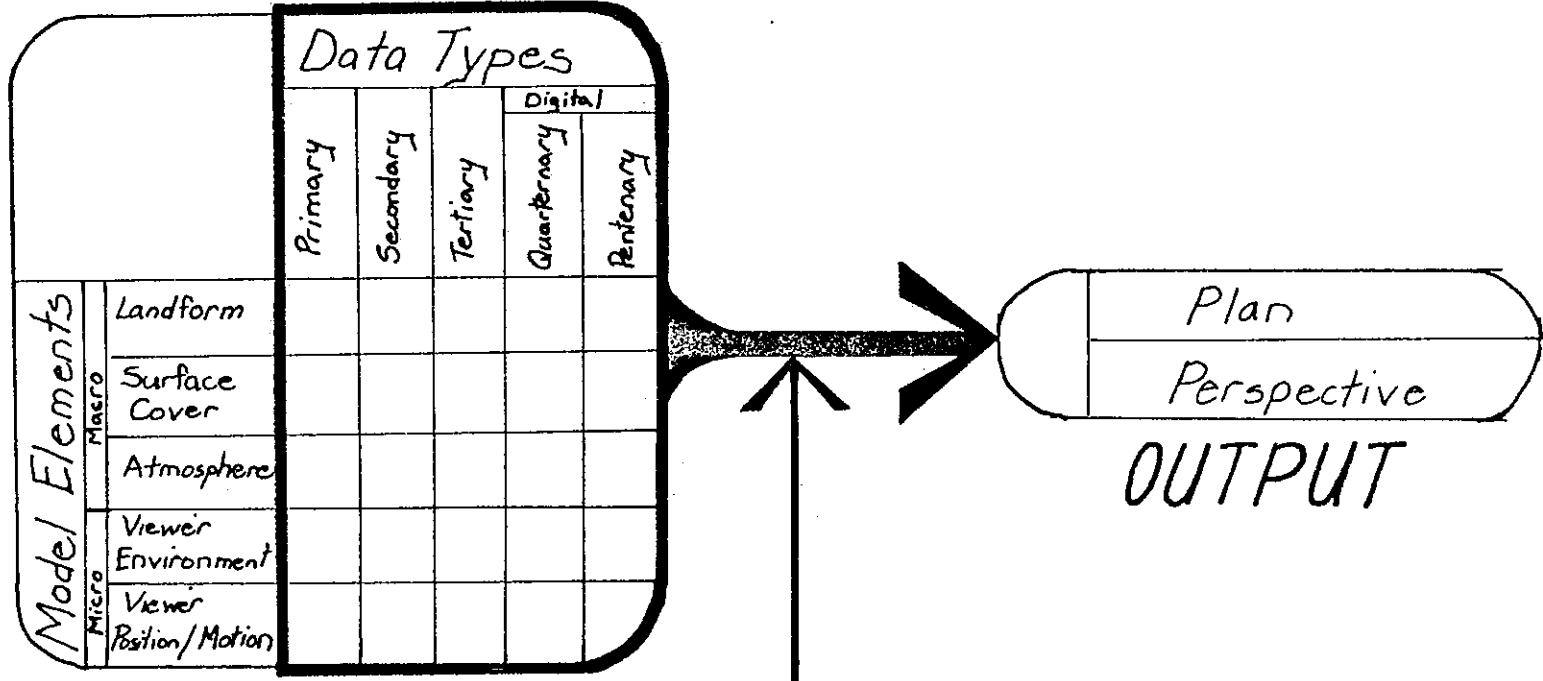

	Stationary	Moving
Direct		
Physical Analog		
Digital		

SIGHTLINE PROCESSES

DATA ASSEMBLY

III DATA ASSEMBLY

A. INTRODUCTION

The macro landscape and observer components of the visibility model require the collection and synthesis of terrain and surface character data. Careful attention to this stage of study design is important for internal consistency, i.e., that the data is compatible in form and quality with the subsequent line-of-sight process to be utilized. In addition, external consistency is also significant. This includes the sharing of information gathered from other components of the resource analysis project.

It is highly useful in discussing data to clarify its relationship to the actual environment. In this monograph the following functional definitions will be used:

PRIMARY DATA - Data collected in the field. Examples include photographs, sketches, map notes, videotapes, and position marking such as flags and stakes.

SECONDARY DATA - Information, typically mapped, which has been processed expressly for the visual study, or for a direct data need of the study. An example of the former is a forest cover map made from air photos; while the latter would include topographic maps such as the U.S.G.S. 7½ minute quadrangles.

TERTIARY DATA - Mapped geographic information not expressly developed for visual studies. Examples would be soil surveys, wetland designations, and New York's Land Use and Natural Resources Inventory (L.U.N.R.).

QUARTERNARY DATA - Numerically processed secondary and tertiary data. This information has been manipulated for inclusion in digital computer analyses. Examples are the grid cell centroid elevations obtained from topographic base maps, and height and diversity of vegetation interpreted from air photos and stored for ¼ square kilometer cells in the EDAP study (Landscapes Limited, 1973).

PENTENARY DATA - Numerically hybrid quarternary data. Examples include slope and aspect maps generated from grid cell elevations (Travis, et al., 1975), and grid cell elevations developed from "random" point elevations (Sampson, 1978).

In the following brief overview, each Macro Landscape and Observer Environment element of the visibility model will be addressed from the standpoint of primary, secondary, tertiary, and quaternary data considerations. Pentenary discussions are included where appropriate.

B. LANDFORM

Three dimensional physiography is usually the dominant interposition factor in large and medium scale landscapes (e.g.: those that contain views of background and midground distances).

1. Primary

Primary terrain data may include topographic surveys, field sketches, ground level photography and vertical aerial photography. Field sketches were the traditional means of recording land features on maps by exploration parties. An example is shown in Figure 20 (Litton, 1973, p.3). Although viewer position (or object location) photography has largely supplanted the need to manually portray detailed features, field sketches supplemented by notes can be highly useful in highlighting the character of terrain features as experienced and photographed in the field (see Figure 19) (see Figure 21) (Litton, 1973, p.21).

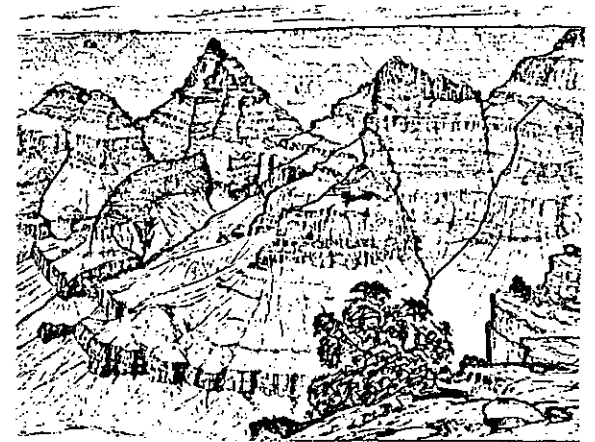

Figure 20: Detailed Field Sketch.

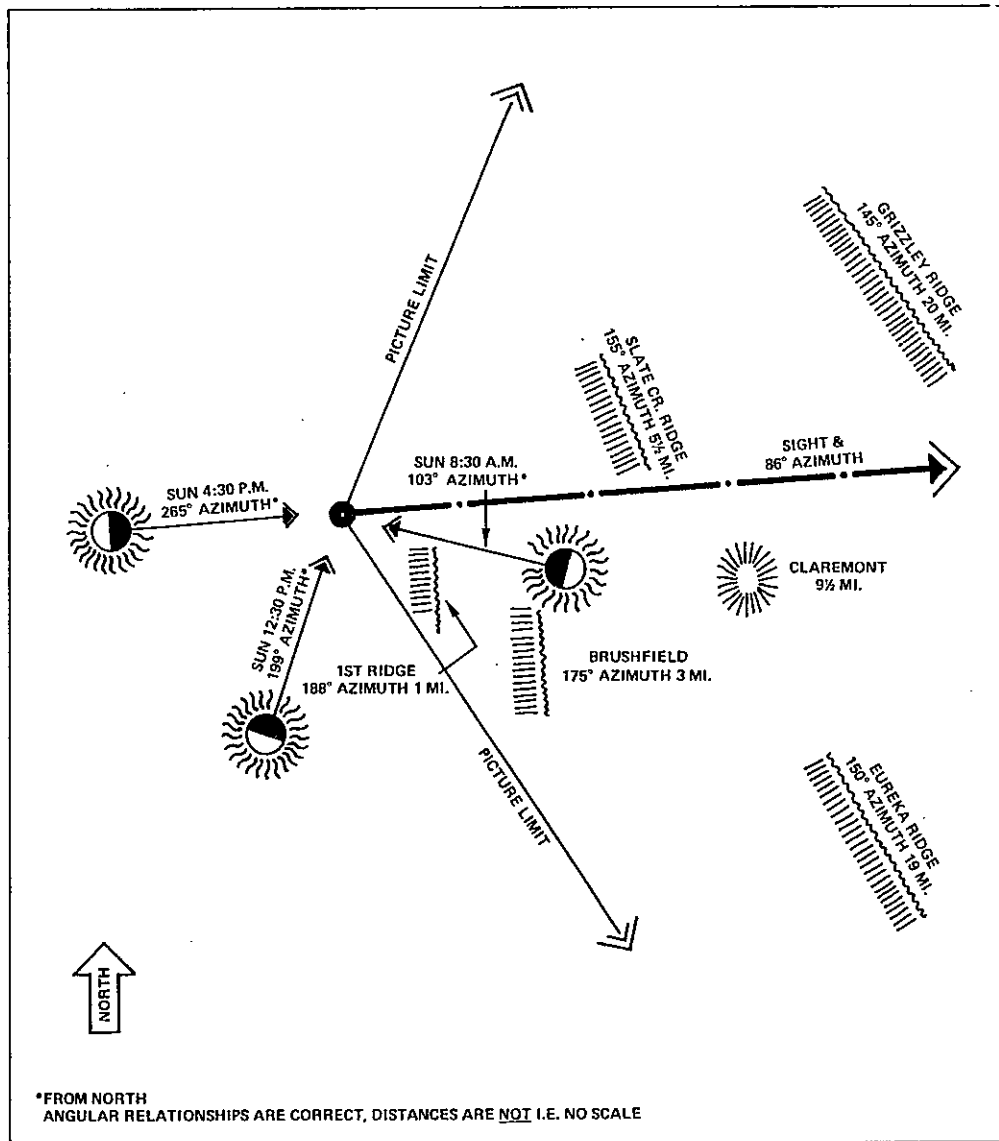
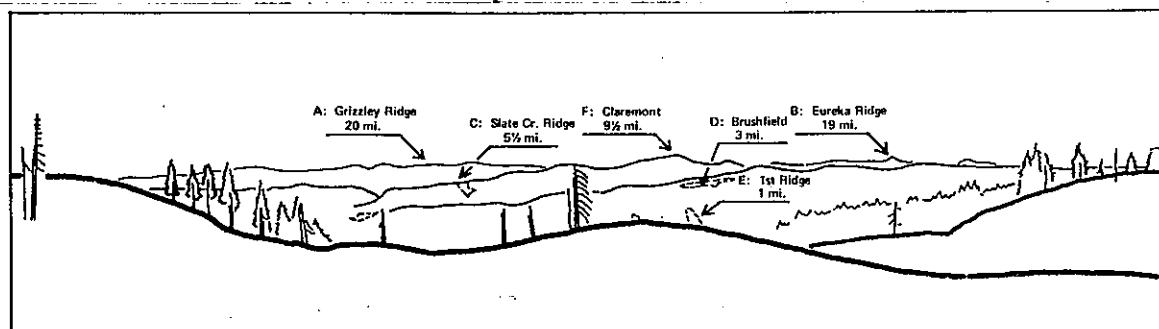

Figure 21: Photo Reference Sketch

Plan diagram

Distance diagram



Viewer position (or object location) photography is a major primary terrain data collection technique. Ground photography is particularly useful in the direct analysis of profiles and skylines, and the evaluation of "before and after" scenic impacts using artist renderings (see Figure 22) (U.S. Nuclear Regulatory Commission, 1977) and computer plots (Kunit, Calhoon, 1973; Aerospace Corp., 1977; Penzien, 1978, p.36) (see Section IV).

Vertical aerial photographs in stereo pairs can be used to update major topographic changes such as landslides, reservoir construction and surface mining.

2. Secondary

The U.S.G.S. topographic maps provide analysts with the major source of terrain information. Contours (lines connecting points on the ground surface of identical surface elevation) are plotted to national map standards. Analysts should be sensitive to the dates of the U.S.G.S. photography and interpretation.

In some study locations more detailed topographic maps may be available. For example the New York State Department of Transportation has developed 1" = 20', 50' maps for the vicinity of its project locations. In recent years many advances have taken place in the field of cartography. One of the most promising is the "orthophoto map", the plotting

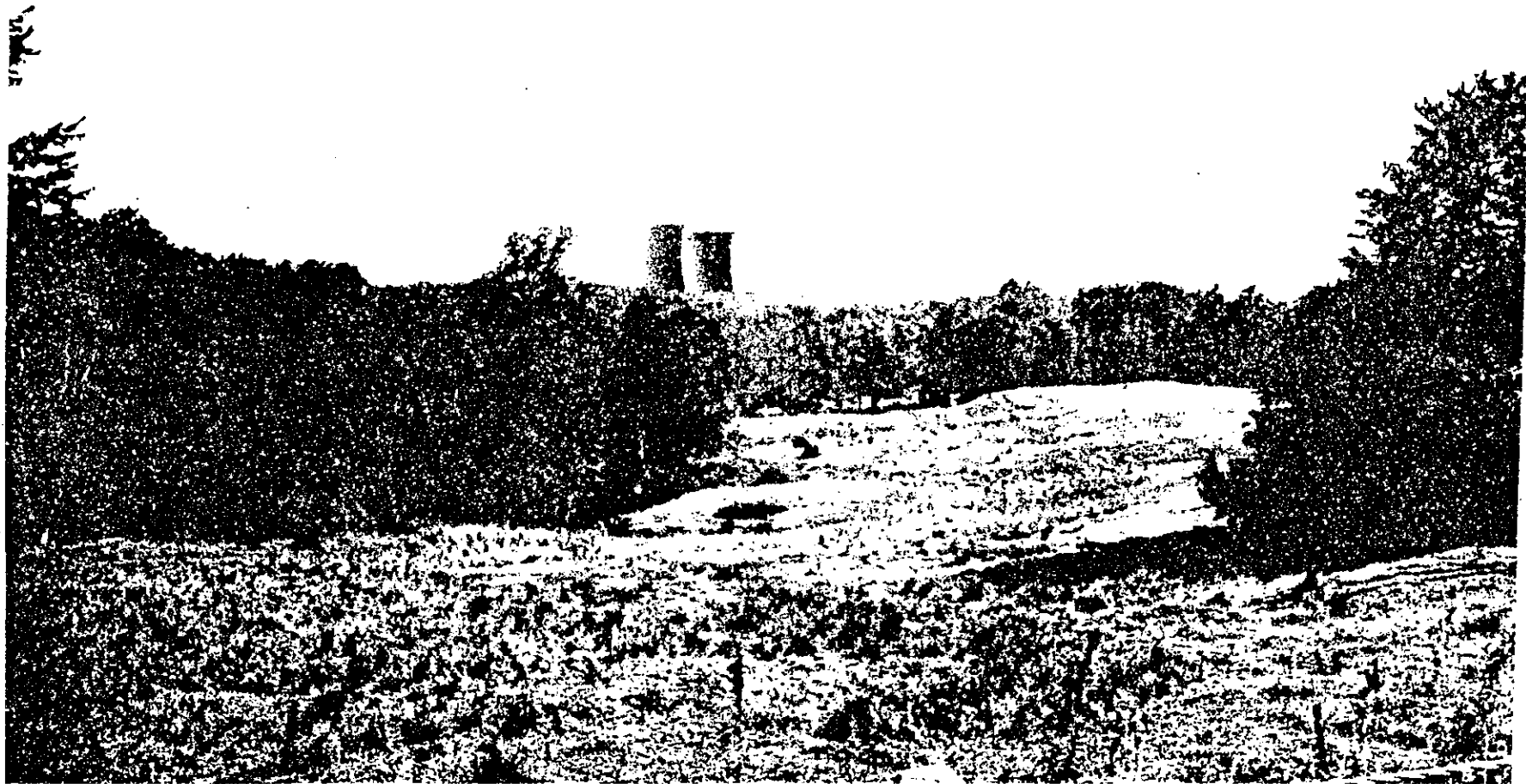

Projected View of 565-Foot Towers

Figure 22: Artist Photo Rendering.

of pertinent terrain-contours and cultural information on a distortion corrected air photo mosaic. The U.S.G.S. is introducing these maps in its nationwide map series.

3. Tertiary

Where available, surficial geology maps are readily combined with topography to define visually relevant landforms. In contrast bedrock geology, and soil survey maps appear to be of little direct use.

4. Quarternary

With the advent of digital terrain analysis, (see Section IV) considerable research interest has been devoted to the development of digitized data banks of terrain information. Typically these include a matrix of cartesian coordinates with associated elevations for each grid intersection (or cell centroid) (see Figure 23).

At present, the only widely available terrain data is the Defense Mapping Agency's (D.M.A.) tapes which are a digitized grid of the U.S. Geological Survey 1:250,000 generalized topographic maps. Ground cells are 200' square (National Cartographic Information Center).

The suitability of this information for visual analyses is a function of the scale of the project area, and the degree of resolution

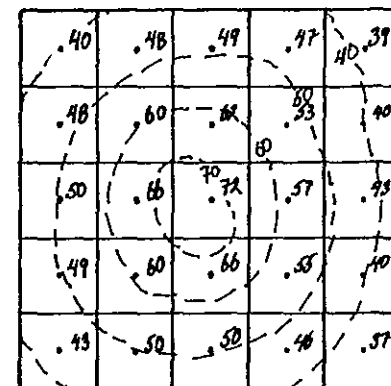
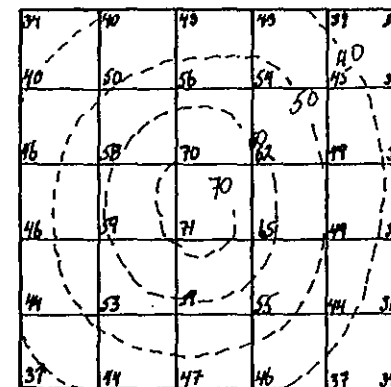

Figure 23: Digitized Elevations.

required. In an innovative scenic river study, the D.M.A. tapes were used to establish the "scenic boundary" for the Upper Missouri. Since the D.M.A. information has a maximum deviation of 400' horizontally and 100' vertically, the study was designed to map 400 acre units (1,320' square). This approach was considered conservative as a "V" shaped valley is approximated by a trapezoid (see Figure 24) (Van Dyke, 1977, p.7). In contrast, the N.Y. Sea Grant Port Bay Case Study found that the vertical relief of the 1:250,000 maps and the D.M.A. tapes were too gross to accurately represent low relief coastal areas (Felleman, 1979).

With the rapid evolution of computer hardware and software, many alternatives are now available to generate data for subsequent analysis with numerical terrain routines. Since most analyses internally utilize numerical grids, decisions must be made regarding accuracy, cost, and whether to input a grid (quaternary) or to generate a grid with a software program from non-grid points (pentenary).

Digitizing is the process of converting pictorial information (maps, photos, etc.) to a computer compatible (cards, tapes, etc.) numerical format (U.S. Forest Service, 1978).



Figure 24: DMA Landform Truncation.

In discussing computers, it is useful to incorporate the process sequence: input, analysis, and output. Since geographic information can be grouped into points, lines and areas (polygons), Figure 25 depicts the variety of approaches currently available for developing digital terrain model base data.

Quaternary processing entails superimposing a grid on the data source information and either manually recording, or electronically digitizing corner point (or centroid) elevations.

5. Pentenary

Pentenary data can be developed in various ways. "Random" points (either statistically random or selected) can be digitized in x,y,z coordinates and a numerical surface program run to create grid elevations (Sampson, 1978, p.91). Linear contours can be digitized (x,y coordinates along the contours, one z elevation associated with each linear string) with subsequent transformation into a numerical grid (Aerospace Corp., 1977, p.5-1).

An analytically powerful means of representing a three dimensional surface is to approximate it with a finite number of

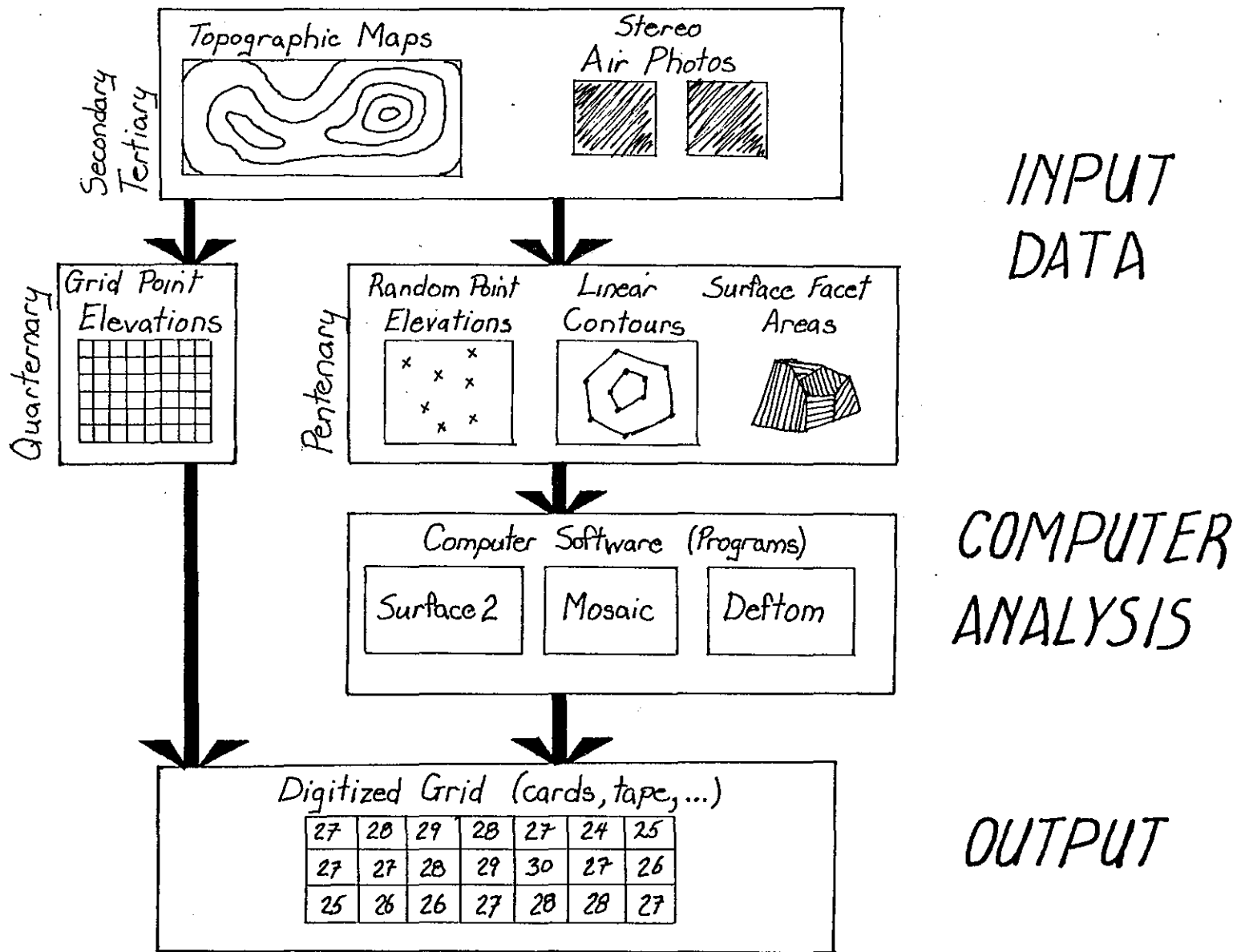

Figure 25: Digitizing Flowchart.

facets, each with internally consistent surface characteristics. This approach is widely used in industrial design (automobile bodies), and computer graphic shading (Newman, Sproull, 1973, part IV). In land form analysis a growing utilization is being made for slope, aspect, and watersheds (see Figure 26). A computer-derived numerical data bank can be made by inputting the polygon or corner outline of facet areas and associating general surface curvature with each area (Wagar, 1977).

C. SURFACE FEATURES

The significance of terrain surface features, vegetation, and buildings, for interposition in the study area should be carefully considered at the project outset. As the scale of terrain features, and/or the distance to observer positions increase, the significance of surface features in defining macro landscape limits of visibility diminishes.

1. Primary

Field sketching and field photography are generally an inefficient means of assembling comprehensive surface cover information. Major difficulties may be encountered in transcribing such information accurately to a topographic base map.

In contrast, vertical air photos (particularly stereo pairs) provide the most significant data source. Note, however, that field checks

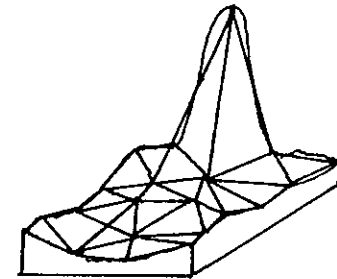
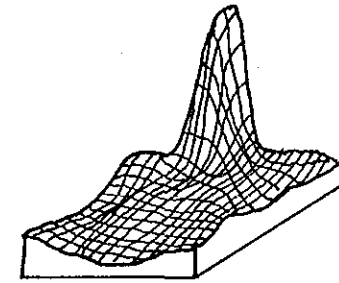

Figure 26: Terrain Facets.

Figure 27: U.S.G.S. Legend.

Primary highway, hard surface	
Secondary highway, hard surface	
Light-duty road, hard or improved surface	
Unimproved road	
Road under construction, alinement known	
Proposed road	
Dual highway, dividing strip 25 feet or less	
Dual highway, dividing strip exceeding 25 feet	
Trail	
Railroad: single track and multiple track	
Railroads in juxtaposition	
Narrow gage: single track and multiple track	
Railroad in street and carline	
Bridge: road and railroad	
Drawbridge: road and railroad	
Footbridge	
Tunnel: road and railroad	
Overpass and underpass	
Small masonry or concrete dam	
Dam with lock	
Dam with road	
Canal with lock	
Buildings (dwelling, place of employment, etc.)	
School, church, and cemetery	
Buildings (barn, warehouse, etc.)	
Power transmission line with located metal tower	
Telephone line, pipeline, etc. (labeled as to type)	
Wells: other than water (labeled as to type)	
Tanks: oil, water, etc. (labeled only if water)	
Located or landmark object; windmill	
Open pit, mine, or quarry; prospect	
Shaft and tunnel entrance	
Horizontal and vertical control station:	
Tablet, spirit level elevation	BM Δ 5653
Other recoverable mark, spirit level elevation	Δ 5455
Horizontal control station: tablet, vertical angle elevation	VABM Δ 9519
Any recoverable mark, vertical angle or checked elevation	Δ 3775
Vertical control station: tablet, spirit level elevation	BM X 957
Other recoverable mark, spirit level elevation	X 954
Spot elevation	x 7369 x 7369
Water elevation	670 670

Boundaries: National	
State	
County, parish, municipio	
Civil township, precinct, town, barrio	
Incorporated city, village, town, hamlet	
Reservation, National or State	
Small park, cemetery, airport, etc.	
Land grant	
Township or range line, United States land survey	
Township or range line, approximate location	
Section line, United States land survey	
Section line, approximate location	
Township line, not United States land survey	
Section line, not United States land survey	
Found corner: section and closing	
Boundary monument: land grant and other	
Fence or field line	
Index contour	
Supplementary contour	
Fill	
Levee	
Mine dump	
Tailings	
Shifting sand or dunes	
Sand area	
Intermediate contour	
Depression contours	
Cut	
Levee with road	
Wash	
Tailings pond	
Intricate surface	
Gravel beach	
Perennial streams	
Elevated aqueduct	
Water well and spring	
Small rapids	
Large rapids	
Intermittent lake	
Foreshore flat	
Sounding, depth curve	
Exposed wreck	
Rock, bare or awash; dangerous to navigation	
Intermittent streams	
Aqueduct tunnel	
Glacier	
Small falls	
Large falls	
Dry lake bed	
Rock or coral reef	
Piling or dolphin	
Sunken wreck	
Marsh (swamp)	
Wooded marsh	
Woods or brushwood	
Vineyard	
Land subject to controlled inundation	
Submerged marsh	
Mangrove	
Orchard	
Scrub	
Urban area	

are highly useful in developing a correct photo interpretation "key" for categories such as vegetation type and height (Reeves, 1975). An important use of stereo photos in New York is to update the L.U.N.R. map interpretations (see C3 below).

2. Secondary

The U.S.G.S. topographic maps contain a rich spectrum of cultural and natural features. An example is shown in Figure 27 (U.S.G.S., 1972). The user should be cautioned as to the date and accuracy of this information which is noted in the map legend.

In New York State the Department of Transportation has made a statewide update of political and cultural features at the identical U.S.G.S. 7 1/2 minute map series. Maps are available as planimetric or as overprints on the original U.S.G.S. topography from the Department's Map Information Unit in Albany.

3. Tertiary

The New York State L.U.N.R. system is an excellent example of a rich surface feature data source that is increasingly available to the visibility analyst. L.U.N.R. is an automated data bank that was constructed in the late 1960's to provide an information base for multi-purpose local, regional and state planning. 1968 and 1969 air photos

were interpreted for categories of land use and natural resources. The interpretations were manually transcribed to transparent overlays which fit the U.S.G.S. quads. However, visibility and visual character were not one of the system's application objectives.

The L.U.N.R. overlays contain the outlines of photo interpretation for point, linear and aerial information types (see Figure 28) (N.Y.S. Office of Planning Services, 1974). This mapped data is available in print or overlay form at the U.S.G.S. quad sheet scale. Both mapped data and numerical grid data are available to analysts. The former, although dated, continues to represent a major data source for many current impact assessments.

The L.U.N.R. categories mapped were not developed for visual analysis. Thus, there may be a range of visual character types encountered in a single land use type such as single family residential. Study area field checks may be necessary to clarify this situation.

Numerous surface type classifications are developed for national, state, and local planning and project purposes. The advent of a national land use and land cover system keyed to the U.S. Geological Survey base maps will set the framework for future analyses (9 general, 37 specific categories) (U.S. Geological Survey, 1978).

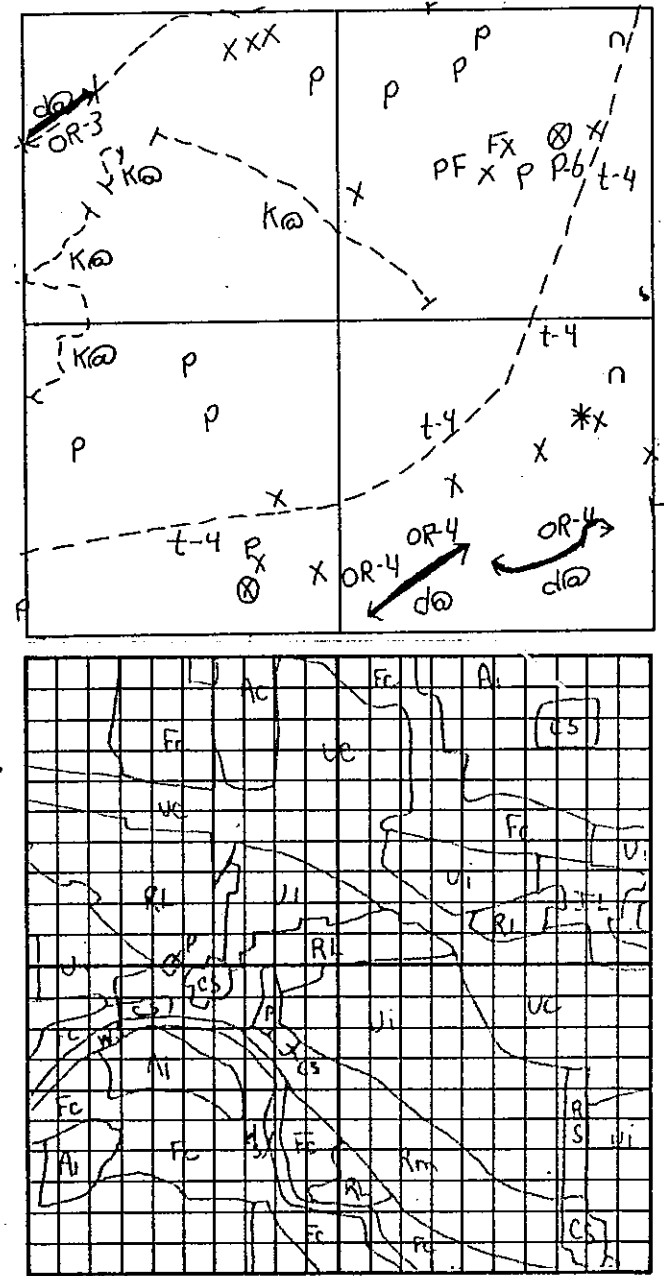

Figure 28: L.U.N.R. - Area and Point Data.

4. Quaternary

The L.U.N.R. system described above was designed to provide fully automated data and analysis assembly. A statewide 1 kilometer square grid system was superimposed on this mapped data and quantitative information was stored for each cell, by area, length, or number (Figure 28).

In contrast, some recent projects have incorporated in a multi-purpose data bank, land use and surface cover categories that are integrally related to scenic analysis. Applied research conducted at the University of Massachusetts (Fabos, 1976) and Harvard (Steinitz, 1978) utilized prior field and photography preference tests in assembling data, and building interpretive models.

The Harvard work is noteworthy in its dynamic synthesis of surface types and viewing distance (see previous discussion Section II-Surface Features). The 267 land use and landscape types which are potentially visible in foreground (200 meters) are aggregated into 30 types in the midground (300 meters +), and 13 groups at "far" distances (Steinitz, 1978, p.29).

D. ATMOSPHERE

This is one of the most complex elements of the visibility model due to the rapid rates of change inherent in climate.

1. Primary

Field observations can be made under varying day/night, and weather conditions to gauge generalized visibility distances associated with a predefined set of significant climatic conditions.

2. Secondary

Charts and tables of solar position can be used to map seasonal, potential sunlight. The U.S. Environmental Protection Agency keeps visibility (haze, smog tables...) information for metropolitan areas and major industrial regions.

3. Tertiary

Weather bureau and airport and coastguard data is highly site-specific. Extreme care should be taken in extrapolation of cloud cover and visibility data to remote sites.

E. OBSERVER TYPE AND QUANTITY

The importance of visual features may vary among observer types. As noted above, the U.S. Forest Service, in its Visual Management System, differentiates between recreation and nonrecreation travellers. The quantity of viewers is used by analysts to select important line-of-sight locations, and to weigh the relative importance of various views.

1. Primary

Field surveys are a frequent method used by recreation and transportation analysts to characterize and quantify user groups. These approaches (surveys, questionnaires...) can be directly applied to visual studies. Most public parks maintain visitor count records. Recreation, (Shafer, 1966), land planning (Zube et al, 1975) and other researchers have developed scenery evaluation approaches which involve direct field (or photo) evaluations.

2. Secondary

Frequent use is made of highway traffic counts to quantify potential numbers of views from the road. This is done by multiplying vehicle counts (such as computed Average Annual Daily Traffic, A.A.D.T.) by a selected occupancy rate, such as 2.5 people per car, and factoring for daylight hours. Such an approach does not deal directly with user types, except where special counts are available. State, county, and some municipal highway departments maintain traffic count data for facilities under their jurisdiction. Where data for precise numbers of travellers is not available or necessary, the Federal Aid Highway Program's Functional Classification System is a useful (and comprehensive) proxy. All routes in the country have been classified for both urban and rural areas (Bureau of Public Roads, 1969). In New York, the State Department of

Transportation has mapped these classifications on the 7 1/2 minute (1" = 2000') planimetric base (Figure 29).

A Federally mandated ^{scenic} highway evaluation was conducted by each state in the early 1970's. (Federal Highway Admin., 1973.) In addition, many counties and municipalities have designed scenic routes. These play an important role in developing impact hierarchies. (Wirth Associates, 1976, p.7-16).

3. Tertiary

For urbanized areas, land use maps, census data, master plans, and zoning may be utilized to approximate existing and future number and type of viewers. Metropolitan transportation studies include industrial and commercial square footage which can be extrapolated to estimate users. This information is, at best, approximate and should be presented with clear explanatory notes. A common problem with quantification of viewer data is the misuse of significant figures, and the lack of provision of an expected statistical range.

4. Quarternary

Land use and transportation computer models are frequently used in simulating future conditions to assist resource managers in decision making. These tools can be adapted to provide gross viewer type and quantity data for a geographic study area such as an urban traffic zone.

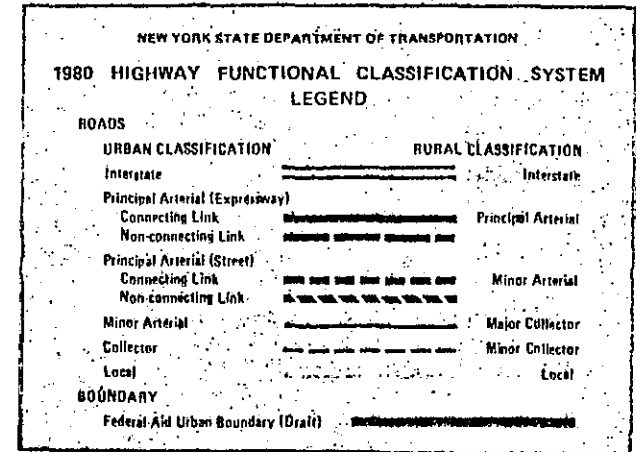
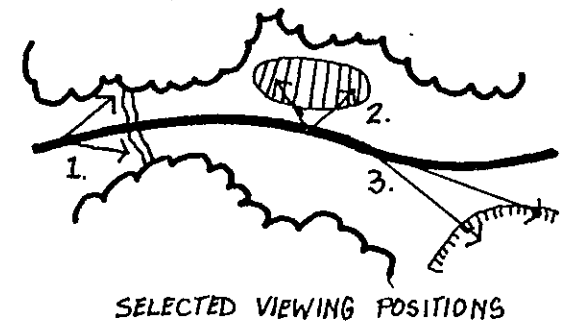

Figure 29: N.Y.S. Functional Highway Classification.

F. OBSERVER POSITION AND MOTION

The selection of a finite number of viewing conditions, from the virtually unlimited number of possible views is a major challenge of study design. Studies may contain important stationary observation points and movement paths, as well as "proxy" positions from scenic elements.

View analysis positions may be functionally selected, regularly spaced, random or continuous (see Figure 30). "Landscape Control Points" (a concept researched by Litton and utilized by Jones and Jones, Zube and others) incorporates a few selected viewing positions which provide spatially extensive, representative views of a variety of landscape types (Litton, 1973). Regularly spaced positions are frequently used in a grid format for computer analysis of areas, and in evenly spaced (distance or time) points along roadway and travel corridors such as scenic rivers. Randomly generated points have been used to assess "typical" views in a landscape for areawide (Boster, 1976,p.92) and roadway contexts (Viohl, 1977) (Figure 30). The approach of "continuous" view positions is often used in the analysis of views along movement paths (Figure 30).



SELECTED VIEWING POSITIONS

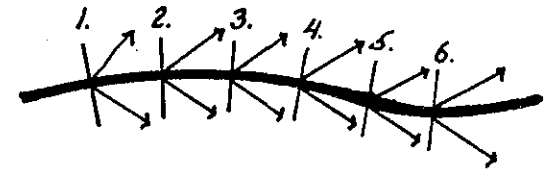

REGULARLY SPACED POSITIONS

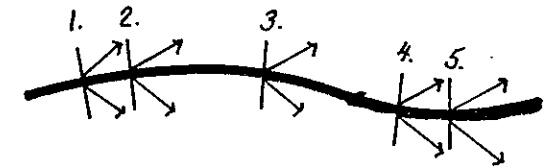

RANDOMLY SPACED POSITIONS



CONTINUOUS POSITIONS

Figure 30: View Position Types.

1. Primary

The selection of visual control points should be made (or confirmed) in the field. Stereo air photos are frequently used with topographic maps to prescreen locations.

2. Secondary

Topographic maps are the usual base for designation of regular, random and continuous positions.

3. Tertiary

These sources are used to supplement topography in selecting control points. Examples include: maps of historic sites and natural features, and maps showing future concentrations of viewer activities, such as a proposed town or park master plan.

4. Quarternary

Data bank models can screen visually sensitive locations. The U.S. Forest Service has utilized its VIEWIT program to identify highly visible project impact locations (Johnson, 1974). Cells with high visibility can be designated as significant viewpoints for subsequent analysis.

G. OBSERVER ENVIRONMENT

The importance of observer environment data is a direct function of the observer positions selected, and the line-of-sight method to be used. For example, if a sensitive site is to be analyzed for views from adjacent public roads then existing roadside conditions are crucial. In contrast, a regional location search for a utility route may omit all observer environment data until narrow study corridors have been designated.

1. Primary

Air photo interpretation with subsequent field analysis is the most accurate means of establishing comprehensive, area wide observer environment conditions. The range of potential diversity is illustrated in Figure 31a (Kunit and Calhoun, 1973, p.110) and Figure 31b (Hornbeck and Okerlund, 1973). Vegetative conditions are temporal, thus often necessitating seasonal (foliate and defoliate) checks (See also Section V).

2. Secondary

U.S.G.S. topographic maps (1" = 2000') are generally unsuitable for accurately establishing local observer-environment conditions. The complexity of local sites including new structures, road signs, individual trees, roadside hedges and walls is not included on these maps. As they become available, new orthophoto maps should provide an excellent base for analysis.

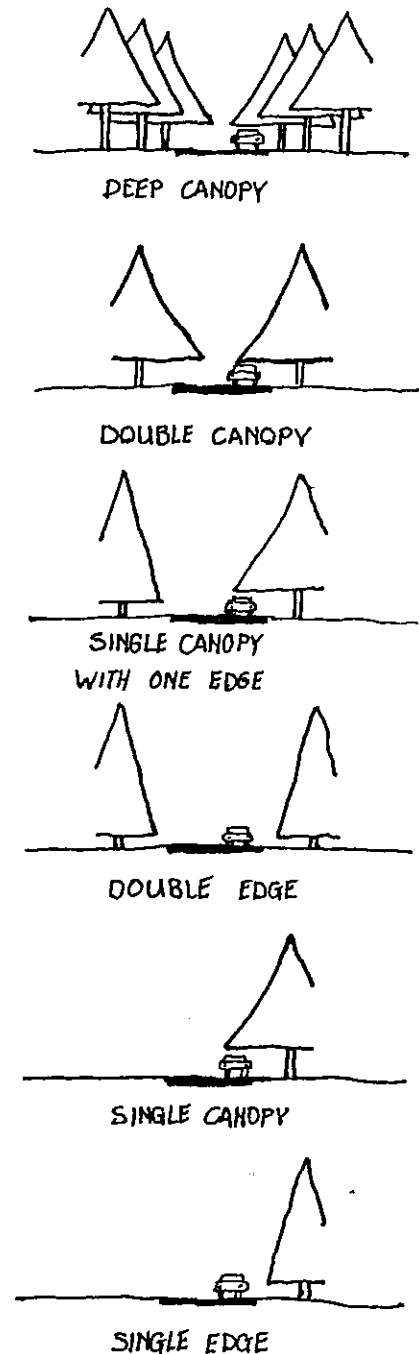

Figure 31a: Observer Environment Conditions.

Complexity of The Visual Field

	Impact	
	Background	Foreground
High Complexity Many and diverse elements widely visible in the cone-of-vision template.	3	2
Medium Complexity Some elements visible in the cone-of-vision template.	2	1
Low Complexity Few elements visible in the cone-of-vision template.	1	0
No Complexity Either completely open or completely enclosed.	0	0

Complexity of The Visual Edge

	Impact	
	Foreground	Background
High Complexity Many types of edge and high complexity of form.	3	2
Medium complexity Some types of edge and some complexity of form.	2	1
Low Complexity Few types of edge and little complexity of form.	1	0
No Complexity No visual edge or completely enclosed.	0	0

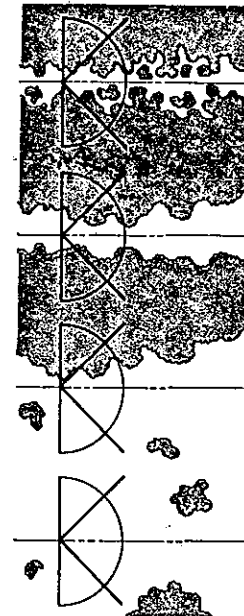
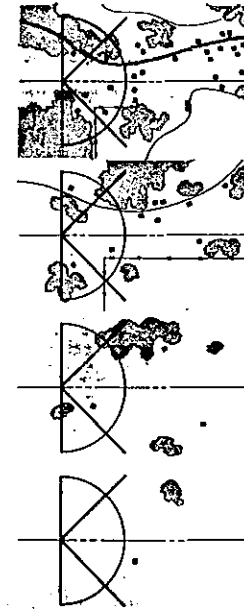

Figure 31b: Complexity of Visual Field and Edge.

3. Tertiary

Some surface condition maps, such as New York's L.U.N.R., were not directly developed for the interpretation of line-of-sight screening and filtering. Care should be taken in their use. Some non-military research has been conducted on visual penetrations of forest types (Way and Knode, 1969) but in general, precise standards for such interpretation do not exist.

4. Quarternary/Pentenary

Due to the typically coarse grain of computer data bases (grid cells 500 feet - 1 kilometer square), precise viewer environment screening/filtering information is generally not available. However, programs such as EDAP (Landscapes Limited, 1973) and OCTVIEW (Steinitz, 1978) can identify the "potential" for such screening. (See Chapter VI.) This potential, if important, could then be clarified using a primary or secondary method.

ENVIRONMENTAL MODEL

		Data Types				
		Primary	Secondary	Tertiary	Digital	
Macro	Landform					
	Surface Cover					
	Atmosphere					
Micro	Viewer Environment					
	Viewer Position/Motion					

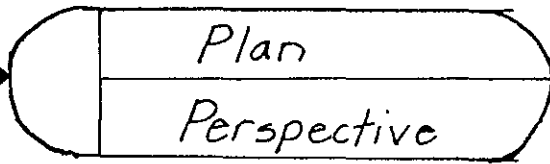
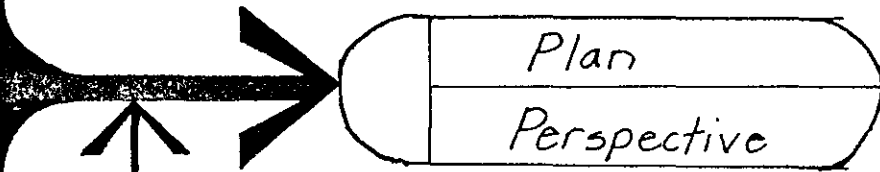

OUTPUT

	Stationary	Moving
Direct		
Physical Analog		
Digital		

SIGHTLINE PROCESSES

IV VIEWBISHED DELINEATION PROCESSES - STATIONARY

IV VIEWSHED DELINEATION PROCESSES - STATIONARY

A. INTRODUCTION

A variety of approaches is available for viewshed mapping and development of perspectives. The analyst must frequently select a related set of methods that most efficiently produce the desired product. Approaches can be grouped into three categories: Direct-field analysis, Physical Analogs - map and photo analysis, and Digital Analogs.

Field analysis approaches utilize actual lines-of-sight, either from selected viewer positions into the landscape, or from a proposed facility location back to potential viewer locations. Air photo and topography methods include intuitive interpretation, topographic cross sections, and three dimensional models. Numerical techniques utilize computer programs to develop interpreted visibility maps and perspective plots of landscape scenes.

Due to the inherent differences between "stationary" and moving visibility, the latter will be dealt with in Section V.

B. DIRECT

A field observer can record limits of visibility directly in the landscape by means of physical signs (flags, etc.). An alternative is to record the view in the field directly onto a map. Litton's comparative work clearly points out the potential inaccuracies inherent in establishing the actual location of view limits. In his study observers tended to map viewsheds to the highpoint of the interposing landforms, not the military crest, thus overestimating visible areas (see Figure 32) (Litton, 1973, p.11). A detailed field study in the Lake Ontario coastal zone revealed mid and background locational accuracy problems in low relief terrain (Fellman, 1979). Extensive field testing in the Netherlands, established that field mapping accuracy was limited to a distance zone of 500-1200 meters within which "space defining elements" (surface, small landforms) can be perceived in stereo (Vander Ham and Iding, 1971).

Innovative applications of field methods have replaced manual records with film media thus permitting subsequent interpretation at another location. Balloons, helicopters, scaffolds and other techniques have also been used to simulate full scale views to and from proposed facilities, such as timber harvest outlines, proposed cooling towers, and micro-wave antennas. (See Figure 33) (U.S. Forest Service, 1972, p.85.)

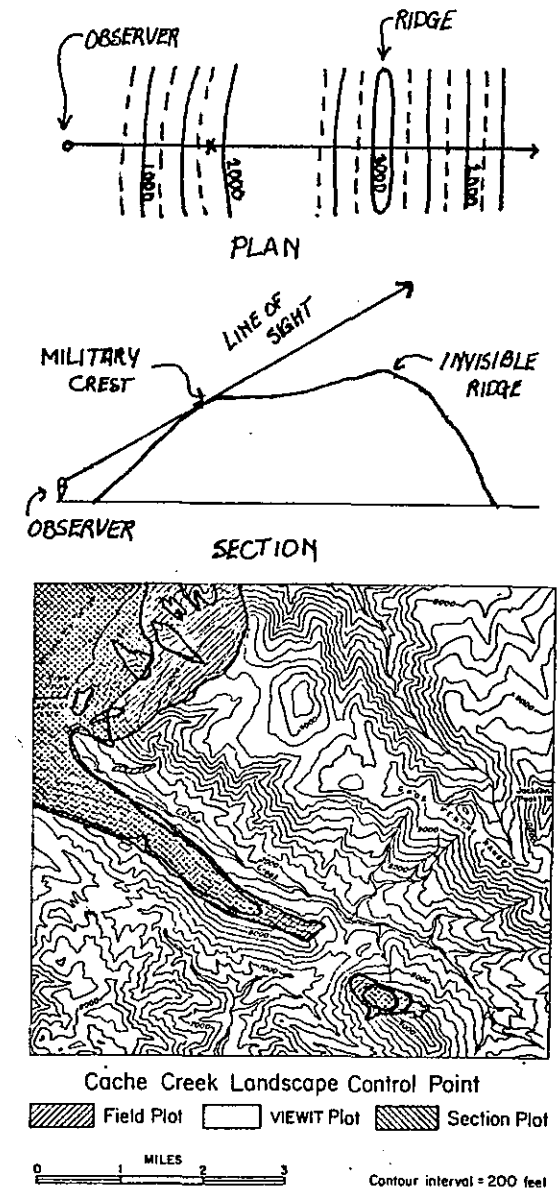

Figure 32: Field Mapping Accuracy.

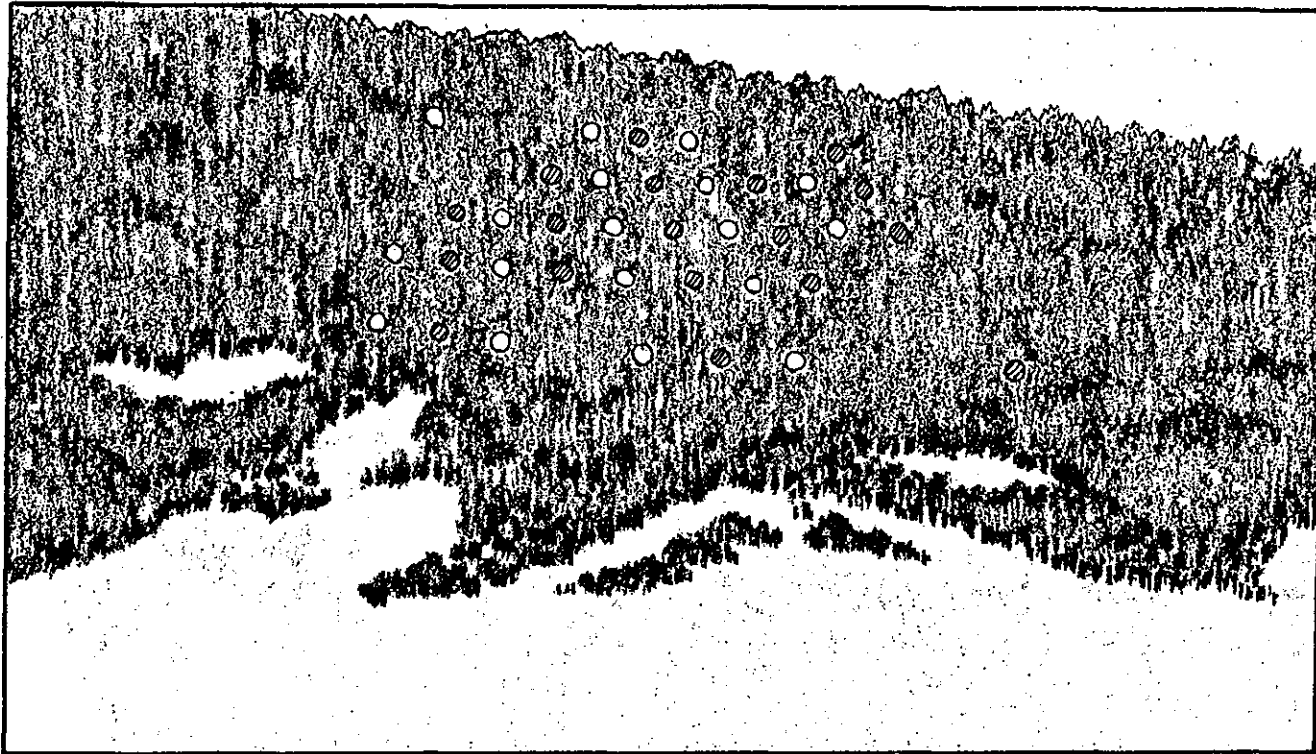
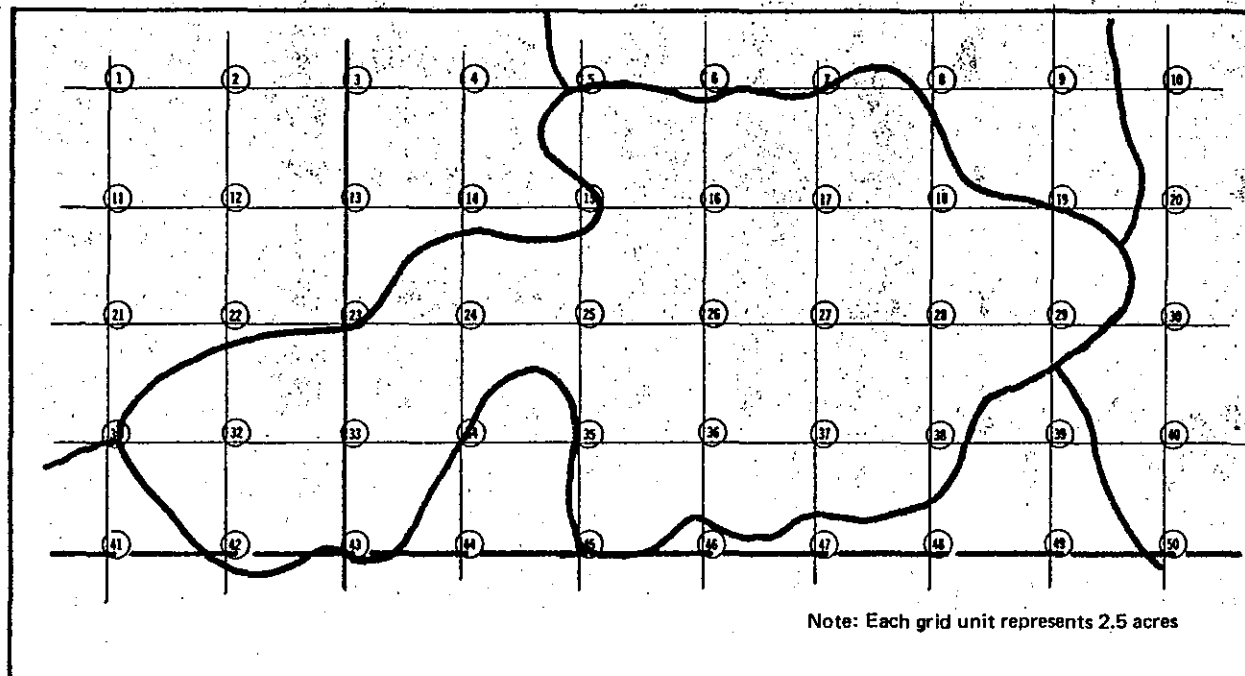

Figure 33: Full Scale
View
Simulation.

View of harvest area showing
balloons tethered at selected
grid points. (Balloon size
greatly exaggerated.)



Partial of harvest area map
showing established grid
system.

C. PHYSICAL ANALOGS

With the advent of accurate topographic maps, a wide variety of offsite interpretation techniques have been developed to delineate viewsheds. The origin of modern visibility analyses can be associated with the French military engineering development of cross sections to ascertain the spatial extent of protection from projectiles that is provided by a fortification. (See Figure 34.) The term "defiled" means:

...to arrange, plan and profile (section) of a fort so that their lines should be protected from...fire"
-Oxford Universal Dictionary

1. Topographic Sections

A cross section is a graphic depiction of the vertical and horizontal relationships of a three dimensional form which occurs along a preselected "cutting plane". For maximum clarity, sections are drawn as viewed perpendicular to the cutting plane. (See Figure 35.)

The French military use of cross sections has a direct analogy to viewshed construction with viewer positions and straight lines-of-sight replacing artillery placements and projectile trajectories. The concept of "military crest" describes positions that provide optimal observation and gun placements to command adjacent valleys (Figures 36) (Greitzer, 1944). These occur on hillsides where a steep slope tapers to a

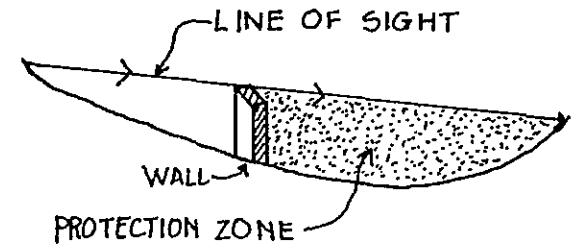

Figure 34: Projectile Trajectory.

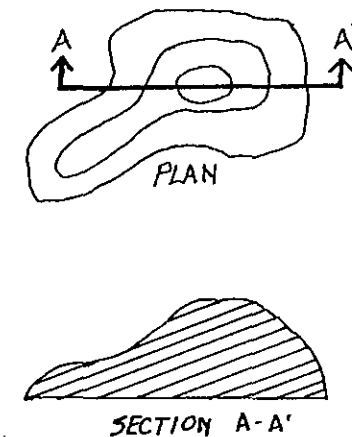

Figure 35: Plan/Section.

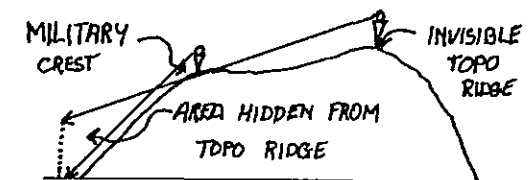

Figure 36: Military Crest.

terrace or crown. In domestic applications such sites are often choice locations for land use activities to make use of a panoramic vista such as residential buildings and roadside rest areas. (See Figure 37) (Hough Stansbury).

A basic training text used in World War II illustrates the analysis steps: topographic plan view, construction of cross sections, location of view limits on sections, transferring of limits to cutting planes in plan view, and interpretive outlining of viewshed. Note, the cross section method includes all possible sight-lines in the vertical cutting plane. Exaggeration of vertical scale, (often up to 10X the horizontal), does not distort the line-of-sight analyses, and is frequently used to enhance the visual interpretation (see Figure 38 a,b,c,) (Greitzer, 1944, p.112).

When conducting a cross section analysis a primary concern is how many sections are necessary. This decision will determine the number of points that are ultimately connected to delineate the viewshed. A standard approach utilizes sections every 10° for the entire 360° potential view cone (Greitzer, 1944). Other project studies have been conducted with even 5° , $7\frac{1}{2}^{\circ}$, 15° , 30° and 45° spacing. An alternative is for the trained analyst to individually select cross section locations based on

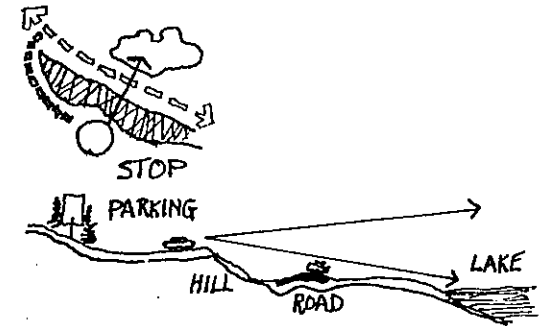
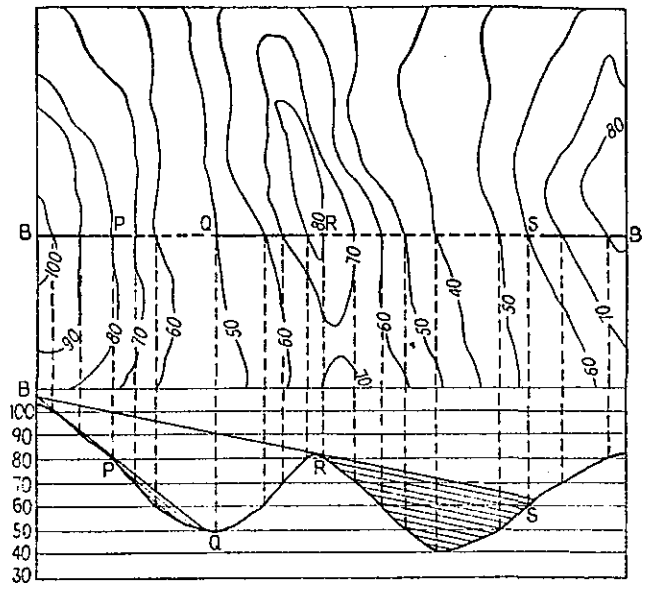
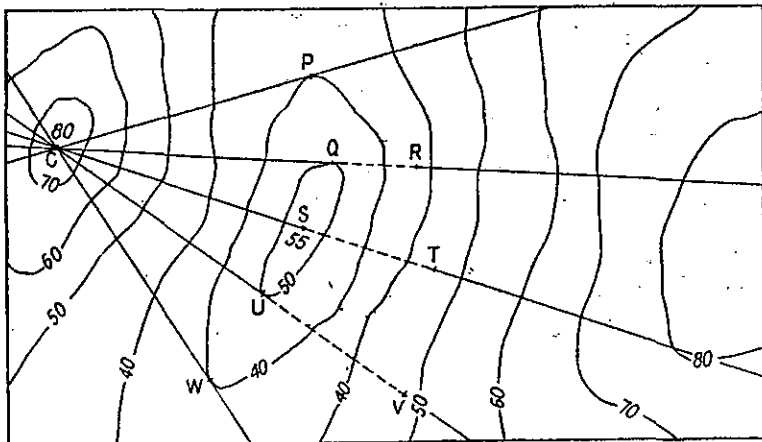

Figure 37: Scenic Overlook.



—Profile and defilade.

Figure 38a,b,c: Viewshed from Sections.



—Finding defiladed areas.

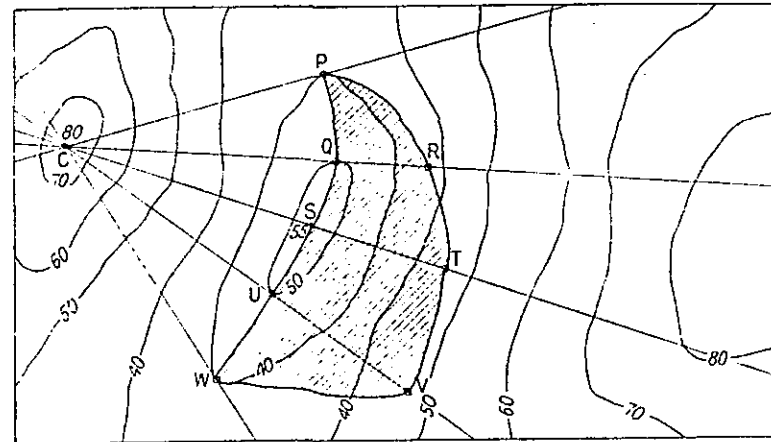

—Visibility diagram.

a review of terrain features (Litton, 1973, p.13). This approach appears to provide reasonable accuracy along with potential reduction of effort, as based on N.Y. Sea Grant test studies (Felleman, 1979).

Line-of-sight cross sections may be adapted to incorporate all elements of the visibility model, including viewer environment, atmosphere, and surface features. This typically entails supplementary data in addition to that normally contained on topographic maps. For example, a field or air photo check of forest height could be used to interpret vegetative mass in the midground cross section.

Detailed cross sections may be subsequently used to construct three dimensional, and block diagram views of the landscape. These are very useful in scenery content evaluation.

If only potential topographic viewsheds are required, the work involved in constructing generalized sections can often be reduced through the simplifying trigonometric principle of "similar" (proportional) triangles. This method examines only the critical limiting line-of-sight in a vertical cutting plane. In the accompanying figure 39, hill B will only be visible if the slope (tangent $a = \frac{Y}{X}$) of the sight line is positively increasing, that is the ratio of

$$\frac{Y_2}{X_2} > \frac{Y_1}{X_1} \quad \text{or} \quad a_2 - a_1 > 0$$

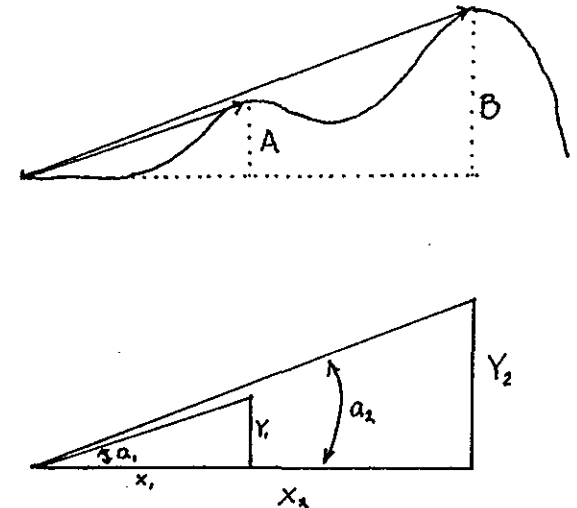

Figure 39: Similar Triangles.

Using this relationship, approximate locus points at the boundary of a viewshed may be rapidly plotted. The U.S. Army used this technique in World War I, both as an algebraic relationship, and as an analog model ("rubberband" proportions). (Pearson, p. 62). Graphical proportions, plotted directly on the topo base map were recently used in a major power plant study (Battelle, 1974). This approach can also be developed into an analog calibrated mechanical jig which is applied to the topographic base.

2. Topographic Models

Scale Models have long served analysts as a means for visualizing three dimensional environments. By cutting layers of material (cardboard, etc....) for each contour, a simple terrain model may be constructed. Vertical exaggeration can enhance visibility analysis as shown in Figure 40 (Salisbury, 1975). More elaborate sculptural techniques are available. Two general methods of simulating sight lines are used: a point light source at the observer or object position(s), and direct viewing of the model through a model scope.

Using a point light source, the bright area delineation is manually transcribed to a topographic basemap. A photograph may be

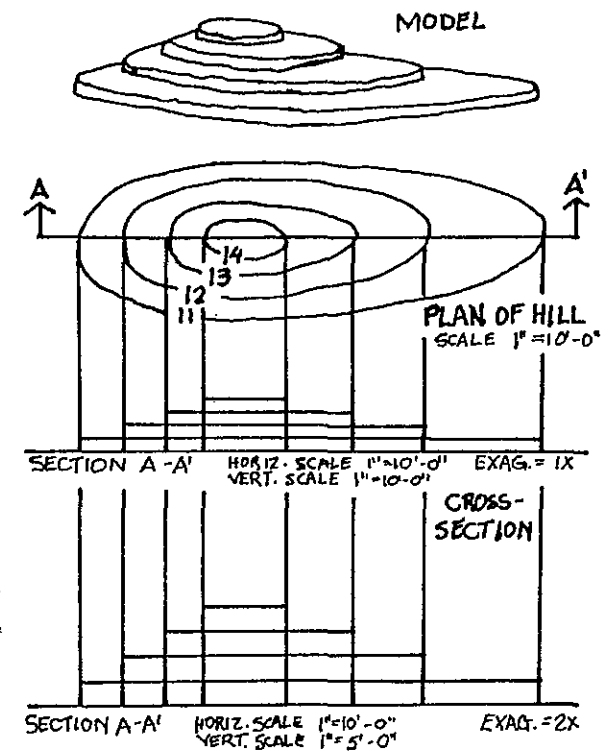

Figure 40: Topographic Model

made of the illuminated model (see Figure 41). Theoretically it would also be possible to coat the model with a light sensitive emulsion and permanently record the visible area(s).

A second approach is the use of a "model scope," a special magnifying periscope which allows the observer (or a camera) to view the model "approximately" as a site visit would permit. A probe is moved through the model tracing the limits of view. Recording of viewshed limits can be done on the model, on an adjacent topographic map, or by photographs taken through the model scope (see Figure 42).

N.Y. Sea Grant research demonstrated that both techniques give quite acceptable results in complex terrain (Felleman, 1979).

One of the most elaborate model simulation studies undertaken has been conducted at the University of California-Berkeley. In addition to topography this model includes scale vegetation, buildings and street furniture. A computer controlled model scope camera is used to simulate movies of auto trips throughout the study area. Psychological tests based on field movies have yielded similar viewer reaction/ results to the simulated trips (Appleyard, et al., 1973).

3. Air Photos

Stereo air photos can be manually interpreted to define landform surface cover, and contours (although optical and automated means are



Figure 41: Illuminated Model.

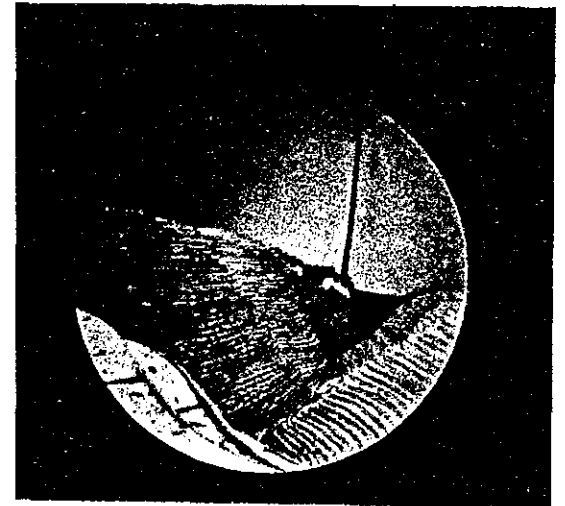

Figure 42: Modelscope Photo.

usually used to photogrammetrically produce accurate maps).

Stereo interpretation is an efficient means of locating scenic vista points (military crest type locations in rugged, and/or unmapped terrain. However, adapting the "floating dot" technique, used to establish contours on a horizontal plane to assess lines-of-sight which are usually at a vertical angle is a complex undertaking. Researchers conducting a forest road study concluded:

To determine whether or not impacts could be seen from a roadway, a "floating line" technique (same principle as the "floating dot" technique described in most elementary aerial photogrammetry texts) was tried on stereo paired photographs...this was found too time consuming...especially when the floating stereo line crosses more than one stereo pair (Potter and Wagar).

Analysts did find that this approach was useful in "checking" local viewer environment with 1:24,000 scale photos, and in large scale preliminary mapping with 1:250,000 scale imagery for their study area in the Pacific Northwest.

4. Inspection

Often in the initial stage of viewshed mapping, it is necessary to roughly estimate the potential viewshed in order to efficiently select and utilize viewer positions and alternative line-of-sight techniques. It is common for a trained professional or technician to

use stereo photos and topo maps in an informal manner to rapidly develop an approximate viewshed map and identify locations where a more detailed approach is needed

D. DIGITAL ANALOGS

With the recent advent of readily available computer hardware and software, many rapid developments are taking place in the area of digital terrain models, of which visibility is one topical area (American Society of Photogrammetry, 1978). The following is a brief highlighting of the basic concepts of automated simulation.

A widely diverse group of problem solvers are concerned with utilizing computer analyses of three dimensional forms. For example, space scientists simulate complex rocket and satellite docking maneuvers, highway designers "test drive" a proposed road to check for unsafe visibility conditions, while architectural engineers design complex structural framing systems.

As described above (II Data Assembly-Landform Quarternary), many digital line-of-sight programs utilize a matrix of elevations. These programs are generally known as "hidden line" algorithms (Newman, Sproull, 1973, Ch.14).

1. Sight Lines

Generalizing, these programs efficiently compute, compare and store results of the visibility proportion (see Figure 39) between a designated viewer (or object) position and all "relevant" terrain grid points. In a large data base, the number of calculations and store requirements are significant enough to effect cost and hardware storage capabilities, particularly for mini or micro computers.

One aspect of this problem, sight lines without intermediate points, is illustrated in Figure 43. A rigorous solution would entail interpolating between D and E to find elevation X, and then using the sight line proportion to ascertain the visibility of H.

Numerous linear programming approaches have been developed to efficiently "scan" the terrain, and sequence the equations and temporary storage (Travis, et al., 1975; Tucker, 1976; Steinitz, 1978; Tomlin, 1978). Of particular interest are the questions of critical sight lines, and maximum view distances.

The programs are typically only capable of analyzing cells, thus the maximum density of analytical coverage is a function of the cell size. Note there is an inverse relationship between plan view and perspective area in view cone distance zones (see Figure 44) (Landscape

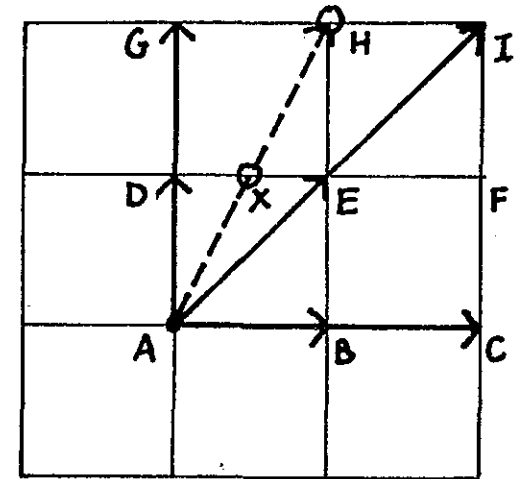

Figure 43: Intermediate Sightline Points.

EFFECTS OF DISTANCE

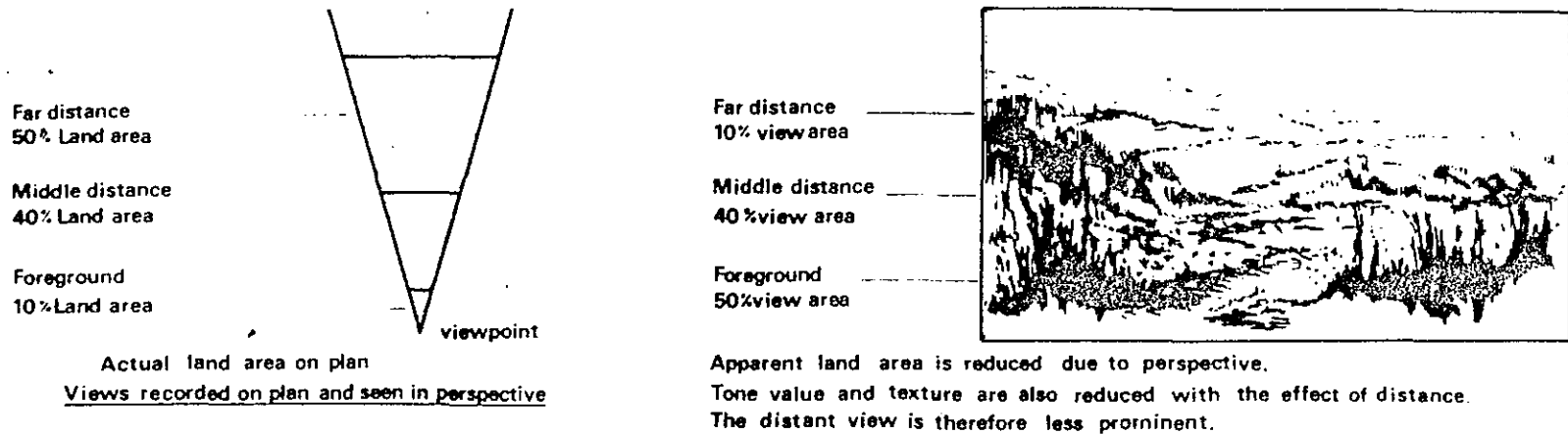

Figure 44: Effects of Distance.

Evaluation Research Project, 1976).

One interesting approach to reducing computations is to limit sight line directions by selectively eliminating intermediate points—such as "X" illustrated in Figure 45. This approach includes all cells adjacent to the viewer position, and a "sample" whose user-selected density decreases as distance increases (see Figure 45) (Steinitz and Paulson, 1975, p.184).

```

000000000000000000000000000000000000000000000000000000000000000000000000000000000000000000000000000000000
000000000111111111222222222233333333344444444445555
12345678901234567890123456789012345678901234567890123

```

```

005
052
051
050
049
048
047
046
045
044
043
042
041
040
039
038
037
036
035
034
033
032
031
030
029
028
027
026
025
024
023
022
021
020
019
018
017
016
015
014
013
012
011
010
009
008
007
006
005
004
003
002
001

```

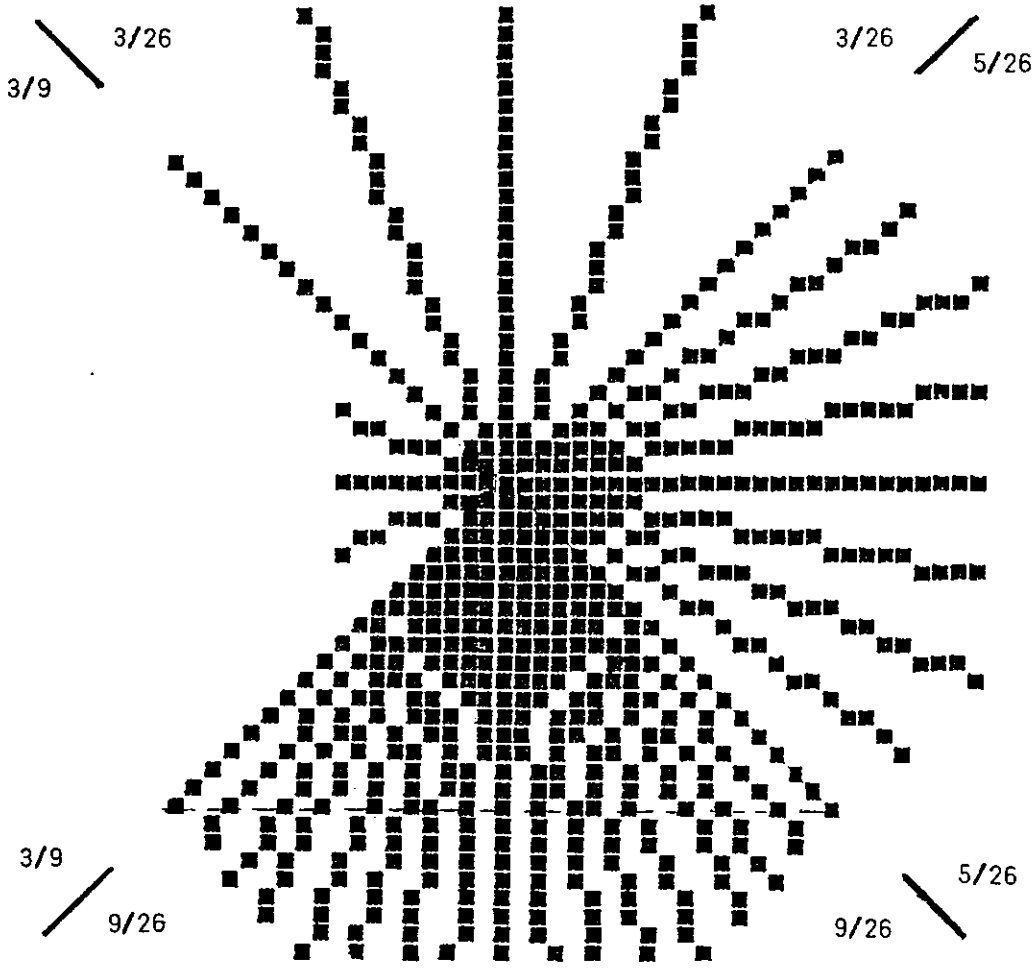

```

005
052
051
050
049
048
047
046
045
044
043
042
041
040
039
038
037
036
035
034
033
032
031
030
029
028
027
026
025
024
023
022
021
020
019
018
017
016
015
014
013
012
011
010
009
008
007
006
005
004
003
002
001

```

```

000000000000000000000000000000000000000000000000000000000000000000000000000000000000000000000000000000000
000000000111111111222222222233333333344444444445555
12345678901234567890123456789012345678901234567890123

```

LEGEND: X/Y
 X = Rays per Octant
 Y = Length of Ray

Figure 4

Figure 45: Selected View Lines.

2. Sight Distance

A common method (both computer and manual) of limiting analysis is to place a maximum effective length on sight lines. This decision can either be based on the length of views that typically occur in a landscape, or the threshold cognition distance associated with a project scale.

In low relief or high local enclosure environments the potential for distance views is slight. Dutch (Vander Ham and Iding, 1971) and British studies indicated that many analyses could take place within a 1 kilometer cell (see Figure 46) (Landscape Evaluation Research Project, 1976, p.84).

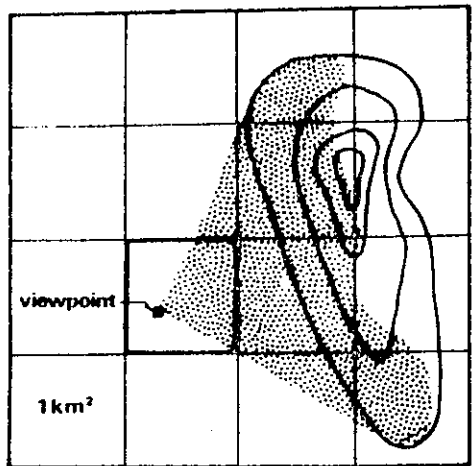

① Area seen outside the grid square can be greater than that seen within it.

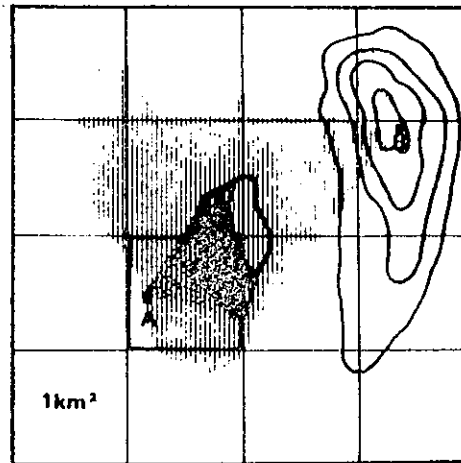

② Area of the grid seen from within (from point A) may be less than that seen from outside the square (from point B).

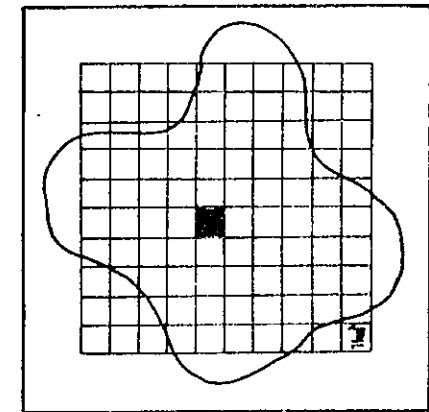

③ The maximum extent of vision has an irregular boundary which can cover many adjacent grid squares

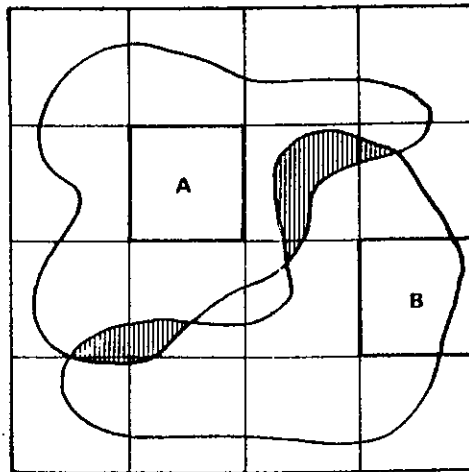

④ The extent of vision can overlap for views from two squares, A & B

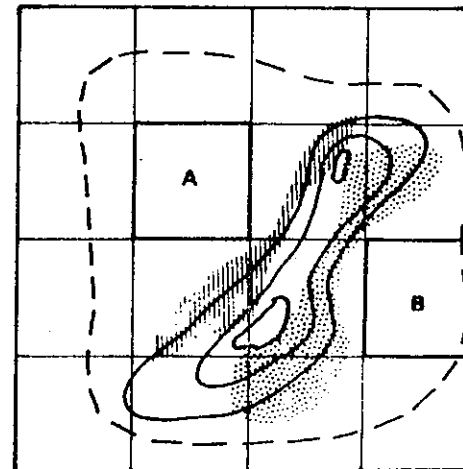

⑤ The areas of dead ground within a common field of vision from two squares will be different
 ■ Dead ground from A visible from B.
 ■ Dead ground from B visible from A.

Figure 46: Extent of Views.

Transmission line studies, both manual and computer, have related structure size to significant view distance. In the Adirondacks a hierarchy of roadway distance zones was established (see Figure 47) (BHI, 1975, p. 30). In a low relief prairie landscape, view searches were limited to adjacent 1/4 km cells (Landscapes Limited, 1973); while in the northwest a maximum of 6-10 miles has been used (Jones and Jones, 1976, p.84).

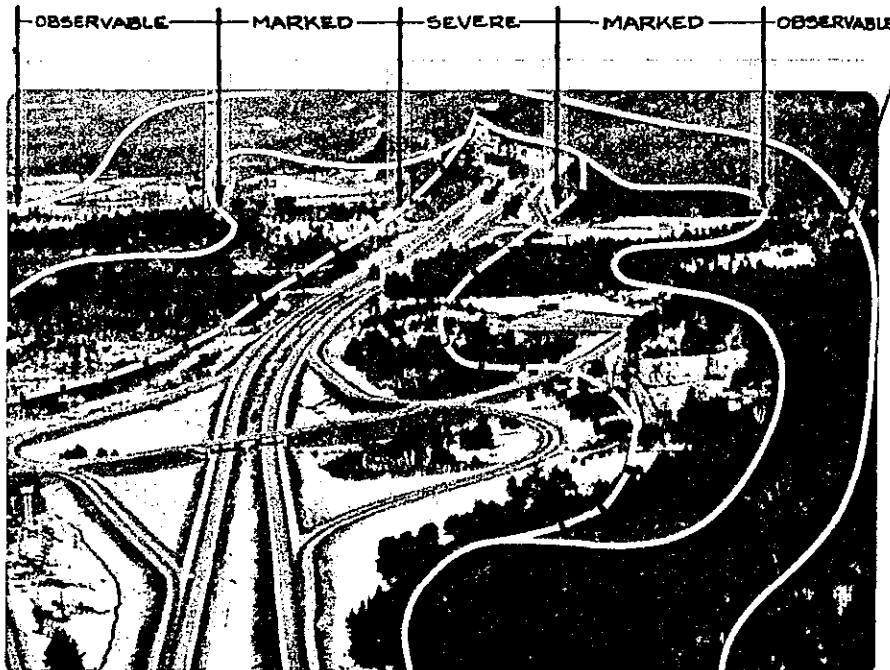

Figure 47: Roadway Distance Zones.

Impact reports have related the angular size of proposed objects in the visible field to minimum cognition (and impact) levels, thus establishing maximum analysis distances. In a land-based study, 10° was used for both horizontal and vertical viewing angles (see Figure 48) (Steinitz, Rogers Assocs., 1977, p.218). For a pioneering water-based study, 10° was used for a horizontal threshold and 5° for a vertical threshold (see Figure 49) (Roy Mann Assocs., Inc., July, 1975b, p.294). This latter approach is consistent with psychological studies which have shown our increased perceptual sensitivity to vertical objects placed in horizontal fields.

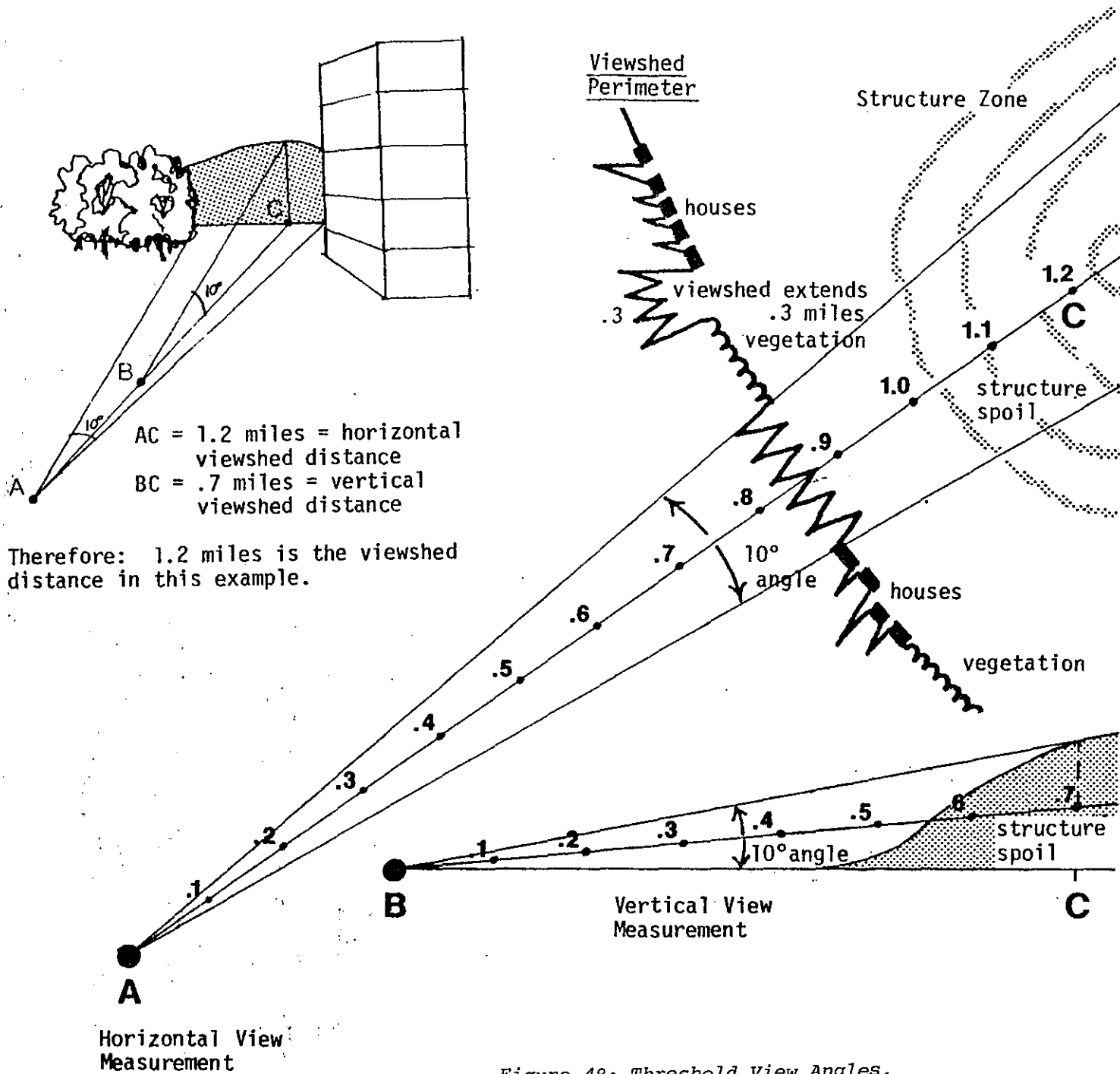

Figure 48: Threshold View Angles.

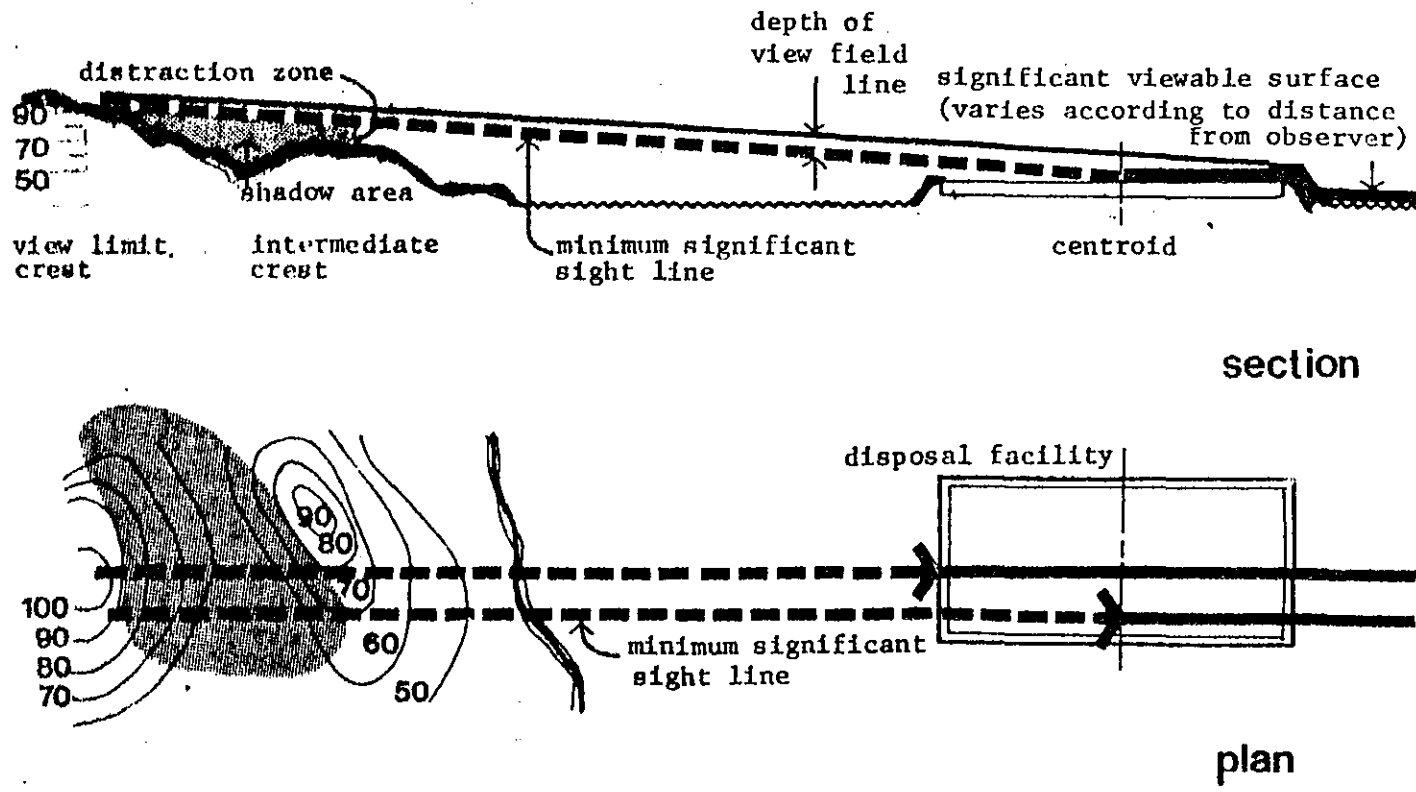

Figure 49: Water Based View Angles.

3. Lines and Surfaces

Computer graphic systems can process points, lines, and areas. The above described search and comparison method results in the identification of visible or non-visible points. Three dimensional warped grid drawings, such as shown in Figure 50, incorporate a hidden line algorithm where each pair of adjacent points is checked. In the PREVIEW output

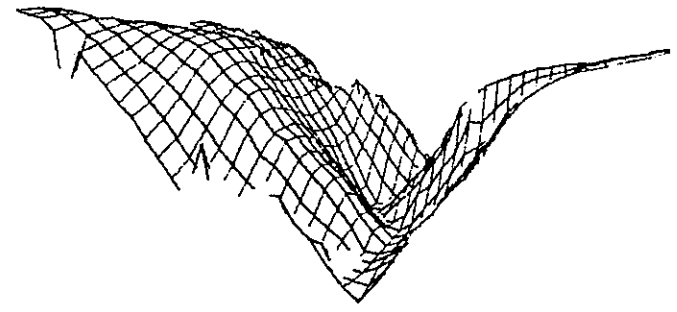

Figure 50: PREVIEW Terrain Plot.

three conditions are processed: both points visible-plot line, one point visible-plot 1/3 of line from visible point, both points hidden-no plot (Myklestad and Wagar, 1975).

A more comprehensive approach than lines is surface facets. The widely used VIEWIT program associates a single elevation for each input grid cell. A wide range of internally generated (pentenary) data can be developed including slope, and aspect. These are computed by "fitting" a plane through the eight adjacent cells (see Figure 51) (Travis, et al., 1975, p.12).

The "Z angle" subroutine enables the user to specify a minimum vertical angle with horizon "below which it is assumed the observer cannot see" (Travis, et al., 1975, p.10). Using the "ASPECT WEIGHTING" subroutine analysts can differentiate 10 different ranges of cell aspect relative to observer position based on visible size area of seen surface. This technique is particularly significant in identifying "visible" areas with low surface content information (see Figure 52) (Travis, et al, 1975, p.16).

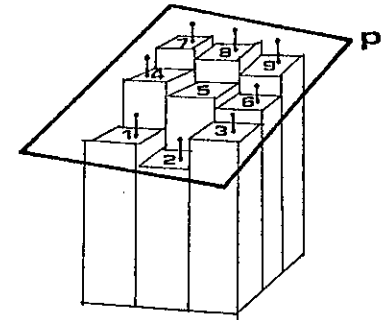

Figure 51: Slope Fitting.

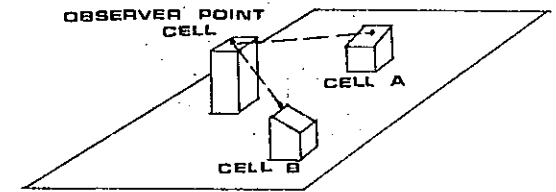
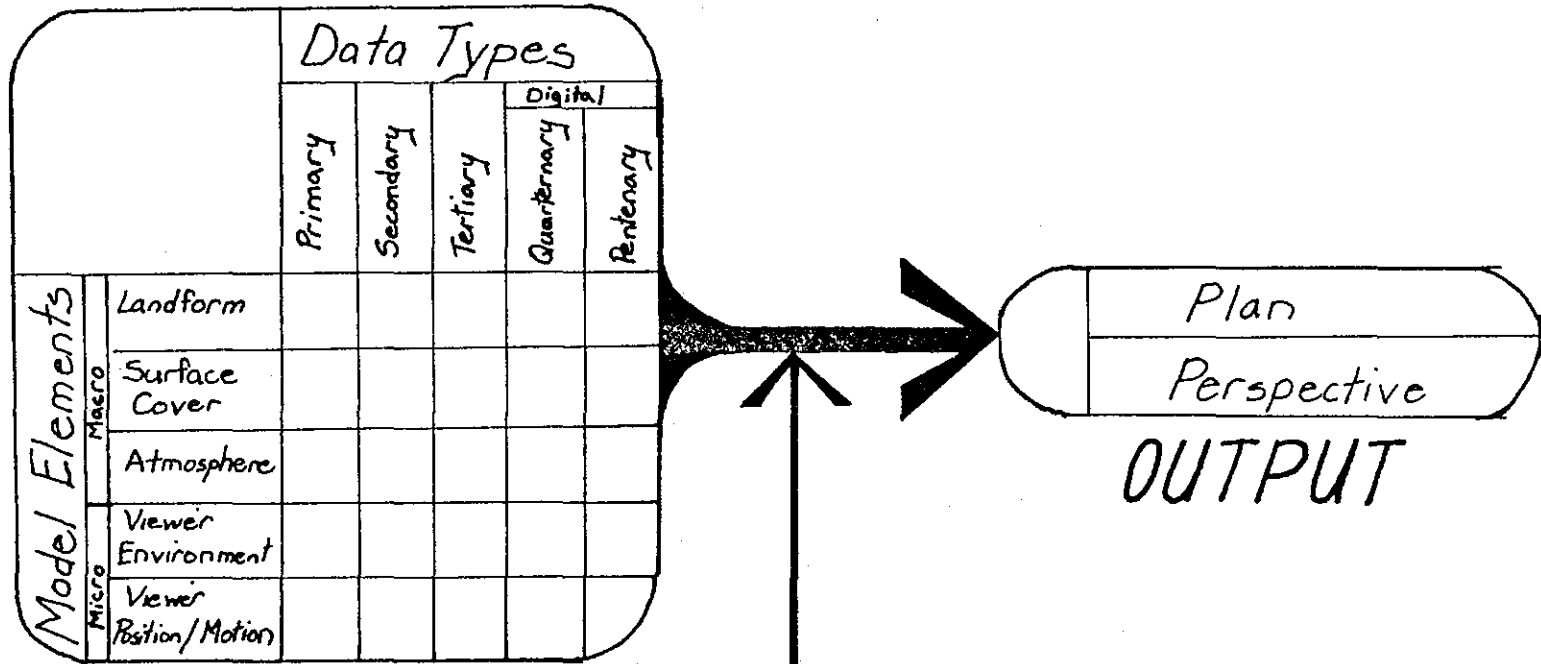

Figure 52: Relative Aspect.

ENVIRONMENTAL MODEL



	Stationary	Moving
Direct		
Physical Analog		
Digital		

SIGHTLINE PROCESSES

V VIEWSHED DELINEATION
 V PROCESSES - MOVING

V VIEWSHED DELINEATION PROCESSES - MOVING

In reality, all viewing is done by a moving sensory system as we constantly scan the environment with our eyes. Head and body activity increases the complexity of analyzing actual viewer behavior. It is generally accepted that pedestrian activities can be approximated by one or a set of stationary view points with a 360° viewing potential. At the other extreme, years of driver behavior research has established that viewing is limited and focused for drivers at moderate and high speeds. Additional research remains to be done before we fully understand viewing phenomena at slow speed such as bicycles, urban traffic, boats, as well as for vehicular passengers at high speeds.

A. VIEW CONE

The "view cone" concept states that as speed increases:

1. The focal point moves away from the viewer; and
2. The effective cone of detailed vision narrows.

This is shown in Figure 53 (U.S. Forest Service, 1972, p.112).

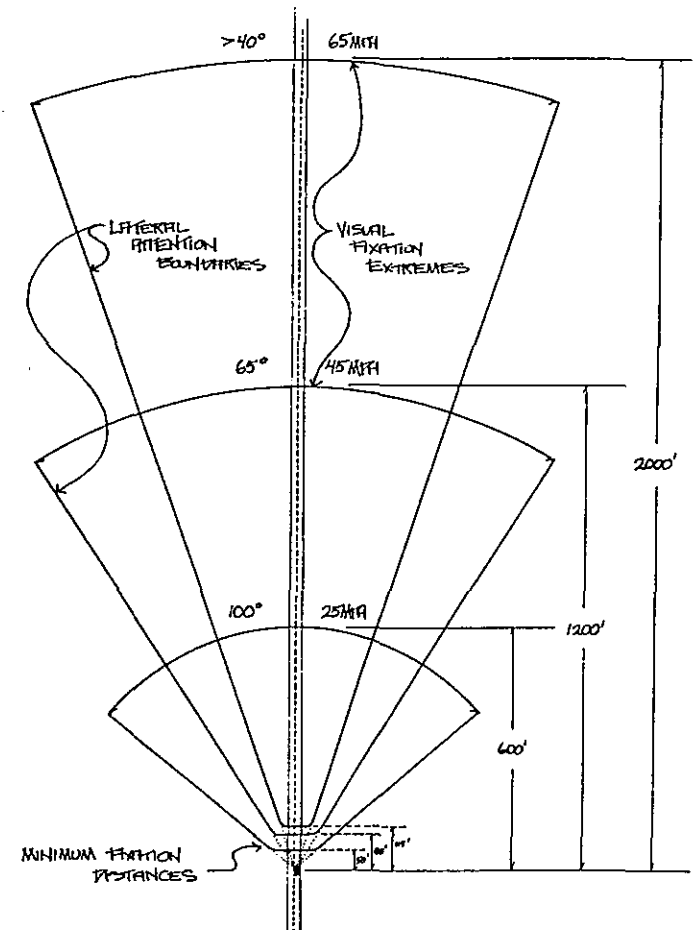

Figure 53: Driver View Cones.

Each of the stationary line-of-sight methods discussed in Section IV is applicable to the analysis of movement paths. A basic study design decision is to either approximate a continuous experience by means of a series of stationary points, or to attempt to directly assess a "continuous" experience. (See Figure 30.) Often a combination is desirable.

Theories of spacing can be related to types of scenery, overlapping views, and speed of viewer. A study on Cape Cod incorporated stationary positions every 0.25 miles (Hornbeck and Okerlund, 1973). A manually conducted scenic river study used cross sections every 0.1 mile (Pitz, 1977, p.84), while a computer based river study used 450 points in 149 miles of river at major changes of river direction and side valley slope and at intermediate locations (VanDyke, 1978, p.13). A northwestern forest road study utilized evenly spaced points 0.2 miles apart. In testing a field photography technique with four photographs (77°) approximating a 360° panorama, they computed that 1.4 acres were not "observed" between any two points (Potter and Wagar). The photos were interpreted in the office to establish the viewshed on a topographic base.

Views from the road are critical in the "Landscape Control Point" method (Litton, 1973). These were preselected at uneven intervals. As input to a scenic quality analysis for Jamaica Bay, random numbers were used to select viewing locations and directions along routes in a waterfront study area. The resultant views were "representations" of the auto experience (Viohl, 1977, p.46).

In the Hornbeck study noted above, a weighted cone-of-vision template was used to identify the driver's central focal area (Hornbeck, 1973, p.115). The template, reproduced in Figure 54, is placed at preselected analysis points on the centerline and the view cone is transferred to a base map. This is repeated for both directions of travel. A stationary line-of-sight technique such as cross sections may be applied within the view cone area.

Computer techniques such as VIEWIT can generate a composite "number of times seen" map which depicts the cumulative viewsheds from a series of points selected along a route. The cone of vision and maximum sight line distance may be specified for each point. (See Figure 55) (Travis, et al., 1975, p.29.)

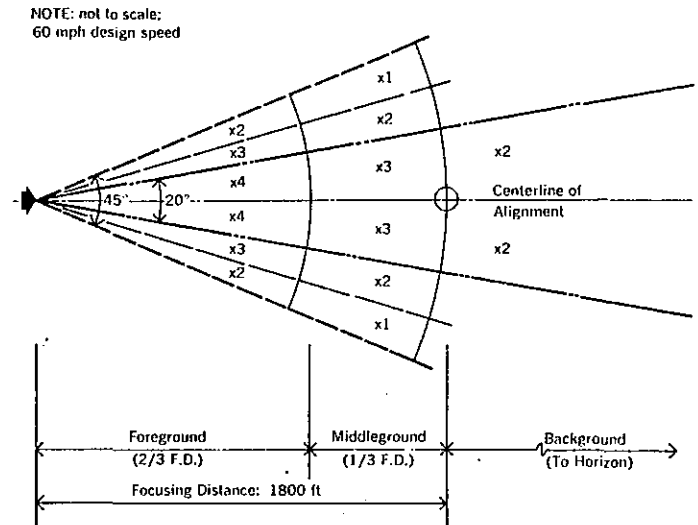
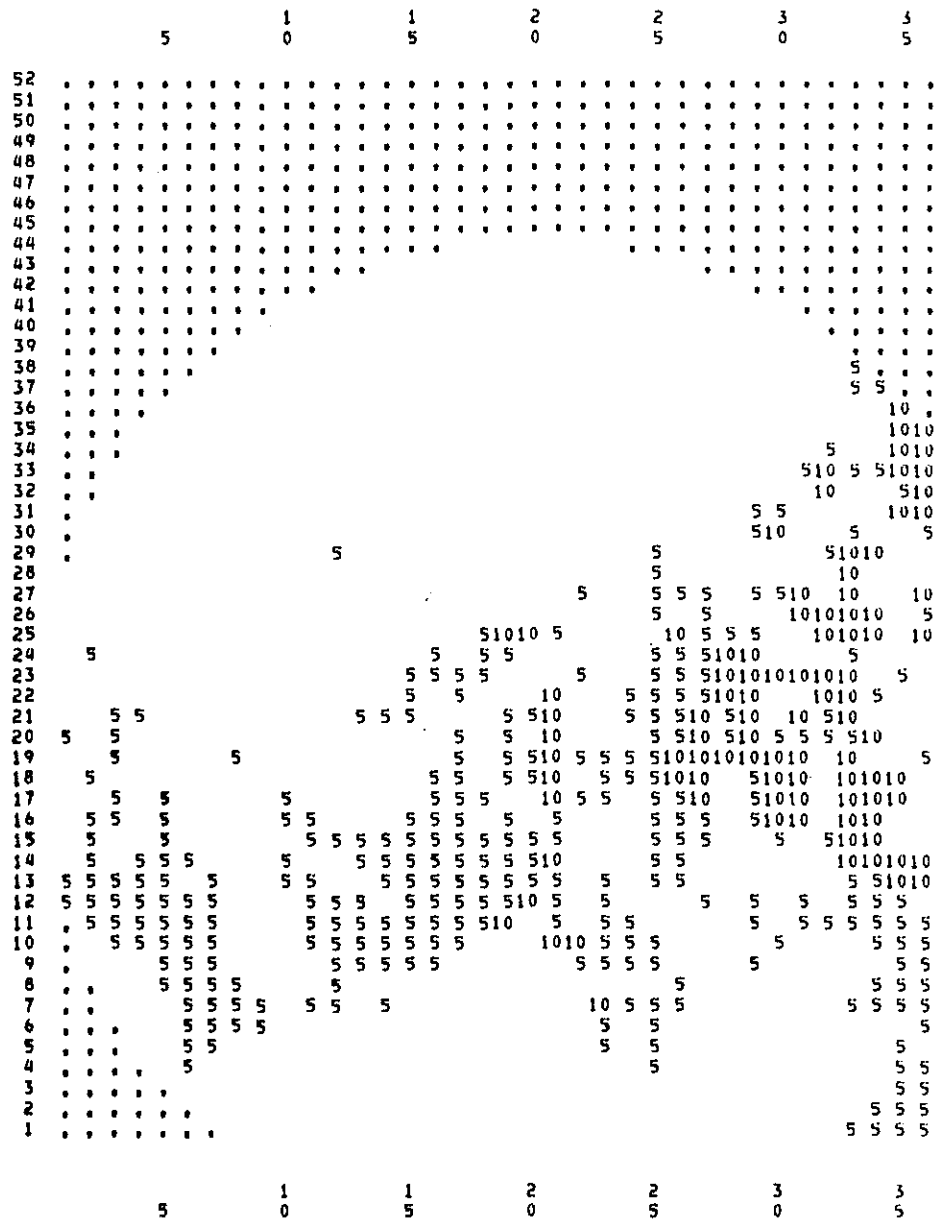

Figure 54: Weighted View Cone.

Figure 55: Times Seen Map.



B. CONTINUOUS ANALYSIS

A standard approach for establishing "view from the road" is to field record on a base map while driving the designated routes. A comprehensive procedure for this method, developed in the Sea Grant research is shown in Figure 56. Office preparation included enhancement of base maps, development of a set of symbols to be used in the field, and the Hornbeck view cone technique (see Figure 31), applied continuously. Each road was driven three times by a two-person team (driver and recorder). The first time was for orientation (exact observer location is a difficult problem) and to check the preliminary view cone viewshed. Then the route was driven once in each direction at a moderate speed, approximately $2/3$ the posted speed limit. The recorder plots view focused on near shoulder (note: this gives a slightly wider view cone than from driver position). Where deciduous vegetation was a significant viewer environment and mid-ground feature, the field work was repeated for foliate and defoliate seasonal conditions. (note: a $1'' = 1000'$ base map scale was found to be more suitable than $1'' = 2000'$ U.S.G.S. maps). Limits of views were plotted for fore and midground. Where background views occurred, topographic cross sections were used to delineate visibility limits.

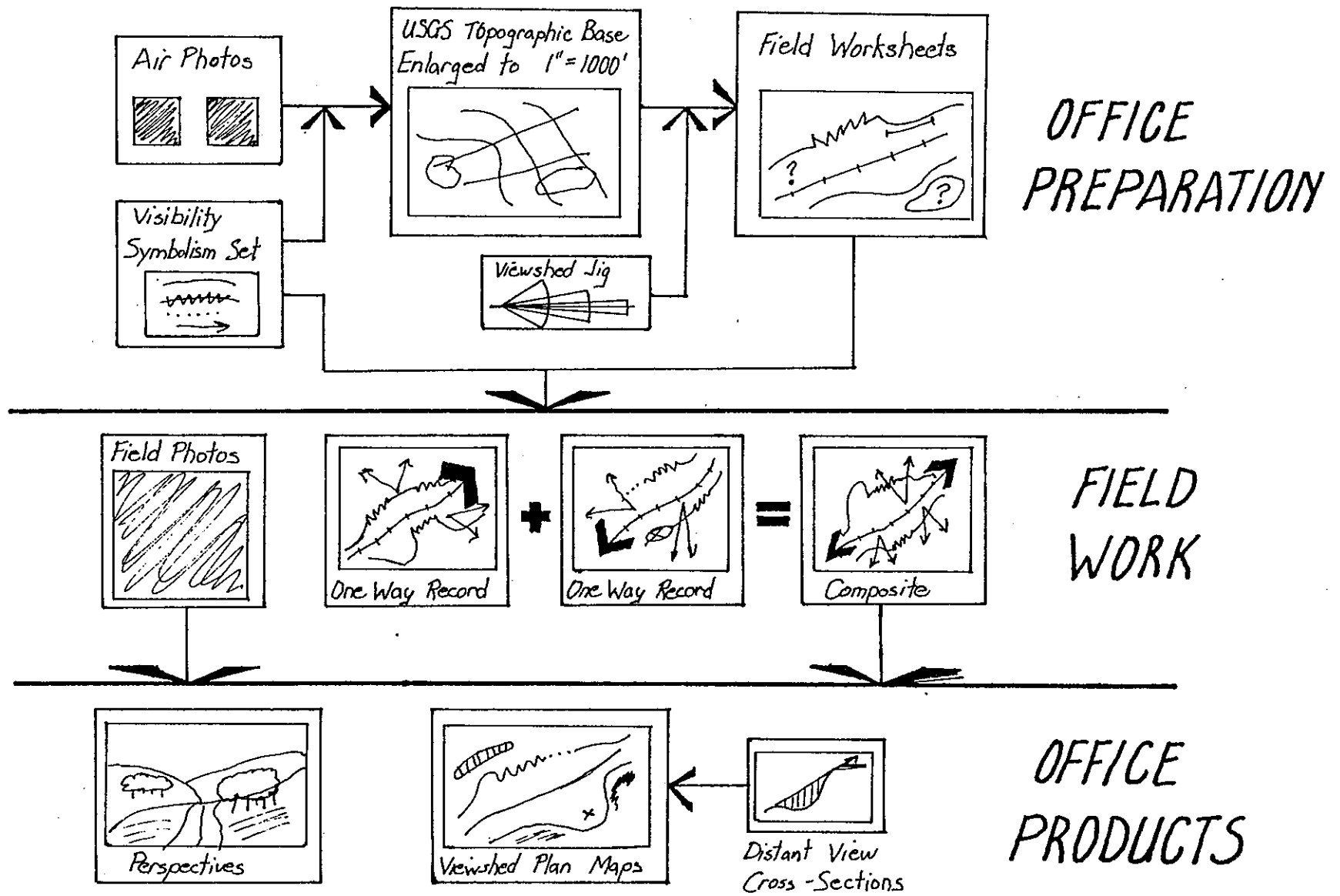

Figure 56: Continuous Road View Methodology.

A variation on this approach would be to video record the trips and then analyze their content. State highway departments are developing photo logs of their entire system for management programs (see Figure 57) (Kunit and Calhoun, 1975, p.81). Other continuous methods include model simulations using motor driven model scope cameras (Appleyard, et al., 1973); and computer based animation. The latter are of growing importance in highway safety design.

Examples of visibility from moving positions are shown in Figures 58 (Litton, 1968, p.51) and 59 (Wirth, 1976, p.SVII-12) and Appendix A.

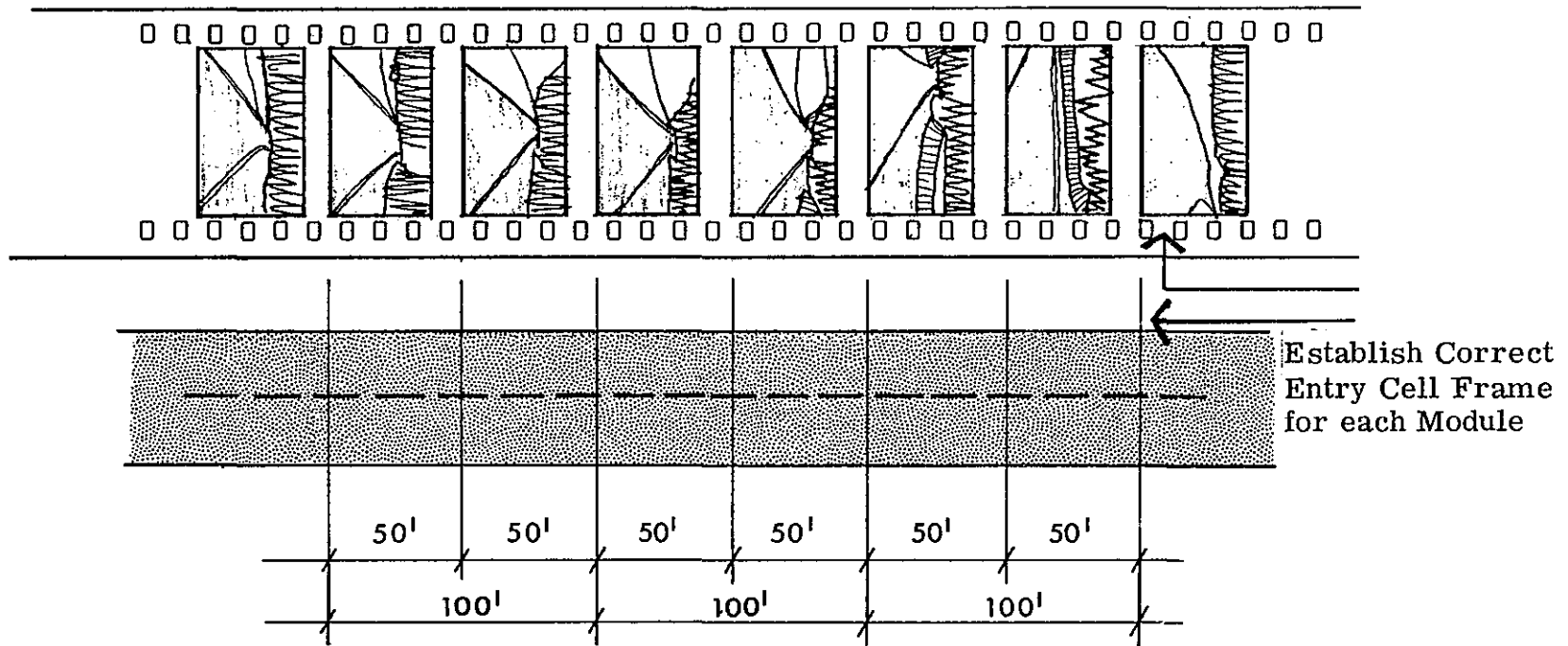

Figure 57: Highway Filmstrip.

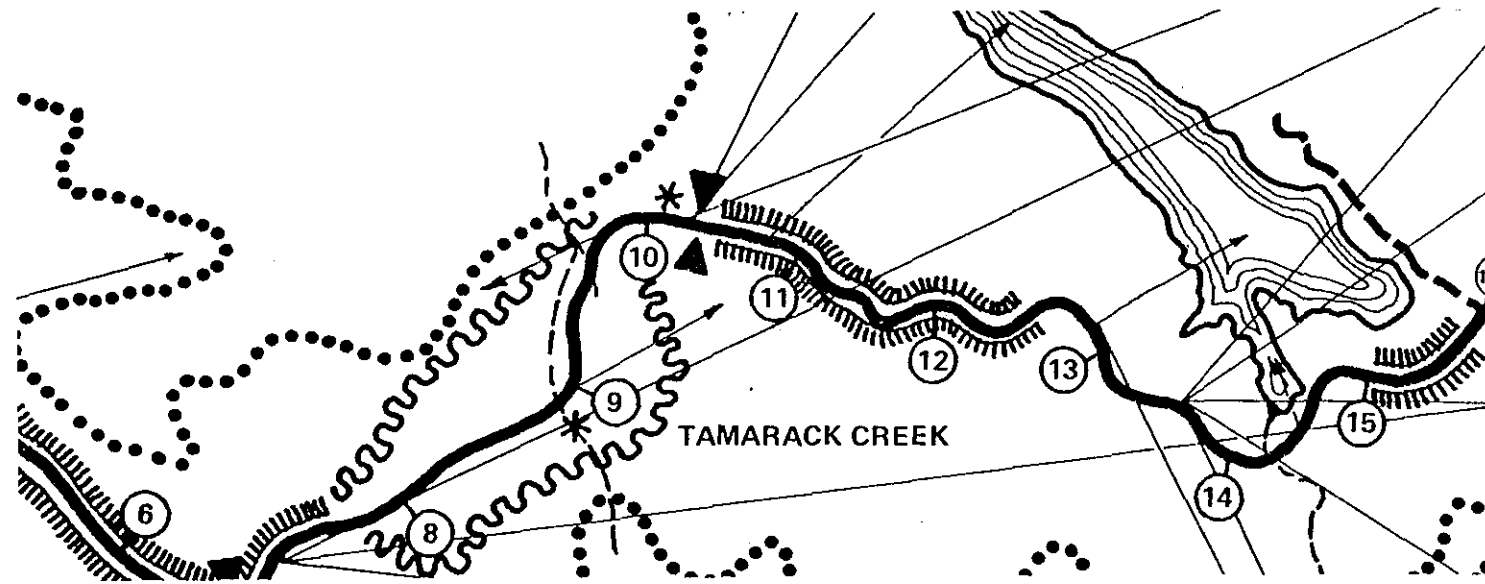
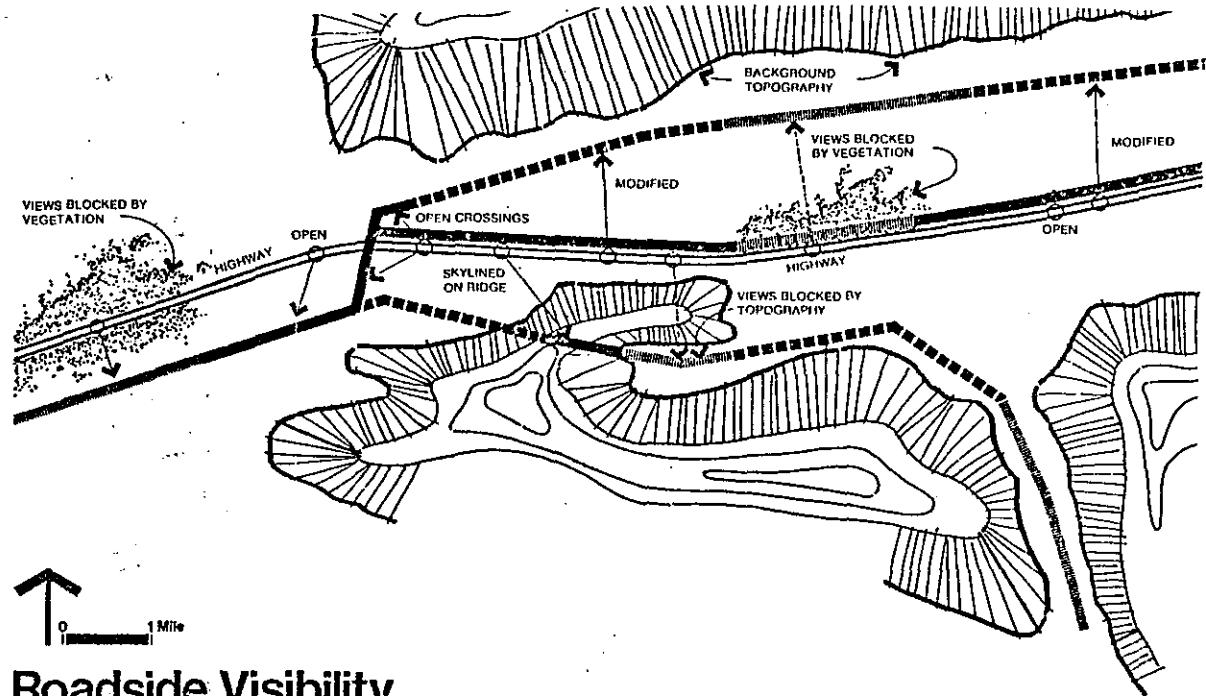

Figure 58: Roadway
Visibility.

Figure 59: Roadside
Visibility.



Roadside Visibility

- OPEN** - TRANSMISSION LINE WOULD BE SKYLIGHTED DUE TO LACK OF TOPOGRAPHIC BACKGROUND INFLUENCE OR RIDGE LOCATIONS.
- MODIFIED** - VISIBILITY OF LINE WOULD BE MODIFIED FROM HIGHWAY DUE TO TOPOGRAPHIC BACKGROUND AND A DISTANCE OF OVER 1/4 MILE FROM HIGHWAY.
- NONVISIBLE** - VIEWS TO TRANSMISSION LINE WOULD BE BLOCKED BY TOPOGRAPHY OR VEGETATION.

ENVIRONMENTAL MODEL

		Data Types				
		Primary	Secondary	Tertiary	Digital	
					Quaternary	Penultimate
Model Elements Macro	Landform					
	Surface Cover					
	Atmosphere					
Model Elements Micro	Viewer Environment					
	Viewer Position/Motion					

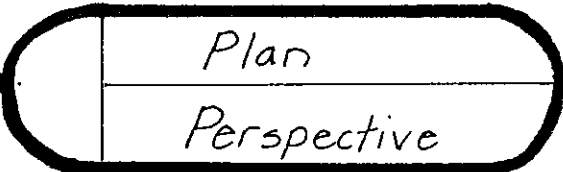
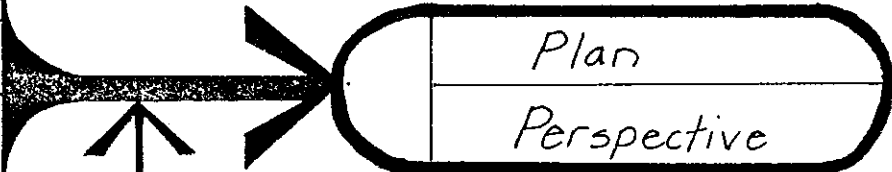

OUTPUT

	Stationary	Moving
Direct		
Physical Analog		
Digital		

SIGHTLINE PROCESSES

VI OUTPUT - PLAN VIEWS AND PERSPECTIVES

VII OUTPUT - PLAN VIEWS AND PERSPECTIVES

A. INTRODUCTION

Visibility analyses are undertaken to provide information for subsequent incorporation in other studies such as planning and design. A wide variety of visibility outputs may be developed, with the great majority being planview or perspective format. Each line-of-sight approach leads to unique output formats.

B. DIRECT

1. Plan View

Plan view visibility may be field estimated and sketched directly on a topographic map or air photo. This is particularly effective for small sites (see Figures 60,61) (Steinitz Rogers Assoc., 1977, p.4.8, 4.9). In some cases, no map (plan) record is necessary. Examples of the latter include the staking of a building site with a commanding view or the marking of trees to be cleared along a forested lakeside edge to establish water views.

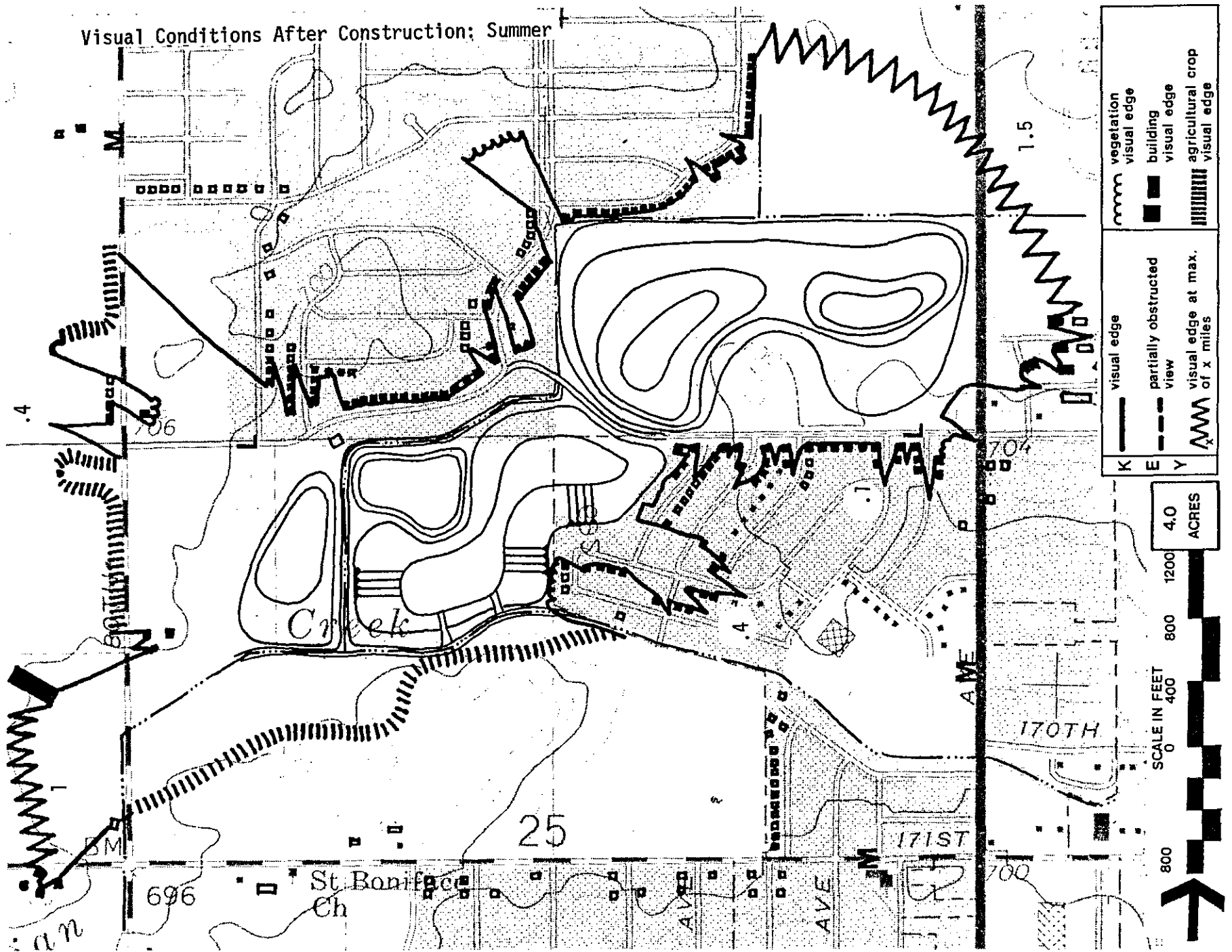

Figure 60: Site Visibility - Summer.

Visual Conditions After Construction: Winter

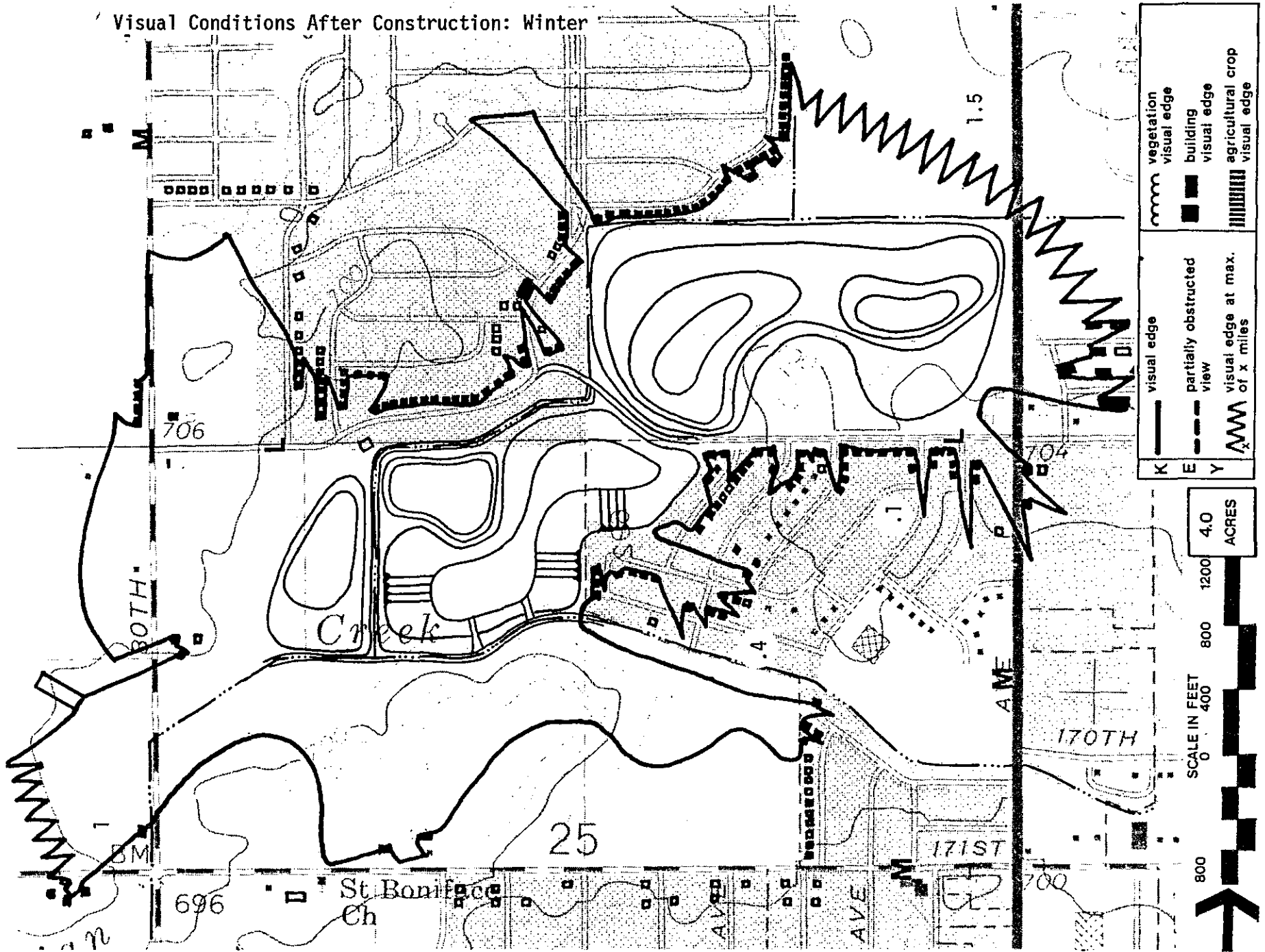

Figure 61: Site Visibility - Winter.

2. Perspectives

Field perspectives, including both drawings and photographs, have been used both as general illustrations and as an integral part of the analysis process. Selection of viewer position, and view direction is critical. Photographic alternatives, such as lens (normal, wide-angle, telephoto) and film have a direct bearing on results. Photographs to be used in measured content analyses are often black and white (Brush and Shafer, 1975, 8"x10"), while for viewer response testing, frequently color prints (Zube, Pitt and Anderson, 1974, p.3-33 mm lens-5"x7" prints) or color slides (Jones and Jones, 1976, p.79-Nikkon 50mm 1:1.4 lens) are used.

Since cone of vision is a research variable, particularly for stationary viewing, many studies incorporate panoramas. Sketch panoramas can be efficiently developed with traditional military field techniques (see Figure 62) (Pearson, p.201).

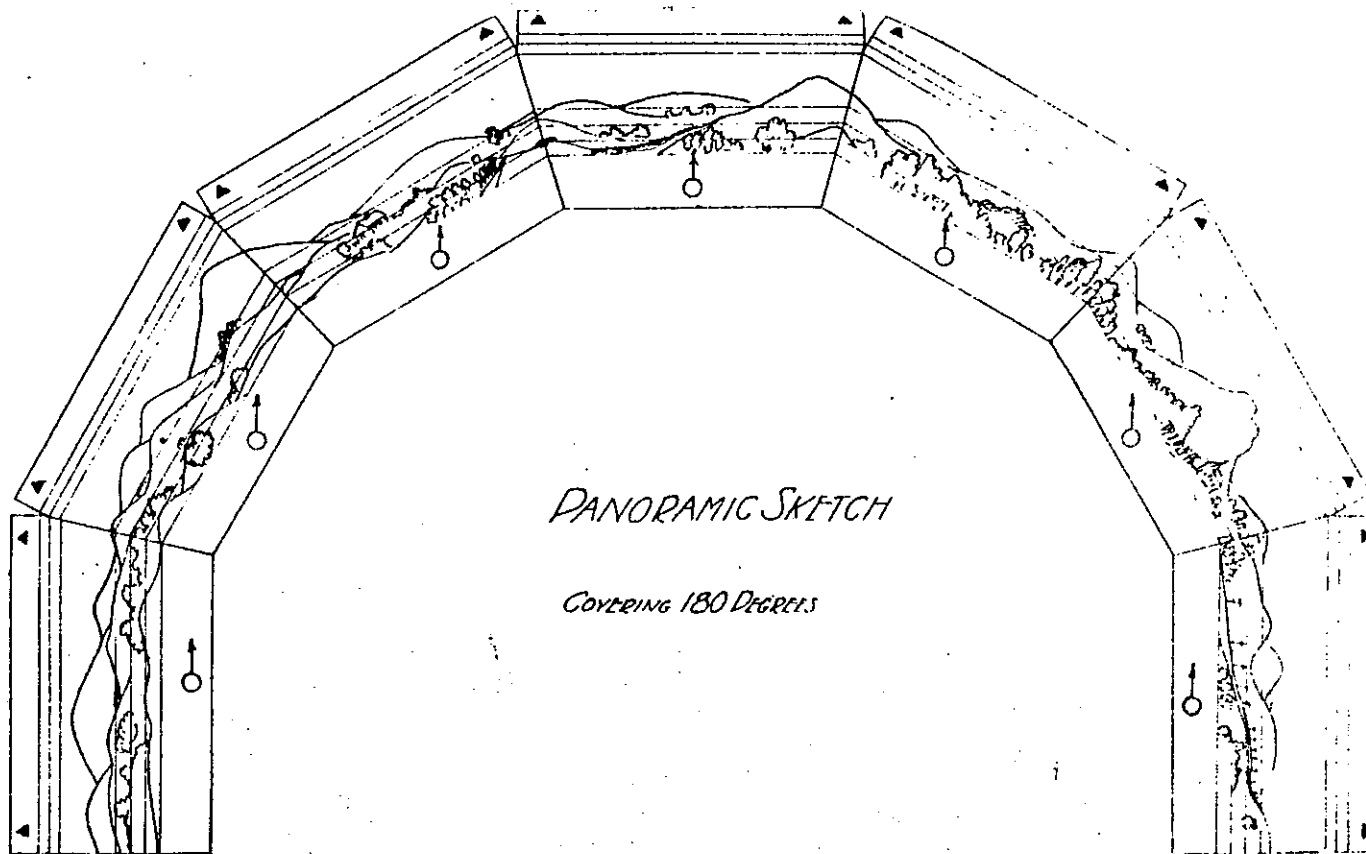

FIG. 102

Figure 62: Field Sketch
Panorama.

Photographic panoramas are made with a special tripod head which maintains a horizontal camera while controlling view direction and frame overlap for splicing (see Figure 63) (Gollub, 1976, p.181). A southern New England Study comparatively tested single wideangle 5"x7" photographs (65° cone of vision), and a spliced mosaic of three "normal" lens photos taken at 36° spacing which resulted in a 5"x14" product encompassing 122° of vision cone (Zube, Pitt and Anderson, 1974, p.23) (See also Section V-View Cone).

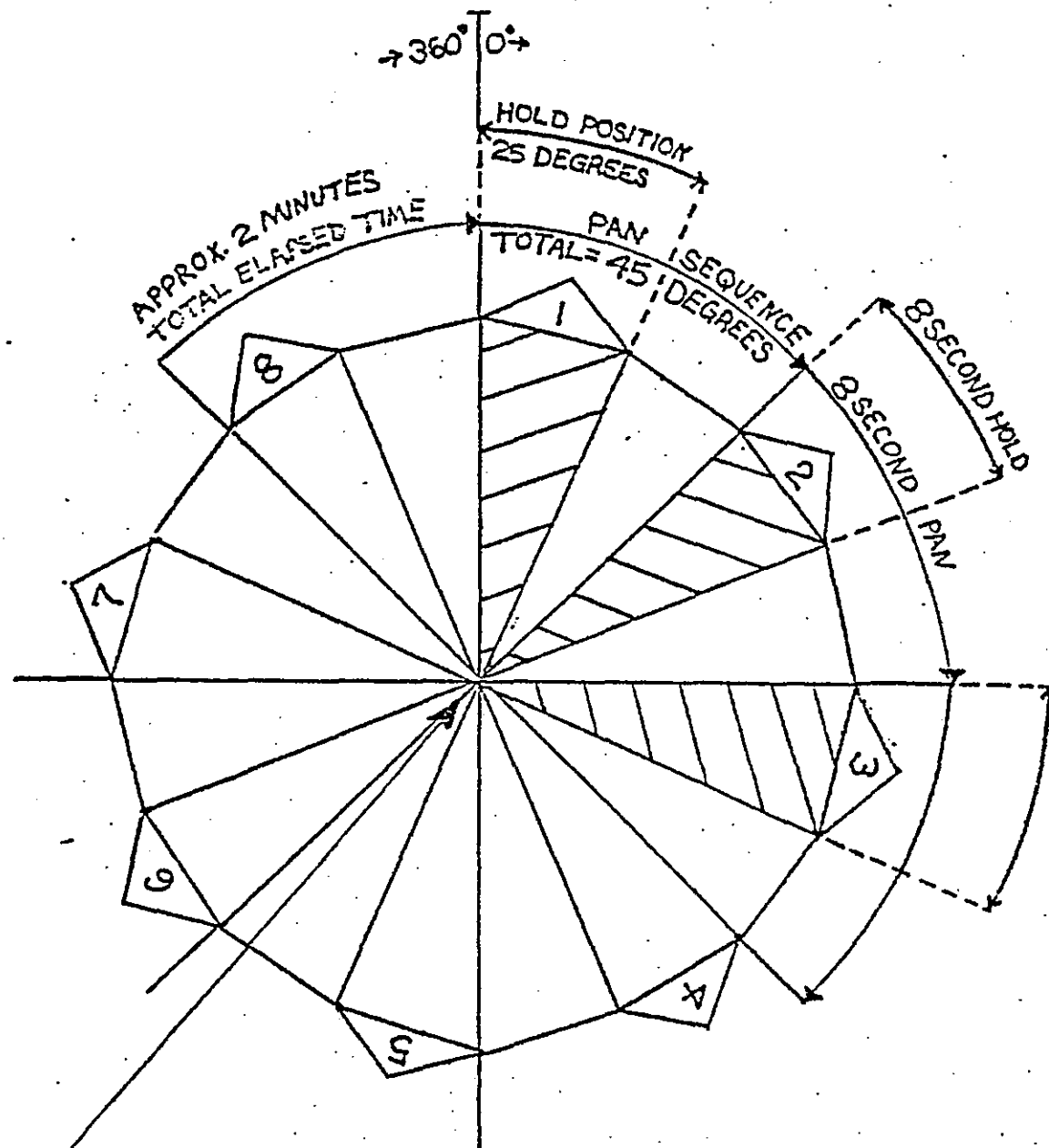

Figure 63: Panoramic
Photographic
Sequence.

OVER-HEAD VIEW OF CAMERA POSITION ON TRIPOD
USING A 25mm LENSE FOR PANORAMA SEQUENCE

The most extreme control in photography is required in methods utilizing "before" and "after" photographs requiring the precise location of complex proposed forms in the landscape. Tests for the MOSAIC system were done with a 2¼"x2¼" format camera with prints (black and white) enlarged to 45"x30" (Aerospace Corp., 1976, p.4-1).

C. PHYSICAL ANALOGS

1. Maps and Photos

a. Plan View

Plan view maps of viewsheds are the most common form of output. The maps may be either independent illustrations or integrated into a larger graphical analysis system. Map features can either be point, linear or aerial. Points include the location of viewer (or object) positions, such as vista points, project sites, and photograph origins.

Linear viewshed features may include travel paths, symbols representing local observer environment screening and enclosure conditions, and vectors representing distant view orientations (see Figure 58 and 64) Jones and Jones, 1977).

Aerial map elements show the geographic extent of visible and hidden surfaces. Viewshed borders are typically represented as "hard edge", although there are many accuracy issues at the fringe of a

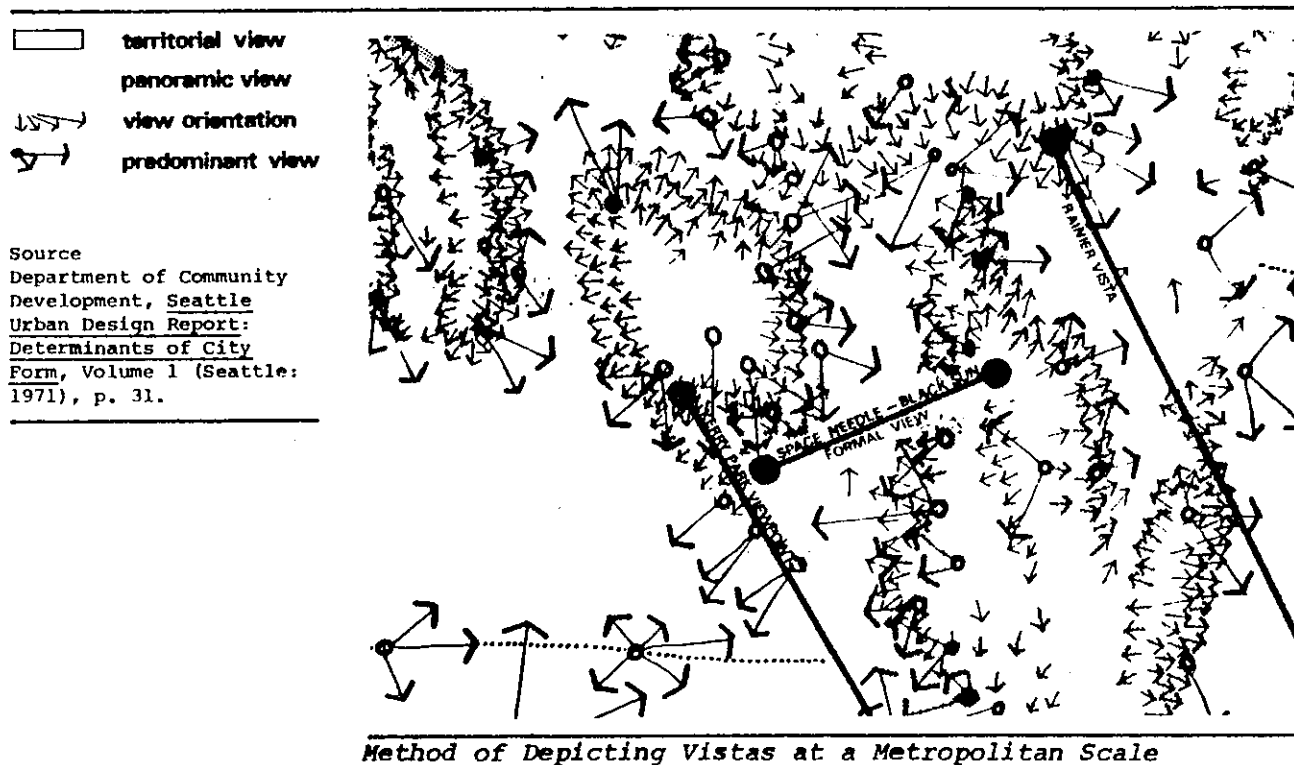

Figure 64: View Orientation Vectors.

visibility zone and some edges may in reality be "grey zones". (Felleman, 1979).

In addition to two basic aerial sets, visible and hidden, a wide variety of quantitative and qualitative visibility information can be mapped in relation to overlapping views (times seen) (see Figure 65) (Jones and Jones, 1977, p.57), observer type and numbers and distance.

Composite viewshed for multiple viewpoints

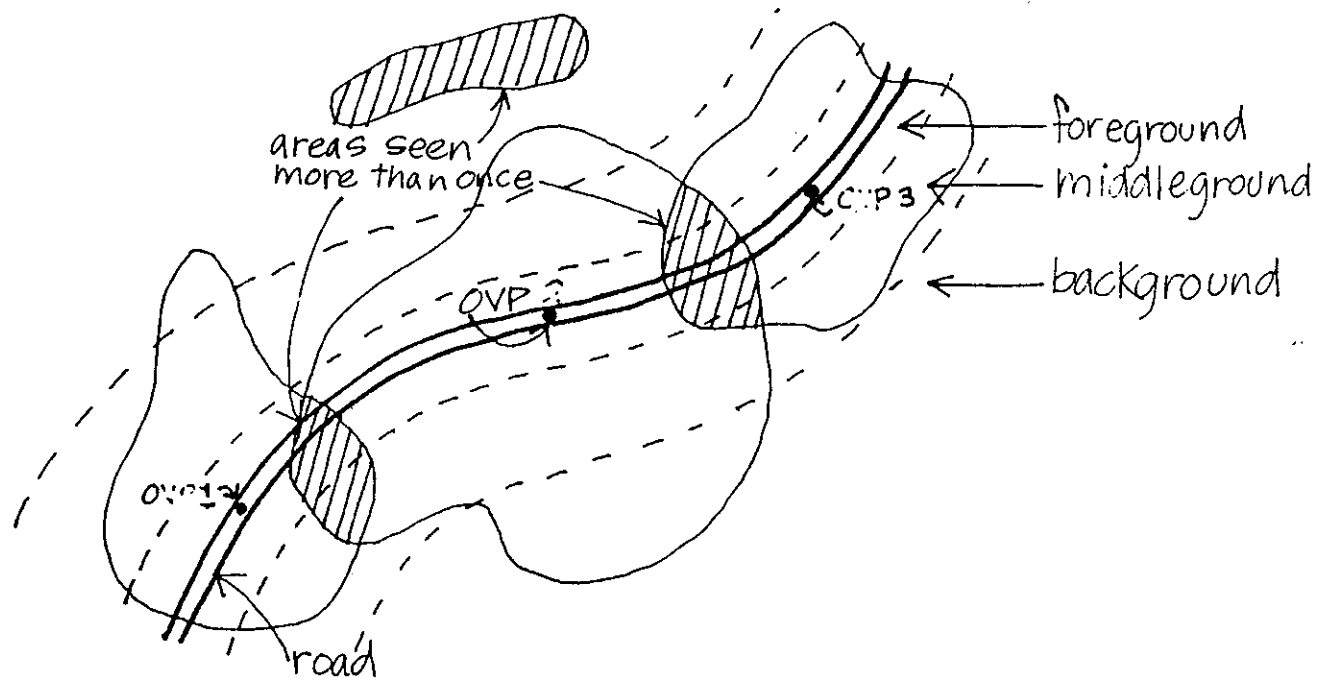





Figure 65: Overlapping Viewsheds.

Assignments of relative importance to observers can lead to graphic spatial differentiation between observer positions. Division of maximum visibility extent into intermediate distance zones can also provide the logical basis for map variety (see Figure 66) (U.S. Forest Service, 1974, p.43).

		Sensitivity Level						
		fg1	mg1	bg1	fg2	mg2	bg2	3
Variety Class	class A				PR	PR	PR	PR
	class B		PR	PR	PR			MM
	class C	PR	PR				MM	MM

Symbol	Objective	Color Code
R	RETENTION	
PR	PARTIAL RETENTION	
M	MODIFICATION	
MM	MAXIMUM MODIFICATION	

Preservation does not appear on the chart but is indicated by:

P PRESERVATION 

Assign Preservation Objective to all existing and proposed (within 10 years) Special Classified Areas.

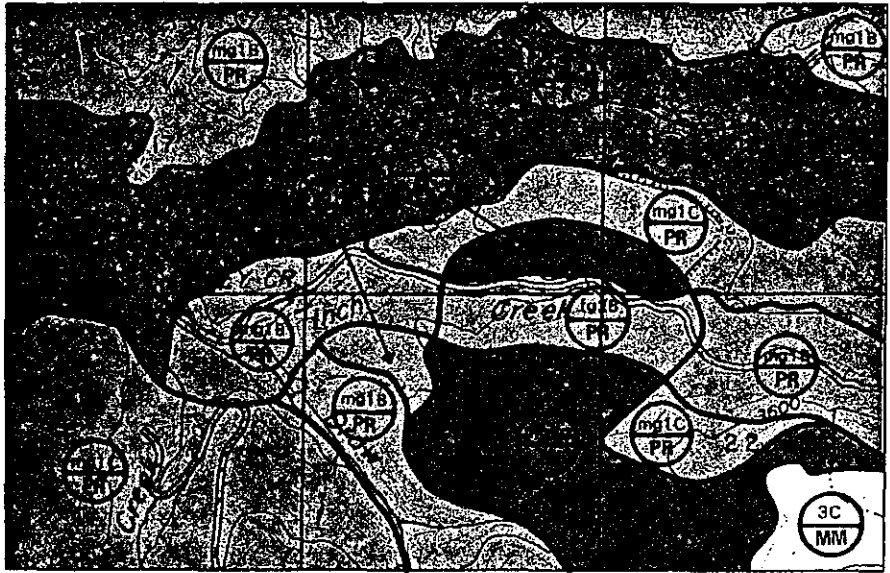

Objective Map

Figure 66: Weighted Overlapping Viewsheds.

A common analysis tool for planning, siting, and impact evaluation is the graphic overlay technique. Although visibility maps can be directly integrated into a comprehensive analysis, more typically they are combined with descriptive landscape scenery maps to generate a visual quality composite map which is then integrated with other resource information (see Figure 67). In either case, it is important to limit the number of graphic tones (or colors) in order to clarify subsequent visual interpretation of the composite overlays.

Figure 67: Overlay Analysis Mapping.

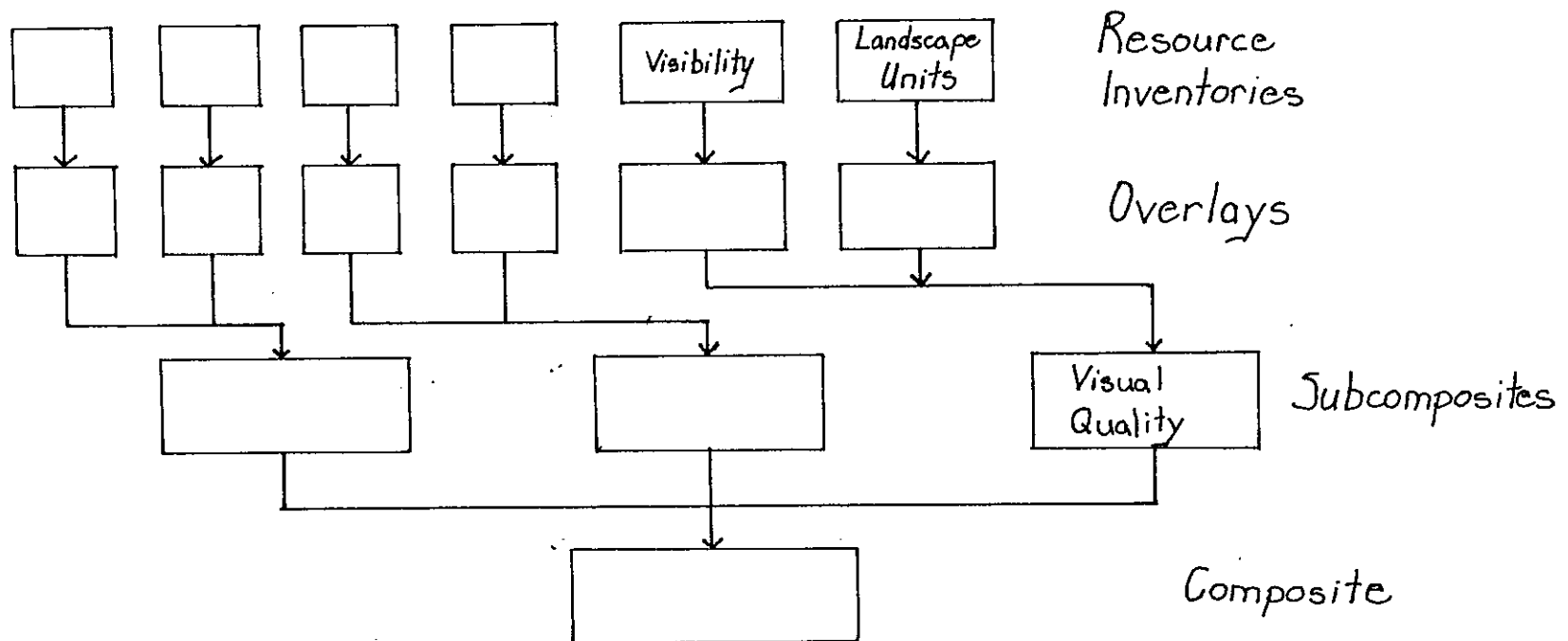

b. Perspectives

Although graphically possible, the development of accurate perspectives from topographic maps for large, complex landscapes is not a common technique. As a simplified proxy, many studies incorporate vertical cross sections to illustrate line-of-site, vertical scale, and landscape character relationships (see Figure 68) (Colorado Dept. of Highways, 1978). Approximate perspectives can however be readily drawn for simple objects or patterns in the landscape (see Figure 69) (U.S. Forest Service, 1972, pps. 92, 3).

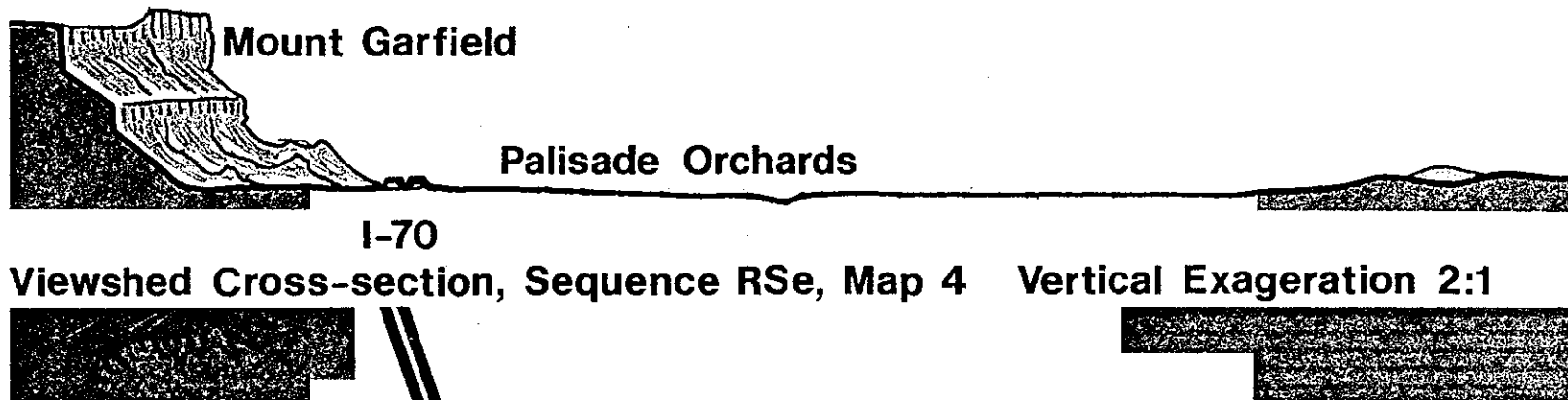
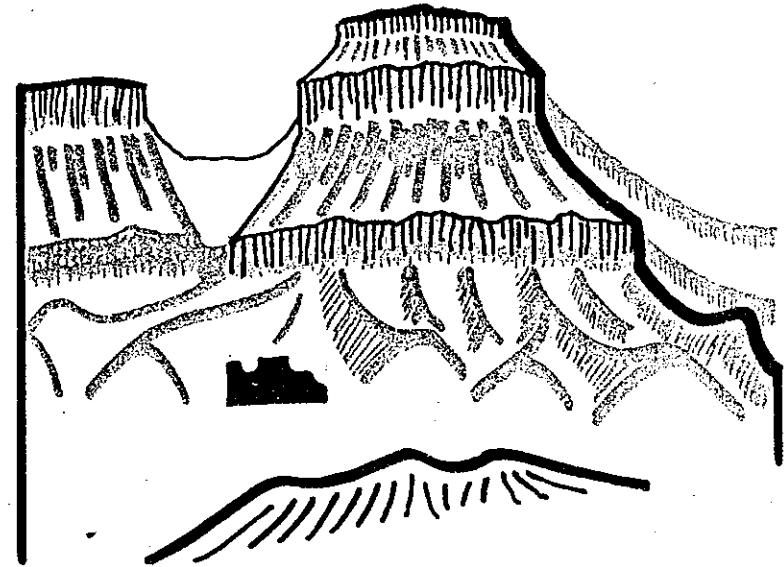

Figure 68: Illustrative Perspective and Section.

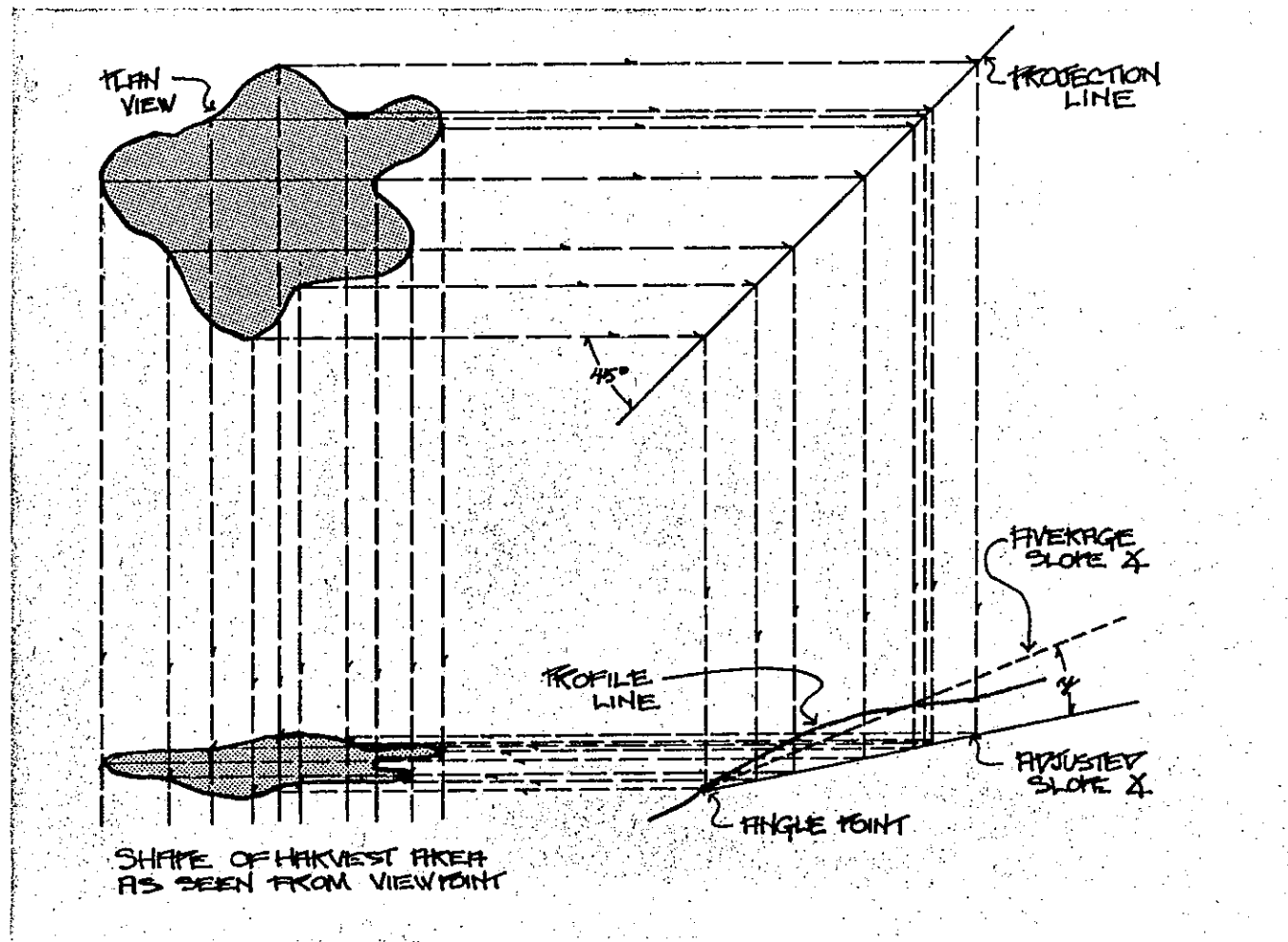

Figure 69: Orthographic Projection.

2. Models

a. Plan View

Plan view viewshed maps can be developed directly from a model scope or point light source (Felleman, 1979).

b. Perspectives

Ordinary cameras can be used to take "birdseye" views of models. Model scope photography can generate "simulated" views. "Fisheye" or macro lenses may distort the resultant image (see Figure 42) (Felleman, 1979).

D. NUMERICAL TECHNIQUES

a. Plan View

A primary product of a digital line of sight analysis is a numerical matrix indicating the visibility of data cells or points. This matrix can be internally stored and combined directly with other data base factors or outputted through a variety of devices.

High speed printers can list the tabular cell information, and generate spatial maps. The latter can have direct numerical significance such as "times seen" (see Figure 55), or can incorporate symbol types and overprinting to create a tonal hierarchy of interpretive content (see Figure 70).

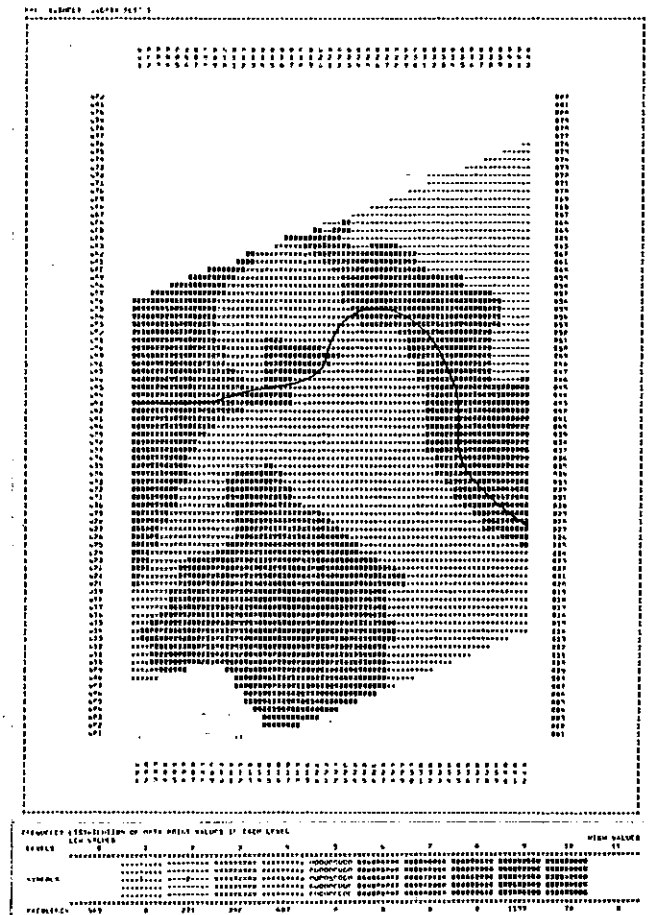

Figure 70: Highspeed Printer Tonal Map.

Line plotters, electrostatic prints, and cathode ray tubes are increasingly used to generate high visual content planimetric information (see Figure 71).

b. Perspectives

Computer graphics is becoming the key tool in creating landscape perspectives due to the ability to quickly and efficiently process large data bases. Common techniques use a plotting device to draft a three dimensional surface of the hidden line perspective grid (see Figure 50). Variations include graphically increasing the grid density, adding diagonals to the cell surface (see Figure 72)(MOSAIC), and supressing one grid direction.

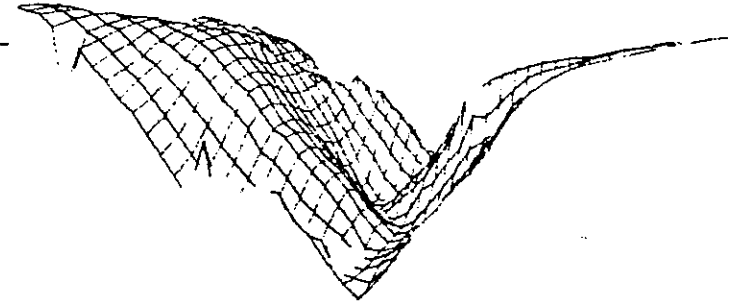

Figure 71: Line Plotter Visual Map.

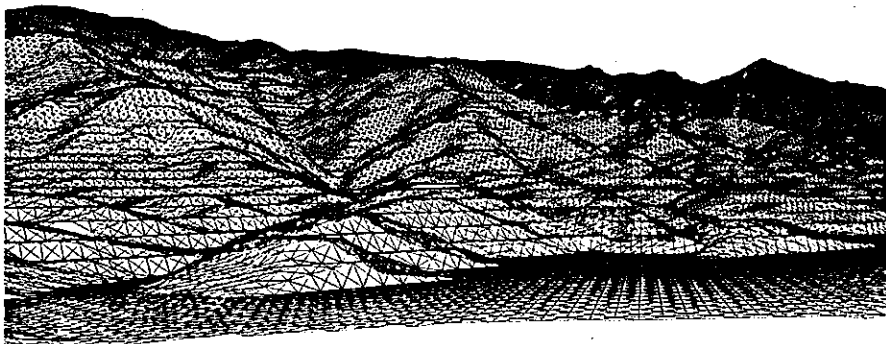

Figure 72: Grid Perspective with Diagonal Enhancement.

In addition to the grid cell plot systems, techniques are available to create surface sections perpendicular to the central line of sight, which maximizes contrast (see Figure 73) (Environmental Systems Research Institute), to draw contours of facets in perspective, and to develop stereo pairs (black and white or red and green) (American Society of Photogrammetry, 1978). The introduction of surface features in the perspective can be on a cell by cell character basis (see Figure 74) (Myklestad and Wagar, 1975); by locating typical structures (see Figure 75) (Aerospace Corp., 1977, p.6); or by plotting a complex project form (see Figure 76) (Penzien, et al., 1978, p.6).

A new generation of programs, scaled down to run on "mini" or "micro" computers can now solve the object-shape problem shown in Figure 69 (See Figure 77) (Nickerson, 1979, p.15).

COMPOSITES

Artist renderings have long played a role in visualizing proposed projects. A serious limitation has been the issue of accuracy vs. artistic license. Through the combination of field photography, artistic

techniques, models and computer graphics, stationary (photo montage) (see Figure 78) (Aerospace Corp., 1977, p. 3) and dynamic (film) simulations are becoming a primary analysis and communication/education tool.

A powerful method for communicating general spatial and character arrangements is the "birdseye" perspective. These may combine a variety of techniques (see Figure 79) (Penzien, et al., 1978, p.36), (see Figure 80) (U.S. N.R.C., 1977).

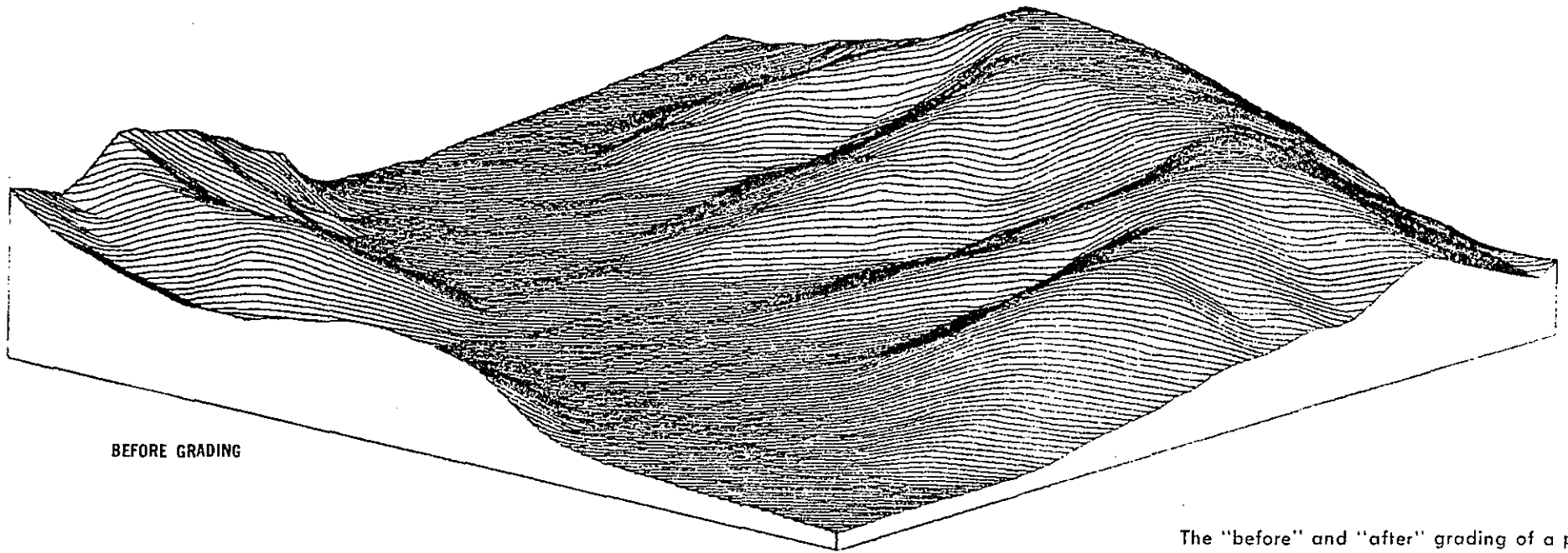

BEFORE GRADING

The "before" and "after" grading of a particular subdivision design can be simulated by Views.

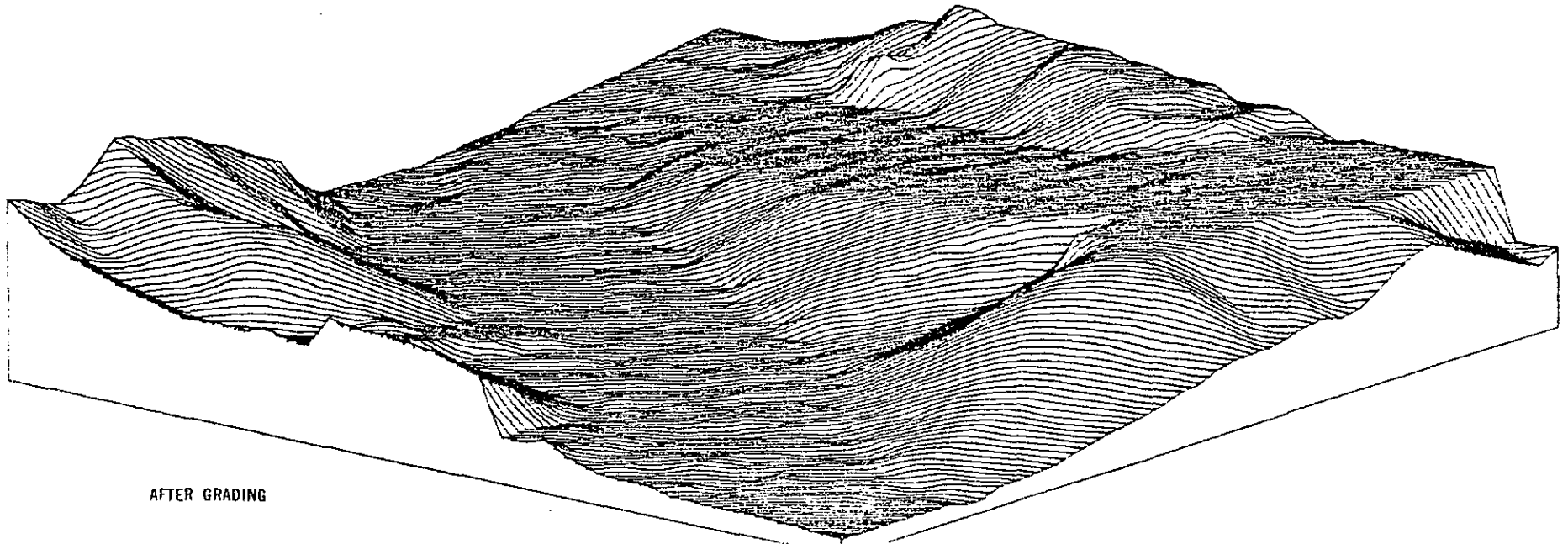

AFTER GRADING

Figure 73: Hidden Line Section Perspective Perpendicular to Line-of-Sight.

Figure 74: PREVIEW Surface
Feature Plot.

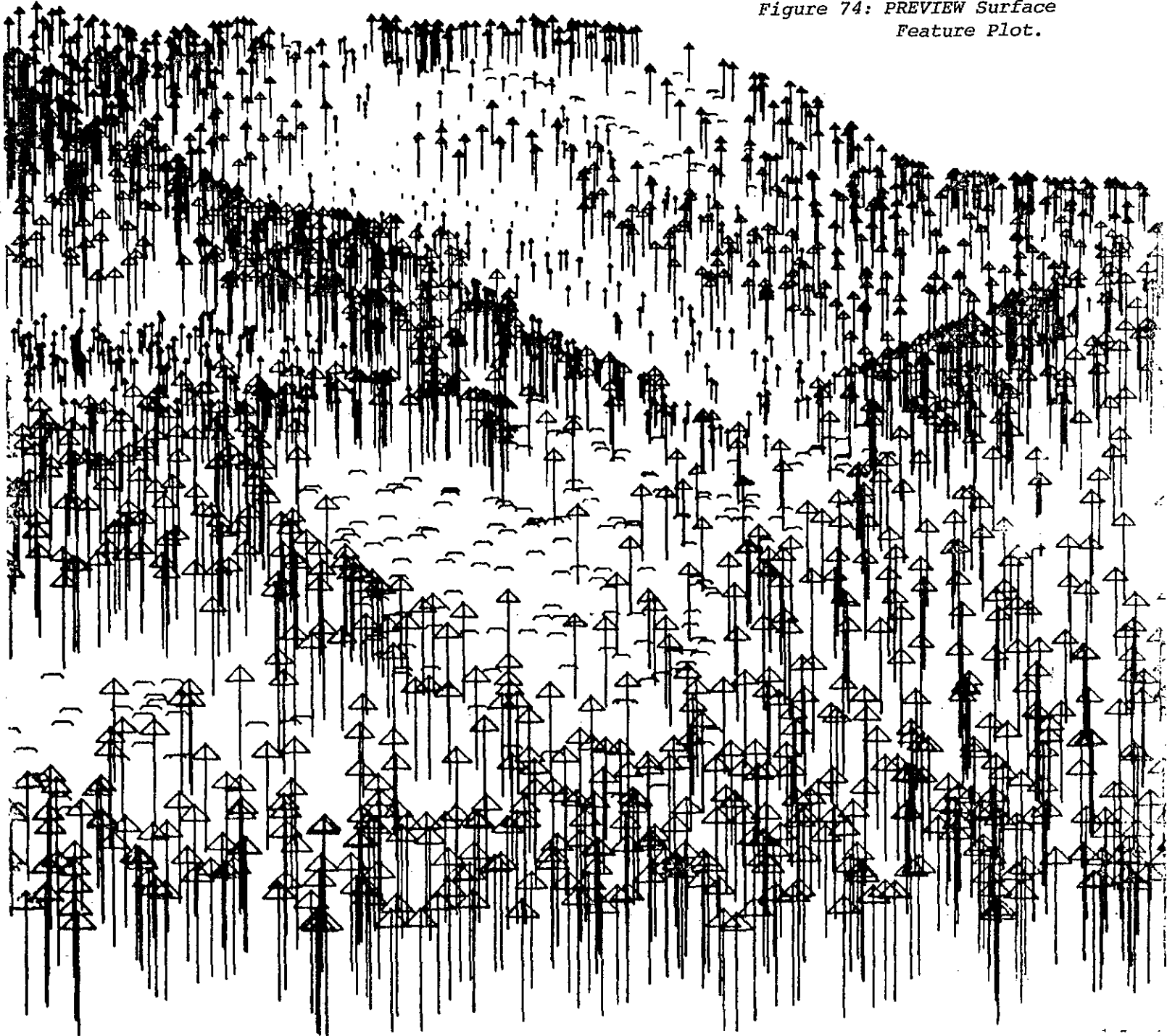

COMPUTER GENERATED FIGURES

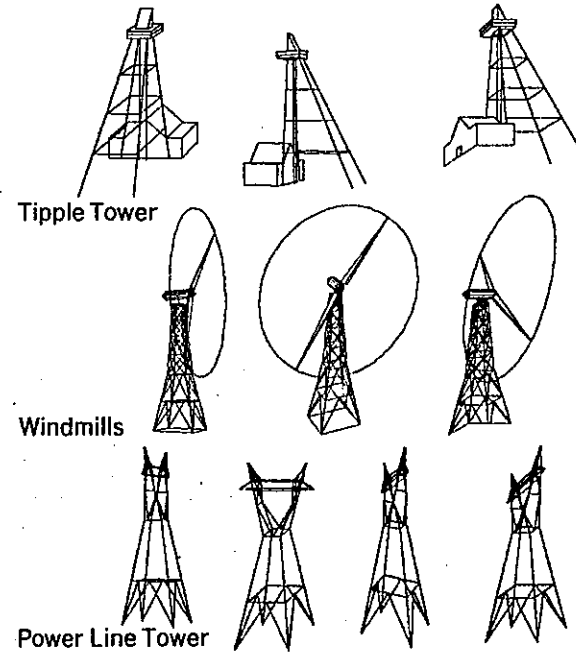
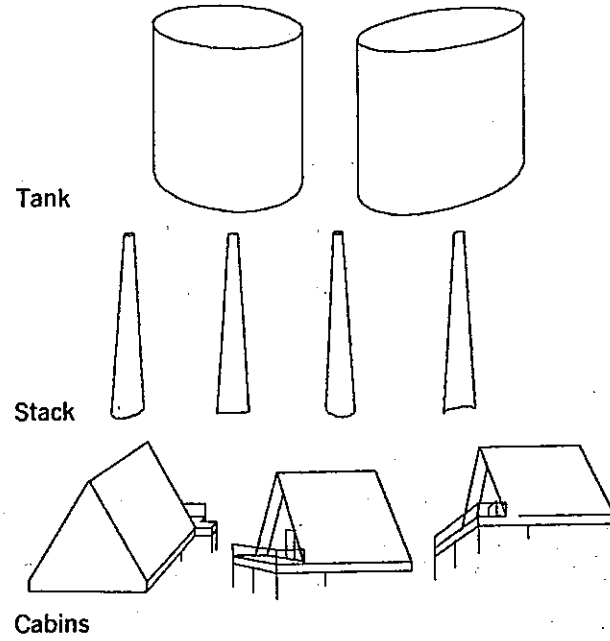

Figure 75: Computer Generated Structures.

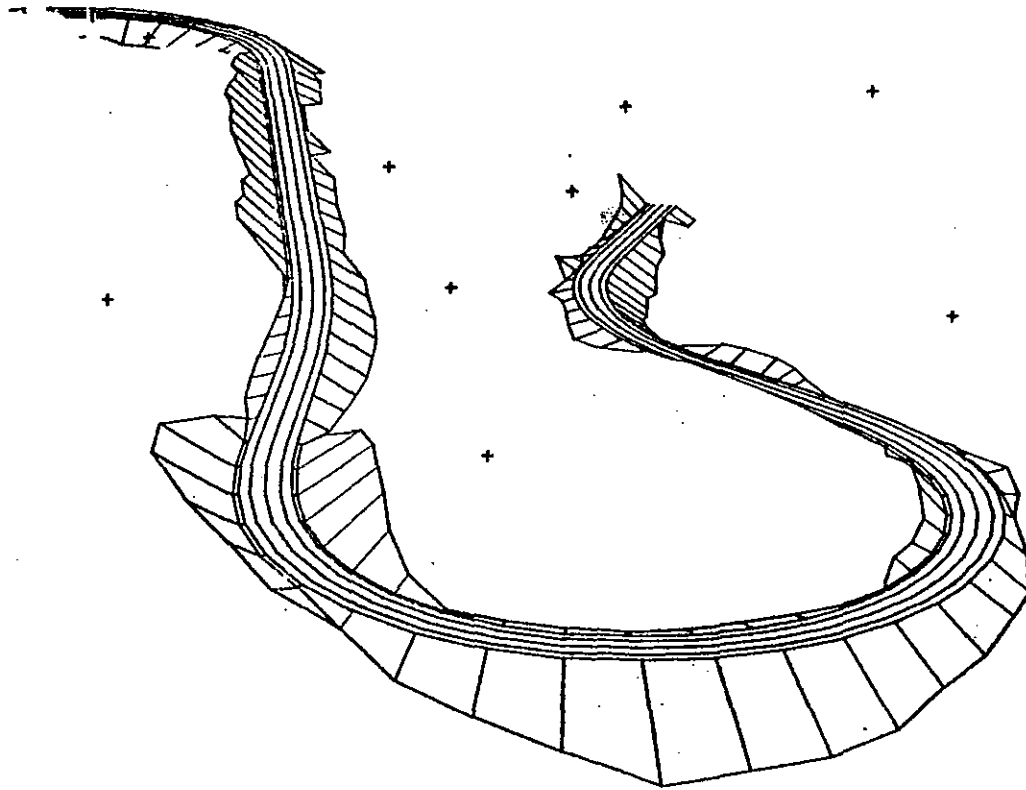

Figure 76: Highway Perspective.

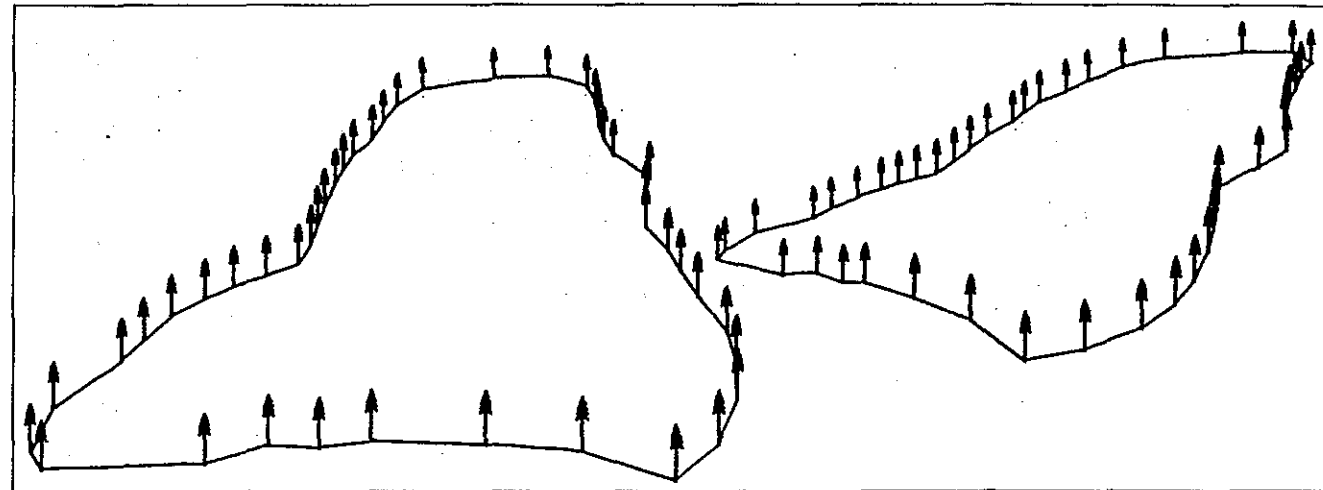

Figure 77: Outline Perspective.

TERRAIN REGISTRATION VERIFICATION



FUEL BREAK



Computer Generated Graphics.

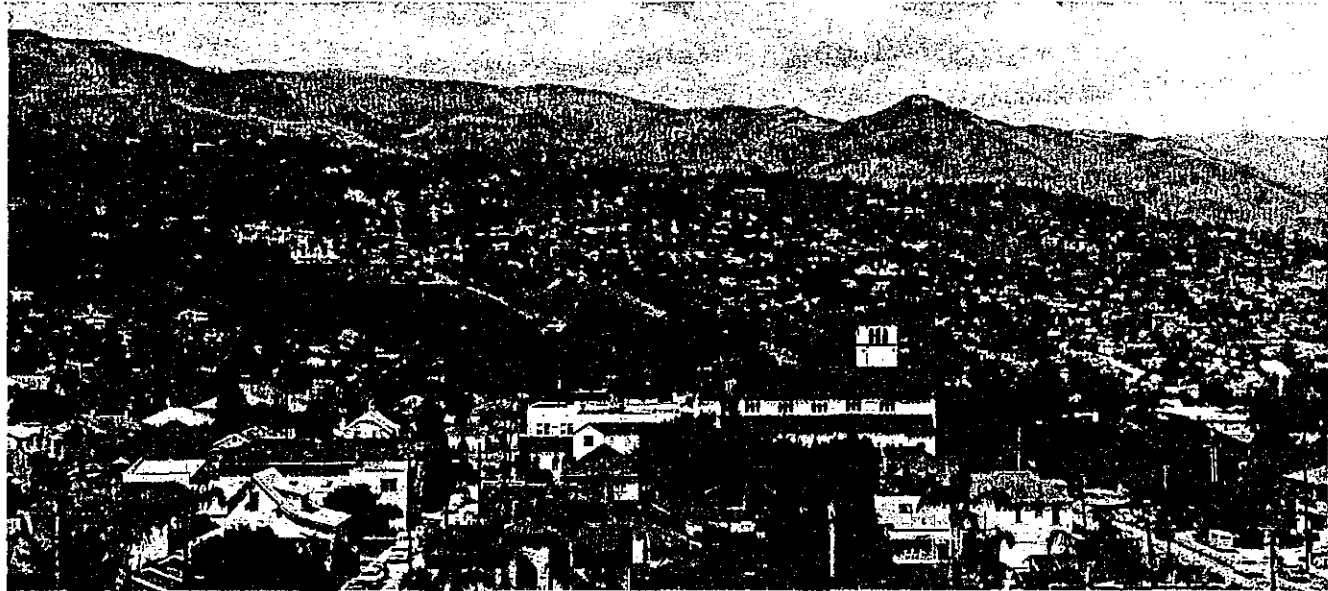

Artist Enhanced Photomontage of a Fuel Break.

Figure 78: Fuel Break Computer Montage.

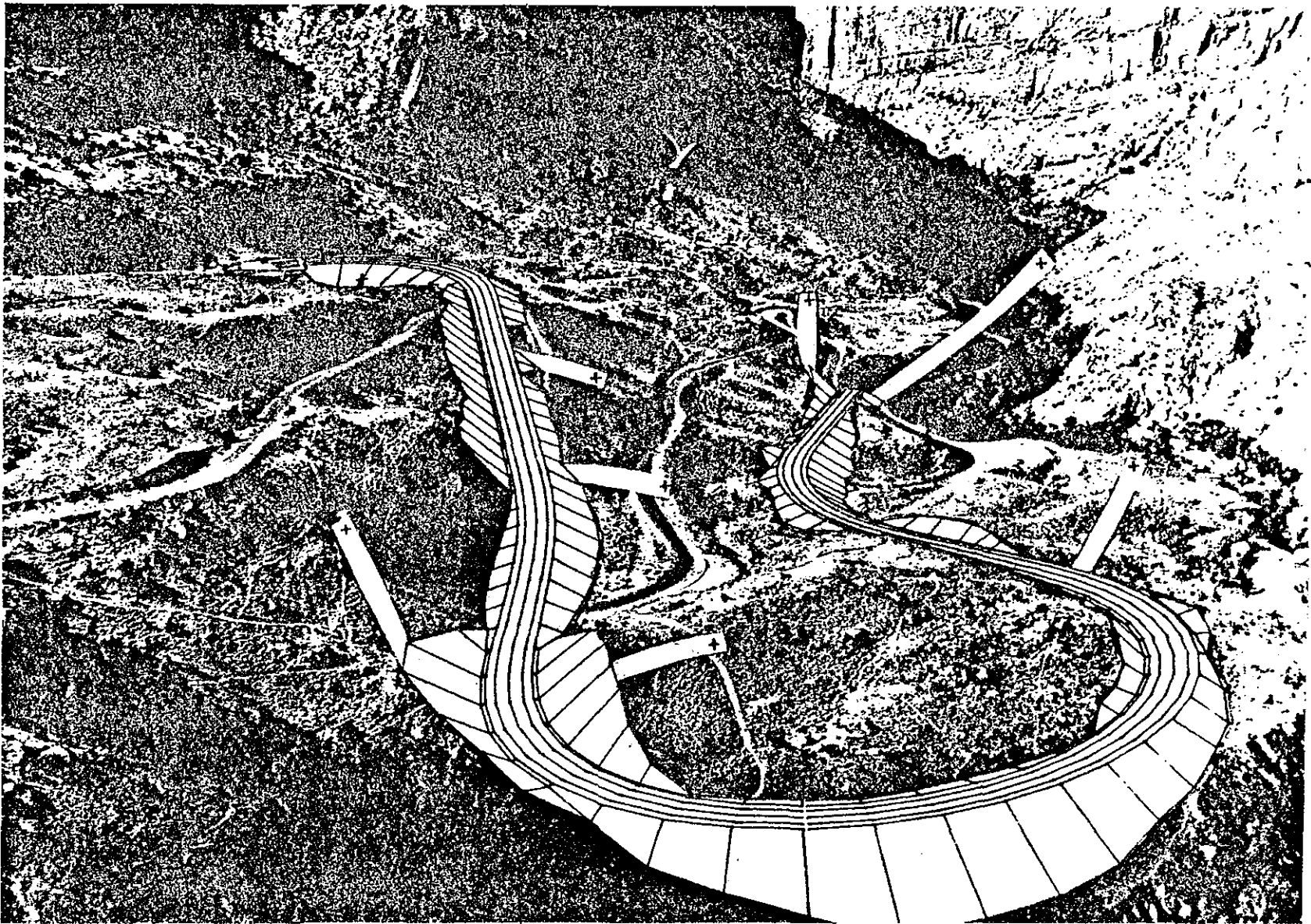

Figure 79: Highway Computer Montage.

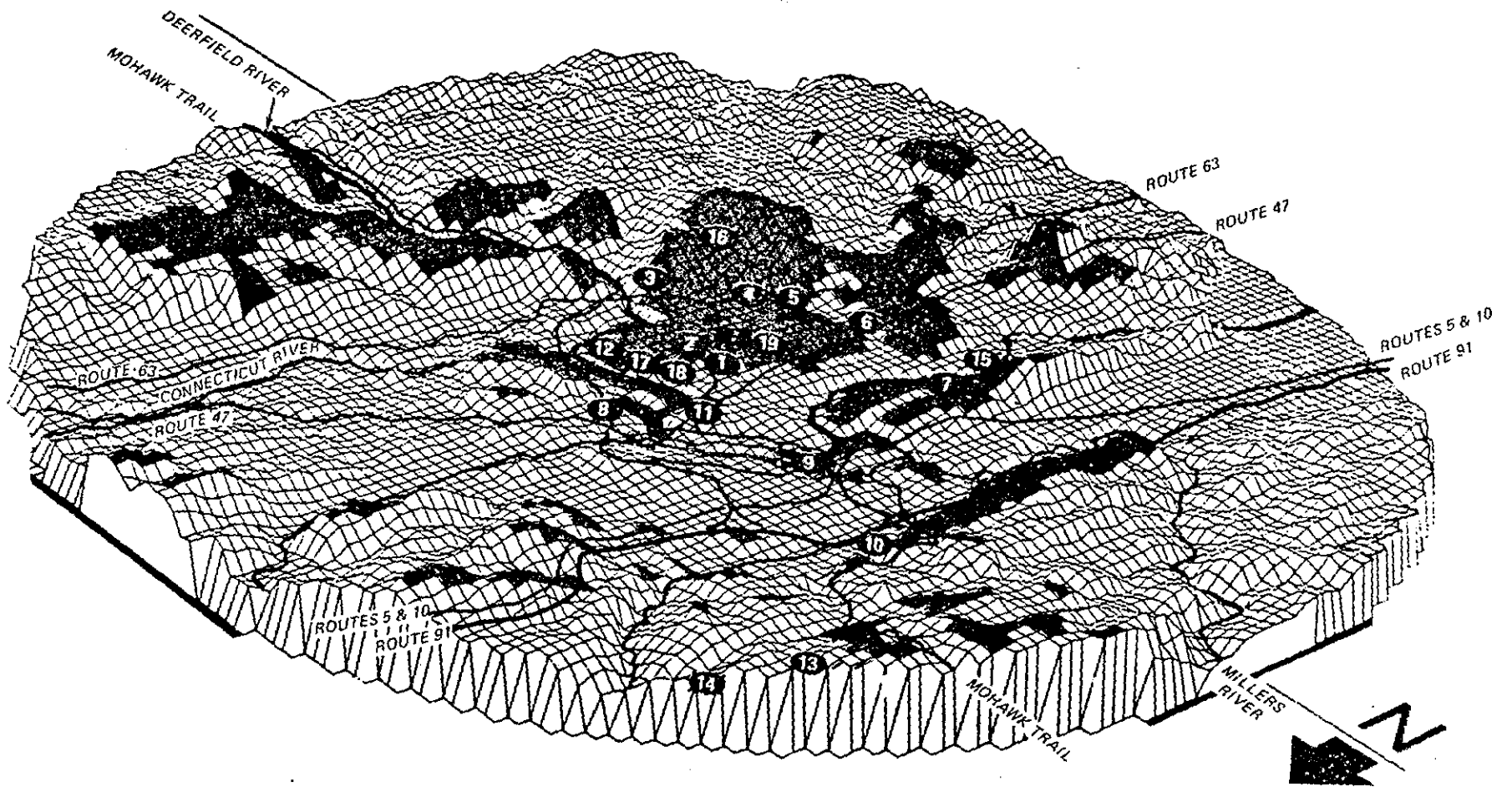

Figure 80: Birdseye Project Cell Visibility.

VIII CONCLUSIONS

VII CONCLUSIONS

Landscape visibility analysis is a growing field, both in terms of social importance and available methodologies. The complexity of the problem, requires careful systems planning in order to optimize the output quality of limited study resources.

A three-tiered hierarchy of related analysis sub-systems can be identified: visibility; scenery; and resource planning, design and impacts (see Figure 67). The design of the visibility study should be internally consistent. Explicit coordination is needed between data types and viewshed delineation processes. This is especially true where multiple combinations of data types and processes are to be synthesized.

The visibility output should be compatible with the scenery assessment method. Transparent overlays, computer data bases and viewer response photographs all have unique format requirements. Many studies incorporate a variety of approaches. For example, high visibility

(from graphic overlays) may be a criteria for selecting areas for a design alternatives study (computer graphics) that will utilize citizen participation (photo preference). Each interface requires careful prearticulation.

Because scenery assessment is often combined with other study elements (social and natural), coordination is often necessary with multiple disciplines. At this level, both data and methods selection are critical. To illustrate, in computer based studies, selection of grid cell size, and surface cover types, must judiciously meet all users needs. A tax base, or watershed hydrology analysis would have model requirements which differ from a visibility study. Dates of photography, base mapping, and field work all can be important shared decisions.

One area that requires further research is the statistical accuracy of visibility (Felleman, 1979). In the New York Sea Grant test site, each visibility method gave different results (see Figure 81). With the emphasis given to quantification in impact analyses, measurements have been applied to various components of the visibility subsystem such as viewer contact, viewshed area, and visual frequency ("times seen"). Many

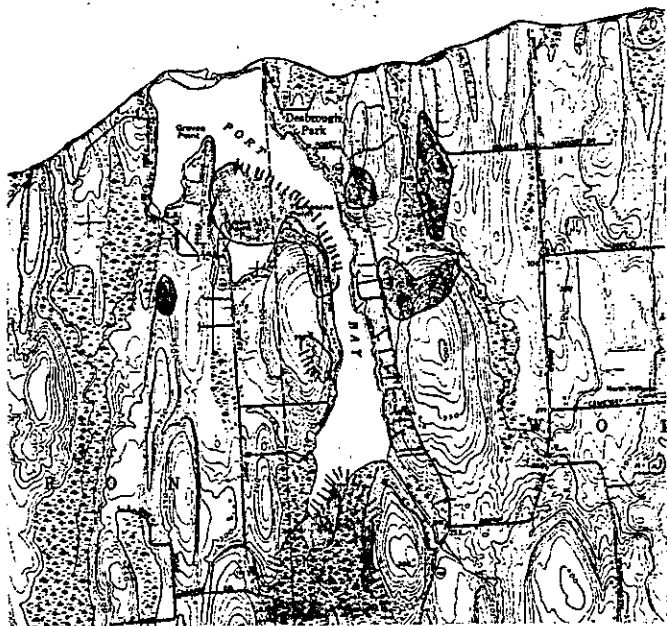

Primary

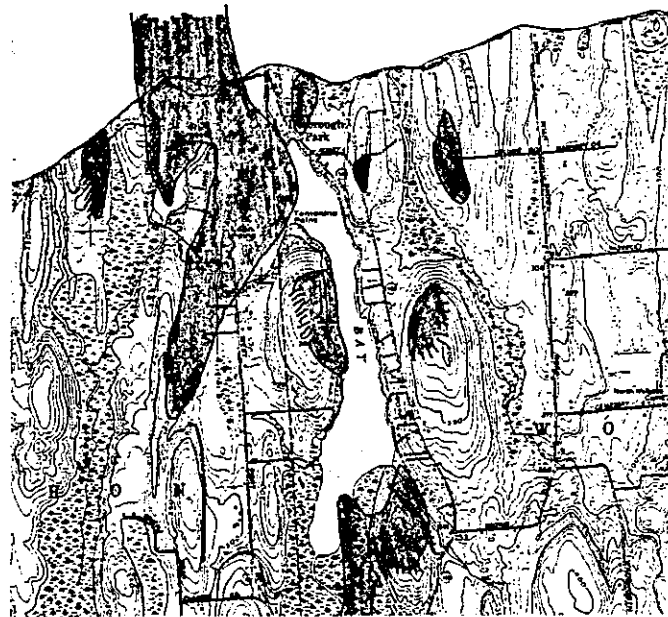

Secondary

Figure 81: N.Y. Sea Grant Visibility Test Composite Maps.

Tertiary

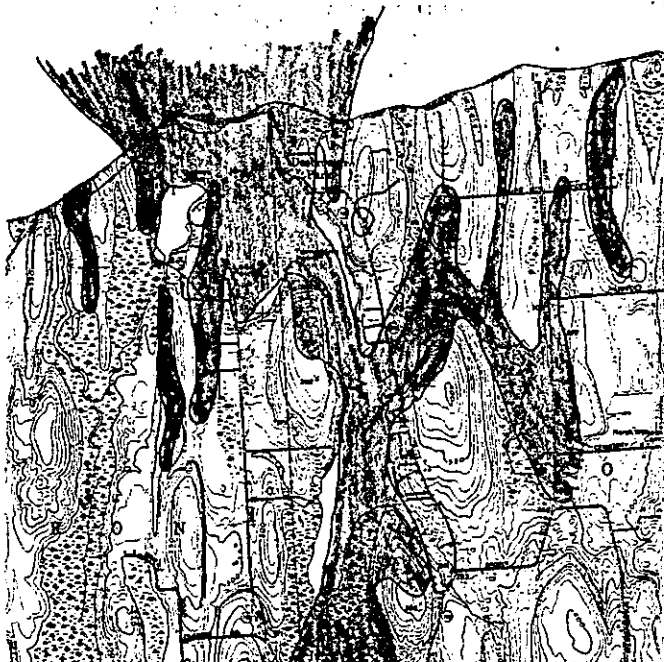

Quarternary

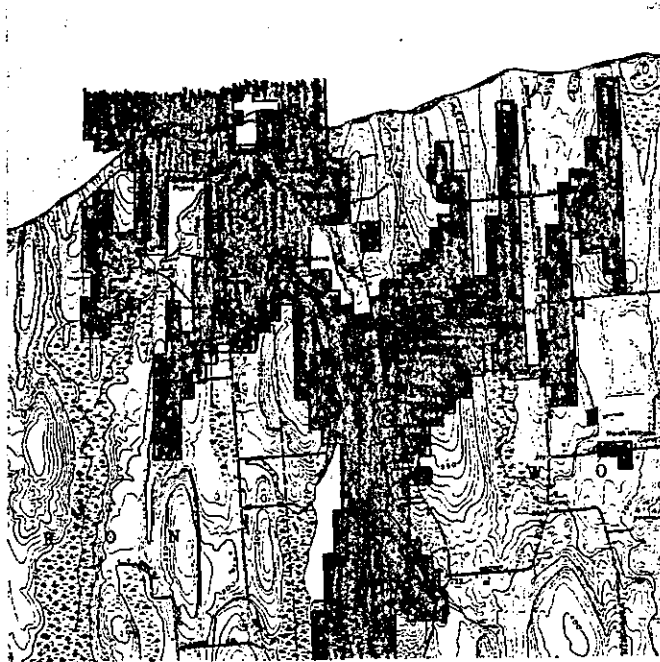

studies have used numerical matrices and formulas to develop a geographic hierarchy of visibility importance zones.

As discussed above, inherent in the data types and viewshed processes are accuracy limits. A fundamental question becomes what statistical range of reliability can be associated with any visibility study. Applied research on this issue may improve both the quality of the products, the effective allocation of critical study resources, and the increased public acceptance of scenery analyses.

APPENDIX A

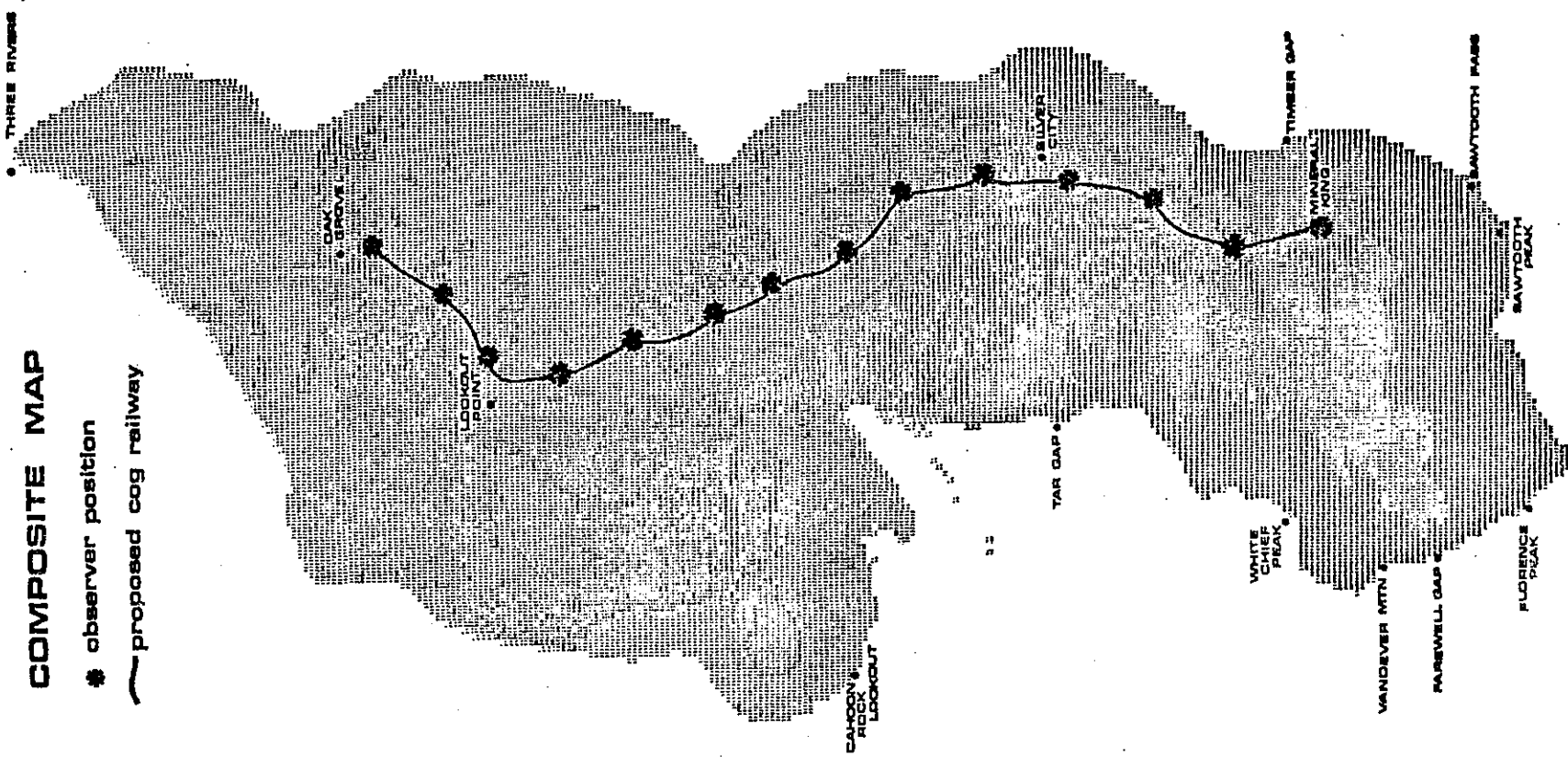

(Johnson, 1974)

Linear Positions:
 Observer Positions Along Proposed Cog Railway

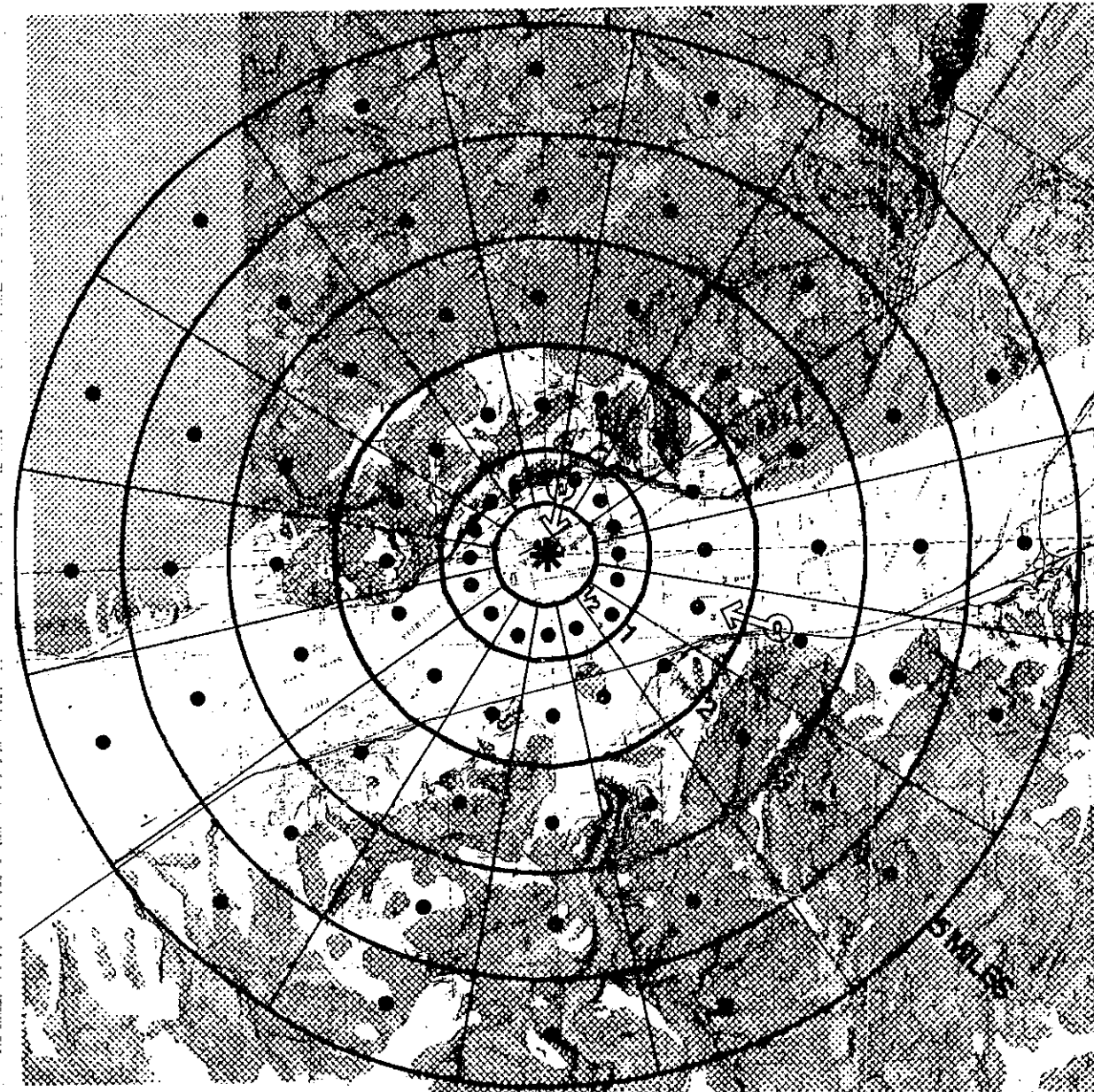

Concentric Positions:
Views to Proposed
Facility.

(Battelle, 1974)

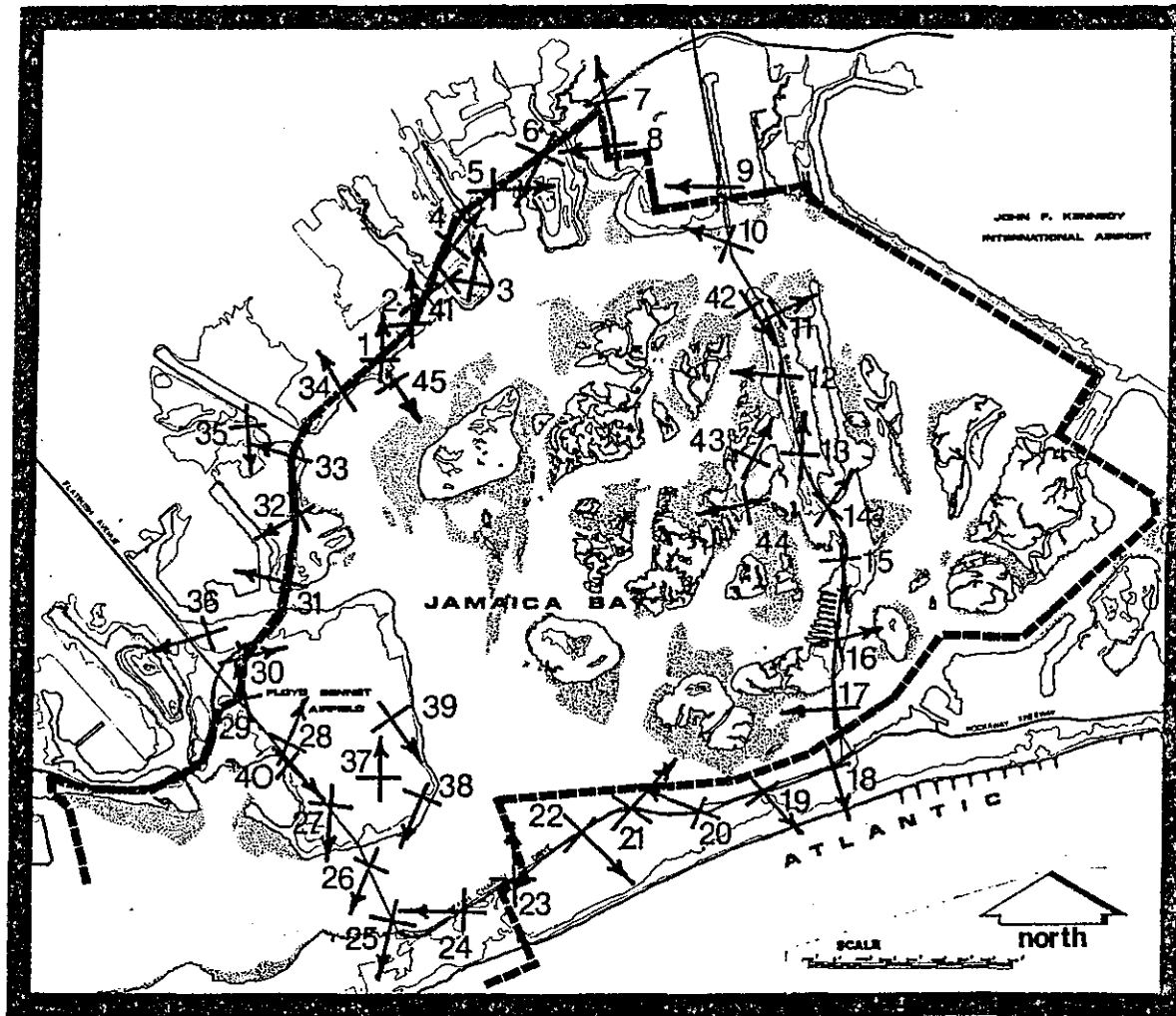



Random Positions:
Viewer Positions.

FORTY-FIVE VIEW STATIONS

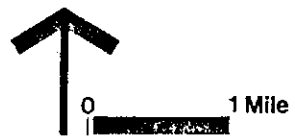
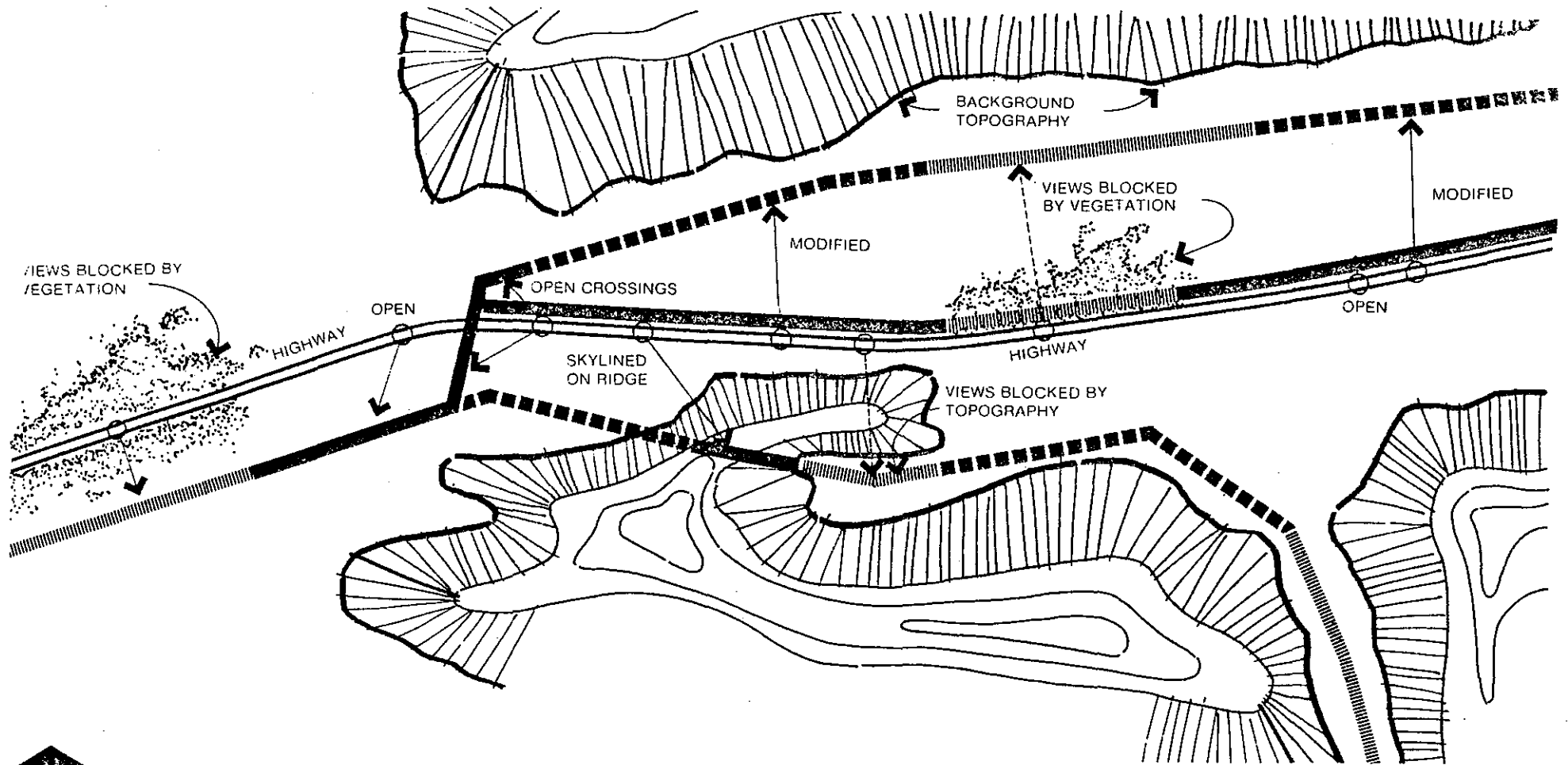
(Viohl, 1977)



-  OPEN - TRANSMISSION LINE WOULD BE SKYLIGHTED DUE TO LACK OF TOPOGRAPHIC BACKGROUND INFLUENCE OR RIDGE LOCATIONS.
-  MODIFIED - VISIBILITY OF LINE WOULD BE MODIFIED FROM HIGHWAY DUE TO TOPOGRAPHIC BACKGROUND AND A DISTANCE OF OVER ONE MILE FROM HIGHWAY
-  NONVISIBLE - VIEWS TO TRANSMISSION LINE WOULD BE BLOCKED BY TOPOGRAPHY OR VEGETATION

Roadside Visibility

(Wirth Assoc., 1976)

Continuous Positions

GENERAL LAYOUT OF SCORES

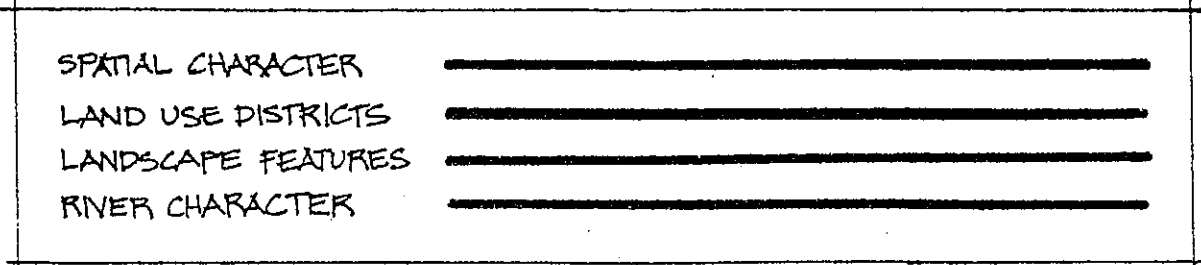
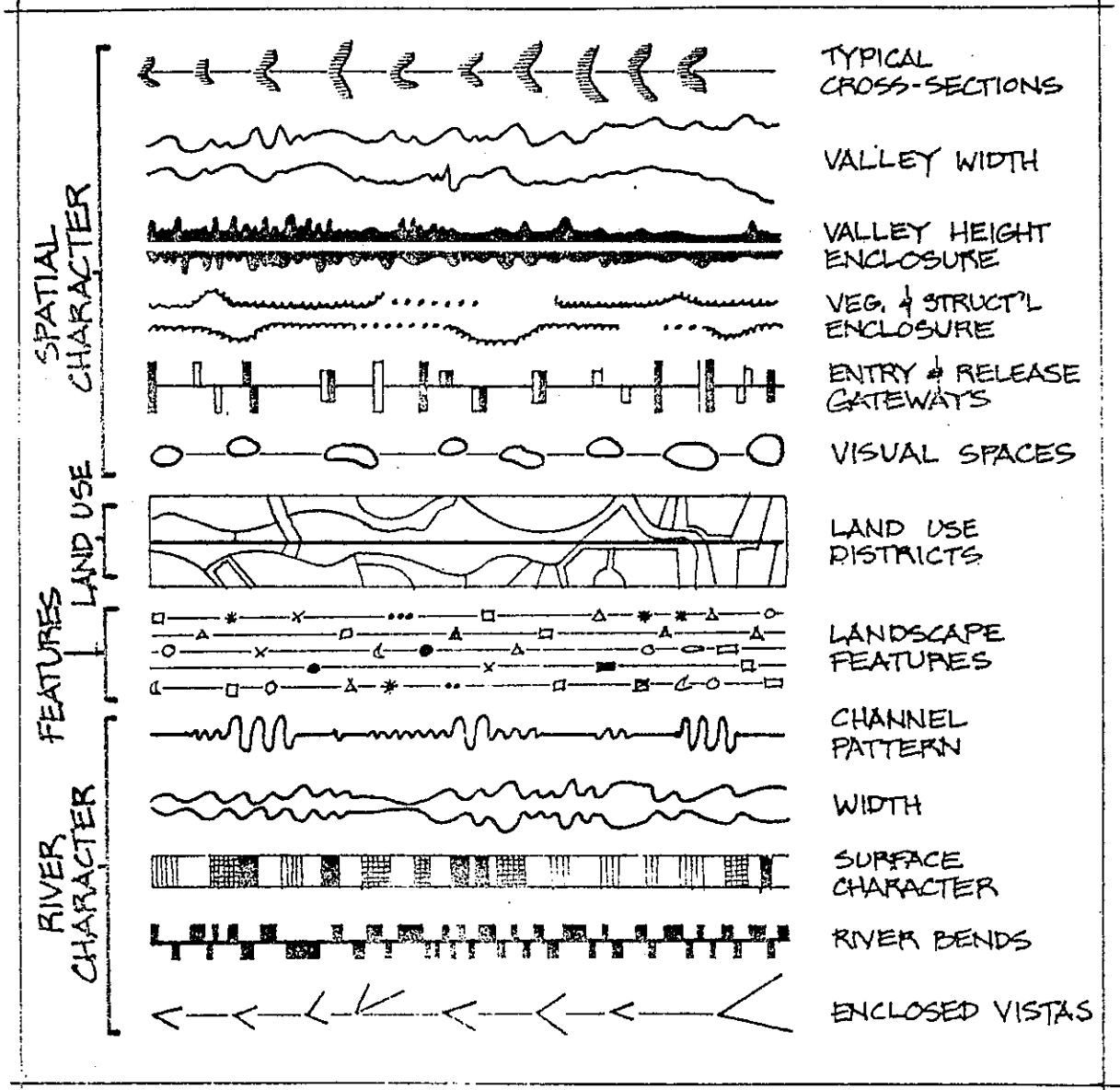
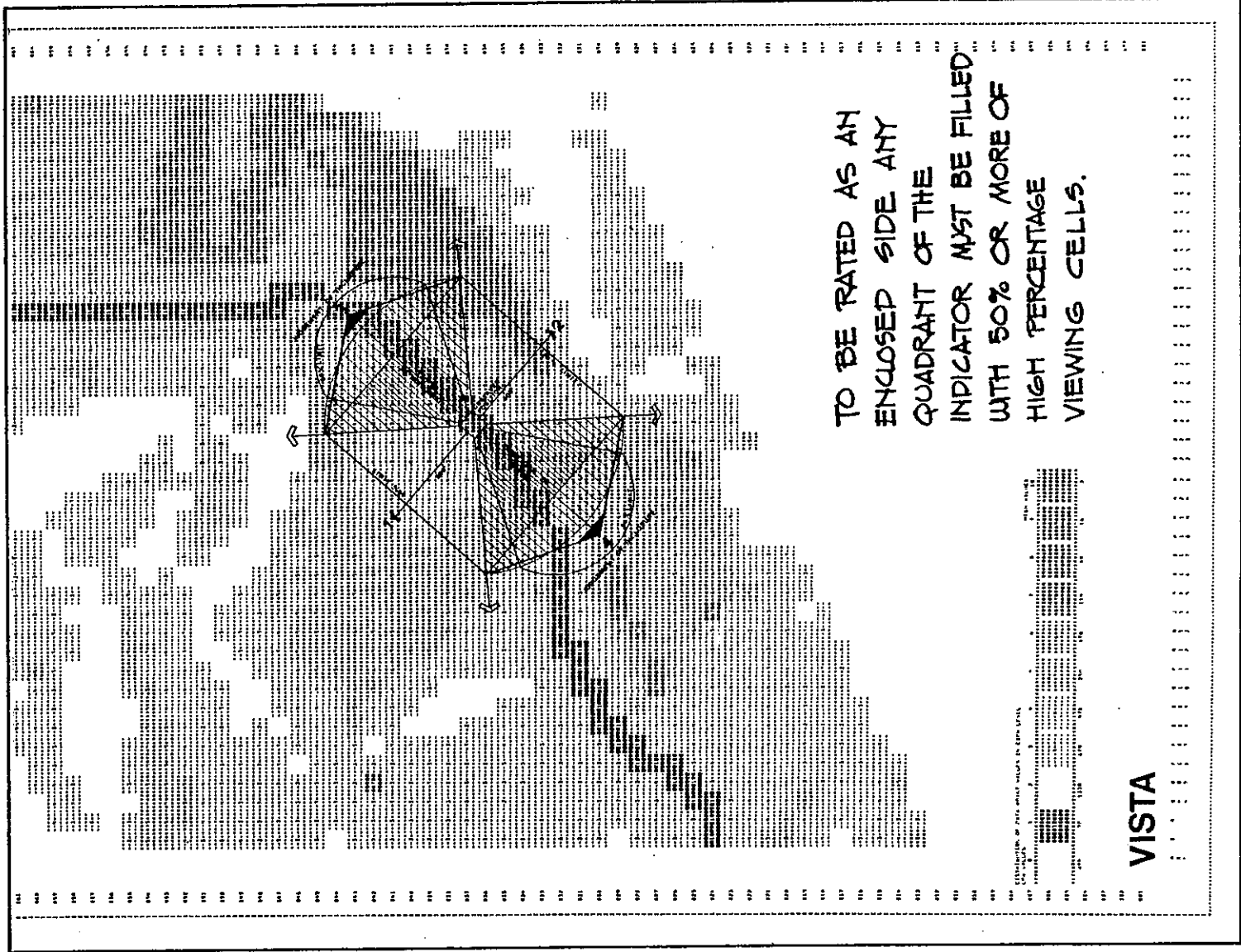

CHART OF SYMBOLS FOR EACH VARIABLE



Master Symbol Sheet for the Sequential Scores.



VISTA Scan

(Kunit and Calhoon, 1975)

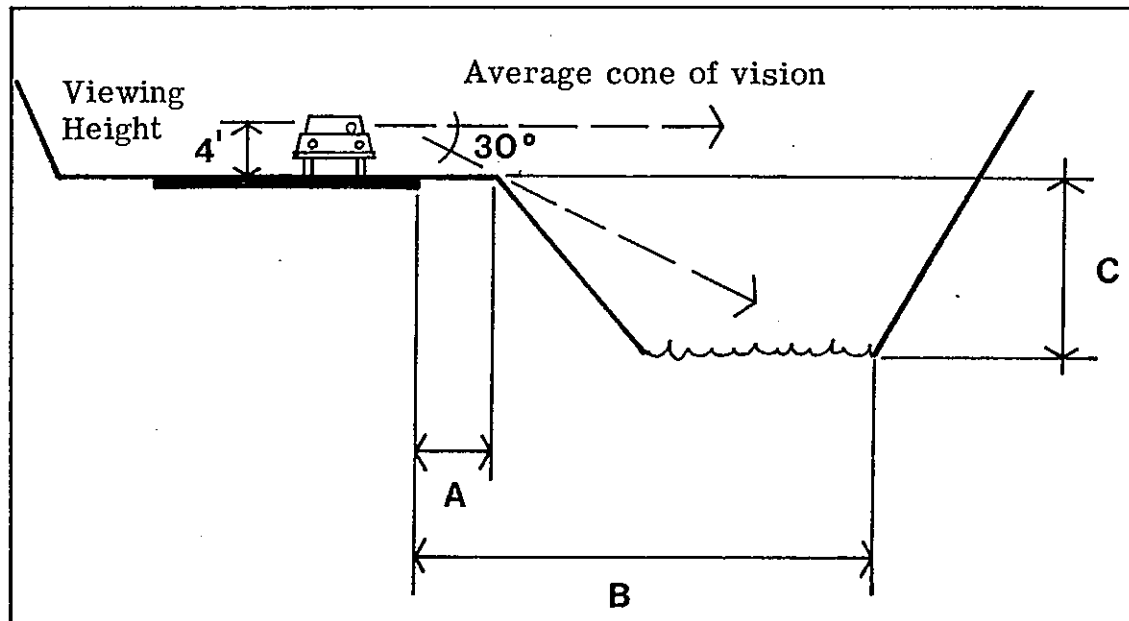

(Kunit and Calhoon, 1975)

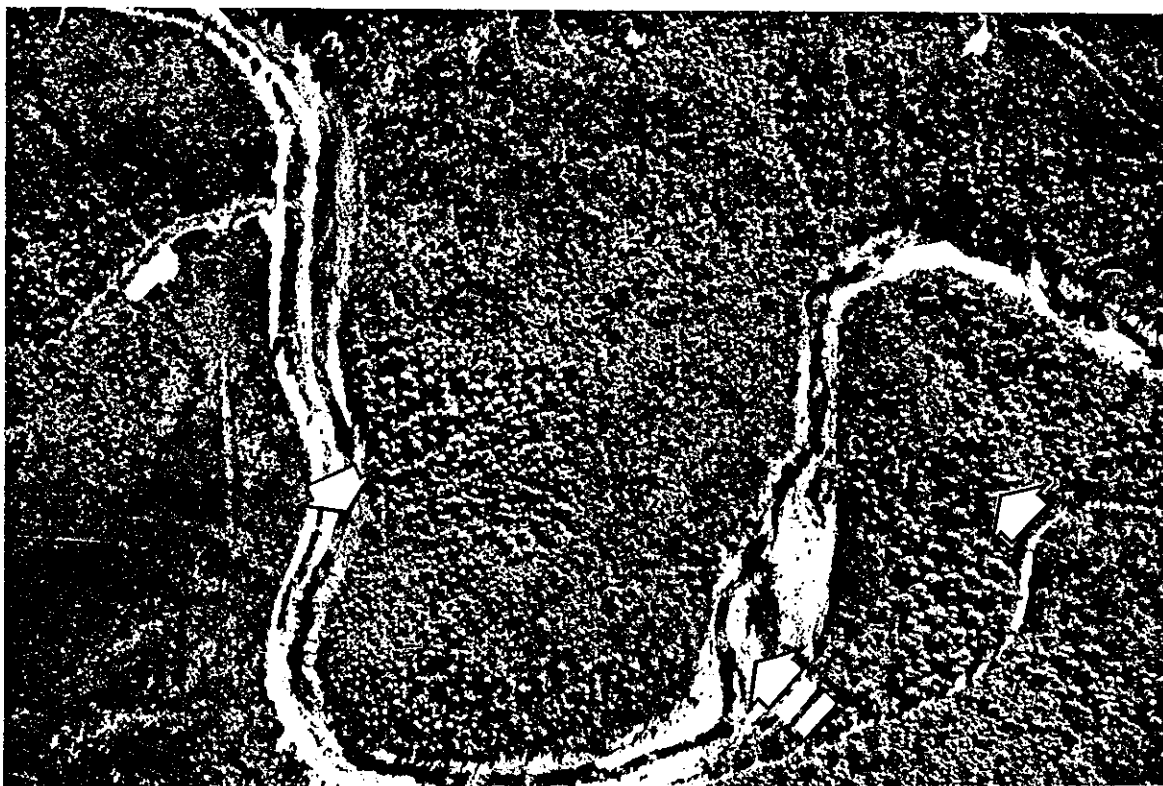

Aerial Photograph Used in Rating
Visibility of River Through Vegetation

Rating Visibility

REFERENCES

- Aerospace Corporation. MOSAIC: A System for Displaying a Proposed Modification Before Its Impact on the Environment; for U.S.D.A. Forest Service, Intermountain Forest and Range Experiment Station, 1977.
- American Society of Photogrammetry. DIGITAL TERRAIN MODELS (DTM) SYMPOSIUM, 9-11 May, 1978, St. Louis, Missouri.
- Appleyard, Donald and Kevin Lynch. VIEW FROM THE ROAD. M.I.T. Press, Cambridge, Mass., 1964.
- Appleyard, Donald, et al. ENVIRONMENTAL PLANNING AND SOCIAL SCIENCE. University of California, Berkeley, 1973.
- Battelle Pacific Northwest Laboratories. A TECHNIQUE FOR ENVIRONMENTAL DECISION MAKING USING QUANTIFIED SOCIAL AND AESTHETIC VALUES for the U.S. Atomic Energy Commission, Richland, Washington, February, 1974.
- Boster, Ron S. "Methodologies for Scenic Assessment", paper presented at VISUAL QUALITY AND THE COASTAL ZONE CONFERENCE/WORKSHOP. Syracuse, NY, May, 1975 in CONFERENCE PROCEEDINGS, SUNY, Syracuse, 1976.
- Bruce Howlett, Inc. ENVIRONMENTAL REPORT ADIRONDACK 115KV PROJECT, for Niagara Mohawk Power Corp., Syracuse, New York, 1975.
- Brush, Robert O. and Elwood L. Shafer. "Application of a Landscape-Preference Model to Land Management" in LANDSCAPE ASSESSMENT: VALUE, PERCEPTIONS, RESOURCES. Ervin H. Zube ed., Dowden, Hutchinson and Ross, Stroudsburg, 1975.
- Bureau of Public Roads. NATIONAL HIGHWAY FUNCTIONAL CLASSIFICATION MANUAL, for U.S. Department of Transportation, Federal Highway Administration, April, 1969.
- Carruth, David B., Randall Arthur and Douglas R. Snider. TRANSMISSION LINE VISUAL IMPACT: AN ASSESSMENT METHODOLOGY, for N.Y.S. Electric and Gas Corporation, Binghamton, New York, June, 1977.
- Colorado Department of Highways. I-70 IN A MOUNTAIN ENVIRONMENT, VAIL PASS, COLORADO, for U.S. Department of Transportation, Federal Highway Administration and USDA Forest Service, 1978.
- Environmental Systems Research Institute. LAND PLANNING TOOLS. Redlands, California.
- Fabos, Julius Gy and Stephanie J. Caswell. COMPOSITE LANDSCAPE ASSESSMENT: Assessment Procedures for Special Resources, Hazards and Development Suitability; Part II of the Metropolitan Landscape Planning Model (METLAND). Massachusetts Agricultural Experiment Station, University of Massachusetts, Amherst, 1976.

- Felleman, John P. COASTAL LANDFORMS AND SCENIC ANALYSIS: A Review of the Literature, with a Preliminary Examination of New York's Shoreline, for New York Sea Grant Institute, School of Landscape Architecture, SUNY, Syracuse, 1977.
- Felleman, John P. "Visibility Mapping in New York's Coastal Zone - A Case Study of Alternative Methods", paper presented at OUR NATIONAL LANDSCAPE CONFERENCE, 23-25 April, Lake Tahoe, Nevada, 1979.
- Gollub, James O.S. IDENTIFYING AND EVALUATING AESTHETIC ELEMENTS OF THE LANDSCAPE. Sea Grant Program Thesis/ Dissertation Series, USCSG-TD-02-76, October, 1976.
- Greitzer, Samuel L. ELEMENTARY TOPOGRAPHY AND MAP READING. McGraw-Hill Book Company, New York, 1944.
- Harper, David B., et al. HUDSON RIVER BASIN: Water and Related Land Resources Study, for Hudson River Basin Study Group, N.Y.S. Department of Environmental Conservation, Albany, New York, October, 1978.
- Hornbeck, Peter L. and Garland A. Okerlund, Jr. VISUAL VALUES FOR THE HIGHWAY USER: AN ENGINEER'S WORKBOOK, for U.S. Department of Transportation, U.S. Government Printing Office, Washington, D.C., 1973.
- Hough, Stansbury and Associates Limited. DESIGN GUIDELINES FOR FOREST MANAGEMENT, for Ontario Ministry of Natural Resources, Toronto, Ontario.
- Jacobs, Peter and Douglas Way. VISUAL ANALYSIS OF LANDSCAPE DEVELOPMENT. Graduate School of Design, Harvard University, Cambridge, Mass., 1969.
- Johnson, Christine G. MINERAL KING VISUAL ANALYSIS, for USDA Forest Service, California Region, San Francisco, July, 1974.
- Jones and Jones. ESTHETICS AND VISUAL RESOURCE MANAGEMENT FOR HIGHWAYS, for U.S. Department of Transportation and Federal Highway Administration, Seattle, Washington, October, 1977.
- Jones and Jones. VISUAL IMPACT OF HIGH VOLTAGE TRANSMISSION FACILITIES IN NORTHERN IDAHO AND NORTHWESTERN MONTANA, for Bonneville Power Administration, Portland, Oregon, 1976.
- Jones and Jones. VISUAL IMPACT STUDY: Statement of Findings Alternative Closed Cycle Cooling Systems Indian Point Nuclear Generating Plant, for U.S. Nuclear Regulatory Commission, November, 1975.
- Kobayashi, Koichi. "Environmental Analysis of Central Ohio", paper presented at VISUAL QUALITY AND THE COASTAL ZONE CONFERENCE/WORKSHOP, May, 1975 in CONFERENCE PROCEEDINGS, Syracuse, 1976.

Kunit, Eugene R. and Karen S. Calhoon. SMITH RIVER HIGHWAY VISUAL ANALYSIS, for USDA Forest Service, February, 1973, reprinted, 1975.

Landscape Evaluation Research Project. LANDSCAPE EVALUATION. University of Manchester, Manchester, 1976.

Landscapes Limited. EDAP: ENVIRONMENTAL DECISION ALIGNMENT PROCESS. Madison, Wisconsin, 1973.

Litton, R. Burton, Jr. FOREST LANDSCAPE DESCRIPTION AND INVENTORIES: A Basis for Land Planning and Design, for USDA Forest Service, Pacific Southwest Forest and Range Experiment Station, 1968.

Litton, R. Burton, Jr. LANDSCAPE CONTROL POINTS: A Procedure for Predicting and Monitoring Visual Impacts, for USDA Forest Service, Pacific Southwest Forest and Range Experiment Station, 1973.

Litton, R. Burton, Jr. et al. WATER AND LANDSCAPE: An Aesthetic Overview of the Role of Water in the Landscape. Water Information Center, Inc., Port Washington, New York, 1974.

Myklestad, Eric and J. Alan Wagar. PREVIEW: A Computer Aid for Visual Management of Forested Landscapes, for USDA Forest Service, November, 1975.

National Cartographic Information Center. DIGITAL TERRAIN TAPES, for U.S. Department of the Interior.

Newman, William M. and Robert F. Sproull. PRINCIPLES OF INTERACTIVE COMPUTER GRAPHICS. McGraw-Hill Book Company, New York, 1973.

New York Sea Grant Institute. VISUAL QUALITY AND THE COASTAL ZONE, Proceedings of a Conference/Workshop, 29-30 May, 1975. David B. Harper and John D. Warbach eds. Syracuse, New York, 1976.

New York State Department of Transportation. 1980 HIGHWAY FUNCTIONAL CLASSIFICATION SYSTEM. Albany, New York, January, 1976.

New York State Office of Planning Services. LUNR - Land Use and National Resource Inventory of New York State. Albany, New York, November, 1974.

Nickerson, Devon B. "Sightline, Perspective Plot, Scope-Three Desktop Computer Programs for Forest Landscape Design", in JOURNAL OF FORESTRY, January, 1979, pp. 14-17.

Pearson, Frank J. MODERN MILITARY MAP READING AND SKETCHING. George Banta Publishing Company, Menasha, Wisconsin.

Penzien, John, Frank J. Bundschuh, Jr. and Paul R. Los. HIGHWAY PHOTOMONTAGE MANUAL, for U.S. Department of Transportation, Federal Highway Administration, Region 15, Demonstration Projects Division, Arlington, Virginia, revised February, 1978.

- Pitz, Andrew D. "A Preliminary Process for Sequential Aesthetic Assessment of Rivers", Master's Thesis, State University of New York, Syracuse, 1977.
- Pragnell, Reginald C. SCENIC ROAD: A Basis for Its Planning, Design and Management, for USDA Forest Service, Division of Engineering, second edition, March, 1970.
- Reeves, Robert G. L. MANUAL OF REMOTE SENSING. American Society of Photogrammetry, Falls Church, Virginia, 1975.
- Research Planning and Design Associates, Inc. NORTH ATLANTIC REGIONAL WATER RESOURCE STUDY, Appendix N: Visual and Cultural Environment, Amherst, Mass., 1972.
- Roy Mann Associates. AESTHETIC RESOURCES OF THE COASTAL ZONE, for NOAA Office of Coastal Zone Management, July, 1975a.
- Roy Mann Associates. LANDSCAPE CONCEPT DEVELOPMENT FOR CONFINED DREDGED MATERIAL SITES, for Environmental Effects Laboratory, U.S. Army Engineer Waterways Experiment Station, Vicksburg, Mississippi, December, 1975.
- Roy Mann Associates. PEER REVIEW OF THE EVALUATION OF HART AND MILLER ISLANDS AND ALTERNATIVES FOR DREDGED MATERIALS DISPOSAL, for State of Maryland, Department of Natural Resources, July, 1975 b.
- Salisbury, Robin. "Landscape Architectural Models". State University of New York, School of Landscape Architecture, Syracuse, 1975.
- Sampson, Robert J. SURFACE II GRAPHICS SYSTEM. Kansas Geological Survey, Lawrence, Kansas, revised, 1978.
- Shafer, Elwood L. Jr. "Perception of Natural Environments", in ENVIRONMENT AND BEHAVIOR, June, 1966, pp. 71-82.
- Steinitz, Carl and Merlyn Paulson. "A Visual Quality Analysis Model Applied to the Coastal Zone", paper presented at VISUAL QUALITY AND THE COASTAL ZONE CONFERENCE/WORKSHOP, Syracuse, 29-30 May, 1975, in CONFERENCE PRECEEDINGS, Syracuse, 1976.
- Steinitz, Carl et al. SIMULATING ALTERNATIVE POLICIES FOR IMPLEMENTING THE MASSACHUSETTS SCENIC AND RECREATIONAL RIVERS ACT: The North River Demonstration Project. Landscape Architecture Research Office, Graduate School of Design, Harvard University, January, 1978.
- Steinitz Rogers Associates, Inc. VISUAL RESOURCE EVALUATION, for USDA Soil Conservation Service, Lisle, Illinois, April, 1977.
- Travis, Michael R. et al. VIEWIT: Computation of Seen Areas, Slope and Aspect, for USDA Forest Service, Pacific Southwest Forest and Range Experiment Station, 1975.

Tucker, T.C. CATCH: Computer Assisted Topography, Cartography and Hypsography, Part IV, for U.S. Department of Commerce, Oak Ridge National Laboratory, Oak Ridge, Tennessee, June, 1976.

USDA Forest Service. FOREST LANDSCAPE MANAGEMENT, VOLUME 1. USDA Forest Service, Northern Region, revised, February, 1972.

USDA Forest Service. FUNDAMENTALS OF DIGITIZING, EM 7140-3 Washington, D.C., November, 1978.

USDA Forest Service. NATIONAL FOREST LANDSCAPE MANAGEMENT, VOLUME 2, CHAPTER 1. USDA Forest Service, Agricultural Handbook No. 462, April, 1974.

US Geological Survey. LAND USE AND LAND COVER and Associated Maps, US Department of the Interior, 1978-261-226/20.

US Geological Survey. TOPOGRAPHIC MAP INFORMATION AND SYMBOLS, US Department of the Interior, September, 1972.

US Nuclear Regulatory Commission. FINAL ENVIRONMENTAL STATEMENT FOR MONTAGUE NUCLEAR POWER STATION UNITS 1 AND 2, February, 1977.

Van Dyke, Thomas, UPPER MISSOURI RIVER: Mapping Scenic Boundaries and Visual Vulnerability with VIEWIT, for Bureau of Land Management, Montana State Office, 1977.

Vander Ham, R.J.I.M. and J.A.M.E. Iding. A LANDSCAPE TYPOLOGY SYSTEM BASED ON VISUAL ELEMENTS. Department of Landscape Architecture, Agricultural University, Wageningen, Netherlands, November, 1971.

Viohl, Richard C., Jr. "Jamaica Bay: Assessing the Visual Quality of a Coastal Area", Master's Thesis, State University of New York, Syracuse, August, 1977.

Wagar, J. Alan. "DEFTOM Instructions", mimeograph, 30 September, 1977.

Way, Douglas and James Knode. "Visual Color Absorptive Levels in Typical Vegetative Association", Appendix IIIA in Section III of QUALITATIVE VALUES IN ENVIRONMENTAL PLANNING: A Study of Resource Use in Urbanizing Watersheds, by Peter Rogers and Carl Steinitz, Department of Landscape Architecture Research Office, Harvard University, October, 1969.

Wirth Associates. PHASE TWO CORRIDOR STUDIES SUNDESERT NUCLEAR PROJECT TRANSMISSION SYSTEM ENVIRONMENTAL STUDY, for San Diego, Gas & Electric Co., Calif., Nov., 1976.

Zube, Ervin, et al. LANDSCAPE ASSESSMENT: VALUE, PERCEPTIONS AND RESOURCES. Dowden, Hutchinson and Ross, Inc., Stroudsburg, PA., 1975.

Zube, Ervin, David G. Pitt and Thomas W. Anderson. PERCEPTION MEASUREMENT AND SCENIC RESOURCES in the Southern Connecticut River Valley, Institute for Man and Environment, University of Massachusetts, Amherst, 1974.