

Metody studia buněčné signalizace

Vítězslav BRYJA

Ústav experimentální biologie, PŘF MU
&
Oddělení cytokinetiky, Biofyzikální ústav AV ČR



e brafish .m d

Wnt signalling

- eg. Wnt-1 or Wnt-3a



Consequences of β -catenin activation in the brain:

midbrain (Brn4-promotor)

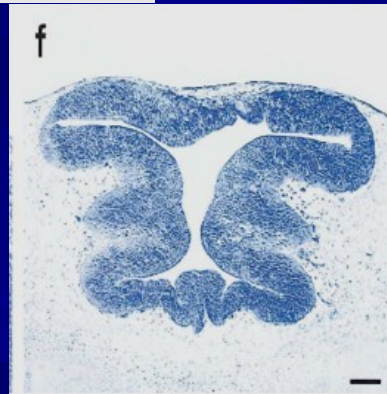
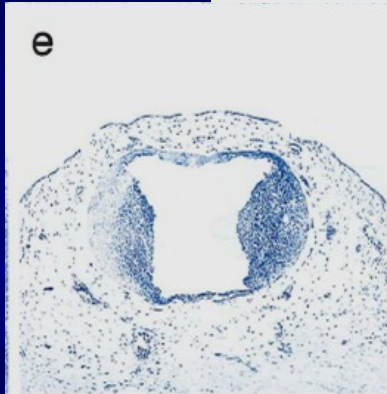
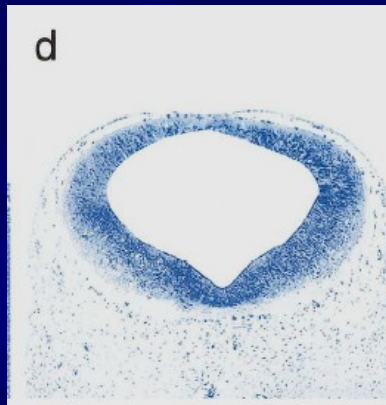

Zechner et al., 2003: Dev. Biol.;258:406-418.

cortex (nestin enhancer)

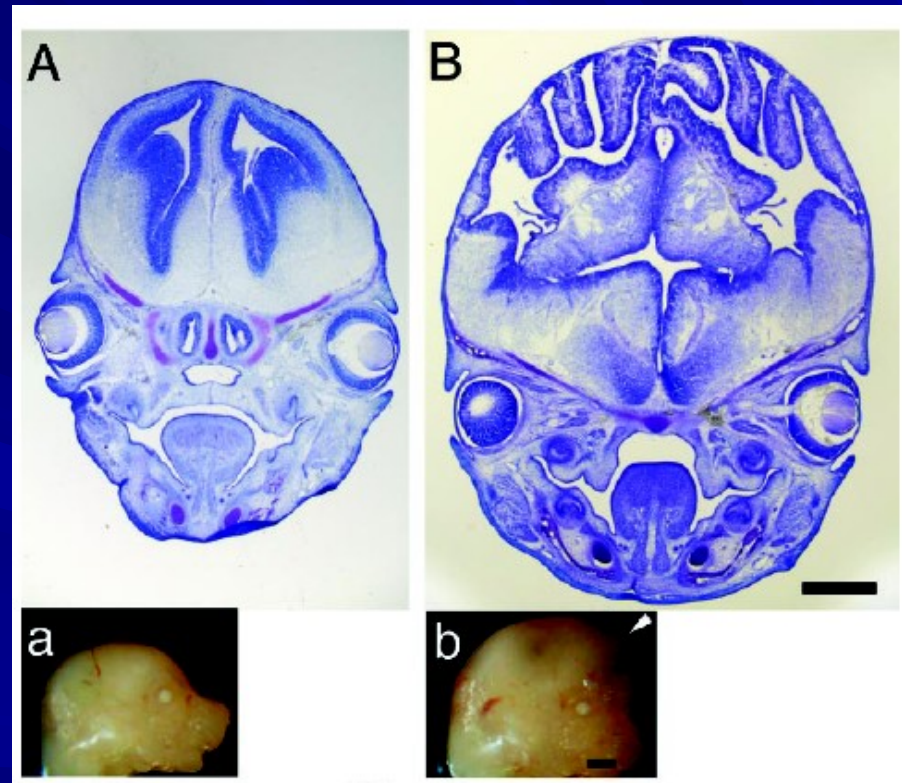

Chenn & Walsh, 2002: Science;297:365-369.

Non-canonical/PCP (Planar cell polarity) pathway defects cause neural tube closure phenotypes in mouse (and human)

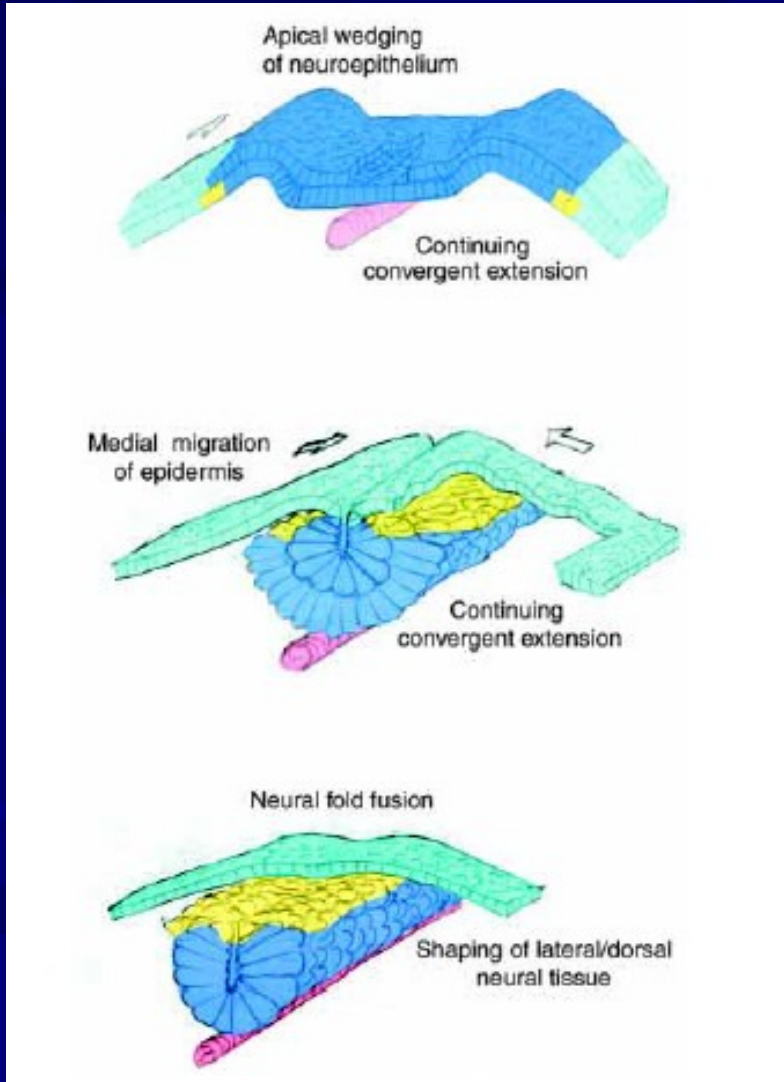

Exencephaly

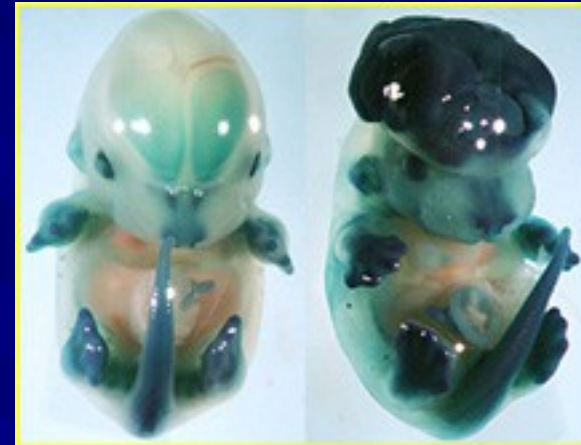

Open neural tube



Protilátka
(imunoglobulin)

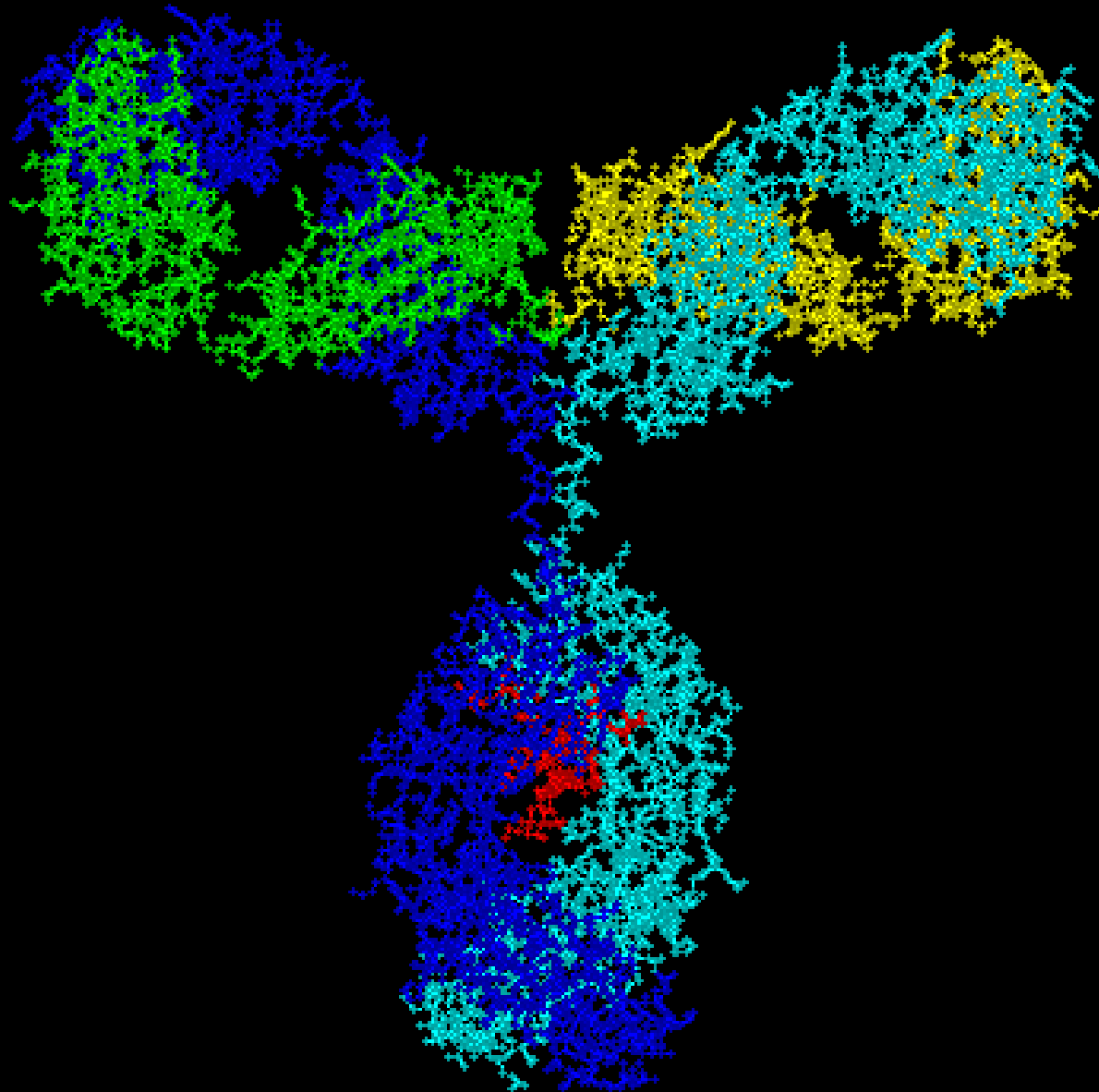

Metoda 1: Western blotting

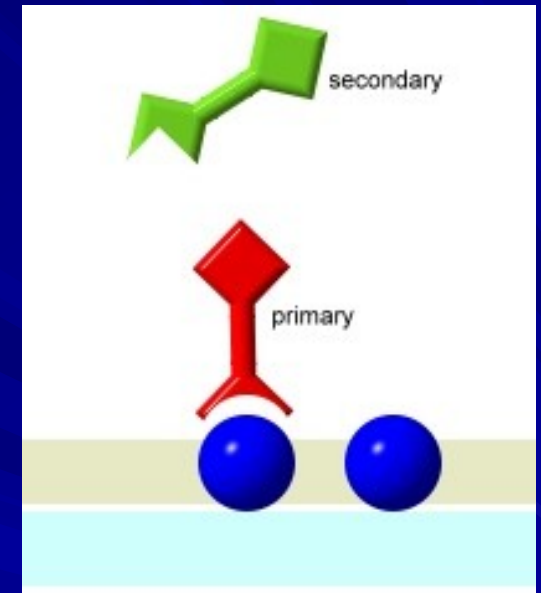
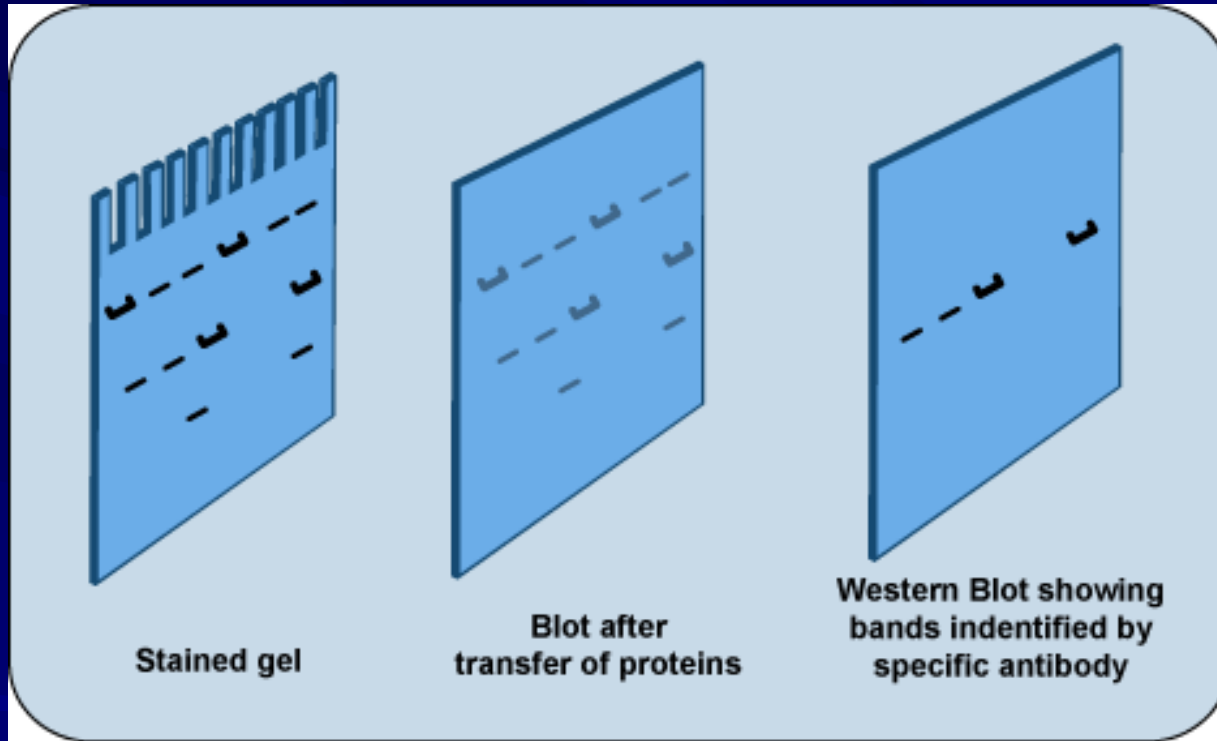

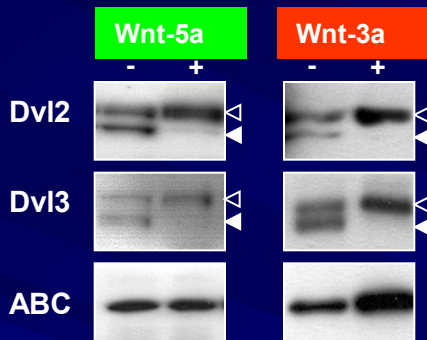

ABC – active β -catenin = β -catenin dephosphorylated on GSK3 target sites

Dvl – Dishevelled – activated by phosphorylation detected as phosphorylation dependent mobility shift

◁ PS-Dvl

Compound	Target	Concn	Activity
PTX	Galpha i/o	100 ng/ml	No
PDBu	PKC activator	1 μ M	No
Wortmannin	PI3K	50 nM	No
LY294002	PI3K	50 μ M	No
PD98059	MEK1/2	10 μ M	No
UO126	MEK1/2	10 μ M	No
SB203580	p38	10 μ M	No
JNKII inhib	JNK	6 μ M	No
Genistein	PKC	50 μ M	No
chelerythrine	PKC	10 μ M	No
Ro-31 8220	PKC	1 μ M	No
BIM I	PKC	500 nM	No
KN93	CamKII	10 μ M	No
I3M	GSK-3	2 μ M	No
Kenpauillone	GSK-3	6 μ M	No
H89	PKA	10 μ M	No
8-Br-cAMP	cAMP pathway activator	10 μ M	No
8CPT-2Me-cAMP	EPAC activator	30 μ M	No
SQ22536	Adenylyl cyclase	100 μ M	No
MDL12330	Adenylyl cyclase	10 μ M	No
PP2	Src-like	10 μ M	No
AG1276	EGFR	10 μ M	No
ET-18-OCH3	PLC	10 μ M	No
D4476	Casein kinase 1	100 μM	Yes
staurosporin	Ser/Thr kinases, PKC	2 μ M	No

D4476 (100 μ M)

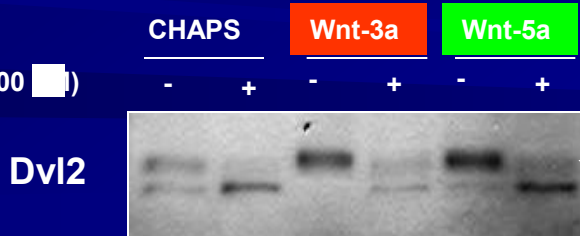

Both **Wnt-3a** and **Wnt-5a** activate Dvl2 and Dvl3 via casein kinase 1 (CK1)

Metoda 2: Immunoprecipitace

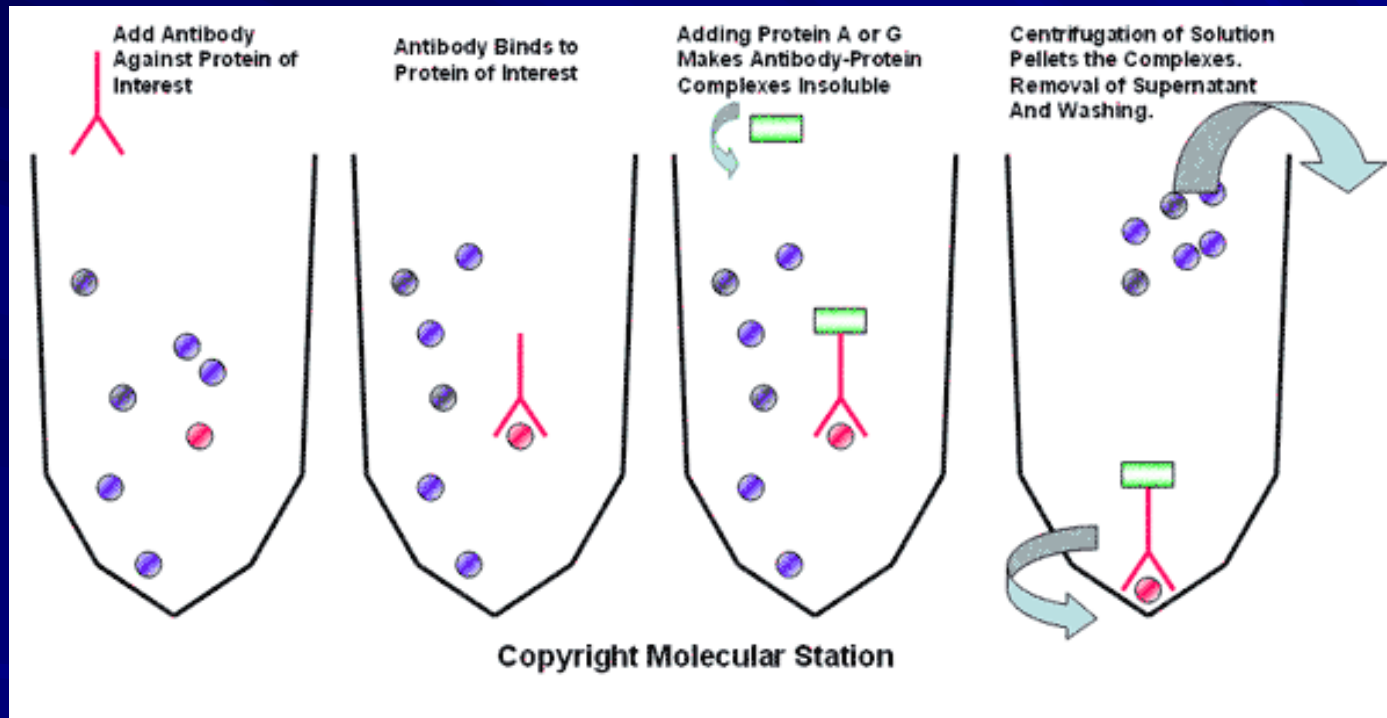

β -arrestin binds Dishevelled

Flag-Dvl3 constructs

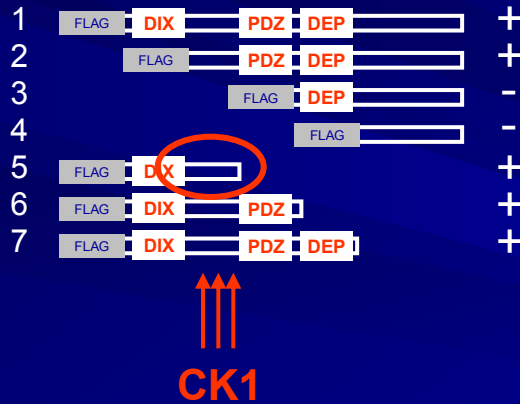

Flag-Dvl3 mutants

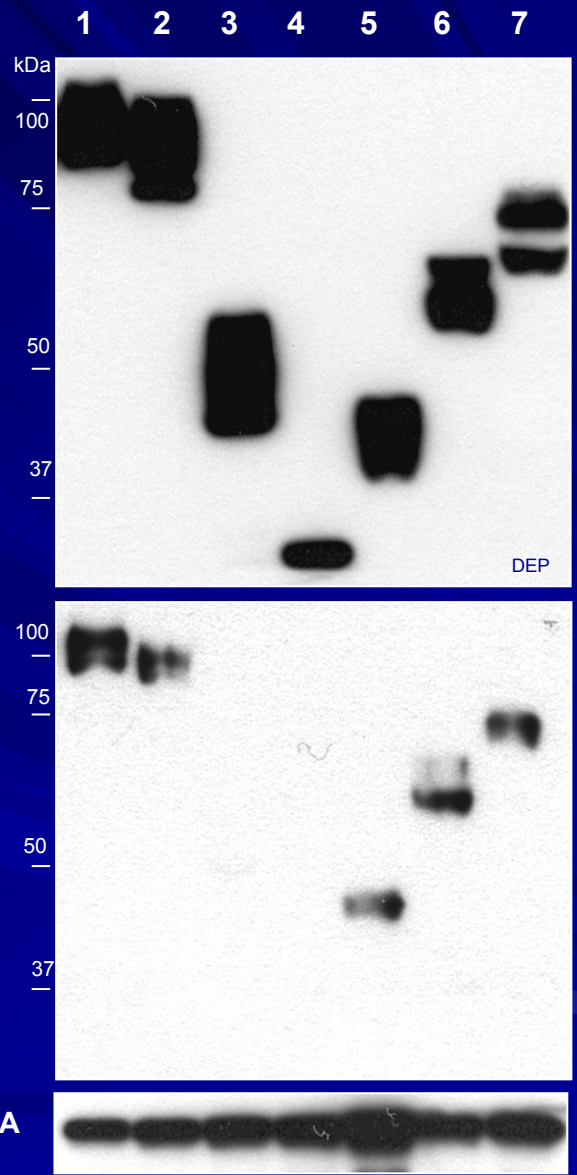

Metoda 3: Immunocytochemie

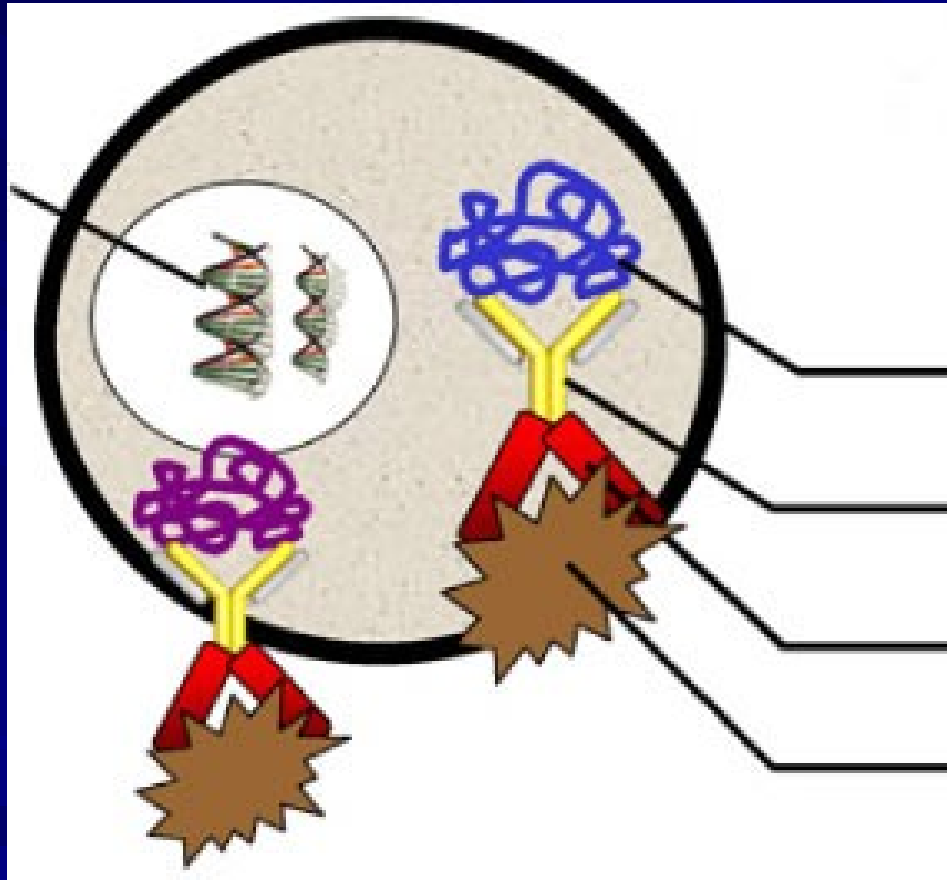

Fluorescenční proteiny

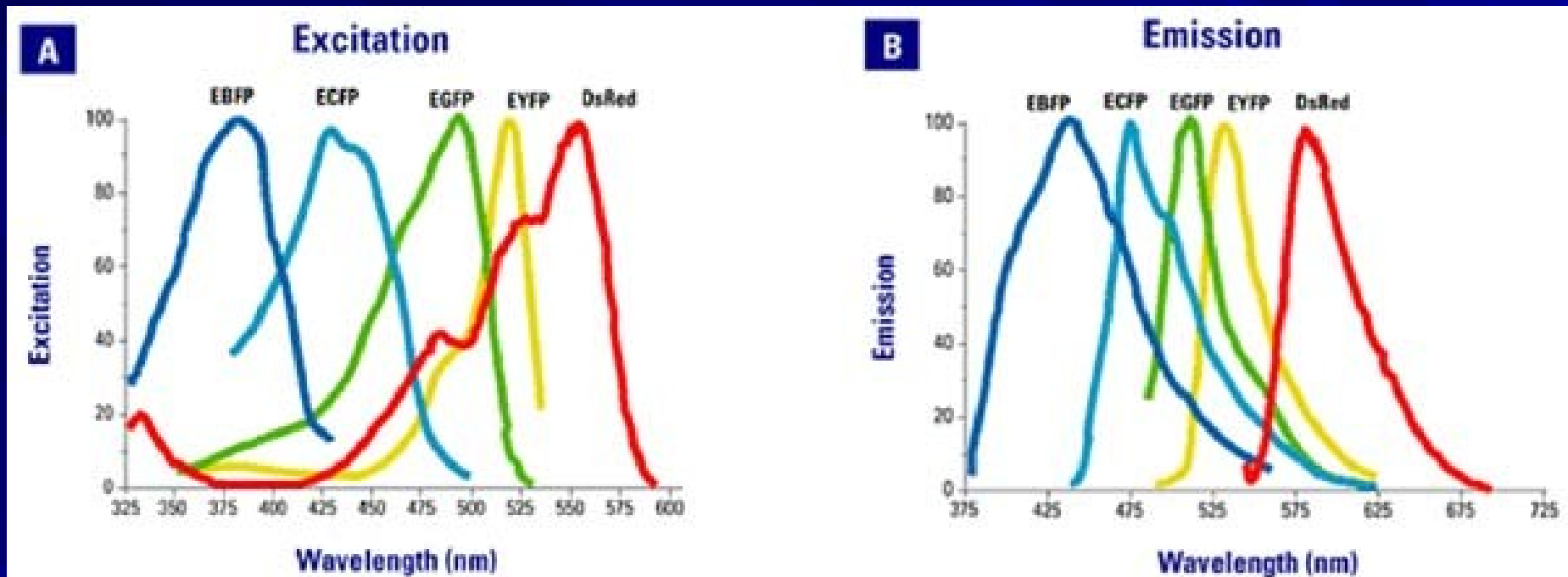

β -arrestin co-localizes with Dvl in the cytoplasm

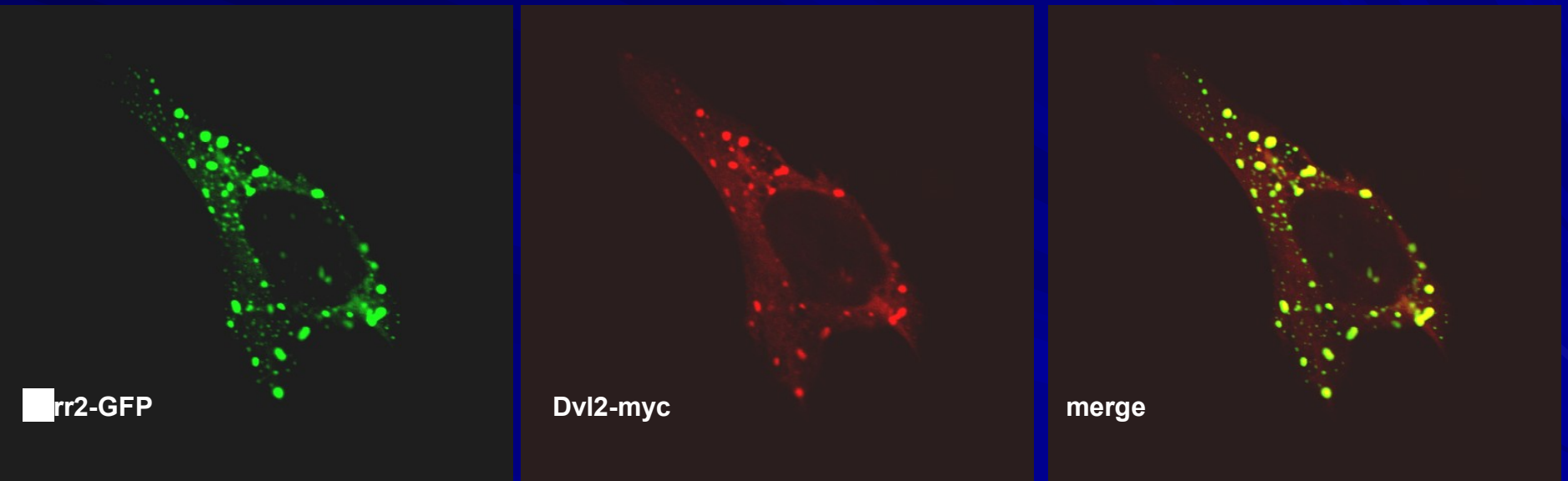

Metoda 4: Reportérové eseje

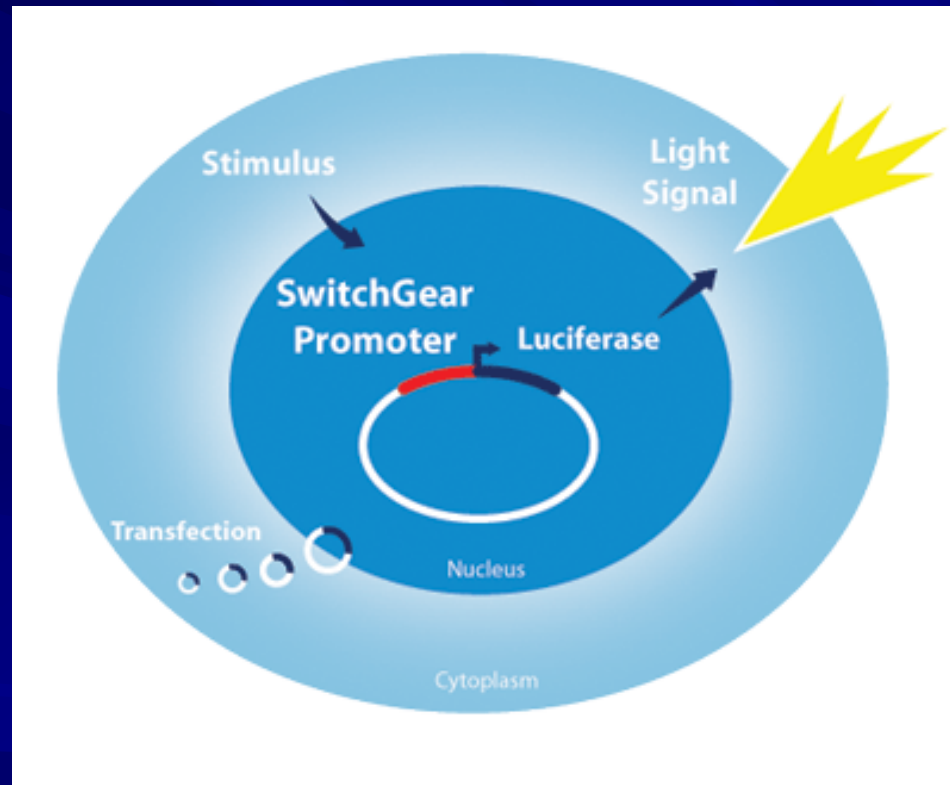

1. β -arrestin is required for β -catenin activation in vitro

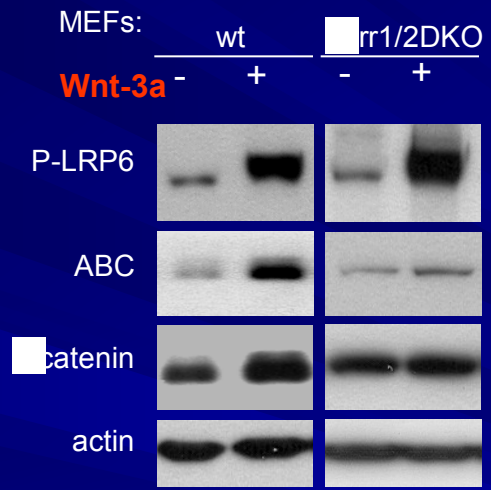
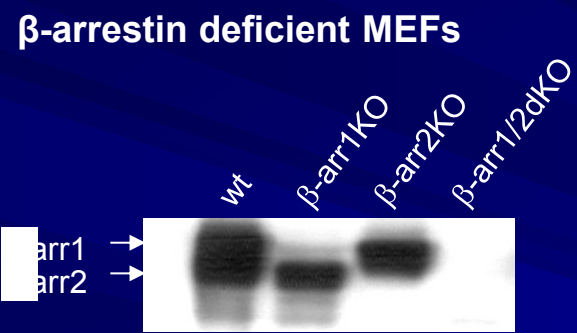

TopFlash reporter - β -catenin transcriptional activity

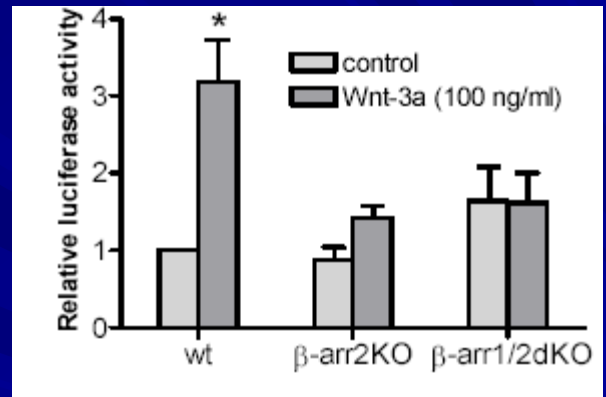

Is this relevant for Wnt signal transduction in vivo?

Metoda č. 5: Analýza in vivo - drápatka

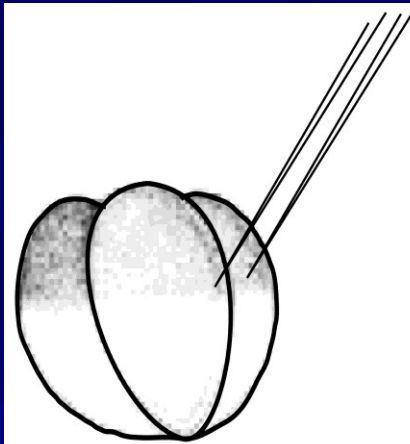

injection in 4-cell stage embryo
targets Dorsal Marginal Zone
affects primary axis formation (ventralization) and CE movements
Figures 2, 3, and Suppl Figure 1

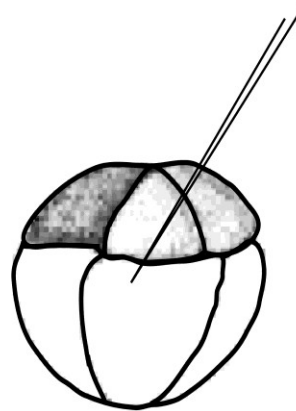

injection in 8-cell stage embryo
targets presumptive cardiac mesoderm
affects cardiac development, but avoids earlier effects on primary axis and CE
Figure 4

Is β -arrestin important for the Wnt/ β -catenin signalling in vivo?

β -arrestin knockdown in *Xenopus* (*axis duplication assay*):

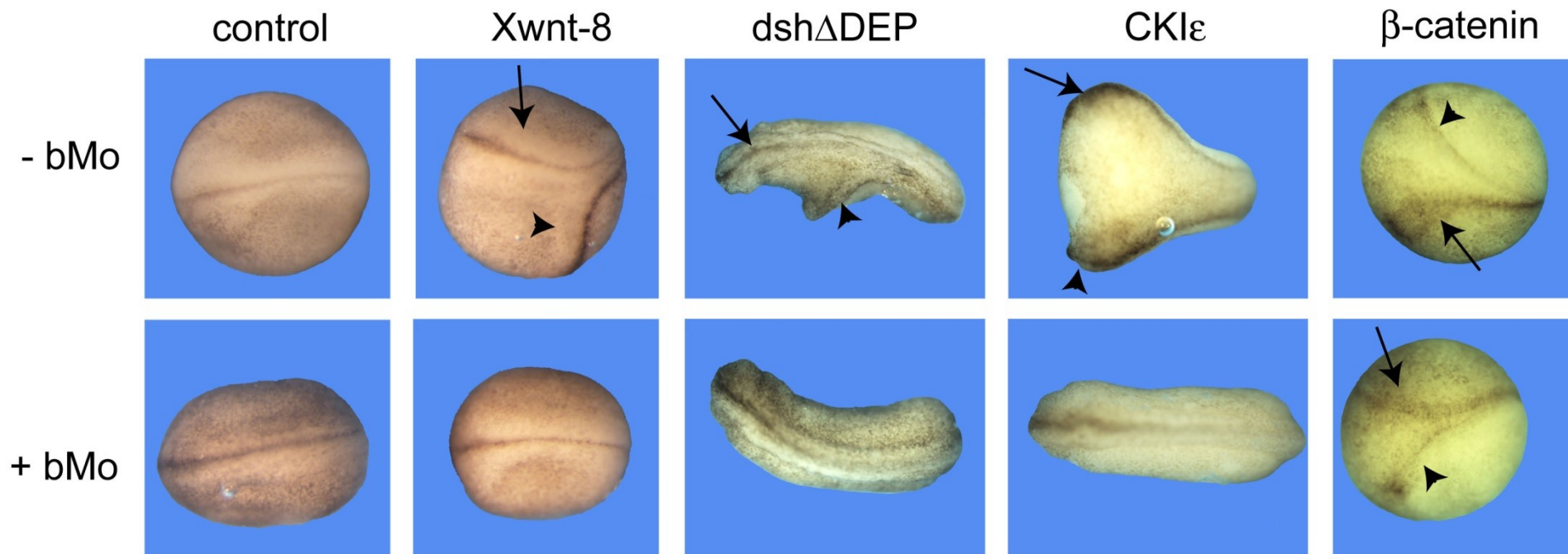

Keller explants (Xenopus)

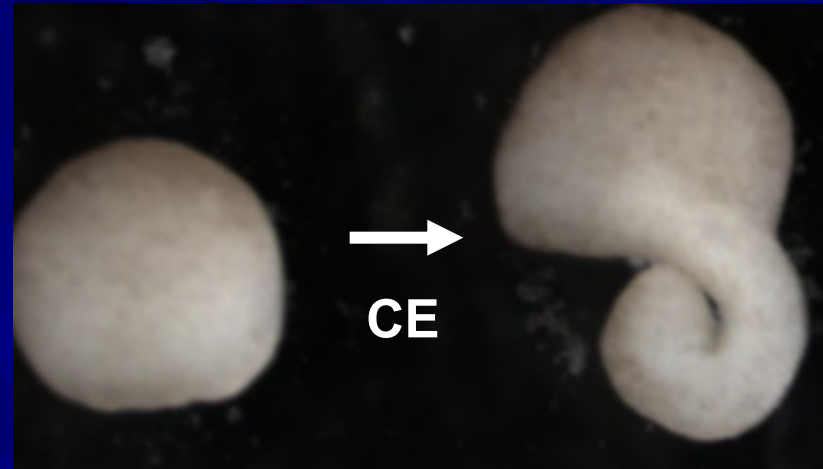
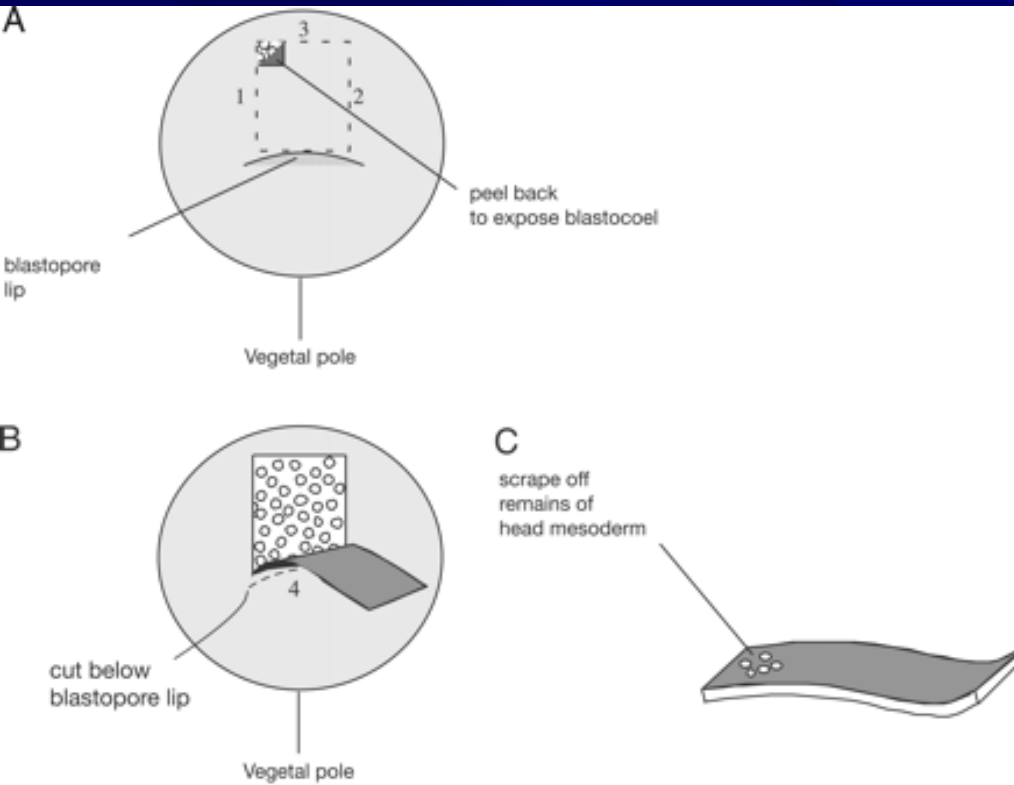

β -arrestin regulates convergent extension movements in vivo

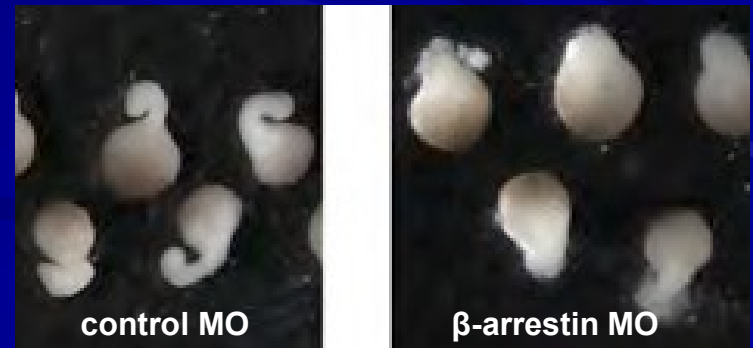

Metody č. 6: Genetické modifikace myši

Transgenní myš

Nobelova cena 2007

Mario R. Capecchi,
Martin J. Evans and
Oliver Smithies

za

„principles for
introducing specific
gene modifications in
mice by the use of
embryonic stem cells“

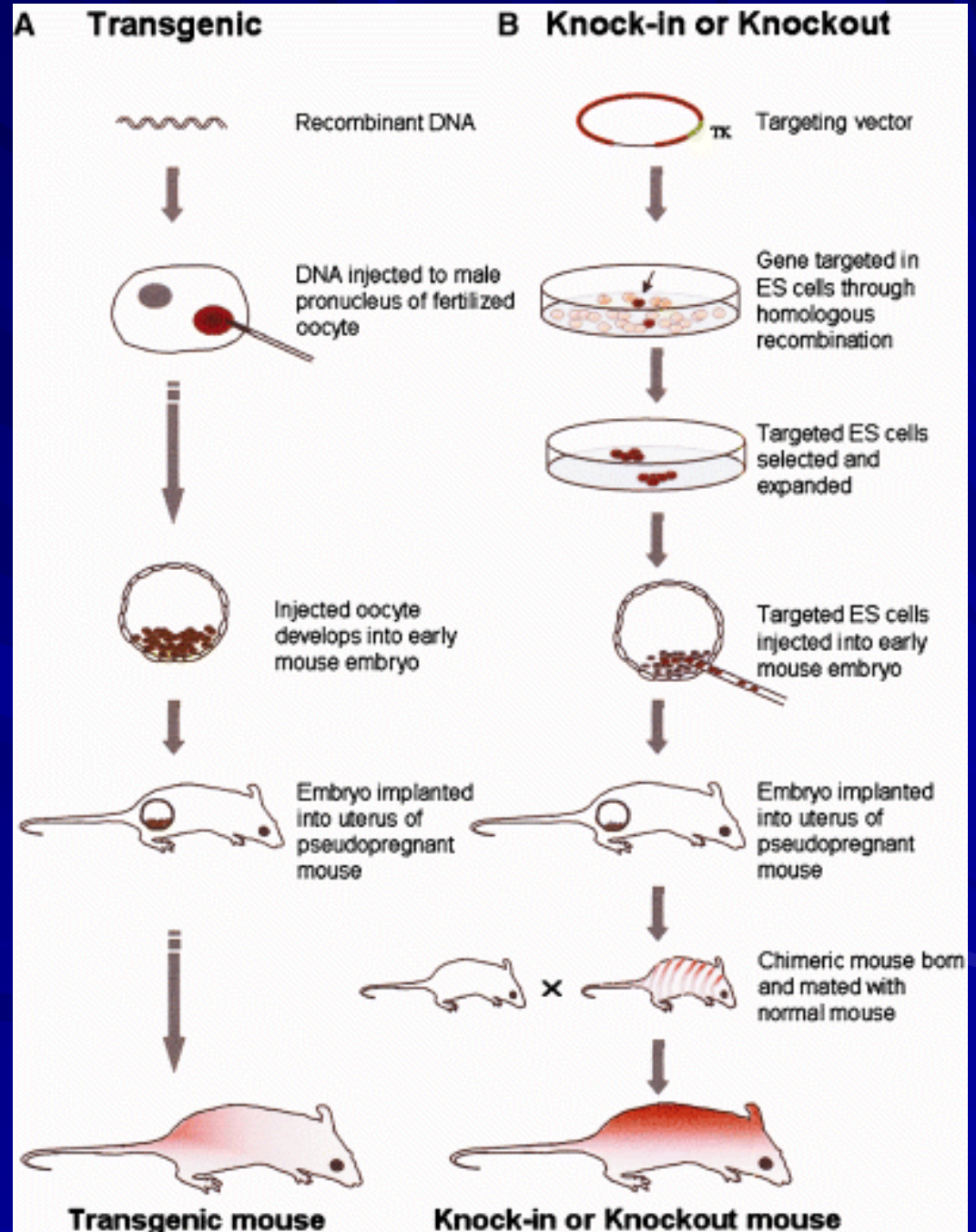

Lrp6 KO embryos display exencephaly....

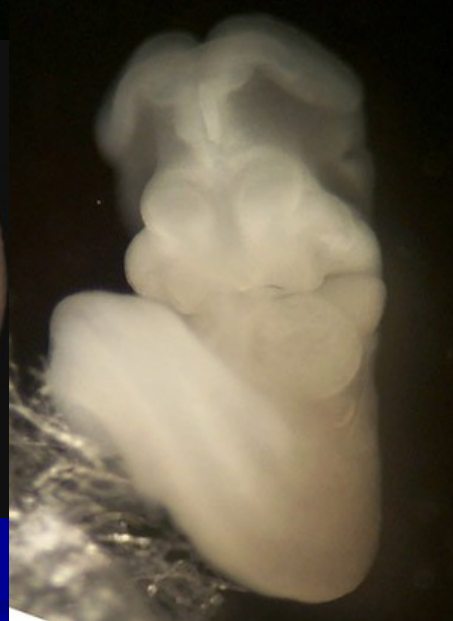
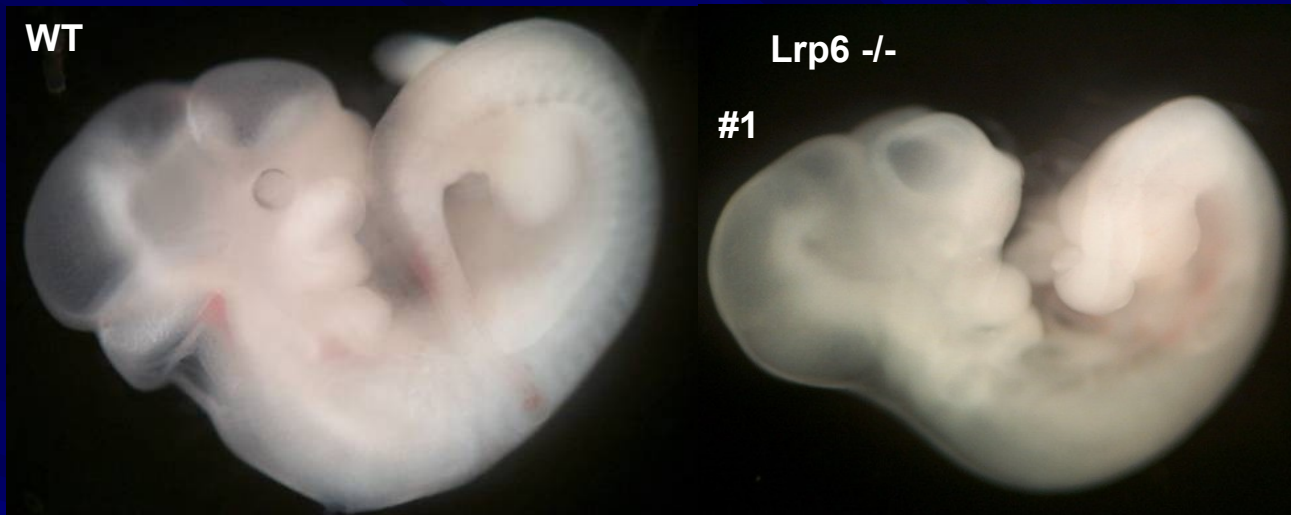

....which is rescued by loss of Wnt5a

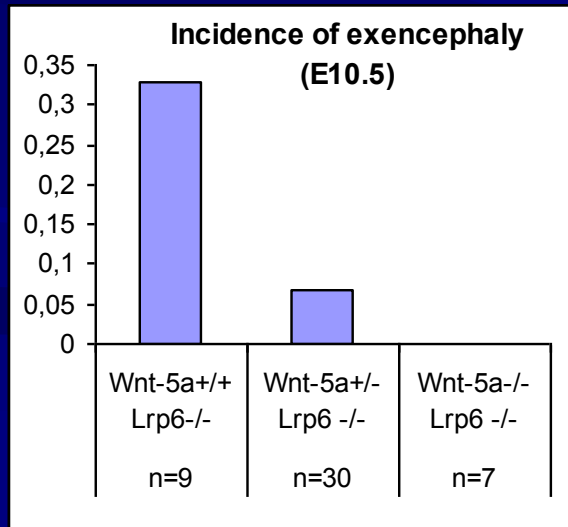

Metody č. 7: Afinity purifikace a hmotnostní spektroskopie

Afinitní purifikace

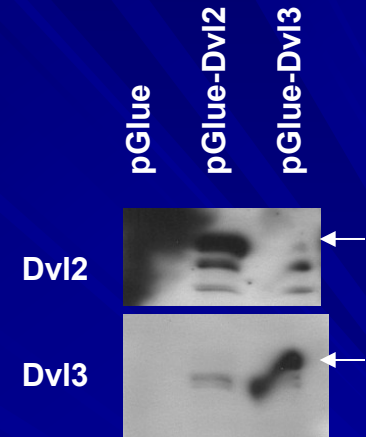
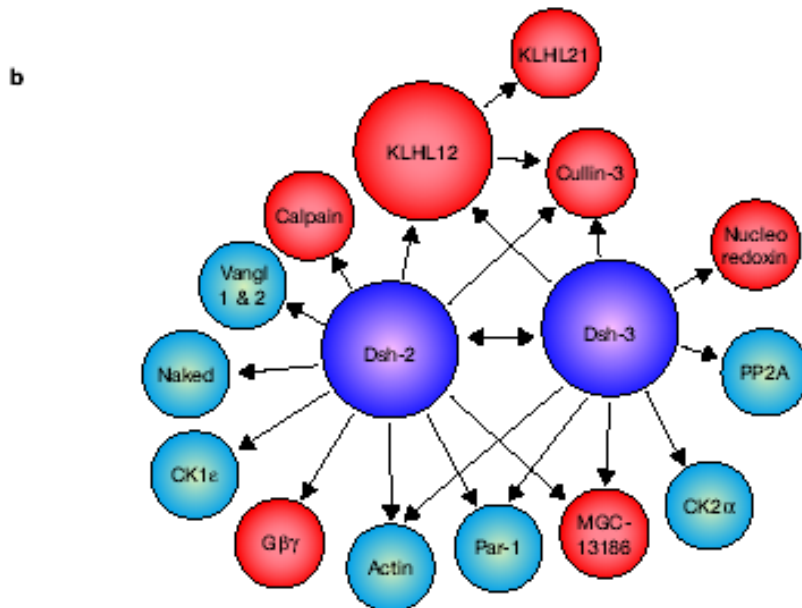
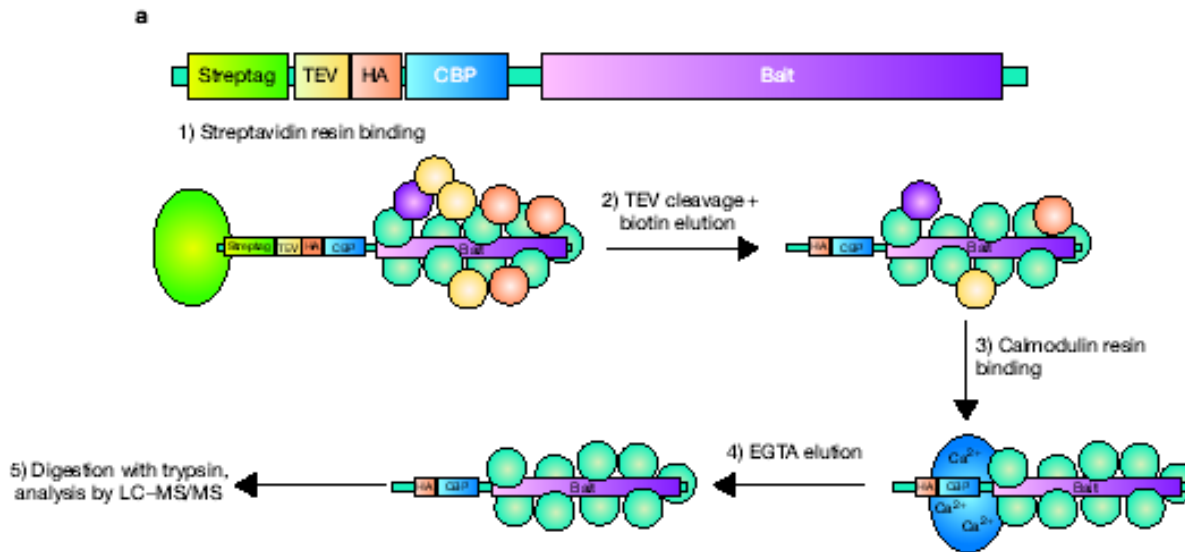

Hmotnostní spektroskopie (Mass Spec)

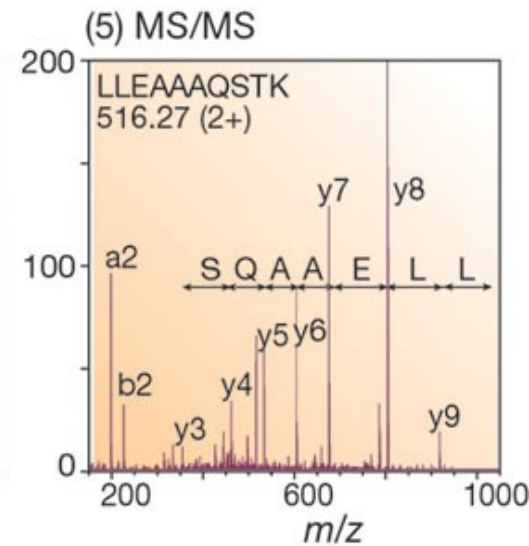
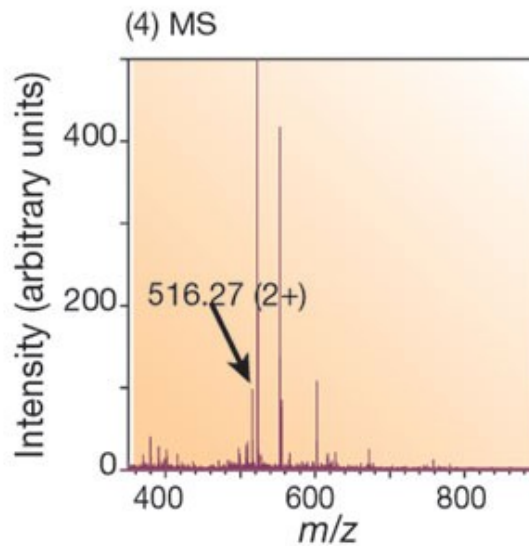
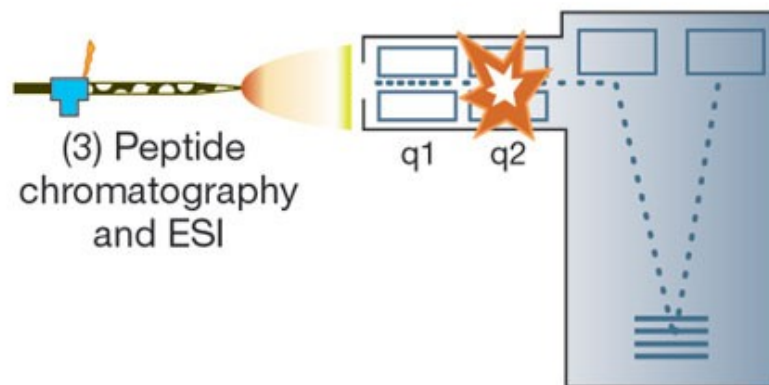
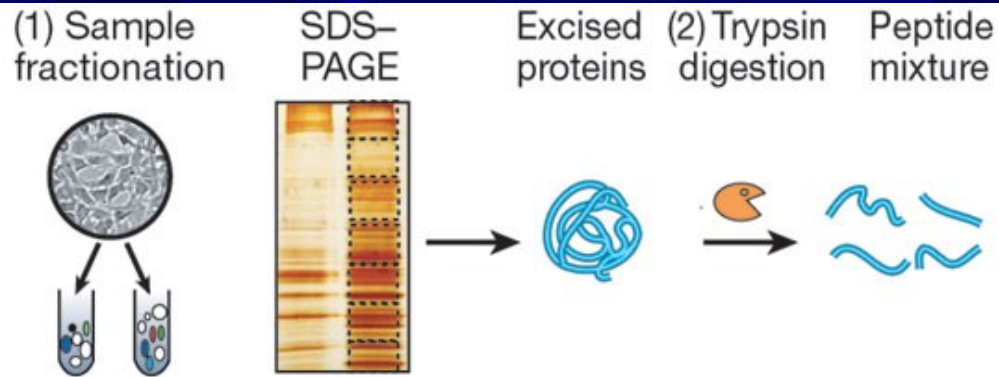

Děkuji za pozornost!

Celogenomové
techniky

Molekulární
mechanismus

Celoproteomové
techniky

