

Typography

Lukáš Žídek



https://en.wikipedia.org/wiki/Typography#/media/File:Pressing-16th_century.jpg

Purpose: to exchange information most efficiently

- Presentation of original results
- Reviewing literature
- Other purposes: education etc.

Students and typography:

- Writing theses (project reports etc.)
- Writing manuscripts
- Preparing poster presentation
- Preparing slides for oral presentation

Publishing in the era of hand-writing

- Hand-writing, using seals to print
 - ancient times
- Movable type
 - 11th century, China:
 - Bi Sheng (China, 1040) clay
 - Wang Zhen (China, 1298) wood
 - Choe Yun-ui (Korea, 1234) metal
 - 15th century, Europe
 - Johannes Gutenberg (Germany, 1439) lead
- ① Author: hand-writing → manuscript
- ② Typesetter: typesetting → form
- ③ Printer: printing → print



Publishing in the era of typewriter

Typewriter in practical use since 1870's
(USA: E. Remington and Sons, 1873 - QWERTY keyboard)

- 1 Author: typing → "manuscript"
- 2 Typesetter: typesetting → form
- 3 Printer: printing → print



Publishing in the era of computer

Desktop publishing available since 1980's
(USA: Apple Macintosh, 1985)

- 1 Author: typing (text editor) → "manuscript"
- 2 Author/publisher: "typesetting" (typography software) →
- 3 Author/publisher: "printing" → "print" electronic/hardcopy

Many historical "relics" from the hand-writing/typewriter times



- Office packages, combined with text editors
(e.g. Microsoft Office, OpenOffice, LibreOffice)
- Typesetting software (e.g. T_EX)
L^AT_EX: document preparation system using T_EX

- Typeface / typeface family (Czech: rodina písma)
- Style (Czech: řez)
- Weight (Czech: váha/duktus)
- Size (Czech: stupeň)

Font = "all the variations of a typeface of a given size possible"
(J. Tyner, Principles of Map Design, Guilford Press, 2010, p. 51)

Different fonts of the same typeface (Adobe Bookman):

different style:

- Adobe Bookman
- *Adobe Bookman*
- ADOBE BOOKMAN

different weight:

- Adobe Bookman
- **Adobe Bookman**

different size:

- Adobe Bookman
- Adobe Bookman
- Adobe Bookman

Serif × Sans-serif

Use:

- Serif fonts are preferred for *lengthy printed text*. The serifs create a "line" which leads the eyes. Use in the main text of your thesis.
- Sans-serif fonts are more legible for *individual words*. Use as labels in figures, in structures of chemical compounds etc.

Proportional × Monospace

Use:

- Use proportional fonts as standard.
- Monospace fonts were developed for typewriters.
Use for amino acid/nucleotide sequences.
Use to emulate computer terminal in printed text.

What influenced font design

- Tradition
- Legibility (ability to recognize individual letters)
- Readability (ease of reading and understanding a text)
- Beauty
- Physical requirements (casting the sorts)



Adobe Palatino

abcdefghijklmnopqrstvwxyz

Adobe Bookman

abcdefghijklmnopqrstvwxyz

Nice, but not ideal for scientific text

Adobe Times

abcdefghijklmnopqrstuvwxy

Popular, acceptable for scientific text

Computer Modern Roman

abcdefghijklmnopqrstuvwxy

Designed for computer typesetting.

Ideal for scientific text (especially for math symbols).

Examples of typefaces

Adobe Courier

abcdefghijklmnopqrstuvwxyz

Example of a monospaced font

Adobe Helvetica

abcdefghijklmnopqrstuvwxyz

Example of a sans-serif font

- Upright (Roman)
Use: standard
- *Italics*
Use: emphasis, foreign phrases (*vide supra*), headings, biology (genus and species: *E. coli*), mathematics
- **SMALL CAPITALS**
Use: abbreviations (10 PM)
- **Bold**
Use: headings, mathematics

If not necessary, do not design your own style of headings.
Use templates or default setting (if template is not available).

E.g. in L^AT_EX: using `\section`, `\emph`, **not** `\textbf`, `\textit`

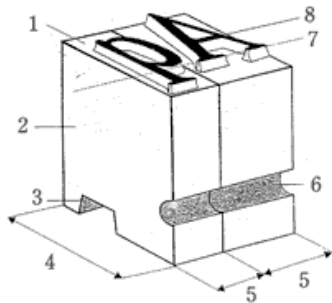

4: sort height

Point size = height of the *sort* (*type*)

Units:

European point (Didôt 1770): $1/864$ royal foot ≈ 0.376 mm

American $\text{T}_{\text{E}}\text{X}$ point (Knuth 1978): $1/72.72$ in ≈ 0.351 mm

American PostScript point (Warnock 1982): $1/72$ in ≈ 0.353 mm

Choice of size

- Optimal height of letter: reading distance divided by 250

Purpose	height	size
Comfortable reading	1.4–1.8 mm	10 pt
Manuals etc.	2.0–2.4 mm	10–12 pt
Posters	6.0–8.0 mm	18–30 pt

- Optimal length of line (movement of eyes): 2–3 "alphabets"

abcdefghijklmnopqrstuvwxyabcdefghijklmnopqrstvwxyz

small size \Rightarrow two columns

- Optimal line spacing (*leading*, pronounce "ledding"): 1.2
- Optimal margins: "total" margin $t = 20$ to 40% pagewidth
page width = paper width minus binding (7 mm–15 mm)
two-sided: top $0.5 t$, bottom $0.7 t$, inside $0.4 t$, external $0.6 t$
one-sided: top $0.5 t$, bottom $0.7 t$, left $0.5 t$, right $0.5 t$

Adjusting horizontal spacing

- Ligature

Difficult × Difficult

- Italic correction

Who is *Josef*? × Who is *Josef*?

- Kerning

LAVATORY × LAVATORY

Justification

All Gaul is divided into three parts, one of which the Belgae inhabit, the Aquitani another, those who in their own language are called Celts, in our Gauls, the third. All these differ from each other in language, customs and laws. The river Garonne separates the Gauls from the Aquitani; the Marne and the Seine separate them from the Belgae. Of all these, the Belgae are the bravest, because they are furthest from the civilization and refinement of our Province, and merchants least frequently resort to them, and import those things which tend to effeminate the mind; and they are the nearest to the Germans, who dwell beyond the Rhine, with whom they are continually waging war; for which reason the Helvetii also surpass the rest of the Gauls in valor, as they contend with the Germans in almost daily battles, when they either repel them from their own territories, or themselves wage war on their frontiers.

flushed left
no hyphenation

All Gaul is divided into three parts, one of which the Belgae inhabit, the Aquitani another, those who in their own language are called Celts, in our Gauls, the third. All these differ from each other in language, customs and laws. The river Garonne separates the Gauls from the Aquitani; the Marne and the Seine separate them from the Belgae. Of all these, the Belgae are the bravest, because they are furthest from the civilization and refinement of our Province, and merchants least frequently resort to them, and import those things which tend to effeminate the mind; and they are the nearest to the Germans, who dwell beyond the Rhine, with whom they are continually waging war; for which reason the Helvetii also surpass the rest of the Gauls in valor, as they contend with the Germans in almost daily battles, when they either repel them from their own territories, or themselves wage war on their frontiers.

justified
no hyphenation
"rivers"!

All Gaul is divided into three parts, one of which the Belgae inhabit, the Aquitani another, those who in their own language are called Celts, in our Gauls, the third. All these differ from each other in language, customs and laws. The river Garonne separates the Gauls from the Aquitani; the Marne and the Seine separate them from the Belgae. Of all these, the Belgae are the bravest, because they are furthest from the civilization and refinement of our Province, and merchants least frequently resort to them, and import those things which tend to effeminate the mind; and they are the nearest to the Germans, who dwell beyond the Rhine, with whom they are continually waging war; for which reason the Helvetii also surpass the rest of the Gauls in valor, as they contend with the Germans in almost daily battles, when they either repel them from their own territories, or themselves wage war on their frontiers.

justified
hyphenation used

Orphans and widows

Single words/lines ending paragraphs/pages (*orphans*) and single lines opening pages (*widows*) should be avoided.

Example of a page with a widow and orphans:

this line ending a preceding paragraph is a widow line.

In this text, in this text, in this text, in this text, in this text, in this text, in this text, in this text, the next word is orphan

In this text, in this text, in this text, in this text, in this text, in this text, in this text, in this text, in this text, in this text, there is no problem.

But this line, beginning a new paragraph, is an orphan.

Avoid "poor man's solution"

- Use 5×5 , not 5×5
- Use $5 - 5$, not $5 - 5$
- Use 5 ± 1 , not $5 +/- 1$
- Use 5° , not 5^o
- Use $5 \mu\text{m}$, not 5um
- Use $1, 2, 3, \dots$, not $1, 2, 3, \dots$

You have a computer, not a typewriter

Confusing characters: - – —

- - **Hyphen**, (Unicode: U+002D, – in L^AT_EX)
Use: line breaks within words (soft hyphen, U+00AD) ,
compounded words (hand-written, tea-cup, bude-li,
Guth-Jarkovský, Brno-Slatina)
- – **En-dash** (U+2013, -- in L^AT_EX)
range (pages 10–20, May–July 2017)
Czech phrases like Chlast – slast. Chlast -- slast.
- — **Em-dash** (U+2014, --- in L^AT_EX)
Use: separates inserted clause/idea: She was tall—taller
than you are—and pretty.
- – **Minus sign** (U+2212, \$- in L^AT_EX)
–35 \$-35\$
+35 \$+35\$
60–35 \$60-35\$

- **' Apostroph** (' in \LaTeX)
Use: possessive (John's, Charles'),
omission (can't, Rock 'n' Roll), plural (1960's, dot the i's
and cross the t's)
- **' Prime** ($\text{\textasciicircumprime}$ in \LaTeX)
Use: feet, minutes ($10^{\circ} 15'$), chemistry (atom H1'),
mathematics, physics
- **Quotation mark**
"Friend" × 'Friend' × „Kamarád“

- **Space** (U+0020, SPACE in \LaTeX)
Use: normal space, line break allowed
- **Non-breaking space** (shown as █ here)
(U+00A0, ~ in \LaTeX , CTRL SHIFT SPACE in MS Word)
Use: Between numbers and units, in references to named parts of a document (Chapter █12, Figure █2), between a person's titles, forenames, surnames (Dr. █Smith, John █F. Kennedy, van █der █Waals), some combinations with math symbols (from 0 to █1), when break looks ugly ("orphans")
In Czech: also following prepositions K, k, O, o, S, s, U, u, V, v, Z, z and conjunctions A, I, i.
- **Thin space** (non-breaking, U+2009, \, in \LaTeX)
Use: 541 129 299 541\, 129\, 299, 5°, between numbers and other units (instead of U+00A0, debated)

5×10^{-3}

⇒ bla blabla bla bla blablalba bla bla blabla 5×10^{-3}

⇒ bla blabla bla bla blablalba blabl blabla 5×10^{-3}

5×10^{-3}

⇒ bla blabla bla bla blablalba bla bla blablalba
blabla 5×10^{-3}

⇒ bla blabla bla bla blablalba blabl bla blablalba
 5×10^{-3}

- **Mathematical italics**

variables, indices, functions: a , x , A_{kl}

- **Upright** (mathematical Roman), `\mathrm{ }` in L^AT_EX)

numbers: 1, 153.67, e^{-ikx}

subscripts/superscripts that are abbreviations, not indices:

D^{calc} , T_c

operators: $\cos \omega x$, $\log k$

differentials: dx

units: kg, MHz

- **Bold**

vectors: \mathbf{v}

Typeset equations, do not include them as figures!

Equations, tables, figures, etc.

Use cross-references (do not type "Figure 3", etc.)

(`\label{fig-gel}` and `\ref{fig-gel}` in \LaTeX ,
selecting "fig-gel" in Cross-reference dialog box in MS Word)

Bibliographic references

Use style of the journal or style typical for the field

- numbers, reference list at the end
in the order as they appear in the text
- numbers, references as footnotes
in the order as they appear in the text
- names, reference list at the end
in the alphabetical order

Use **bibliographic databases**:

- Software: EndNote, BibTex,
- Use database but create stand-alone list of references
(the database is usually not supplied to publisher)
- You can maintain a single database for all your papers.
- Outputs from Web Of Science

- Caption above table
- Footnotes below table
- No vertical lines
- No horizontal lines between rows

Table 1: Rodents

Number	Animal		<i>m/g</i>
1	white mouse	<i>Mus musculus</i> ^a	30
2	rat	<i>Rattus rattus</i>	250

^a *M. domesticus*

- Caption below figure
- Use specialized software to create chemical structures (ChemDraw, Chemtool, XDrawChem)
- Labels sans-serif, large enough size (at least 7 pt)
- Copyright (transferred to publisher)
When using own, already published figures:
 - ask publisher for permission (use in thesis is often free)
 - modify the figure (change colors, symbols)
- Cite/acknowledge source even if not protected by copyright
- Simple graphics (schemes, plots) should be original (not be copied from other sources)
- Use sufficient resolution
- Never shrink (change the original height-to-width ratio)!
- Never expand (enlarge) - it lowers resolution!
- Avoid *runaround* (text flowing around a figure)

Changing height-to-width ratio

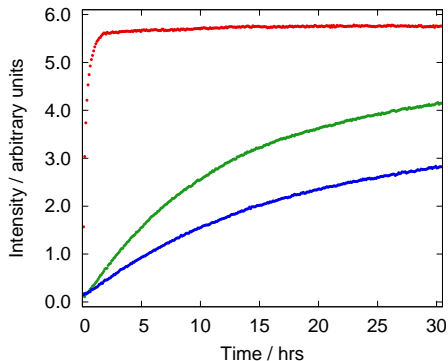

Original

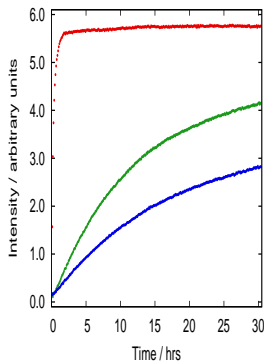

Do not do this!

-When he was presi-
ezuela, Carlos Andrés
the two families he
one with his wife, the
h a mis-
separate
oth sides say
ained a tense
ever visiting,
, or even ac-
g each other.
r. Pérez died
of 88 last De-
d decades of
; resentment
rth. Now the
e clashing in
m battle here
e to lay him



*Carlos Andrés
Pérez*

e, Blanca Rodríguez de
its to inter him in Ven-
Rich he led during two
an 1974 to 1979 and
to 1998.

and Mrs. Pérez's daugh-
says she is a spokesw
her mother.

The mistress, Cecil
prefers Mian
she lived with
for most of th
cade, until h
away.

She claims l
said he never v
be buried in V
as long as his
President Hugc
was in charge.

Since Mr.
failed to spell
preferences in
it's now up to a

judge to decide, in a tria
uled for August. State la
the surviving spouse pri
choosing where to bury
ceased. In this case, tha
Pérez, who remained ma

Do not use in thesis!

- **Vector graphics** - optimal for simple geometric shapes
image composed of *primitive objects*: polygons, ellipses,
shapes defined by Bézier curves
supports text
Use for graphs and simple schemes containing regular shapes
- **Bitmap (*raster*) graphics** - optimal for "irregular" images
image composed of (rectangular) *pixels*
Use for photographs, models of molecules etc.

vector × bitmap

lossy × lossless compression

1 × magnification

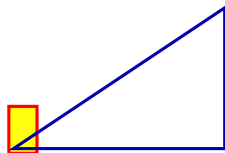

.eps, 3kB

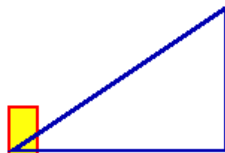

.tif, 98kB

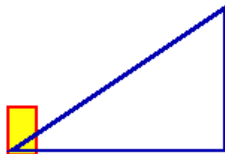

.png, 6kB

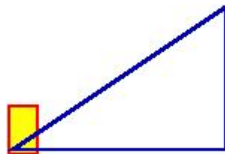

.jpg, 9kB

vector × bitmap

lossy × lossless compression

2× magnification

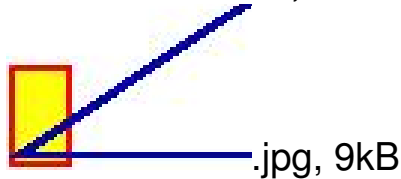
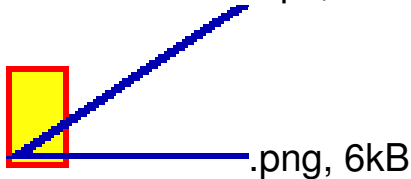
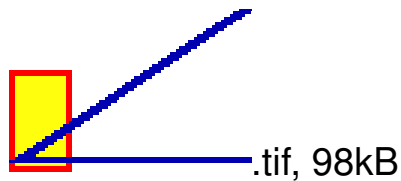
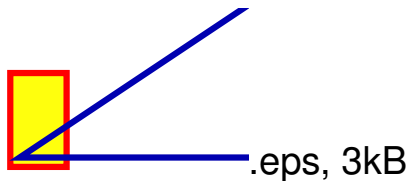

vector × bitmap

lossy × lossless compression

4× magnification

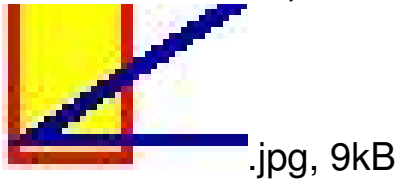
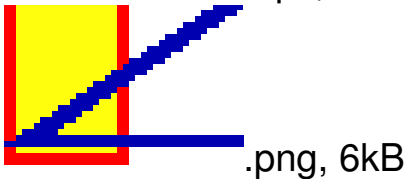
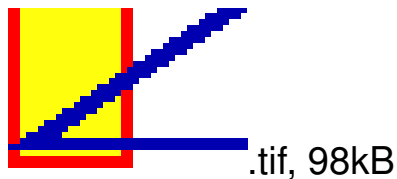
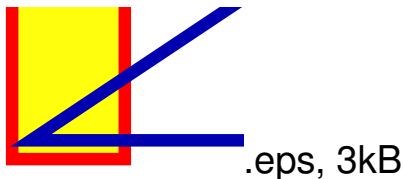

vector × bitmap

lossy × lossless compression

10× magnification



.eps, 3kB

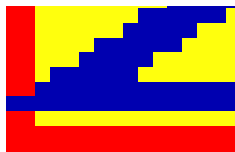

.tif, 98kB

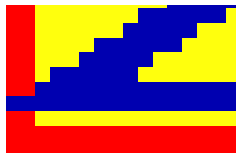

.png, 6kB

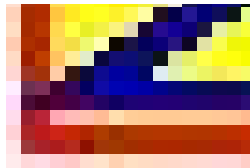

.jpg, 9kB

- **EPS** (*Encapsulated PostScript*) - vector
Use: editing, publication
- **TIFF** (*Tagged Image File Format*) - high quality bitmap
Use: editing, archiving, publication
- **PNG** (*Portable Network Graphics*) - bitmap
lossless compression
Use: logos, maps, models of molecules, schemes
- **GIF** (*Graphics Interchange Format*) - bitmap
lossless compression, less colors
Use: animation
- **JPEG** (*Joint Photographic Experts Group*) - bitmap
lossy compression
Use: photographs
- **PDF** (*Portable Document Format*) - end format

As high as required (quality), as low as possible (size)

Typical requirements by journals:

- Line art: 1000–1200 DPI (*dots-per-inch*)
- Half-tone (photographs): 300 DPI
- Combination (photographs with labels etc): 500–600 DPI

Example:

a landscape picture, width-to-height ratio = $\sqrt{2}$
to fit a column of width = 8.9 cm, \Rightarrow height = 6.3 cm
required resolution 600 DPI

8.9 cm = 3.50 in, $3.50 \times 600 = 2100$

6 cm = 2.48 in, $2.48 \times 600 = 1488$

The figure should have 2100×1488 pixels (~ 3 megapixels!)

Related to physical properties of light:

- Hue - wavelength
- Saturation - monochromaticity
- Luminance - intensity

But color perception is *physiology*, not *optics*!

Purpose: color-coding

Use to help the reader to better understand/remember
not to make the thesis/slideshow more colorful

- Use standard/intuitive choice of colors

Examples:

positive × negative, cold × hot, rigid × flexible
correct × wrong, active × inactive

- Be consistent (same color-coding in all figures)
- Do not use too many colors
 - Different people may see colors differently
 - Different devices define colors differently
computer screen/beamer: RGB, printer: CMYK
 - Technical factors (old lamp, running out of toner)

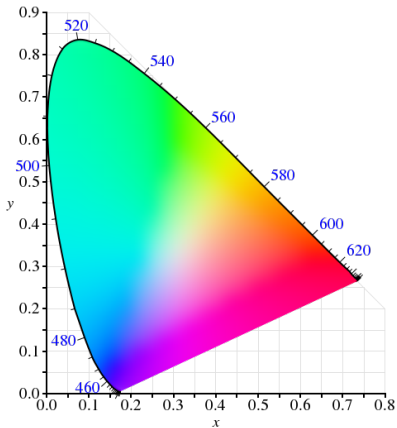

computer display

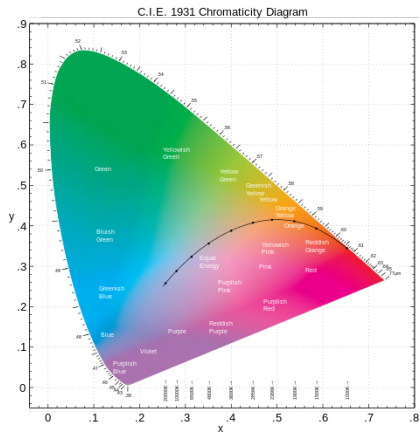

pigments used for printing

By BenRG (left) and Palschou (right) at en.wikipedia

Luminance and contrast

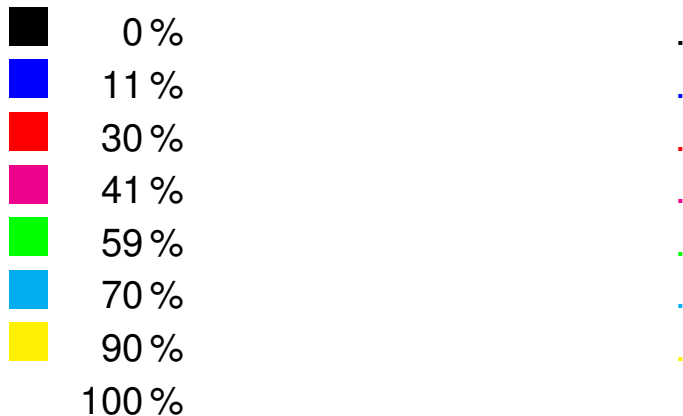

Luminance and contrast

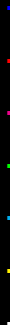
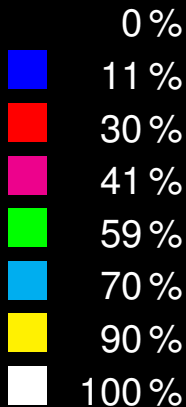

Ability to focus on different colors

Ability to focus on different colors

Ability to focus on different colors

Ability to focus on different colors

Ability to focus on different colors

Ability to focus on different colors

Ability to focus on different colors

Ability to focus on different colors

- Sans-serif
- Letter height: 5–10 % slide height
- One idea per slide
- Not more than 35 words per slide
- Not more than 35 characters per line
- Color coding

When writing a paper

- follow requirements of the publisher even if they violate the general typographic rules
- use template if available

When writing a thesis

- follow requirements of the school even if they violate the general typographic rules
- use template if available

Your thesis should show original ideas/results
but **standard typography!**