

Kuproxový usmerňovač

Július Vida

F5090 Elektronika (2a)

- Cu_2O – polovodič
- Usmerňovacie diódy od roku 1924
- Kremíkové diódy – 1970s
- Polykryštalická štruktúra
- Priepustný smer – z mede do Cu_2O

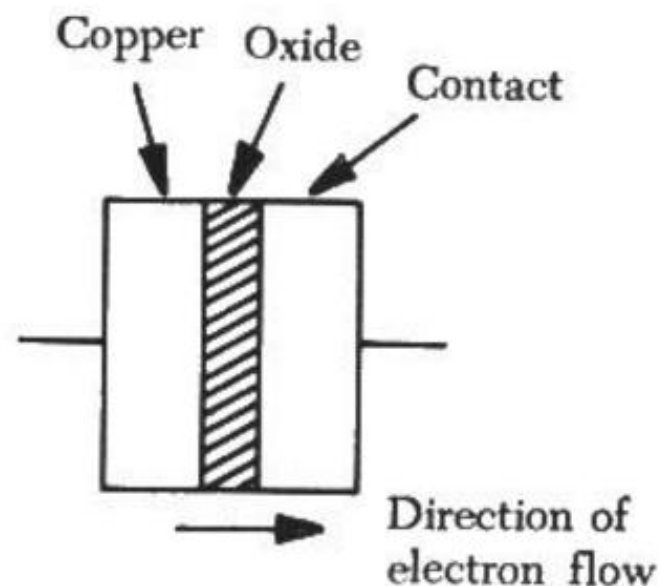

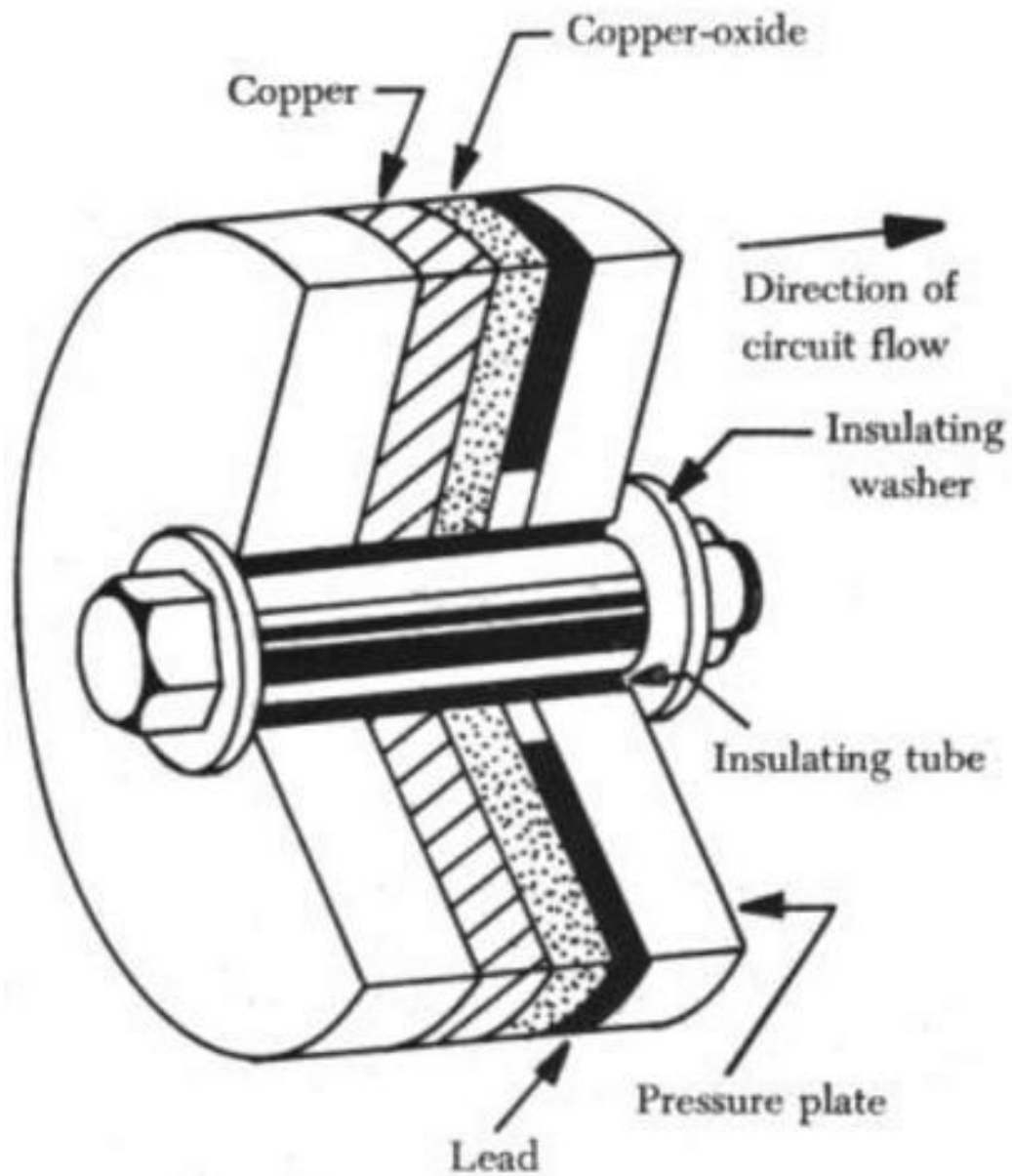



Starting point.

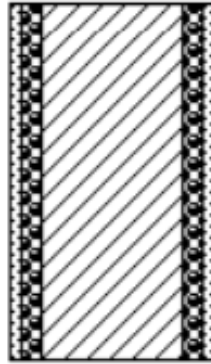

Thermally grown oxides.

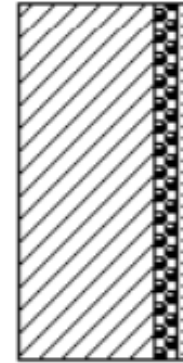

Remove oxide layer from one side.



Remove cupric oxide overlayer.

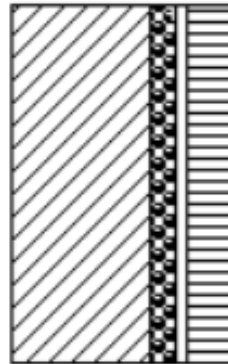

Coat cuprous oxide with Aquadag® and then press on the metal counterelectrode.



Mother Copper



Cuprous Oxide

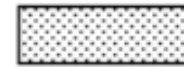

Cupric Oxide



Aquadag®



Counterelectrode
Metal

Elektrické vlastnosti

- Silno závislé na tepelnej úprave Cu_2O
- Pomalé chladenie – vysoké prierazné napätie v závernom smere
- Rapídne chladenie – tolerancia vyšších prúdov
- Striedavé napätie asi 5 V
- Záťaž asi $0,05 \text{ A/cm}^2$

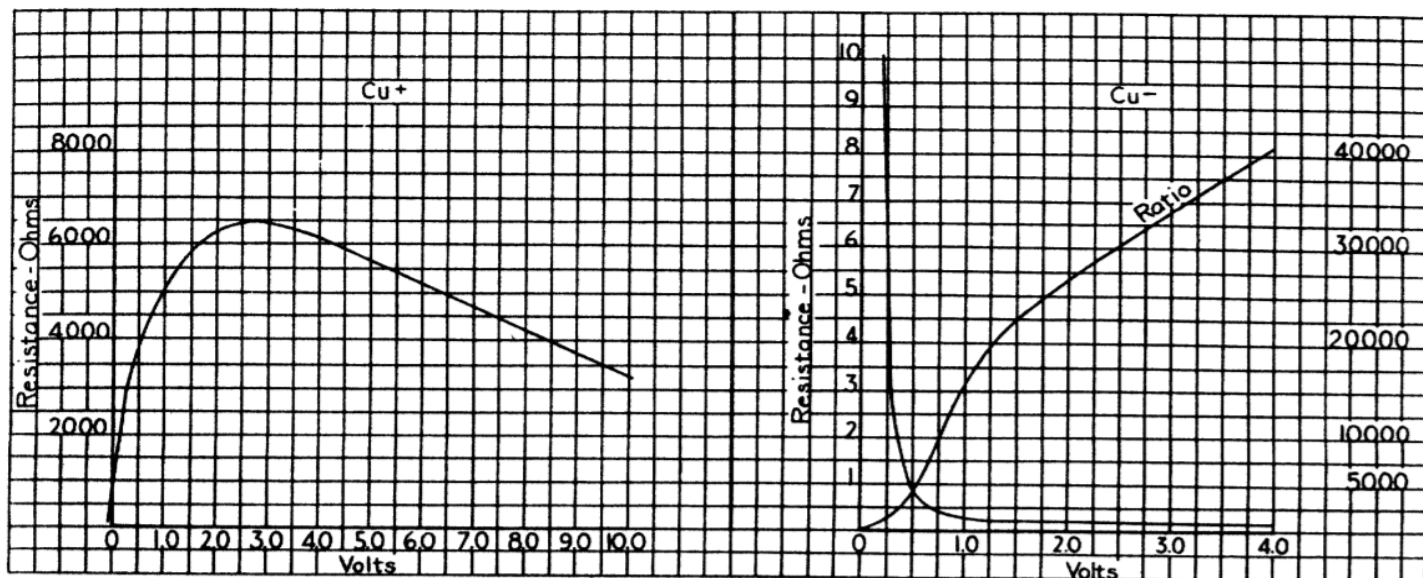
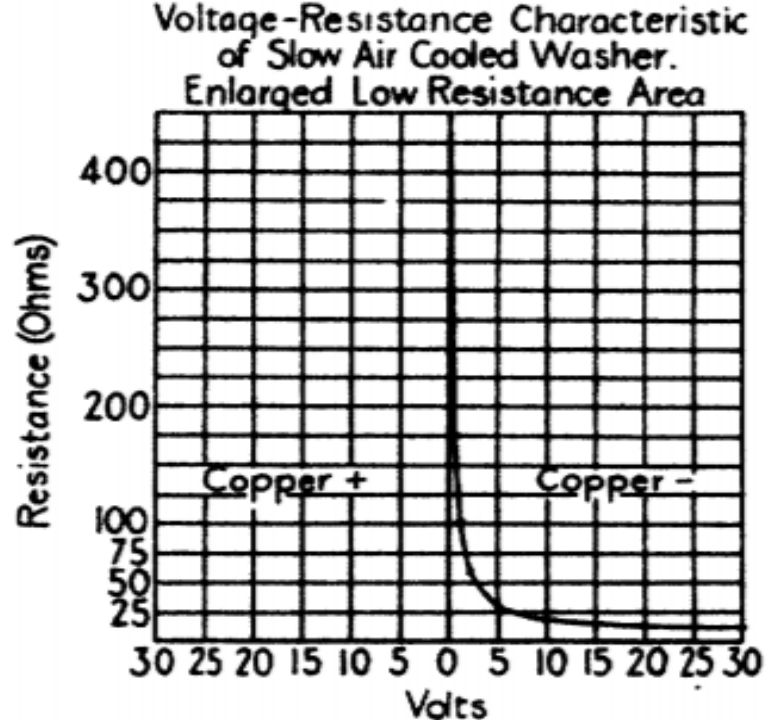
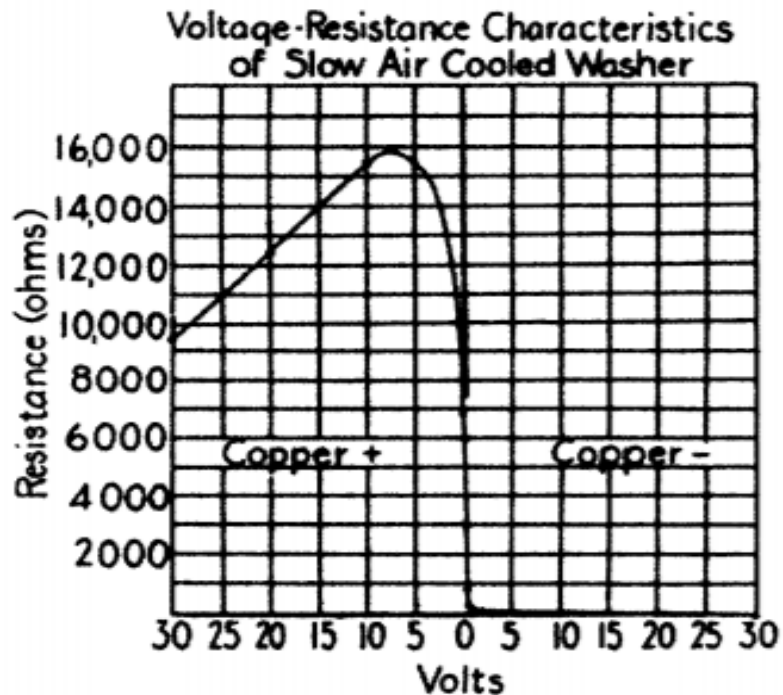
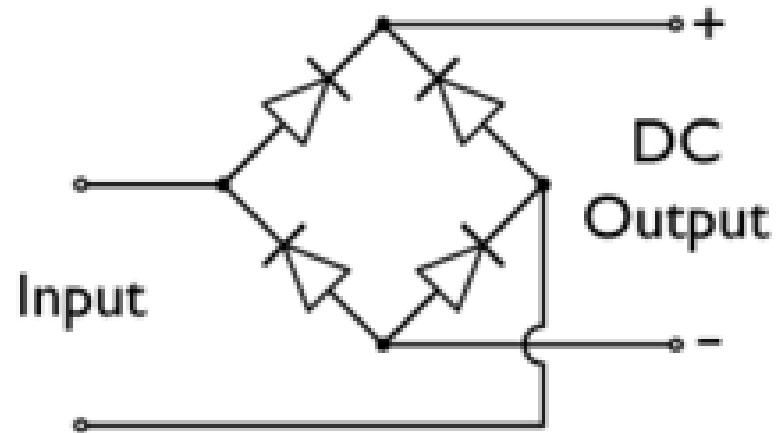

FIG. 12. Resistance voltage characteristics and resistance ratio of water-quenched disk.

Zapojenia

- Disky v sérii – usmerňovanie vyšších napätí
- Disky paralelne – usmerňovanie vyšších prúdov





Aplikácie

- Usmerňovanie
- Demodulátory v rádiových prijímačoch
- Electroplating
- Iné high-current low-voltage aplikácie

- L. O. Grondahl. The Copper-Cuprous-Oxide Rectifier and Photoelectric Cell. Reviews of modern physics vol. 5 (1933)
- Thomas Mark Cuff, Engineering Department of Temple University. The copper oxide rectifier (1993)
- Google
- Wikipedia

Ďakujem za pozornosť