

INTRODUCTION TO ALGEBRAIC TOPOLOGY

doc. RNDr. Martin Čadek, CSc.

Faculty of Science of Masaryk University
Department of Mathematics and Statistics

Technical cooperation: Service Center for E-learning,
Faculty of Informatics, Masaryk University, Brno 2013

© 2013 Masaryk University

0. FOREWORD

These notes form a brief overview of basic topics in a usual introductory course of algebraic topology. They were prepared for my series of lectures at the Okayama University in 2002 and rewritten in 2013. They cannot substitute standard textbooks. The technical proofs of several important theorems are omitted and many other theorems are not proved in full generality. However, in all such cases I have tried to give references to well known textbooks the list of which you can find at the end.

I would like to express my acknowledgements to my former student Richard Lastovecki whose comments helped me to correct and improve the text.

The notes are available online in electronic form at

<http://is.muni.cz/el/1431/jaro2013/M8130/um/39015882/>

CONTENTS

0. Foreword	1
1. Basic notions and constructions	3
2. CW-complexes	9
3. Simplicial and singular homology	14
4. Homology of CW-complexes and applications	24
5. Singular cohomology	31
6. More homological algebra	37
7. Products in cohomology	45
8. Vector bundles and Thom isomorphism	52
9. Poincaré duality	57
10. Homotopy groups	67
11. Fundamental group	74
12. Homotopy and CW-complexes	79
13. Homotopy excision and Hurewicz theorem	85
14. Short overview of some further methods in homotopy theory	93
References	99

1. BASIC NOTIONS AND CONSTRUCTIONS

1.1. Notation. The closure, the interior and the boundary of a topological space X will be denoted by \overline{X} , $\text{int } X$ and ∂X , respectively. The letter I will stand for the interval $[0, 1]$. \mathbb{R}^n and \mathbb{C}^n will denote the vector spaces of n -tuples of real and complex numbers, respectively, with the standard norm $\|x\| = \sum_{i=1}^n |x_i|^2$. The sets

$$D^n = \{x \in \mathbb{R}^n; \|x\| \leq 1\},$$

$$S^n = \{x \in \mathbb{R}^{n+1}; \|x\| = 1\}$$

are the n -dimensional disc and the n -dimensional sphere, respectively.

1.2. Categories of topological spaces. Every category consists of objects and morphisms between them. Morphisms $f : A \rightarrow B$ and $g : B \rightarrow C$ can be composed in a morphism $g \circ f : A \rightarrow C$ and for every object B there is a morphism $\text{id}_B : B \rightarrow B$ such that $\text{id}_B \circ f = f$ and $g \circ \text{id}_B = g$.

The category with topological spaces as objects and continuous maps as morphisms will be denoted Top . Topological spaces with distinguished points (usually denoted by $*$) and continuous maps $f : (X, *) \rightarrow (Y, *)$ such that $f(*) = *$ form the category Top_* . Topological spaces X, A will be called a *pair of topological spaces* if A is a subspace of X (notation (X, A)). The notation $f : (X, A) \rightarrow (Y, B)$ means that $f : X \rightarrow Y$ is a continuous map which preserves subspaces, i. e. $f(A) \subseteq B$. The category Top^2 consists of pairs of topological spaces as objects and continuous maps $f : (X, A) \rightarrow (Y, B)$ as morphisms. Finally, Top_*^2 will denote the category of pairs of topological spaces with distinguished points in subspaces and continuous maps preserving both subspaces and distinguished points.

The right category for doing algebraic topology is the category of compactly generated spaces. We will not go into details and refer to Chapter 5 of [May]. In fact, the majority of spaces we deal with in this text are compactly generated.

From now on, a space will mean a topological space and a map will mean a continuous map.

1.3. Homotopy. Maps $f, g : X \rightarrow Y$ are called *homotopic*, notation $f \sim g$, if there is a map $h : X \times I \rightarrow Y$ such that $h(x, 0) = f(x)$ and $h(x, 1) = g(x)$. This map is called *homotopy* between f and g . The relation \sim is an equivalence. Homotopies in categories Top_* , Top^2 or Top_*^2 have to preserve distinguished points, i. e. $h(*, t) = *$, subsets or both subsets and distinguished points, respectively.

Spaces X and Y are called *homotopy equivalent* if there are maps $f : X \rightarrow Y$ and $g : Y \rightarrow X$ such that $f \circ g \sim \text{id}_Y$ and $g \circ f \sim \text{id}_X$. We also say that the spaces X and Y have the same *homotopy type*. The maps f and g are called *homotopy equivalences*.

A space is called *contractible* if it is homotopy equivalent to a point.

Example. S^n and $\mathbb{R}^{n+1} - \{0\}$ are homotopy equivalent. As homotopy equivalences take the inclusion $f : S^n \rightarrow \mathbb{R}^{n+1} - \{0\}$ and $g : \mathbb{R}^{n+1} - \{0\} \rightarrow S^n$, $g(x) = x/\|x\|$.

1.4. Retracts and deformation retracts. Let $i : A \hookrightarrow X$ be an inclusion. We say that A is a *retract* of X if there is a map $r : X \rightarrow A$ such that $r \circ i = \text{id}_A$. The map r is called a *retraction*.

We say that A is a *deformation retract* of X (sometimes also strong deformation retract) if $i \circ r : X \rightarrow A \rightarrow X$ is homotopic to the identity on X relative to A , i.e. there is a homotopy $h : X \times I \rightarrow X$ such that $h(-, 0) = \text{id}_X$, $h(-, 1) = i \circ r$ and $h(i(-), t) = \text{id}_A$ for all $t \in I$. The map h is called a *deformation retraction*.

Exercise A. Show that deformation retract of X is homotopy equivalent to X .

1.5. Basic constructions in Top. Consider a topological space X with an equivalence \simeq . Then X/\simeq is the set of equivalence classes with the topology determined by the projection $p : X \rightarrow X/\simeq$ in the following way: $U \subseteq X/\simeq$ is open iff $p^{-1}(U)$ is open in X .

Exercise A. The map $f : (X/\simeq) \rightarrow Y$ is continuous iff the composition $f \circ p : X \rightarrow (X/\simeq) \rightarrow Y$ is continuous.

We will show this constructions in several special cases. Let A be a subspace of X . The *quotient* X/A is the space X/\simeq where $x \simeq y$ iff $x = y$ or both x and y are elements of A . This space is often considered as a based space with base point determined by A . If $A = \emptyset$ we put $X/\emptyset = X \cup \{*\}$.

Exercise B. Prove that D^n/S^{n-1} is homeomorphic to S^n . For it consider $f : D^n \rightarrow S^n$

$$f(x_1, x_2, \dots, x_n) = (2\sqrt{1 - \|x\|^2}x, 2\|x\|^2 - 1).$$

Disjoint union of spaces X and Y will be denoted $X \sqcup Y$. Open sets are unions of open sets in X and in Y . Let A be a subspace of X and let $f : A \rightarrow Y$ be a map. Then $X \cup_f Y$ is the space $(X \sqcup Y)/\simeq$ where the equivalence is generated by relations $a \simeq f(a)$.

The *mapping cylinder* of a map $f : X \rightarrow Y$ is the space

$$M_f = X \times I \cup_{f \times 1} Y$$

which arises from $X \times I$ and Y after identification of points $(x, 1) \in X \times I$ and $f(x) \in Y$.

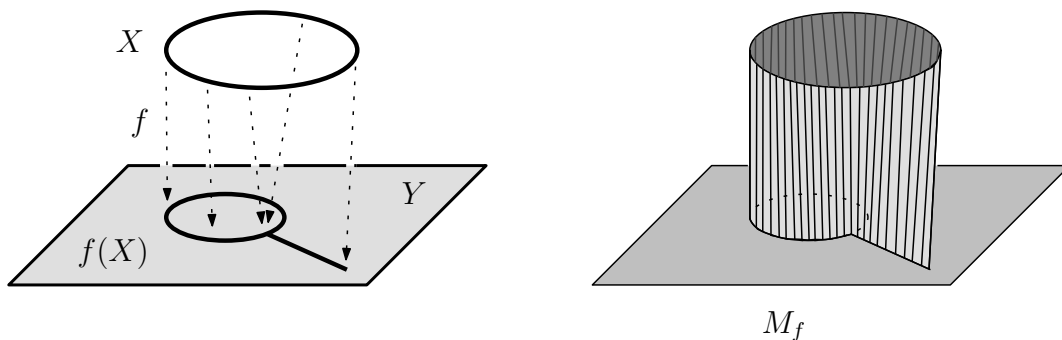

FIGURE 1.1. Mapping cylinder

Exercise C. We have two inclusions $i_X : X = X \times \{0\} \hookrightarrow M_f$ and $i_Y : Y \hookrightarrow M_f$ and a retraction $r : M_f \rightarrow Y$. How is r defined?

$$\begin{array}{ccccc} & & X & & \\ & f \swarrow & \downarrow i_X & \searrow f & \\ Y & \xrightarrow{i_Y} & M_f & \xrightarrow{r} & Y \end{array}$$

Prove that

- (1) Y is a deformation retract of M_f ,
- (2) $i_X \circ r = f$,
- (3) $i_Y \circ f \sim i_X$.

The *mapping cone* of a mapping $f : X \rightarrow Y$ is the space

$$C_f = M_f / (X \times \{0\}).$$

A special case of a mapping cone is the *cone* of a space X

$$CX = X \times I / (X \times \{0\}) = C_{\text{id}_X}.$$

The *suspension* of a space X is the space

$$SX = CX / (X \times \{1\}).$$

Exercise D. Show that $SS^n = S^{n+1}$. For it consider the map $f : S^n \times I \rightarrow S^{n+1}$

$$f(x, t) = (\sqrt{1 - (2t - 1)^2}x, 2t - 1).$$

The *join* of spaces X and Y is the space

$$X \star Y = X \times Y \times I / \simeq$$

where \simeq is the equivalence generated by $(x, y_1, 0) \simeq (x, y_2, 0)$ and $(x_1, y, 1) \simeq (x_2, y, 1)$.

Exercise E. Show that the join operation is associative and compute the joins of two points, two intervals, several points, $S^0 \star X$, $S^n \star S^m$.

1.6. Basic constructions in Top_* and Top^2 . Let X be a space with a base point x_0 . The *reduced suspension* of X is the space

$$\Sigma X = SX / (\{x_0\} \times I)$$

with base point determined by $x_0 \times I$. In the next section in 2.8 we will show that ΣX is homotopy equivalent to SX .

The space

$$(X, x_0) \vee (Y, y_0) = X \times \{y_0\} \cup \{x_0\} \times Y$$

with distinguished point (x_0, y_0) is called the *wedge* of X and Y and usually denoted only as $X \vee Y$.

The *smash product* of spaces (X, x_0) and (Y, y_0) is the space

$$X \wedge Y = X \times Y / (X \times \{y_0\} \cup \{x_0\} \times Y) = X \times Y / X \vee Y.$$

Analogously, the smash product of pairs (X, A) and (Y, B) is the pair

$$(X \times Y, A \times Y \cup X \times B).$$

Exercise A. Show that $S^m \wedge S^n = S^{n+m}$. One way how to do it is to prove that

$$X/A \wedge Y/B \cong X \times Y/A \times Y \cup X \times B.$$

1.7. Homotopy extension property. We say that a pair of topological spaces (X, A) has the *homotopy extension property* (abbreviation HEP) if any map $f : X \rightarrow Y$ and any homotopy $h : A \times I \rightarrow Y$ such that $h(a, 0) = f(a)$ for $a \in A$, and

$$f \cup h : X \times \{0\} \cup A \times I \rightarrow Y$$

is continuous, can be extended to a homotopy $H : X \times I \rightarrow Y$ such that $H(x, 0) = f(x)$ and $H(a, t) = h(a, t)$ for all $x \in X$, $a \in A$ and $t \in I$, i.e. H is an arrow making the diagram

$$\begin{array}{ccc} X \times \{0\} \cup A \times I & \xrightarrow{f \cup h} & Y \\ \downarrow & \nearrow H & \\ X \times I & & \end{array}$$

commutative. If the pair (X, A) satisfies HEP, we call the inclusion $A \hookrightarrow X$ a *cofibration*.

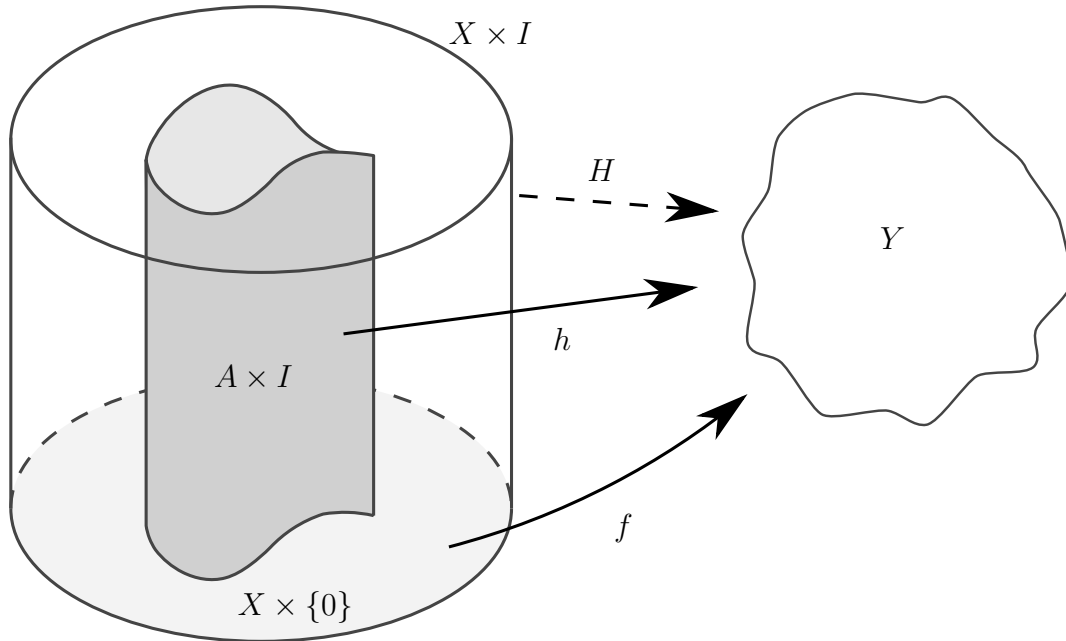

FIGURE 1.2. Homotopy extension property

Theorem. A pair (X, A) has HEP if and only if $X \times \{0\} \cup A \times I$ is a retract of $X \times I$.

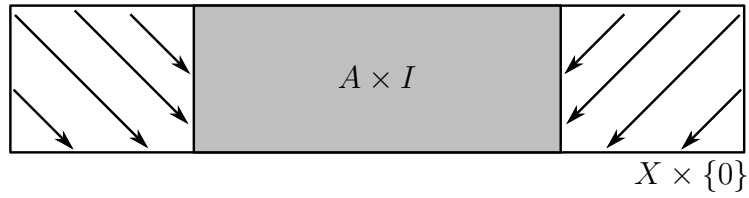

FIGURE 1.3. Retraction $X \times I \rightarrow X \times \{0\} \cup A \times I$

Exercise A. Using this Theorem show that the pair (D^n, S^{n-1}) satisfies HEP. Many other examples will be given in the next section.

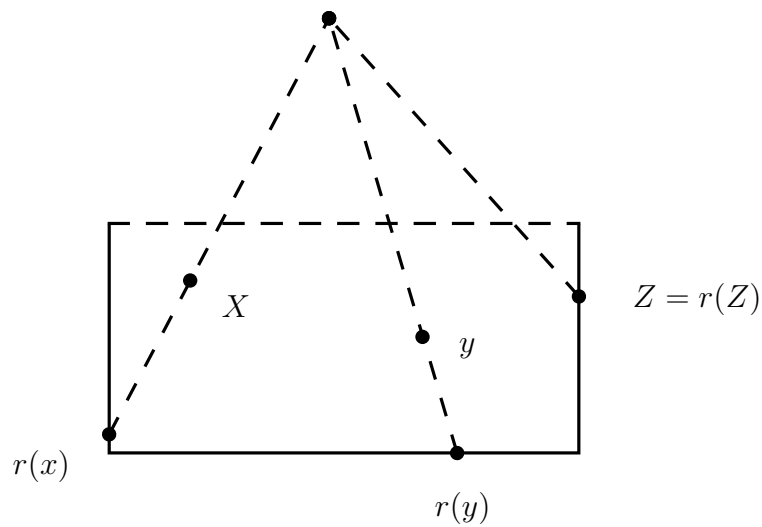

FIGURE 1.4. Retraction $D^1 \times I \rightarrow D^1 \times \{0\} \cup S^0 \times I$

Proof of Theorem. Let (X, A) has HEP. Put $Y = X \times \{0\} \cup A \times I$ and consider $f \cup h : X \times \{0\} \cup A \times I \rightarrow X \times \{0\} \cup A \times I$ to be an identity. Its extension $H : X \times I \rightarrow X \times \{0\} \cup A \times I$ is a retraction.

Let $r : X \times I \rightarrow X \times \{0\} \cup A \times I$ be a retraction. Given a map f and a homotopy h as in the definition which together determine a continuous map $F = (f \cup h) : X \times \{0\} \cup A \times I \rightarrow Y$, then $H = F \circ r$ is an extension of $f \cup h$. \square

Exercise B. Let a pair (X, A) satisfy HEP and consider a map $g : A \rightarrow Y$. Prove that $(X \cup_g Y, Y)$ also satisfies HEP.

Exercise C. Let X be a Hausdorff compact space and let an inclusion $A \hookrightarrow X$ is a cofibration. Prove that A is a closed subset of X .

Exercise D. Consider the closed subset set $A = \{1/n \in \mathbb{R}; n = 0, 1, 2, \dots\} \cup \{0\}$ of the interval $[0, 1]$. However, the inclusion $A \hookrightarrow [0, 1]$ is not a cofibration. Prove it.

Exercise E. Let M_f be a mapping cylinder of a map $f : X \rightarrow Y$. Show that the inclusion $i_X : X \hookrightarrow M_f$ is a cofibration. In particular, the map $f : X \rightarrow Y$ can be factored into the composition $r \circ i_X$ of the cofibration i_X and the homotopy equivalence r . (See the exercise after the definition of the mapping cylinder.)

2. CW-COMPLEXES

2.1. Constructive definition of CW-complexes. *CW-complexes* are all the spaces which can be obtained by the following construction:

- (1) We start with a discrete space X^0 . Single points of X^0 are called 0-dimensional cells.
- (2) Suppose that we have already constructed X^{n-1} . For every element α of an index set J_n take a map $f_\alpha : S^{n-1} = \partial D_\alpha^n \rightarrow X^{n-1}$ and put

$$X^n = \bigcup_{\alpha} (X^{n-1} \cup_{f_\alpha} D_\alpha^n).$$

Interiors of discs D_α^n are called n -dimensional cells and denoted by e_α^n .

- (3) We can stop our construction for some n and put $X = X^n$ or we can proceed with n to infinity and put

$$X = \bigcup_{n=0}^{\infty} X^n.$$

In the latter case X is equipped with inductive topology which means that $A \subseteq X$ is closed (open) iff $A \cap X^n$ is closed (open) in X^n for every n .

Example A. The sphere S^n is a CW-complex with one cell e^0 in dimension 0, one cell e^n in dimension n and the constant attaching map $f : S^{n-1} \rightarrow e^0$.

Example B. The real projective space $\mathbb{R}\mathbb{P}^n$ is the space of 1-dimensional linear subspaces in \mathbb{R}^{n+1} . It is homeomorphic to

$$S^n / (v \simeq -v) \cong D^n / (w \simeq -w), \quad \text{for } w \in \partial D^n = S^{n-1}.$$

However, $S^{n-1} / (w \simeq -w) \cong \mathbb{R}\mathbb{P}^{n-1}$. So $\mathbb{R}\mathbb{P}^n$ arises from $\mathbb{R}\mathbb{P}^{n-1}$ by attaching one n -dimensional cell using the projection $f : S^{n-1} \rightarrow \mathbb{R}\mathbb{P}^{n-1}$. Hence $\mathbb{R}\mathbb{P}^n$ is a CW-complex with one cell in every dimension from 0 to n .

We define $\mathbb{R}\mathbb{P}^\infty = \bigcup_{n=1}^{\infty} \mathbb{R}\mathbb{P}^n$. It is again a CW-complex.

Example C. The complex projective space $\mathbb{C}\mathbb{P}^n$ is the space of complex 1-dimensional linear subspaces in \mathbb{C}^{n+1} . It is homeomorphic to

$$\begin{aligned} S^{2n+1} / (v \simeq \lambda v) &\cong \{(w, \sqrt{1-|w|^2}) \in \mathbb{C}^{n+1}; \|w\| \leq 1\} / ((w, 0) \simeq \lambda(w, 0), \|w\| = 1) \\ &\cong D^{2n} / (w \simeq \lambda w; w \in \partial D^{2n}) \end{aligned}$$

for all $\lambda \in \mathbb{C}$, $|\lambda| = 1$. However, $\partial D^{2n} / (w \simeq \lambda w) \cong \mathbb{C}\mathbb{P}^{n-1}$. So $\mathbb{C}\mathbb{P}^n$ arises from $\mathbb{C}\mathbb{P}^{n-1}$ by attaching one $2n$ -dimensional cell using the projection $f : S^{2n-1} = \partial D^{2n} \rightarrow \mathbb{C}\mathbb{P}^{n-1}$. Hence $\mathbb{C}\mathbb{P}^n$ is a CW-complex with one cell in every even dimension from 0 to $2n$.

Define $\mathbb{C}\mathbb{P}^\infty = \bigcup_{n=1}^{\infty} \mathbb{C}\mathbb{P}^n$. It is again a CW-complex.

2.2. Another definition of CW-complexes. Sometimes it is advantageous to be able to describe CW-complexes by their properties. We carry it out in this paragraph. Then we show that the both definitions of CW-complexes are equivalent.

Definition. A *cell complex* is a Hausdorff topological space X such that

- (1) X as a set is a disjoint union of cells e_α

$$X = \bigcup_{\alpha \in J} e_\alpha.$$

- (2) For every cell e_α there is a number, called dimension.

$$X^n = \bigcup_{\dim e_\alpha \leq n} e_\alpha$$

is the n -skeleton of X .

- (3) Cells of dimension 0 are points. For every cell of dimension ≥ 1 there is a characteristic map

$$\varphi_\alpha : (D^n, S^{n-1}) \rightarrow (X, X^{n-1})$$

which is a homeomorphism of $\text{int } D^n$ onto e_α .

The *cell subcomplex* Y of a cell complex X is a union $Y = \bigcup_{\alpha \in K} e_\alpha$, $K \subseteq J$, which is a cell complex with the same characteristic maps as the complex X .

A *CW-complex* is a cell complex satisfying the following conditions:

- (C) Closure finite property. The closure of every cell belongs to a finite subcomplex, i. e. subcomplex consisting only from a finite number of cells.
(W) Weak topology property. F is closed in X if and only if $F \cap \bar{e}_\alpha$ is closed for every α .

Example. Examples of cell complexes which are not CW-complexes:

- (1) S^2 where every point is 0-cell. It does not satisfy property (W).
(2) D^3 with cells $e^3 = \text{int } B^3$, $e_x^0 = \{x\}$ for all $x \in S^2$. It does not satisfy (C).
(3) $X = \{1/n; n \geq 1\} \cup \{0\} \subset \mathbb{R}$. It does not satisfy (W).
(4) $X = \bigcup_{n=1}^{\infty} \{x \in \mathbb{R}^2; \|x - (1/n, 0)\| = 1/n\} \subset \mathbb{R}^2$. If it were a CW-complex, the set $\{(1/n, 0) \in \mathbb{R}^2; n \geq 1\}$ would be closed in X , and consequently in \mathbb{R}^2 .

2.3. Equivalence of definitions.

Proposition. *The definitions 2.1 and 2.2 of CW-complexes are equivalent.*

Proof. We will show that a space X constructed according to 2.1 satisfies definition 2.2. The proof in the opposite direction is left as an exercise to the reader.

The cells of dimension 0 are points of X^0 . The cells of dimension n are interiors of discs D_α^n attached to X^{n-1} with characteristic maps

$$\varphi_\alpha : (D_\alpha^n, S_\alpha^{n-1}) \rightarrow (X^{n-1} \cup_{f_\alpha} D_\alpha^n, X^{n-1})$$

induced by identity on D_α^n . So X is a cell complex. From the construction 2.1 it follows that X satisfies property (W). It remains to prove property (C). We will carry it out by induction.

Let $n = 0$. Then $\bar{e}_\alpha^0 = e_\alpha^0$.

Let (C) holds for all cells of dimension $\leq n - 1$. \bar{e}_α^n is a compact set (since it is an image of D_α^n). Its boundary ∂e_α^n is compact in X^{n-1} . Consider the set of indices

$$K = \{\beta \in J; \partial e_\alpha^n \cap e_\beta \neq \emptyset\}.$$

If we show that K is finite, from the inductive assumption we get that \bar{e}_α^n lies in a finite subcomplex which is a union of finite subcomplexes for \bar{e}_β , $\beta \in K$.

Choosing one point from every intersection $\partial e_\alpha^n \cap e_\beta$, $\beta \in K$ we form a set A . A is closed since any intersection with a cell is empty or a one-point set. Simultaneously, it is open, since every its element a forms an open subset (for $A - \{a\}$ is closed). So A is a discrete subset in the compact set ∂e_α^n , consequently, it is finite. \square

2.4. Compact sets in CW complexes.

Lemma. *Let X be a CW-complex. Then any compact set $A \subseteq X$ lies in a finite subcomplex, particularly, there is n such that $A \subseteq X^n$.*

Proof. Consider the set of indices

$$K = \{\beta \in J; A \cap e_\beta \neq \emptyset\}.$$

Similarly as in 2.3 we will show that K is a finite set. Then $A \subseteq \bigcup_{\beta \in K} \bar{e}_\beta$ and every \bar{e}_β lies in a finite subcomplexes. Hence A itself is a subset of a finite subcomplex. \square

2.5. Cellular maps. Let X and Y be CW-complexes. A map $f : X \rightarrow Y$ is called a *cellular map* if $f(X^n) \subseteq Y^n$ for all n . In Section 5 we will prove that every map $g : X \rightarrow Y$ is homotopic to a cellular map $f : X \rightarrow Y$. If moreover, g restricted to a subcomplex $A \subset X$ is already cellular, f can be chosen in such a way that $f = g$ on A .

2.6. Spaces homotopy equivalent to CW-complexes. One can show that every open subset of \mathbb{R}^n is a CW-complex. In [Hatcher], Theorem A.11, it is proved that every retract of a CW-complex is homotopy equivalent to a CW-complex. These two facts imply that every compact manifold with or without boundary is homotopy equivalent to a CW-complex. (See [Hatcher], Corollary A.12.)

2.7. CW complexes and HEP. The most important result of this section is the following theorem:

Theorem. *Let A be a subcomplex of a CW-complex X . Then the pair (X, A) has the homotopy extension property.*

Proof. According to the last theorem in Section 1 it is sufficient to prove that $X \times \{0\} \cup A \times I$ is a retract of $X \times I$. We will prove that it is even a deformation retract. There is a retraction $r_n : D^n \times I \rightarrow D^n \times \{0\} \cup S^{n-1} \times I$. (See Section 1.) Then $h_n : D^n \times I \times I \rightarrow D^n \times I$ defined by

$$h_n(x, s, t) = (1 - t)(x, s) + tr_n(x, s)$$

is a deformation retraction, i.e. a homotopy between id and r_n .

Put $Y^{-1} = A$, $Y^n = X^n \cup A$. Using h_n we can define a deformation retraction $H_n : Y^n \times I \times I \rightarrow Y^n \times I$ for the retract $Y^n \times \{0\} \cup Y^{n-1} \times I$ of $Y^n \times I$. Now define

the deformation retraction $H : X \times I \times I \rightarrow X \times I$ for the retract $X \times \{0\} \cup A \times I$ successively on the subspaces $X \times \{0\} \times I \cup Y^n \times I \times I$ with values in $X \times \{0\} \cup Y^n \times I$. For $n = 0$ put

$$\begin{aligned} H(x, s, t) &= (x, s) && \text{for } (x, s) \in X \times \{0\} \text{ or } t \in [0, 1/2], \\ H(x, s, t) &= H_0(x, s, 2(t - 1/2)) && \text{for } x \in Y^0 \text{ and } t \in [1/2, 1]. \end{aligned}$$

Suppose that we have already defined H on $X \times \{0\} \cup Y^{n-1} \times I$. On $X \times \{0\} \cup Y^n \times I$ we put

$$\begin{aligned} H(x, s, t) &= (x, s) && \text{for } (x, s) \in X \times \{0\} \text{ or } t \in [0, 1/2^{n+1}], \\ H(x, s, t) &= H_n(x, s, 2^{n+1}(t - 1/2^{n+1})) && \text{for } x \in Y^n \text{ and } t \in [1/2^{n+1}, 1/2^n], \\ H(x, s, t) &= H(H(x, s, 1/2^n), t) && \text{for } x \in Y^n \text{ and } t \in [1/2^n, 1]. \end{aligned}$$

$H : X \times I \times I \rightarrow X \times I$ is continuous since so are its restrictions on $X \times \{0\} \times I \cup Y^n \times I \times I$ and the space $X \times I \times I$ is a direct limit of the subspaces $X \times \{0\} \times I \cup Y^n \times I \times I$.

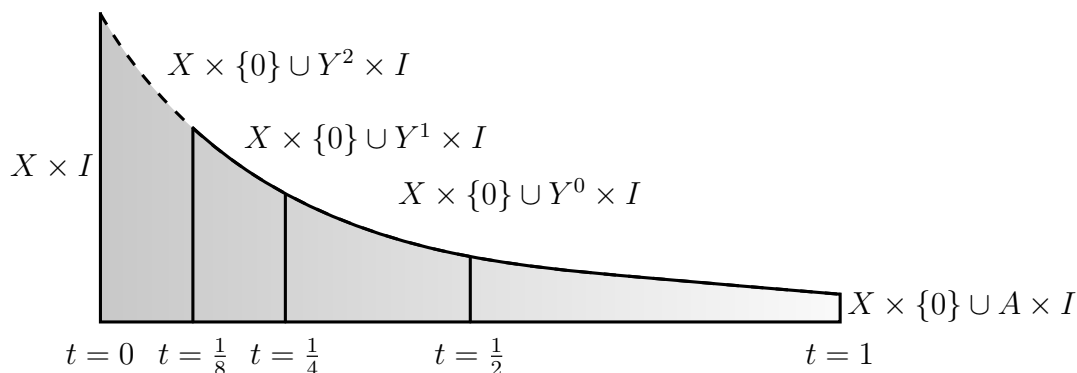

FIGURE 2.1. Image of H depending on t

□

2.8. First criterion for homotopy equivalence.

Proposition. *Suppose that a pair (X, A) has the homotopy extension property and that A is contractible (in X). Then the canonical projection $q : X \rightarrow X/A$ is a homotopy equivalence.*

Proof. Since A is contractible, there is a homotopy $h : A \times I \rightarrow A$ between id_A and constant map. This homotopy together with $\text{id}_X : X \rightarrow X$ can be extended to a homotopy $f : X \times I \rightarrow X$. Since $f(A, t) \subseteq A$ for all $t \in I$, there is a homotopy $\tilde{f} : X/A \times I \rightarrow X/A$ such that the diagram

$$\begin{array}{ccc} X \times I & \xrightarrow{f} & X \\ q \downarrow & & \downarrow q \\ X/A \times I & \xrightarrow{\tilde{f}} & X/A \end{array}$$

commutes. Define $g : X/A \rightarrow X$ by $g([x]) = f(x, 1)$. Then $\text{id}_X \sim g \circ q$ via the homotopy f and $\text{id}_{X/A} \sim q \circ g$ via the homotopy \tilde{f} . Hence X is homotopy equivalent to X/A . \square

Exercise A. Using the previous criterion show that $S^2/S^0 \sim S^2 \vee S^1$.

Exercise B. Using the previous criterion show that the suspension and the reduced suspension of a CW-complex are homotopy equivalent.

2.9. Second criterion for homotopy equivalence.

Proposition. *Let (X, A) be a pair of CW-complexes and let Y be a space. Suppose that $f, g : A \rightarrow Y$ are homotopic maps. Then $X \cup_f Y$ and $X \cup_g Y$ are homotopy equivalent.*

Proof. Let $F : A \times I \rightarrow Y$ be a homotopy between f and g . We will show that $X \cup_f Y$ and $X \cup_g Y$ are both deformation retracts of $(X \times I) \cup_F Y$. Consequently, they have to be homotopy equivalent.

We construct a deformation retraction in two steps.

- (1) $(X \times \{0\}) \cup_f Y$ is a deformation retract of $(X \times \{0\}) \cup A \times I \cup_F Y$.
- (2) $(X \times \{0\}) \cup A \times I \cup_F Y$ is a deformation retract of $(X \times I) \cup_F Y$.

\square

Exercise. Let (X, A) be a pair of CW-complexes. Suppose that A is a contractible in X , i. e. there is a homotopy $F : A \rightarrow X$ between id_A and const . Using the first criterion show that $X/A \cong X \cup CA/CA \sim X \cup CA$. Using the second criterion prove that $X \cup CA \sim X \vee SA$. Then

$$X/A \sim X \vee SA.$$

Apply it to compute S^n/S^i , $i < n$.

3. SIMPLICIAL AND SINGULAR HOMOLOGY

3.1. Exact sequences. A sequence of homomorphisms of Abelian groups or modules over a ring

$$\dots \xrightarrow{f_{n+1}} A_n \xrightarrow{f_n} A_{n-1} \xrightarrow{f_{n-1}} A_{n-2} \xrightarrow{f_{n-2}} \dots$$

is called an *exact sequence* if

$$\text{Im } f_n = \text{Ker } f_{n-1}.$$

Exactness of the following sequences

$$O \rightarrow A \xrightarrow{f} B, \quad B \xrightarrow{g} C \rightarrow 0, \quad 0 \rightarrow C \xrightarrow{h} D \rightarrow 0$$

means that f is a monomorphism, g is an epimorphism and h is an isomorphism, respectively.

A *short exact sequence* is an exact sequence

$$0 \rightarrow A \xrightarrow{i} B \xrightarrow{j} C \rightarrow 0.$$

In this case $C \cong B/A$. We say that the short exact sequence splits if one of the following three equivalent conditions is satisfied:

- (1) There is a homomorphism $p : B \rightarrow A$ such that $pi = \text{id}_A$.
- (2) There is a homomorphism $q : C \rightarrow B$ such that $jq = \text{id}_C$.
- (3) There are homomorphisms $p : B \rightarrow A$ and $q : C \rightarrow B$ such that $ip + jq = \text{id}_B$.

The last condition means that $B \cong A \oplus C$ with isomorphism $(p, q) : B \rightarrow A \oplus C$.

Exercise. Prove the equivalence of (1), (2) and (3).

3.2. Chain complexes. The *chain complex* (C, ∂) is a sequence of Abelian groups (or modules over a ring) and their homomorphisms indexed by integers

$$\dots \xrightarrow{\partial_{n+2}} C_{n+1} \xrightarrow{\partial_{n+1}} C_n \xrightarrow{\partial_n} C_{n-1} \xrightarrow{\partial_{n-1}} \dots$$

such that

$$\partial_{n-1}\partial_n = 0.$$

This conditions means that $\text{Im } \partial_n \subseteq \text{Ker } \partial_{n-1}$. The homomorphism ∂_n is called a boundary operator. A *chain homomorphism* of chain complexes (C, ∂^C) and (D, ∂^D) is a sequence of homomorphisms of Abelian groups (or modules over a ring) $f_n : C_n \rightarrow D_n$ which commute with the boundary operators

$$\partial_n^D f_n = f_{n-1} \partial_n^C.$$

3.3. Homology of chain complexes. The n -th *homology group* of the chain complex (C, ∂) is the group

$$H_n(C) = \frac{\text{Ker } \partial_n}{\text{Im } \partial_{n+1}}.$$

The elements of $\text{Ker } \partial_n = Z_n$ are called *cycles* of dimension n and the elements of $\text{Im } \partial_{n+1} = B_n$ are called *boundaries* (of dimension n). If a chain complex is exact, then its homology groups are trivial.

The component f_n of the chain homomorphism $f : (C, \partial^C) \rightarrow (D, \partial^D)$ maps cycles into cycles and boundaries into boundaries. It enables us to define

$$H_n(f) : H_n(C) \rightarrow H_n(D)$$

by the prescription $H_n(f)[c] = [f_n(c)]$ where $[c] \in H_n(C_*)$ and $[f_n(c)] \in H_n(D^*)$ are classes represented by the elements $c \in Z_n(C)$ and $f_n(c) \in Z_n(D)$, respectively.

3.4. Long exact sequence in homology. A sequence of chain homomorphisms

$$\dots \rightarrow A \xrightarrow{f} B \xrightarrow{g} C \rightarrow \dots$$

is exact if for every $n \in \mathbb{Z}$

$$\dots \rightarrow A_n \xrightarrow{f_n} B_n \xrightarrow{g_n} C_n \rightarrow \dots$$

is an exact sequence of Abelian groups.

Theorem. Let $0 \rightarrow A \xrightarrow{i} B \xrightarrow{j} C \rightarrow 0$ be a short exact sequence of chain complexes. Then there is a connecting homomorphism $\partial_* : H_n(C) \rightarrow H_{n-1}(A)$ such that the sequence

$$\dots \xrightarrow{\partial_*} H_n(A) \xrightarrow{H_n(i)} H_n(B) \xrightarrow{H_n(j)} H_n(C) \xrightarrow{\partial_*} H_{n-1}(A) \xrightarrow{H_{n-1}(i)} \dots$$

is exact.

Proof. Define the connecting homomorphism ∂_* . Let $[c] \in H_n(C)$ where $c \in C_n$ is a cycle. Since $j : B_n \rightarrow C_n$ is an epimorphism, there is $b \in B_n$ such that $j(b) = c$. Further, $j(\partial b) = \partial j(b) = \partial c = 0$. From exactness there is $a \in A_{n-1}$ such that $i(a) = \partial b$. Since $i(\partial a) = \partial i(a) = \partial \partial b = 0$ and i is a monomorphism, $\partial a = 0$ and a is a cycle in A_{n-1} . Put

$$\partial_*[c] = [a].$$

Now we have to show that the definition is correct, i. e. independent of the choice of c and b , and to prove exactness. For this purpose it is advantageous to use an appropriate diagram. It is not difficult and we leave it as an exercise to the reader. \square

3.5. Chain homotopy. Let $f, g : C \rightarrow D$ be two chain homomorphisms. We say that they are *chain homotopic* if there are homomorphisms $s_n : C_n \rightarrow D_{n+1}$ such that

$$\partial_{n+1}^D s_n + s_{n-1} \partial_n^C = f_n - g_n \quad \text{for all } n.$$

The relation to be chain homotopic is an equivalence. The sequence of maps s_n is called a *chain homotopy*.

Theorem. If two chain homomorphism $f, g : C \rightarrow D$ are chain homotopic, then

$$H_n(f) = H_n(g).$$

Exercise. Prove the previous theorem from the definitions.

3.6. Five Lemma. Consider the diagram

$$\begin{array}{ccccccccc} A & \longrightarrow & B & \longrightarrow & C & \longrightarrow & D & \longrightarrow & E \\ f_1 \downarrow \cong & & f_2 \downarrow \cong & & f_3 \downarrow & & f_4 \downarrow \cong & & f_5 \downarrow \cong \\ \bar{A} & \longrightarrow & \bar{B} & \longrightarrow & \bar{C} & \longrightarrow & \bar{D} & \longrightarrow & \bar{E} \end{array}$$

If the horizontal sequences are exact and f_1, f_2, f_4 and f_5 are isomorphisms, then f_3 is also an isomorphism.

Exercise. Prove 5-lemma.

3.7. Simplicial homology. We describe two basic ways how to define homology groups for topological spaces – simplicial homology which is closer to geometric intuition and singular homology which is more general. For the definition of simplicial homology we need the notion of Δ -complex, which is a special case of CW-complex.

Let v_0, v_1, \dots, v_n be points in \mathbb{R}^m such that $v_1 - v_0, v_2 - v_0, \dots, v_n - v_0$ are linearly independent. The n -simplex $[v_0, v_1, \dots, v_n]$ with the vertices v_0, v_1, \dots, v_n is the subspace of \mathbb{R}^m

$$\left\{ \sum_{i=0}^n t_i v_i; \sum_{i=0}^n t_i = 1, t_i \geq 0 \right\}$$

with a given ordering of vertices. A *face* of this simplex is any simplex determined by a proper subset of vertices in the given ordering.

Let $\Delta_\alpha, \alpha \in J$ be a collection of simplices. Subdivide all their faces of dimension i into sets F_β^i . A Δ -complex is a quotient space of disjoint union $\coprod_{\alpha \in J} \Delta_\alpha$ obtained by identifying simplices from every F_β^i into one single simplex via affine maps which preserve the ordering of vertices. Thus every Δ -complex is determined only by combinatorial data.

A special case of Δ -complex is a *finite simplicial complex*. It is a union of simplices the vertices of which lie in a given finite set of points $\{v_0, v_1, \dots, v_n\}$ in \mathbb{R}^m such that $v_1 - v_0, v_2 - v_0, \dots, v_n - v_0$ are linearly independent.

Example. Torus, real projective space of dimension 2 and Klein bottle are Δ -complexes as one can see from the following pictures.

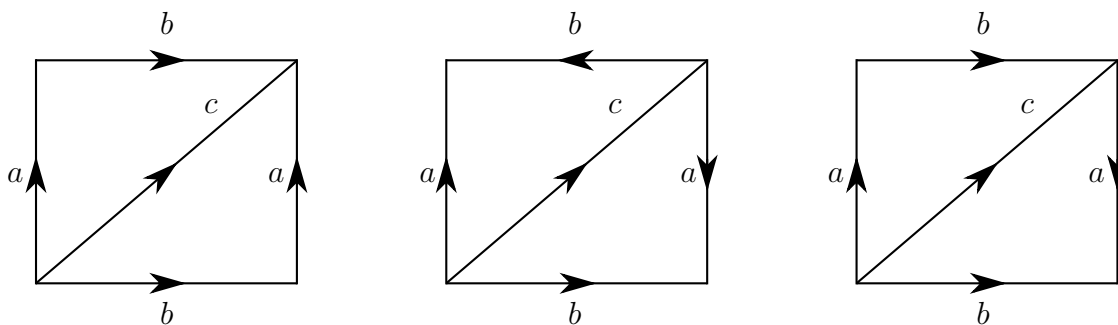

FIGURE 3.1. Torus, $\mathbb{R}P^2$ and Klein bottle as Δ -complexes

In all the cases we have two sets F^2 whose elements are triangles, three sets F^1 every with two segments and one set F^0 containing all six vertices of both triangles.

These surfaces are also homeomorphic to finite simplicial complexes, but their structure as simplicial complexes is more complicated than their structure as Δ -complexes.

To every Δ -complex X we can assign the chain complex (C, ∂) where $C_n(X)$ is a free Abelian group generated by n -simplices of X (i. e. the rank of $C_n(X)$ is the number of the sets F^n and the boundary operator on generators is given by

$$\partial[v_0, v_1, \dots, v_n] = \sum_{i=0}^n (-1)^i [v_0, \dots, \hat{v}_i, \dots, v_n].$$

Here the symbol \hat{v}_i means that the vertex v_i is omitted. Prove that $\partial\partial = 0$.

The *simplicial homology groups* of Δ -complex X are the homology groups of the chain complex defined above. Later, we will show that these groups are independent of Δ -complex structure.

Exercise. Compute simplicial homology of S^2 (find a Δ -complex structure), \mathbb{RP}^2 , torus and Klein bottle (with Δ -complex structures given in example above).

Let X and Y be two Δ -complexes and $f : X \rightarrow Y$ a map which maps every simplex of X into a simplex of Y and it is affine on all simplexes. Using appropriate sign conventions we can define the chain homomorphism $f_n : C_n(X) \rightarrow C_n(Y)$ induced by the map f . This chain map enables us to define homomorphism of simplicial homology groups induced by f .

Having a Δ -subcomplex A of a Δ -complex X (i. e. subspace of X formed by some of the simplices of X) we can define simplicial homology groups $H_n(X, A)$. The definition is the same as for singular homology in paragraph 3.9. These groups fit into the long exact sequence

$$\dots \rightarrow H_n(A) \rightarrow H_n(X) \rightarrow H_n(X, A) \rightarrow H_{n-1}(A) \rightarrow \dots$$

See again 3.9.

3.8. Singular homology. The *standard n -simplex* is the n -simplex

$$\Delta^n = \{(t_0, t_1, \dots, t_n) \in \mathbb{R}^{n+1}; \sum_{i=0}^n t_i = 1; t_i \geq 0\}.$$

The j -th face of this standard simplex is the $(n-1)$ -dimensional simplex $[e_0, \dots, \hat{e}_j, \dots, e_n]$ where e_j is the vertex with all coordinates 0 with the exception of the j -th one which is 1. Define

$$\varepsilon_n^j : \Delta^{n-1} \rightarrow \Delta^n$$

as the affine map $\varepsilon_n^j(t_0, t_1, \dots, t_{n-1}) = (t_0, \dots, t_{j-1}, 0, t_j, \dots, t_{n-1})$ which maps

$$e_0 \rightarrow e_0, \dots, e_{j-1} \rightarrow e_{j-1}, e_j \rightarrow e_{j+1}, \dots, e_{n-1} \rightarrow e_n.$$

It is not difficult to prove

Lemma. $\varepsilon_{n+1}^k \varepsilon_n^j = \varepsilon_{n+1}^{j+1} \varepsilon_n^k$ for $k < j$.

A *singular n -simplex* in a space X is a continuous map $\sigma : \Delta^n \rightarrow X$. Denote the free Abelian group generated by all the singular n -simplices by $C_n(X)$ and define the boundary operator $\partial_n : C_n(X) \rightarrow C_{n-1}(X)$ by

$$\partial_n(\sigma) = \sum_{i=0}^n (-1)^i \sigma \varepsilon_n^i$$

for $n \geq 0$. Put $C_n(X) = 0$ for $n < 0$. Using the lemma above one can show that

$$\partial_{n+1} \partial_n = 0.$$

The chain complex (C_n, ∂_n) is called the *singular chain complex* of the space X . The *singular homology groups* $H_n(X)$ of the space X are the homology groups of the chain complex $(C_n(X), \partial_n)$, i. e.

$$H_n(X) = \frac{\text{Ker } \partial_n}{\text{Im } \partial_{n+1}}.$$

Next consider a map $f : X \rightarrow Y$. Define the chain homomorphism $C_n(f) : C_n(X) \rightarrow C_n(Y)$ on singular n -simplices as the composition

$$C_n(f)(\sigma) = f\sigma.$$

From definitions it is easy to show that these homomorphisms commute with boundary operators. Hence this chain homomorphism induces homomorphisms

$$f_* = H_n(f) : H_n(X) \rightarrow H_n(Y).$$

Moreover, $H_n(\text{id}_X) = \text{id}_{H_n(X)}$ and $H_n(fg) = H_n(f)H_n(g)$. It means that H_n is a functor from the category **Top** to the category **Ab** of Abelian groups and their homomorphisms. This functor is the composition of the functor C from **Top** to chain complexes and the n -th homology functor from chain complexes to abelian groups.

Prove the lemma above and $\partial_{n+1} \partial_n = 0$.

Show directly from the definition that the singular homology groups of a point are $H_0(*) = \mathbb{Z}$ and $H_n(*) = 0$ for $n \neq 0$.

3.9. Singular homology groups of a pair. Consider a pair of topological spaces (X, A) . Then the $C_n(A)$ is a subgroup of $C_n(X)$. Hence we get this short exact sequence

$$0 \rightarrow C_n(A) \xrightarrow{i} C_n(X) \xrightarrow{j} \frac{C_n(X)}{C_n(A)} \rightarrow 0.$$

Since the boundary operators in $C_n(A)$ are restrictions of boundary operators in $C_n(X)$, we can define boundary operators

$$\partial_n : \frac{C_n(X)}{C_n(A)} \rightarrow \frac{C_{n-1}(X)}{C_{n-1}(A)}.$$

We will denote this chain complex as $(C(X, A), \partial)$ and its homology groups as $H_n(X, A)$. Notice that the factor $C_n(X)/C_n(A)$ is a free Abelian group generated by singular simplices $\sigma : \Delta^n \rightarrow X$ such that $\sigma(\Delta^n) \not\subseteq A$. We will need it later.

A map $f : (X, A) \rightarrow (Y, B)$ induces the chain homomorphism $C_n(f) : C_n(X) \rightarrow C_n(Y)$ which restricts to a chain homomorphism $C_n(A) \rightarrow C_n(B)$ since $f(A) \subseteq B$. Hence we can define the chain homomorphism

$$C_n(f) : C_n(X, A) \rightarrow C_n(Y, B)$$

which in homology induces the homomorphism

$$f_* = H_n(f) : H_n(X, A) \rightarrow H_n(Y, B).$$

We can again conclude that H_n is a functor from the category \mathbf{Top}^2 into the category \mathbf{Ab} of Abelian groups. This functor extends the functor defined on the category \mathbf{Top} since every object X and every morphism $f : X \rightarrow Y$ in \mathbf{Top} can be considered as the object (X, \emptyset) and the morphism $\hat{f} = f : (X, \emptyset) \rightarrow (Y, \emptyset)$ in the category \mathbf{Top}^2 and

$$H_n(X, \emptyset) = H_n(X), \quad H_n(\hat{f}) = H_n(f).$$

3.10. Long exact sequence for singular homology. Consider inclusions of spaces $i : A \rightarrow X$, $i' : B \rightarrow Y$ and maps $j : (X, \emptyset) \rightarrow (X, A)$, $j' : (Y, \emptyset) \rightarrow (Y, B)$ induced by id_X and id_Y , respectively. Let $f : (X, A) \rightarrow (Y, B)$ be a map. Then there are connecting homomorphisms ∂_*^X and ∂_*^Y such that the following diagram

$$\begin{array}{ccccccccc} \xrightarrow{\partial_*^X} & H_n(A) & \xrightarrow{i_*} & H_n(X^1) & \xrightarrow{j_*} & H_n(X, A) & \xrightarrow{\partial_*^X} & H_{n-1}(A) & \xrightarrow{i_*} & \longrightarrow \\ & \downarrow (f/A)_* & & \downarrow f_* & & \downarrow f_* & & \downarrow (f/A)_* & & \\ \xrightarrow{\partial_*^Y} & H_n(B) & \xrightarrow{i'_*} & H_n(Y) & \xrightarrow{j'_*} & H_n(Y, B) & \xrightarrow{\partial_*^Y} & H_{n-1}(B) & \xrightarrow{i'_*} & \longrightarrow \end{array}$$

commutes and its horizontal sequences are exact.

An analogous theorem holds also for simplicial homology.

Remark. Consider the functor $I : \mathbf{Top}^2 \rightarrow \mathbf{Top}^2$ which assigns to every pair (X, A) the pair (A, \emptyset) . The commutativity of the last square in the diagram above means that ∂_* is a natural transformation of functors H_n and $H_{n-1} \circ I$ defined on \mathbf{Top}^2 .

Proof. We have the following commutative diagram of chain complexes

$$\begin{array}{ccccccc} 0 & \longrightarrow & C(A) & \xrightarrow{C(i)} & C(X) & \xrightarrow{C(j)} & C(X, A) & \longrightarrow & 0 \\ & & \downarrow C(f/A) & & \downarrow C(f) & & \downarrow C(f) & & \\ 0 & \longrightarrow & C(B) & \xrightarrow{C(i')} & C(Y) & \xrightarrow{C(j')} & C(Y, B) & \longrightarrow & 0 \end{array}$$

with exact horizontal rows. Then Theorem 3.4 and the construction of connecting homomorphism ∂_* imply the required statement. \square

Remark. It is useful to realize how $\partial_* : H_n(X, A) \rightarrow H_{n-1}(A)$ is defined. Every element of $H_n(X, A)$ is represented by a chain $x \in C_n(X)$ with a boundary $\partial x \in C_{n-1}(A)$. This is a cycle in $C_n(A)$ and from the definition in 3.4 we have

$$\partial_*[x] = [\partial x].$$

3.11. Homotopy invariance. If two maps $f, g : (X, A) \rightarrow (Y, B)$ are homotopic, then they induce the same homomorphisms

$$f_* = g_* : H_n(X, A) \rightarrow H_n(Y, B).$$

Proof. We need to prove that the homotopy between f and g induces a chain homotopy between $C_*(f)$ and $C_*(g)$. For the proof see [Hatcher], Theorem 2.10 and Proposition 2.19 or [Spanier], Chapter 4, Section 4. \square

Corollary. If X and Y are homotopy equivalent spaces, then

$$H_n(X) \cong H_n(Y).$$

3.12. Excision Theorem. There are two equivalent versions of this theorem.

Theorem (Excision Theorem, 1st version). Consider spaces $C \subseteq A \subseteq X$ and suppose that $\bar{C} \subseteq \text{int } A$. Then the inclusion

$$i : (X - C, A - C) \hookrightarrow (X, A)$$

induces the isomorphism

$$i_* : H_n(X - C, A - C) \xrightarrow{\cong} H_n(X, A).$$

Theorem (Excision Theorem, 2nd version). Consider two subspaces A and B of a space X . Suppose that $X = \text{int } A \cup \text{int } B$. Then the inclusion

$$i : (B, A \cap B) \hookrightarrow (X, A)$$

induces the isomorphism

$$i_* : H_n(B, A \cap B) \xrightarrow{\cong} H_n(X, A).$$

The second version of Excision Theorem holds also for simplicial homology if we suppose that A and B are Δ -subcomplexes of a Δ -complex X and $X = A \cup B$. In this case the proof is easy since the inclusion

$$C_n(i) : C_n(B, A \cap B) \rightarrow C_n(A \cup B, A)$$

is an isomorphism, namely the both chain complexes are generated by the same n -simplices.

Exercise. Show that the theorems above are equivalent.

The proof of Excision Theorem for singular homology can be found in [Hatcher], pages 119 – 124, or in [Spanier], Chapter 4, Sections 4 and 6. The main step (a little bit technical for beginners) is to prove the following lemma which we will need later.

Lemma. Let $\mathcal{U} = \{U_\alpha; \alpha \in J\}$ be a collection of subsets of X such that $X = \bigcup_{\alpha \in J} \text{int } U_\alpha$. Denote the free chain complex generated by singular simplices σ with $\sigma(\Delta^n) \in U_\alpha$ for some α as $C_n^{\mathcal{U}}(X)$. Then

$$C_n^{\mathcal{U}}(X) \hookrightarrow C_n(X)$$

induces isomorphism in homology.

Proof of Excision Theorem. Consider $\mathcal{U} = \{A, B\}$. Then the inclusion

$$C_n(i) : C_n(B, A \cap B) \rightarrow \frac{C_n^{\mathcal{U}}(X)}{C_n(A)}$$

is an isomorphism and, moreover, according to the previous lemma, the homology of the second chain complex is $H_n(X, A)$. \square

3.13. Homology of disjoint union. Let $X = \coprod_{\alpha \in J} X_\alpha$ be a disjoint union. Then

$$H_n(X) = \bigoplus_{\alpha \in J} H_n(X_\alpha).$$

The proof follows from the definition and connectivity of $\sigma(\Delta^n)$ in X for every singular n -simplex σ .

3.14. Reduced homology groups. For every space $X \neq \emptyset$ we define the *augmented chain complex* $(\tilde{C}(X), \tilde{\partial})$ as follows

$$\tilde{C}_n(X) = \begin{cases} C_n(X) & \text{for } n \neq -1, \\ \mathbb{Z} & \text{for } n = -1. \end{cases}$$

with $\tilde{\partial}_n = \partial_n$ for $n \neq 0$ and $\tilde{\partial}_0(\sum_{i=1}^j n_i \sigma_i) = \sum_{i=1}^j n_i$. The *reduced homology groups* $\tilde{H}_n(X)$ are the homology groups of the augmented chain complex. From the definition it is clear that

$$\tilde{H}_n(X) = H_n(X) \quad \text{for } n \neq 0$$

and

$$\tilde{H}_n(*) = 0 \quad \text{for all } n.$$

For pairs of spaces we define $\tilde{H}_n(X, A) = H_n(X, A)$ for all n . Then theorems on long exact sequence, homotopy invariance and excision hold for reduced homology groups as well.

Considering a space X with distinguished point $*$ and applying the long exact sequence for the pair $(X, *)$, we get that for all n

$$\tilde{H}_n(X) = \tilde{H}_n(X, *) = H_n(X, *).$$

Using this equality and the long exact sequence for unreduced homology we get that

$$H_0(X) \cong H_0(X, *) \oplus H_0(*) \cong \tilde{H}_0(X) \oplus \mathbb{Z}.$$

Lemma. Let (X, A) be a pair of CW-complexes, $X \neq \emptyset$. Then

$$\tilde{H}_n(X/A) = H_n(X, A)$$

and we have the long exact sequence

$$\cdots \rightarrow \tilde{H}_n(A) \rightarrow \tilde{H}_n(X) \rightarrow \tilde{H}_n(X/A) \rightarrow \tilde{H}_{n-1}(A) \rightarrow \cdots$$

Proof. According to example in Section 2

$$(X, A) \rightarrow (X \cup CA, CA) \rightarrow (X \cup CA/CA, *) = (X/A, *)$$

is the composition of an excision and a homotopy equivalence. Hence $\tilde{H}_n(X/A) = H_n(X, A)$. The rest follows from the long exact sequence of the pair (X, A) . \square

Exercise. Prove that $\tilde{H}_n(\bigvee X_\alpha) \cong \bigoplus \tilde{H}_n(X_\alpha)$.

\tilde{H}_n can be considered as a functor from \mathbf{Top}_* to Abelian groups.

3.15. The long exact sequence of a triple. Three spaces (X, B, A) with the property $A \subseteq B \subseteq X$ are called a *triple*. Denote $i : (B, A) \rightarrow (X, A)$ and $j : (X, A) \rightarrow (X, B)$ maps induced by the inclusion $B \hookrightarrow X$ and id_X , respectively. Analogously as for pairs one can derive the following long exact sequence:

$$\dots \xrightarrow{\partial_*} H_n(B, A) \xrightarrow{i_*} H_n(X, A) \xrightarrow{j_*} H_n(X, B) \xrightarrow{\partial_*} H_{n-1}(B, A) \xrightarrow{i_*} \dots$$

3.16. Singular homology groups of spheres. Consider the long exact sequence of the triple $(\Delta^n, \partial\Delta^n, \Lambda^{n-1} = \partial\Delta^n - \Delta^{n-1})$:

$$\dots \rightarrow H_i(\Delta^n, \Lambda^{n-1}) \rightarrow H_i(\Delta^n, \partial\Delta^n) \xrightarrow{\partial_*} H_{i-1}(\partial\Delta^n, \Lambda^{n-1}) \rightarrow H_{i-1}(\Delta^n, \Lambda^{n-1}) \rightarrow \dots$$

The pair $(\Delta^n, \Lambda^{n-1})$ is homotopy equivalent to $(*, *)$ and hence its homology groups are zeroes. Next using Excision Theorem and homotopy invariance we get that $H_i(\Delta^n, \Lambda^{n-1}) \cong H_i(\Delta^{n-1}, \partial\Delta^{n-1})$. Consequently, we get an isomorphism

$$H_i(\Delta^n, \partial\Delta^n) \cong H_{i-1}(\Delta^{n-1}, \partial\Delta^{n-1}).$$

Using induction and computing $H_i(\Delta^1, \partial\Delta^1) = H_i([0, 1], \{0, 1\}) \cong H_{i-1}(\{0, 1\}, \{0\})$ we get that

$$H_i(\Delta^n, \partial\Delta^n) = \begin{cases} \mathbb{Z} & \text{for } i = n, \\ 0 & \text{for } i \neq n. \end{cases}$$

Doing the induction carefully we can find that the generator of the group $H_n(\Delta^n, \partial\Delta^n) = \mathbb{Z}$ is determined by the singular n -simplex id_{Δ^n} .

The pair (D^n, S^{n-1}) is homeomorphic to $(\Delta^n, \partial\Delta^n)$. Hence it has the same homology groups. Using the long exact sequence for this pair we obtain

$$\tilde{H}_{i-1}(S_{n-1}) = H_i(D^n, S^{n-1}) = \begin{cases} 0 & \text{for } i \neq n, \\ \mathbb{Z} & \text{for } i = n. \end{cases}$$

3.17. Mayer-Vietoris exact sequence. Denote inclusions $A \cap B \hookrightarrow A$, $A \cap B \hookrightarrow B$, $A \hookrightarrow X$, $B \hookrightarrow X$ by i_A , i_B , j_A , j_B , respectively. Let $C \hookrightarrow A \cap B$ and suppose that $X = \text{int } A \cup \text{int } B$. Then the following sequence

$$\begin{aligned} \dots \xrightarrow{\partial_*} H_n(A \cap B, C) &\xrightarrow{(i_{A*}, i_{B*})} H_n(A, C) \oplus H_n(B, C) \\ &\xrightarrow{j_{A*} - j_{B*}} H_n(X, C) \xrightarrow{\partial_*} H_{n-1}(A \cap B, C) \rightarrow \dots \end{aligned}$$

is exact.

Proof. The covering $\mathcal{U} = \{A, B\}$ satisfies conditions of Lemma 3.12. The sequence of chain complexes

$$0 \longrightarrow \frac{C(A \cap B)}{C(C)} \xrightarrow{i} \frac{C(A)}{C(C)} \oplus \frac{C(B)}{C(C)} \xrightarrow{j} \frac{C^{\mathcal{U}}(X)}{C(C)} \longrightarrow 0$$

where $i(x) = (x, x)$ and $j(x, y) = x - y$ is exact. Consequently, it induces a long exact sequence. Using Lemma 3.12 we get that $H_n(C^{\mathcal{U}}(X), C(C)) = H_n(X, C)$, which completes the proof. \square

3.18. Equality of simplicial and singular homology. Let (X, A) be a pair of Δ -complexes. Then the natural inclusion of simplicial and singular chain complexes $C^{\Delta}(X, A) \hookrightarrow C(X, A)$ induces the isomorphism of simplicial and singular homology groups

$$H_n^{\Delta}(X, A) \cong H_n(X, A).$$

Outline of the proof. Consider the long exact sequences for the pair (X^k, X^{k-1}) of skeletons of X . We get

$$\begin{array}{ccccccccc} H_{n+1}^{\Delta}(X^k, X^{k-1}) & \longrightarrow & H_n^{\Delta}(X^{k-1}) & \longrightarrow & H_n^{\Delta}(X^k) & \longrightarrow & H_n^{\Delta}(X^k, X^{k-1}) & \longrightarrow & H_{n-1}^{\Delta}(X^{k-1}) \\ \downarrow & & \downarrow & & \downarrow & & \downarrow & & \downarrow \\ H_{n+1}(X^k, X^{k-1}) & \longrightarrow & H_n(X^{k-1}) & \longrightarrow & H_n(X^k) & \longrightarrow & H_n(X^k, X^{k-1}) & \longrightarrow & H_{n-1}(X^{k-1}) \end{array}$$

Using induction by k we have $H_i^{\Delta}(X^{k-1}) = H_i(X^{k-1})$ for all i . Further, $C_i^{\Delta}(X^k, X^{k-1})$ is according to definition zero if $i \neq k$ and free Abelian of rank equal the number of i -simplices Δ_{α}^i if $i = k$. The homology groups $H_i^{\Delta}(X^k, X^{k-1})$ have the same description.

Since

$$\coprod_{\alpha} \Delta_{\alpha}^k / \coprod_{\alpha} \partial \Delta_{\alpha}^k = X^k / X^{k-1}$$

we get the isomorphism

$$H_i^{\Delta}(X^k / X^{k-1}) \rightarrow H_i\left(\coprod_{\alpha} \Delta_{\alpha}^k / \coprod_{\alpha} \partial \Delta_{\alpha}^k\right) = H_i(X^k / X^{k-1}).$$

Applying 5-lemma (see 3.6) in the diagram above, we get that $H_n^{\Delta}(X^k) \rightarrow H_n(X^k)$ is an isomorphism.

If X is finite Δ -complex, we are ready. If it is not, we have to prove that $H_n^{\Delta}(X) = H_n(X)$. See [Hatcher], page 130. \square

4. HOMOLOGY OF CW-COMPLEXES AND APPLICATIONS

4.1. First applications of homology. Using homology groups we can easily prove the following statements:

- (1) S^n is not a retract of D^{n+1} .
- (2) Every map $f : D^n \rightarrow D^n$ has a fixed point, i.e. there is $x \in D^n$ such that $f(x) = x$.
- (3) If $\emptyset \neq U \subseteq \mathbb{R}^n$ and $\emptyset \neq V \subseteq \mathbb{R}^m$ are open homeomorphic sets, then $n = m$.

Outline of the proof. (1) Suppose that there is a retraction $r : D^{n+1} \rightarrow S^n$. Then we get the commutative diagram

$$\begin{array}{ccc} \mathbb{Z} = H_n(S^n) & \xrightarrow{\text{id}} & H_n(S^n) = \mathbb{Z} \\ & \searrow i_* & \nearrow r_* \\ & & H_n(D^{n+1}) = 0 \end{array}$$

which is a contradiction.

(2) Suppose that $f : D^n \rightarrow D^n$ has no fixed point. Then we can define the map $g : D^n \rightarrow S^{n-1}$ where $g(x)$ is the intersection of the ray from $f(x)$ to x with S^{n-1} . However, this map would be a retraction, a contradiction with (1).

(3) The proof of the last statement follows from the isomorphisms:

$$H_i(U, U - \{x\}) \cong H_i(\mathbb{R}^n, \mathbb{R}^n - \{x\}) \cong \tilde{H}_{i-1}(\mathbb{R}^n - \{x\}) \cong \tilde{H}_{i-1}(S^{n-1}) = \begin{cases} \mathbb{Z} & \text{for } i = n, \\ 0 & \text{for } i \neq n. \end{cases}$$

□

4.2. Degree of a map. Consider a map $f : S^n \rightarrow S^n$. In homology $f_* : \tilde{H}_n(S^n) \rightarrow \tilde{H}_n(S^n)$ has the form

$$f_*(x) = ax, \quad a \in \mathbb{Z}.$$

The integer a is called the *degree* of f and denoted by $\deg f$.

The degree has the following properties:

- (1) $\deg \text{id} = 1$.
- (2) If $f \sim g$, then $\deg f = \deg g$.
- (3) If f is not surjective, then $\deg f = 0$.
- (4) $\deg(fg) = \deg f \cdot \deg g$.
- (5) Let $f : S^n \rightarrow S^n$, $f(x_0, x_1, \dots, x_n) = (-x_0, x_1, \dots, x_n)$. Then $\deg f = -1$.
- (6) The antipodal map $f : S^n \rightarrow S^n$, $f(x) = -x$ has $\deg f = (-1)^{n+1}$.
- (7) If $f : S^n \rightarrow S^n$ has no fixed point, then $\deg f = (-1)^{n+1}$.

Proof. We outline only the proof of (5) and (7). The rest is not difficult and left as an exercise.

We show (5) by induction on n . The generator of $\tilde{H}_0(S^0)$ is $1 - (-1)$ and f_* maps it in $(-1) - 1$. Hence the degree is -1 . Suppose that the statement is true for n . To

prove it for $n + 1$ we use the diagram with rows coming from a suitable Mayer-Vietoris exact sequence

$$\begin{array}{ccccccc} 0 & \longrightarrow & \tilde{H}_{n+1}(S^{n+1}) & \xrightarrow{\cong} & \tilde{H}_n(S^n) & \longrightarrow & 0 \\ & & f_* \downarrow & & \downarrow (f/S^n)_* & & \\ 0 & \longrightarrow & \tilde{H}_{n+1}(S^{n+1}) & \xrightarrow{\cong} & \tilde{H}_n(S^n) & \longrightarrow & 0 \end{array}$$

If $(f/S^n)_*$ is a multiplication by -1 , so is f_* .

To prove (7) we show that f is homotopic to the antipodal map through the homotopy

$$H(x, t) = \frac{tf(x) - (1-t)x}{\|tf(x) - (1-t)x\|}.$$

□

Corollary. S^n has a nonzero continuous vector field if and only if n is odd.

Proof. Let S^n has such a field $v(x)$. We can suppose $\|v(x)\| = 1$. Then the identity is homotopic to antipodal map through the homotopy

$$H(x, t) = \cos t\pi \cdot x + \sin t\pi \cdot v(x).$$

Hence according to properties (2) and (6)

$$(-1)^{n+1} = \deg(-\text{id}) = \deg(\text{id}) = 1.$$

Consequently, n is odd.

On the contrary, if $n = 2k + 1$, we can define the required vector field by prescription

$$v(x_0, x_1, x_2, x_3, \dots, x_{2k}, x_{2k+1}) = (-x_1, x_0, -x_3, x_2, \dots, -x_{2k+1}, x_{2k}).$$

□

Exercise. Prove the properties (3), (4) and (6) of the degree.

4.3. Local degree. Consider a map $f : S^n \rightarrow S^n$ and $y \in S^n$ such that $f^{-1}(y) = \{x_1, x_2, \dots, x_m\}$. Let U_i be open disjoint neighbourhoods of points x_i and V a neighbourhood of y such that $f(U_i) \subseteq V$. Then

$$\begin{aligned} (f/U_i)_* : H_n(U_i, U_i - \{x_i\}) &\cong H_n(S^n, S^n - \{x_i\}) = \mathbb{Z} \\ &\longrightarrow H_n(V, V - \{y\}) \cong H_n(S^n, S^n - \{y\}) = \mathbb{Z} \end{aligned}$$

is a multiplication by an integer which is called a *local degree* and denoted by $\deg f|_{x_i}$.

Theorem A. Let $f : S^n \rightarrow S^n$, $y \in S^n$ and $f^{-1}(y) = \{x_1, x_2, \dots, x_m\}$. Then

$$\deg f = \sum_{i=1}^m \deg f|_{x_i}.$$

For the proof see [Hatcher], Proposition 2.30, page 136.

The suspension Sf of a map $f : X \rightarrow Y$ is given by the prescription $Sf(x, t) = (f(x), t)$.

Theorem B. $\deg Sf = \deg f$ for any map $f : S^n \rightarrow S^n$.

Proof. f induces $Cf : CS^n \rightarrow CS^n$. The long exact sequence for the pair (CS^n, S^n) and the fact that $SS^n = CS^n/S^n$ give rise to the diagram

$$\begin{array}{ccccc} \tilde{H}_{n+1}(S^{n+1}) & \xrightarrow{\cong} & \tilde{H}_{n+1}(CS^n, S^n) & \xrightarrow{\cong} & \tilde{H}_n(S^n) \\ sf_* \downarrow & & Cf_* \downarrow & & \downarrow f_* \\ \tilde{H}_{n+1}(S^{n+1}) & \xrightarrow{\cong} & \tilde{H}_{n+1}(CS^n, S^n) & \xrightarrow{\cong} & \tilde{H}_n(S^n) \end{array}$$

which implies the statement. \square

Corollary. For any $n \geq 1$ and given $k \in \mathbb{Z}$ there is a map $f : S^n \rightarrow S^n$ such that $\deg f = k$.

Proof. For $n = 1$ put $f(z) = z^k$ where $z \in S^1 \subset \mathbb{C}$. Using the computation based on local degree as above, we get $\deg f = k$. The previous theorem implies that the degree of $S^{n-1}f : S^n \rightarrow S^n$ is also k . \square

4.4. Computations of homology of CW-complexes. If we know a CW-structure of a space X , we can compute its cohomology relatively easily. Consider the sequence of Abelian groups and its morphisms

$$(H_n(X^n, X^{n-1}), d_n)$$

where d_n is the composition

$$H_n(X^n, X^{n-1}) \xrightarrow{\partial_n} H_n(X^{n-1}) \xrightarrow{j_{n-1}} H_{n-1}(X^{n-1}, X^{n-2}).$$

Theorem. Let X be a CW-complex. $(H_n(X^n, X^{n-1}), d_n)$ is a chain complex with homology

$$H_n^{CW}(X) \cong H_n(X).$$

Proof. First, we show how the groups $H_k(X^n, X^{n-1})$ look like. Put $X^{-1} = \emptyset$ and $X^0/\emptyset = X^0 \sqcup \{*\}$. Then

$$H_k(X^n, X^{n-1}) = \tilde{H}_k(X^n/X^{n-1}) = \tilde{H}_k(\bigvee S_\alpha^n) = \begin{cases} \bigoplus_\alpha \mathbb{Z} & n = k, \\ 0 & n \neq k. \end{cases}$$

Now we show that

$$H_k(X^n) = 0 \quad \text{for } k > n.$$

From the long exact sequence of the pair (X^n, X^{n-1}) we get $H_k(X^n) = H_k(X^{n-1})$. By induction $H^k(X^n) = H^k(X^{-1}) = 0$.

Next we prove that

$$H_k(X^n) = H_k(X) \quad \text{for } k \leq n - 1.$$

From the long exact sequence for the pair (X^{n+1}, X^n) we obtain $H_k(X^n) = H_k(X^{n+1})$. By induction $H_k(X^n) = H_k(X^{n+m})$ for every $m \geq 1$. Since the image of each singular chain lies in some X^{n+m} we get $H_k(X^n) = H_k(X)$.

To prove Theorem we will need the following diagram with parts of exact sequences for the pairs (X^{n+1}, X^n) , (X^n, X^{n-1}) and (X^{n-1}, X^{n-2}) .

$$\begin{array}{ccccccc}
 & & 0 & & & & \\
 & & \uparrow & & & & \\
 & & H_n(X^{n+1}) & & & & \\
 & & \uparrow & & & & \\
 0 & \searrow & H_n(X^n) & & & & \\
 & & \uparrow & \searrow & j_n & & \\
 & & \partial_{n+1} & & H_n(X^n, X^{n-1}) & \xrightarrow{d_n} & H_{n-1}(X^{n-1}, X^{n-2}) \\
 & & \uparrow & \xrightarrow{d_{n+1}} & & & \\
 & & H_{n+1}(X^{n+1}, X^n) & & & & \\
 & & & & & & \uparrow \\
 & & & & & & j_{n-1} \\
 & & & & & & \uparrow \\
 & & & & & & H_{n-1}(X^{n-1}) \\
 & & & & & & \uparrow \\
 & & & & & & 0
 \end{array}$$

From it we get

$$d_n d_{n+1} = j_{n-1}(\partial_n j_n) \partial_{n+1} = j_{n-1}(0) \partial_{n+1} = 0.$$

Further,

$$\text{Ker } d_n = \text{Ker } \partial_n = \text{Im } j_n \cong H_n(X^n)$$

and

$$\text{Im } d_{n+1} \cong \text{Im } \partial_{n+1},$$

since j_{n-1} and j_n are monomorphisms. Finally,

$$H_n^{CW}(X) = \frac{\text{Ker } d_n}{\text{Im } d_{n+1}} \cong \frac{H_n(X^n)}{\text{Im } \partial_{n+1}} \cong H_n(X^{n+1}) \cong H_n(X).$$

□

Example. $H_n(X) = 0$ for CW-complexes without cells in dimension n .

$$H_k(\mathbb{C}\mathbb{P}^n) = \begin{cases} \mathbb{Z} & \text{for } k \leq 2n \text{ even,} \\ 0 & \text{in other cases.} \end{cases}$$

4.5. Computation of d_n . Let e_α^n and e_β^{n-1} be cells in dimension n and $n-1$ of a CW-complex X , respectively. Since

$$H_n(X^n, X^{n-1}) = \bigoplus_{\alpha} \mathbb{Z}, \quad H_{n-1}(X^{n-1}, X^{n-2}) = \bigoplus_{\beta} \mathbb{Z},$$

they can be considered as generators of these groups. Let $\varphi_\alpha : \partial D_\alpha^n \rightarrow X^{n-1}$ be the attaching map for the cell e_α^n . Then

$$d_n(e_\alpha^n) = \sum_{\beta} d_{\alpha\beta} e_\beta^{n-1}$$

where $d_{\alpha\beta}$ is the degree of the following composition

$$S^{n-1} = \partial D_\alpha^n \xrightarrow{\varphi_\alpha} X^{n-1} \rightarrow X^{n-1}/X^{n-2} \rightarrow X^n/(X^{n-2} \cup \bigcup_{\gamma \neq \beta} e_\gamma^{n-1}) = S^{n-1}.$$

For the proof we refer to [Hatcher], pages 140 and 141.

Exercise. Compute homology groups of various 2-dimensional surfaces (torus, Klein bottle, projective plane) using their CW-structure with only one cell in dimension 2.

4.6. Homology of real projective spaces. The real projective space $\mathbb{R}P^n$ is formed by cell e^0, e^1, \dots, e^n , one in each dimension from 0 to n . The attaching map for the cell e^{k+1} is the projection $\varphi : S^k \rightarrow \mathbb{R}P^k$. So we have to compute the degree of the composition

$$f : S^k \xrightarrow{\varphi} \mathbb{R}P^k \rightarrow \mathbb{R}P^k/\mathbb{R}P^{k-1} = S^k.$$

Every point in S^k has two preimages x_1, x_2 . In a neighbourhood U_i of x_i f is a homeomorphism, hence its local degree $\deg f|_{x_i} = \pm 1$. Since f/U_2 is the composition of the antipodal map with f/U_1 , the local degrees $\deg f|_{x_1}$ and $\deg f|_{x_2}$ differs by the multiple of $(-1)^{k+1}$. (See the properties (4) and (6) in 4.2.) According to 4.3

$$\deg f = \pm 1(1 + (-1)^{k+1}) = \begin{cases} 0 & \text{for } k+1 \text{ odd,} \\ \pm 2 & \text{for } k+1 \text{ even.} \end{cases}$$

So we have obtained the chain complex for computation of $H_*^{CW}(\mathbb{R}P^n)$. The result is

$$H_k(\mathbb{R}P^n) = \begin{cases} \mathbb{Z} & \text{for } k=0 \text{ and } k=n \text{ odd,} \\ \mathbb{Z}_2 & \text{for } k \text{ odd, } 0 < k < n, \\ 0 & \text{in other cases.} \end{cases}$$

4.7. Euler characteristic. Let X be a finite CW-complex. The *Euler characteristic* of X is the number

$$\chi(X) = \sum_{i=0}^{\infty} (-1)^i \text{rank } H_i(X).$$

Theorem. Let X be a finite CW-complex with c_k cells in dimension k . Then

$$\chi(X) = \sum_{k=0}^{\infty} (-1)^k c_k.$$

Proof. Realize that $c_k = \text{rank } H_k(X^k, X^{k-1}) = \text{rank Ker } d_k + \text{rank Im } d_{k+1}$ and that $\text{rank } H_k(X) = \text{rank Ker } d_k - \text{rank Im } d_{k+1}$. Hence

$$\begin{aligned}\chi(X) &= \sum_{k=0}^{\infty} (-1)^k \text{rank } H_k(X) = \sum_{k=0}^{\infty} (-1)^k (\text{rank Ker } d_k - \text{rank Im } d_{k+1}) \\ &= \sum_{k=0}^{\infty} (-1)^k \text{rank Ker } d_k + \sum_{k=0}^{\infty} (-1)^k \text{rank Im } d_k = \sum_{k=0}^{\infty} (-1)^k c_k.\end{aligned}$$

□

Example. 2-dimensional oriented surface of genus g (the number of handles attached to the 2-sphere) has the Euler characteristic $\chi(M_g) = 2 - 2g$.

2-dimensional nonorientable surface of genus g (the number of Möbius bands which replace discs cut out from the 2-sphere) has the Euler characteristic $\chi(N_g) = 2 - g$.

4.8. Lefschetz Fixed Point Theorem. Let G be a finitely generated Abelian group and $h : G \rightarrow G$ a homomorphism. The trace $\text{tr } h$ is the trace of the homomorphism

$$\mathbb{Z}^n \cong G / \text{Torsion } G \rightarrow G / \text{Torsion } G \cong \mathbb{Z}^n$$

induced by h .

Let X be a finite CW-complex. The *Lefschetz number* of a map $f : X \rightarrow X$ is

$$L(f) = \sum_{i=0}^{\infty} (-1)^i \text{tr } H_i f.$$

Notice that $L(\text{id}_X) = \chi(X)$. Similarly as for the Euler characteristic we can prove

Lemma. Let $f_n : (C_n, d_n) \rightarrow (C_n, d_n)$ be a chain homomorphism. Then

$$\sum_{i=0}^{\infty} (-1)^i \text{tr } H_i f = \sum_{i=0}^{\infty} (-1)^i \text{tr } f_i$$

whenever the right hand side is defined.

Theorem (Lefschetz Fixed Point Theorem). *If X is a finite simplicial complex or its retract and $f : X \rightarrow X$ a map with $L(f) \neq 0$, then f has a fixed point.*

For the proof see [Hatcher], Chapter 2C. Theorem has many consequences.

Corollary A (Brouwer Fixed Point Theorem). *Every continuous map $f : D^n \rightarrow D^n$ has a fixed point.*

Proof. The Lefschetz number of f is 1. □

In the same way we can prove

Corollary B. *If n is even, then every continuous map $f : \mathbb{R}P^n \rightarrow \mathbb{R}P^n$ has a fixed point.*

Corollary C. *Let M be a smooth compact manifold in \mathbb{R}^n with nonzero vector field. Then $\chi(M) = 0$.*

The converse of this statement is also true.

Outline of the proof. If M has a nonzero vector field, there is a continuous map $f : M \rightarrow M$ which is a "small shift in the direction of the vector field". Since such a map has no fixed point, its Lefschetz number has to be zero. Moreover, f is homotopic to identity and hence

$$\chi(M) = L(\text{id}_X) = L(f) = 0.$$

□

4.9. Homology with coefficients. Let G be an Abelian group. From the singular chain complex $(C_n(X), \partial_n)$ of a space X we make the new chain complex

$$C_n(X; G) = C_n(X) \otimes G, \quad \partial_n^G = \partial_n \otimes \text{id}_G.$$

The homology groups of X with coefficients G are

$$H_n(X; G) = H_n(C_*(X; G), \partial_*^G).$$

The homology groups defined before are in fact the homology groups with coefficients \mathbb{Z} . The homology groups with coefficients G satisfy all the basic general properties as the homology groups with integer coefficients with the exception that

$$H_n(; G) = \begin{cases} 0 & \text{for } n \neq 0, \\ G & \text{for } n = 0. \end{cases}$$

If the coefficient group G is a field (for instance $G = \mathbb{Q}$ or \mathbb{Z}_p for p a prime), then homology groups with coefficients G are vector spaces over this field. It often brings advantages.

The computation of homology with coefficients G can be carried out again using a CW-complex structure. For instance, we get

$$H_k(\mathbb{R}P^n; \mathbb{Z}_2) = \begin{cases} \mathbb{Z}_2 & \text{for } 0 \leq k \leq n, \\ 0 & \text{in other cases.} \end{cases}$$

For an application of \mathbb{Z}_2 -coefficients see the proof of the following theorem in [Hatcher], pages 174–176.

Theorem (Borsuk-Ulam Theorem). *Every map $f : S^n \rightarrow S^n$ satisfying*

$$f(-x) = -f(x)$$

has an odd degree.

5. SINGULAR COHOMOLOGY

Cohomology forms a dual notion to homology. To every topological space we assign a graded group $H^*(X)$ equipped with a ring structure given by a product $\cup : H^i(X) \times H^j(X) \rightarrow H^{i+j}(X)$. In this section we give basic definitions and properties of singular cohomology groups which are very similar to those of homology groups.

5.1. Cochain complexes. A *cochain complex* (C, δ) is a sequence of Abelian groups (or modules over a ring) and their homomorphisms indexed by integers

$$\dots \xrightarrow{\delta^{n-2}} C^{n-1} \xrightarrow{\delta^{n-1}} C^n \xrightarrow{\delta^n} C^{n+1} \xrightarrow{\delta^{n+1}} \dots$$

such that

$$\delta^n \delta^{n-1} = 0.$$

δ^n is called a coboundary operator. A *cochain homomorphism* of cochain complexes (C, δ_C) and (D, δ_D) is a sequence of homomorphisms of Abelian groups (or modules over a ring) $f^n : C^n \rightarrow D^n$ which commute with the coboundary operators

$$\delta_D^n f^n = f^{n+1} \delta_C^n.$$

5.2. Cohomology of cochain complexes. The n -th *cohomology group* of a cochain complex (C, δ) is the group

$$H^n(C) = \frac{\text{Ker } \delta^n}{\text{Im } \delta^{n-1}}.$$

The elements of $\text{Ker } \delta^n = Z^n$ are called *cocycles* of dimension n and the elements of $\text{Im } \delta^{n-1} = B^n$ are called *coboundaries* (of dimension n). If a cochain complex is exact, then its cohomology groups are trivial.

The component f^n of the cochain homomorphism $f : (C, \delta_C) \rightarrow (D, \delta_D)$ maps cocycles into cocycles and coboundaries into coboundaries. It enables us to define

$$H^n(f) : H^n(C) \rightarrow H^n(D)$$

by the prescription $H^n(f)[c] = [f^n(c)]$ where $[c] \in H^n(C)$ and $[f^n(c)] \in H^n(D)$ are classes represented by the elements $c \in Z^n(C)$ and $f^n(c) \in Z^n(D)$, respectively.

5.3. Long exact sequence in cohomology. A sequence of cochain homomorphisms

$$\dots \rightarrow A \xrightarrow{f} B \xrightarrow{g} C \rightarrow \dots$$

is exact if for every $n \in \mathbb{Z}$

$$\dots \rightarrow A^n \xrightarrow{f^n} B^n \xrightarrow{g^n} C^n \rightarrow \dots$$

is an exact sequence of Abelian groups. Similarly as for homology groups we can prove

Theorem. Let $0 \rightarrow A \xrightarrow{i} B \xrightarrow{j} C \rightarrow 0$ be a short exact sequence of cochain complexes. Then there is a so called connecting homomorphism $\delta^* : H^n(C) \rightarrow H^{n+1}(A)$

such that the sequence

$$\dots \xrightarrow{\delta^*} H^n(A) \xrightarrow{H^n(i)} H^n(B) \xrightarrow{H^n(j)} H^n(C) \xrightarrow{\delta^*} H^{n+1}(A) \xrightarrow{H^{n+1}(i)} \dots$$

is exact.

5.4. Cochain homotopy. Let $f, g : C \rightarrow D$ be two cochain homomorphisms. We say that they are *cochain homotopic* if there are homomorphisms $s^n : C^n \rightarrow D^{n-1}$ such that

$$\delta_D^{n-1} s^n + s^{n+1} \delta_C^n = f^n - g^n \quad \text{for all } n.$$

The relation to be cochain homotopic is an equivalence. The sequence of maps s^n is called a *cochain homotopy*. Similarly as for homology we have

Theorem. *If two cochain homomorphism $f, g : C \rightarrow D$ are cochain homotopic, then*

$$H^n(f) = H^n(g).$$

5.5. Singular cohomology groups of a pair. Consider a pair of topological spaces (X, A) , an inclusion $i : A \hookrightarrow X$ and an Abelian group G . Let

$$C(X, A) = (C_n(X)/C_n(A), \partial_n)$$

be the singular chain complex of the pair (X, A) . The *singular cochain complex* $(C(X, A; G), \delta)$ for the pair (X, A) is defined as

$$\begin{aligned} C^n(X, A; G) &= \text{Hom}(C_n(X, A), G) \cong \{h \in \text{Hom}(C_n(X), G); h|_{C_n(A)} = 0\} \\ &= \text{Ker } i^* : \text{Hom}(C_n(X), G) \longrightarrow \text{Hom}(C_n(A), G). \end{aligned}$$

and

$$\delta^n(h) = h \circ \partial_{n+1} \quad \text{for } h \in \text{Hom}(C_n(X, A), G).$$

The n -th *cohomology group* of the pair (X, A) with coefficients in the group G is the n -th cohomology group of this cochain complex

$$H^n(X, A; G) = H^n(C(X, A; G), \delta).$$

We write $H^n(X; G)$ for $H^n(X, \emptyset; G)$. A map $f : (X, A) \rightarrow (Y, B)$ induces the cochain homomorphism $C^n(f) : C^n(Y; G) \rightarrow C^n(X; G)$ by

$$C^n(f)(h) = h \circ C_n(f)$$

which restricts to a cochain homomorphism $C^n(Y, B; G) \rightarrow C^n(X, A; G)$ since $f(A) \subseteq B$. In cohomology it induces the homomorphism

$$f^* = H^n(f) : H^n(Y, B) \rightarrow H^n(X, A).$$

Moreover, $H^n(\text{id}_{(X, A)}) = \text{id}_{H^n(X, A; G)}$ and $H^n(fg) = H^n(g)H^n(f)$. We can conclude that H^n is a contravariant functor (cofunctor) from the category Top^2 into the category \mathcal{AG} of Abelian groups.

5.6. Long exact sequence for singular cohomology. Consider inclusions of spaces $i : A \hookrightarrow X$, $i' : B \hookrightarrow Y$ and maps $j : (X, \emptyset) \rightarrow (X, A)$, $j' : (Y, \emptyset) \rightarrow (Y, B)$ induced by id_X and id_Y , respectively. Let $f : (X, A) \rightarrow (Y, B)$ be a map. Then there are connecting homomorphisms δ_X^* and δ_Y^* such that the following diagram

$$\begin{array}{ccccccccccc} \dots & \xrightarrow{\delta_X^*} & H^n(X, A; G) & \xrightarrow{j^*} & H^n(X; G) & \xrightarrow{i^*} & H^n(A; G) & \xrightarrow{\delta_X^*} & H^{n+1}(X, A; G) & \xrightarrow{j^*} & \dots \\ & & \uparrow f^* & & \uparrow f^* & & \uparrow (f/B)^* & & \uparrow f^* & & \\ \dots & \xrightarrow{\delta_Y^*} & H^n(X, B; G) & \xrightarrow{j'^*} & H^n(Y; G) & \xrightarrow{i'^*} & H^n(B; G) & \xrightarrow{\delta_Y^*} & H^{n+1}(Y, B; G) & \xrightarrow{j'^*} & \dots \end{array}$$

commutes and its horizontal sequences are exact.

The proof follows from Theorem 5.3 using the fact that

$$0 \rightarrow C^n(X, A; G) \xrightarrow{C^n(j)} C^n(X; G) \xrightarrow{C^n(i)} C^n(A; G) \rightarrow 0$$

is a short exact sequence of cochain complexes as it follows directly from the definition of $C^n(X, A; G)$.

Remark A. Consider the functor $I : \text{Top}^2 \rightarrow \text{Top}^2$ which assigns to every pair (X, A) the pair (A, \emptyset) . The commutativity of the last square in the diagram above means that δ^* is a natural transformation of contravariant functors $H^n \circ I$ and H^{n+1} defined on Top^2 .

Remark B. It is useful to realize how $\delta^* : H^n(A; G) \rightarrow H^{n+1}(X, A; G)$ looks like. Every element of $H^n(A; G)$ is represented by a cochain $q \in \text{Hom}(C_n(A); G)$ with a zero coboundary $\delta q \in \text{Hom}(C_{n+1}(A); G)$. Extend q to $Q \in \text{Hom}(C_n(X); G)$ in arbitrary way. Then $\delta Q \in \text{Hom}(C_{n+1}(X), G)$ restricted to $C_{n+1}(A)$ is equal to $\delta q = 0$. Hence it lies in $\text{Hom}(C_{n+1}(X, A); G)$ and from the definition in 5.3 we have

$$\delta^*[q] = [\delta Q].$$

5.7. Homotopy invariance. If two maps $f, g : (X, A) \rightarrow (Y, B)$ are homotopic, then they induce the same homomorphisms

$$f^* = g^* : H^n(Y, B; G) \rightarrow H^n(X, A; G).$$

Proof. We already know that the homotopy between f and g induces a chain homotopy s_* between $C_*(f)$ and $C_*(g)$. Then we can define a cochain homotopy between $C^*(f)$ and $C^*(g)$ as

$$s^n(h) = h \circ s_{n-1} \quad \text{for } h \in \text{Hom}(C_n(Y); G)$$

and use Theorem 5.4. □

Corollary. *If X and Y are homotopy equivalent spaces, then*

$$H^n(X) \cong H^n(Y).$$

5.8. Excision Theorem. Similarly as for singular homology groups there are two equivalent versions of this theorem.

Theorem A (Excision Theorem, 1st version). *Consider spaces $C \subseteq A \subseteq X$ and suppose that $\bar{C} \subseteq \text{int } A$. Then the inclusion*

$$i : (X - C, A - C) \hookrightarrow (X, A)$$

induces the isomorphism

$$i^* : H^n(X, A; G) \xrightarrow{\cong} H^n(X - C, A - C; G).$$

Theorem B (Excision Theorem, 2nd version). *Consider two subspaces A and B of a space X . Suppose that $X = \text{int } A \cup \text{int } B$. Then the inclusion*

$$i : (B, A \cap B) \hookrightarrow (X, A)$$

induces the isomorphism

$$i^* : H^n(X, A; G) \xrightarrow{\cong} H^n(B, A \cap B; G).$$

The proof of Excision Theorem for singular cohomology follows from the proof of the homology version.

5.9. Cohomology of finite disjoint union. Let $X = \coprod_{\alpha=1}^k X_\alpha$ be a disjoint union. Then

$$H^n(X; G) = \bigoplus_{\alpha=1}^k H^n(X_\alpha).$$

The statement is not generally true for infinite unions.

5.10. Reduced cohomology groups. For every space $X \neq \emptyset$ we define the *augmented cochain complex* $(\tilde{C}^*(X; G), \tilde{\delta})$ as follows

$$\tilde{C}^n(X; G) = \text{Hom}(\tilde{C}_n(X); G)$$

with $\tilde{\delta}^n h = h \circ \tilde{\partial}_{n+1}$ for $h \in \text{Hom}(\tilde{C}_n(X); G)$. See 3.14. The *reduced cohomology groups* $\tilde{H}^n(X; G)$ with coefficients in G are the cohomology groups of the augmented cochain complex. From the definition it is clear that

$$\tilde{H}^n(X; G) = H^n(X; G) \quad \text{for } n \neq 0$$

and

$$\tilde{H}^n(*; G) = 0 \quad \text{for all } n.$$

For pairs of spaces we define $\tilde{H}^n(X, A; G) = H^n(X, A; G)$ for all n . Then theorems on long exact sequence, homotopy invariance and excision hold for reduced cohomology groups as well.

Considering a space X with base point $*$ and applying the long exact sequence for the pair $(X, *)$, we get that for all n

$$\tilde{H}^n(X; G) = \tilde{H}^n(X, *; G) = H^n(X, *; G).$$

Using this equality and the long exact sequence for unreduced cohomology we get that

$$H^0(X; G) \cong H^0(X, *; G) \oplus H^0(*; G) \cong \tilde{H}^0(X) \oplus \mathbb{G}.$$

Analogously as for homology groups we have

Lemma. *Let (X, A) be a pair of CW-complexes. Then*

$$\tilde{H}^n(X/A; G) = H^n(X, A; G)$$

and we have the long exact sequence

$$\dots \rightarrow \tilde{H}^n(X/A; G) \rightarrow \tilde{H}^n(X; G) \rightarrow \tilde{H}^n(A; G) \rightarrow \tilde{H}^{n+1}(X/A; G) \rightarrow \dots$$

5.11. The long exact sequence of a triple. Consider a triple (X, B, A) , $A \subseteq B \subseteq X$. Denote $i : (B, A) \hookrightarrow (X, A)$ and $j : (X, A) \rightarrow (X, B)$ maps induced by the inclusion $B \hookrightarrow X$ and id_X , respectively. Analogously as for homology one can derive the long exact sequence of the triple (X, B, A)

$$\dots \xrightarrow{\delta^*} H^n(X, B; G) \xrightarrow{j^*} H^n(X, A; G) \xrightarrow{i^*} H^n(B, A; G) \xrightarrow{\delta^*} H^{n+1}(X, B; G) \xrightarrow{j^*} \dots$$

5.12. Singular cohomology groups of spheres. Considering the long exact sequence of the triple $(\Delta^n, \partial\Delta^n, V = \delta\Delta^n - \Delta^{n-1})$: we get that

$$H^i(\Delta^n, \partial\Delta^n; G) = \begin{cases} G & \text{for } i = n, \\ 0 & \text{for } i \neq n. \end{cases}$$

The pair (D^n, S^{n-1}) is homeomorphic to $(\Delta^n, \partial\Delta^n)$. Hence it has the same cohomology groups. Using the long exact sequence for this pair we obtain

$$\tilde{H}^i(S^n; G) = H^{i+1}(D^{n+1}, S^n) = \begin{cases} 0 & \text{for } i \neq n, \\ G & \text{for } i = n. \end{cases}$$

5.13. Mayer-Vietoris exact sequence. Denote inclusions $A \cap B \hookrightarrow A$, $A \cap B \hookrightarrow B$, $A \hookrightarrow X$, $B \hookrightarrow X$ by i_A , i_B , j_A , j_B , respectively. Let $C \hookrightarrow A$, $D \hookrightarrow B$ and suppose that $X = \text{int } A \cup \text{int } B$, $Y = \text{int } C \cup \text{int } D$. Then there is the long exact sequence

$$\begin{aligned} \dots \xrightarrow{\delta^*} H^n(X, Y; G) &\xrightarrow{(j_A^*, j_B^*)} H^n(A, C; G) \oplus H^n(B, D; G) \\ &\xrightarrow{i_A^* - i_B^*} H_n(A \cap B, C \cap D; G) \xrightarrow{\delta^*} H^{n+1}(X, Y; G) \rightarrow \dots \end{aligned}$$

Proof. The coverings $\mathcal{U} = \{A, B\}$ and $\mathcal{V} = \{C, D\}$ satisfy conditions of Lemma 3.12. The sequence of chain complexes

$$0 \longrightarrow C_n(A \cap B, C \cap D) \xrightarrow{i} C_n(A, C) \oplus C_n(B, D) \xrightarrow{j} C_n^{\mathcal{U}, \mathcal{V}}(X, Y) \longrightarrow 0$$

where $i(x) = (x, x)$ and $j(x, y) = x - y$ is exact. Applying $\text{Hom}(-, G)$ we get a new short exact sequence of cochain complexes

$$0 \longrightarrow C_{\mathcal{U}, \mathcal{V}}^n(X, Y; G) \xrightarrow{j^*} C^n(A, C; G) \oplus C^n(B, D; G) \xrightarrow{i^*} C^n(A \cap B, C \cap D; G) \longrightarrow 0$$

and it induces a long exact sequence. Using Lemma 3.12 we get that $H^n(C_{\mathcal{U}, \mathcal{V}}(X, Y; G)) = H^n(X, Y; G)$, which completes the proof. \square

5.14. Computations of cohomology of CW-complexes. If we know a CW-structure of a space X , we can compute its cohomology in the same way as homology. Consider the chain complex from Section 4

$$(H_n(X^n, X^{n-1}), d_n).$$

Theorem. *Let X be a CW-complex. The n -th cohomology group of the cochain complex*

$$(\text{Hom}(H_n(X^n, X^{n-1}); G), d^n) \quad d^n(h) = h \circ d_n$$

is isomorphic to the n -th singular cohomology group $H^n(X; G)$.

Exercise A. After reading the next section try to prove the theorem above using the results and proofs from Section 4.

Exercise B. Compute singular cohomology of real and complex projective spaces with coefficients \mathbb{Z} and \mathbb{Z}_2 .

6. MORE HOMOLOGICAL ALGEBRA

In this section we will deal with algebraic constructions leading to the definitions of homology and cohomology groups with coefficients given in the previous sections. At the end we use introduced notions to state and prove so called universal coefficient theorems for singular homology and cohomology groups.

6.1. Functors and cofunctors. Let \mathbf{A} and \mathbf{B} be two categories. A *functor* $t : \mathbf{A} \rightarrow \mathbf{B}$ assigns to every object x in \mathbf{A} an object $t(x)$ in \mathbf{B} and to every morphism $f : x \rightarrow y$ in \mathbf{A} a morphism $t(f) : t(x) \rightarrow t(y)$ such that $t(\text{id}_x) = \text{id}_{t(x)}$ and $t(fg) = t(f)t(g)$.

A *contravariant functor* or briefly *cofunctor* $t : \mathbf{A} \rightarrow \mathbf{B}$ assigns to every object x in \mathbf{A} an object $t(x)$ in \mathbf{B} and to every morphism $f : x \rightarrow y$ in \mathbf{A} a morphism $t(f) : t(y) \rightarrow t(x)$ in \mathbf{B} such that $t(\text{id}_x) = \text{id}_{t(x)}$ and $t(fg) = t(g)t(f)$.

Let R be a commutative ring with a unit element. The category of R -modules and their homomorphisms will be denoted by $R\text{-Mod}$. $R\text{-GMod}$ will be used for the category of graded R -modules, $R\text{-Ch}$ and $R\text{-CoCh}$ will stand for the categories of chain complexes and the category of cochain complexes of R -modules, respectively. For $R = \mathbb{Z}$ the previous categories are Abelian groups Ab , graded Abelian groups GAb , chain complexes of Abelian groups Ch and cochain complexes of Abelian groups CoCh , respectively.

Homology H is a functor from the category $R\text{-Ch}$ to the category $R\text{-GMod}$. Let t be a functor from $R\text{-Mod}$ to $R\text{-Mod}$ which induces a functor $t : \text{Ch} \rightarrow \text{Ch}$, and let s be a cofunctor from $R\text{-Mod}$ to $R\text{-Mod}$, which induces a cofunctor from Ch to CoCh . The aim of this section is to say something about the functor $H \circ t$ and the cofunctor $H \circ s$. Model examples of such functors will be $t(-) = - \otimes_R M$ and $s(-) = \text{Hom}_R(-, M)$ for a fixed R -module M . We have already used these functors when we have defined homology and cohomology groups with coefficients.

6.2. Tensor product. The *tensor product* $A \otimes_R B$ of two R -modules A and B is the quotient of the free R -module over $A \times B$ and the ideal generated by the elements of the form

$$r(a, b) - (ra, b), \quad r(a, b) - (a, rb), \quad (a_1 + a_2, b) - (a_1, b) - (a_2, b), \quad (a, b_1 + b_2) - (a, b_1) - (a, b_2)$$

where $a, a_1, a_2 \in A$, $b, b_1, b_2 \in B$, $r \in R$. The class of equivalence of the element (a, b) in $A \otimes_R B$ is denoted by $a \otimes b$. The map $\varphi : A \times B \rightarrow A \otimes_R B$, $\varphi(a, b) = a \otimes b$ is bilinear and has the following universal property:

Whenever an R -module C and a bilinear map $\psi : A \times B \rightarrow C$ are given, there is just one R -module homomorphism $\Psi : A \otimes_R B \rightarrow C$ such that the diagram

$$\begin{array}{ccc} A \times B & \xrightarrow{\psi} & C \\ \downarrow \varphi & \nearrow \Psi & \\ A \otimes_R B & & \end{array}$$

commutes. This property determines the tensor product uniquely up to isomorphism.

If $f : A \rightarrow C$ and $g : B \rightarrow D$ are homomorphisms of R -modules then $(a, b) \rightarrow f(a) \otimes g(b)$ is a bilinear map and the universal property above ensures the existence and uniqueness of an R -homomorphism $f \otimes g : A \otimes_R B \rightarrow C \otimes_R D$ with the property $(f \otimes g)(a \otimes b) = f(a) \otimes g(b)$.

Homomorphisms between R -modules form an R -module denoted by $\text{Hom}_R(A, B)$. If $R = \mathbb{Z}$, we will denote the tensor product of Abelian groups A and B without the subindex \mathbb{Z} , i.e. $A \otimes B$, and similarly, the group of homomorphisms from A to B will be denoted by $\text{Hom}(A, B)$.

Exercise. Prove from the definition that

$$\mathbb{Z} \otimes \mathbb{Z} = \mathbb{Z}, \quad \mathbb{Z} \otimes \mathbb{Z}_n = \mathbb{Z}_n, \quad \mathbb{Z}_n \otimes \mathbb{Z}_m = \mathbb{Z}_{d(n,m)}, \quad \mathbb{Z}_n \otimes \mathbb{Q} = 0$$

where $d(m, n)$ is the greatest common divisor of n and m . Further compute

$$\text{Hom}(\mathbb{Z}, \mathbb{Z}), \quad \text{Hom}(\mathbb{Z}, \mathbb{Z}_n), \quad \text{Hom}(\mathbb{Z}_n, \mathbb{Z}), \quad \text{Hom}(\mathbb{Z}_n, \mathbb{Z}_m).$$

6.3. Additive functors and cofunctors. A functor (or a cofunctor) $t : \text{Mod} \rightarrow \text{Mod}$ is called *additive* if

$$t(\alpha + \beta) = t(\alpha) + t(\beta)$$

for all $\alpha, \beta \in \text{Hom}_R(A, B)$. Additive functors and cofunctors have the following properties.

- (1) $t(0) = 0$ for any zero homomorphism.
- (2) $t(A \oplus B) = t(A) \oplus t(B)$
- (3) Every additive functor (cofunctor) converts short exact sequences which split into short exact sequences which again split.
- (4) Every additive functor (cofunctor) can be extended to a functor $\text{Ch} \rightarrow \text{Ch}$ (cofunctor $\text{Ch} \rightarrow \text{CoCh}$) which preserves chain homotopies (converts chain homotopies to cochain homotopies).

Proof of (2) and (3). Consider a short exact sequence

$$0 \rightarrow A \xrightarrow{i} B \xrightarrow{j} C \rightarrow 0$$

which splits, i. e. there are homomorphisms $p : B \rightarrow A$, $q : C \rightarrow B$ such that $pi = \text{id}_A$, $jq = \text{id}_C$, $ip + qj = \text{id}_B$. See 3.1. Applying an additive functor t we get a splitting short exact sequence described by homomorphisms $t(i)$, $t(j)$, $t(p)$, $t(q)$. \square

6.4. Exact functors and cofunctors. An additive functor (or an additive cofunctor) $t : \text{Mod} \rightarrow \text{Mod}$ is called *exact* if it preserves short exact sequences.

Example. The functor $t(-) = - \otimes \mathbb{Z}_2$ and the cofunctor $s(-) = \text{Hom}(-, \mathbb{Z})$ are additive but not exact. To show it apply them on the short exact sequence

$$0 \rightarrow \mathbb{Z} \xrightarrow{2 \times} \mathbb{Z} \rightarrow \mathbb{Z}_2 \rightarrow 0.$$

On the other hand, the functor $t(-) = - \otimes \mathbb{Q}$ from Ab to Ab is exact.

Lemma. Let (C, ∂) be a chain complex and let $t : \mathbf{Mod} \rightarrow \mathbf{Mod}$ be an exact functor. Then

$$H_n(tC, t\partial) = tH_n(C, \partial).$$

Consequently, t converts all exact sequences into exact sequences.

Proof. Since t preserves short exact sequences, it preserves kernels, images and factors. So we get

$$H_n(tC) = \frac{\text{Ker } t\partial_n}{\text{Im } t\partial_{n+1}} = \frac{t(\text{Ker } \partial_n)}{t(\text{Im } \partial_{n+1})} = t\left(\frac{\text{Ker } \partial_n}{\text{Im } \partial_{n+1}}\right) = t(H_n(C)).$$

□

6.5. Right exact functors. An additive functor $t : \mathbf{Mod} \rightarrow \mathbf{Mod}$ is called *right exact* if it converts any exact sequence

$$A \xrightarrow{i} B \xrightarrow{j} C \rightarrow 0$$

into an exact sequence

$$tA \xrightarrow{t(i)} tB \xrightarrow{t(j)} tC \rightarrow 0.$$

Theorem. Consider an R -module M . The functor $t(-) = - \otimes_R M$ from \mathbf{Mod} to \mathbf{Ab} is right exact.

Proof. The exact sequence $A \xrightarrow{i} B \xrightarrow{j} C \rightarrow 0$ is converted into the sequence

$$A \otimes_R M \xrightarrow{i \otimes \text{id}_M} B \otimes_R M \xrightarrow{j \otimes \text{id}_M} C \otimes_R M \rightarrow 0.$$

It is clear that $j \otimes \text{id}_M$ is an epimorphism. According to the lemma below $\text{Ker}(j \otimes \text{id}_M)$ is generated by elements $b \otimes m$ where $b \in \text{Ker } j = \text{Im } i$. Hence, $\text{Ker}(j \otimes \text{id}_M) = \text{Im}(i \otimes \text{id}_M)$. □

Lemma. If $\alpha : A \rightarrow A'$ and $\beta : B \rightarrow B'$ are epimorphisms, then $\text{Ker}(\alpha \otimes \beta)$ is generated by elements $a \otimes b$ where $a \in \text{Ker } \alpha$ or $b \in \text{Ker } \beta$.

For the proof see [Spanier], Chapter 5, Lemma 1.5.

6.6. Left exact cofunctors. An additive cofunctor $t : \mathbf{Mod} \rightarrow \mathbf{Mod}$ is called *left exact* if it converts any exact sequence

$$A \xrightarrow{i} B \xrightarrow{j} C \rightarrow 0$$

into an exact sequence

$$O \rightarrow tC \xrightarrow{t(j)} tB \xrightarrow{t(i)} tA.$$

Theorem. Consider an R -module M . The cofunctor $t(-) = \text{Hom}_R(-, M)$ from \mathbf{Mod} to \mathbf{Mod} is left exact.

The proof is not difficult and is left as an exercise.

6.7. Projective modules. An R -module is called *projective* if for any epimorphism $p : A \rightarrow B$ and any homomorphism $f : P \rightarrow B$ there is $F : P \rightarrow A$ such that the diagram

$$\begin{array}{ccc} & & A \\ & \nearrow F & \downarrow p \\ P & \xrightarrow{f} & B \\ & & \downarrow \\ & & 0 \end{array}$$

commutes. Every free R -module is projective.

6.8. Projective resolution. A *projective resolution* of an R -module A is a chain complex (P, ε) , $P_i = 0$ for $i < 0$ and a homomorphism $\alpha : P_0 \rightarrow A$ such that the sequence

$$\cdots \rightarrow P_i \xrightarrow{\varepsilon_i} P_{i-1} \rightarrow \cdots \rightarrow P_1 \xrightarrow{\varepsilon_1} P_0 \xrightarrow{\alpha} A \rightarrow 0$$

is exact. It means that

$$H_i(P, \varepsilon) = \begin{cases} 0 & \text{for } i \neq 0, \\ P_0 / \text{Im } \varepsilon_1 = P_0 / \text{Ker } \alpha \cong A & \text{for } i = 0. \end{cases}$$

If all P_i are free modules, the resolution is called *free*.

Lemma A. *To every module there is a free resolution.*

Proof. For module A denote $F(A)$ a free module over A and $\pi : F(A) \rightarrow A$ a canonical projection. Then the free resolution of A is constructed in the following way

$$P_2 = F \text{Ker } \varepsilon_1 \xrightarrow{\varepsilon_2} \text{Ker } \varepsilon_1 \xrightarrow{\varepsilon_1} P_1 = F(\text{Ker } \pi) \xrightarrow{\varepsilon_1} \text{Ker } \pi \xrightarrow{\pi} P_0 = F(A) \xrightarrow{\pi} A$$

□

Lemma B. *Every Abelian group A has the projective resolution*

$$0 \rightarrow \text{Ker } \pi \rightarrow F(A) \xrightarrow{\pi} A \rightarrow 0.$$

Proof. $\text{Ker } \pi$ as a subgroup of free Abelian group $F(A)$ is free. □

Theorem. *Consider a homomorphism of R -modules $\varphi : A \rightarrow A'$. Let (P_n, ε_n) and (P'_n, ε'_n) be projective resolutions of A and A' , respectively. Then there is a chain homomorphism $\varphi_n : (P, \varepsilon) \rightarrow (P', \varepsilon')$ such that the diagram*

$$\begin{array}{cccccccc} \cdots & \xrightarrow{\varepsilon_3} & P_2 & \xrightarrow{\varepsilon_2} & P_1 & \xrightarrow{\varepsilon_1} & P_0 & \xrightarrow{\alpha} & A & \longrightarrow & 0 \\ & & \downarrow \varphi_2 & & \downarrow \varphi_1 & & \downarrow \varphi_0 & & \downarrow \varphi & & \\ \cdots & \xrightarrow{\varepsilon'_3} & P'_2 & \xrightarrow{\varepsilon'_2} & P'_1 & \xrightarrow{\varepsilon'_1} & P'_0 & \xrightarrow{\alpha'} & A' & \longrightarrow & 0 \end{array}$$

commutes. Moreover, any two such chain homomorphism $(P, \varepsilon) \rightarrow (P', \varepsilon')$ are chain homotopic.

Proof of the first part. α' is an epimorphism and P_0 is projective. Hence there is $\varphi_0 : P_0 \rightarrow P'_0$ such that the first square on the right side commutes.

Since $\alpha'(\varphi_0\varepsilon_1) = \varphi(\alpha\varepsilon_1) = \varphi \circ 0 = 0$, we get that

$$\text{Im}(\varphi_0\varepsilon) \subseteq \text{Ker } \alpha' = \text{Im } \varepsilon'_1.$$

$\varepsilon'_1 : P'_1 \rightarrow \text{Im } \varepsilon'_1$ is an epimorphism and P_1 is projective. Hence there is $\varphi_1 : P_1 \rightarrow P'_1$ such that the second square in the diagram commutes.

The proof of the rest of the first part proceeds in the same way by induction. \square

Proof of the second part. Let φ_* and φ'_* be two chain homomorphisms making the diagram above commutative. Since $\alpha'(\varphi_0 - \varphi'_0) = \alpha(\varphi - \varphi') = 0$, we have

$$\text{Im}(\varphi_0 - \varphi'_0) \subseteq \text{Ker } \alpha' = \text{Im } \varepsilon'_1.$$

Therefore there exists $s_0 : P_0 \rightarrow P'_1$ such that $\varepsilon'_1 s_0 = \varphi_0 - \varphi'_0$.

Next, $\varepsilon'_1(\varphi_1 - \varphi'_1 - s_0\varepsilon_1) = \varepsilon'_1(\varphi_1 - \varphi'_1) - \varepsilon'_1 s_0\varepsilon_1 = (\varphi_0 - \varphi'_0)\varepsilon_1 - (\varphi_0 - \varphi'_0)\varepsilon_1 = 0$, hence

$$\text{Im}(\varphi_0 - \varphi'_0 - s_0\varepsilon_1) \subseteq \text{Ker } \varepsilon'_1 = \text{Im } \varepsilon'_2,$$

and consequently, there is $s_1 : P_1 \rightarrow P'_2$ such that

$$\varepsilon'_2 s_1 = \varphi_1 - \varphi'_1 - s_0\varepsilon_1.$$

The rest proceeds by induction in the same way. \square

6.9. Derived functors. Consider a right exact functor $t : \mathbf{Mod} \rightarrow \mathbf{Mod}$ and a homomorphism of R -modules $\varphi : A \rightarrow A'$. Let (P, ε) and (P', ε') be projective resolutions of A and A' , respectively, and let $\varphi_* : (P, \varepsilon) \rightarrow (P', \varepsilon')$ be a chain homomorphism induced by φ . The *derived functors* $t_i : \mathbf{Mod} \rightarrow \mathbf{Mod}$ of the functor t are defined

$$\begin{aligned} t_i A &= H_i(tP, t\varepsilon) \\ t_i \varphi &= H_i(t\varphi). \end{aligned}$$

The functor t_0 is equal to t since

$$t_0 A = tP_0 / \text{Im } t\varepsilon_1 = tP_0 / \text{Ker } t\alpha \cong tA.$$

Using the previous theorem we can easily show that the definition does not depend on the choice of projective resolutions and a chain homomorphism φ_* .

Definition. The i -th derived functors of the functor $t(-) = - \otimes_R M$ is denoted

$$\text{Tor}_i^R(-, M).$$

If $R = \mathbb{Z}$, the index \mathbb{Z} in the notation will be omitted.

Example. Let $R = \mathbb{Z}$. Any Abelian group A has a free resolution with $P_i = 0$ for $i \geq 2$. Hence

$$\text{Tor}_i(A, B) = 0 \quad \text{for } i \geq 2.$$

Hence we will omit the index 1 in $\text{Tor}_1(A, B)$. We have

- (1) $\text{Tor}(A, B) = 0$ for any free Abelian group A .
- (2) $\text{Tor}(A, B) = 0$ for any free Abelian group B .

- (3) $\text{Tor}(\mathbb{Z}_m, \mathbb{Z}_n) = \mathbb{Z}_{d(m,n)}$ where $d(m, n)$ is the greatest common divisor of m and n .
- (4) $\text{Tor}(-, B)$ is an additive functor.

The proof based on the definition is not difficult and is left to the reader as an exercise.

6.10. Derived cofunctors. Consider a left exact cofunctor $t : \mathbf{Mod} \rightarrow \mathbf{Mod}$ and a homomorphism of R -modules $\varphi : A \rightarrow A'$. Let (P, ε) and (P', ε') be projective resolutions of A and A' , respectively, and let $\varphi_* : (P, \varepsilon) \rightarrow (P', \varepsilon')$ be a chain homomorphism induced by φ . The *derived cofunctors* $t^i : \mathbf{Mod} \rightarrow \mathbf{Mod}$ of the functor t are defined

$$\begin{aligned} t^i A &= H^i(tP, t\varepsilon) \\ t^i \varphi &= H^i(t\varphi). \end{aligned}$$

The functor t^0 is equal to t since

$$t_0 A = \text{Ker } t\varepsilon_1 = \text{Im } t\alpha = tA.$$

Using Theorem 6.8 we can easily show that the definition does not depend on the choice of projective resolutions and a chain homomorphism φ_* .

Definition. The i -th derived functors of the functor $t(-) = \text{Hom}_R(-, M)$ is denoted

$$\text{Ext}_R^i(-, M).$$

If $R = \mathbb{Z}$, the index \mathbb{Z} in the notation will be omitted.

Example. Let $R = \mathbb{Z}$. Since every Abelian group A has a free resolution with $P_i = 0$ for $i \geq 2$,

$$\text{Ext}^i(A, B) = 0 \quad \text{for } i \geq 2.$$

Hence we will write $\text{Ext}(A, B)$ for $\text{Ext}^1(A, B)$. We have

- (1) $\text{Ext}(A, B) = 0$ for any free Abelian group A .
- (2) $\text{Ext}(\mathbb{Z}_n, \mathbb{Z}) = \mathbb{Z}_n$.
- (3) $\text{Ext}(\mathbb{Z}_m, \mathbb{Z}_n) = \mathbb{Z}_{d(m,n)}$ where $d(m, n)$ is the greatest common divisor of m and n .
- (4) $\text{Ext}(-, B)$ is an additive cofunctor.

The proof is the application of the definition and it is again left to the reader.

6.11. Universal coefficient theorems. In this paragraph we first express the cohomology groups $H^n(X; G)$ with the aid of functors Hom and Ext using the homology groups $H_*(X)$.

Theorem A. *If a free chain complex C of Abelian groups has homology groups $H_n(C)$, then the cohomology groups $H^n(C; G)$ of the cochain complex $C^n = \text{Hom}(C_n, G)$ are determined by the following split short exact sequence*

$$0 \rightarrow \text{Ext}(H_{n-1}(C), G) \rightarrow H^n(C; G) \xrightarrow{h} \text{Hom}(H_n(C), G) \rightarrow 0$$

where $h[f]([c]) = f(c)$ for all cycles $c \in C_n$ and all cocycles $f \in \text{Hom}(C_n; G)$.

Remark. The exact sequence is natural but the splitting not. In this case the naturality means that for every chain homomorphism $f : C \rightarrow D$ we have commutative diagram

$$\begin{array}{ccccccc} 0 & \longrightarrow & \text{Ext}(H_{n-1}(C), G) & \longrightarrow & H^n(C; G) & \xrightarrow{h_C} & \text{Hom}(H_n(C), G) \longrightarrow 0 \\ & & \downarrow \text{Ext}(H_{n-1}f, \text{id}_G) & & \downarrow H^n f & & \downarrow \text{Hom}(H_n f, \text{id}_G) \\ 0 & \longrightarrow & \text{Ext}(H_{n-1}(D), G) & \longrightarrow & H^n(D; G) & \xrightarrow{h_D} & \text{Hom}(H_n(D), G) \longrightarrow 0 \end{array}$$

Proof. The free chain complex (C_n, ∂) determines two other chain complexes, the chain complex of cycles $(Z_n, 0)$ and the chain complex of boundaries $(B_n, 0)$. We have the short exact sequence of these chain complexes

$$0 \rightarrow Z_n \xrightarrow{i} C_n \xrightarrow{\partial} B_{n-1} \rightarrow 0.$$

Since B_{n-1} is a subgroup of the free Abelian group C_{n-1} , it is also free and the exact sequence splits. Since the functor $\text{Hom}(-, G)$ is additive, it converts this sequence into the short exact sequence of cochain complexes

$$0 \rightarrow \text{Hom}(B_{n-1}, G) \xrightarrow{\delta} \text{Hom}(C_n, G) \xrightarrow{i^*} \text{Hom}(Z_n, G) \rightarrow 0.$$

As in 5.6 we obtain the long exact sequence of cohomology groups of the given cochain complexes

$$\rightarrow \text{Hom}(Z_{n-1}, G) \rightarrow \text{Hom}(B_{n-1}, G) \rightarrow H^n(C; G) \xrightarrow{i^*} \text{Hom}(Z_n, G) \xrightarrow{\delta^*} \text{Hom}(B_n, G) \rightarrow$$

Next, one has to realize how the connecting homomorphism δ^* in this exact sequence looks like using its definition and the special form of the short exact sequence. The conclusion is that $\delta^* = j^*$ where $j : B_n \hookrightarrow Z_n$ is an inclusion. Now we can reduce the long exact sequence to the short one

$$0 \rightarrow \frac{\text{Hom}(B_{n-1}, G)}{\text{Im } j^*} \rightarrow H^n(C; G) \xrightarrow{i^*} \text{Ker } j^* \rightarrow 0.$$

We determine $\text{Ker } j^*$ and $\text{Hom}(B_{n-1}, G)/\text{Im } j^*$. Consider the short exact sequence

$$0 \rightarrow B_n \xrightarrow{j} Z_n \rightarrow H_n(C) \rightarrow 0.$$

It is a free resolution of $H_n(C)$. Applying the cofunctor $\text{Hom}(-, G)$ we get the cochain complex

$$0 \rightarrow \text{Hom}(Z_n, G) \xrightarrow{j^*} \text{Hom}(B_n, G) \rightarrow 0 \rightarrow 0 \rightarrow \dots$$

from which we can easily compute that

$$\text{Hom}(H_n(C), G) = \text{Ker } j^*, \quad \text{Ext}(H_n(C), G) = \frac{\text{Hom}(B_{n-1}, G)}{\text{Im } j^*}.$$

This completes the proof of exactness.

We will find a splitting $r : \text{Hom}(H_n(C); G) \rightarrow H^n(C; G)$. Let $g \in \text{Hom}(H_n(C), G)$. We can define $f \in \text{Hom}(C_n, G)$ such that on cycles $c \in Z_n$

$$f(c) = g([c])$$

where $[c] \in H_n(C)$. f is a cocycle, hence $[f] \in H^n(C; G)$ and $h[f]([c]) = f(c) = g([c])$. \square

In a very similar way one can compute homology groups with coefficients in G using the tensor product $H_*(C) \otimes G$ and $\text{Tor}(H_*(C), G)$.

Theorem B. *If a free chain complex C has homology groups $H_n(C)$, then the homology groups $H_n(C_*; G)$ of the chain complex $C_n \otimes G$ are determined by the split short exact sequence*

$$0 \rightarrow H_n(C) \otimes G \xrightarrow{l} H_n(C; G) \rightarrow \text{Tor}(H_{n-1}(C), G) \rightarrow 0$$

where $l([c] \otimes g) = [c \otimes g]$ for $c \in Z_n(C)$, $g \in G$.

6.12. Exercise. Compute cohomology of real projective spaces with \mathbb{Z} and \mathbb{Z}_2 coefficients using the universal coefficient theorem for cohomology.

Exercise. Using again the universal coefficient theorem for cohomology and Theorem 4.4 prove that for a given CW-complex X the cohomology of the cochain complex

$$(H^n(X^n, X^{n-1}; G), d^n)$$

where d^n is the composition

$$H^n(X^n, X^{n-1}; G) \xrightarrow{j_n^*} H^n(X^n; G) \xrightarrow{\delta^*} H^{n+1}(X^{n+1}, X^n; G)$$

is isomorphic to $H^*(X; G)$. See also Theorem 5.14.

7. PRODUCTS IN COHOMOLOGY

An internal product in cohomology brings a further algebraic structure. The contravariant functor H^* becomes a cofunctor into graded rings. It enables us to obtain more information on topological spaces and homotopy classes of maps. In this section we will define an internal product – called the cup product and a closely related external product – called the cross product.

7.1. Cup product. Let R be a commutative ring with a unite and let X be a space. For two cochains $\varphi \in C^k(X; R)$ and $\psi \in C^l(X; R)$ we define their *cup product* $\varphi \cup \psi \in C^{k+l}(X; R)$

$$(\varphi \cup \psi)(\sigma) = \varphi(\sigma/[v_0, v_1, \dots, v_k]) \cdot \psi(\sigma/[v_k, v_{k+1}, \dots, v_{k+l}])$$

for any singular simplex $\sigma : \Delta^{k+l} \rightarrow X$. The notation $\sigma/[v_0, v_1, \dots, v_k]$ and $\sigma/[v_k, v_{k+1}, \dots, v_{k+l}]$ stands for σ composed with inclusions of the standard simplices Δ^k and Δ^l into the indicated faces of the standard simplex Δ^{k+l} , respectively. The coboundary operator δ behaves on the cup products of cochains as graded derivation as shown in the following

Lemma.

$$\delta(\varphi \cup \psi) = \delta\varphi \cup \psi + (-1)^k \varphi \cup \delta\psi.$$

Proof. For $\sigma \in C_{k+l+1}(X)$ we get

$$\begin{aligned} (\delta\varphi \cup \psi)(\sigma) + (-1)^k (\varphi \cup \delta\psi)(\sigma) &= \delta\varphi(\sigma/[v_0, v_1, \dots, v_{k+1}])\psi(\sigma/[v_{k+1}, \dots, v_{k+l+1}]) \\ &\quad + (-1)^k \varphi(\sigma/[v_0, v_1, \dots, v_k])\delta\psi(\sigma/[v_k, \dots, v_{k+l+1}]) \\ &= \sum_{i=0}^{k+1} (-1)^i \varphi(\sigma/[v_0, \dots, \hat{v}_i, \dots, v_{k+1}]) (\psi(\sigma/[v_{k+1}, \dots, v_{k+l+1}])) \\ &\quad + (-1)^k \left(\sum_{j=k}^{k+l+1} (-1)^{j-k} \varphi(\sigma/[v_0, \dots, v_k]) \psi(\sigma/[v_k, \dots, \hat{v}_j, \dots, v_{k+l+1}]) \right) \\ &= \sum_{i=0}^{k+l+1} (-1)^i (\varphi \cup \psi)(\sigma/[v_0, \dots, \hat{v}_i, \dots, v_{k+l+1}]) = \delta(\varphi \cup \psi)(\sigma). \end{aligned}$$

□

Lemma implies that

- (1) If φ and ψ are cocycles, then $\varphi \cup \psi$ is a cocycle.
- (2) If one of the cochains φ and ψ is a coboundary, then $\varphi \cup \psi$ is a coboundary.

It enables us to define the *cup product*

$$\cup : H^k(X; R) \times H^l(X; R) \rightarrow H^{k+l}(X; R)$$

by the prescription

$$[\varphi] \cup [\psi] = [\varphi \cup \psi]$$

for cocycles φ and ψ . Since \cup is an R -bilinear map on $H^k(X; R) \times H^l(X; R)$, it can be considered as an R -linear map on the tensor product $H^k(X; R) \otimes_R H^l(X; R)$. Given a pair of spaces (X, A) we can define the cup product as a linear map

$$\begin{aligned}\cup : H^k(X, A; R) \otimes_R H^l(X; R) &\rightarrow H^{k+l}(X, A; R), \\ \cup : H^k(X; R) \otimes_R H^l(X, A; R) &\rightarrow H^{k+l}(X, A; R), \\ \cup : H^k(X, A; R) \otimes_R H^l(X, A; R) &\rightarrow H^{k+l}(X, A; R).\end{aligned}$$

Moreover, if A and B are open in X or A and B are subcomplexes of CW-complex X , one can define

$$\cup : H^k(X, A; R) \otimes_R H^l(X, B; R) \rightarrow H^{k+l}(X, A \cup B; R).$$

Exercise. Prove that the previous definitions of cup product for pairs of spaces are correct. For the last case you need Lemma 3.12.

Remark. In the same way as the singular cohomology groups and the cup product have been defined using the singular chain complexes, we can introduce simplicial cohomology groups for Δ -complexes and a cup product in these groups.

7.2. Properties of the cup product are following:

- (1) The cup product is associative.
- (2) If $X \neq \emptyset$, there is an element $1 \in H^0(X; R)$ such that for all $\alpha \in H^k(X, A; R)$

$$1 \cup \alpha = \alpha \cup 1 = \alpha.$$

- (3) For all $\alpha \in H^k(X, A; R)$ and $\beta \in H^l(X, A; R)$

$$\alpha \cup \beta = (-1)^{kl} \beta \cup \alpha,$$

i. e. the cup product is graded commutative.

- (4) Naturality of the cup product. For every map $f : (X, A) \rightarrow (Y, B)$ and any $\alpha \in H^k(Y, B; R)$, $\beta \in H^l(Y, B; R)$ we have

$$f^*(\alpha \cup \beta) = f^*(\alpha) \cup f^*(\beta).$$

Remark. Properties (1) – (3) mean that $H^*(X, A; R) = \bigoplus_{i=0}^{\infty} H^i(X, A; R)$ with the cup product is not only a graded group but also a graded ring and that $H^*(X; R)$ is even a graded ring with a unit if $X \neq \emptyset$. Property (4) says that $f : (X, A) \rightarrow (Y, B)$ induces a ring homomorphism $f^* : H^*(Y, B; R) \rightarrow H^*(X, A; R)$.

Proof. To prove properties (1), (2) and (4) is easy and left to the reader as an exercise. To prove property (3) is more difficult. We refer to [Hatcher], Theorem 3.14, pages 215 – 217 for geometrically motivated proof. Another approach is outlined later in 7.8. \square

7.3. Cross product. Consider spaces X and Y and projections $p_1 : X \times Y \rightarrow X$ and $p_2 : X \times Y \rightarrow Y$. We will define the *cross product* or *external product*. The absolute

and relative forms are the linear maps

$$\begin{aligned}\mu &: H^k(X, R) \otimes H^l(Y; R) \rightarrow H^{k+l}(X \times Y; R), \\ \mu &: H^k(X, A; R) \otimes H^l(Y, B; R) \rightarrow H^{k+l}(X \times Y, A \times Y \cup X \times B; R)\end{aligned}$$

given by

$$\mu(\alpha \otimes \beta) = p_1^*(\alpha) \cup p_2^*(\beta).$$

For the relative form of the cross product we suppose that A and B are open in X and Y , or that A and B are subcomplexes of X and Y , respectively. (See the definition of the cup product.) The name cross product comes from the notation since $\mu(\alpha \otimes \beta)$ is often written as $\alpha \times \beta$.

Exercise. Let $\Delta : X \rightarrow X \times X$ be the diagonal $\Delta(x) = (x, x)$. Show that for $\alpha, \beta \in H^*(X; R)$

$$\alpha \cup \beta = \Delta^*(\mu(\alpha \otimes \beta)).$$

7.4. Tensor product of graded rings. Let $A^* = \bigoplus_{n=0}^{\infty} A^n$ and $B^* = \bigoplus_{n=0}^{\infty} B^n$ be graded rings. Then the *tensor product of graded rings* $A^* \otimes B^*$ is the graded ring $C^* = \bigoplus_{n=0}^{\infty} C^n$ where

$$C^n = \bigoplus_{i+j=n} A^i \otimes B^j$$

with the multiplication given by

$$(a_1 \otimes b_1) \cdot (a_2 \otimes b_2) = (-1)^{|b_1| \cdot |a_2|} (a_1 \cdot a_2) \otimes (b_1 \cdot b_2).$$

Here $|b_1|$ is the degree of $b_1 \in B^*$, i.e. $b_1 \in B^{|b_1|}$. If A^* and B^* are graded commutative, so is $A^* \otimes B^*$.

Lemma. *The cross product*

$$\mu : H^k(X, A; R) \otimes H^l(Y, B; R) \rightarrow H^{k+l}(X \times Y, A \times Y \cup X \times B; R)$$

is a homomorphism of graded rings.

Proof. Using the definitions of the cup and cross products and their properties we have

$$\begin{aligned}\mu((a \times b) \cdot (c \times d)) &= (-1)^{|b| \cdot |c|} \mu((a \cup c) \otimes (b \cup d)) = (-1)^{|b| \cdot |c|} p_1^*(a \cup c) \cup p_2^*(b \cup d) \\ &= (-1)^{|b| \cdot |c|} p_1^*(a) \cup p_1^*(c) \cup p_2^*(b) \cup p_2^*(d) \\ &= p_1^*(a) \cup p_2^*(b) \cup p_1^*(c) \cup p_2^*(d) = \mu(a \otimes b) \cup \mu(c \otimes d).\end{aligned}$$

□

7.5. Künneth formulas tell us how to compute the graded R -modules $H_*(X \times Y; R)$ or $H^*(X \times Y; R)$ out of the graded modules $H_*(X; R)$ and $H_*(Y; R)$ or $H^*(X; R)$ and $H^*(Y; R)$, respectively. Under certain conditions it even determines the ring structure of $H^*(X \times Y; R)$.

Theorem (Künneth formula). *Let (X, A) and (Y, B) be pairs of CW-complexes. Suppose that $H^k(Y, B; R)$ are free finitely generated R -modules for all k . Then*

$$\mu : H^*(X, A; R) \otimes H^*(Y, B; R) \rightarrow H^*(X \times Y, A \times Y \cup X \times B; R)$$

is an isomorphism of graded rings.

Example. $H^*(S^k \times S^l) \cong \mathbb{Z}[\alpha, \beta]/\mathcal{I}$ where \mathcal{I} is the ideal generated by elements α^2 , β^2 , $\alpha\beta = (-1)^{kl}\beta\alpha$ and $\deg \alpha = k$, $\deg \beta = l$.

Proof. Consider the diagram

$$\begin{array}{ccccc} H^*(X, A) \otimes_R H^*(Y) & \xrightarrow{\quad\quad\quad} & H^*(X) \otimes_R H^*(Y) & & \\ & \searrow^{\delta^* \otimes \text{id}} & & \swarrow & \\ & & H^*(A) \otimes_R H^*(Y) & & \\ & & \downarrow \mu & & \\ H^*(X \times Y, A \times Y) & \xrightarrow{\quad\quad\quad} & H^*(X \times Y) & & \\ & \searrow^{\delta^*} & & \swarrow & \\ & & H^*(A \times Y) & & \end{array}$$

where the upper and the lower triangles come from the long exact sequences for pairs (X, A) and $(X \times Y, A \times Y)$, respectively. The right rhomb commutes as a consequence of the naturality of the cross product. We prove that the left rhomb also commutes.

Let φ and ψ be cocycles in $C^*(A)$ and $C^*(Y)$, respectively. Let Φ be a cocycle in $C^*(X)$ extending φ . Then $p_1^*\Phi \cup p_2^*\psi \in C^*(X \times Y)$ extends $p_1^*\varphi \cup p_2^*\psi \in C^*(A \times Y)$. Using the definition of the connecting homomorphism in cohomology (see Remark 5.6 B) we get

$$\begin{aligned} \mu((\delta^* \otimes \text{id})([\varphi] \otimes [\psi])) &= \mu[\delta\Phi \otimes \psi] = p_1^*[\delta\Phi] \cup p_2^*[\psi], \\ \delta^*(\mu([\varphi] \otimes [\psi])) &= \delta^*[p_1^*\varphi \cup p_2^*\psi] = [\delta(p_1^*\Phi \cup p_2^*\psi)] = p_1^*[\delta\Phi] \cup p_2^*[\psi]. \end{aligned}$$

First, we prove the statement of Theorem for a finitedimensional CW-complex X and $A = B = \emptyset$ using the induction by the dimension of X and Five Lemma. If $\dim X = 0$, X is a finite discrete set and the statement of Theorem is true. Suppose that Theorem holds for spaces of dimension $n - 1$ or less. Let $\dim X = n$. It suffices to show that

$$\mu : H^*(X^n, X^{n-1}) \otimes H^*(Y) \rightarrow H^*(X^n \times Y, X^{n-1} \times Y)$$

is an isomorphism and than to use Five Lemma in the diagram above with $A = X^{n-1}$ to prove the statement for $X = X^n$. X^n/X^{n-1} is homeomorphic to $\bigsqcup_i D_i^n / \bigsqcup_i \partial D_i^n$. To prove that

$$\mu : H^*\left(\bigvee_i S_i^n\right) \otimes H^*(Y) \rightarrow H^*\left(\bigvee_i S_i^n \times Y\right)$$

is an isomorphism, we use again the diagram above for $X = \bigsqcup_i D_i^n$ and $A = \bigsqcup_i \partial D_i^n$ and the induction with respect to n .

So we have proved the theorem for X a finite dimensional CW-complex and $A = B = \emptyset$. Using once more our diagram and Five Lemma, we can easily prove Theorem for any pairs $(X, A), (Y, \emptyset)$ with X of finite dimension. For X of infinite dimension, we have to prove $H^i(X) = H^i(X^n)$ for $i < n$ which is equivalent to $H^i(X/X^n) = 0$. We omit the details and refer the reader to [Hatcher], pages 220 – 221. \square

7.6. Application of the cup product. In this paragraph we show how to use the cup product to prove that S^{2k} is not an H-space. A space X is called an *H-space* if there is a map $m : X \times X \rightarrow X$ called a multiplication and an element $e \in X$ called a unit such that $m(e, x) = m(x, e) = x$ for all $x \in X$.

Suppose that there is a multiplication $m : S^{2k} \times S^{2k} \rightarrow S^{2k}$ with a unit e . According to Example after Theorem 7.5

$$H^*(S^{2k} \times S^{2k}; \mathbb{Z}) = \mathbb{Z}[\alpha, \beta]/\mathcal{I}$$

where \mathcal{I} is the ideal generated by relations $\alpha^2 = 0$, $\beta^2 = 0$ and $\alpha\beta = \beta\alpha$. The last relation is due to the fact that the dimension of the sphere is even. Moreover, $\alpha = \gamma \otimes 1$ and $\beta = 1 \otimes \gamma$ where $\gamma \in H^{2k}(S^{2k}; \mathbb{Z})$ is a generator. Let us compute $m^* : H^*(S^{2k}; \mathbb{Z}) \rightarrow H^*(S^{2k} \times S^{2k}; \mathbb{Z})$. We have

$$m^*(\gamma) = a\alpha + b\beta, \quad a, b \in \mathbb{Z}.$$

Since the composition

$$S^{2k} \xrightarrow{\text{id} \times e} S^{2k} \times S^{2k} \xrightarrow{m} S^{2k}$$

is the identity, we get that $a = 1$. Similarly, $b = 1$. Now compute $m^*(\gamma^2)$:

$$0 = m^*(0) = m^*(\gamma^2) = (m^*(\gamma))^2 = (\alpha + \beta)^2 = 2\alpha\beta \neq 0,$$

a contradiction. Does this proof go through for odd dimensional spheres?

7.7. Künneth formula in homological algebra. Consider two chain complexes $(C_*, \partial_C), (D_*, \partial_D)$ of R -modules. Suppose there is an integer N such that $C_n = D_n = 0$ for all $n < N$. Then their tensor product is the chain complex $(C_* \otimes D_*, \partial)$ with

$$(C_* \otimes D_*)_n = \bigoplus_{i+j=n} C_i \otimes D_j$$

and the boundary operator on $C_i \otimes D_j$

$$\partial(c \otimes d) = \partial_C c \otimes d + (-1)^i c \otimes \partial_D d.$$

It is easy to make sure that $\partial\partial = 0$.

Next we can define the graded R -module $C_* * D_*$ as

$$(C_* * D_*)_n = \bigoplus_{i+j=n} \text{Tor}_1^R(C_i, D_j).$$

A ring R is called *hereditary* if any submodule of a free R -module is free. Examples of hereditary rings are \mathbb{Z} and all fields.

Theorem (Algebraic Künneth formula). *Let R be a hereditary ring and let C_* and D_* be chain complexes of R -modules. If C_* is free, then the homology groups of $C_* \otimes D_*$ are determined by the splitting short exact sequence*

$$0 \rightarrow (H_*(C) \otimes H_*(D))_n \xrightarrow{l} H_n(C_* \otimes D_*) \rightarrow (H_*(C) * H_*(D))_{n-1} \rightarrow 0$$

where $l([c] \otimes [d]) = [c \otimes d]$. This sequence is natural but the splitting is not.

Notice that for the chain complex

$$D_n = \begin{cases} 0 & \text{for } n \neq 0, \\ G & \text{for } n = 0 \end{cases}$$

the Künneth formula gives the universal coefficient theorem for homology groups, see Theorem 6.11 B.

The proof of the Künneth formula is similar to the proof of the universal coefficient theorem and we omit it.

7.8. Eilenberg-Zilbert Theorem. To be able to apply the previous Künneth formula in topology we have to show that the singular chain complex $C_*(X \times Y)$ of a product $X \times Y$ is chain homotopy equivalent to the tensor product of the singular chain complexes $C_*(X) \otimes C_*(Y)$.

Theorem (Eilenberg-Zilbert). *Up to chain homotopy there are unique natural chain homomorphisms*

$$\begin{aligned} \Phi : C_*(X) \otimes C_*(Y) &\rightarrow C_*(X \times Y), \\ \Psi : C_*(X \times Y) &\rightarrow C_*(X) \otimes C_*(Y) \end{aligned}$$

such that for 0-simplices σ and τ

$$\Phi(\sigma \otimes \tau) = (\sigma, \tau), \quad \Psi(\sigma, \tau) = \sigma \otimes \tau.$$

Moreover, such chain homomorphisms are chain homotopy equivalences: there are natural chain homotopies such that

$$\Psi\Phi \sim \text{id}_{C_*X \otimes C_*Y}, \quad \Phi\Psi \sim \text{id}_{C_*(X \times Y)}.$$

For the proof of this theorem see [Dold], IV.12.1. The chain homomorphism Ψ is called the Eilenberg-Zilbert homomorphism and denoted EZ . It enables a different and more abstract approach to the definitions of the cross and cup products. The cross product is

$$\mu([\alpha] \otimes [\beta]) = [(\alpha \otimes \beta) \circ EZ]$$

for cocycles $\alpha \in C^*(X; R)$ and $\beta \in C^*(Y; R)$ and the cup product is

$$([\varphi] \otimes [\psi]) = [(\varphi \otimes \psi) \circ EZ \circ \Delta_*]$$

for cocycles $\varphi, \psi \in C^*(X; R)$ and the diagonal $\Delta : X \rightarrow X \times X$. In our definition in 7.1 we have used for $EZ \circ \Delta_*$ the homomorphism

$$\sigma \rightarrow \sigma/[v_0, v_1, \dots, v_k] \otimes \sigma/[v_k, \dots, v_n].$$

The properties of EZ can be used for a different proof of the graded commutativity of the cup product.

7.9. Künneth formulas in topology. The following statement is an immediate consequence of the previous paragraph.

Theorem A (Künneth formula for homology). *Let R be a hereditary ring. The homology groups of the product of two spaces X and Y are determined by the following splitting short exact sequence*

$$0 \rightarrow (H_*(X; R) \otimes H_*(Y; R))_n \xrightarrow{l} H_n(X \times Y; R) \rightarrow (H_*(X; R) * H_*(Y; R))_{n-1} \rightarrow 0$$

where $l([c] \otimes [d]) = [c \otimes d]$. *This sequence is natural but the splitting is not.*

For cohomology groups one can prove

Theorem B (Künneth formula for cohomology groups). *Let R be a hereditary ring. The cohomology groups of the product of two spaces X and Y are determined by the following splitting short exact sequence*

$$0 \rightarrow (H^*(X; R) \otimes H^*(Y; R))_n \xrightarrow{\mu} H^n(X \times Y; R) \rightarrow (H^*(X; R) * H^*(Y; R))_{n+1} \rightarrow 0.$$

This sequence is natural but the splitting is not.

For the proof and other forms of Künneth formulas see [Dold], Chapter VI, Theorem 12.16 or [Spanier], Chapter 5, Theorems 5.11. and 5.12.

8. VECTOR BUNDLES AND THOM ISOMORPHISM

In this section we introduce the notion of vector bundle and define its important algebraic invariants Thom and Euler classes. The Thom class is involved in so called Thom isomorphism. Using this isomorphism we derive the Gysin exact sequence which is an important tool for computing cup product structure in cohomology.

8.1. Fibre bundles. A *fibre bundle* structure on a space E , with fiber F , consists of a projection map $p : E \rightarrow B$ such that each point of B has a neighbourhood U for which there is a homeomorphism $h : p^{-1}(U) \rightarrow U \times F$ such that the diagram

$$\begin{array}{ccc} p^{-1}(U) & \xrightarrow{h} & U \times F \\ & \searrow p & \swarrow \text{pr}_1 \\ & & U \end{array}$$

commutes. Here pr_1 is the projection on the first factor. h is called a *local trivialization*, the space E is called the *total space* of the bundle and B is the *base space*.

A *subbundle* (E', B, p') of a fibre bundle (E, B, p) has the total space $E' \subseteq E$, the fibre $F' \subseteq F$, $p' = p|_{E'}$ and local trivializations in E' are restrictions of local trivializations of E .

A *vector bundle* is a fibre bundle (E, B, p) whose fiber is a vector space (real or complex). Moreover, we suppose that for each $b \in B$ the fiber $p^{-1}(b)$ over b is a vector space and all local trivializations restricted to $p^{-1}(b)$ are linear isomorphisms. The dimension of a vector bundle is the dimension of its fiber. For $p^{-1}(U)$ where $U \subseteq B$ we will use notation E_U . Further, E_U^0 will stand for E_U without zeroes in vector spaces $E_x = p^{-1}(x)$ for $x \in U$.

8.2. Orientation of a vector space. Let V be a real vector space of dimension n . The orientation of V is the choice of a generator in $H^n(V, V - \{0\}; \mathbb{Z}) = \mathbb{Z}$. If R is a commutative ring with a unit, the R -orientation of V is the choice of a generator in $H^n(V, V - \{0\}; R) = R$. For $R = \mathbb{Z}$ we have two possible orientations, for $R = \mathbb{Z}_2$ only one.

8.3. Orientation of a vector bundle. Consider a vector bundle (E, B, p) with fiber \mathbb{R}^n . The R -orientation of the vector bundle E is a choice of orientation in each vector space $p^{-1}(b)$, $b \in B$, i. e. a choice of generators $t_b \in H^n(E_b, E_b^0; R) = R$ such that for each $b \in B$ there is a neighbourhood U and an element

$$t_U \in H^n(E_U, E_U^0; R)$$

with the property

$$i_x^*(t_U) = t_x$$

for each $x \in U$ and the inclusion $i_x : E_x \hookrightarrow E_U$.

If a vector bundle has an R -orientation, we say that it is R -orientable. An R -oriented vector bundle is a vector bundle with a chosen R -orientation. Talking on orientation we will mean \mathbb{Z} -orientation.

Example. Every vector bundle (E, B, p) is \mathbb{Z}_2 -orientable. After we have some knowledge of fundamental group, we will be able to prove that vector bundles with $\pi_1(B) = 0$ are orientable.

8.4. Thom class and Thom isomorphism. The Thom class of a vector bundle (E, B, p) of dimension n is an element $t \in H^n(E, E^0; R)$ such that $i_b^*(t)$ is a generator in $H^n(E_b, E_b^0; R) = R$ for each $b \in B$ where $i_b : E_b \hookrightarrow E$ is an inclusion.

It is clear that any Thom class determines a unique orientation. The reverse statement is also true.

Theorem (Thom Isomorphism Theorem). *Let (E, B, p) be an R -oriented vector bundle of real dimension n . Then there is just one Thom class $t \in H^n(E, E^0; R)$ which determines the given R -orientation. Moreover, the homomorphism*

$$\tau : H^k(B; R) \rightarrow H^{k+n}(E, E^0; R), \quad \tau(a) = p^*(a) \cup t$$

is an isomorphism (so called Thom isomorphism).

Remark. Notice that Thom Isomorphism Theorem is a generalization of the Künneth Formula 7.5 for $(Y, A) = (\mathbb{R}^n, \mathbb{R}^n - \{0\})$. We use it in the proof.

Proof. (1) First suppose that $E = B \times \mathbb{R}^n$. Then according to Theorem 7.5

$$\begin{aligned} H^*(E, E^0; R) &= H^*(B \times \mathbb{R}^n, B \times (\mathbb{R}^n - \{0\}); R) = H^*(B; R) \otimes H^*(\mathbb{R}^n, \mathbb{R}^n - \{0\}; R) \\ &\cong H^*(B; R)[e]/\langle e^2 \rangle \end{aligned}$$

where $e \in H^n(\mathbb{R}^n, \mathbb{R}^n - \{0\}; R)$ is the generator given by the orientation of E . Now, there is just one Thom class $t = 1 \times e$ and

$$\tau(a) = p^*(a) \cup t = a \times e$$

is an isomorphism.

(2) If U is open subset of B , then the orientation of (E, B, p) induces an orientation of the vector bundle (E_U, U, p) . Suppose that U and V are two open subsets in B such that the statement of Theorem is true for E_U, E_V and $E_{U \cap V}$ with induced orientations. Denote the corresponding Thom classes by t_U, t_V and $t_{U \cap V}$. The uniqueness of $t_{U \cap V}$ implies that the restrictions of both classes t_U and t_V on $H^n(E_{U \cap V}, E_{U \cap V}^0; R)$ are $t_{U \cap V}$. We will show that Theorem holds for $E_{U \cup V}$.

Consider the Mayer-Vietoris exact sequence 5.13 for $A = E_U, B = E_V, C = E_U^0, D = E_V^0$ together with the Mayer-Vietoris exact sequence for $A = U, B = V$ and $C = D = \emptyset$. Omitting coefficients these exact sequences together with Thom isomorphisms

τ_U , τ_V and $\tau_{U \cap V}$ yield the following diagram where DE_U stands for the pair (E_U, E_U^0)

$$\begin{array}{ccccccc} \xrightarrow{\delta^*} & H^{k+n}(DE_{U \cup V}) & \xrightarrow{(j_U^*, j_V^*)} & H^{k+n}(DE_U) \oplus H^{k+n}(DE_V) & \xrightarrow{i_U^* - i_V^*} & H^{k+n}(DE_{U \cap V}) & \longrightarrow \\ & \uparrow \tau_{U \cup V} & & \uparrow \tau_U \oplus \tau_V & & \uparrow \tau_{U \cap V} & \\ \xrightarrow{\delta^*} & H^k(U \cup V) & \xrightarrow{(j_U^*, j_V^*)} & H^k(U) \oplus H^k(V) & \xrightarrow{i_U^* - i_V^*} & H^k(U \cap V) & \longrightarrow \end{array}$$

(At the moment we do not need commutativity.) From the first row of this diagram we get that

$$H^i(E_{U \cup V}, E_{U \cup V}^0) = 0 \quad \text{for } i < n$$

and that there is just one class $t_{U \cup V} \in H^n(E_{U \cup V}, E_{U \cup V}^0)$ such that

$$(j_U^*, j_V^*)(t_{U \cup V}) = (t_U, t_V).$$

This is the Thom class for $E_{U \cup V}$ and we can define the homomorphism $\tau_{U \cup V} : H^k(U \cup V) \rightarrow H^{k+n}(E_{U \cup V}, E_{U \cup V}^0)$ by

$$\tau_{U \cup V}(a) = p_*(a) \cup t_{U \cup V}.$$

Complete the diagram by this homomorphism. When we check the commutativity of the completed diagram, it suffices to apply Five Lemma to show that $\tau_{U \cup V}$ is an isomorphism.

To prove the commutativity we have to go into the cochain level from which the Mayer-Vietoris sequences are derived in natural way. Let t'_U and t'_V be cocycles representing the Thom classes t_U and t_V . We can choose them in such a way that

$$i_U^* t'_U = i_V^* t'_V = t'_{U \cap V}$$

where $t'_{U \cap V}$ represents the Thom class $t_{U \cap V}$. Consider the diagram where the rows are the short exact sequences inducing the Mayer-Vietoris exact sequences above.

$$\begin{array}{ccccccc} 0 & \longrightarrow & C_0^*(E_U + E_V) & \xrightarrow{(j_U^*, j_V^*)} & C_0^*(E_U) \oplus C_0^*(E_V) & \xrightarrow{i_U^* - i_V^*} & C^*(E_{U \cap V}) \longrightarrow 0 \\ & & \uparrow \tau'_{U \cup V} & & \uparrow \tau'_U \oplus \tau'_V & & \uparrow \tau'_{U \cap V} \\ 0 & \longrightarrow & C^*(U + V) & \xrightarrow{(j_U^*, j_V^*)} & C^*(U) \oplus C^*(V) & \xrightarrow{i_U^* - i_V^*} & C^*(U \cap V) \longrightarrow 0 \end{array}$$

Here we use the following notation: $C_*(U + V)$ is the free Abelian group generated by simplices lying in U and V , $C^*(U + V) = \text{Hom}_R(C_*(U + V), R)$. $C_0^*(E_U + E_V)$ are the cochains from $C^*(E_U + E_V)$ which are zeroes on simplices from $C_*(E_U^0 + E_V^0)$. $\tau'_U(a) = p^*(a) \cup t'_U$. (According to Lemma in 3.12 the cohomology of $C_0^*(E_U + E_V)$ is $H^*(E_{U \cup V}, E_{U \cup V}^0; R)$.)

There is just one cocycle $t'_{U \cup V}$ representing the Thom class $t_{U \cup V}$ such that

$$(j_U^*, j_V^*)(t'_{U \cup V}) = (t'_U, t'_V).$$

If we show that τ'_U , τ'_V , $\tau'_{U \cap V}$ and $\tau'_{U \cup V}$ are cochain homomorphisms which make the diagram commutative, then the diagram with the Mayer-Vietoris exact sequences will be also commutative. To prove the commutativity of the cochain diagram above is not difficult and left to the reader. Here we prove that τ'_U is a cochain homomorphism. (The proof for the other τ' is the same.)

Let $a \in C^k(U)$. Since t'_U is cocycle we get

$$\delta\tau'_U(a) = \delta(p^*(a) \cup t'_U) = \delta(p^*(a)) \cup t'_U + (-1)^k p^*(a) \cup \delta(t'_U) = p^*(\delta(a)) \cup t'_U = \tau'_U \delta(a).$$

(3) Let B be compact (particullary a finite CW-complex). Then there is a finite open covering U_1, U_2, \dots, U_m such that E_{U_i} is homeomorphic to $U_i \times \mathbb{R}^n$. So according to (1) the statement of Theorem holds for all E_{U_i} . Using (2) and induction we can show that Theorem holds for $E = \bigcup_{i=1}^m E_{U_i}$ as well.

(4) The proof for the other base spaces B needs a limit transitions in cohomology and the fact that for any B there is always a CW-complex X and a map $f : B \rightarrow X$ inducing isomorphism in cohomology. Here we omit this part. \square

8.5. Euler class. Let $\xi = (E, B, p)$ be oriented vector bundle of dimension n with the Thom class $t_\xi \in H^n(E, E^0; \mathbb{Z})$. Consider the standard inclusion $j : E \rightarrow (E, E^0)$. Since $p : E \rightarrow B$ is a homotopy equivalence, there is just one class $e(\xi) \in H^n(B; \mathbb{Z})$, called the *Euler class* of ξ , such that

$$p^*(e(\xi)) = j^*(t_\xi).$$

For R -oriented vector bundles we can define the Euler class $e(\xi) \in H^n(B; R)$ in the same way. Particulary, any vector bundle $\xi = (E, B, p)$ has an Euler class with \mathbb{Z}_2 -coefficients called the *n-th Stiefel-Whitney class* $w_n(\xi) \in H^n(B; \mathbb{Z}_2)$.

8.6. Gysin exact sequence. The following theorem gives us a useful tool for computation of the ring structure of singular cohomology of various spaces.

Theorem (Gysin exact sequence). *Let $\xi = (E, B, p)$ be an R -oriented vector bundle of dimension n with the Euler class $e(\xi) \in H^n(B; R)$. Then there is a homomorphism $\Delta^* : H^*(E^0; R) \rightarrow H^*(B; R)$ of modules over $H^*(B; R)$ such that the sequence*

$$\dots \xrightarrow{p^*} H^{k+n-1}(E^0; R) \xrightarrow{\Delta^*} H^k(B; R) \xrightarrow{\cup e(\xi)} H^{k+n}(B; R) \xrightarrow{p^*} H^{k+n}(E^0; R) \xrightarrow{\Delta^*} \dots$$

is exact.

Proof. The definition of Δ^* and the exactness follows from the following cummutative diagram where we have used the long exact sequence for the pair (E, E^0) and the Thom isomorphism τ :

$$\begin{array}{ccccccc} H^{k+n-1}(E^0) & \xrightarrow{\delta^*} & H^{k+n}(E, E^0) & \xrightarrow{j^*} & H^{k+n}(E) & \xrightarrow{i^*} & H^{k+n}(E^0) \\ & \searrow \Delta^* & \cong \uparrow \tau & & \cong \uparrow p^* & \nearrow p^* & \\ & & H^k(B) & \xrightarrow{\cup e(\xi)} & H^{k+n}(B) & & \end{array}$$

The right action of $b \in H^*(B)$ on $H^*(E^0)$ is given by

$$x \cdot b = x \cup i^* p^*(b), \quad x \in H^*(E^0).$$

Using the definition of the connecting homomorphism and the properties of cup product one can show that

$$\Delta^*(x \cdot b) = \Delta^*(x) \cup b.$$

The details are left to the reader. □

Example. Consider the canonical one dimensional vector bundle $\gamma = (E, \mathbb{R}\mathbb{P}^n, p)$ where

$$E = \{(l, v) \in \mathbb{R}\mathbb{P}^n \times \mathbb{R}^{n+1}; v \in l\},$$

the elements of $\mathbb{R}\mathbb{P}^n$ are identified with lines in \mathbb{R}^{n+1} and $p(l, v) = l$. The space E_0 is equal to $\mathbb{R}^{n+1} - \{0\}$ and homotopy equivalent to S^n .

Using the Gysin exact sequence with \mathbb{Z}_2 -coefficients and the fact that $H^k(\mathbb{R}\mathbb{P}^n; \mathbb{Z}_2) = \mathbb{Z}_2$ for $0 \leq k \leq n$, we get successively that the first Stiefel-Whitney class $w_1(\gamma) \in H^1(\mathbb{R}\mathbb{P}^n; \mathbb{Z}_2)$ is different from zero and that

$$H^*(\mathbb{R}\mathbb{P}^n; \mathbb{Z}_2) \cong \mathbb{Z}_2[w_1(\gamma)] / \langle w_1(\gamma)^{n+1} \rangle.$$

Exercise. Using the Gysin exact sequence show that

$$H^*(\mathbb{C}\mathbb{P}^n; \mathbb{Z}) \cong \mathbb{Z}[x] / \langle x^{n+1} \rangle$$

where $x \in H^2(\mathbb{C}\mathbb{P}^n; \mathbb{Z})$.

9. POINCARÉ DUALITY

Many interesting spaces used in geometry are closed oriented manifolds. Poincaré duality expresses a remarkable symmetry between their homology and cohomology.

9.1. Manifolds. A *manifold of dimension n* is a Hausdorff space M in which each point has an open neighbourhood U homeomorphic to \mathbb{R}^n . The dimension of M is characterized by the fact that for each $x \in M$, the local homology group $H_i(M, M - \{x\}; \mathbb{Z})$ is nonzero only for $i = n$ since by excision and homotopy equivalence

$$H_i(M, M - \{x\}; \mathbb{Z}) \cong H_i(U, U - \{x\}; \mathbb{Z}) \cong H_i(\mathbb{R}^n, \mathbb{R}^n - \{0\}; \mathbb{Z}) \cong \tilde{H}_{i-1}(S^{n-1}; \mathbb{Z}).$$

A compact manifold is called *closed*.

Example. Examples of closed manifolds are spheres, real and complex projective spaces, orthogonal groups $O(n)$ and $SO(n)$, unitary groups $U(n)$ and $SU(n)$, real and complex Stiefel and Grassmann manifolds. The real Stiefel manifold $V_{n,k}$ is the space of k -tuples of orthonormal vectors in \mathbb{R}^n . The real Grassmann manifolds $G_{n,k}$ is the space of k -dimensional vector subspaces of \mathbb{R}^n .

9.2. Orientation of manifolds. Consider a manifold M of dimension n . A *local orientation* of M in a point $x \in M$ is a choice of a generator $\mu_x \in H_n(M, M - \{x\}; \mathbb{Z}) \cong \mathbb{Z}$.

To shorten our notation we will use $H_i(M|A)$ for $H_i(M, M - A; \mathbb{Z})$ and $H^i(M|A)$ for $H^i(M; M - A; \mathbb{Z})$ if $A \subseteq M$.

An *orientation* of M is a function assigning to each point $x \in M$ a local orientation $\mu_x \in H_n(M|x)$ such that each point has an open neighbourhood B with the property that all local orientations μ_y for $y \in B$ are images of an element $\mu_B \in H_n(M|B)$ under the map $\rho_{y*} : H_n(M|B) \rightarrow H_n(M|x)$ where $\rho_y : (M, M - \{x\}) \rightarrow (M, M - B)$ is the natural inclusion.

If an orientation exists on M , the manifold is called *orientable*. A manifold with a chosen orientation is called *oriented*.

Proposition. *A connected manifold M is orientable if it is simply connected, i. e. every map $S^1 \rightarrow M$ is homotopic to a constant map.*

For the proof one has to know more about covering spaces and fundamental group. See [Hatcher], Proposition 3.25, pages 234 – 235.

In the same way we can define an R -orientation of a manifold for any commutative ring R . Every manifold is \mathbb{Z}_2 -oriented.

9.3. Fundamental class. A *fundamental class* of a manifold M with coefficients in R is an element $\mu \in H_n(M; R)$ such that $\rho_{x*}(\mu)$ is a generator of $H_n(M|x; R) = R$ for each $x \in M$ where $\rho_x : (M, \emptyset) \rightarrow (M, M - \{x\})$ is the obvious inclusion. It is usual to denote the fundamental class of the manifold M by $[M]$. We will keep this notation.

If a fundamental class of M exists, it determines uniquely the orientation $\mu_x = \rho_{x*}([M])$ of M .

Theorem. *Let M be a closed manifold of dimension n . Then:*

- (a) *If M is R -orientable, the natural map $H_n(M; R) \rightarrow H_n(M|x; R) = R$ is an isomorphism for all $x \in M$.*
- (b) *If M is not R -orientable, the natural map $H_n(M; R) \rightarrow H_n(M|x; R) = R$ is injective with the image $\{r \in R; 2r = 0\}$ for all $x \in M$.*
- (c) *$H_i(M; R) = 0$ for all $i > n$.*

(a) implies immediately that very oriented closed manifold has just one fundamental class. It is a suitable generator of $H_n(M; R)$.

The theorem will follow from a more technical statement:

Lemma. *Let M be n -manifold and let $A \subseteq M$ be compact. Then:*

- (a) *$H_i(M|A; R) = 0$ for $i > n$ and $\alpha \in H_n(M|A; R)$ is zero iff its image $\rho_{x*}(\alpha) \in H_n(M|x; R)$ is zero for all $x \in M$.*
- (b) *If $x \mapsto \mu_x$ is an R -orientation of M , then there is $\mu_A \in H_n(M|A; R)$ whose image in $H_n(M|x; R)$ is μ_x for all $x \in A$.*

To prove the theorem put $A = M$. We get immediately (c) of the theorem. Further, the lemma implies that an oriented manifold M has a fundamental class $[M] = \mu_M$ and any other element in $H_n(M; R)$ has to be its multiple in R . So we obtain (a) of the theorem. For the proof of (b) we refer to [Hatcher], pages 234 – 236.

Proof of Lemma. Since R does not play any substantial role in our considerations, we will omit it from our notation. We will omit also stars in notation of maps induced in homology. The proof will be divided into several steps.

(1) Suppose that the statements are true for compact subsets A , B and $A \cap B$ of M . We will prove them for $A \cup B$ using the Mayer-Vietoris exact sequence:

$$0 \rightarrow H_n(M|A \cup B) \xrightarrow{\Phi} H_n(M|A) \oplus H_n(M|B) \xrightarrow{\Psi} H_n(M|A \cap B)$$

where $\Phi(\alpha) = (\rho_A \alpha, \rho_B \alpha)$, $\Psi(\alpha, \beta) = \rho_{A \cap B} \alpha - \rho_{A \cap B} \beta$.

$H_i(M|A \cup B) = 0$ for $i > n$ is immediate from the exact sequence. Suppose $\alpha \in H_n(M|A \cup B)$ restricted to $H_n(M|x)$ is zero for all $x \in A \cup B$. Then $\rho_A \alpha$ and $\rho_B \alpha$ are zeroes. Since Φ is a monomorphism, α has to be also zero.

Take μ_A and μ_B such that their restrictions to $H_n(M|x)$ are orientations. Then the restrictions to points $x \in A \cap B$ are the same. Hence also the restrictions to $A \cap B$ coincide. It means $\Psi(\mu_A, \mu_B) = 0$ and the Mayer-Vietoris exact sequence yields the existence of α in $H_n(M|A \cup B)$ such that $\Phi(\alpha) = (\mu_A, \mu_B)$. Therefore α reduces to a generator of $H_n(M|x)$ for all $x \in A \cup B$, and consequently, $\alpha = \mu_{A \cup B}$.

(2) If $M = \mathbb{R}^n$ and A is a compact convex set in a disc D containing an origin 0 , the lemma is true since the composition given by inclusions

$$H_i(\mathbb{R}^n|D) \longrightarrow H_i(\mathbb{R}^n|A) \longrightarrow H_i(\mathbb{R}^n|0)$$

is an isomorphism.

(3) If $M = \mathbb{R}^n$ and A is finite simplicial complex in \mathbb{R}^n , then $A = \bigcup_{i=1}^m A_i$ where A_i are convex compact sets. Using (1) and induction by m we can prove that the lemma holds in this case as well.

(4) Let $M = \mathbb{R}^n$ and A is an arbitrary compact subset. Let $\alpha \in H_i(\mathbb{R}^n|A)$ be represented by a relative cycle $z \in Z_i(\mathbb{R}^n, \mathbb{R}^n - A)$. Let $C \subset \mathbb{R}^n - A$ be the union of images of the singular simplices in ∂z . Since C is compact, $\text{dist}(C, A) > 0$, and consequently, there is a finite simplicial complex $K \supset A$ such that $C \subset \mathbb{R}^n - K$. (Draw a picture.) So the chain z defines also an element $\alpha_K \in H_i(\mathbb{R}^n|K)$ which reduces to $\alpha \in H_i(\mathbb{R}^n|A)$. If $i > n$, then by (3) $\alpha_K = 0$ and consequently also $\alpha = 0$.

Suppose that $i = n$ and that α reduces to zero in each point $x \in A$. K can be chosen in such a way that every its point lies in a simplex of K together with a point of A . Consequently, α_K reduces to zero not only for all $x \in A$ but for all $x \in K$. (Use the case (2) to prove it.) By (3) $\alpha_K = 0$, and therefore also $\alpha = 0$.

The proof of existence of $\mu_A \in H_n(\mathbb{R}^n|A)$ in the statement (b) is easy. Take $\mu_B \in H_n(\mathbb{R}^n|B)$ for a ball $B \supset A$ and its reduction is μ_A .

(5) Let M be a general manifold and A a compact subset in an open set U homeomorphic to \mathbb{R}^n . Now by excision

$$H_i(M|A) \cong H_i(U|A) \cong H_i(\mathbb{R}^n|A)$$

and we can use (4).

(6) Let M be a manifold and A an arbitrary compact set. Then A can be covered by open sets V_1, V_2, \dots, V_m such that the closure of V_i lies in an open set U_i homeomorphic to \mathbb{R}^n . Then by (5) the lemma holds for $A_i = A \cap \bar{V}_i$. By (1) and induction it holds also for $\bigcup_{i=1}^m A_i = A$. \square

9.4. Cap product. Let X be a space. On the level of chains and cochains the *cap product*

$$\cap : C_n(X; R) \otimes C^k(X; R) \rightarrow C_{n-k}(X; R)$$

is given for $0 \leq k \leq n$ by

$$\sigma \cap \varphi = \varphi(\sigma/[v_0, v_1, \dots, v_k])\sigma/[v_k, v_{k+1}, \dots, v_n]$$

where σ is a singular n -simplex, $\varphi : C^k(X; R) \rightarrow R$ is a cochain and $\sigma/[v_0, v_1, \dots, v_k]$ is the composition of the inclusion of Δ^k into the indicated face of Δ^n with σ , and is given by zero in the remaining cases.

The proof of the following statement is similar as in the case of cup product and is left to the reader as an exercise.

Lemma A. For $\sigma \in C_n(X; R)$ and $\varphi \in C^k(X; R)$

$$\partial(\sigma \cap \varphi) = (-1)^k(\partial\sigma \cap \varphi - \sigma \cap \delta\varphi)$$

This enables us to define

$$\cap : H_n(X; R) \otimes H^k(X; R) \rightarrow H_{n-k}(X; R)$$

by

$$[\sigma] \cap [\varphi] = [\sigma \cap \varphi]$$

for all cycles σ and cocycles φ . In the same way one can define

$$\begin{aligned}\cap : H_n(X, A; R) \otimes H^k(X; R) &\rightarrow H_{n-k}(X, A; R) \\ \cap : H_n(X, A; R) \otimes H^k(X, A; R) &\rightarrow H_{n-k}(X; R)\end{aligned}$$

for any pair (X, A) and

$$\cap : H_n(X, A \cup B; R) \otimes H^k(X, A; R) \rightarrow H_{n-k}(X, B; R)$$

for A, B open in X or subcomplexes of CW-complex X .

Exercise. Show the correctness of all the definitions above and prove the following lemma.

Lemma B (Naturality of cup product). *Let $f : (X, A) \rightarrow (Y, B)$. Then*

$$f_*(\alpha \cap f^*(\beta)) = f_*(\alpha) \cap \beta$$

for all $\alpha \in H_n(X, A; R)$ and $\beta \in H^k(Y; R)$.

9.5. Poincaré duality. Now we have all the tools needed to state the Poincaré duality for closed manifolds.

Theorem (Poincaré duality). *If M is a closed R -orientable manifold of dimension n with fundamental class $[M] \in H_n(M; R)$, then the map $D : H^k(M; R) \rightarrow H_{n-k}(M; R)$ defined by*

$$D(\varphi) = [M] \cap \varphi$$

is an isomorphism.

Exercise. Use Poincaré duality to show that the real projective spaces of even dimension are not orientable.

This theorem is a consequence of a more general version of Poincaré duality. To state it we introduce the notion of direct limit and cohomology with compact support.

9.6. Direct limits. A *direct set* is a partially ordered set I such that for each pair $\iota, \kappa \in I$ there is $\lambda \in I$ such that $\iota \leq \lambda$ and $\kappa \leq \lambda$.

Let G_ι be a system of Abelian groups (or R -modules) indexed by elements of a directed set I . Suppose that for each pair $\iota \leq \kappa$ of indices there is a homomorphism $f_{\iota\kappa} : G_\iota \rightarrow G_\kappa$ such that $f_{\iota\iota} = \text{id}$ and $f_{\kappa\lambda}f_{\iota\kappa} = f_{\iota\lambda}$. Then such a system is called *directed*.

Having a directed system of Abelian groups (or R -modules) we will say that $a \in G_\iota$ and $b \in G_\kappa$ are equivalent ($a \simeq b$) if $f_{\iota\lambda}(a) = f_{\kappa\lambda}(b)$ for some $\lambda \in I$. The direct limit of the system $\{G_\iota\}_{\iota \in I}$ is the Abelian group (R -module) of classes of this equivalence

$$\varinjlim G_\iota = \bigoplus_{\iota \in I} G_\iota / \simeq .$$

Moreover, we have natural homomorphism $j_\iota : G_\iota \rightarrow \varinjlim G_\iota$.

The direct limit is characterized by the following universal property: Having a system of homomorphism $h_\iota : G_\iota \rightarrow A$ such that $h_\iota = h_\kappa f_{\iota\kappa}$ whenever $\iota \leq \kappa$, there is just one homomorphism

$$H : \varinjlim G_\iota \rightarrow A$$

such that $h_\iota = H j_\iota$.

It is not difficult to prove that direct limits preserve exact sequences.

In a system of sets the ordering is usually given by inclusions.

Lemma. *If a space X is the union of a directed set of subspaces X_ι with the property that each compact set in X is contained in some X_ι , the natural map*

$$\varinjlim H_n(X_\iota; R) \rightarrow H_n(X; R)$$

is an isomorphism.

The proof is not difficult, we refer to [Hatcher], Proposition 3.33, page 244.

9.7. Cohomology groups with compact support. Consider a space X with a directed system of compact subsets. For each pair (L, K) , $K \subseteq L$, the inclusion $(X, X - L) \hookrightarrow (X, X - K)$ induces homomorphism $H^k(X|K; R) \rightarrow H^k(X|L; R)$. We define the cohomology groups with compact support as

$$H_c^k(X; R) = \varinjlim H^k(X|K; R).$$

If X is compact, then $H_c^k(X; R) = H^k(X; R)$.

For cohomology with compact support we get the following lemma which does not hold for ordinary cohomology groups.

Lemma. *If a space X is the union of a directed set of open subspaces X_ι with the property that each compact set in X is contained in some X_ι , the natural map*

$$\varinjlim H_c^k(X_\iota; R) \rightarrow H_c^k(X; R)$$

is an isomorphism.

Proof. The definition of natural homomorphism in the lemma is based on the following fact: Let U be an open subset in V . For any compact set $K \subset U$ the inclusion $(U, U - K) \hookrightarrow (V, V - K)$ induces by excision an isomorphism

$$H^k(V|K; R) \rightarrow H^k(U|K; R).$$

Its inverse can be composed with natural homomorphism $H^k(V|K; R) \rightarrow H_c^k(V; R)$. By the universal property of direct sum there is just one homomorphism

$$H_c^k(U; R) \rightarrow H_c^k(V; R).$$

So on inclusions of open sets H_c^k behaves as covariant functor and this makes the definition of the natural homomorphism in the lemma possible. The proof that it is an isomorphism (based on excision) is left to the reader. \square

9.8. Generalized Poincaré duality. Let M be an R -orientable manifold of dimension n . Let $K \subseteq M$ be compact. Let $\mu_K \in H_n(M|K; R)$ be such a class that its reduction to $H_n(M|x; R)$ gives a generator for each $x \in K$. The existence of such a class is ensured by Lemma in 9.3. Define

$$D_K : H^k(M|K) \rightarrow H_{n-k}(M; R) : \quad D_K(\varphi) = \mu_K \cap \varphi.$$

If $K \subset L$ are two compact subsets of M , we can easily prove using naturality of cap product that

$$D_L(\rho^* \varphi) = D_K(\varphi)$$

for $\varphi \in H^k(M|K; R)$ and $\rho : (M, M - L) \hookrightarrow (M, M - K)$. It enables us to define the *generalized duality map*

$$D_M : H_c^k(M; R) \rightarrow H_{n-k}(M; R) : \quad D_M(\varphi) = \mu_K \cap \varphi$$

since each element $\varphi \in H_c^k(M; R)$ is contained in $H^k(M|K; R)$ for some compact set $K \subseteq M$.

Theorem (Duality for all orientable manifolds). *If M is an R -orientable manifold of dimension n , then the duality map*

$$D_M : H_c^k(M; R) \rightarrow H_{n-k}(M; R)$$

is an isomorphism.

The proof is based on the following

Lemma. *If a manifold M be a union of two open subsets U and V , the following diagram of Mayer-Vietoris sequences*

$$\begin{array}{ccccccc} H_c^k(U \cap V) & \longrightarrow & H_c^k(U) \oplus H_c^k(V) & \longrightarrow & H_c^k(M) & \longrightarrow & H_c^{k+1}(U \cap V) \\ \downarrow D_{U \cap V} & & \downarrow D_U \oplus D_V & & \downarrow D_M & & \downarrow D_{U \cap V} \\ H_{n-k}(U \cap V) & \longrightarrow & H_{n-k}(U) \oplus H_{n-k}(V) & \longrightarrow & H_{n-k}(M) & \longrightarrow & H_{n-k-1}(U \cap V) \end{array}$$

commutes up to signs.

The proof of this lemma is analogous as the proof of commutativity of the diagram in the proof of Theorem 8.4 on Thom isomorphism. So we omit it referring the reader to [Hatcher], Lemma 3.36, pages 246 – 247 or to [Bredon], Chapter VI, Lemma 8.2, pages 350 – 351.

Proof of Poincaré Duality Theorem. We will use the following two statements

- (A) If $M = U \cup V$ where U and V are open subsets such that D_U , D_V and $D_{U \cap V}$ are isomorphisms, then D_M is also an isomorphism.
- (B) If $M = \bigcup_{i=1}^{\infty} U_i$ where U_i are open subsets such that $U_1 \subset U_2 \subset U_3 \subset \dots$ and all D_{U_i} are isomorphisms, then D_M is also an isomorphism.

The former is an immediate consequence of the previous lemma and Five Lemma. To obtain the latter apply the direct limit to the short exact sequences

$$0 \rightarrow H_c^k(U_i) \xrightarrow{D_{U_i}} H_{n-k}(U_i) \rightarrow 0$$

and use the lemmas in 9.6 and 9.7. The proof of Duality Theorem will be carried out in four steps.

(1) For $M = \mathbb{R}^n$ we have

$$H_c^k(\mathbb{R}^n) \cong H^k(\Delta^n, \partial\Delta^n), \quad H_n(\mathbb{R}^n|\Delta^n) \cong H_n(\Delta^n, \partial\Delta^n).$$

Take the generator $\mu \in H_n(\Delta^n, \partial\Delta^n)$ represented by the singular simplex given by identity. The only nontrivial case is $k = n$. In this case for a generator

$$\varphi \in H^n((\Delta^n, \partial\Delta^n)) = \text{Hom}(H_n((\Delta^n, \partial\Delta^n)), R)$$

we get $\mu \cap \varphi = \varphi(\mu) = \pm 1$. So the duality map is an isomorphism.

(2) Let $M \subset \mathbb{R}^n$ be open. Then M is a countable union of open convex sets V_i which are homeomorphic to \mathbb{R}^n . Using the previous step and induction in statement (A) we show that the duality map is an isomorphism for every finite union of V_i . The application of statement (B) yields that the duality map D_M is an isomorphism as well.

(3) Let M be a manifold which is a countable union of open sets U_i which are homeomorphic to \mathbb{R}^n . Now we can proceed in the same way as in (2) using its result instead of the result in (1).

(4) For general M we have to use Zorn lemma. See [Hatcher], page 248. \square

Corollary. *The Euler characteristic of a closed manifold of odd dimension is zero.*

Proof. For M orientable we get from Poincaré duality and the universal coefficient theorem that

$$\begin{aligned} \text{rank } H_{n-k}(M; \mathbb{Z}) &= \text{rank } H^k(M; \mathbb{Z}) = \text{rank } \text{Hom } H_k(M; \mathbb{Z}) \\ &= \text{rank } H_k(M; \mathbb{Z}) \end{aligned}$$

Hence $\chi(M) = \sum_{i=0}^n (-1)^i \text{rank } H_i(M; \mathbb{Z}) = 0$ for n odd.

If M is not orientable, we get from the Poincaré duality with \mathbb{Z}_2 coefficients that

$$\sum_{i=0}^n (-1)^i \dim H_i(M; \mathbb{Z}_2) = 0.$$

Here the dimension is considered over \mathbb{Z}_2 . Applying the universal coefficient theorem one can show that the expression on the left hand side equals to $\chi(M)$. See [Hatcher], page 249. \square

Remark. Consider an oriented closed smooth manifold M . The orientation of the manifold induces an orientation of the tangent bundle τ_M and we get the following relation between the Euler class of τ_M , the fundamental class of M and the Euler characteristic of M :

$$\chi(M) = e(\tau_M) \cap [M].$$

Particulary, for spheres of even dimension we get that the Euler class of their tangent bundle is twice a generator of $H^n(S^n; \mathbb{Z})$. For the proof see [MS], Corollary 11.12.

9.9. Duality and cup product. One can easily show that for $\alpha \in C_n(X; R)$, $\varphi \in C^k(X; R)$ and $\psi \in C^{n-k}(X; R)$ we have

$$\psi(\alpha \cap \varphi) = (\varphi \cup \psi)(\alpha).$$

For a closed R -orientable manifold M we define bilinear form

$$(*) \quad H^k(M; R) \times H^{n-k}(M; R) \rightarrow R: (\varphi, \psi) \mapsto (\varphi \cup \psi)[M].$$

A bilinear form $A \times B \rightarrow R$ is called *regular* if induced linear maps $A \rightarrow \text{Hom}(B, R)$ and $B \rightarrow \text{Hom}(A, R)$ are isomorphisms.

Theorem. *Let M be a closed R -orientable manifold. If R is a field, then the bilinear form $(*)$ is regular.*

If $R = \mathbb{Z}$, then the bilinear form

$$H^k(M; \mathbb{Z}) / \text{Torsion} \times H^{n-k}(M; \mathbb{Z}) / \text{Torsion} \rightarrow \mathbb{Z}$$

induced by $()$ is regular.*

Proof. Consider the homomorphism

$$H^{n-k}(M; R) \xrightarrow{h} \text{Hom}(H_{n-k}(M; R); R) \xrightarrow{D^*} \text{Hom}(H^k(M; R), R).$$

Here $h(\psi)(\beta) = \psi(\beta)$ for $\beta \in H_{n-k}(M; R)$ and $\psi \in H^{n-k}(M; R)$ and D^* is the dual map to duality. The homomorphism h is an isomorphism by the universal coefficient theorem and D^* is an isomorphism since so is D . Now it suffices to prove that the composition D^*h is the homomorphism induced from the bilinear form $(*)$. For $\psi \in H^{n-k}(M; R)$ and $\varphi \in H^k(M; R)$ we get

$$(D^*h(\psi))(\varphi) = (h(\psi))D(\varphi) = (h(\psi))([M] \cap \varphi) = \psi([M] \cap \varphi) = (\varphi \cup \psi)[M].$$

□

This theorem gives us a further tool for computing the cup product structure in cohomology of closed manifolds.

Corollary. *Let M be a closed orientable manifold of dimension n . Then for every $\varphi \in H^k(M; \mathbb{Z})$ of infinite order which is not of the form $\varphi = m\varphi_1$ for $m > 1$, there is $\psi \in H^{n-k}(M; \mathbb{Z})$ such that $\varphi \cup \psi$ is a generator of $H^n(M; \mathbb{Z}) \cong \mathbb{Z}$.*

Example. We will prove by induction that $H^*(\mathbb{C}\mathbb{P}^n; \mathbb{Z}) = \mathbb{Z}[\omega] / \langle \omega^{n+1} \rangle$ where $\omega \in H^2(\mathbb{C}\mathbb{P}^n; \mathbb{Z})$ is a generator. For $n = 1$ the statement is clear. Suppose that it holds for $n - 1$. From the long exact sequence for the pair $(\mathbb{C}\mathbb{P}^n, \mathbb{C}\mathbb{P}^{n-1})$ we get that

$$H^i(\mathbb{C}\mathbb{P}^n; \mathbb{Z}) \cong H^i(\mathbb{C}\mathbb{P}^{n-1}; \mathbb{Z})$$

for $i \leq 2n - 1$. Now, using the consequence above for $\varphi = \omega$ we obtain that ω^n is a generator of $H^{2n}(\mathbb{C}\mathbb{P}^n; \mathbb{Z})$.

9.10. Manifolds with boundary. A *manifold with boundary* of dimension n is a Hausdorff space M in which each point has an open neighbourhood homeomorphic either to \mathbb{R}^n or to the half-space

$$\mathbb{R}_+^n = \{(x_1, x_2, \dots, x_n) \in \mathbb{R}^n; x_n \geq 0\}.$$

The boundary ∂M of the manifold M is formed by points which have all neighbourhoods of the second type. The boundary of a manifold of dimension n is a manifold of dimension $n - 1$. In a similar way as for a manifold we can define orientation of a manifold with boundary and its fundamental class $[M] \in H_n(M; \partial M; R)$.

Theorem. *Suppose that M is a compact R -orientable n -dimensional manifold whose boundary ∂M is decomposed as a union of two compact $(n - 1)$ -dimensional manifolds A and B with common boundary $\partial A = \partial B = A \cap B$. Then the cap product with the fundamental class $[M] \in H_n(M, \partial M; R)$ gives the isomorphism*

$$D_M : H^k(M, A; R) \rightarrow H_{n-k}(M, B; R).$$

For the proof and many other applications of Poincaré duality we refer to [Hatcher], Theorem 3.43 and pages 250 – 254, and [Bredon], Chapter VI, Sections 9 and 10, pages 355 – 366.

9.11. Alexander duality. In this paragraph we introduce another version of duality.

Theorem (Alexander duality). *If K is a proper compact subset of S^n which is a deformation retract of an open neighbourhood, then*

$$\tilde{H}_i(S^n - K; \mathbb{Z}) \cong \tilde{H}^{n-i-1}(K; \mathbb{Z}).$$

Proof. For $i \neq 0$ and U a neighbourhood of K we have

$$\begin{aligned} H_i(S^n - K) &\cong H_c^{n-i}(S^n - K) && \text{by Poincaré duality} \\ &\cong \varinjlim_U H^{n-i}(S^n - K, U - K) && \text{by definition} \\ &\cong \varinjlim_U H^{n-i}(S^n, U) && \text{by excision} \\ &\cong \varinjlim_U \tilde{H}^{n-i-1}(U) && \text{connecting homomorphism} \\ &\cong \tilde{H}^{n-i-1}(K) && K \text{ is a def. retract of some } U \end{aligned}$$

First three isomorphisms are natural and exist also for $i = 0$. So using these facts we have

$$\begin{aligned} \tilde{H}_0(S^n - K) &\cong \text{Ker}(H_0(S^n - K) \rightarrow H_0(\text{pt})) \\ &\cong \text{Ker}(H_0(S^n - K) \rightarrow H_0(S^n)) \\ &\cong \text{Ker}\left(\varinjlim H^n(S^n, U) \rightarrow H^n(S^n)\right) \\ &\cong \varinjlim \text{Ker}(H^n(S^n, U) \rightarrow H^n(S^n)) \\ &\cong \varinjlim H^{n-1}(U) = H^{n-1}(K). \end{aligned}$$

□

Corollary. *A closed nonorientable manifold of dimension n cannot be embedded as a subspace into \mathbb{R}^{n+1} .*

Proof. Suppose that M can be embedded into \mathbb{R}^{n+1} . Then it can be embedded also in S^{n+1} . By Alexander duality

$$H_{n-1}(M; \mathbb{Z}) \cong H^1(S^{n+1} - M; \mathbb{Z}).$$

According to the universal coefficient theorem

$$H^1(S^{n+1} - M; \mathbb{Z}) \cong \text{Hom}(H_1(S^{n+1} - M; \mathbb{Z}), \mathbb{Z}) \oplus \text{Ext}(H_0(S^{n+1} - M; \mathbb{Z}))$$

is a free Abelian group. On the other hand

$$\mathbb{Z}_2 = H_n(M; \mathbb{Z}_2) \cong H_n(M; \mathbb{Z}) \otimes \mathbb{Z}_2 \oplus \text{Tor}(H_{n-1}(M, \mathbb{Z}), \mathbb{Z}_2).$$

According to (b) of Theorem 9.3 the tensor product has to be zero, and since $H_{n-1}(M; \mathbb{Z})$ is free, the second summand has to be also zero, which is a contradiction. \square

10. HOMOTOPY GROUPS

In this section we will define homotopy groups and derive their basic properties. While the definition of homotopy groups is relatively simple, their computation is complicated in general.

10.1. Homotopy groups. Let I^n be the n -dimensional unit cube and ∂I^n its boundary. For $n = 0$ we take I^0 to be one point and ∂I^0 to be empty. Consider a space X with a basepoint x_0 . Maps $(I^n, \partial I^n) \rightarrow (X, x_0)$ are the same as the maps of the quotient $(S^n = I^n/\partial I^n, s_0 = \partial I^n/\partial I^n) \rightarrow (X, x_0)$. We define the n -th *homotopy group* of the space X with the basepoint x_0 as

$$\pi_n(X, x_0) = [(S^n, s_0), (X, x_0)] = [(I^n, \partial I^n), (X, x_0)].$$

$\pi_0(X, x_0)$ is the set of path connected components of X with the component containing x_0 as a distinguished element. For $n \geq 1$ we can introduce a sum operation on $\pi_n(X, x_0)$

$$(f + g)(t_1, t_2, \dots, t_n) = \begin{cases} f(2t_1, t_2, \dots, t_n) & t_1 \in [0, \frac{1}{2}], \\ g(2t_1 - 1, t_2, \dots, t_n) & t_1 \in [\frac{1}{2}, 1]. \end{cases}$$

This operation is well defined on homotopy classes. It is easy to show that $\pi_n(X, x_0)$ is a group with identity element represented by the constant map to x_0 and with the inverse represented by

$$-f(t_1, t_2, \dots, t_n) = f(1 - t_1, t_2, \dots, t_n).$$

For $n \geq 2$ the groups $\pi_n(X, x_0)$ are commutative. The proof is indicated by the following pictures.

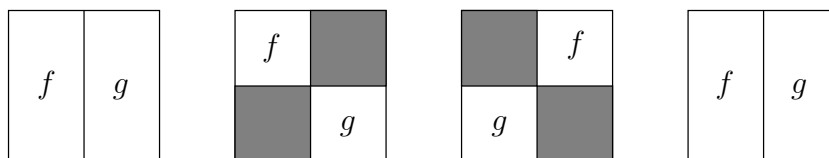

FIGURE 10.1. $f + g \sim g + f$

In the interpretation of $\pi_n(X, x_0)$ as $[(S^n, s_0), (X, x_0)]$, the sum $f + g$ is the composition

$$S^n \xrightarrow{c} S^n \vee S^n \xrightarrow{f \vee g} X$$

where c collapses the equator S^{n-1} of S^n to a point $s_0 \in S^{n-1} \subset S^n$.

Any map $F : (X, x_0) \rightarrow (Y, y_0)$ induces the homomorphism $F_* : \pi_n(X, x_0) \rightarrow \pi_n(Y, y_0)$ by composition

$$F_*([f]) = [Ff].$$

Hence π_n is a functor from \mathbf{Top}_* to the category of Abelian groups \mathbf{Ab} for $n \geq 2$, to the category of groups \mathbf{G} for $n = 1$ and to the category of sets with distinguished element \mathbf{Set}_* for $n = 0$.

10.2. Relative homotopy groups. Consider I^{n-1} as a face of I^n with the last coordinate $t_n = 0$. Denote J^{n-1} the closure of $\partial I^n - I^{n-1}$. Let (X, A) be a pair with basepoint $x_0 \in A$. For $n \geq 1$ we define the n -th *relative homotopy group of the pair* (X, A) as

$$\pi_n(X, A, x_0) = [(D^n, S^{n-1}, s_0), (X, A, x_0)] = [(I^n, \partial I^n, J^{n-1}), (X, A, x_0)].$$

A sum operation on $\pi_n(X, A, x_0)$ is defined by the same formula as for $\pi_n(X, x_0)$ only for $n \geq 2$. (Explain why this definition does not work for $n = 1$.) Similarly as in the case of absolute homotopy groups one can show that $\pi_n(X, A, x_0)$ is a group for $n \geq 2$ which is commutative if $n \geq 3$.

Sometimes it is useful to know how the representatives of zero (neutral element) in $\pi_n(X, A, x_0)$ look like. We say that two maps $f, g : (D^n, S^{n-1}, s_0) \rightarrow (X, A, x_0)$ are *homotopic rel S^{n-1}* if there is a homotopy h between f and g such that $h(x, t) = f(x) = g(x)$ for all $x \in S^{n-1}$ and all $t \in I$.

Proposition. A map $f : (D^n, S^{n-1}, s_0) \rightarrow (X, A, x_0)$ represents zero in $\pi_n(X, A, x_0)$ iff it is homotopic rel S^{n-1} to a map with image in A .

Proof. Suppose that $f \sim g \text{ rel } S^{n-1}$ and $g(D^n) \subseteq A$. Then $g = g \circ \text{id}_{D^n}$ is homotopic to the constant map $g \circ \text{const}$ into $x_0 \in A$. Hence $[f] = [g] = 0$.

Let f be homotopic to the constant map via homotopy $h : D^n \times I \rightarrow X$. Have a look at the picture and consider the subset

$$C = \{(x, t) \in D^n \times I; 2\|x\| \leq 2 - t\}$$

of $D^n \times I$ simultaneously with a vertical retraction $r : D^n \times I \rightarrow C$ and a horizontal homeomorphism $q : C \rightarrow D^n \times I$.

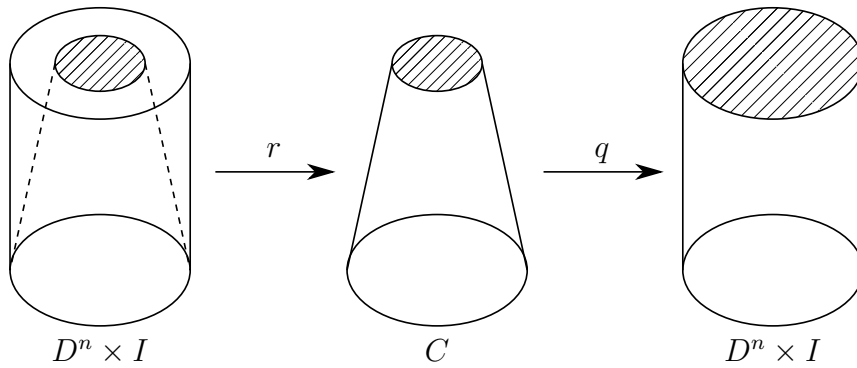

FIGURE 10.2. Retraction r and homeomorphism q

The maps can be defined in the following way:

$$r(x, t) = \begin{cases} (x, t) & \text{for } 2\|x\| \leq 2 - t, \\ (x, 2(1 - \|x\|)) & \text{for } 2\|x\| \geq 2 - t \end{cases}$$

and

$$q(x, t) = \left(\frac{2}{2-t}x, t \right).$$

Now $H = h \circ q \circ r : D^n \times I \rightarrow X$ is a homotopy between $H(x, 0) = h(x, 0) = f(x)$ and $H(x, 1) = g(x)$ where

$$g(D^n) = H(D^n \times I) = h(D^n \times \{1\} \cup S^{n-1} \times I) \subseteq A$$

and H is a homotopy rel S^{n-1} . \square

A map $F : (X, A, x_0) \rightarrow (Y, B, y_0)$ induces again the homomorphism $F_* : \pi_n(X, A, x_0) \rightarrow \pi_n(Y, B, y_0)$. Since $\pi_n(X, x_0, x_0) = \pi_n(X, x_0)$ the functor π_n on \mathbf{Top}_* can be extended to a functor from \mathbf{Top}_*^2 to Abelian groups \mathbf{Ab} for $n \geq 3$, to the category of groups \mathbf{G} for $n = 2$ and to the category \mathbf{Set}_* of sets with distinguished element for $n = 1$.

From definitions it is clear that homotopic maps induce the same homomorphisms between homotopy groups. Hence homotopy equivalent spaces have the same homotopy groups. Particularly, contractible spaces have trivial homotopy groups.

10.3. Long exact sequence of a pair. Relative homotopy groups fit into the following long exact sequence of a pair.

Theorem. *Let (X, A) be a pair of spaces with a distinguished point $x_0 \in A$. Then the sequence*

$$\cdots \rightarrow \pi_n(A, x_0) \xrightarrow{i_*} \pi_n(X, x_0) \xrightarrow{j_*} \pi_n(X, A, x_0) \xrightarrow{\delta} \pi_{n-1}(A, x_0) \rightarrow \cdots$$

where $i : A \hookrightarrow X$, $j : (X, x_0) \hookrightarrow (X, A)$ are inclusions and δ comes from restriction, is exact.

More generally, any triple $B \subseteq A \subseteq X$ induces the long exact sequence

$$\cdots \rightarrow \pi_n(A, B, x_0) \xrightarrow{i_*} \pi_n(X, B, x_0) \xrightarrow{j_*} \pi_n(X, A, x_0) \xrightarrow{\delta} \pi_{n-1}(A, B, x_0) \rightarrow \cdots$$

Proof. We will prove only the version for the pair (X, A) . δ is defined on $[f] \in \pi_n(X, A, x_0)$ by

$$\delta[f] = [f/I^{n-1}].$$

Exactness in $\pi_n(X, x_0)$. According to the previous proposition $j_*i_* = 0$, hence $\text{Im } i_* \subseteq \text{Ker } j_*$. Let $[f] \in \text{Ker } j_*$ for $f : (I^n, \partial I^n) \rightarrow (X, x_0)$. Using again the previous proposition $f \sim g \text{ rel } \partial I^n$ where $g : I^n \rightarrow A$. Hence $[f] = i_*[g]$.

Exactness in $\pi_n(X, A, x_0)$. $\delta j_* = 0$, hence $\text{Im } j_* \subseteq \text{Ker } \delta$. Let $[f] \in \text{Ker } \delta$, i. e. $f(I^n, \partial I^n, J^{n-1}) \rightarrow (X, A, x_0)$ and $f/I^{n-1} \sim \text{const}$. Then according to HEP there is $f_1 : (I^n, \partial I^n, J^n) \rightarrow (X, x_0, x_0)$ homotopic to f . Therefore $[f_1] \in \pi_n(X, x_0)$ and $[f] = j_*[f_1]$.

Exactness in $\pi_n(A, x_0)$. Let $[F] \in \pi_{n+1}(X, A, x_0)$. Then $i \circ F/I^n : I^n \rightarrow X$ is a map homotopic to the constant map to x_0 through the homotopy F . (Draw a picture.)

Let $f : (I^n, \partial I^n) \rightarrow (A, x_0)$ and $f \sim 0$ through the homotopy $F : I^n \times I \rightarrow X$ such that $F(x, 0) = f(x) \in A$, $F/J^n = x_0$. Hence $[F] \in \pi_{n+1}(X, A, x_0)$ and $\delta[F] = [f]$. \square

Remark. The boundary operator for a triple (X, A, B) is the composition

$$\pi_n(X, A) \xrightarrow{\delta} \pi_n(A) \xrightarrow{j_*} \pi_{n-1}(A, B).$$

10.4. Changing basepoints. Let X be a space and $\gamma : I \rightarrow X$ a path connecting points x_0 and x_1 . This path associates to $f : (I^n, \partial I^n) \rightarrow (X, x_1)$ a map $\gamma \cdot f : (I^n, \partial I^n) \rightarrow (X, x_0)$ by shrinking the domain of f to a smaller concentric cube in I^n and inserting the path γ on each radial segment in the shell between ∂I^n and the smaller cube.

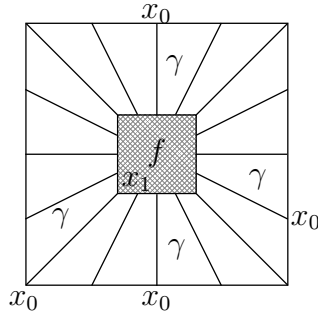

FIGURE 10.3. The action of γ on f

It is not difficult to prove that this assignment has the following properties:

- (1) $\gamma \cdot (f + g) \sim \gamma \cdot f + \gamma \cdot g$ for $f, g : (I^n, \partial I^n) \rightarrow (X, x_1)$,
- (2) $(\gamma + \kappa) \cdot f \sim \gamma \cdot (\kappa \cdot f)$ for $f : (I^n, \partial I^n) \rightarrow (X, x_2)$, $\gamma(0) = x_0$, $\gamma(1) = x_1 = \kappa(0)$, $\kappa(1) = x_2$.
- (3) If $\gamma_1, \gamma_2 : I \rightarrow X$ are homotopic rel $\partial I = \{0, 1\}$, then $\gamma_1 \cdot f \sim \gamma_2 \cdot f$.

Hence, every path γ defines an isomorphism

$$\gamma : \pi_n(X, \gamma(1)) \rightarrow \pi_n(X, \gamma(0)).$$

Particularly, we have a left *action of the group* $\pi_1(X, x_0)$ on $\pi_n(X, x_0)$.

10.5. Fibrations. Fibration is a dual notion to cofibration. (See 1.7.) It plays an important role in homotopy theory.

A map $p : E \rightarrow B$ has the *homotopy lifting property*, shortly HLP, with respect to a pair (X, A) if the following commutative diagram can be completed by a map $X \times I \rightarrow E$

$$\begin{array}{ccc} X \times \{0\} \cup A \times I & \longrightarrow & E \\ \downarrow i & \nearrow \text{dashed} & \downarrow p \\ X \times I & \longrightarrow & B \end{array}$$

A map $p : E \rightarrow B$ is called a *fibration* (sometimes also Serre fibration or weak fibration), if it has the homotopy lifting property with respect to all disks (D^k, \emptyset) .

Theorem. *If $p : E \rightarrow B$ is a fibration, then it has homotopy lifting property with respect to all pairs of CW-complexes (X, A) .*

Proof. The proof can be carried out by induction from $(k-1)$ -skeleton to k -skeleton similarly as in the proof of Theorem 2.7 if we show that $p : E \rightarrow B$ has the homotopy lifting property with respect to the pair $(D^k, \partial D^k = S^{k-1})$. The HLP for this pair

follows from the fact that the pair $(D^k \times I, D^k \times \{0\} \cup S^{k-1} \times I)$ is homeomorphic to the pair $(D^k \times I, D^k \times \{0\})$, see the picture below, and the fact that p has homotopy lifting property with respect to the pair (D^k, \emptyset) .

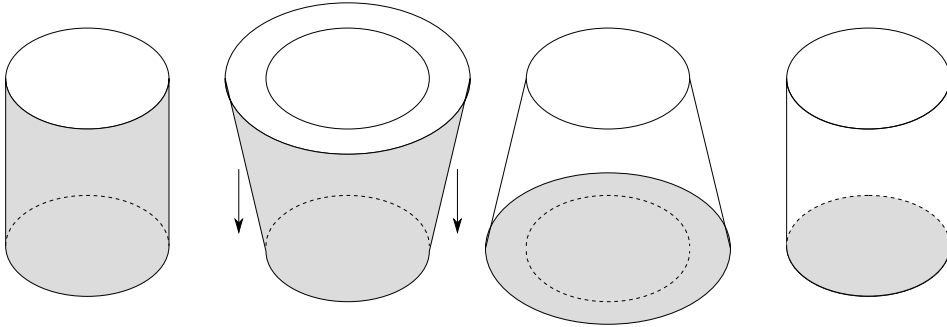

FIGURE 10.4. Homeomorphism $(D^n \times I, D^n \times \{0\} \cup S^{n-1} \times I) \rightarrow (D^n \times I, D^n \times \{0\})$

□

Proposition. *Every fibre bundle (E, B, p) is a fibration.*

Proof. For the definition of a fibre bundle see 8.1. Let U_α be an open covering of B with trivializations $h_\alpha : p^{-1}(U_\alpha) \rightarrow U_\alpha \times F$. We would like to define a lift of a homotopy $G : I^k \times I \rightarrow B$. (We have replaced D^k by I^k .) The compactness of $I^k \times I$ implies the existence of a division

$$0 = t_0 < t_1 < \cdots < t_m = 1, \quad I_j = [t_{j-1}, t_j],$$

such that $G(I_{j_1} \times \cdots \times I_{j_{k+1}})$ lies in some U_α . Now we make a lift $H : I^k \times I \rightarrow E$ of G , first on $(I_1)^{k+1}$ and then we add successively the other small cubes. We need retractions r of cubes $C \times I_{j_{k+1}} = \prod_{i=1}^{k+1} I_{j_i}$ to a suitable part of the boundary $C \times \{0\} \cup A \times I_{j_{k+1}}$ where H is already defined. A is a CW-subcomplex of the cube C and we are in the following situation

$$\begin{array}{ccc} C \times \{0\} \cup A \times I & \xrightarrow{g} & U_\alpha \times F \\ i \downarrow & \nearrow H & \downarrow p_1 \\ C \times I & \xrightarrow{G} & U_\alpha \end{array}$$

Now, we can define

$$H(x, t) = (G(x, t), p_2 \circ g \circ r)(x, t)$$

where $p_2 : U_\alpha \times F \rightarrow F$ is a projection. □

Example. Here you are several examples of fibre bundles.

- (1) The projection $p : S^n \rightarrow \mathbb{R}P^n$ determines a fibre bundle with the fibre S^0 .
- (2) The projection $p : S^{2n+1} \rightarrow \mathbb{C}P^n$ determines a fibre bundle with the fibre S^1 .
- (3) The special case is so called Hopf fibration

$$S^1 \rightarrow S^3 \rightarrow \mathbb{C}P^1 = S^2.$$

(4) Similarly, as complex projective space we can define quaternionic projective space $\mathbb{H}\mathbb{P}^n$. The definition determines the fibre bundle

$$S^3 \rightarrow S^{4n+3} \rightarrow \mathbb{H}\mathbb{P}^n.$$

(5) The special case of the previous fibre bundle is the second Hopf fibration

$$S^3 \rightarrow S^7 \rightarrow \mathbb{H}\mathbb{P}^1 = S^4.$$

(6) Similarly, the Cayley numbers enable to define another Hopf fibration

$$S^7 \rightarrow S^{15} \rightarrow S^8.$$

(7) Let H be a Lie subgroup of G . Then we get a fibre bundle given by the projection $p : G \rightarrow G/H$ with the fibre H .

(8) Let $n \geq k > l \geq 1$. Then the projection

$$p : V_{n,k} \rightarrow V_{n,l}, \quad p(v_1, v_2, \dots, v_k) = (v_1, v_2, \dots, v_l)$$

determines a fibre bundle with the fibre $V_{n-l, k-l}$.

(9) Natural projection $p : V_{n,k} \rightarrow G_{n,k}$ is a fibre bundle with the fibre $O(k)$.

10.6. Long exact sequence of a fibration. Consider a fibration $p : E \rightarrow B$. Take a basepoint $b_0 \in B$, put $F = p^{-1}(b_0)$ and choose $x_0 \in F$.

Lemma. For all $n \geq 1$

$$p_* : \pi_n(E, F, x_0) \rightarrow \pi_n(B, b_0)$$

is an isomorphism.

Proof. First, we show that p_* is an epimorphism. Consider $f : (I^n, \partial I^n) \rightarrow (B, b_0)$. Let $k : J^{n-1} \rightarrow E$ be the constant map into x_0 . Since p is a fibration the commutative diagram

$$\begin{array}{ccc} J^{n-1} = I^{n-1} \times \{1\} \cup \partial I^{n-1} \times I & \xrightarrow{k} & E \\ \downarrow & \nearrow g & \downarrow p \\ I^{n-1} \times I & \xrightarrow{f} & B \end{array}$$

can be completed by $g : (I^n, \partial I^n, J^{n-1}) \rightarrow (E, F, x_0)$. Hence $p_*[g] = [f]$.

Now we prove that p_* is a monomorphism. Consider $f : (I^n, \partial I^n, J^{n-1}) \rightarrow (E, F, x_0)$ such that $p_*[f] = 0$. Then there is a homotopy $G : (I^n \times I, \partial I^n \times I) \rightarrow (B, b_0)$ between pf and the constant map into b_0 . Denote the constant map into x_0 by k . Since p is a fibration, we complete the following commutative diagram:

$$\begin{array}{ccc} J^{n-1} \times I \cup I^n \times \{0\} \cup I^n \times \{1\} & \xrightarrow{k \cup f \cup k} & E \\ \downarrow & \nearrow H & \downarrow p \\ I^n \times I & \xrightarrow{G} & B \end{array}$$

by $H : (I^n \times I, \partial I^n \times I, J^{n-1} \times I) \rightarrow (E, B, x_0)$ which is a homotopy between f and the constant map k . \square

The notion of exact sequence can be enlarged to groups and also to the category \mathbf{Set}_* of sets with distinguished elements. Here we have to define $\text{Ker } f = f^{-1}(b_0)$ for $f : (A, a_0) \rightarrow (B, b_0)$.

Theorem. *If $p : E \rightarrow B$ be a fibration with a fibre $F = p^{-1}(b_0)$, $x_0 \in F$ and B is path connected, then the sequence*

$$\begin{aligned} \cdots \rightarrow \pi_n(F, x_0) \xrightarrow{i_*} \pi_n(E, x_0) \xrightarrow{p_*} \pi_n(B, b_0) \xrightarrow{\delta} \pi_{n-1}(F, x_0) \rightarrow \cdots \\ \cdots \rightarrow \pi_0(F) \xrightarrow{i_*} \pi_0(E) \xrightarrow{p_*} \pi_0(B). \end{aligned}$$

is exact.

Proof. Substitute the isomorphism $p_* : \pi_n(E, F, x_0) \rightarrow \pi_n(B, b_0)$ into the exact sequence for the pair (E, F) . In this way we get the required exact sequence ending with

$$\cdots \rightarrow \pi_0(F, x_0) \rightarrow \pi_0(E, x_0).$$

We can prolong it by one term to the right. The exactness in $\pi_0(E, x_0)$ follows from the fact that every path in B ending in b_0 can be lifted to a path in E ending in F . \square

The direct definition of $\delta : \pi_n(B, b_0) \rightarrow \pi_{n-1}(F, x_0)$ is given by

$$\delta[f] = [g/I^{n-1}]$$

where g is the lift in the diagram

$$\begin{array}{ccc} J^{n-1} & \xrightarrow{x_0} & E \\ \downarrow & \nearrow g & \downarrow p \\ I^n & \xrightarrow{f} & B \end{array}$$

Some applications of this long exact sequence to computations of homotopy groups will be given in Section 14.

11. FUNDAMENTAL GROUP

The *fundamental group* of a space is the first homotopy group. In this section we describe two basic methods how to compute it.

11.1. Covering space. A *covering space* of a space X is a space \tilde{X} together with a map $p : \tilde{X} \rightarrow X$ such that (\tilde{X}, X, p) is a fibre bundle with a discrete fibre.

In the previous section we have proved that every fibre bundle has homotopy lifting property with respect to CW-complexes. In the case of covering spaces the lifts of homotopies are unique:

Proposition. *Let $p : \tilde{X} \rightarrow X$ be a covering space and let Y be a space. Given a homotopy $F : Y \times I \rightarrow X$ and a map $\tilde{f} : Y \times \{0\} \rightarrow \tilde{X}$ such that $F(-, 0) = p\tilde{f}$, there is a unique homotopy $\tilde{F} : Y \times I \rightarrow \tilde{X}$ making the following diagram commutative:*

$$\begin{array}{ccc} Y \times \{0\} & \xrightarrow{\tilde{f}} & \tilde{X} \\ \downarrow & \nearrow \tilde{F} & \downarrow p \\ Y \times I & \xrightarrow{F} & X \end{array}$$

Proof. Since the proof follows the same lines as the proof of the analogous proposition in 10.5, we outline only the main steps.

- (1) Using compactness of I we show that for each $y \in Y$ there is a neighbourhood U such that \tilde{F} can be defined on $U \times I$.
- (2) \tilde{F} is uniquely determined on $\{y\} \times I$ for each $y \in Y$.
- (3) The lifts of F defined on $U_1 \times I$ and $U_2 \times I$ coincide on $(U_1 \cap U_2) \times I$.

□

From the uniqueness of lifts of loops and their homotopies starting at a fixed point we get immediately the following

Corollary. *The group homomorphism $p_* : \pi_1(\tilde{X}, \tilde{x}_0) \rightarrow \pi_1(X, x_0)$ induced by a covering space (\tilde{X}, X, p) is injective. The image subgroup $p_*(\pi_1(\tilde{X}, \tilde{x}_0))$ in $\pi_1(X, x_0)$ consists of loops in X based at x_0 whose lifts in \tilde{X} starting at \tilde{x}_0 are loops.*

11.2. Group actions. A *left action* of a discrete group G on a space Y is a map

$$G \times Y \rightarrow Y, \quad (g, y) \mapsto g \cdot y$$

such that $1 \cdot y = y$ and $(g_1 g_2) \cdot y = g_1 \cdot (g_2 \cdot y)$. We will call this action *properly discontinuous* if each point $y \in Y$ has an open neighbourhood U such that $g_1 U \cap g_2 U \neq \emptyset$ implies $g_1 = g_2$.

An action of a group G on a space Y induces the equivalence $x \sim y$ if $y = g \cdot x$ for some $g \in G$. The *orbit space* Y/G is the factor space Y/\sim .

A space Y is called *simply connected* if it is path connected and $\pi_1(Y, y_0)$ is trivial for some (and hence all) base point y_0 .

The following theorem provides a useful method for computation of fundamental groups.

Theorem. *Let Y be a path connected space with a properly discontinuous action of a group G . Then*

- (1) *The natural projection $p : Y \rightarrow Y/G$ is a covering space.*
- (2) *$G \cong \pi_1(Y/G, p(y_0))/p_*\pi_1(Y, y_0)$. Particularly, if Y is simply connected, then $\pi_1(Y/G) \cong G$.*

Proof. Let $y \in Y$ and let U be a neighbourhood of y from the definition of properly discontinuous action. Then $p^{-1}(p(U))$ is a disjoint union of gU , $g \in G$. Hence $(Y, Y/G, p)$ is a fibre bundle with the fibre G .

Applying the long exact sequence of homotopy groups of this fibration we obtain

$$0 = \pi_1(G, 1) \rightarrow \pi_1(Y, y_0) \xrightarrow{p_*} \pi_1(Y/G; p(y_0)) \xrightarrow{\delta} \pi_0(G) = G \rightarrow \pi_0(Y) = 0.$$

In general π_0 of a fibre is only the set with distinguished point. However, here it has the group structure given by G . Using the definition of δ from 10.3 one can check that δ is a group homomorphism. Consequently, the exact sequence implies that

$$G \cong \pi_1(Y/G, p(y_0))/p_*\pi_1(Y, y_0).$$

□

Example A. \mathbb{Z} acts on real numbers \mathbb{R} by addition. The orbit space is $\mathbb{R}/\mathbb{Z} = S^1$. According to the previous theorem

$$\pi_1(S^1, s) = \mathbb{Z}.$$

The fundamental group of the sphere S^n with $n \geq 2$ is trivial. The reason is that any loop $\gamma : S^1 \rightarrow S^n$ is homotopic to a loop which is not a map onto S^n and S^n without a point is contractible.

Next, the group $\mathbb{Z}_2 = \{1, -1\}$ has an action on S^n , $n \geq 2$ given by $(-1) \cdot x = -x$. Hence

$$\pi_1(\mathbb{R}P^n) = \mathbb{Z}_2.$$

Example B. The abelian group $\mathbb{Z} \oplus \mathbb{Z}$ acts on \mathbb{R}^2

$$(m, n) \cdot (x, y) = (x + m, y + n).$$

The factor $\mathbb{R}^2/(\mathbb{Z} \oplus \mathbb{Z})$ is two dimensional torus $S^1 \times S^1$. Its fundamental group is $\mathbb{Z} \oplus \mathbb{Z}$.

Example C. The group G given by two generators α, β and the relation $\beta^{-1}\alpha\beta = \alpha^{-1}$ acts on \mathbb{R}^2 by

$$\alpha \cdot (x, y) = (x + 1, y), \quad \beta \cdot (x, y) = (1 - x, y + 1).$$

The factor \mathbb{R}^2/G is the Klein bottle. Hence its fundamental group is G .

11.3. Free product of groups. As a set the *free product* $*_{\alpha}G_{\alpha}$ of groups G_{α} , $\alpha \in I$ is the set of finite sequences $g_1g_2 \dots g_m$ such that $1 \neq g_i \in G_{\alpha_i}$, $\alpha_i \neq \alpha_{i+1}$, called words. The elements g_i are called letters. The group operation is given by

$$(g_1g_2 \dots g_m) \cdot (h_1h_2 \dots h_n) = (g_1g_2 \dots g_mh_1h_2 \dots h_n)$$

where we take g_mh_1 as a single letter $g_m \cdot h_1$ if both elements belong to the same group G_{α} . It is easy to show that $*_{\alpha}G_{\alpha}$ is a group with the empty word as the identity element. Moreover, for each $\beta \in I$ there is the natural inclusion $i_{\beta} : G_{\beta} \hookrightarrow *_{\alpha}G_{\alpha}$.

Up to isomorphism the free product of groups is characterized by the following universal property: Having a system of group homomorphism $h_{\alpha} : G_{\alpha} \rightarrow G$ there is just one group homomorphism $h : *_{\alpha}G_{\alpha} \rightarrow G$ such that $h_{\alpha} = hi_{\alpha}$.

Exercise. Describe $\mathbb{Z}_2 * \mathbb{Z}_2$.

11.4. Van Kampen Theorem. Suppose that a space X is a union of path connected open subsets U_{α} each of which contains a base point $x_0 \in X$. The inclusions $U_{\alpha} \hookrightarrow X$ induce homomorphisms $j_{\alpha} : \pi_1(U_{\alpha}) \rightarrow \pi_1(X)$ which determine a unique homomorphism $\varphi : *_{\alpha}\pi_1(U_{\alpha}) \rightarrow \pi_1(X)$.

Next, the inclusions $U_{\alpha} \cap U_{\beta} \hookrightarrow U_{\alpha}$ induce the homomorphisms $i_{\alpha\beta} : \pi_1(U_{\alpha} \cap U_{\beta}) \rightarrow \pi_1(U_{\alpha})$. We have $j_{\alpha}i_{\alpha\beta} = j_{\beta}i_{\beta\alpha}$. Consequently, the kernel of φ contains elements of the form $i_{\alpha\beta}(\omega)i_{\beta\alpha}(\omega^{-1})$ for any $\omega \in \pi_1(U_{\alpha} \cap U_{\beta})$.

Van Kampen Theorem provides the full description of the homomorphism φ which enables us to compute $\pi_1(X)$ using groups $\pi_1(U_{\alpha})$ and $\pi_1(U_{\alpha} \cap U_{\beta})$.

Theorem (Van Kampen Theorem). *If X is a union of path connected open sets U_{α} each containing a base point $x_0 \in X$ and if each intersection $U_{\alpha} \cap U_{\beta}$ is path connected, then the homomorphism $\varphi : *_{\alpha}\pi_1(U_{\alpha}) \rightarrow \pi_1(X)$ is surjective. If in addition each intersection $U_{\alpha} \cap U_{\beta} \cap U_{\gamma}$ is path connected, then the kernel of φ is the normal subgroup N in $*_{\alpha}\pi_1(U_{\alpha})$ generated by elements $i_{\alpha\beta}(\omega)i_{\beta\alpha}(\omega^{-1})$ for any $\omega \in \pi_1(U_{\alpha} \cap U_{\beta})$. So φ induces an isomorphism*

$$\pi_1(X) \cong *_{\alpha}\pi_1(U_{\alpha})/N.$$

Example. If X_{α} are path connected spaces, then

$$\pi_1(\bigvee X_{\alpha}) = *_{\alpha}\pi_1(X_{\alpha}).$$

Outline of the proof of Van Kampen Theorem. For simplicity we suppose that X is a union of only two open subsets U_1 and U_2 .

Surjectivity of φ . Let $f : I \rightarrow X$ be a loop starting at $x_0 \in U_1 \cup U_2$. This loop is up to homotopy a composition of several paths, for simplicity suppose there are three such that $f_1 : I \rightarrow U_1$, $f_2 : I \rightarrow U_2$ and $f_3 : I \rightarrow U_1$ with end points successively $x_0, x_1, x_2, x_0 \in U_1 \cap U_2$. Since $U_1 \cap U_2$ is path connected there are paths $g_1 : I \rightarrow U_1 \cap U_2$ and $g_2 : I \rightarrow U_1 \cap U_2$ from x_0 to x_1 and x_2 , respectively. Then the loop f is up to homotopy the composition of loops $f_1 - g_1 : I \rightarrow U_1$, $g_1 + f_2 - g_2 : I \rightarrow U_2$ and $g_2 + f_3 : I \rightarrow U_1$. Consequently, $[f] \in \pi_1(X)$ lies in the image of φ .

Kernel of φ . Suppose that the image under φ of a word with m letters $[f_1][g_1][f_2] \dots$, where $[f_i] \in \pi_1(U_1)$, $[g_i] \in \pi_1(U_2)$, is zero in $\pi_1(X)$. Then there is a homotopy

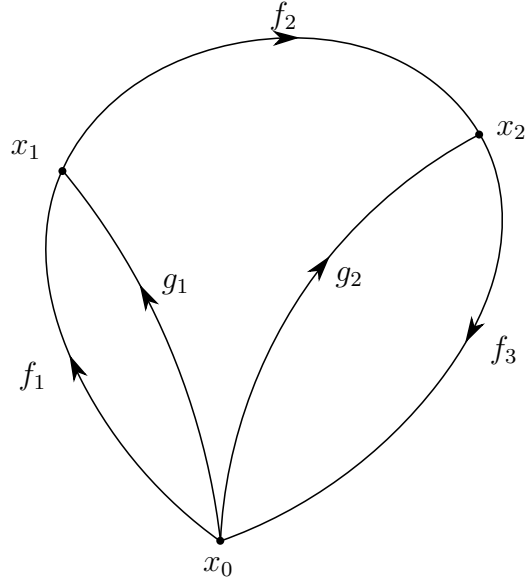

FIGURE 11.1. $[f] = [f_1 + f_2 + f_3] = [f_1 - g_1] + [g_1 + f_2 - g_2] + [g_2 + f_3]$

$F : I \times I \rightarrow X$ such that

$$F(s, 0) = f_1 + g_1 + f_2 + \dots, \quad F(s, 1) = x_0, \quad F(0, t) = F(1, t) = x_0$$

where we suppose that f_i is defined on $[\frac{2i-2}{m}, \frac{2i-1}{m}]$ and g_i is defined on $[\frac{2i-1}{m}, \frac{2i}{m}]$. Since $I \times I$ is compact, there is an integer n , a multiple of m , such that

$$F \left(\left[\frac{i}{n}, \frac{i+1}{n} \right] \times \left[\frac{j}{n}, \frac{j+1}{n} \right] \right)$$

is a subset in U_1 or U_2 . Using homotopy extension property, we can construct a homotopy from F to \tilde{F} rel J^1 such that again

$$\tilde{F} \left(\left[\frac{i}{n}, \frac{i+1}{n} \right] \times \left[\frac{j}{n}, \frac{j+1}{n} \right] \right)$$

is a subset in U_1 or U_2 , and moreover,

$$\tilde{F} \left(\frac{i}{n}, \frac{j}{n} \right) = x_0.$$

Further, $\tilde{F}(s, 0) = f'_1 + g'_1 + f'_2 + \dots$ where $f'_i \sim f_i$, $g'_i \sim g_i$ in U_1 and U_2 , respectively, rel the boundary of the domain of definition. We want to show that the word $[f'_1]_1 [g'_1]_2 [f'_2]_1 \dots$ belongs to N . Here $[\]_i$ stands for an element in $\pi_1(U_i)$.

We can decompose

$$I \times I = \bigcup_i M_i$$

where M_i is a maximal subset with the properties:

- (1) M_i is a union of several squares $[\frac{i}{n}, \frac{i+1}{n}] \times [\frac{j}{n}, \frac{j+1}{n}]$.
- (2) $\text{int } M_i$ is path connected.
- (3) $\tilde{F}(M_i)$ is a subset in U_1 or U_2 .

For simplicity suppose that we have four sets M_i as indicated in the picture.

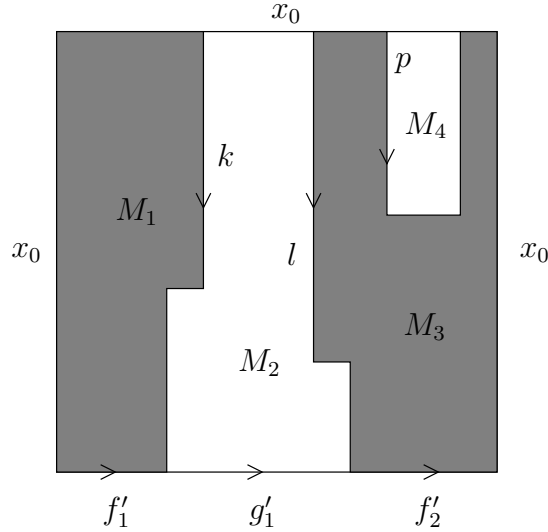

FIGURE 11.2. $[f'_1]_1[g'_1]_2[f'_2]_1 \in \text{Ker}\varphi$

In this situation there are three loops k , l and p starting at x_0 and lying in $U_1 \cap U_2$. They are defined by \tilde{F} on common boundary of M_1 and M_2 , M_2 and M_3 , M_3 and M_4 , respectively. Now, we get

$$\begin{aligned} [f'_1]_1[g'_1]_2[f'_2]_1 &= [k]_1[-k+l]_2[-l+p]_1 = [k]_1[-k]_2[l]_2[-l]_1[p]_1 \\ &= [k]_1[-k]_2[l]_2[-l]_1 \in N. \end{aligned}$$

□

Corollary. Let X be a union of two open subsets U and V where V is simply connected and $U \cap V$ is path connected. Then

$$\pi_1(X) = \pi_1(U)/N$$

where N is the normal subgroup in $\pi_1(U)$ generated by the image of $\pi_1(U \cap V)$.

Exercise. Use the previous statement to compute the fundamental group of the Klein bottle and other 2-dimensional closed surfaces.

11.5. Fundamental group and homology. Here we compare the fundamental group of a space with the first homology group. We obtain a special case of Hurewicz theorem, see 13.6.

Theorem. By regarding loops as 1-cycles, we obtain a homomorphism $h : \pi_1(X, x_0) \rightarrow H_1(X)$. If X is path connected, then h is surjective and its kernel is the commutator subgroup of $\pi_1(X)$. So h induces isomorphism from the abelization of $\pi_1(X, x_0)$ to $H_1(X)$.

For the proof we refer to [Hatcher], Theorem 2A.1, pages 166–167.

12. HOMOTOPY AND CW-COMPLEXES

This section demonstrates the importance of CW-complexes in homotopy theory. The main results derived here are Whitehead theorem and theorems on approximation of maps by cellular maps and spaces by CW-complexes.

12.1. n -connectivity. A space X is n -connected if $\pi_i(X, x_0) = 0$ for all $0 \leq i \leq n$ and some base point $x_0 \in X$ (and consequently, for all base points).

A pair (X, A) is called n -connected if each component of path connectivity of X contains a point from A and $\pi_i(X, A, x_0) = 0$ for all $x_0 \in A$ and all $1 \leq i \leq n$.

We say that a map $f : X \rightarrow Y$ is an n -equivalence if $f_* : \pi_i(X, x_0) \rightarrow \pi_i(Y, f(x_0))$ is an isomorphism for all $x_0 \in X$ if $0 \leq i < n$ and an epimorphism for all x_0 if $i = n$.

Exercise. Prove that a pair (X, A) is n -connected if and only if the inclusion $i : A \hookrightarrow X$ is an n -equivalence.

12.2. Compression lemma is an important technical tool in what follows.

Lemma A (Compression lemma). *Let (X, A) be a pair of CW-complexes and (Y, B) a pair with $B \neq \emptyset$. Suppose that $\pi_n(Y, B, y_0) = 0$ for all $y_0 \in B$ whenever there is a cell in $X - A$ of dimension n . Then every $f : (X, A) \rightarrow (Y, B)$ is homotopic rel A with a map $g : X \rightarrow B$.*

$$\begin{array}{ccc} A & \xrightarrow{f/A} & B \\ \downarrow & \nearrow g & \downarrow \\ X & \xrightarrow{f} & Y \end{array} \quad \sim$$

If $n = 0$, the condition $\pi_0(Y, B, y_0) = 0$ means that (Y, B) is 0-connected.

Proof. By induction we will define maps $f_n : X \rightarrow Y$ such that $f_n(X^n \cup A) \subseteq B$, and f_n is homotopic to f_{n-1} rel $A \cup X^{n-1}$. Put $f_{-1} = f$. Suppose that we have f_{n-1} and there is a cell e^n in $X - A$. Let $\varphi : D^n \rightarrow X$ be its characteristic map. Then $f_{n-1}\varphi : (D^n, \partial D^n) \rightarrow (Y, B)$ represents zero element in $\pi_n(Y, B)$. According to Proposition 10.2 it means that $f_{n-1}\varphi : (D^n, \partial D^n) \rightarrow (Y, B)$ is homotopic rel ∂D^n to a map $h_n : (D^n, \partial D^n) \rightarrow (B, B)$. Doing it for all cells of dimension n in $X - A$ we obtain a map $g_n : X^n \cup A \rightarrow B$ homotopic rel $A \cup X^{n-1}$ with f_{n-1} restricted to $X^n \cup A$. Using the homotopy extension property of the pair $(X, X^n \cup A)$ we can conclude that g_n can be extended to a map $f_n : X \rightarrow Y$ which is homotopic rel $A \cup X^{n-1}$ to f_{n-1} . Now for $x \in X^n$ define $g(x) = f_n(x) = g_n(x)$. By the same trick as in the proof of Theorem 2.7 we can construct a homotopy rel A between f and g . \square

The proof of the following extension lemma is similar but easier and hence left to the reader.

Lemma B (Extension lemma). *Consider a pair (X, A) of CW-complexes and a map $f : A \rightarrow Y$. If Y is path connected and $\pi_{n-1}(Y, y_0) = 0$ whenever there is a cell in $X - A$ of dimension n , then f can be extended to a map $X \rightarrow Y$.*

12.3. Whitehead Theorem. The compression lemma has two important consequences.

Corollary. Let $h : Z \rightarrow Y$ be an n -equivalence and let X be a finite dimensional CW-complex. Then the induced map $h_* : [X, Z] \rightarrow [X, Y]$ is

- (1) a surjection if $\dim X \leq n$,
- (2) a bijection if $\dim X \leq n - 1$.

Proof. First, we will suppose that $h : Z \rightarrow Y$ is an inclusion and apply the compression lemma. Put $B = Z$, $A = \emptyset$ and consider a map $f : X \rightarrow Y$. If $\dim X \leq n$ then all the assumptions of the compression lemma are satisfied. Consequently, there is a map $g : X \rightarrow Z$ such that $hg \sim f$. Hence $h_* : [X, Z] \rightarrow [X, Y]$ is surjection.

Let $\dim X \leq n - 1$ and let $g_1, g_2 : X \rightarrow Z$ be two maps such that $hg_1 \sim hg_2$ via a homotopy $F : X \times I \rightarrow Y$. Then we can apply the compression lemma in the situation of the diagram

$$\begin{array}{ccc} X \times \{0, 1\} & \xrightarrow{g_1 \cup g_2} & Z \\ \downarrow & \nearrow H & \downarrow h \\ X \times I & \xrightarrow{F} & Y \end{array}$$

to get a homotopy $H : X \times I \rightarrow Z$ between g_1 and g_2 .

If h is not an inclusion, we use the mapping cylinder M_h . (See 1.5 for the definition and basic properties.) Let $f : X \rightarrow Y$ be a map. Apply the result of the previous part of the proof to the inclusion $i_Z : Z \hookrightarrow M_h$ and to the map $i_Y f : X \rightarrow Y \hookrightarrow M_h$ to get $g : X \rightarrow Z$ such that $i_Z g \sim i_Y f$.

$$\begin{array}{ccccc} & & Z & & \\ & \nearrow g & \downarrow i_Z & \searrow h & \\ X & \xrightarrow{f} & Y & \xrightarrow{i_Y} & M_h & \xrightarrow{p} & Y \end{array}$$

Since the right triangle in the diagram commutes and the middle one commutes up to homotopy and $pi_Y = id_Y$, we get

$$hg = pi_Z g \sim pi_Y f = f.$$

The statement (2) can be proved in a similar way. □

A map $f : X \rightarrow Y$ is called a *weak homotopy equivalence* if $f_* : \pi_n(X, x_0) \rightarrow \pi_n(Y, f(x_0))$ is an isomorphism for all n and all base points x_0 .

Theorem (Whitehead Theorem). If a map $h : Z \rightarrow Y$ between two CW-complexes is a weak homotopy equivalence, then h is a homotopy equivalence.

Moreover, if Z is a subcomplex of Y and h is an inclusion, then Z is even deformation retract of Y .

Proof. Let h be an inclusion. We apply the compression lemma in the following situation:

$$\begin{array}{ccc} Z & \xrightarrow{\text{id}_Z} & Z \\ h \downarrow & \nearrow g & \downarrow h \\ Y & \xrightarrow{\text{id}_Y} & Y \end{array}$$

Then $gh \sim \text{id}_Y \text{ rel } Z$ and consequently $hg = \text{id}_Z$. So Z is a deformation retract of Y . The proof in a general case again uses mapping cylinder M_h . \square

12.4. Simplicial approximation lemma. The following rather technical statement will play an important role in proofs of approximation theorems in this section and in the proof of homotopy excision theorem in the next section. Under convex polyhedron we mean an intersection of finite number of halfspaces in \mathbb{R}^n with nonempty interior.

Lemma (Simplicial approximation lemma). *Consider a map $f : I^n \rightarrow Z$. Let Z be a space obtained from a space W by attaching a cell e^k . Then f is rel $f^{-1}(W)$ homotopic to f_1 for which there is a simplex $\Delta^k \subset e^k$ with $f_1^{-1}(\Delta^k)$ a union (possibly empty) of finitely many convex polyhedra such that f_1 is the restriction of a linear surjection $\mathbb{R}^n \rightarrow \mathbb{R}^k$ on each of them.*

The proof is elementary but rather technical and we omit it. See [Hatcher], Lemma 4.10, pages 350–351.

12.5. Cellular approximation. We recall that a map $g : X \rightarrow Y$ between two CW-complexes is called cellular, if $g(X^n) \subseteq Y^n$ for all n .

Theorem (Cellular approximation theorem). *If $f : X \rightarrow Y$ is a map between CW-complexes, then it is homotopic to a cellular map. If f is already cellular on a subcomplex A , then f is homotopic to a cellular map rel A .*

Corollary A. $\pi_k(S^n) = 0$ for $k < n$.

Corollary B. *Let (X, A) be a pair of CW-complexes such that $X - A$ contains only cells of dimension greater than n . Then (X, A) is n -connected.*

Proof of the cellular approximation theorem. By induction we will construct maps $f_n : X \rightarrow Y$ such that $f_{-1} = f$, f_n is cellular on X^n and $f_n \sim f_{n-1} \text{ rel } X^{n-1} \cup A$. Then we can define $g(x) = f_n(x)$ for $x \in X^n$ and by the same trick as in the proof of Theorem 2.7 we can construct homotopy rel A between f and g .

Suppose we have already f_{n-1} and there is a cell e^n such that $f_{n-1}(e^n)$ does not lie in Y^n . Then $f(e^n)$ meets a cell e^k in Y of dimension $k > n$. According to the simplicial approximation lemma f_{n-1} restricted to \bar{e}^n is homotopic rel ∂e^n to $h : \bar{e}^n \rightarrow Y$ with the property that there is a simplex $\Delta^k \subset e^k$ and $h(e^n) \subset Y - \Delta^k$. (Since $n < k$, there is no linear surjection $\mathbb{R}^n \rightarrow \mathbb{R}^k$.) ∂e^k is a deformation retract of $\bar{e}^k - \Delta^k$ and that is why h is homotopic rel ∂e^n to a map $g : \bar{e}^n \rightarrow Y - e^k$. Since $f(e^n)$ meets only a finite number of cells, repeating the previous step we get a map f_n defined on \bar{e}^n

such that $f_n(e^n) \subseteq Y^n$ and homotopic rel ∂e^n to f_{n-1}/\bar{e}^n . In the same way we can define f_n on $A \cup X^n$ homotopic to $f_{n-1}/A \cup X^n$ rel $A \cup X^{n-1}$. Then using homotopy extension property for the pair $(X, A \cup X^n)$ we obtain $f_n : X \rightarrow Y$ homotopic to f_{n-1} rel $A \cup X^{n-1}$. \square

12.6. Approximation by CW-complexes. Consider a pair (X, A) where A is a CW-complex. An n -connected CW model for (X, A) is an n -connected pair of CW-complexes (Z, A) together with a map $f : Z \rightarrow X$ such that $f/A = \text{id}_A$ and $f_* : \pi_i(Z, z_0) \rightarrow \pi_i(X, f(z_0))$ is an isomorphism for $i > n$ and a monomorphism for $i = n$ and all base points $z_0 \in Z$.

If we take A a set containing one point from every path component of X , then 0-connected CW model gives a CW-complex Z and a map $Z \rightarrow X$ which is a weak homotopy equivalence.

Theorem A (CW approximation theorem). *For every $n \geq 0$ and for every pair (X, A) where A is a CW-complex there exists n -connected CW-model (Z, A) with the additional property that Z can be obtained from A by attaching cells of dimensions greater than n .*

Proof. We proceed by induction constructing $Z_n = A \subset Z_{n+1} \subset Z_{n+2} \subset \dots$ with Z_k obtained from Z_{k-1} by attaching cells of dimension k , and a map $f : Z_k \rightarrow X$ such that $f/A = \text{id}_A$ and $f_* : \pi_i(Z_k) \rightarrow \pi_i(X)$ is a monomorphism for $n \leq i < k$ and an epimorphism for $n < i \leq k$. For simplicity we will consider X and A path connected with a fixed base point $x_0 \in A$.

Suppose we have already $f : Z_k \rightarrow X$. Let $\varphi_\alpha : S^k \rightarrow Z_k$ be maps representing generators in the kernel of $f_* : \pi_k(Z_k) \rightarrow \pi_k(X)$. Put

$$Y_{k+1} = Z_k \cup_{\varphi_\alpha} \bigcup_{\alpha} D_\alpha^{k+1}.$$

Since the map $f : Z_k \rightarrow X$ restricted to the boundaries of new cells is trivial, it can be extended to a map $f : Y_{k+1} \rightarrow X$.

By the cellular approximation theorem $\pi_i(Y_{k+1}) = \pi_i(Z_k)$ for all $i \leq k-1$. Hence the new f_* has the same properties as the old f_* on homotopy groups π_i with $i \leq k-1$. Since the composition $\pi_k(Z_k) \rightarrow \pi_k(Y_{k+1}) \rightarrow \pi_k(X)$ is surjective according to the induction assumptions, the homomorphism $f_* : \pi_k(Y_{k+1}) \rightarrow \pi_k(X)$ has to be surjective as well.

Now we prove that it is injective. Let $[\varphi] \in \pi_k(Y_{k+1})$ and let $f\varphi \sim 0$. By cellular approximation $\varphi : S^k \rightarrow Y_{k+1}$ is homotopic to $\tilde{\varphi} : S^k \rightarrow Y_{k+1}^k = Z_k \subseteq Y_{k+1}$ and $[f\tilde{\varphi}] = 0$ in $\pi_k(X)$. Hence $[\tilde{\varphi}] \in \text{Ker } f_*$ is a sum of $[\varphi_\alpha]$, and consequently, it is zero in $\pi_k(Y_{k+1})$.

Next, let maps $\psi_\alpha : S_\alpha^{k+1} \rightarrow X$ represent generators of $\pi_{k+1}(X)$. Put

$$Z_{k+1} = Y_{k+1} \vee \bigvee_{\alpha} S_\alpha^{k+1}$$

and define $f = \psi_\alpha$ on new $(k+1)$ -cells. It is clear that $f_* : \pi_{k+1}(Z_{k+1}) \rightarrow \pi_{k+1}(X)$ is a surjection. Using cellular approximation it can be shown that $\pi_i(Z_{k+1}, Y_{k+1}) =$

0 for $i \leq k$. From the long exact sequence of the pair (Z_{k+1}, Y_{k+1}) we get that $\pi_i(Y_{k+1}) = \pi_i(Z_{k+1})$ for $i \leq k-1$. Consequently, $f_* : \pi_i(Z_{k+1}) \rightarrow \pi_i(X)$ is an isomorphism for $n < i \leq k-1$ and a monomorphism for $i = n$. The same long exact sequence implies that $\pi_k(Y_{k+1}) \rightarrow \pi_k(Z_{k+1})$ is surjective. We have already proved that $f_* : \pi_k(Y_{k+1}) \rightarrow \pi_k(X)$ is an isomorphism. From the diagram

$$\begin{array}{ccc} \pi_k(Y_{k+1}) & \xrightarrow{\text{epi}} & \pi_k(Z_{k+1}) \\ & \searrow \text{iso} & \downarrow f_* \\ & & \pi_k(X) \end{array}$$

we can see that $f_* : \pi_k(Z_{k+1}) \rightarrow \pi_k(X)$ is also an isomorphism. \square

Corollary. *If (X, A) is an n -connected pair of CW-complexes, then there is a pair (Z, A) homotopy equivalent to (X, A) rel A such that the cells in $Z - A$ have dimension greater than n .*

Proof. Let $f : (Z, A) \rightarrow (X, A)$ be an n -connected model for (X, A) obtained by attaching cells of dimension $> n$ to A . Then $f_* : \pi_j(Z) \rightarrow \pi_j(X)$ is a monomorphism for $j = n$ and an isomorphism for $j > n$. We will show that f_* is an isomorphism also for $j \leq n$. Consider the diagram:

$$\begin{array}{ccc} A & & \\ i_Z \downarrow & \searrow i_X & \\ Z & \xrightarrow{f} & X \end{array}$$

The inclusions i_X and i_Z are n -equivalences. Consequently, $f_* i_{Z*} = i_{X*} : \pi_j(A) \rightarrow \pi_j(X)$ is an epimorphism for $j = n$. Hence so is f_* . Next, i_{X*} and i_{Z*} are isomorphisms for $j < n$, hence so is f_* .

Finally, according to Whitehead Theorem, the weak homotopy equivalence f between two CW-complexes is a homotopy equivalence. \square

Theorem B. *Let $f : (Z, A) \rightarrow (X, A)$ and $f' : (Z', A') \rightarrow (X', A')$ be two n -connected CW-models. Given a map $g : (X, A) \rightarrow (X', A')$ there is a map $h : (Z, A) \rightarrow (Z', A')$ such that the following diagram commutes up to homotopy rel A :*

$$\begin{array}{ccc} Z & \xrightarrow{f} & X \\ h \downarrow & & \downarrow g \\ Z' & \xrightarrow{f'} & X' \end{array}$$

The map h is unique up to homotopy rel A .

Proof. By the previous corollary we can suppose that $Z - A$ has only cells of dimension $\geq n + 1$. We can define h/A as g/A .

$$\begin{array}{ccc} A & \xrightarrow{h/A} & Z' \\ \downarrow & & \downarrow f' \\ Z & \xrightarrow{gf} & X' \end{array}$$

Replace X' by the mapping cylinder $M_{f'}$ which is homotopy equivalent to X' . Since $f' : Z' \rightarrow X'$ is an n -connected model, from the long exact sequence of the pair $(M_{f'}, Z')$ we get that $\pi_i(M_{f'}, Z') = 0$ for $i \geq n + 1$. According to compression lemma 12.2 there exists $h : Z \rightarrow Z'$ such that the diagram

$$\begin{array}{ccc} A & \xrightarrow{h/A} & Z' \\ \downarrow & \nearrow h & \downarrow \\ Z & \longrightarrow & M_{f'} \end{array}$$

commutes up to homotopy rel A . This h has required properties. The proof that it is unique up to homotopy follows the same lines. \square

13. HOMOTOPY EXCISION AND HUREWICZ THEOREM

One of the reasons why the computation of homotopy groups is so difficult is the fact that we have no general excision theorem at our disposal. Nevertheless, there is a restricted version of such a theorem. It has many consequences, one of them is the Freudenthal suspension theorem which enables us to compute $\pi_n(S^n)$. At the end of this section we define the Hurewicz homomorphism which under certain conditions compares homotopy and homology groups.

13.1. Homotopy excision theorem. Excision theorem for homology groups has the following restricted analogue for homotopy groups.

Theorem (Blakers-Massey theorem). *Let A and B be subcomplexes of CW-complex $X = A \cup B$. Suppose that $C = A \cap B$ is connected, (A, C) is m -connected and (B, C) is n -connected. Then the inclusion*

$$j : (A, C) \hookrightarrow (X, B)$$

is $(m+n)$ -equivalence, i. e. $j_ : \pi_i(A, C) \rightarrow \pi_i(X, B)$ is an isomorphism for $i < m+n$ and an epimorphism for $i = m+n$.*

Proof. We distinguish several cases.

1. Suppose that $A = C \cup \bigcup_{\alpha} e_{\alpha}^{m+1}$ and $B = C \cup e^{n+1}$. First we prove that $j_* : \pi_i(A, C) \rightarrow \pi_i(X, B)$ is surjective for $i \leq m+n$.

Consider $f : (I^i, \partial I^i, J^{i-1}) \rightarrow (X, B, x_0)$. Using simplicial approximation lemma 12.4 we can suppose that there are simplices $\Delta_{\alpha}^{m+1} \subset e_{\alpha}^{m+1}$ and $\Delta^{n+1} \subset e^{n+1}$ such that their inverse images $f^{-1}(\Delta_{\alpha}^{m+1})$, $f^{-1}(\Delta^{n+1})$ are unions of convex polyhedra on each of which f is a linear surjection \mathbb{R}^i onto \mathbb{R}^{m+1} and \mathbb{R}^{n+1} , respectively. We will need the following statement.

Lemma. *If $i \leq m+n$ then there exist points $p_{\alpha} \in \Delta_{\alpha}^{m+1}$, $q \in \Delta^{n+1}$ and a continuous function $\varphi : I^{i-1} \rightarrow [0, 1)$ such that*

- (a) $f^{-1}(p_{\alpha})$ lies above the graph of φ ,
- (b) $f^{-1}(q)$ lies below the graph of φ ,
- (c) $\varphi = 0$ on ∂I^{i-1} .

Let us postpone the proof of the lemma for a moment. The subspace $M = \{(s, t) \in I^{i-1} \times I; t \geq \varphi(s)\}$ is a deformation retract of I^i with deformation retraction $h : I^i \times I \rightarrow I^i$, $h(x, 0) = x$, $h(x, 1) \in M$. Then

$$H = fh : I^i \times I \rightarrow X$$

provides a homotopy between f and

$$g : (I^i, \partial I^i, J^{i-1}) \rightarrow (X - \{q\}, X - \{q\} - \bigcup \{p_{\alpha}\}, x_0).$$

Obviously, g is homotopic to $\tilde{g} : (I^i, \partial I^i, J^{i-1}) \rightarrow (A, C, x_0)$. Hence $j_*[\tilde{g}] = [f]$.

The fact that $j_* : \pi_i(A, C) \rightarrow \pi_i(X, B)$ is monomorphism for $i \leq m+n-1$ can be proved by the same way as above replacing f by homotopy $h : I^i \times I \rightarrow (X, B)$. (Notice that $i+1 \leq m+n$ now.)

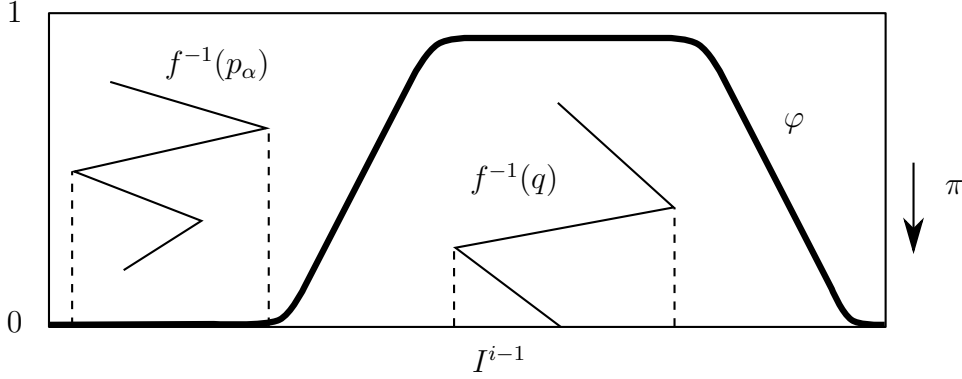
FIGURE 13.1. The graph of φ

Proof of the lemma. Choose arbitrary $q \in \Delta^{n+1}$. Then $f^{-1}(q)$ is a union of convex simplices of dimension $\leq i - n - 1$. Denote $\pi : I^i \rightarrow I^{i-1}$ the projection given by omitting the last coordinate. $\pi^{-1}(\pi(f^{-1}(q)))$ is the union of convex simplices of dimension $\leq i - n$. On the set $\pi^{-1}(\pi(f^{-1}(q))) \cap f^{-1}(\Delta_\alpha^{m+1})$ is f linear, hence

$$f(\pi^{-1}(\pi(f^{-1}(q)))) \cap \Delta_\alpha^{m+1}$$

is the union of simplices of dimension at most $i - n < m + 1$ for $i \leq m + n$. Consequently, there is $p_\alpha \in \Delta_\alpha^{m+1}$ such that

$$f^{-1}(p_\alpha) \cap \pi^{-1}(\pi f^{-1}(q)) = \emptyset.$$

Since $\text{Im } f$ meets only finite number of cells e_α^{m+1} , the set $\bigcup \pi(f^{-1}(p_\alpha))$ is compact and disjoint from $\pi(f^{-1}(q))$. Hence there is continuous function φ , $\varphi = 0$ on $\bigcup \pi(f^{-1}(p_\alpha))$ and $\varphi = 1 - \varepsilon$ on $\pi(f^{-1}(q))$ with required properties.

2. Suppose that A is obtained from C by attaching cells e_α^{m+1} and B is obtained by attaching cells $e_\beta^{n_\beta}$ of dimensions $\geq n + 1$. Consider a map $f : (I^i, \partial I^i, J^{i-1}) \rightarrow (X, B, x_0)$. f meets only finite number of cells $e_\beta^{n_\beta}$. According to the case 1 we can show that f is homotopic to

$$\begin{aligned} f_1 &: (I^i, \partial I^i) \rightarrow (X - e^{n_1}, B - e^{n_1}), \\ f_2 &: (I^i, \partial I^i) \rightarrow (X - e^{n_1} - e^{n_2}, B - e^{n_1} - e^{n_2}), \\ &\dots \\ f_r &: (I^i, \partial I^i) \rightarrow (A, C). \end{aligned}$$

3. Suppose that A is obtained from C by attaching cells of dimensions $\geq m + 1$ and B is obtained by attaching cells of dimensions $\geq n + 1$. We may assume that the dimensions of new cells in A is $\leq m + n + 1$ since higher dimensional ones have no effect on π_i for $i \leq m + n$ by cellular approximation theorem 12.5. Let A_k be a CW-subcomplex of A obtained from C by attaching cells of dimension $\leq k$, similarly let X_k be a CW-subcomplex of X obtained from B by attaching cells of dimension $\leq k$. Using the long exact sequences for triples (A_k, A_{k-1}, C) and (X_k, X_{k-1}, B) , we

get the diagram

$$\begin{array}{ccccccccc}
\pi_{i+1}(A_k, A_{k-1}) & \longrightarrow & \pi_i(A_{k-1}, C) & \longrightarrow & \pi_i(A_k, C) & \longrightarrow & \pi_i(A_k, A_{k-1}) & \longrightarrow & \pi_{i-1}(A_{k-1}, C) \\
\downarrow \cong & & \downarrow & & \downarrow & & \downarrow \cong & & \downarrow \\
\pi_{i+1}(X_k, X_{k-1}) & \longrightarrow & \pi_i(X_{k-1}, B) & \longrightarrow & \pi_i(X_k, B) & \longrightarrow & \pi_i(X_k, X_{k-1}) & \longrightarrow & \pi_{i-1}(X_{k-1}, B)
\end{array}$$

Applying the previous step for $X_k = A_k \cup X_{k-1}$ and $A_{k-1} = A_k \cap X_{k-1}$ we obtain the indicated isomorphisms. Now the induction with respect to k and 5-lemma completes the proof that $\pi_i(A_{m+n+1}, C) \rightarrow \pi_i(X_{m+n+1}, B)$ is an isomorphism for $i < m + n$ and an epimorphism for $i = m + n$.

4. Consider a general case. Then according to Corrolary 12.6 there is a CW-pair (A', C) homotopy equivalent to (A, C) and a CW-pair (B', C) homotopy equivalent to (B, C) such that $A' - C$ contains only cells of dimension $\geq m + 1$ and $B' - C$ contains only cells of dimension $\geq n + 1$. Then $X' = A' \cup B'$ is homotopy equivalent to $X = A \cup B$. According to the previous case $j' : (A', C) \rightarrow (X', B')$ is an $(m + n)$ -equivalence, consequently $j : (A, C) \rightarrow (X, B)$ is an $(m + n)$ -equivalence as well. \square

Corollary. *If a CW-pair (X, A) is r -connected and A is s -connected with $r, s \geq 0$, then the homomorphism*

$$\pi_i(X, A) \rightarrow \pi_i(X/A)$$

induced by the quotient map $X \rightarrow X/A$ is an isomorphism for $i \leq r + s$ and an epimorphism for $i \leq r + s + 1$.

Proof. Consider the diagram:

$$\begin{array}{ccccc}
\pi_i(X, A) & \longrightarrow & \pi_i(X \cup CA, CA) & \longrightarrow & \pi_i(X \cup CA/CA) \xrightarrow{\cong} \pi_i(X/A) \\
& & \uparrow \cong & \nearrow \cong & \\
& & \pi_i(X \cup CA) & &
\end{array}$$

The first homomorphism is $(r+s+1)$ -equivalence by the homotopy excision theorem for $(s+1)$ -connected pair (CA, A) and r -connected pair (X, A) . The vertical isomorphism comes from the long exact sequence for the pair $(X \cup CA, CA)$ and the remaining isomorphisms are induced by a homotopy equivalence and the identity $X \cup CA/CA = X/A$. \square

13.2. Freudenthal suspension theorem. We have defined the suspension of a space in 1.5 and the reduced suspension of a space with distinguished point in 1.6. In 4.3 we have introduced the suspension of a map. In a similar way we can define the reduced suspension of a map which preserves distinguished points. This notion defines so called suspension homomorphism $\pi_i(X) \rightarrow \pi_{i+1}(\Sigma X)$, $[f] \mapsto [\Sigma f]$ for every space X .

Theorem (Freudenthal suspension theorem). *Let X be $(n-1)$ -connected CW-complex, $n \geq 1$. Then the suspension homomorphism $\pi_i(X) \rightarrow \pi_{i+1}(\Sigma X)$ is an isomorphism for $i \leq 2n - 2$ and an epimorphism for $i \leq 2n - 1$.*

Proof. The suspension ΣX is a union of two reduced cones \tilde{C}_+X and \tilde{C}_-X with intersection X . Now, we get

$$\pi_i(X) \cong \pi_{i+1}(\tilde{C}_+X, X) \rightarrow \pi_{i+1}(\Sigma X, \tilde{C}_-X) \cong \pi_{i+1}(\Sigma X)$$

where the first and the last isomorphisms come from the long exact sequences for pairs (\tilde{C}_+X, X) and $(\Sigma X, \tilde{C}_-X)$, respectively, and the middle homomorphism comes from homotopy excision theorem for n -connected pairs (\tilde{C}_+X, X) and (\tilde{C}_-X, X) . What remains is to show that the induced map on the level of homotopy groups is the same as suspension homomorphism which is left to the reader. \square

13.3. Stable homotopy groups. The Freudenthal suspension theorem enables us to define *stable homotopy groups*. Consider a based space X and an integer j . The n -times iterated reduced suspension $\Sigma^n X$ is at least $(n-1)$ -connected. If $n \geq j+2$, then $i = j+n \leq 2n-2$, so the assumptions of the Freudenthal suspension theorem are satisfied and we get

$$\pi_{j+(j+2)}(\Sigma^{j+2}X) \cong \pi_{j+(j+3)}(\Sigma^{j+3}X) \cong \pi_{j+(j+4)}(\Sigma^{j+4}X) \cong \dots$$

Hence we define the j -th stable homotopy group of the space X as

$$\pi_j^s(X) = \lim_{n \rightarrow \infty} \pi_{j+n}(\Sigma^n X).$$

We will write π_j^s for the j -th stable homotopy group of S^0 .

13.4. Computations. In this paragraph we compute n -th homotopy groups of $(n-1)$ -connected CW-complexes.

Theorem A. $\pi_n(S^n) \cong \mathbb{Z}$ generated by the identity map for all $n \geq 1$. Moreover, this isomorphism is given by the degree map $\pi_n(S^n) \rightarrow \mathbb{Z}$.

Proof. Consider the diagram

$$\begin{array}{ccccccc} \pi_1(S^1) & \xrightarrow{\text{epi}} & \pi_2(S^2) & \xrightarrow{\cong} & \pi_3(S^3) & \xrightarrow{\cong} & \dots \\ \text{deg} \downarrow \cong & & \text{deg} \downarrow & & \text{deg} \downarrow & & \\ \mathbb{Z} & \xrightarrow{=} & \mathbb{Z} & \xrightarrow{=} & \mathbb{Z} & \xrightarrow{=} & \dots \end{array}$$

where the horizontal homomorphisms are suspension homomorphisms and the left vertical isomorphism is known from Section 11 and determined by degree. The statement follows now from the fact that $\text{deg } f = \text{deg } \Sigma f$. \square

Exercise. Prove that $\pi_n(\prod_{\alpha \in A} X_\alpha) = \prod_{\alpha \in A} \pi_n(X_\alpha)$.

Theorem B. $\pi_n(\bigvee_{\alpha \in A} S_\alpha^n) = \bigoplus_{\alpha \in A} \mathbb{Z}$ for $n \geq 2$.

Proof. Suppose first that A is finite. Then CW-complex $\bigvee_{\alpha \in A} S_\alpha^n$ is a subcomplex of CW-complex $\prod_{\alpha \in A} S_\alpha^n$. The pair

$$\left(\prod_{\alpha \in A} S_\alpha^n, \bigvee_{\alpha \in A} S_\alpha^n \right)$$

is $(2n - 1)$ -connected since $\prod_{\alpha \in A} S_\alpha^n$ is obtained from $\bigvee_{\alpha \in A} S_\alpha^n$ by attaching cells of dimension $\geq 2n$. Hence

$$\pi_n\left(\bigvee_{\alpha \in A} S_\alpha^n\right) = \pi_n\left(\prod_{\alpha \in A} S_\alpha^n\right) = \prod_{\alpha \in A} \pi_n(S_\alpha^n) = \bigoplus_{\alpha \in A} \pi_n(S_\alpha^n) = \bigoplus_{\alpha \in A} \mathbb{Z}.$$

If A is infinite, consider homomorphism $\phi : \bigoplus_{\alpha \in A} \pi_n(S_\alpha^n) \rightarrow \pi_n(\bigvee_{\alpha \in A} S_\alpha^n)$ induced by inclusions $\pi_n(S_\alpha^n) \rightarrow \pi_n(\bigvee_{\alpha \in A} S_\alpha^n)$. ϕ is surjective since any $f : S^n \rightarrow \bigvee_{\alpha \in A} S_\alpha^n$ has a compact image and meets only finitely many S_α^n 's. Similarly, if $h : S^n \times I \rightarrow \bigvee_{\alpha \in A} S_\alpha^n$ is homotopy between f and the constant map, it meets only finitely many S_α^n 's, so $\phi^{-1}([f])$ is zero. \square

Theorem C. *Suppose $n \geq 2$. If X is obtained from $\bigvee_{\alpha \in A} S_\alpha^n$ by attaching cells e_β^{n+1} via base point preserving maps $\varphi_\beta : S^n \rightarrow \bigvee_{\alpha \in A} S_\alpha^n$, then*

$$\pi_i(X) = \begin{cases} 0 & \text{if } i < n, \\ \bigoplus_{\alpha \in A} \pi_n(S_\alpha^n)/N & \text{if } i = n. \end{cases}$$

where N is a subgroup of $\bigoplus_{\alpha \in A} \pi_n(S_\alpha^n)$ generated by $[\varphi_\beta]$.

Proof. The first equality is clear from the cellular approximation theorem. Consider the long exact sequence for the pair $(X, X^n = \bigvee_{\alpha \in A} S_\alpha^n)$

$$\pi_{n+1}(X, X^n) \xrightarrow{\partial} \pi_n(X^n) \rightarrow \pi_n(X) \rightarrow 0.$$

The pair (X, X^n) is n -connected, X^n is $(n - 1)$ -connected, hence by Corollary 13.1

$$\pi_{n+1}(X, X^n) \rightarrow \pi_{n+1}(X/X^n) = \pi_{n+1}\left(\bigvee_{\beta \in B} S_\beta^{n+1}\right) = \bigoplus_{\beta \in B} \mathbb{Z}$$

is an isomorphism. Hence

$$\pi_n(X) = \pi_n(X^n)/\text{Im } \partial = \pi_n\left(\bigvee_{\alpha \in A} S_\alpha^n\right)/N$$

since $\text{Im } \partial$ is generated by $[\varphi_\beta]$. \square

13.5. Hurewicz homomorphism. The *Hurewicz map* $h : \pi_n(X, A, x_0) \rightarrow H_n(X, A)$ assigns to every element in $\pi_n(X, A, x_0)$ represented by $f : (D^n, \partial D^n, s_0) \rightarrow (X, A, x_0)$ the element $f_*(\iota) \in H_n(X, A)$ where $\iota \in H_n(D^n, \partial D^n) = H_n(\Delta^n, \partial \Delta^n)$ is the generator induced by the identity map $\Delta^n \rightarrow \Delta^n$. In the same way we can define the Hurewicz map $h : \pi_n(X) \rightarrow H_n(X)$.

Proposition 13.6. *The Hurewicz map is a homomorphism.*

Proof. Let $c : D^n \rightarrow D^n \vee D^n$ be the map collapsing equatorial D^{n-1} into a point, $q_1, q_2 : D^n \vee D^n \rightarrow D^n$ quotient maps and $i_1, i_2 : D^n \rightarrow D^n \vee D^n$ inclusions. We have

the diagram

$$\begin{array}{ccccc} H_n(D^n, \partial D^n) & \xrightarrow{c_*} & H_n(D^n \vee D^n, \partial D^n \vee \partial D^n) & \xrightarrow{f \vee g} & H_n(X, A) \\ & & \begin{array}{c} \uparrow i_{1*} + i_{2*} \\ \downarrow q_{1*} \oplus q_{2*} \end{array} & & \\ & & H_n(D^n, \partial D^n) \oplus H_n(D^n, \partial D^n) & & \end{array}$$

Since $i_{1*} + i_{2*}$ is an inverse to $q_{1*} \oplus q_{2*}$, we get

$$\begin{aligned} h([f] + [g]) &= (f + g)_*(\iota) = (f \vee g)_* c_*(\iota) \\ &= ((f \vee g)_*(i_{1*} + i_{2*}))((q_{1*} \oplus q_{2*})c_*)(\iota) = (f_* + g_*)(\iota \oplus \iota) \\ &= f_*(\iota) + g_*(\iota) = h([f]) + h([g]). \end{aligned}$$

□

We leave the reader to prove the following properties of the Hurewicz homomorphism directly from the definition:

Proposition 13.7. *The Hurewicz homomorphism is natural, i. e. the diagram*

$$\begin{array}{ccc} \pi_n(X, A) & \xrightarrow{f_*} & \pi_n(Y, B) \\ h_X \downarrow & & \downarrow h_Y \\ H_n(X, A) & \xrightarrow{f_*} & H_n(Y, B) \end{array}$$

commutes for any $f : (X, A) \rightarrow (Y, B)$.

The Hurewicz homomorphisms make commutative also the following diagram with long exact sequences of a pair (X, A) :

$$\begin{array}{ccccccc} \pi_n(A) & \longrightarrow & \pi_n(X) & \longrightarrow & \pi_n(X, A) & \xrightarrow{\partial} & \pi_{n-1}(A) \\ \downarrow h_A & & \downarrow h_X & & \downarrow h_{(X,A)} & & \downarrow h_A \\ H_n(A) & \longrightarrow & H_n(X) & \longrightarrow & H_n(X, A) & \xrightarrow{\partial} & H_{n-1}(A) \end{array}$$

13.8. Hurewicz theorem. The previous calculations of $\pi_n(\bigvee_{\alpha \in A} S_\alpha^n)$ enable us to compare homotopy and homology groups of $(n-1)$ -connected CW-complexes via the Hurewicz homomorphism.

Theorem A (Absolute version of the Hurewicz theorem). *Let $n \geq 2$. If X is a $(n-1)$ -connected, then $\tilde{H}_i(X) = 0$ for $i < n$ and $h : \pi_n(X) \rightarrow H_n(X)$ is an isomorphism.*

For the case $n = 1$ see Theorem 11.5.

Proof. We will carry out the proof only for CW-complexes X . For general method which enables us to enlarge the result to all spaces see [Hatcher], Proposition 4.21.

First, realize that $h : \pi_n(S^n) \rightarrow H_n(S^n)$ is an isomorphism. It follows from the characterization of $\pi_n(S^n)$ by degree in Theorem 13.4.

According to Corollary 12.6 every $(n-1)$ -connected CW-complex X is homotopy equivalent to a CW-complex obtained by attaching cells of dimension $\geq n$ to a point.

Moreover cells of dimension $\geq n + 2$ do not play any role in computing π_i and H_i for $i \leq n$. Hence we may suppose that

$$X = \bigvee_{\alpha \in A} S_\alpha^n \cup_{\varphi_\beta} \bigcup_{\beta \in B} e_\beta^{n+1} = X^{n+1}$$

where φ_β are base point preserving maps. Then $\tilde{H}_i(X) = 0$ for $i < n$.

Using the long exact sequences for the pair (X, X^n) and the Hurewicz homomorphisms between them we get

$$\begin{array}{ccccccc} \pi_{n+1}(X, X^n) & \xrightarrow{\partial} & \pi_n(X^n) & \longrightarrow & \pi_n(X) & \longrightarrow & 0 \\ \downarrow h & & \downarrow h & & \downarrow h & & \\ H_{n+1}(X, X^n) & \xrightarrow{\partial} & H_n(X^n) & \longrightarrow & H_n(X) & \longrightarrow & 0 \end{array}$$

Since $\pi_{n+1}(X, X^n)$ is isomorphic to $\pi_{n+1}(X/X^n) = \bigoplus \pi_{n+1}(S_\beta^{n+1})$ and $\pi_n(X^n) = \bigoplus \pi_n(S_\alpha^n)$, the first and the second Hurewicz homomorphisms are isomorphisms. According to the 5-lemma so is $h : \pi_n(X) \rightarrow H_n(X)$. \square

Let $[\gamma] \in \pi_1(A, x_0)$, $[f] \in \pi_n(X, A, x_0)$. Then $\gamma \cdot f$ and f are homotopic (although the homotopy does not keep the base point x_0 fixed), and consequently,

$$(\gamma \cdot f)_*(\iota) = f_*(\iota)$$

for $\iota \in H_n(D^n, \partial D^n)$. Hence $h([\gamma] \cdot [f]) = h([f])$.

Let $\pi'_n(X, A, x_0)$ be the factor of $\pi_n(X, A, x_0)$ by the normal subgroup generated by $[\gamma] \cdot [f] - [f]$. Let $h' : \pi'_n(X, A, x_0) \rightarrow H_n(X, A)$ be the map induced by the Hurewicz homomorphism h .

Theorem B (Relative version of the Hurewicz theorem). *Let $n \geq 2$. If a pair (X, A) of the path connected spaces is $(n - 1)$ -connected, then $H_i(X, A) = 0$ for $i < n$ and $h' : \pi'_n(X, A, x_0) \rightarrow H_n(X, A)$ is an isomorphism.*

Proof. We will prove the theorem for a pair (X, A) of CW-complexes where A is supposed to be simply connected. In this case $\pi'_n(X, A, x_0) = \pi_n(X, A, x_0)$ and $h' = h$. For general proof see [Hatcher], Theorem 4.37, pages 371–373.

Since (X, A) is $(n - 1)$ -connected and A is 1-connected, Corollary 13.1 implies that the quotient map $\pi_n(X, A) \rightarrow \pi_n(X/A)$ is an isomorphism and X/A is $(n - 1)$ -connected. The absolute version of the Hurewicz theorem and the commutativity of the diagram

$$\begin{array}{ccc} \pi_n(X, A) & \xrightarrow{\cong} & \pi_n(X/A) \\ \downarrow h & & \cong \downarrow h \\ H_n(X, A) & \xrightarrow{\cong} & H_n(X/A) \end{array}$$

imply immediately the required statement. \square

13.9. Homology version of Whitehead theorem. Since computations in homology are much easier than in homotopy, the following homology version of the Whitehead theorem gives a very useful method how to prove that two spaces are homotopy equivalent.

Theorem (Whitehead theorem). *A map $f : X \rightarrow Y$ between two simply connected CW-complexes is homotopy equivalence if $f_* : H_n(X) \rightarrow H_n(Y)$ is an isomorphism for all n .*

Proof. Replacing Y by the mapping cylinder M_f we can consider f to be an inclusion $X \hookrightarrow Y$. Since X and Y are simply connected, we have $\pi_1(Y, X) = 0$. Using the relative version of the Hurewicz theorem and the induction with respect to n , we get successively that

$$\pi_n(Y, X) = H_n(Y, X) = 0.$$

The long exact sequence of homotopy groups for the pair (Y, X) yields that $f_* : \pi_n(X) \rightarrow \pi_n(Y)$ is an isomorphism for all n . Applying now the Whitehead theorem 12.3 we get that f is a homotopy equivalence. \square

14. SHORT OVERVIEW OF SOME FURTHER METHODS IN HOMOTOPY THEORY

We start this sections with two examples of computations of homotopy groups. These computations demonstrate the fact that the possibilities of the methods we have learnt so far are very restricted. Hence we outline some further (still very classical) methods which enable us to prove and compute more.

14.1. Homotopy groups of Stiefel manifolds. Let $n \geq 3$ and $n > k \geq 1$. The Stiefel manifold $V_{n,k}$ is $(n - k - 1)$ -connected and

$$\pi_{n-k}(V_{n,k}) = \begin{cases} \mathbb{Z} & \text{for } k = 1, \\ \mathbb{Z} & \text{for } k \neq 1 \text{ and } n - k \text{ even,} \\ \mathbb{Z}_2 & \text{for } k \neq 1 \text{ and } n - k \text{ odd.} \end{cases}$$

Proof. The statement about connectivity follows from the long exact sequence for the fibration

$$V_{n-1,k-1} \rightarrow V_{n,k} \rightarrow V_{n,1} = S^{n-1}$$

by induction.

As for the second statement, it is sufficient to prove that

$$\pi_{n-2}(V_{n,2}) = \begin{cases} \mathbb{Z} & \text{for } n \text{ even,} \\ \mathbb{Z}_2 & \text{for } n \text{ odd} \end{cases}$$

and to use the induction in the long exact sequence for the fibration above.

We have the fibration

$$S^{n-2} = V_{n-1,1} \rightarrow V_{n,2} \xrightarrow{p} V_{n,1} = S^{n-1}$$

which corresponds to the tangent vector bundle of the sphere S^{n-1} . If n is even, there is a nonzero vector field on S^{n-1} . This field is a map $s : S^{n-1} \rightarrow V_{n,2}$ such that $ps = \text{id}_{S^{n-1}}$. Such a map is called a section and its existence ensures that the map $p_* : \pi_{n-1}(V_{n,2}) \rightarrow \pi_{n-1}(S^{n-1})$ is an epimorphism. Hence we get the following part of the long exact sequence

$$\pi_{n-1}(V_{n,2}) \xrightarrow{\text{epi}} \pi_{n-1}(S^{n-1}) \xrightarrow{0} \pi_{n-2}(S^{n-2}) \xrightarrow{\cong} \pi_{n-2}(V_{n,2}) \rightarrow 0.$$

Consequently, $\pi_{n-2}(V_{n,2}) = \mathbb{Z}$.

The case n odd is more complicated. We need the fact that the Euler class of tangent bundle of S^{n-1} is twice a generator $\iota \in H^{n-1}(S^{n-1})$. We obtain the following part of the Gysin exact sequence for cohomology groups with integer coefficients

$$0 \rightarrow H^{n-2}(V_{n,2}) \xrightarrow{0} H^0(S^{n-1}) \xrightarrow{\cup 2\iota} H^{n-1}(S^{n-1}) \rightarrow H^{n-1}(V_{n,2}) \rightarrow 0.$$

From this sequence and the universal coefficient theorem we get that

$$\begin{aligned} 0 &= H^{n-2}(V_{n,2}; \mathbb{Z}) \cong \text{Hom}(H_{n-2}(V_{n,2}), \mathbb{Z}) \\ \mathbb{Z}_2 &\cong H^{n-1}(V_{n,2}) \cong \text{Hom}(H_{n-1}(V_{n,2}), \mathbb{Z}) \oplus \text{Ext}(H_{n-2}(V_{n,2}), \mathbb{Z}) \end{aligned}$$

which implies that $H_{n-2}(V_{n,2}; \mathbb{Z}) \cong \mathbb{Z}_2$. The Hurewicz theorem now yields $\pi_{n-1}(V_{n,2}) \cong \mathbb{Z}_2$. \square

14.2. Hopf fibration. Consider the Hopf fibration

$$S^1 \rightarrow S^3 \xrightarrow{\eta} S^2$$

defined in 10.5. From the long exact sequence for this fibration we get

$$\pi_i(S^2) \cong \pi_i(S^3) \quad \text{for } i \geq 2.$$

Particularly,

$$\pi_3(S^2) \cong \mathbb{Z}$$

with $[\eta]$ as a generator (since $[\text{id}]$ is a generator of $\pi_3(S^3)$). By the Freudenthal theorem $\mathbb{Z} \cong \pi_3(S^2) \xrightarrow{\text{epi}} \pi_4(S^3) \xrightarrow{\cong} \pi_1^s$. The methods we have learnt so far give us only that $\pi_4(S^3) \cong \pi_1^s$ is a factor of \mathbb{Z} with $\Sigma\eta$ as a generator.

Exercise. Try to compute as much as possible from the long exact sequences for the other two Hopf fibrations in 10.5.

14.3. Composition methods were developed in works of I. James and the Japanese school of H. Toda in the 1950-ies and are described in the monograph [Toda]. They enable us to find maps which determine the generators of homotopy groups $\pi_{n+k}(S^n)$ for k not very big (approximately $k \leq 20$). For these purposes various types of compositions and products are used.

Having two maps $f : S^i \rightarrow S^n$ and $g : S^n \rightarrow S^m$ their composition $gf : S^i \rightarrow S^m$ determines an element $[gf] \in \pi_i(S^m)$ which depends only on $[f]$ and $[g]$. If the target of f is different from the source of g , we can use suitable multiple suspensions to be able to make compositions. For instance, if $f : S^6 \rightarrow S^4$ and $g : S^7 \rightarrow S^3$ we can make composition $g \circ (\Sigma^3 f) : S^9 \rightarrow S^3$. (Here Σ stands for reduced suspension.) In this way we get a bilinear map $\pi_a^s \times \pi_b^s \rightarrow \pi_{a+b}^s$.

More complicated tool is the *Toda bracket*. Consider three maps

$$W \xrightarrow{f} X \xrightarrow{g} Y \xrightarrow{h} Z$$

preserving distinguished points such that $gf \sim 0$ and $hg \sim 0$. Then gf can be extended to a map $F : \tilde{C}W \rightarrow Y$ and hg can be extended to a map $G : \tilde{C}X \rightarrow Z$. (\tilde{C} stands for reduced cone.) Define $\langle f, g, h \rangle : \Sigma W = \tilde{C}_+W \cup \tilde{C}_-W \rightarrow Z$ as $G \circ \tilde{C}f$ on \tilde{C}_+W and $h \circ F$ on \tilde{C}_-W .

This definition depends on homotopies $gf \sim 0$ and $hg \sim 0$. So it defines a map from $\pi_i^s \times \pi_j^s \times \pi_k^s$ to cosets of $\pi_{i+j+k+1}^s$. See [Toda] and also Exercise 39 in [Hatcher], Chapter 4.2.

The *Whitehead product* $[,] : \pi_i(X) \times \pi_j(X) \rightarrow \pi_{i+j-1}(X)$ is defined as follows: $f : I^i \rightarrow X$ and $g : I^j \rightarrow X$ define the map $f \times g : I^{i+j} = I^i \times I^j \rightarrow X$ and we put $[f, g] = (f \times g) / \partial I^{i+j}$.

Having a map $f : S^{2n-1} \rightarrow S^n$, $n \geq 2$, we can construct a CW-complex $C_f = S^n \cup_f e^{2n}$ with just one cell in the dimensions 0, n and $2n$. Denote the generators of $H^n(C_f; \mathbb{Z})$ and $H^{2n}(C_f; \mathbb{Z})$ by α and β , respectively. Then the *Hopf invariant* of f is the number $H(f)$ such that

$$\alpha^2 = H(f)\beta.$$

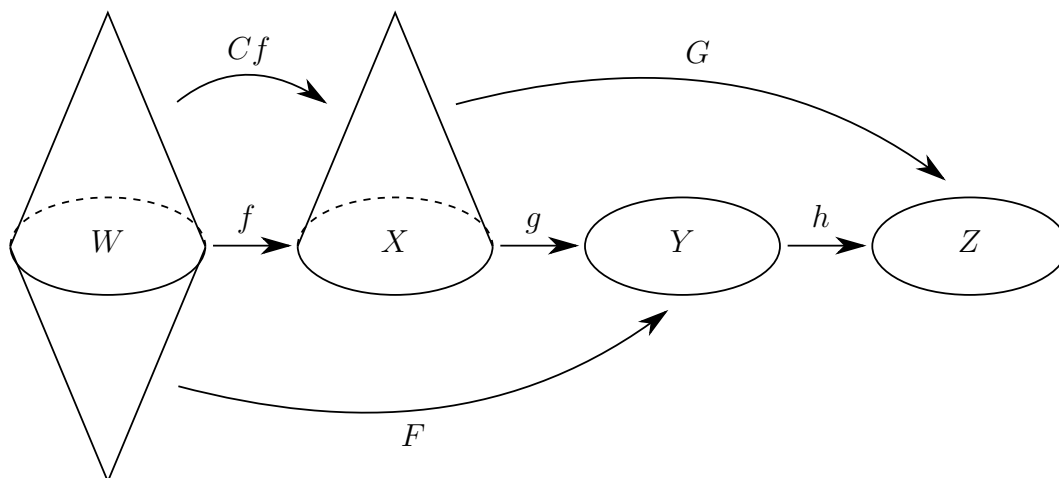

FIGURE 14.1. Definition of Toda bracket $\langle f, g, h \rangle$.

The Hopf invariant determines a homomorphism $H : \pi_{2n-1}(S^n) \rightarrow \mathbb{Z}$.

For the Hopf map $\eta : S^3 \rightarrow S^2$ we have $C_\eta \cong \mathbb{C}\mathbb{P}^2$, consequently

$$H(\eta) = 1.$$

For $\text{id} : S^2 \rightarrow S^2$ we can make the Whitehead product $[\text{id}, \text{id}] : S^3 \rightarrow S^2$ and compute (see [Hatcher], page 474) that

$$H([\text{id}, \text{id}]) = \pm 2.$$

Since $\pi_3(S^2) \cong \mathbb{Z}$, we get $[\text{id}, \text{id}] = \pm 2\eta$. One can show (see [Hatcher], page 474 and Corollary 4J.4) that the kernel of the suspension homomorphism $\pi_3(S^2) \rightarrow \pi_4(S^3)$ is generated just by $[\text{id}, \text{id}]$. By the Freudenthal theorem this suspension homomorphism is an epimorphism which implies that

$$\pi_4(S^3) \cong \mathbb{Z}_2.$$

Consequently, $\pi_1^s \cong \mathbb{Z}_2$.

Remark. J. F. Adams proved in [Adams1] that the only maps with the odd Hopf invariant are the maps coming from the Hopf fibrations $S^3 \rightarrow S^2$, $S^7 \rightarrow S^4$ and $S^{15} \rightarrow S^8$.

Another important tool for composition methods is the EHP exact sequence for the homotopy groups of S^n , S^{n+1} and S^{2n} :

$$\begin{aligned} \pi_{3n-2}(S^n) \xrightarrow{E} \pi_{3n-1}(S^{n+1}) \xrightarrow{H} \pi_{3n-2}(S^{2n}) \xrightarrow{P} \pi_{3n-3}(S^n) \rightarrow \dots \\ \dots \rightarrow \pi_i(S^n) \xrightarrow{E} \pi_{i+1}(S^{n+1}) \xrightarrow{H} \pi_i(S^{2n}) \xrightarrow{P} \pi_{i-1}(S^n) \rightarrow \dots \end{aligned}$$

Here E stands for suspension, H refers to a generalized Hopf invariant and P is defined with connection to the Whitehead product. See [Whitehead], Chapter XII or [Hatcher], page 474.

For $n = 2$ the EHP exact sequence yields

$$\pi_4(S^2) \xrightarrow{E} \pi_5(S^3) \xrightarrow{H} \pi_4(S^4) \xrightarrow{P} \pi_3(S^2) \xrightarrow{E} \pi_4(S^3) \rightarrow 0.$$

Since $\pi_4(S^3) \cong \mathbb{Z}_2$, $\pi_3(S^2) \cong \mathbb{Z}$ and $\pi_4(S^4) \cong \mathbb{Z}$, we obtain that P is a multiplication by 2 and $H = 0$. From the long exact sequence for the Hopf fibration (see 14.2) we get that $\pi_4(S^2) \cong \pi_4(S^3) \cong \mathbb{Z}_2$ with the generator $\eta(\Sigma\eta)$. So $\pi_5(S^3)$ is either \mathbb{Z}_2 or 0. By a different methods one can show that

$$\pi_5(S^3) \cong \mathbb{Z}_2$$

with the generator $(\Sigma\eta)(\Sigma^2\eta)$.

14.4. Cohomological methods have been playing an important role in homotopy theory since they were introduced in the 1950-ies.

By the methods used in proofs in Section 12 we can construct so called *Eilenberg-McLane spaces* $K(G, n)$ for any $n \geq 0$ and any group G , Abelian if $n \geq 2$. These spaces are up to homotopy equivalence uniquely determined by their homotopy groups

$$\pi_i(K(G, n)) = \begin{cases} 0 & \text{for } i \neq n, \\ G & \text{for } i = n. \end{cases}$$

Moreover, these spaces provide the following homotopy description of reduced singular cohomology groups

$$[(X, *), (K(G, n), *)] \xrightarrow{\cong} \tilde{H}^n(X; G).$$

To each $[f] \in [(X, *), (K(G, n), *)]$ we assign

$$f^*(\iota) \in \tilde{H}^n(X; G)$$

where ι is the generator of

$$\tilde{H}^n(K(G, n); G) \cong \text{Hom}(\tilde{H}_n(K(G, n); \mathbb{Z}), G) \cong \text{Hom}(G, G)$$

corresponding to id_G .

A system of homomorphisms $\theta_X : \tilde{H}^n(X; G_1) \rightarrow \tilde{H}^m(X; G_2)$ which is natural, i. e. $f^*\theta_Y = \theta_X f^*$ for all $f : X \rightarrow Y$, is called a *cohomology operation*. A system of cohomology operations $\theta_j : \tilde{H}^{n+j} \rightarrow \tilde{H}^{m+j}$ is called *stable* if it commutes with suspensions $\Sigma\theta_j = \theta_{j+1}\Sigma$.

The most important stable cohomology operations for singular cohomology are the Steenrod squares and the Steenrod powers:

$$\begin{aligned} Sq^i &: \tilde{H}^n(X; \mathbb{Z}_2) \rightarrow \tilde{H}^{n+i}(X; \mathbb{Z}_2) \\ P_p^i &: \tilde{H}^n(X; \mathbb{Z}_p) \rightarrow \tilde{H}^{n+2i(p-1)}(X; \mathbb{Z}_p) \quad \text{for } p \neq 2 \text{ a prime.} \end{aligned}$$

For their definition and properties see [SE] or [Hatcher], Section 4.L. These operations can be also interpreted as homotopy classes of maps between Eilenberg-McLane spaces, for instance

$$Sq^i : K(\mathbb{Z}_2, n) \rightarrow K(\mathbb{Z}_2, n + i).$$

Example A. We show how the Steenrod squares can be used to prove that some maps are not homotopic to a trivial one. Consider the Hopf map $\eta : S^3 \rightarrow S^2$. We

know that $C_\eta = \mathbb{C}\mathbb{P}^2$ and $H^2(\mathbb{C}\mathbb{P}^2; \mathbb{Z}_2)$ and $H^4(\mathbb{C}\mathbb{P}^2; \mathbb{Z}_2)$ have generators α and α^2 . Since one of the properties of the Steenrod squares is

$$Sq^n x = x^2 \quad \text{for } x \in H^n(X; \mathbb{Z}_2),$$

we get that $Sq^2 \alpha = \alpha^2 \neq 0$. Using this fact we show that $[\Sigma \eta] \in \pi_4(S^3)$ is nontrivial.

For reduced cones and reduced suspensions one can prove that

$$\tilde{C}_{\Sigma \eta} = \Sigma \tilde{C}_\eta \simeq \Sigma \mathbb{C}\mathbb{P}^2.$$

Then $\Sigma \alpha : \Sigma \mathbb{C}\mathbb{P}^2 \rightarrow K(\mathbb{Z}_2, 3)$ and $\Sigma \alpha^2 : \Sigma \mathbb{C}\mathbb{P}^2 \rightarrow k(\mathbb{Z}_2; 5)$ represent generators in $H^3(\Sigma \mathbb{C}\mathbb{P}^2; \mathbb{Z}_2)$ and $H^5(\Sigma \mathbb{C}\mathbb{P}^2; \mathbb{Z}_2)$, respectively. Now

$$Sq^2(\Sigma \alpha) = \Sigma(Sq^2 \alpha) = \Sigma \alpha^2 \neq 0.$$

If $\Sigma \eta$ were homotopic to a constant map, we would have $\tilde{C}_{\Sigma \eta} = S^3 \vee S^5$, and consequently, $Sq^2(\Sigma \alpha) = 0$ since Sq^2 is trivial on S^3 .

Example B. We outline how to compute $\pi_{n+1}(S^n)$ using cohomological methods. A generator $\alpha \in H^n(S^n)$ induces up to homotopy a map $S^n \rightarrow K(\mathbb{Z}, n)$. Further, $H^n(K(\mathbb{Z}, n); \mathbb{Z}) \cong \mathbb{Z}$ with a generator ι and $H^{n+2}(K(\mathbb{Z}, n); \mathbb{Z}_2) \cong \mathbb{Z}_2$ with the generator $Sq^2 \rho \iota$ where $\rho : H^n(X; \mathbb{Z}) \rightarrow H^n(X; \mathbb{Z}_2)$ is induced by reduction mod 2. $Sq^2 \rho \iota$ induces up to homotopy a map

$$K(\mathbb{Z}, n) \xrightarrow{Sq^2 \rho \iota} K(\mathbb{Z}_2, n+2).$$

Consider the fibration

$$\Omega K(\mathbb{Z}_2, n+2) \rightarrow PK(\mathbb{Z}_2, n+2) \rightarrow K(\mathbb{Z}_2, n+2)$$

where PX is the space of all maps $p : I \rightarrow X$, $p(1) = x_0$ and ΩX is the space of all maps $\omega : I \rightarrow X$, $\omega(0) = \omega(1) = x_0$. (These maps are called loops in X .) One can show that $\Omega K(\mathbb{Z}_2, n+2)$ has a homotopy type of $K(\mathbb{Z}_2, n+1)$. The pullback of the fibration above by the map $Sq^2 \rho \iota : K(\mathbb{Z}, n) \rightarrow K(\mathbb{Z}_2, n+2)$ is the fibration

$$K(\mathbb{Z}_2, n+1) \rightarrow E \xrightarrow{p} K(\mathbb{Z}, n).$$

Since $Sq^2 \rho \alpha = 0$ in $H^{n+2}(S^n; \mathbb{Z})$, one can show that the map $\alpha : S^n \rightarrow K(\mathbb{Z}, n)$ can be lifted to a map $f : S^n \rightarrow E$.

$$\begin{array}{ccc} & & E \\ & \nearrow f & \downarrow p \\ S^n & \xrightarrow{\alpha} & K(\mathbb{Z}, n) \end{array}$$

One can compute f^* in cohomology (using so called long Serre exact sequence) and then also f_* in homology. A modified version of the homology Whitehead theorem implies that f is an $(n+2)$ -equivalence. Hence $f_* : \pi_{n+1}(S^n) \rightarrow \pi_{n+1}(E)$ is an isomorphism. Using the long exact sequence for the fibration $(E, K(\mathbb{Z}, n), p)$ we get

$$\mathbb{Z}_2 \cong \pi_{n+1}(K(\mathbb{Z}_2, n+1)) \xrightarrow{\cong} \pi_{n+1}(E) \cong \pi_{n+1}(S^n).$$

For more details see [MT].

The Steenrod operations form a beginning for the second course in algebraic topology which should contain spectral sequences, other homology and cohomology theories, spectra. We refer the reader to [Adams2], [Kochman], [MT], [Switzer], [Whitehead] or to the last sections of [Hatcher].

REFERENCES

- [A1] J. F. Adams, *On the non-existence of Hopf invariant one*, Ann. of Math. **72** (1960), 20–104.
- [A2] J. F. Adams, *Stable homotopy and generalised homology*, The University of Chicago Press (1974).
- [Br] G. E. Bredon, *Topology and geometry*, Graduate Texts in Math. Springer (1997).
- [Do] A. Dold, *Lectures on Algebraic Topology*, Springer (1972).
- [Ha] A. Hatcher, *Algebraic Topology*, Cambridge University Press (2002).
- [Ko] S. O. Kochman, *Bordisms, Stable Homotopy and Adams Spectral Sequences*, Fields Institutes Monographs **7**, AMS, (1996).
- [MS] J. W. Milnor, J. D. Stasheff, *Characteristic classes*, Princeton University Press, Princeton, (1974).
- [MT] R. E. Mosher, M. C. Tangora, *Cohomology operations and applications in homotopy theory*, Harper & Row Publishers, New York, (1968).
- [Sp] E. H. Spanier, *Algebraic Topology*, McGraw-Hill Book Company, New York, (1966).
- [SE] N. E. Steenrod, D. B. A. Epstein, *Cohomology Operations*, Annals of Math. Studies, **50**, Princeton Univ. Press, (1962).
- [Sw] R. M. Switzer, *Algebraic Topology – Homotopy and Homology*, Springer, (1975).
- [To] H. Toda, *Composition Methods in the Homotopy Groups of Spheres*, Ann. Math. Studies, Princeton, (1962).
- [Wh] G. W. Whitehead, *Elements of Homotopy Theory*, Graduate Texts in Math., Springer, (1995).

CZ.1.07/2.2.00/28.0041

Centrum interaktivních a multimediálních studijních opor pro inovaci výuky a efektivní učení



EVROPSKÁ UNIE



MINISTERSTVO ŠKOLSTVÍ,
MLÁDEŽE A TĚLOVÝCHOVY



OP Vzdělávání
pro konkurenceschopnost



INVESTICE DO ROZVOJE VZDĚLÁVÁNÍ