

# Metody studia buněčné signalizace

**Vítězslav BRYJA**

Ústav experimentální biologie, PŘF MU  
&  
Oddělení cytokinetiky, Biofyzikální ústav AV ČR

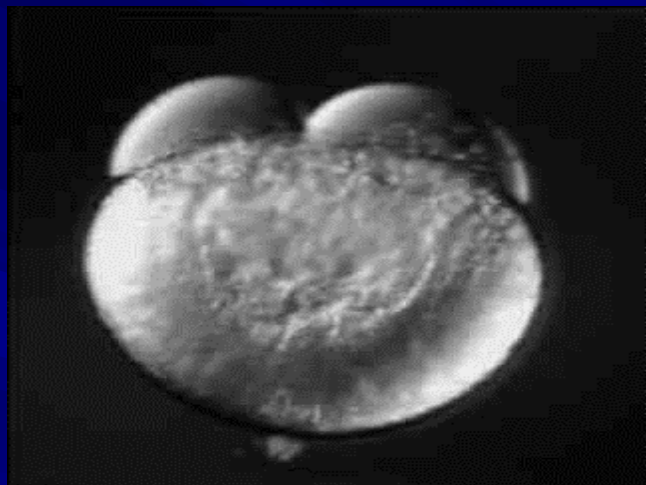

# Wnt signalling

- eg. Wnt-1 or Wnt-3a



# Consequences of $\beta$ -catenin activation in the brain:

midbrain (Brn4-promotor)

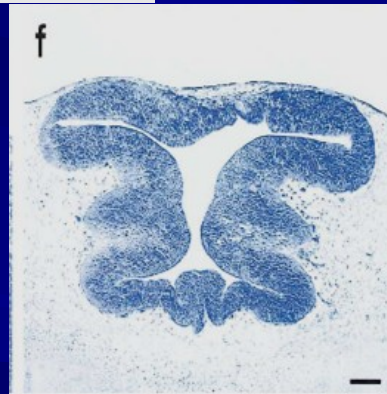
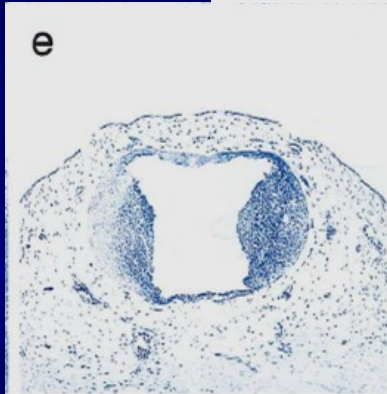
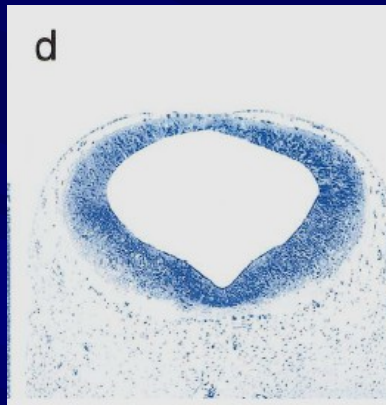

Zechner et al., 2003: Dev. Biol.;258:406-418.

cortex (nestin enhancer)

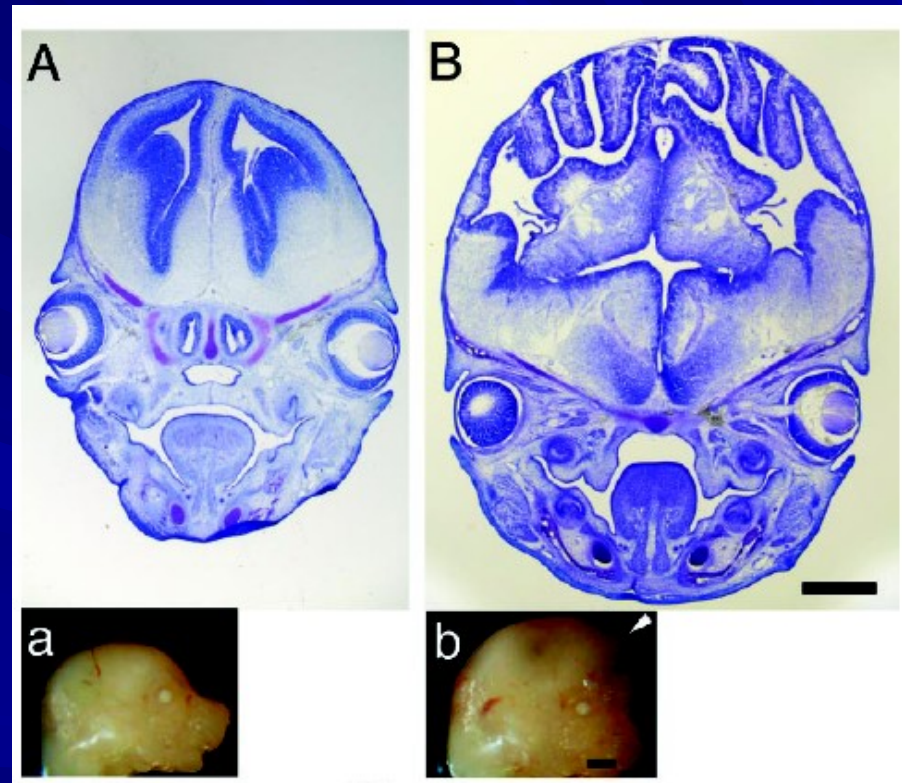

Chenn & Walsh, 2002: Science;297:365-369.

# Non-canonical/PCP (Planar cell polarity) pathway defects cause neural tube closure phenotypes in mouse (and human)

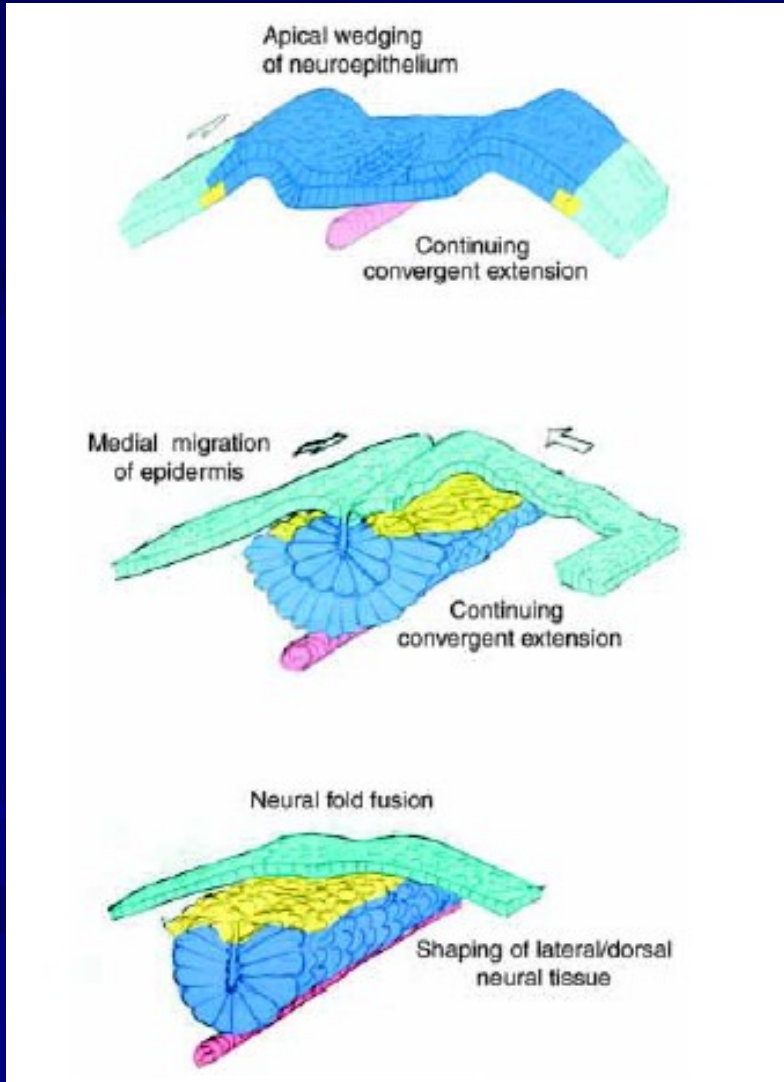

## Exencephaly

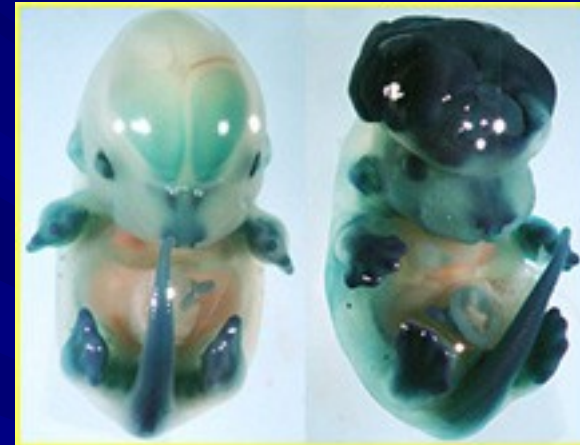

## Open neural tube



Protilátka  
(imunoglobulin)

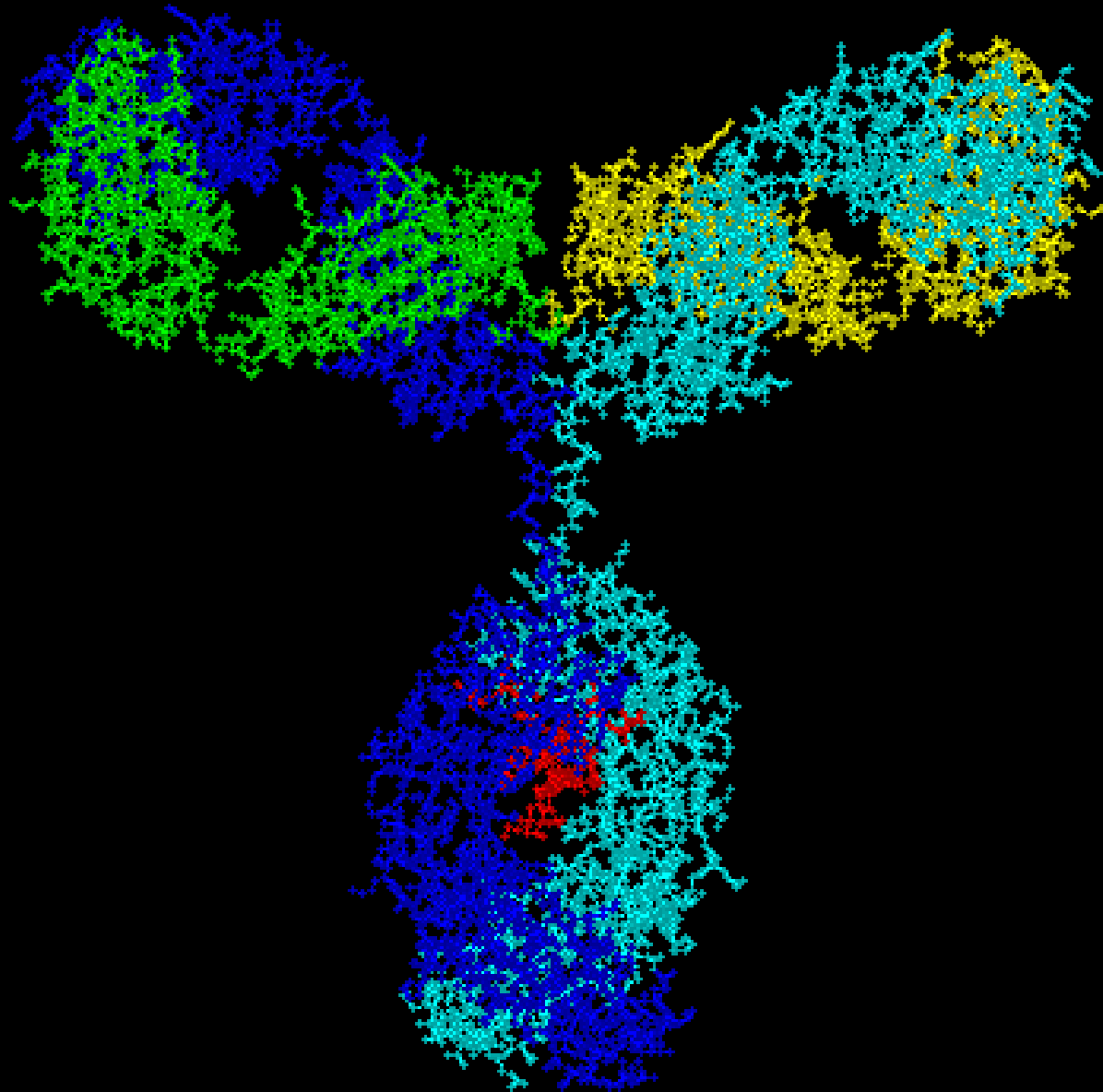

# Metoda 1: Western blotting

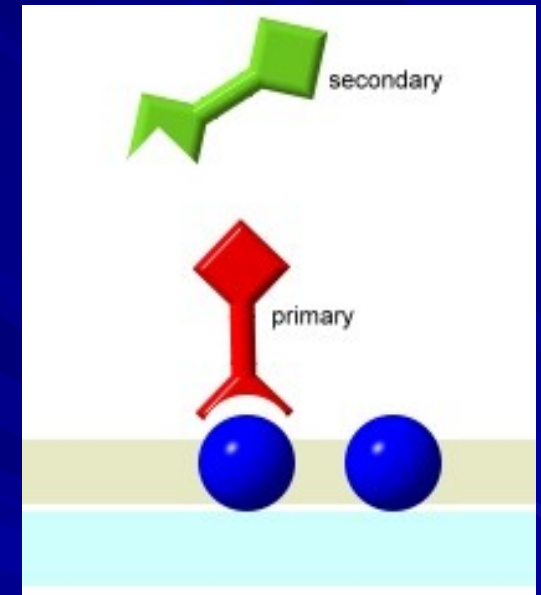
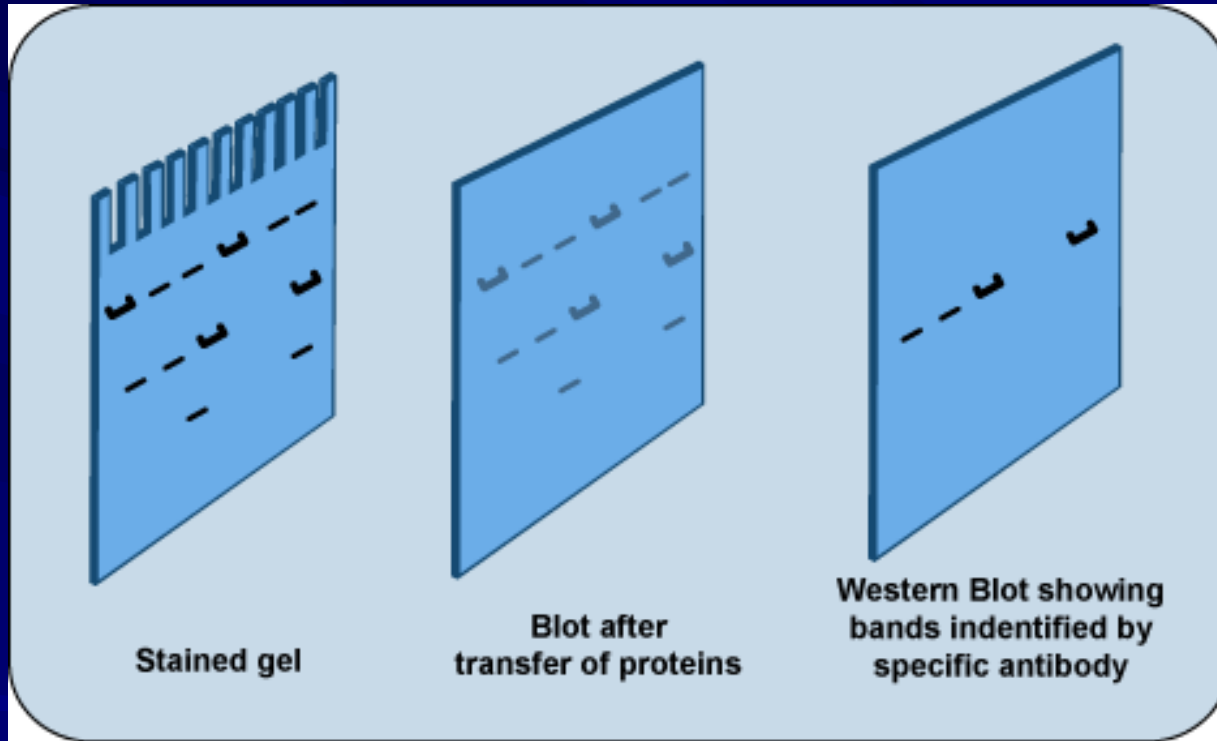

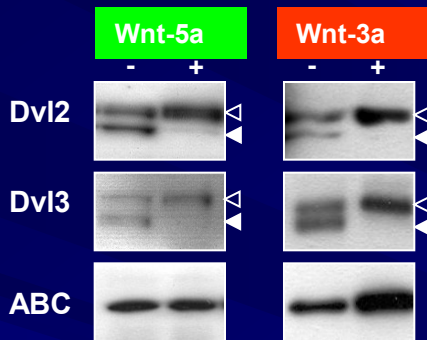

ABC – active  $\beta$ -catenin =  $\beta$ -catenin dephosphorylated on GSK3 target sites

Dvl – Dishevelled – activated by phosphorylation detected as phosphorylation dependent mobility shift

◁ PS-Dvl

Compound	Target	Concn	Activity
PTX	Galpha i/o	100 ng/ml	No
PDBu	PKC activator	1 $\mu$ M	No
Wortmannin	PI3K	50 nM	No
LY294002	PI3K	50 $\mu$ M	No
PD98059	MEK1/2	10 $\mu$ M	No
UO126	MEK1/2	10 $\mu$ M	No
SB203580	p38	10 $\mu$ M	No
JNKII inhib	JNK	6 $\mu$ M	No
Genistein	PKC	50 $\mu$ M	No
chelerythrine	PKC	10 $\mu$ M	No
Ro-31 8220	PKC	1 $\mu$ M	No
BIM I	PKC	500 nM	No
KN93	CamKII	10 $\mu$ M	No
I3M	GSK-3	2 $\mu$ M	No
Kenpauillone	GSK-3	6 $\mu$ M	No
H89	PKA	10 $\mu$ M	No
8-Br-cAMP	cAMP pathway activator	10 $\mu$ M	No
8CPT-2Me-cAMP	EPAC activator	30 $\mu$ M	No
SQ22536	Adenylyl cyclase	100 $\mu$ M	No
MDL12330	Adenylyl cyclase	10 $\mu$ M	No
PP2	Src-like	10 $\mu$ M	No
AG1276	EGFR	10 $\mu$ M	No
ET-18-OCH3	PLC	10 $\mu$ M	No
<b>D4476</b>	<b>Casein kinase 1</b>	<b>100 <math>\mu</math>M</b>	<b>Yes</b>
staurosporin	Ser/Thr kinases, PKC	2 $\mu$ M	No

D4476 (100  $\mu$ M)

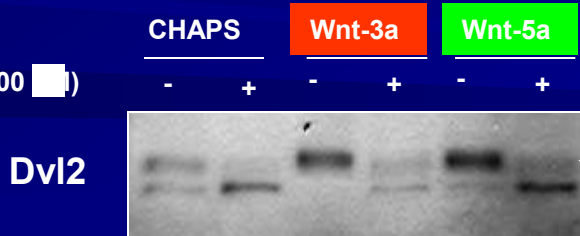

Both **Wnt-3a** and **Wnt-5a** activate Dvl2 and Dvl3 via casein kinase 1 (CK1)



# Metoda 2: Immunoprecipitace

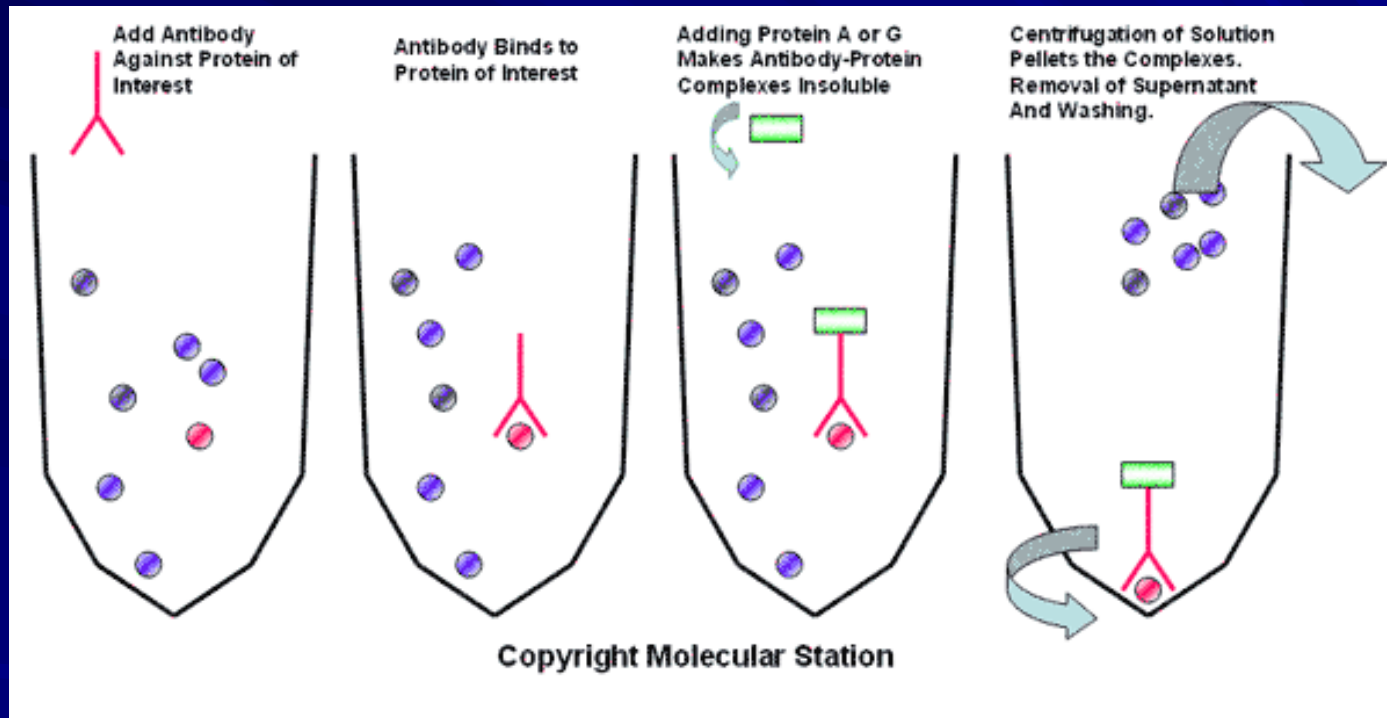

# $\beta$ -arrestin binds Dishevelled

Flag-Dvl3 constructs

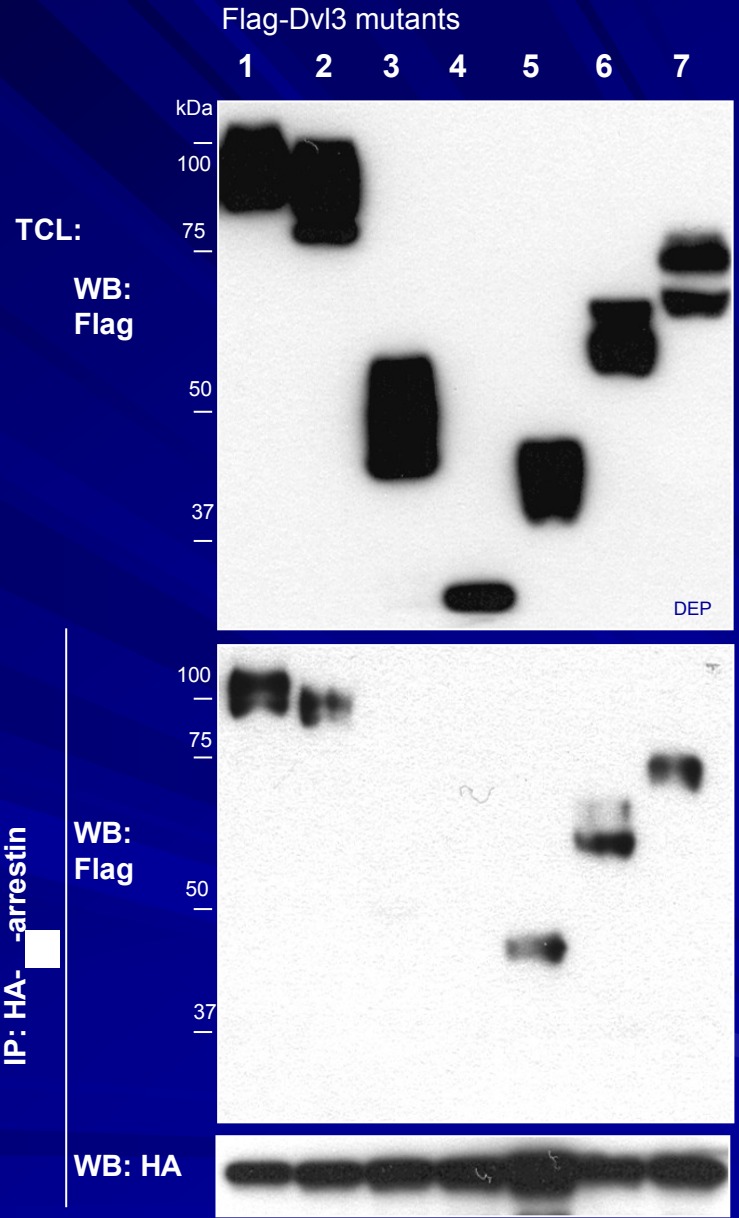
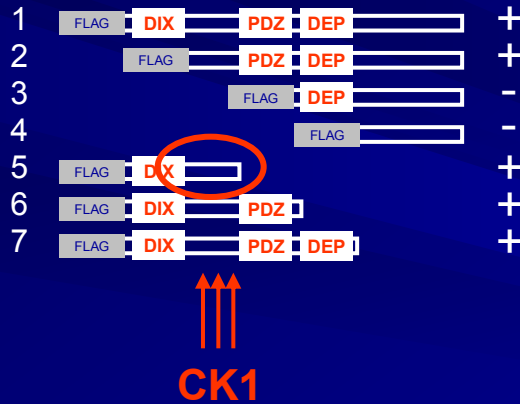

# Metoda 3: Immunocytochemie

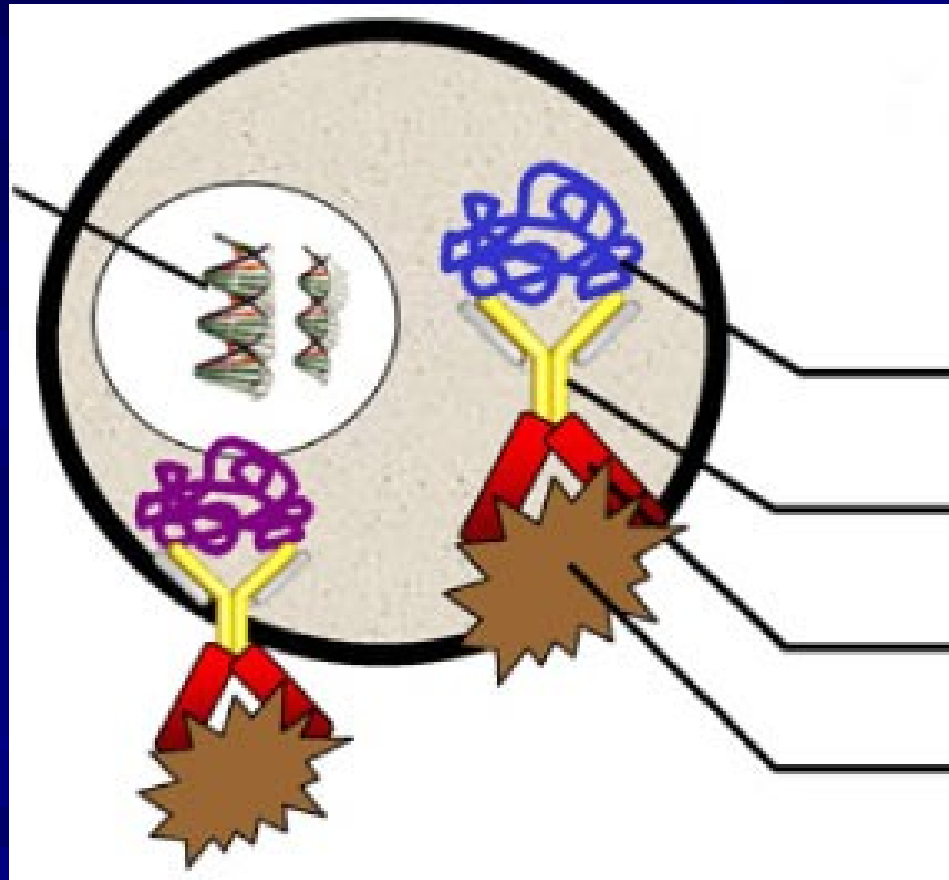

# Fluorescenční proteiny

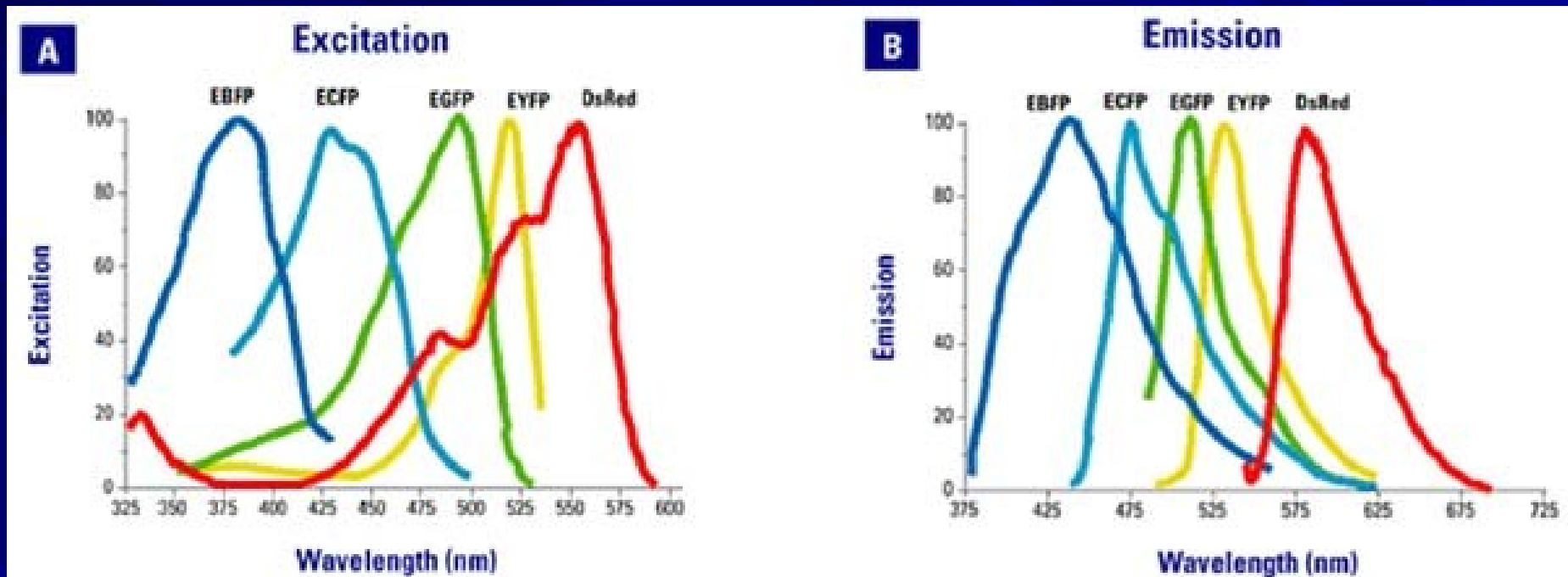

# $\beta$ -arrestin co-localizes with Dvl in the cytoplasm

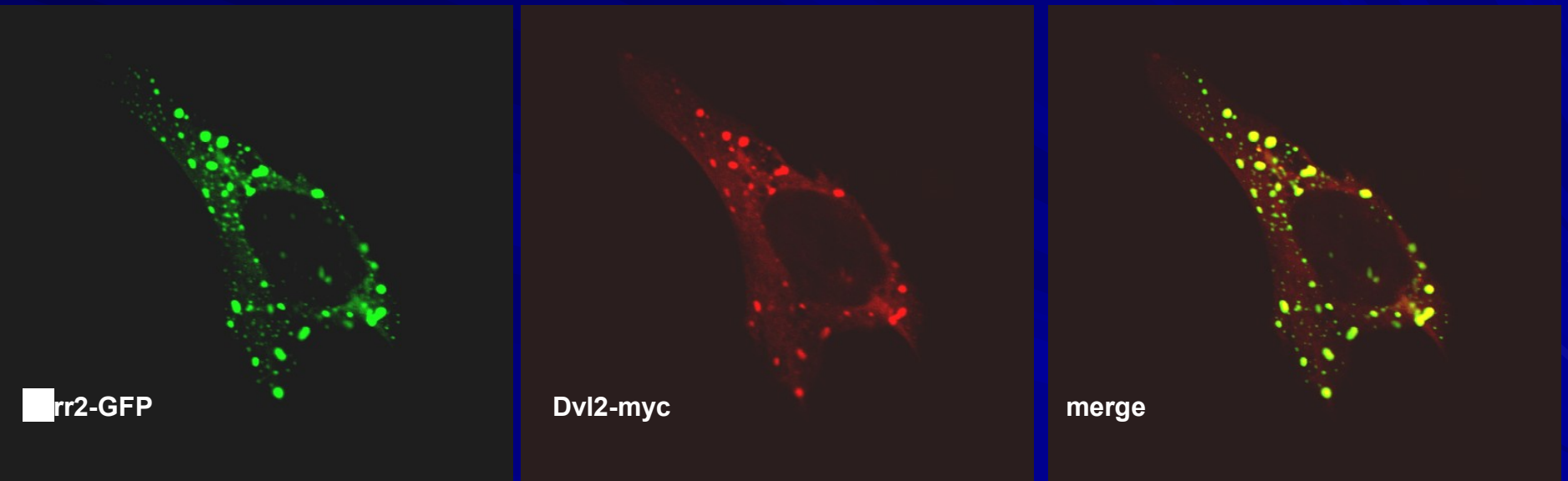

# Metoda 4: Reportérové eseje

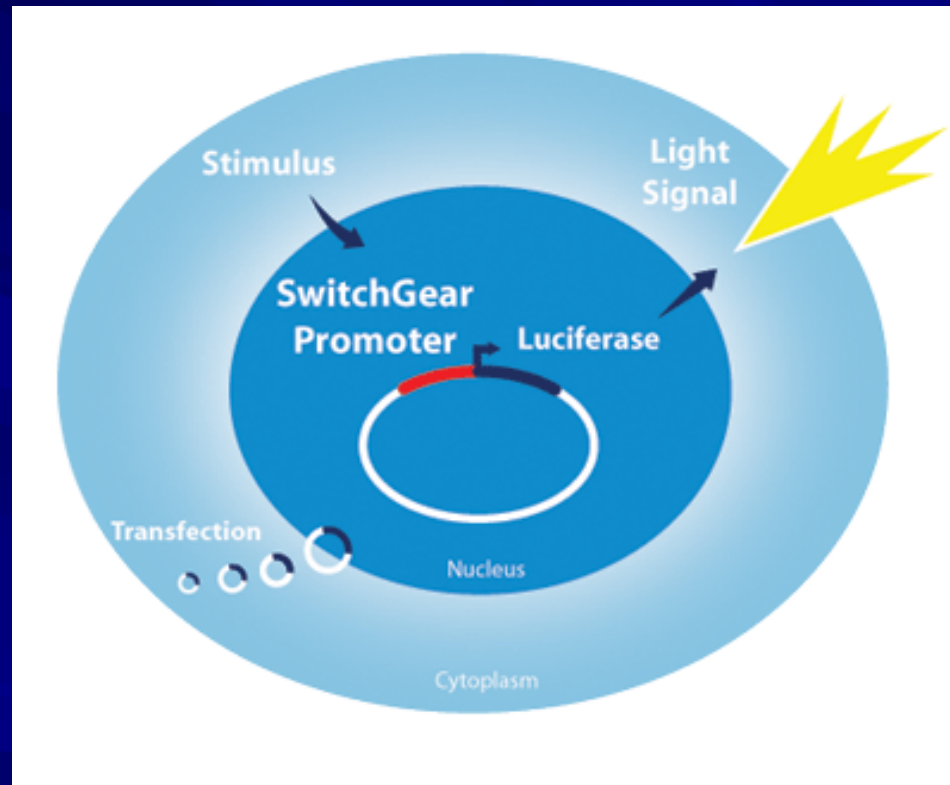

**1.  $\beta$ -arrestin is required for  $\beta$ -catenin activation in vitro**

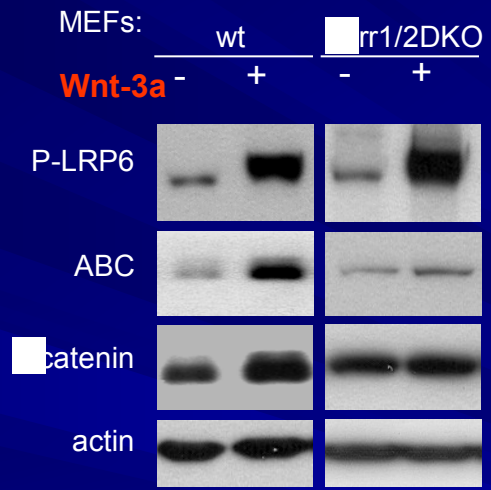
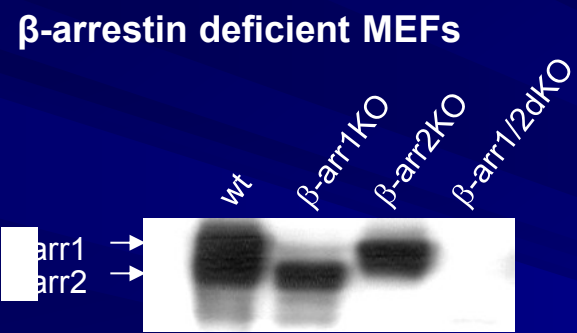

**TopFlash reporter -  $\beta$ -catenin transcriptional activity**

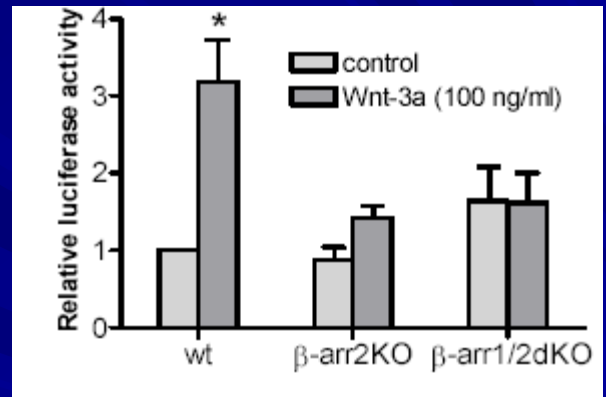

**Is this relevant for Wnt signal transduction in vivo?**

# Metoda č. 5: Analýza in vivo - drápatka

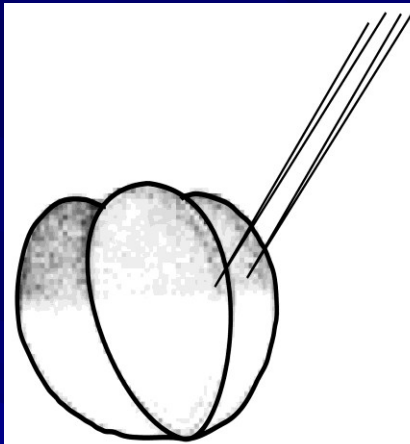

injection in 4-cell stage embryo  
targets Dorsal Marginal Zone  
affects primary axis formation (ventralization) and CE movements  
Figures 2, 3, and Suppl Figure 1

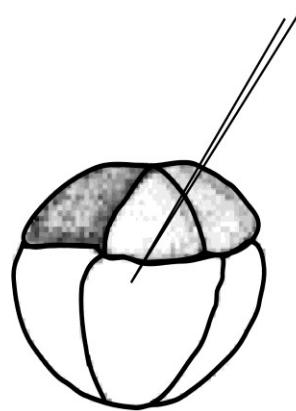

injection in 8-cell stage embryo  
targets presumptive cardiac mesoderm  
affects cardiac development, but avoids earlier effects on primary axis and CE  
Figure 4



# Is $\beta$ -arrestin important for the Wnt/ $\beta$ -catenin signalling in vivo?

$\beta$ -arrestin knockdown in *Xenopus* (*axis duplication assay*):

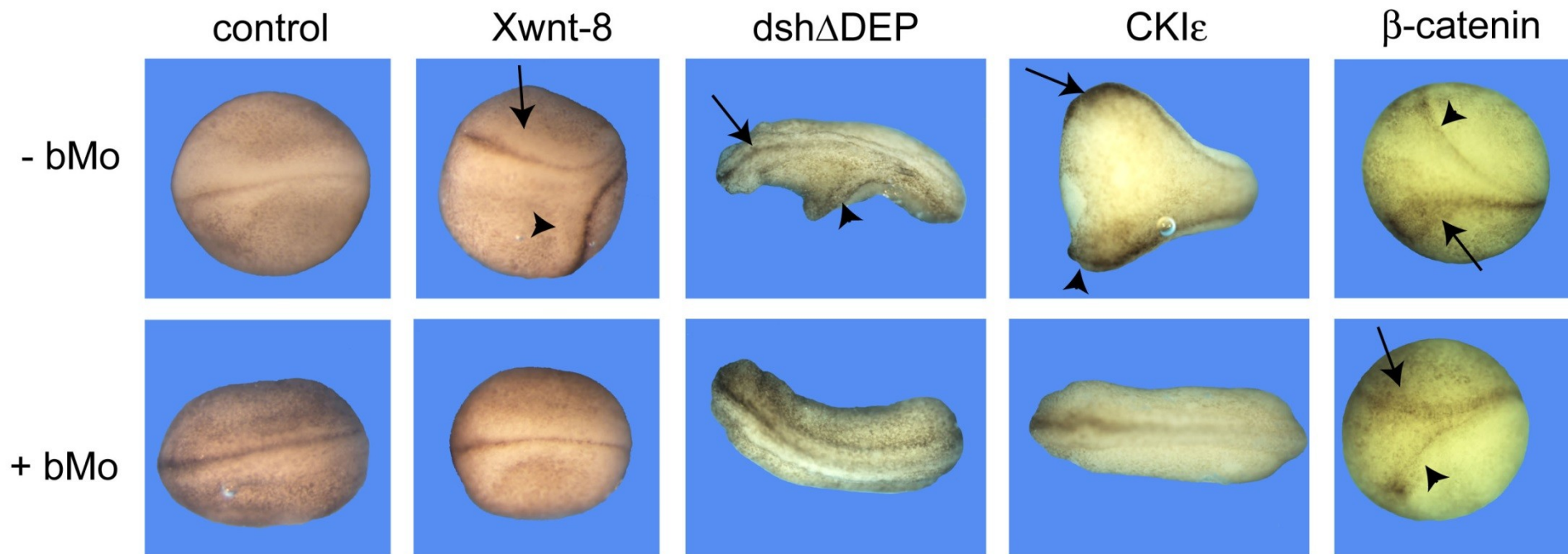

# Keller explants (Xenopus)

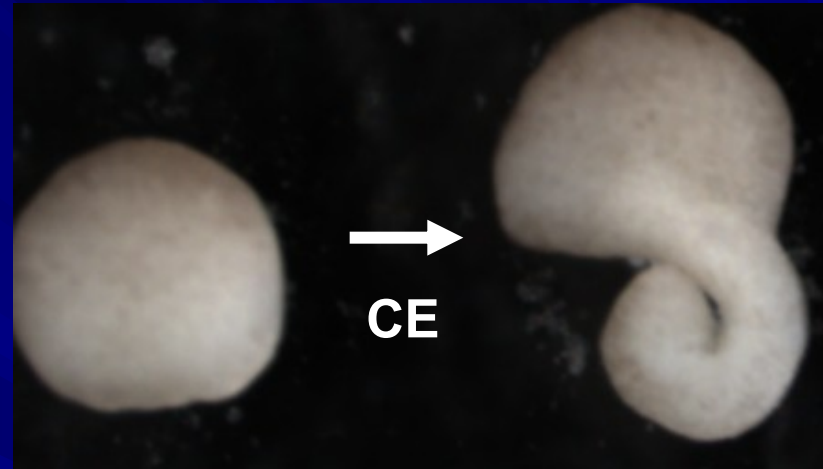
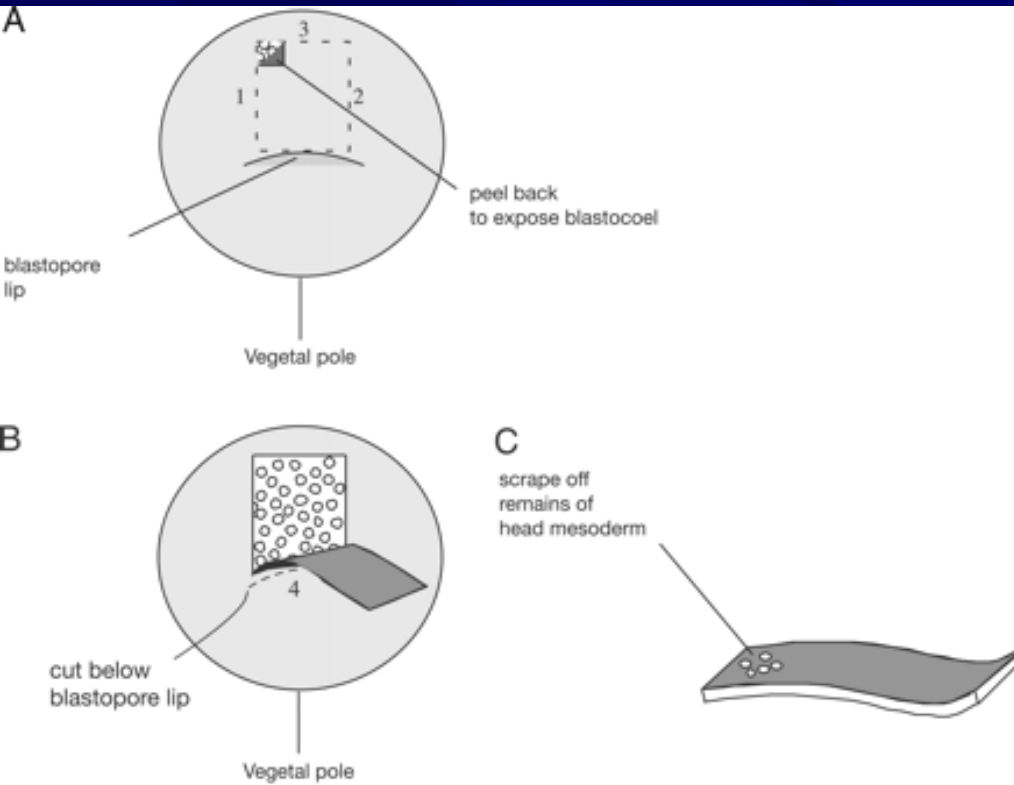

$\beta$ -arrestin regulates convergent extension movements in vivo

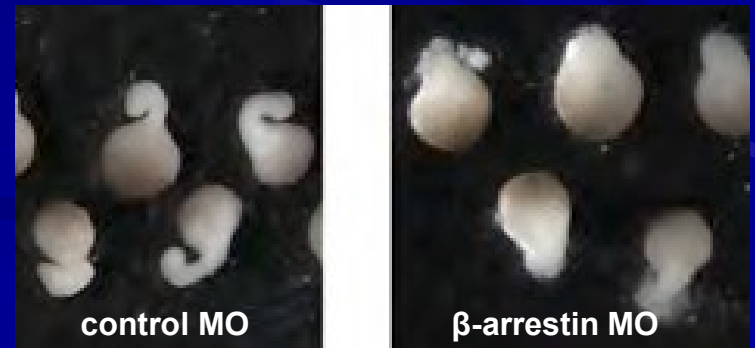

# Metody č. 6: Genetické modifikace myši

# Transgenní myš

Nobelova cena 2007

**Mario R. Capecchi,**  
**Martin J. Evans** and  
**Oliver Smithies**

za

„principles for  
introducing specific  
gene modifications in  
mice by the use of  
embryonic stem cells“

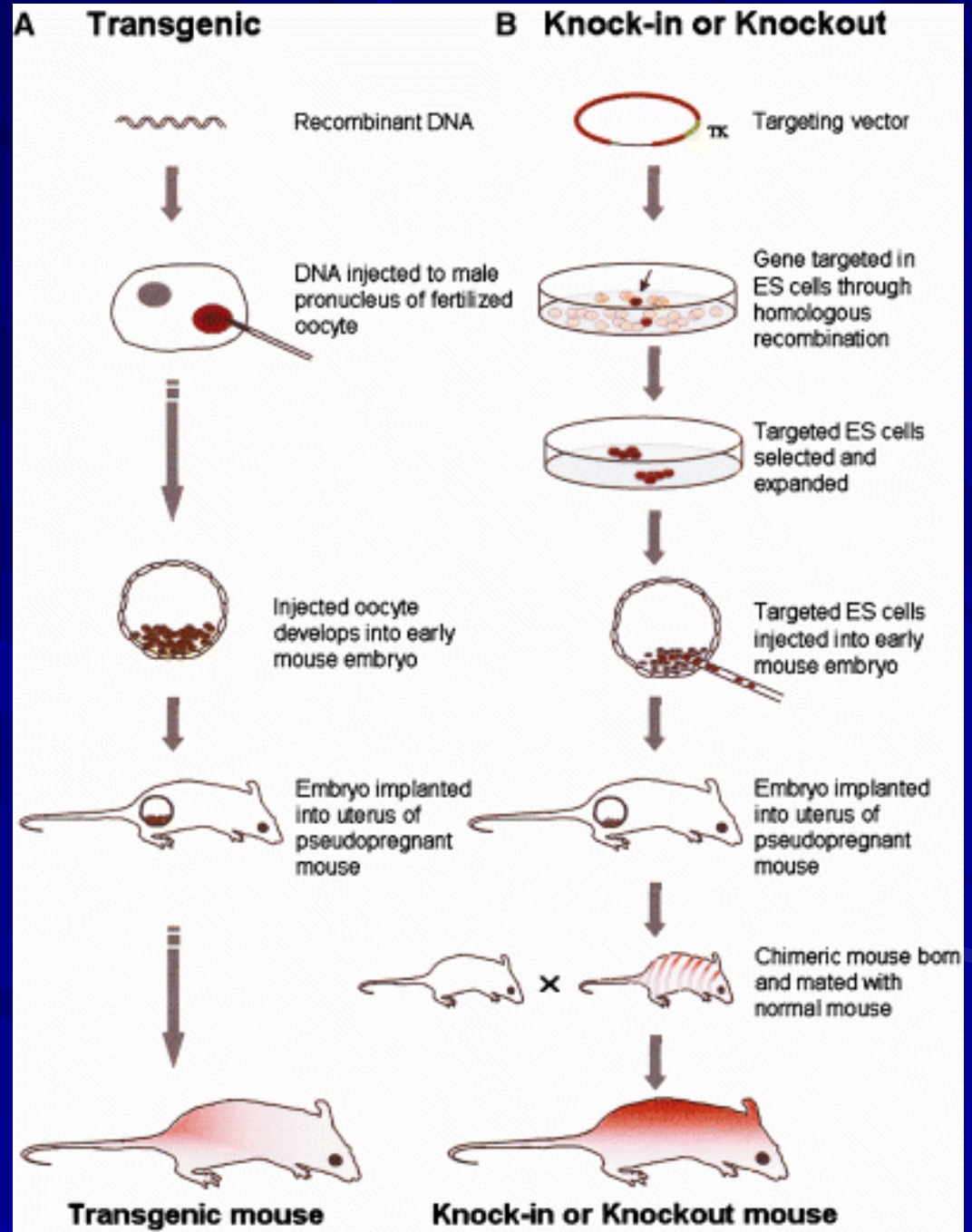

# Lrp6 KO embryos display exencephaly....

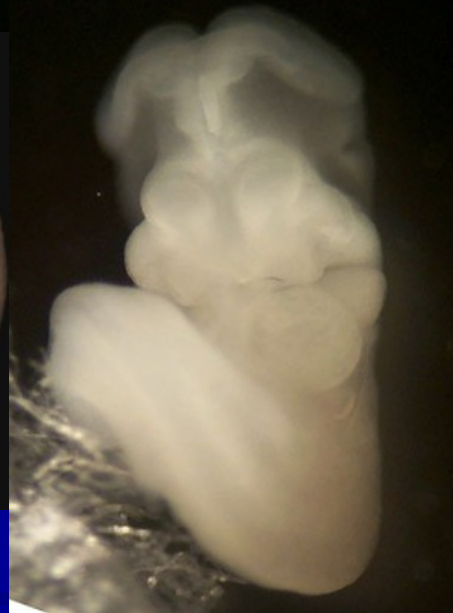
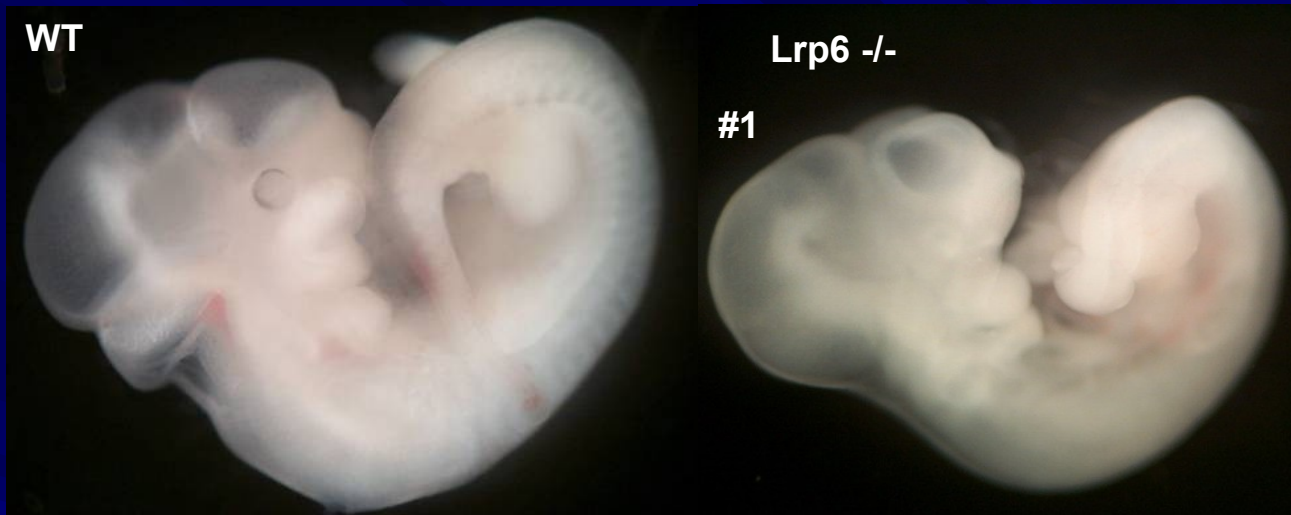

....which is rescued by loss of Wnt5a

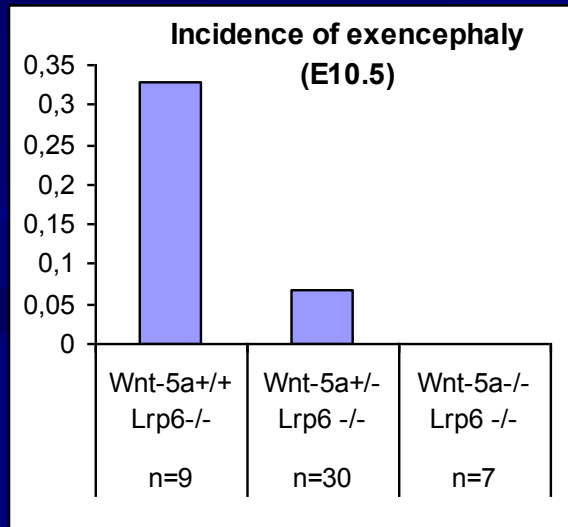

# Metody č. 7: Afinity purifikace a hmotnostní spektroskopie

# Afinitní purifikace

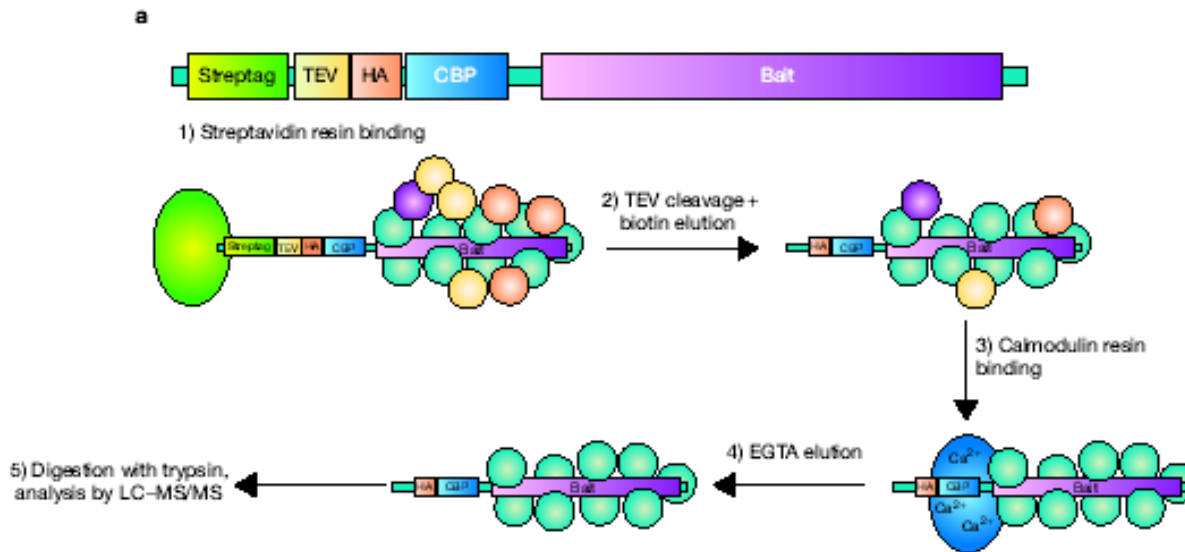

**b**

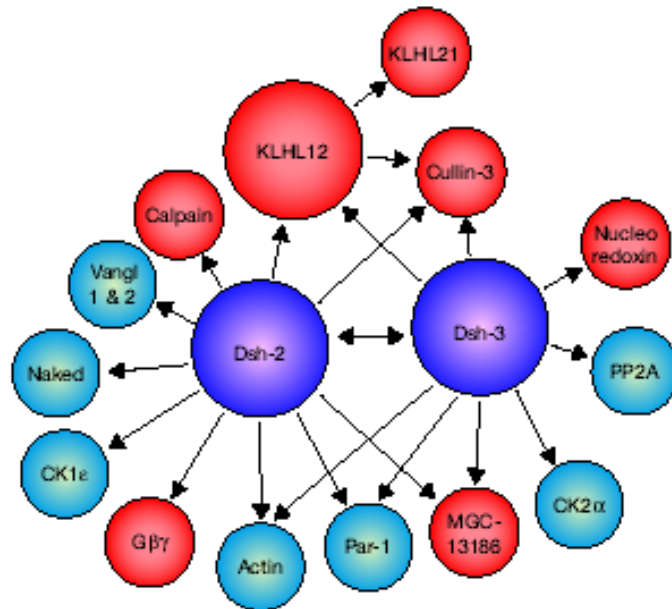

pGlue  
pGlue-Dvl2  
pGlue-Dvl3

Dvl2

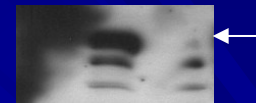

Dvl3

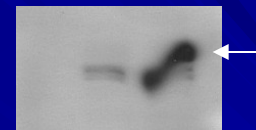

# Hmotnostní spektroskopie (Mass Spec)

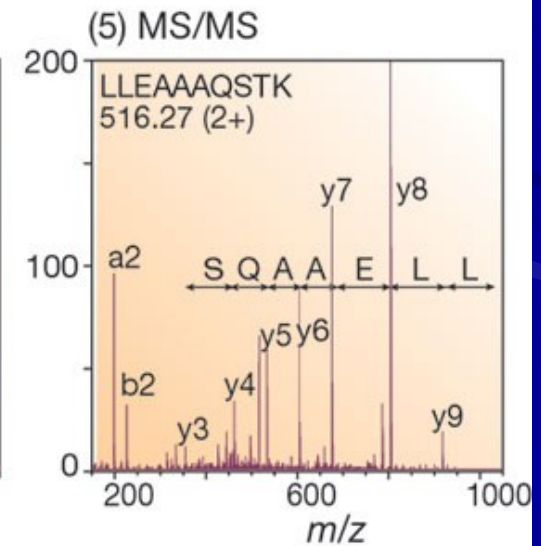
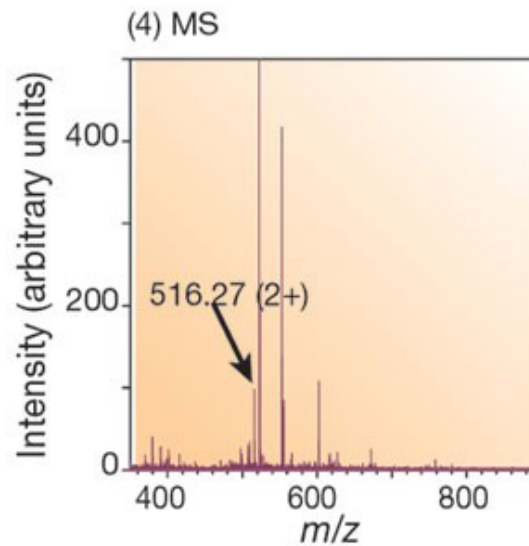
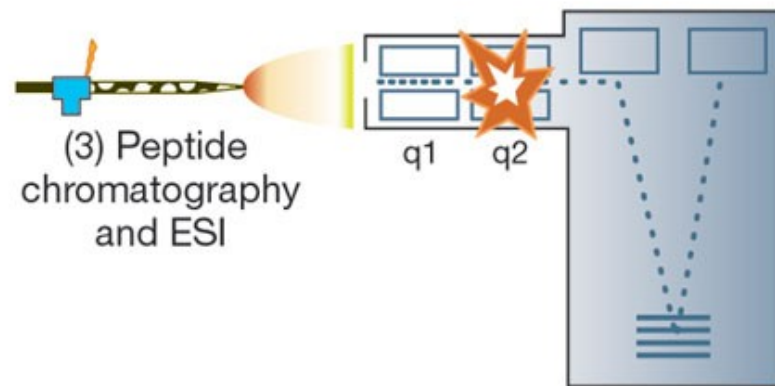
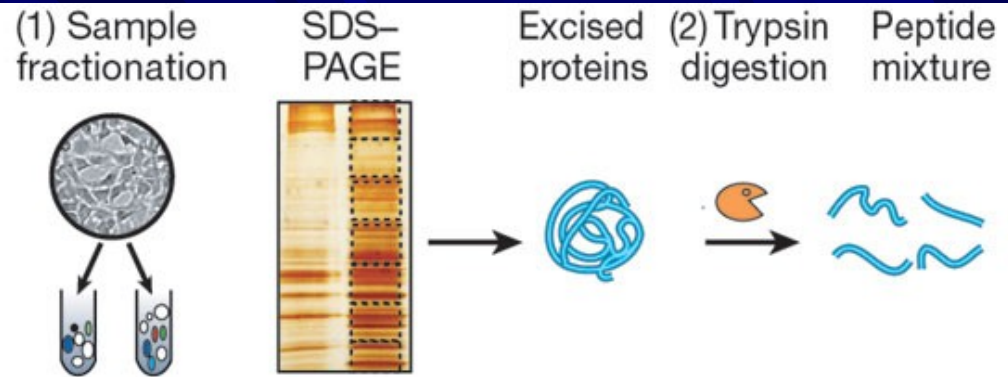



# Děkuji za pozornost!

Celogenomové  
techniky

Molekulární  
mechanismus

Celoproteomové  
techniky

