

Šíření signálů a synapse

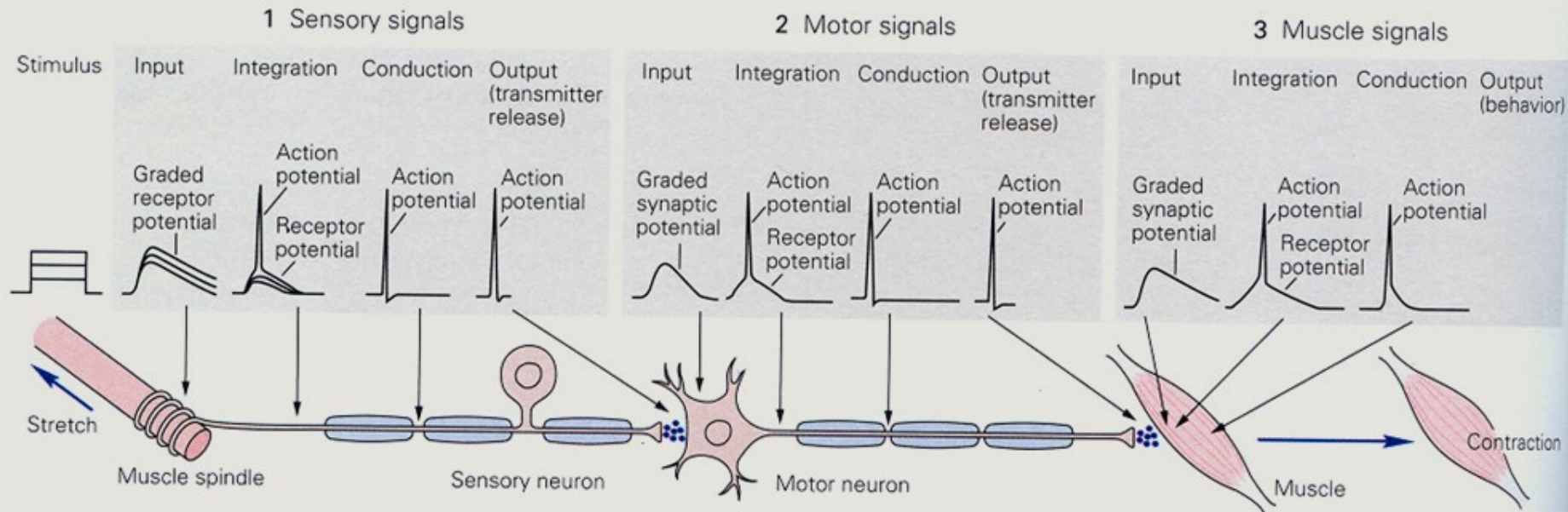

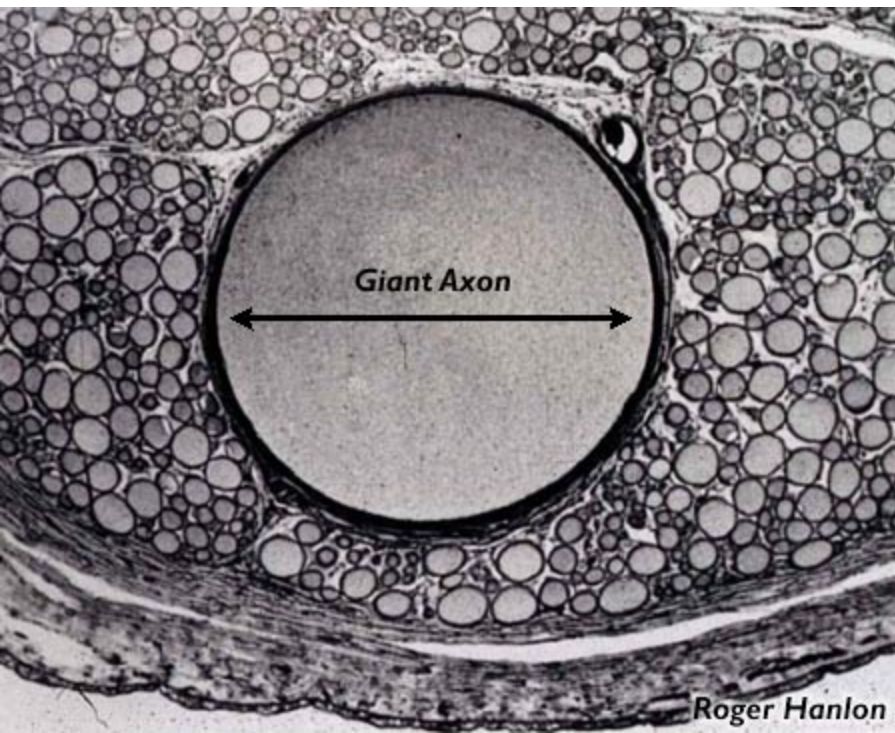

Roger Hanlon

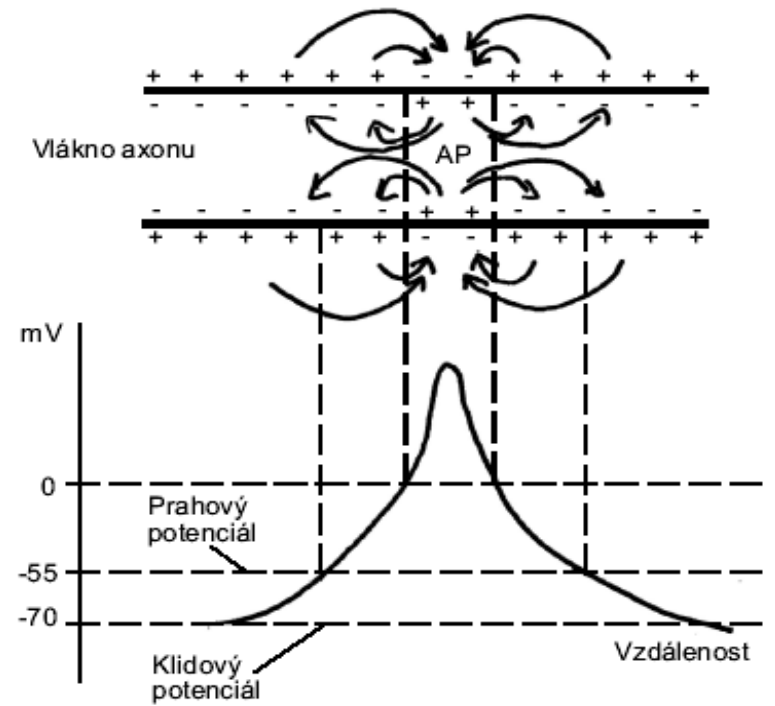

Obr. 4.6. Šíření akčního potenciálu (AP). Jestliže je jedno místo excitabilní membrány depolarizováno, podélné iontové toky (šipky) vyvolají rozšíření depolarizace i do bezprostředního okolí. Nové AP mohou vznikat všude, kde byl překročen prahový potenciál. Děj se opakuje a vlna vznikajících depolarizací se šíří podél membrány.



Synapse

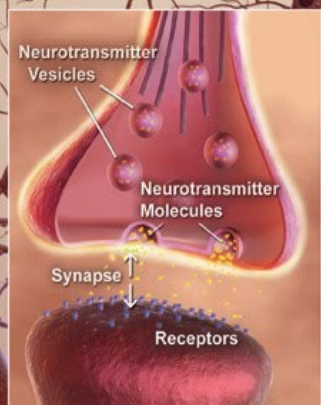

Axons

Dendrites

Neuron

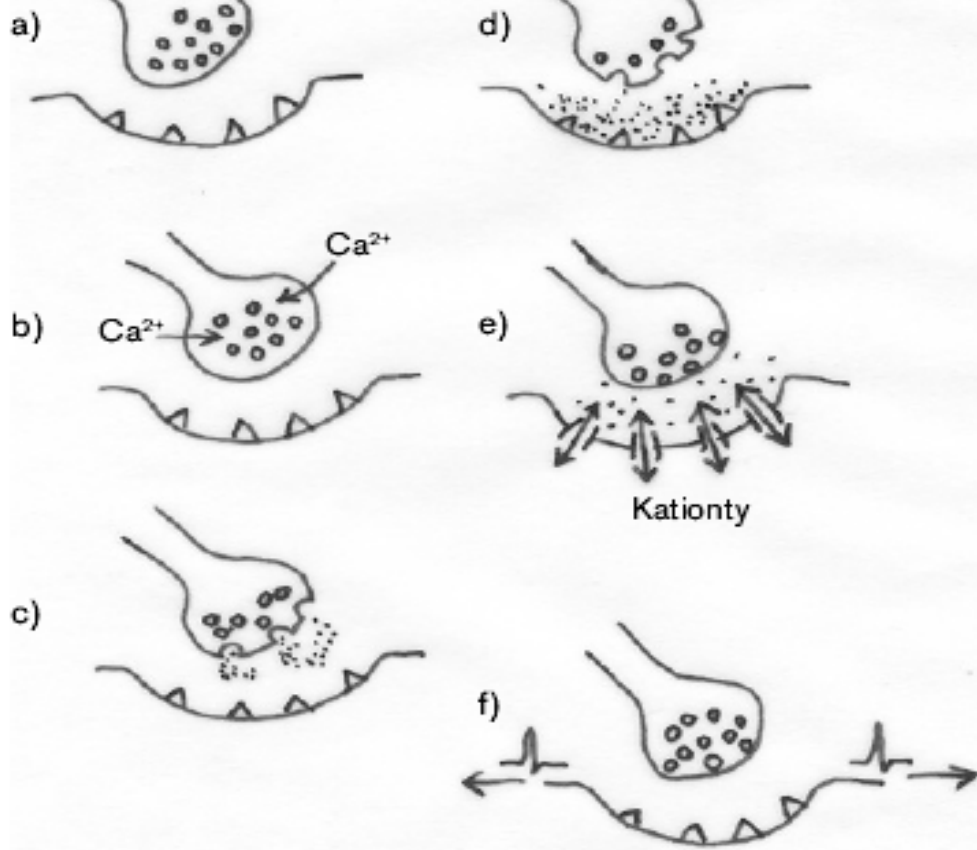

Obř. 4.7. Sekvence dějů při předání akčního potenciálu (AP) prostřednictvím mediátoru na chemické synapsi. a) přicházející AP depolarizuje synaptický knoflík, b) otevírají se vápníkové kanály a Ca^{2+} proudí do nitra knoflíku, c) to vyvolá exocytózu granul s mediátorem, d) mediátor se váže na receptory postsynaptické membrány, e) následuje otevření kanálů pro kationty a jejich vtok způsobí místní depolarizaci, f) na napěťově citlivém okolí synapse mohou vzniknout nové AP.

Synapse

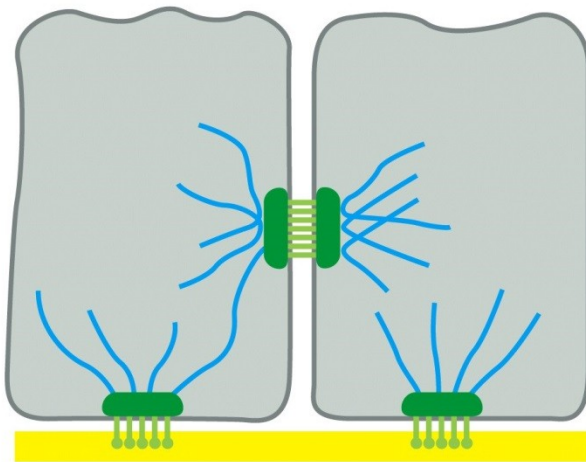

**ANCHORING
JUNCTIONS**

Figure 19-2a Molecular Biology of the Cell 5/e (© Garland Science 2008)

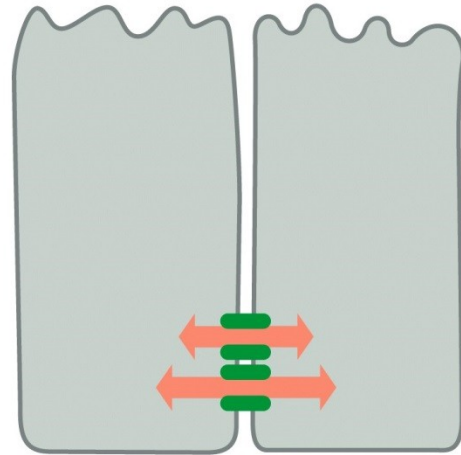

**CHANNEL-FORMING
JUNCTIONS**

Figure 19-2c Molecular Biology of the Cell 5/e (© Garland Science 2008)

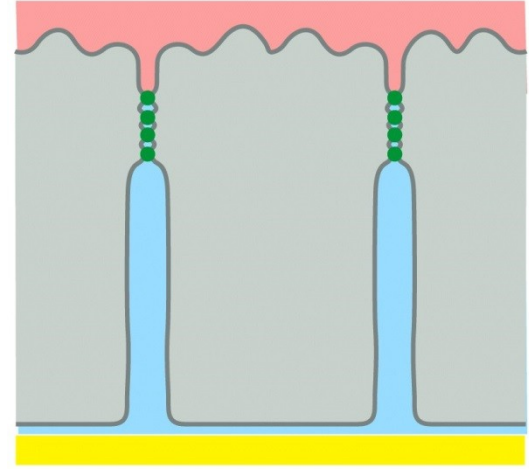

**OCCUDING
JUNCTIONS**

Figure 19-2b Molecular Biology of the Cell 5/e (© Garland Science 2008)

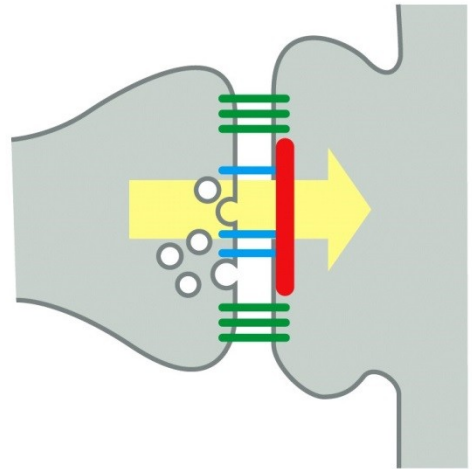

**SIGNAL-RELAYING
JUNCTIONS**

Figure 19-2d Molecular Biology of the Cell 5/e (© Garland Science 2008)

The Nobel Prize in Physiology or Medicine 1970



"for their discoveries concerning the humoral transmitters in the nerve terminals and the mechanism for their storage, release and inactivation"



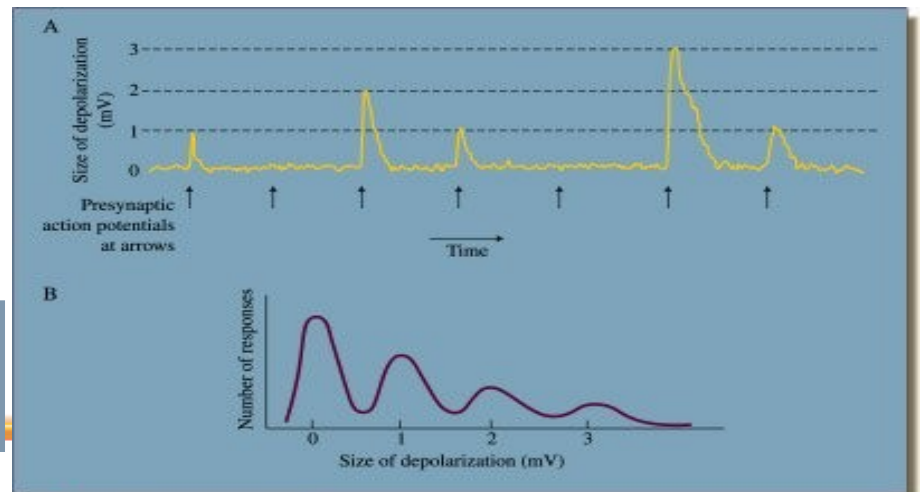
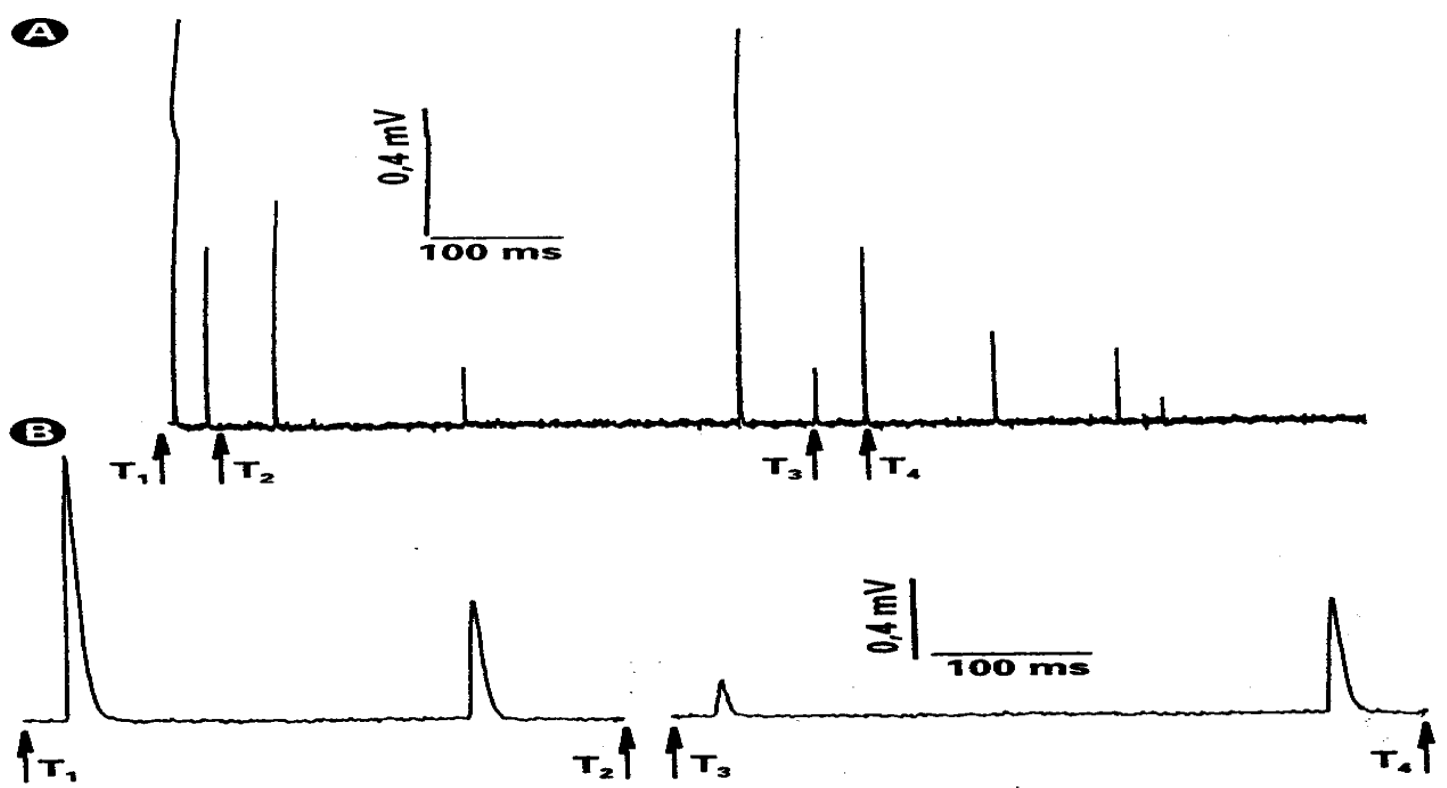

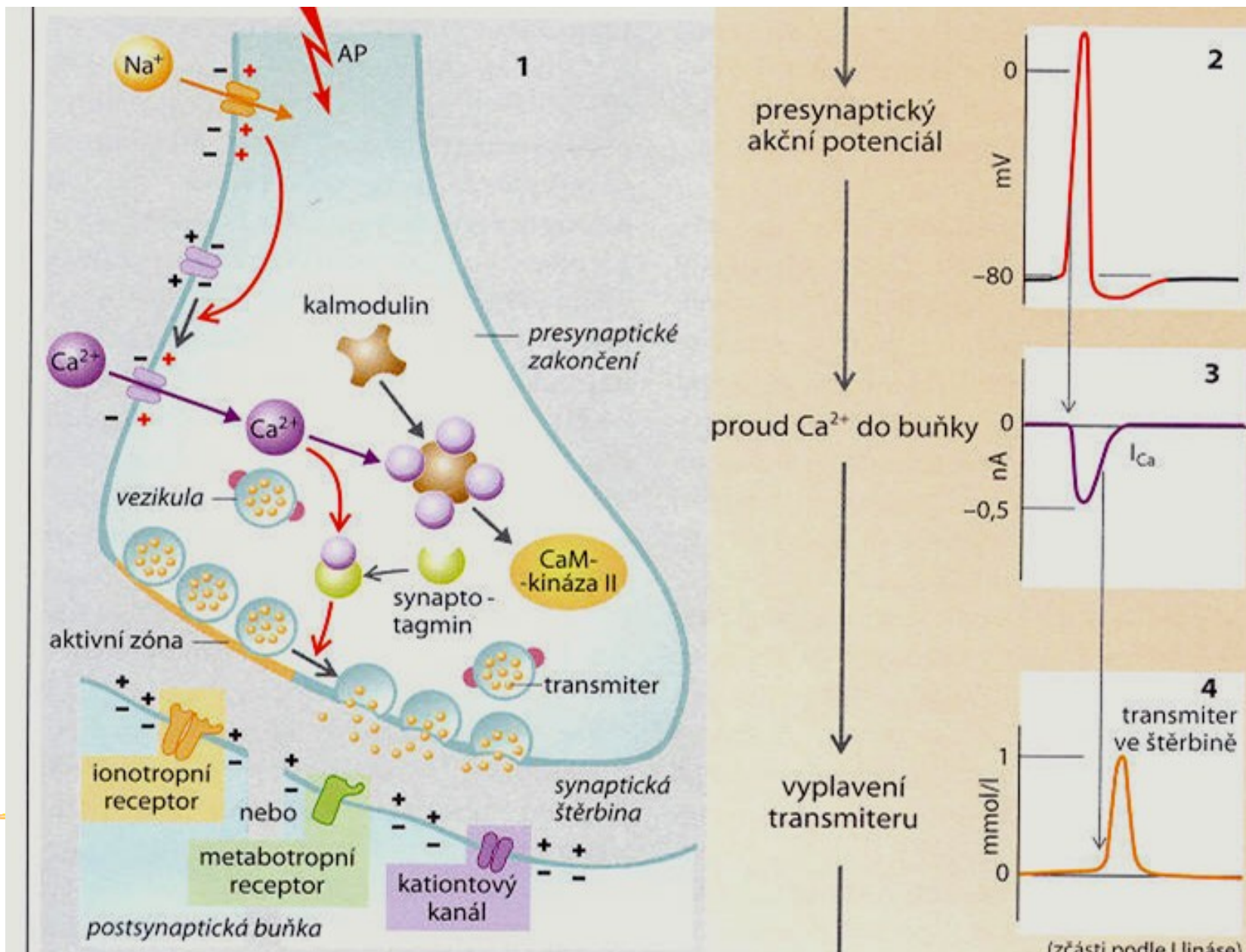

Synapsin = znovuhromadění v aktivní zóně

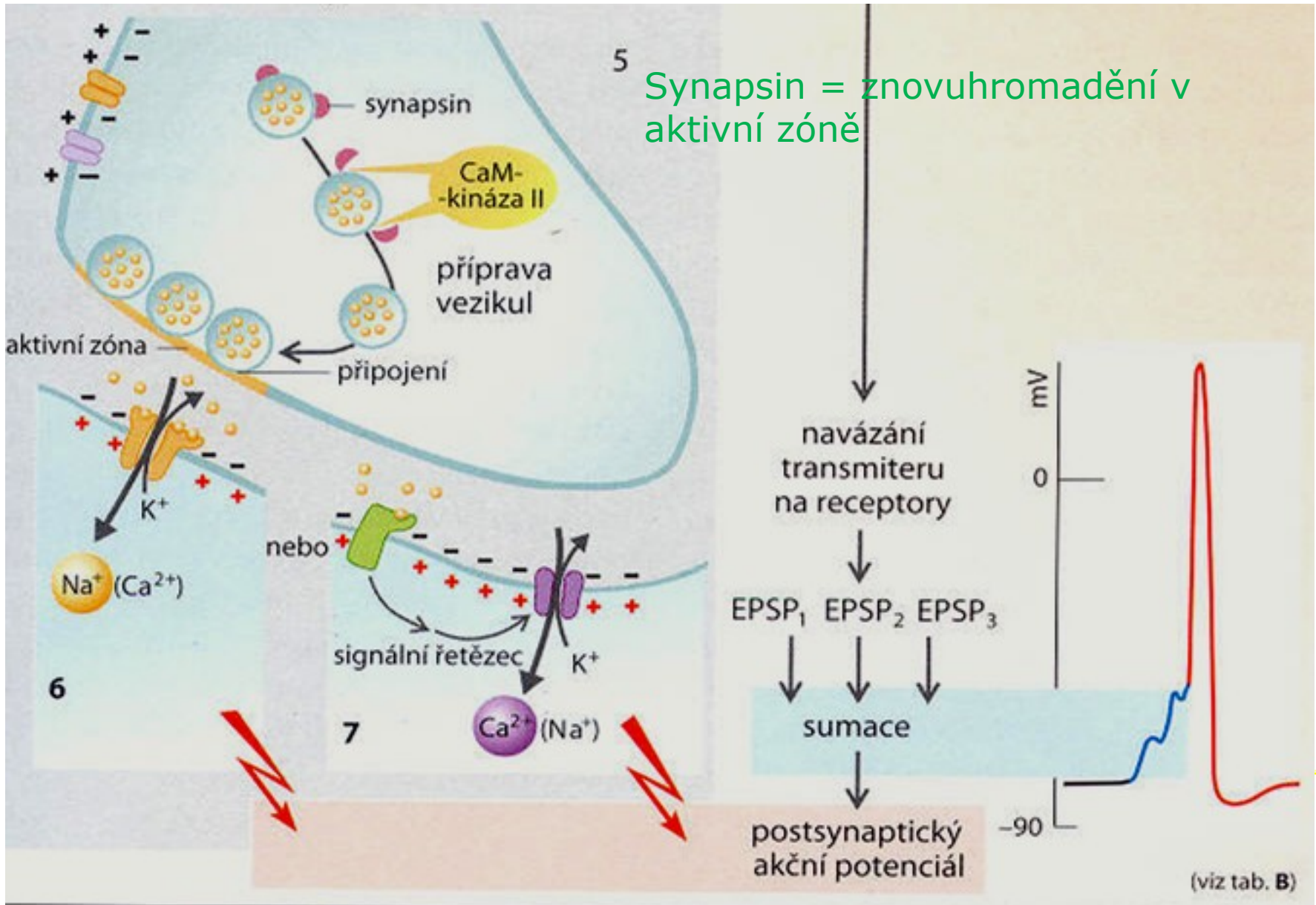

(a) Overview of vesicle recycling

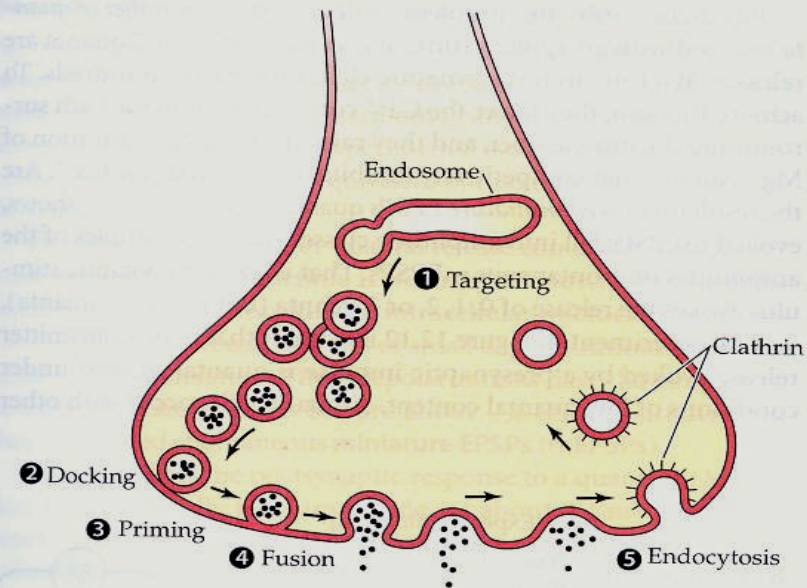

(b) Retrieval of the vesicular membrane

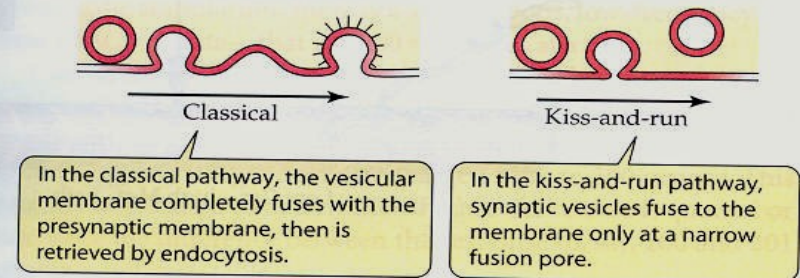

C. Receptory zprostředkovaná endocytóza

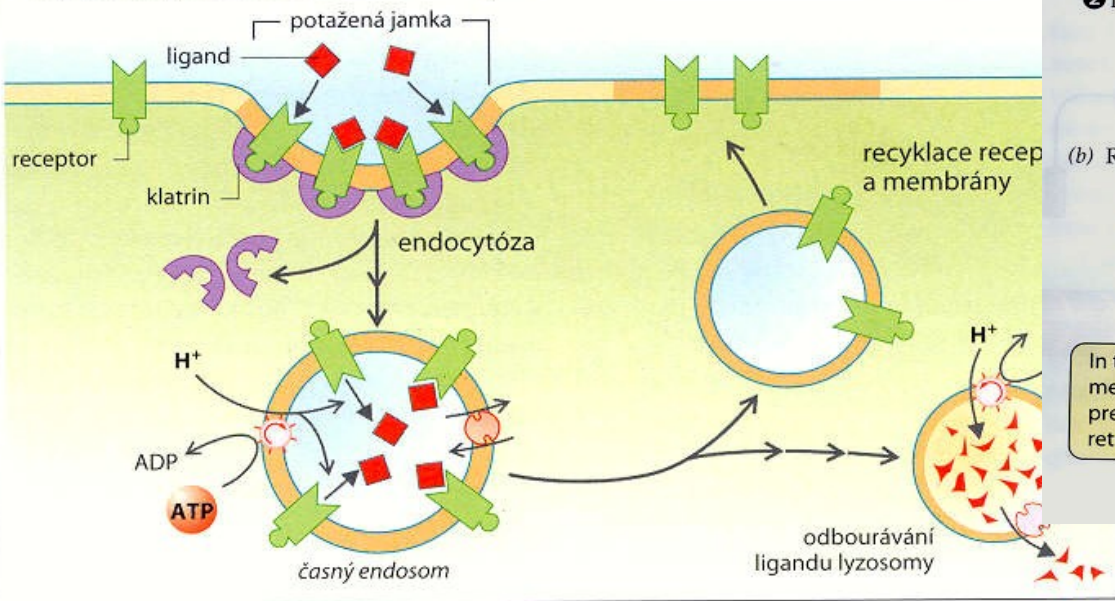

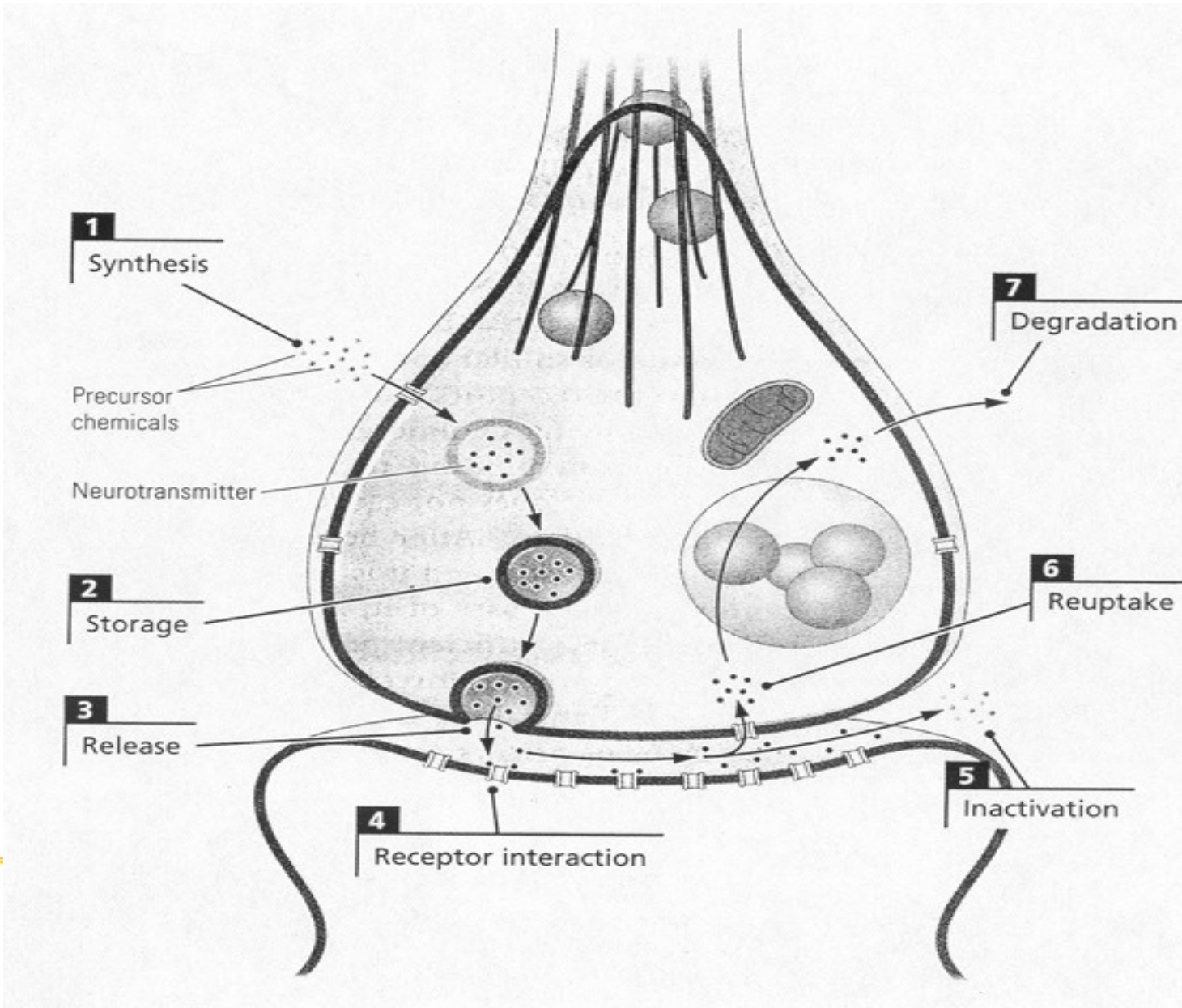

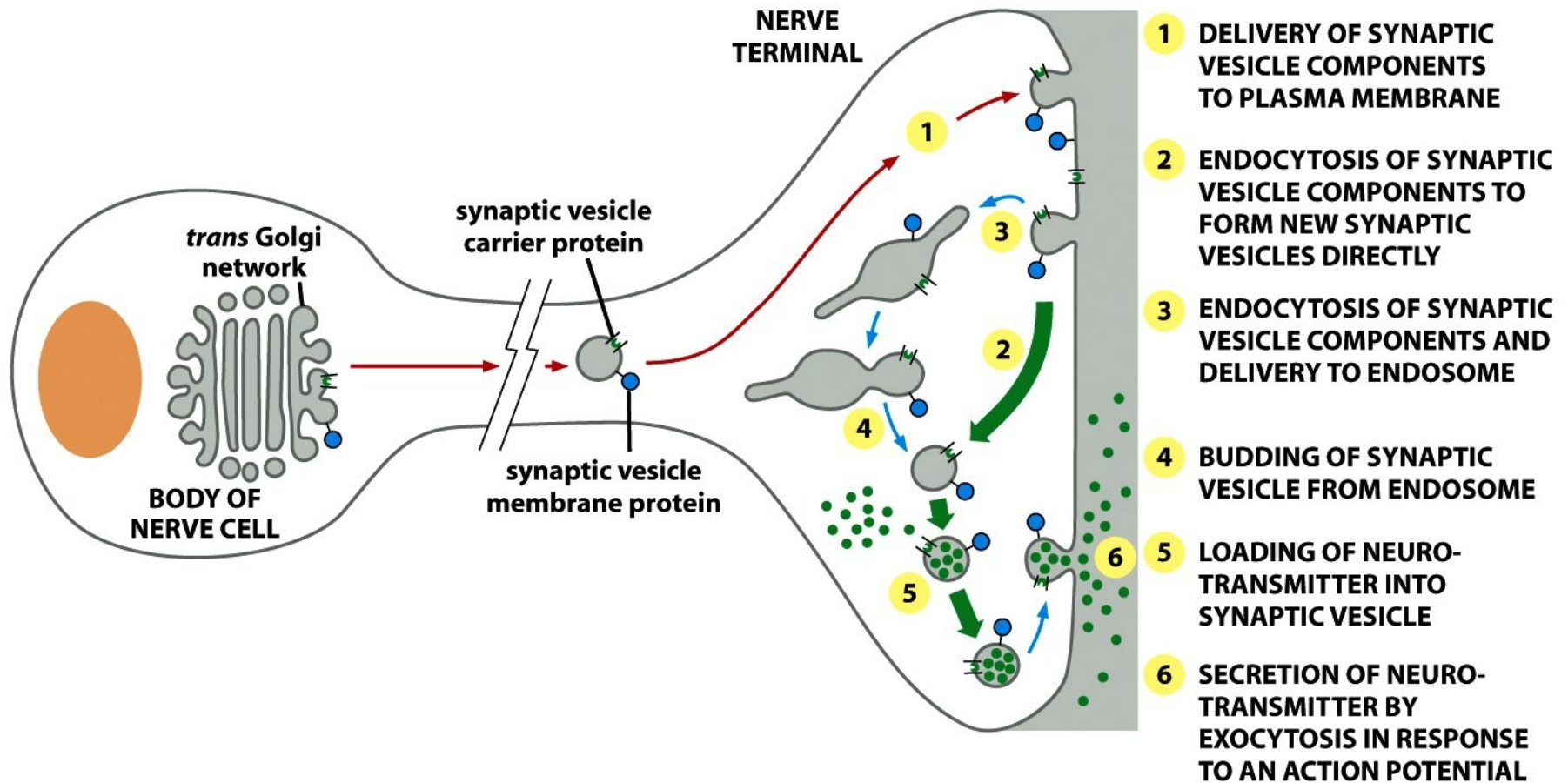

Figure 13-73 Molecular Biology of the Cell 5/e (© Garland Science 2008)

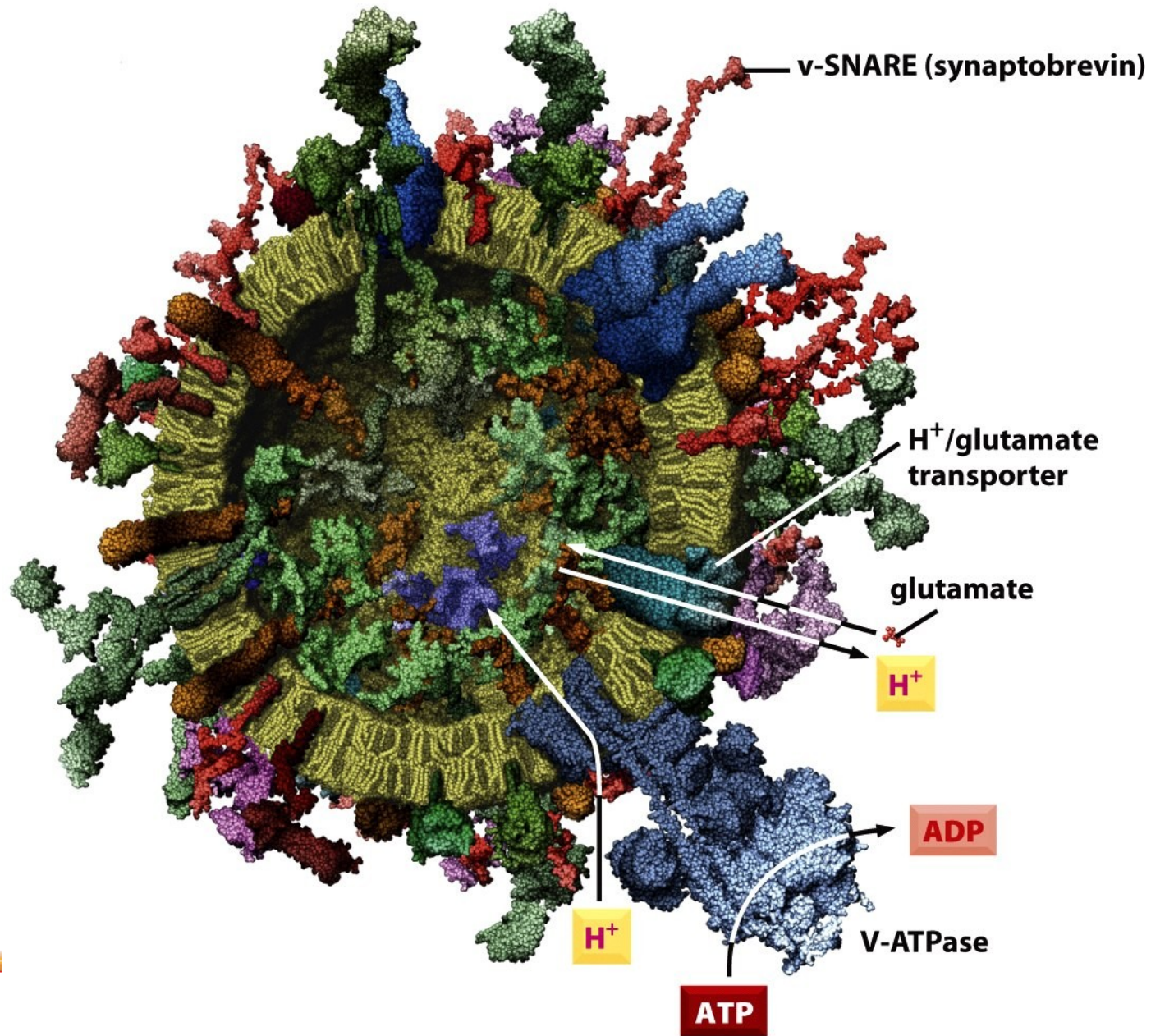
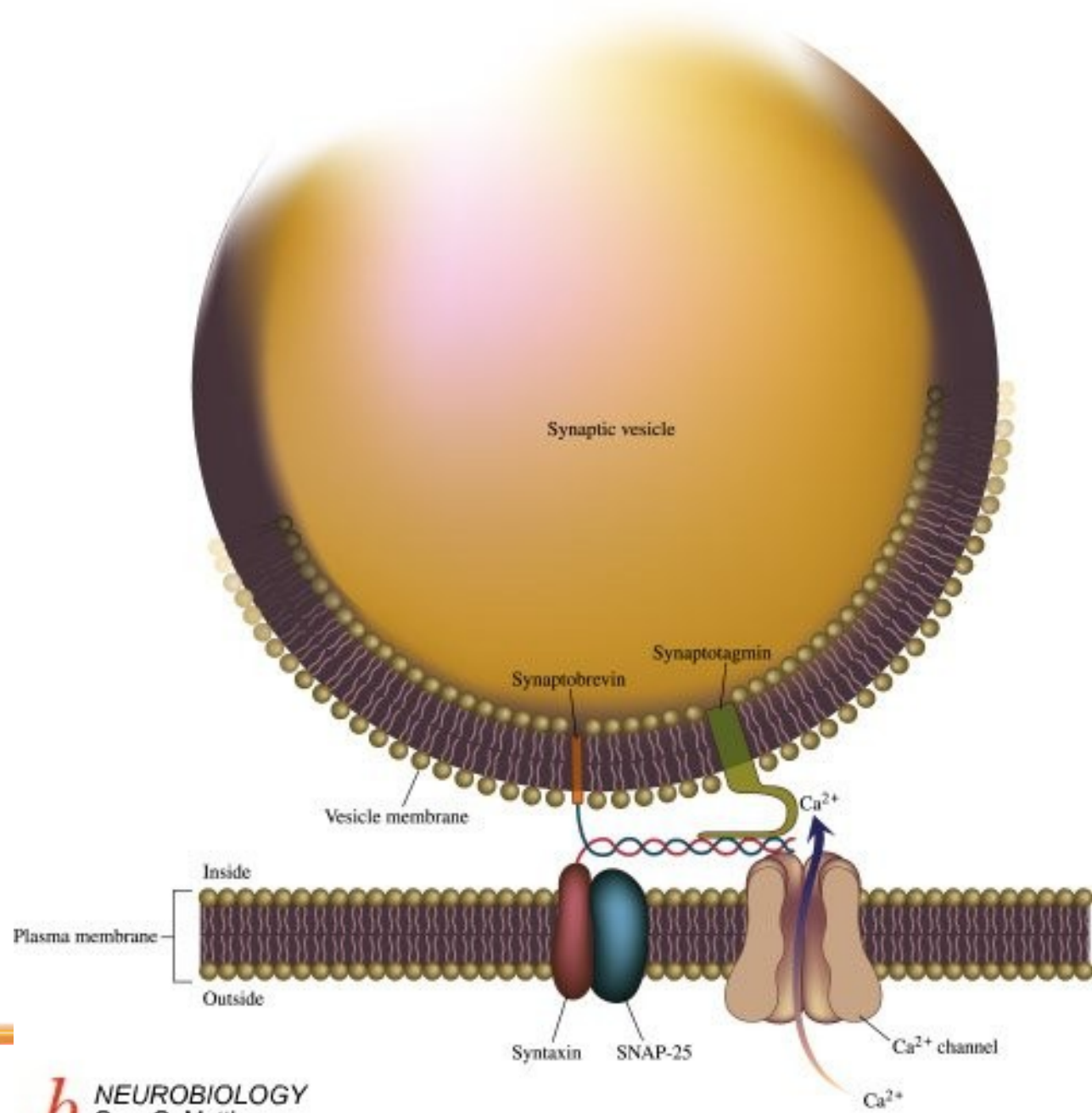
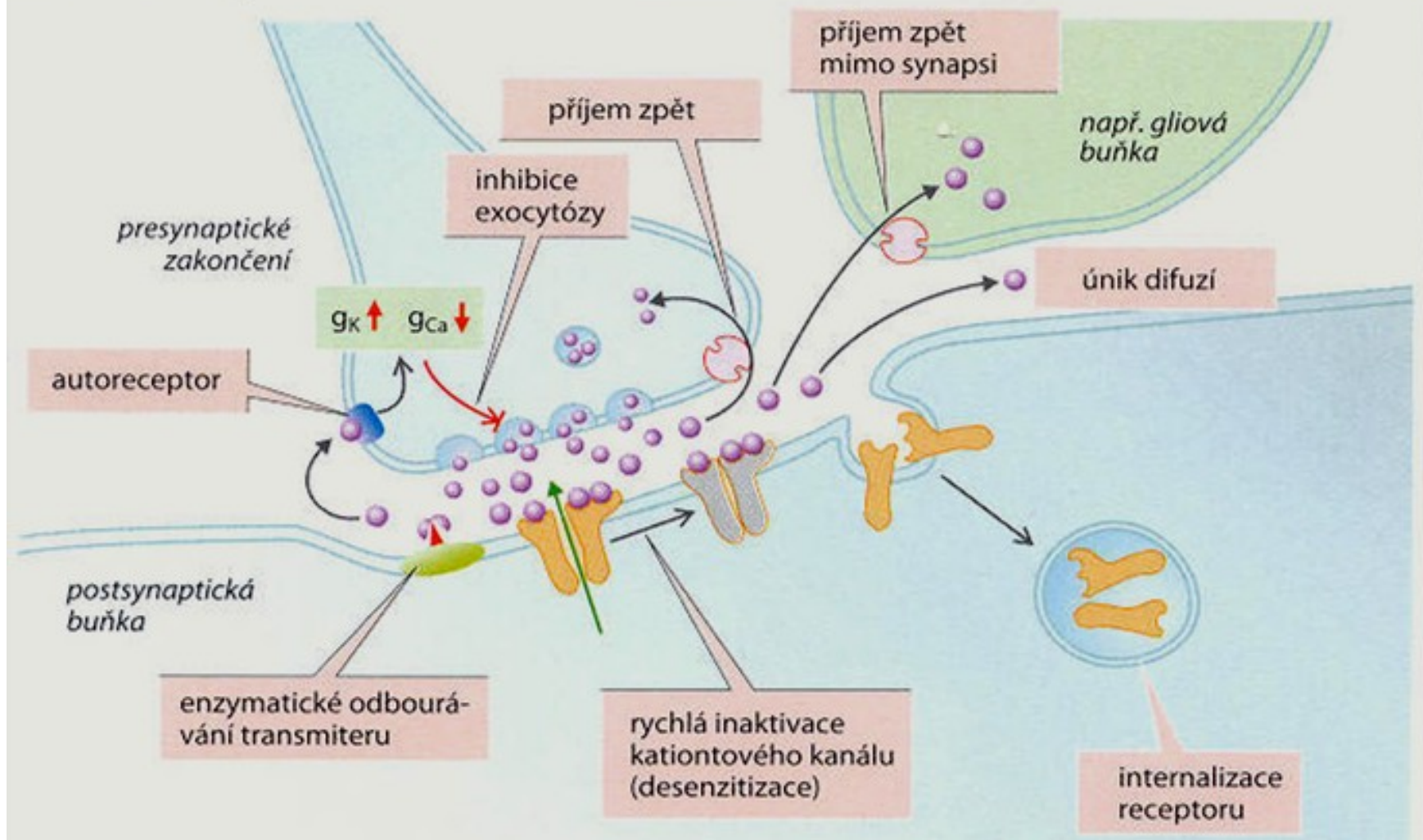
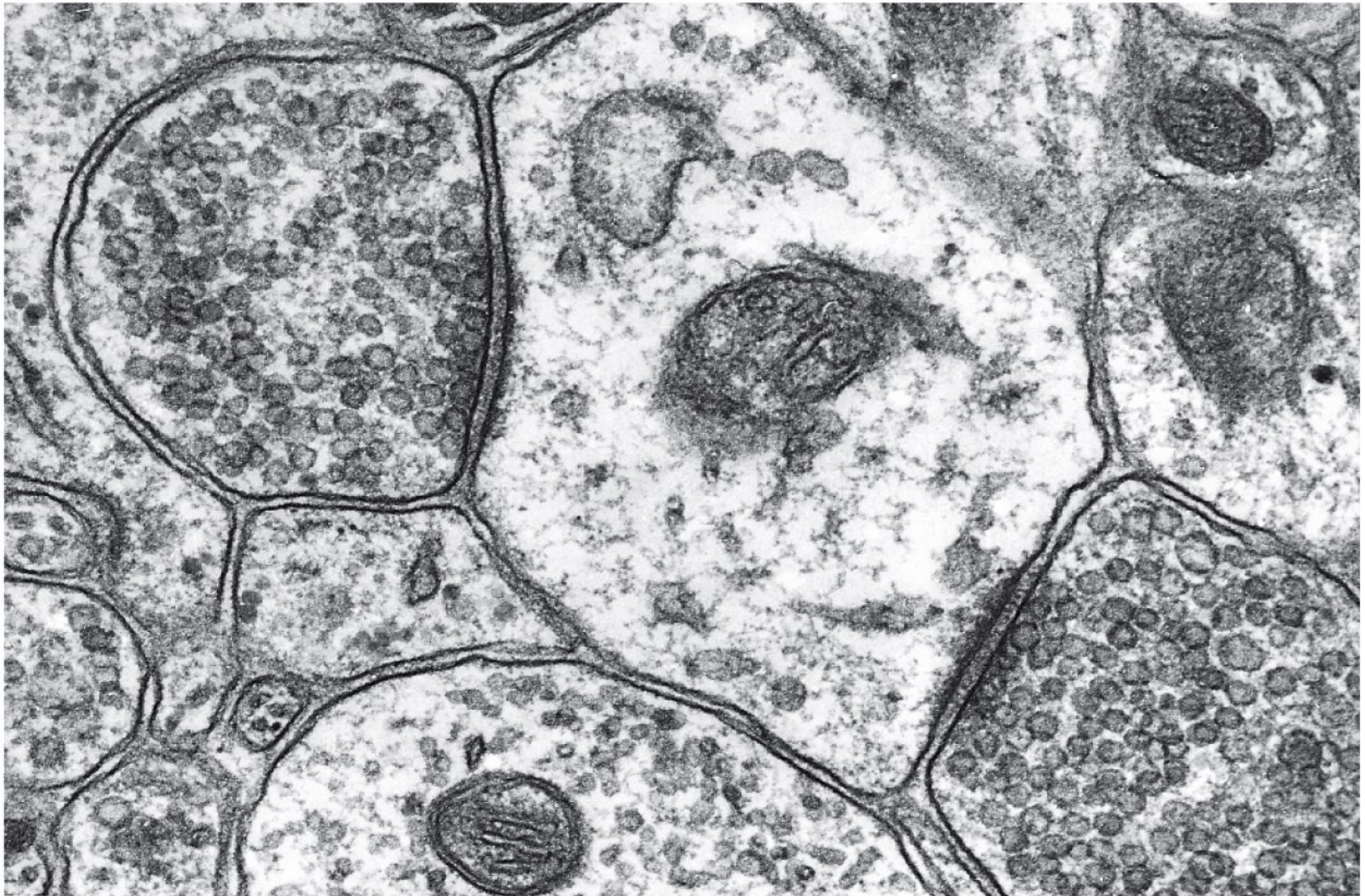

Figure 13-74 Molecular Biology of the Cell 5/e (© Garland Science 2008)



E. Ukončení působení transmiteru





2 μm

Figure 19-22a Molecular Biology of the Cell 5/e (© Garland Science 2008)

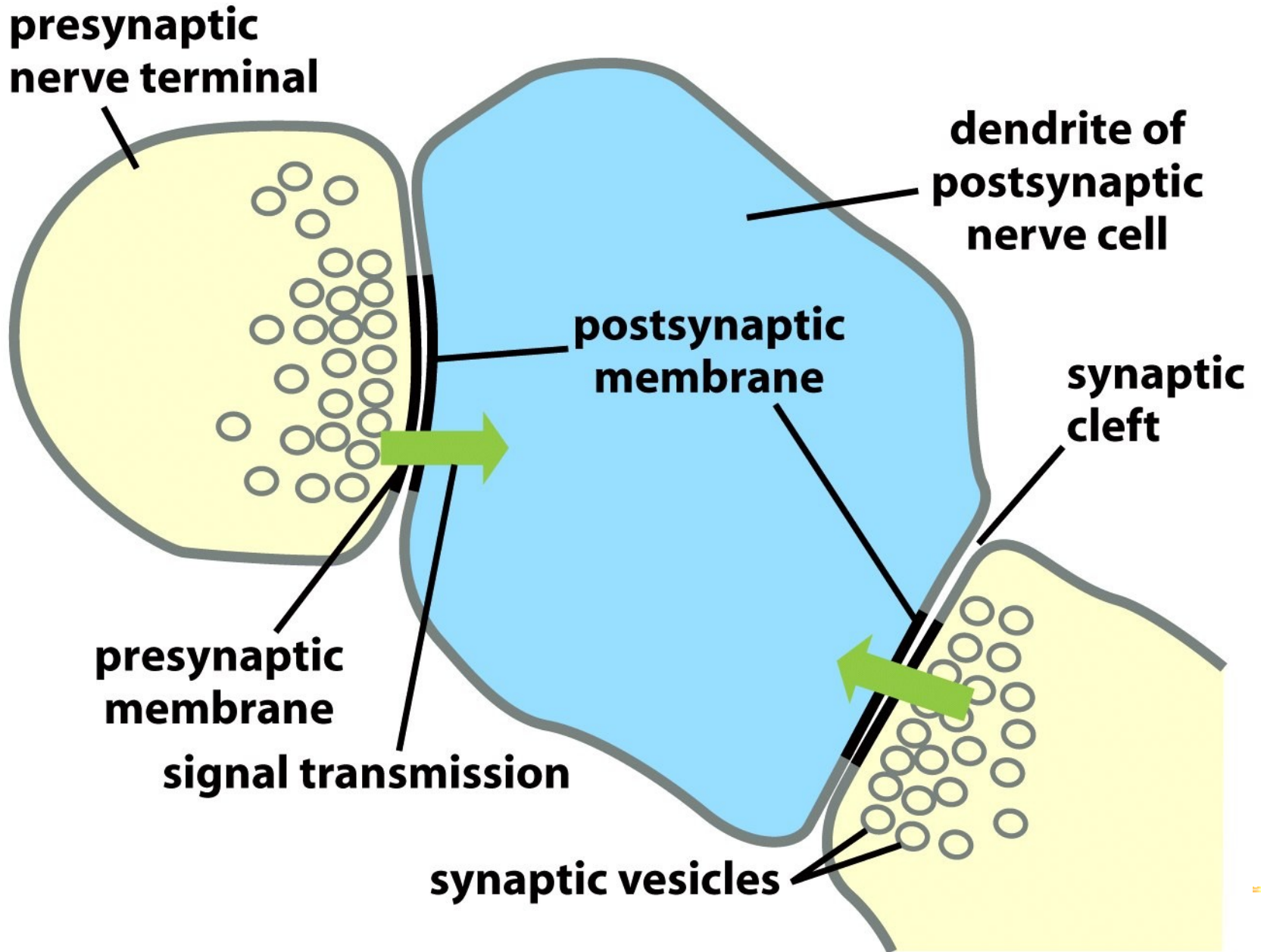

Figure 19-22b Molecular Biology of the Cell 5/e (© Garland Science 2008)

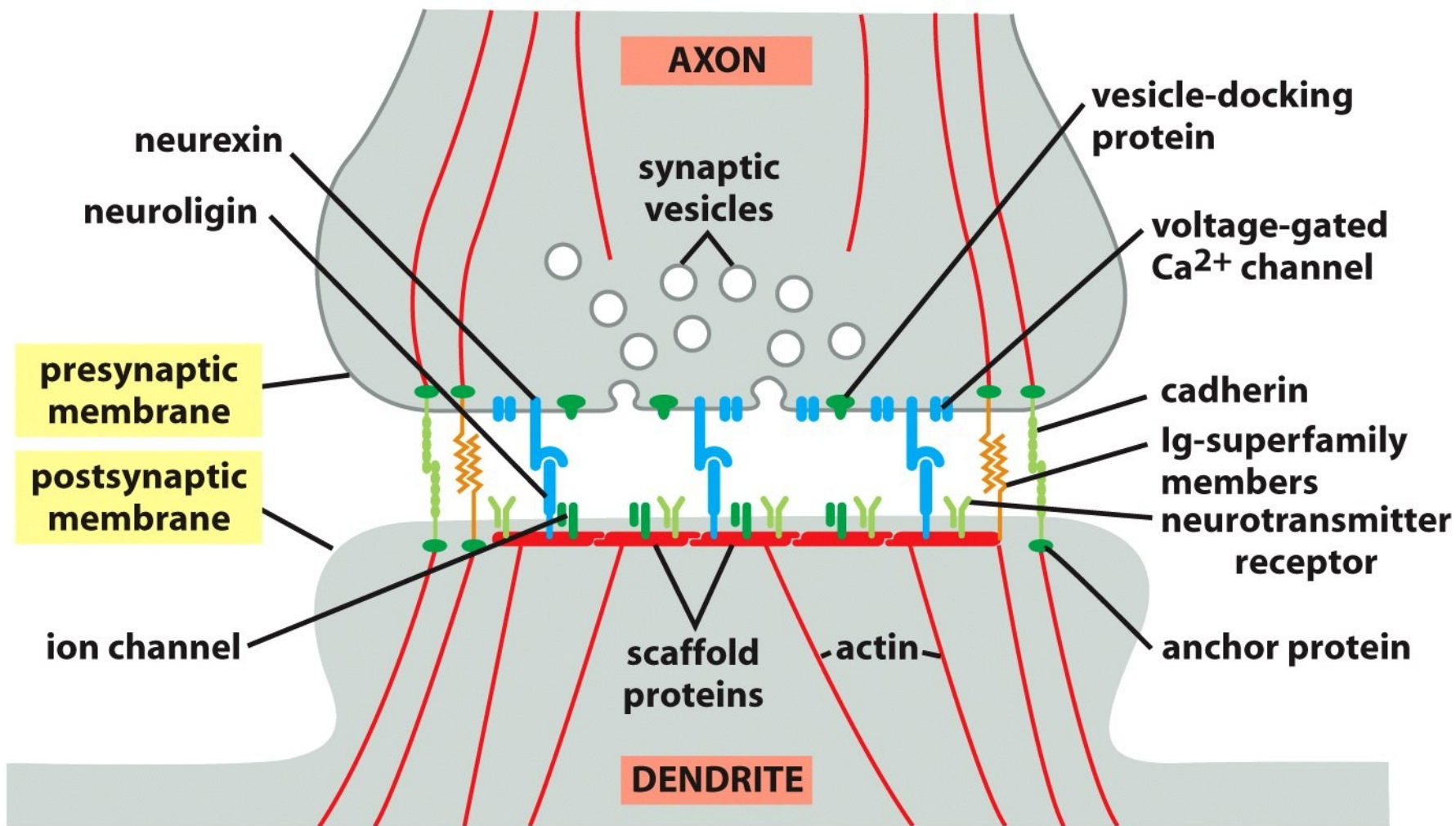

Figure 19-22c Molecular Biology of the Cell 5/e (© Garland Science 2008)

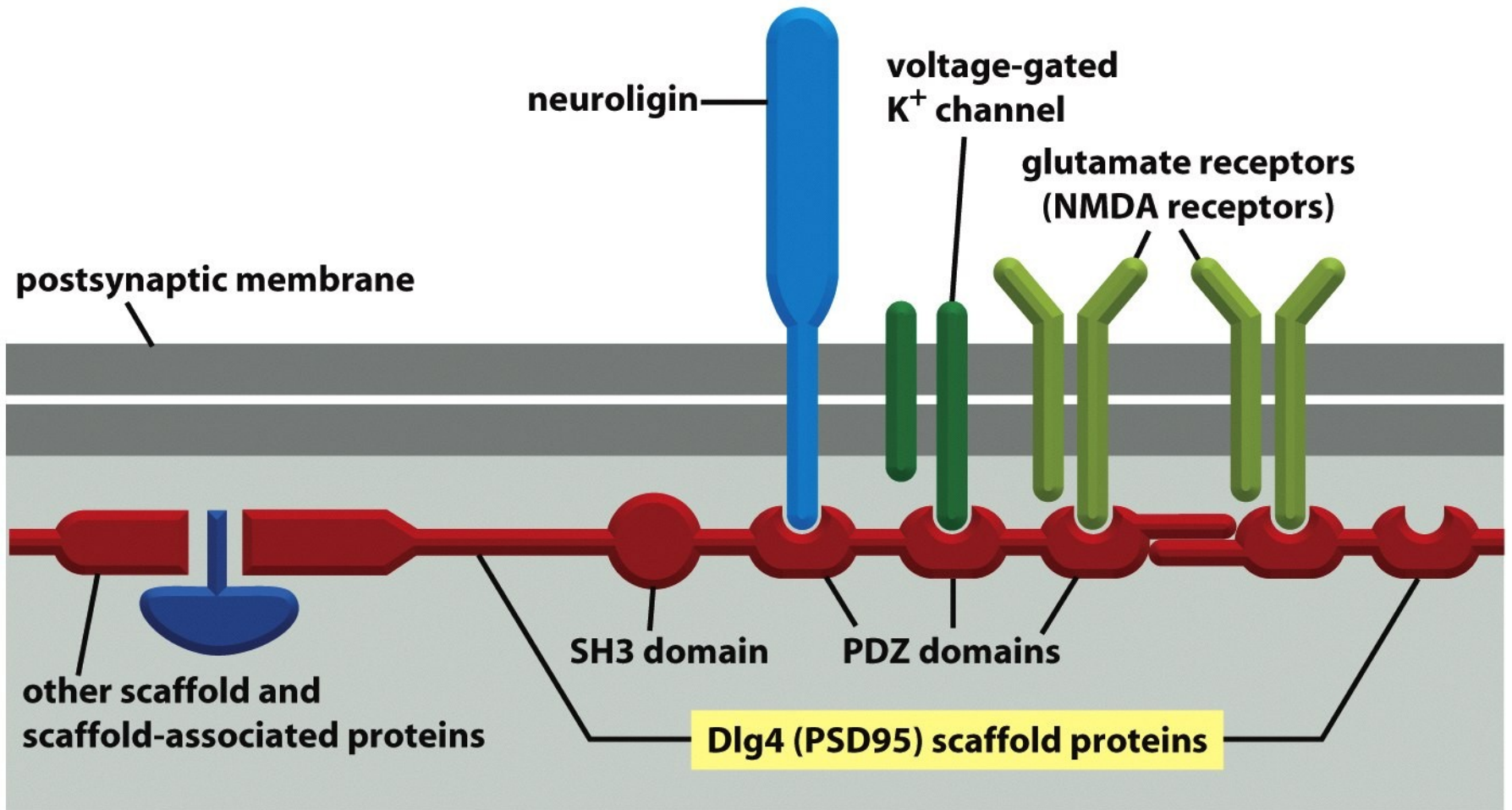

Figure 19-21 Molecular Biology of the Cell 5/e (© Garland Science 2008)

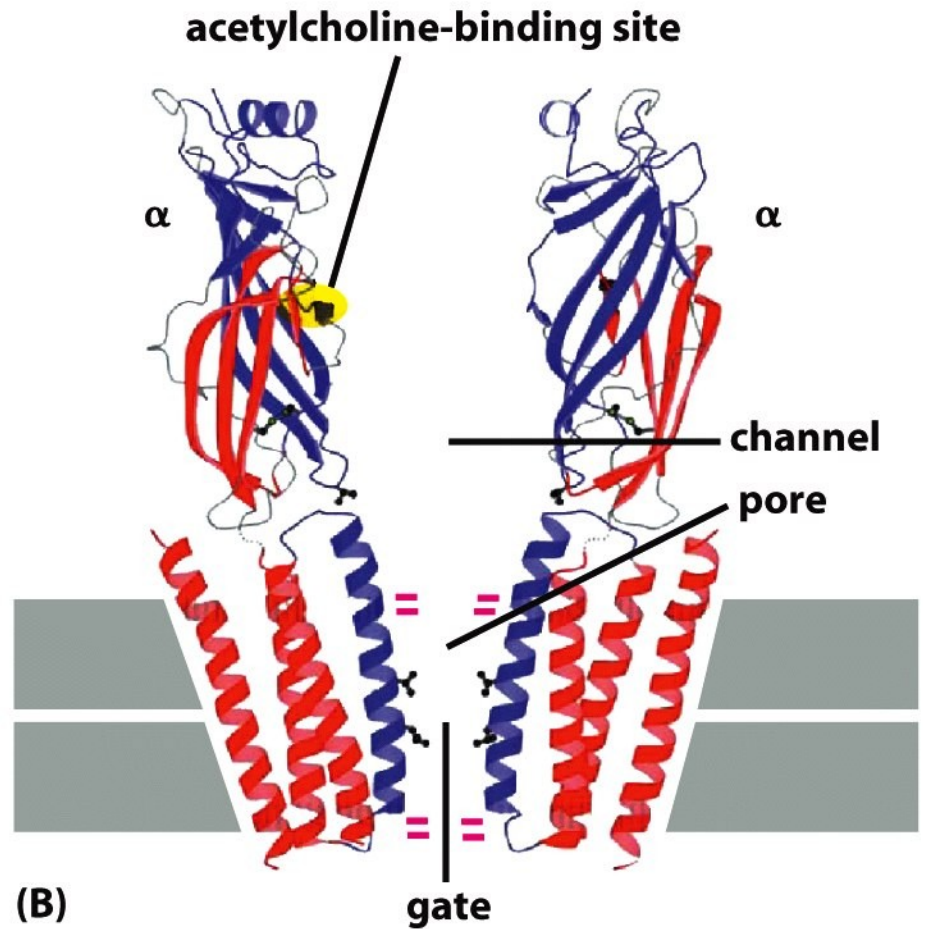
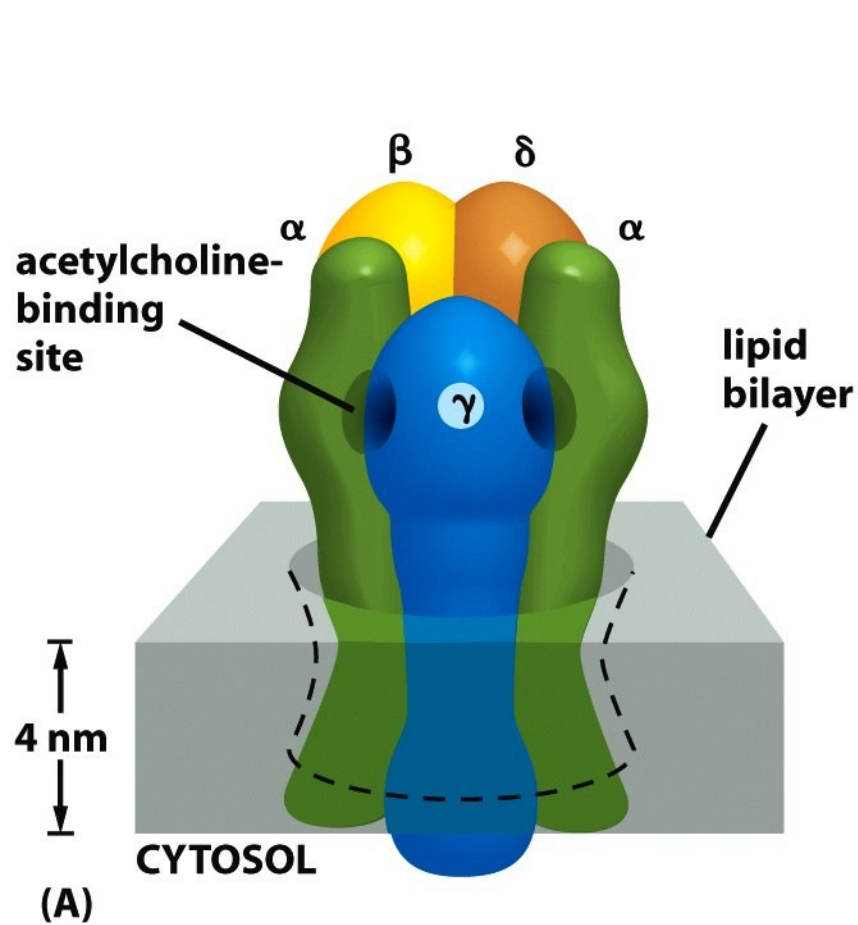
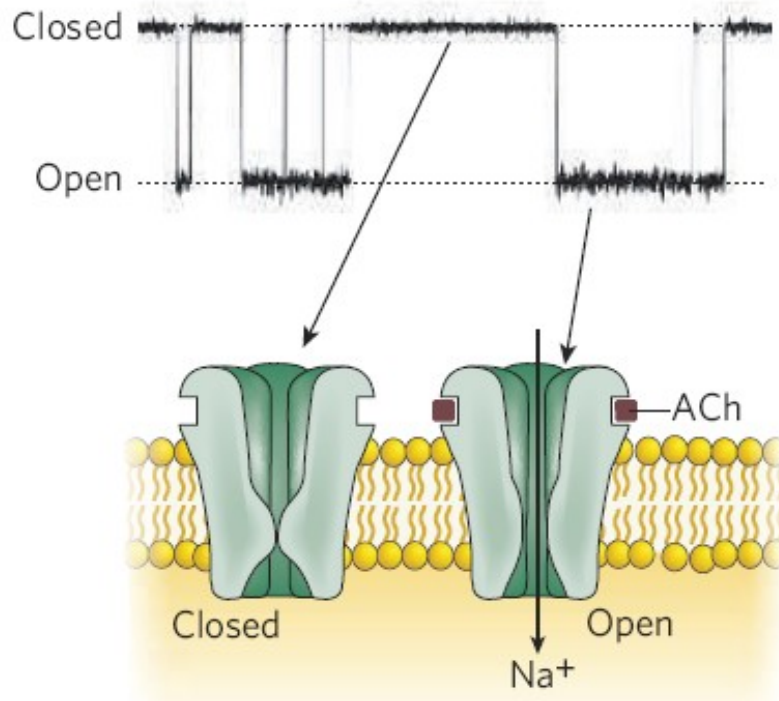
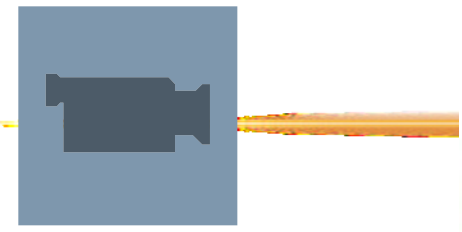
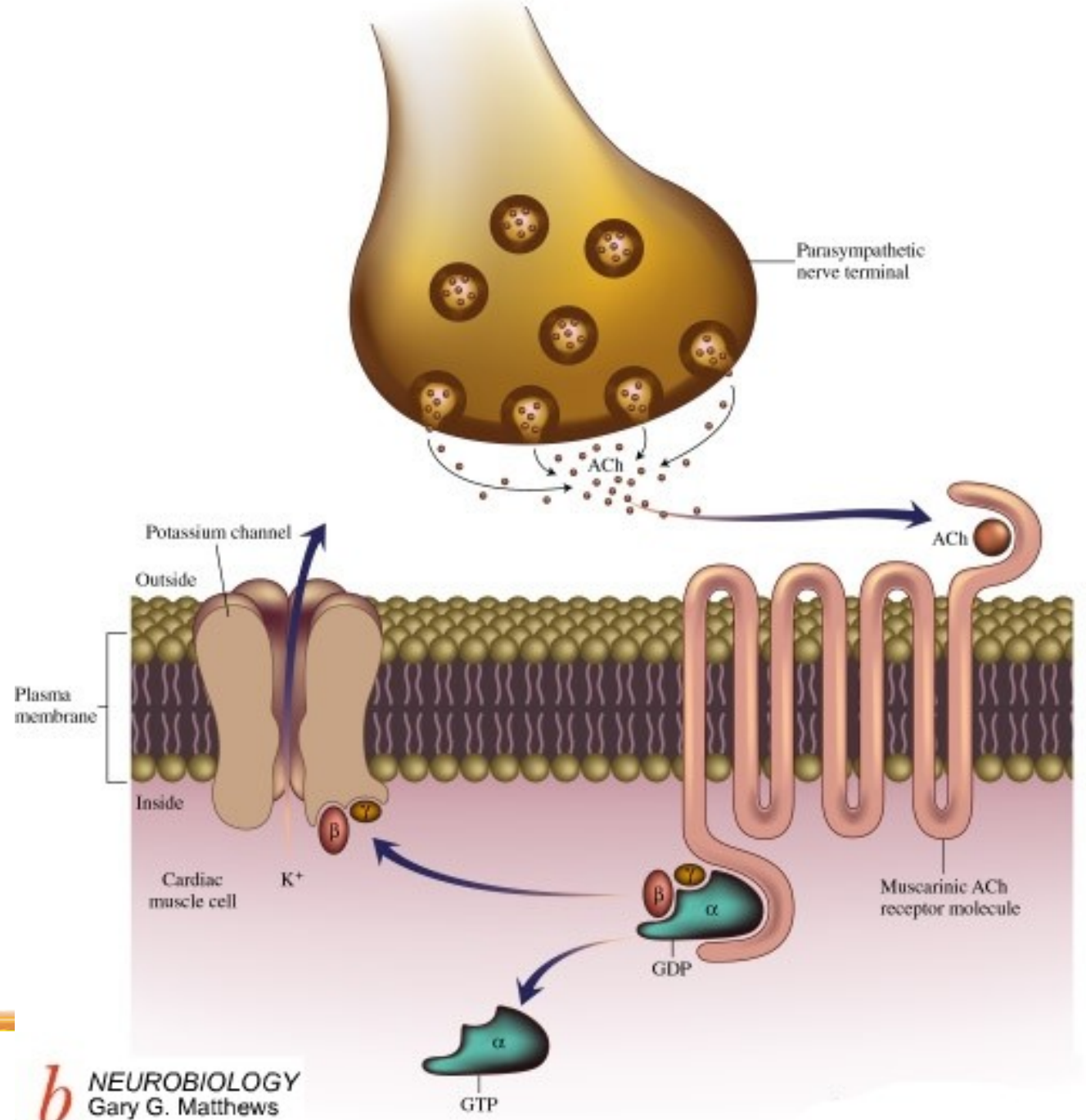
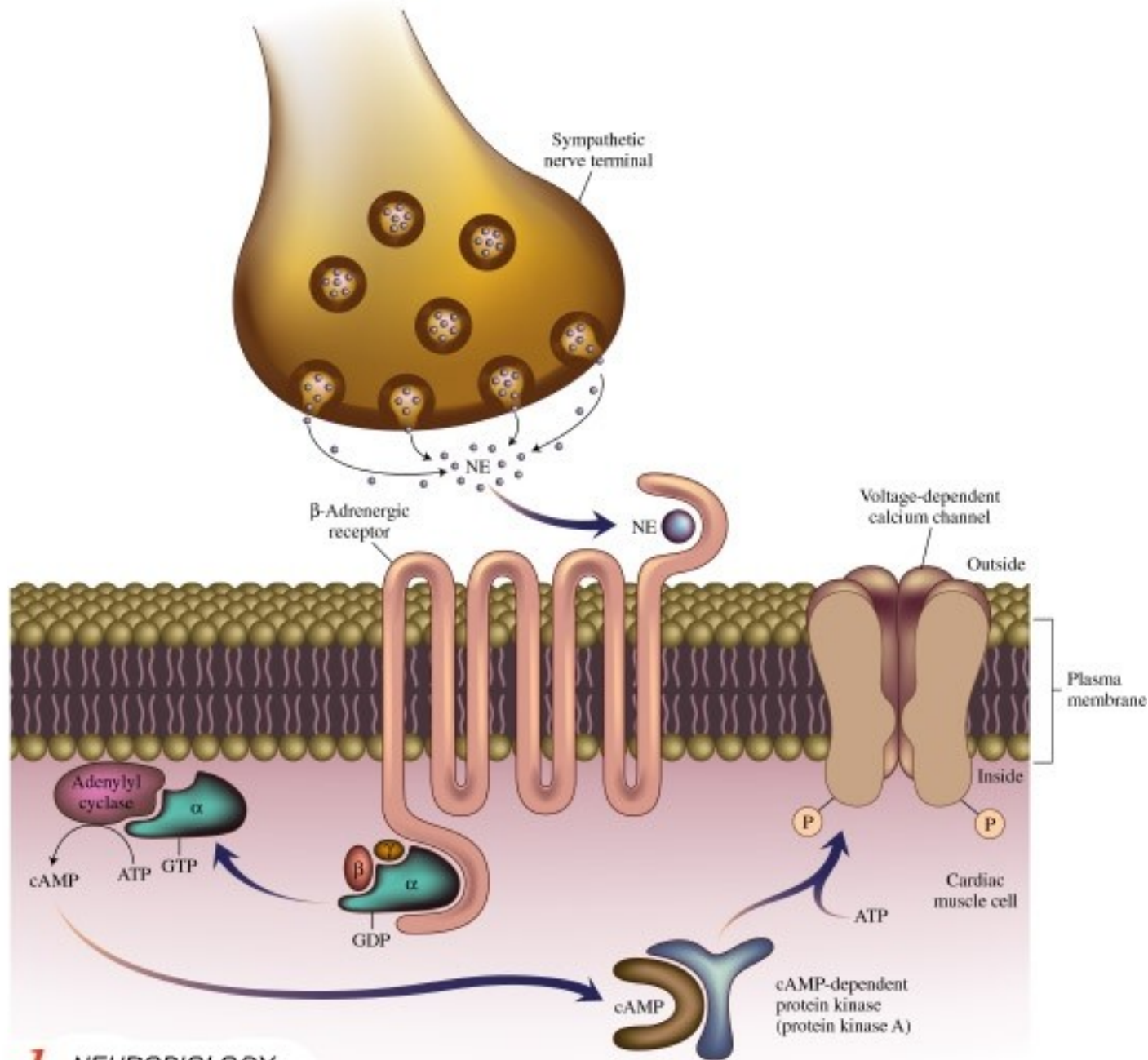

Figure 11-38 Molecular Biology of the Cell 5/e (© Garland Science 2008)

a







Iont	Rovnovážný potenciál
Na^+	+67 mV
K^+	-98 mV
Cl^-	-90 mV
volný Ca^{2+}	+129 mV
fixní aniont	

D. Vliv IPSP na postsynaptickou excitaci

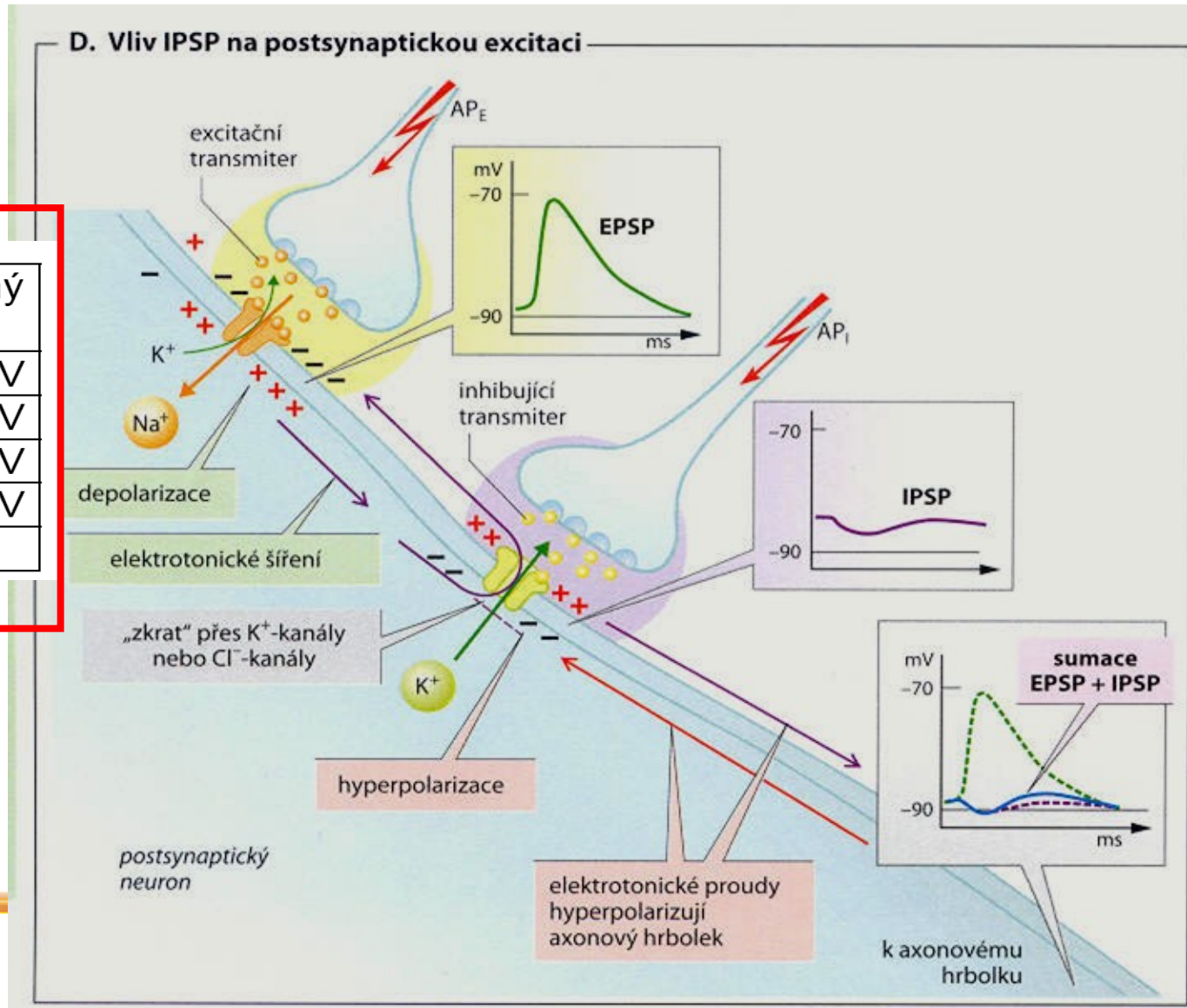

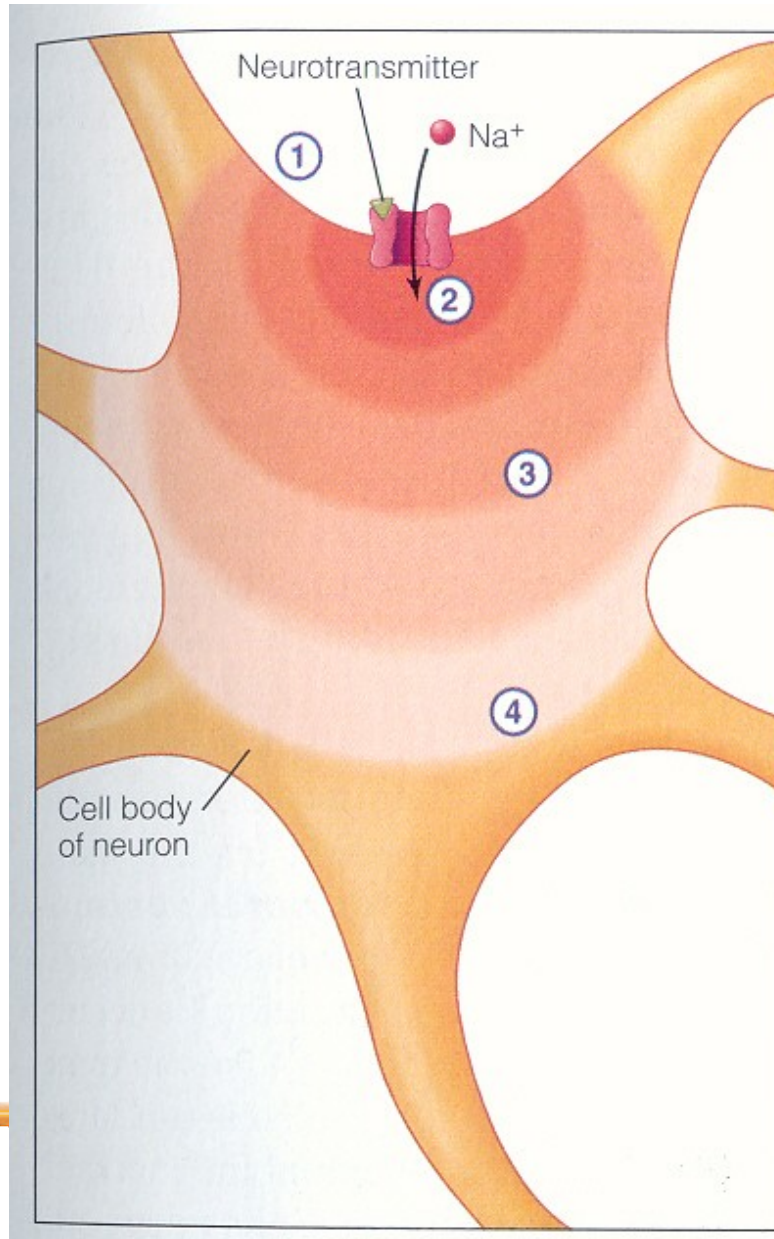

1 Neurotransmitter binds to a ligand-gated Na^+ channel.

2 Na^+ enters cell through the open channel.

3 Current spreads through the cell.

4 The strength of the signal decreases with distance.

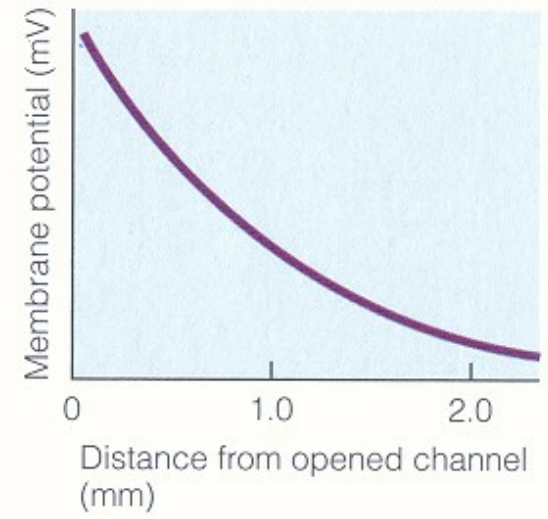
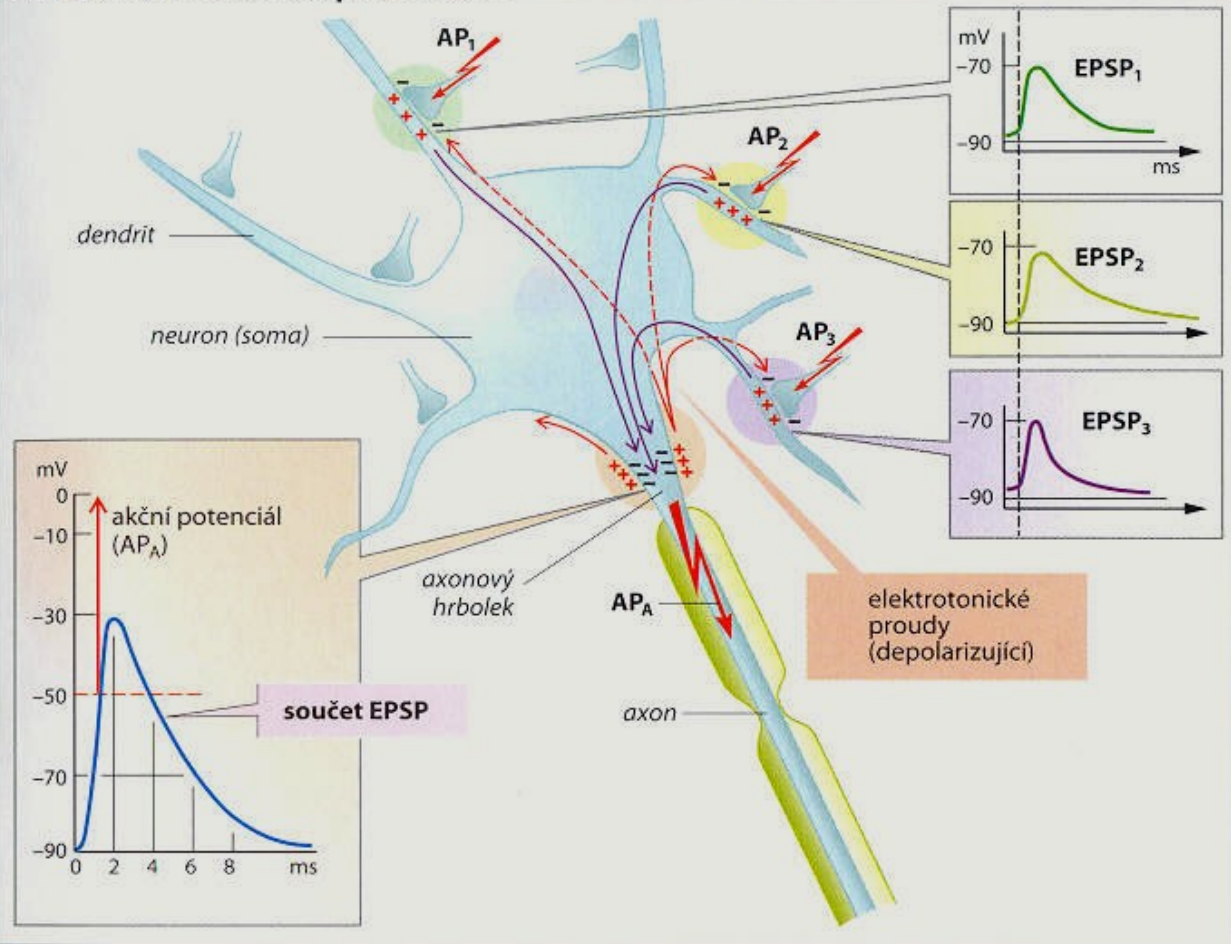

Figure 15.10 The propagation of an action potential.

B. Prostorová sumace podráždění



C. Časová sumace podráždění

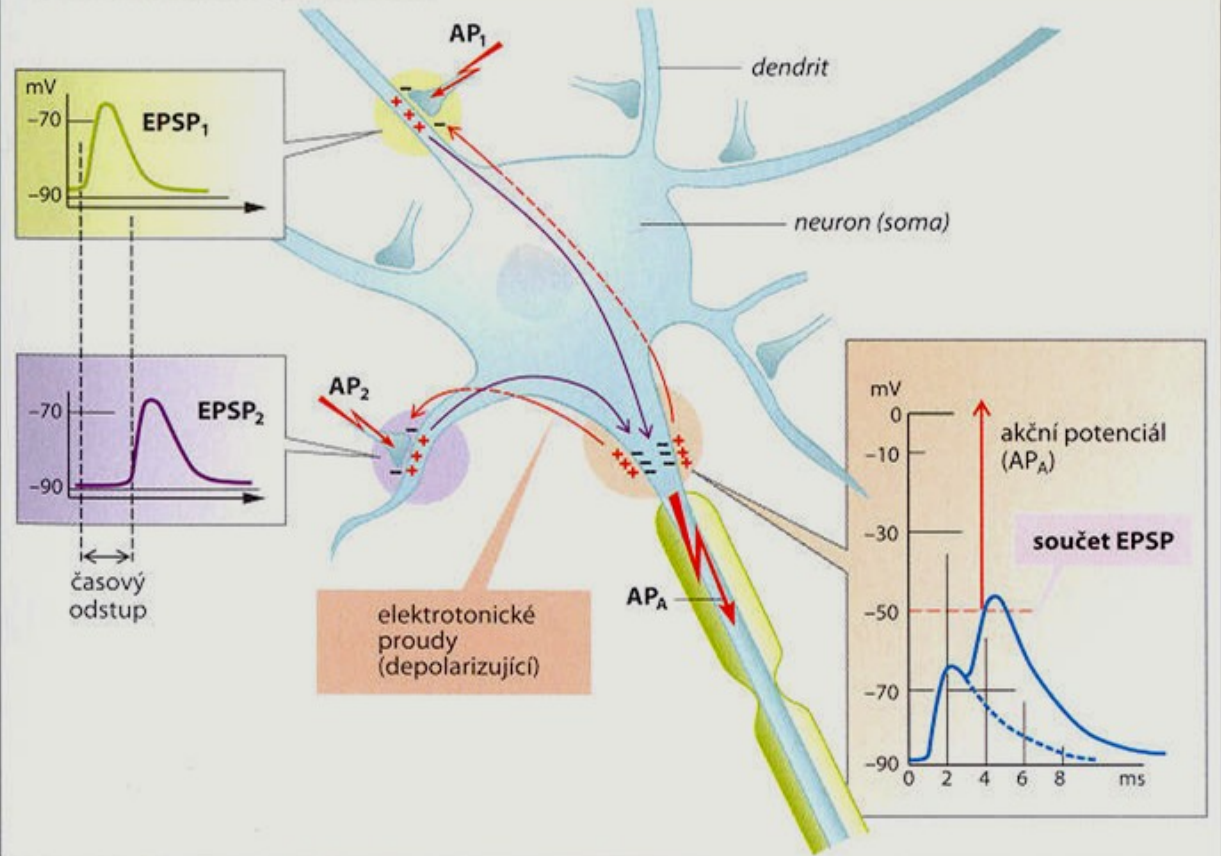
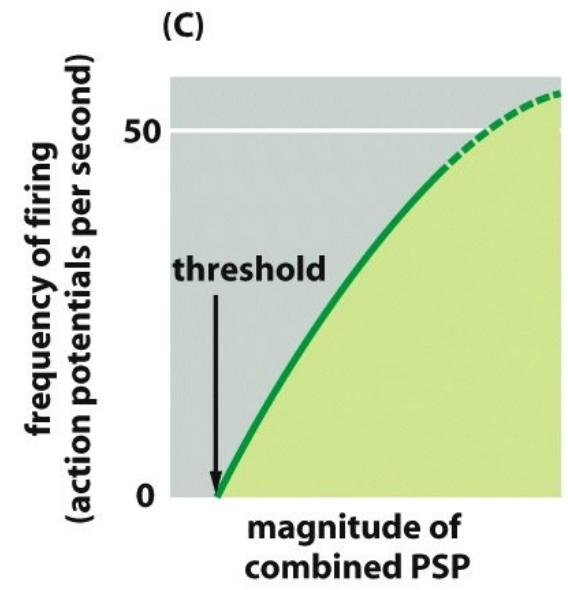
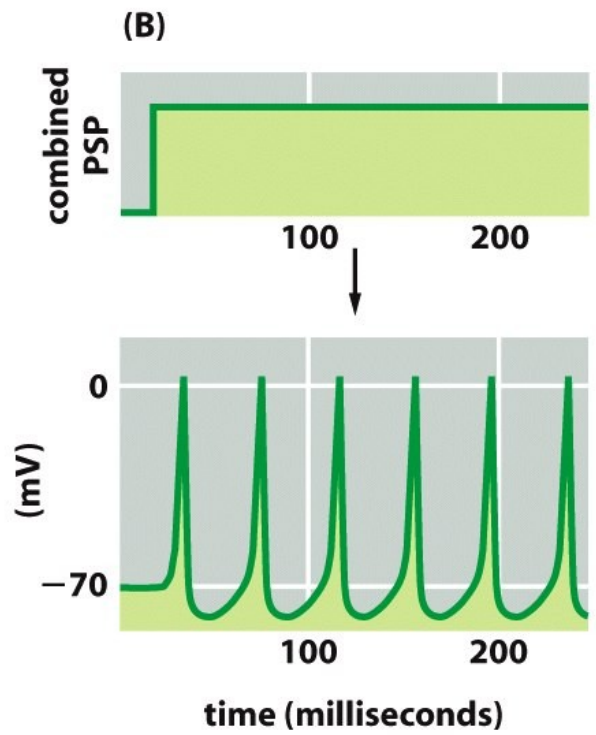
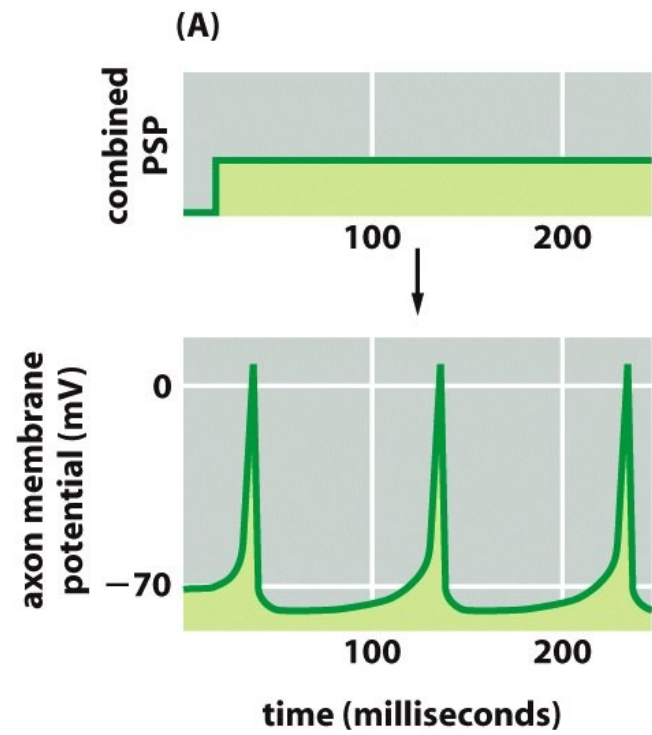

Table 4-2 ■ Comparison of Graded Potentials and Action Potentials

Graded Potentials	Action Potentials
Graded potential change; magnitude varies with magnitude of triggering event	All-or-none membrane response; magnitude of triggering event coded in frequency rather than amplitude of action potentials
Decremental conduction; magnitude diminishes with distance from initial site	Propagated throughout membrane in undiminishing fashion
Passive spread to neighboring inactive areas of membrane	Self-regenerating in neighboring inactive areas of membrane
No refractory period	Refractory period
Can be summed	Summation impossible
Can be a depolarization or hyperpolarization	Always depolarization and reversal of charges
Triggered by a stimulus, by combination of neurotransmitter with receptor, or by spontaneous shifts in leak-pump cycle	Triggered by depolarization to threshold, usually through the spread of a graded potential
Occurs in specialized regions of membrane designed to respond to the triggering event	Occurs in regions of membrane with an abundance of voltage-gated Na^+ channels



Trvalý podnět tedy vyvolá trvalé „pálení“.

větší depolarizace se inaktivují dříve,
počet otevřených K kanálů je tedy nižší (tím méně se uplatňují) a frekvenci AP netlumí.

Ca a Ca dependentní K kanály se uplatňují při adaptaci



0.1 mm

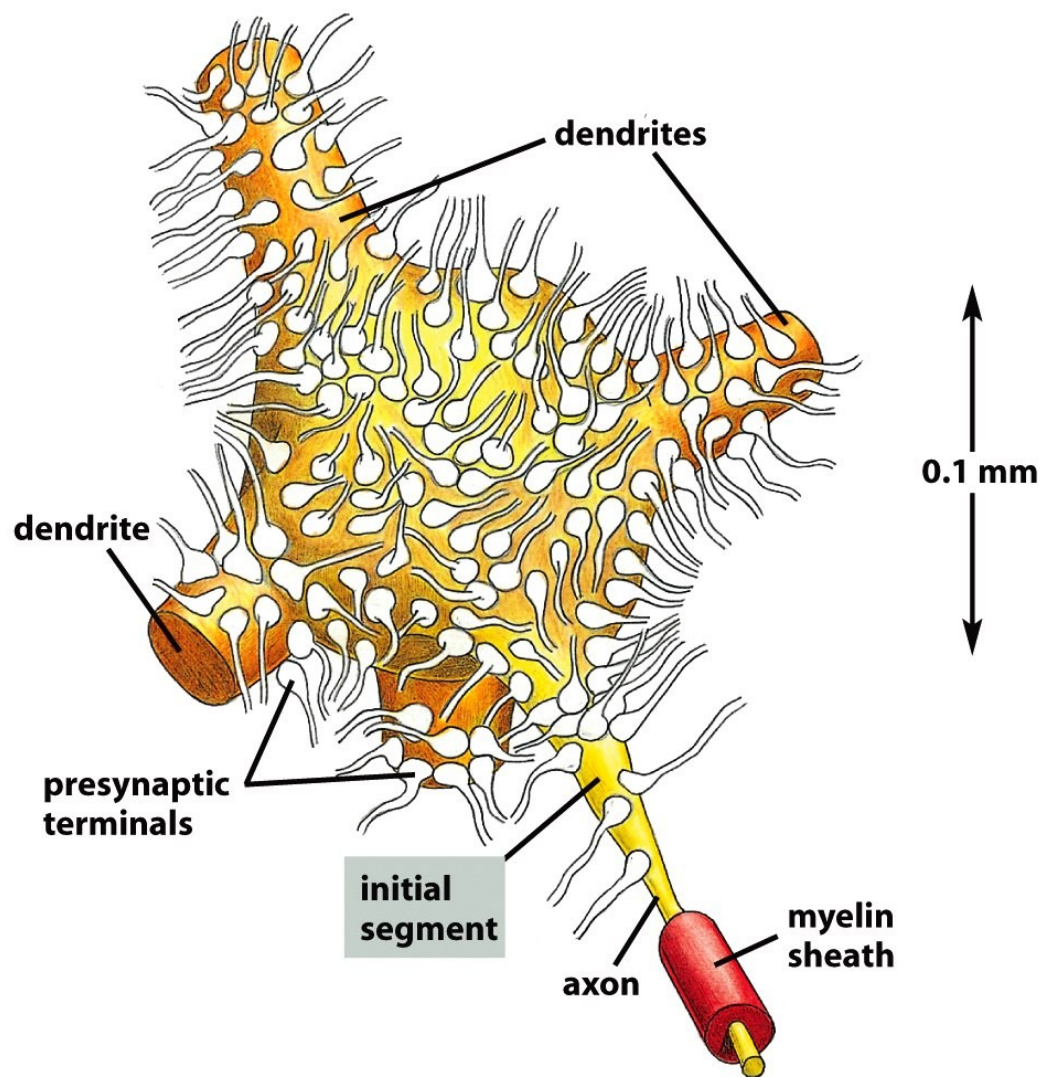
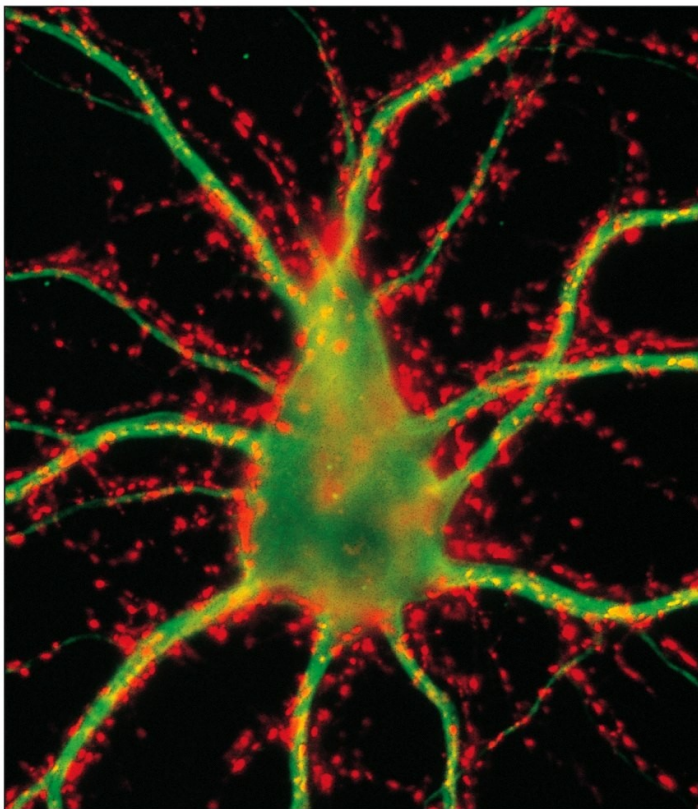
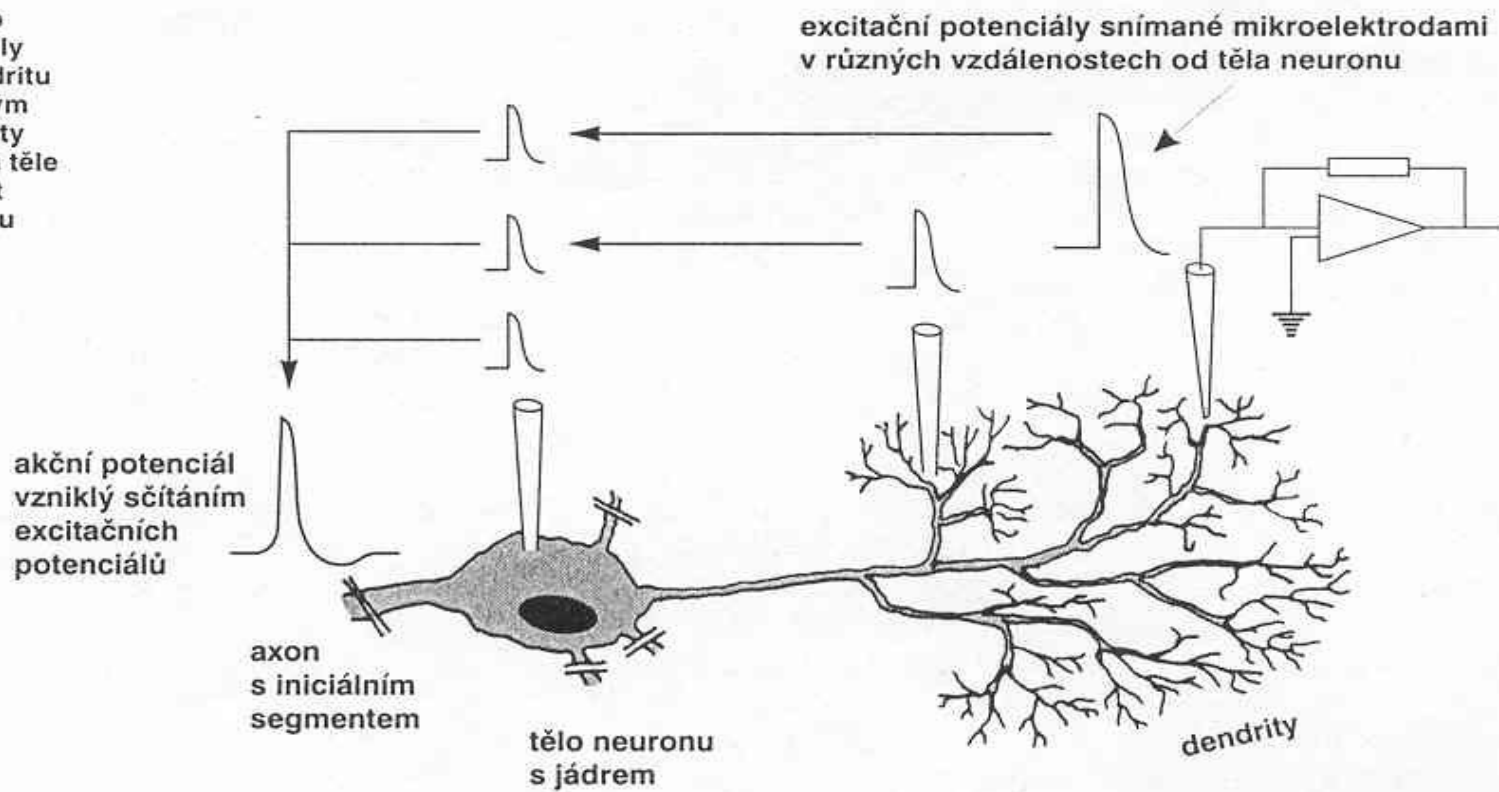
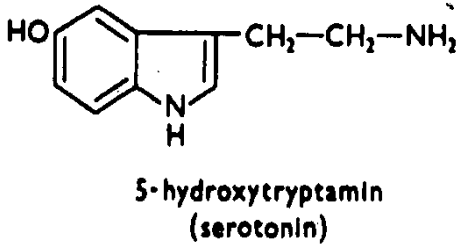
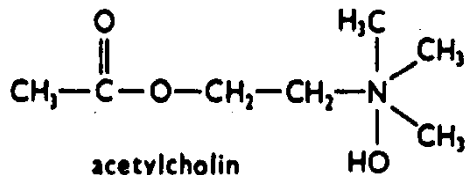
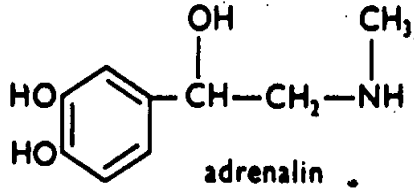
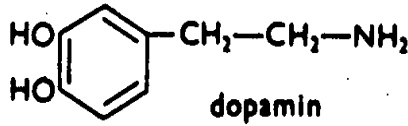
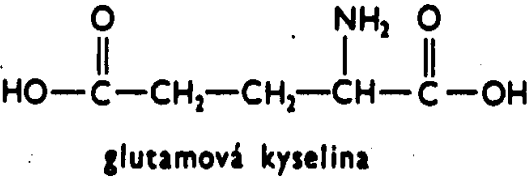
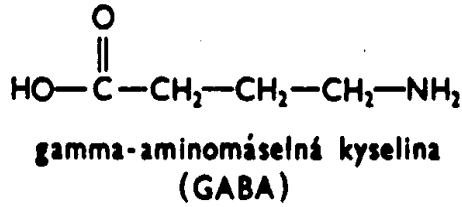

Figure 11-40a Molecular Biology of the Cell 5/e (© Garland Science 2008)

1. Schéma pokusu Mageeho a Cooka. Excitační potenciály vyvolané ostříkováním dendritu vysokoosmotickým cukerným roztokem se během své cesty k tělu neuronu zmenšují. Na těle neuronu už je jejich velikost stejná, ač se při svém vzniku amplitudou lišily. Sčítáním potenciálů může vzniknout akční potenciál.





transmitter	typy receptorů	druh receptoru	účinek				druhý posel	
			Na ⁺	K ⁺	Ca ²⁺	Cl ⁻	cAMP	IP ₃ /DAG
acetylcholin	nikotinový muskarinový: M1, M2, M3	●	↑	↑	↑			↑
ADH (= vazopresin)	V1 V2	●					↑	↑
CCK (= cholecystokinin)	CCK _{A-B}	●						↑
dopamin	D1, D5 D2	●		↑	↓		↓	↑
GABA (= γ-aminomáselná kys.)	GABA _A , GABA _C GABA _B	●		↑	↓	↑	↓	
glutamát (aspartát)	AMPA kainat NMDA m-GLU	●	↑	↑	↑		↓	↑
glycin	-	●				↑		
histamin	H ₁ H ₂	●					↑	↑
neurotenzin	-	●					↓	↑
noradrenalin, adrenalin	α ₁ (A-D) α ₂ (A-C) β ₁₋₃	●		↑	↓		↓	↑
NPY (= neuropeptid Y)	Y1-2	●		↑	↓		↓	
opioidní peptidy	μ, δ, κ	●		↑	↓		↓	
oxytocin	-	●						↑
puriny	P ₁ : A ₁ A _{2a} P _{2X} P _{2Y}	●		↑	↓		↓	↑
serotonin (= 5-hydroxytryptamin)	5-HT ₁ 5-HT ₂ 5-HT ₃ 5-HT ₄₋₇	●	↑	↑	↓		↓	↑
somatostatin (= SIH)	SRIF	●		↑	↓		↓	
tachykinin	NK1-3	●						↑

- aminokyseliny
- katecholaminy
- peptidy
- ostatní



Tab. 2.7 a 2.8 Synaptický přenos III a IV



•

•

•



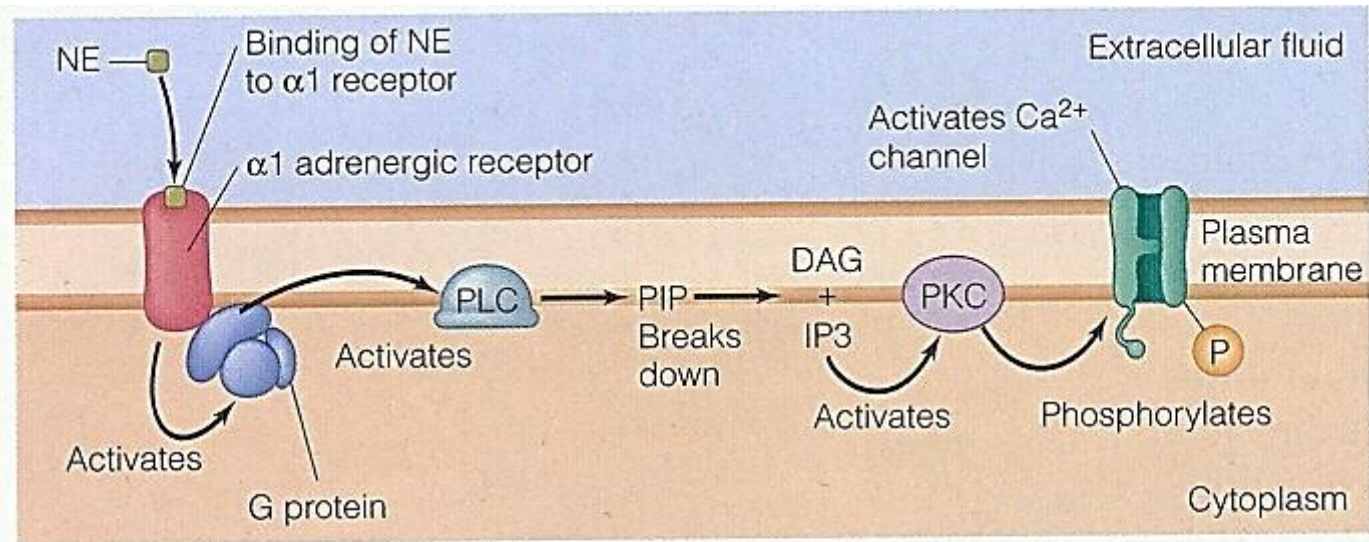

(a) Binding of NE to α_1 adrenergic receptors

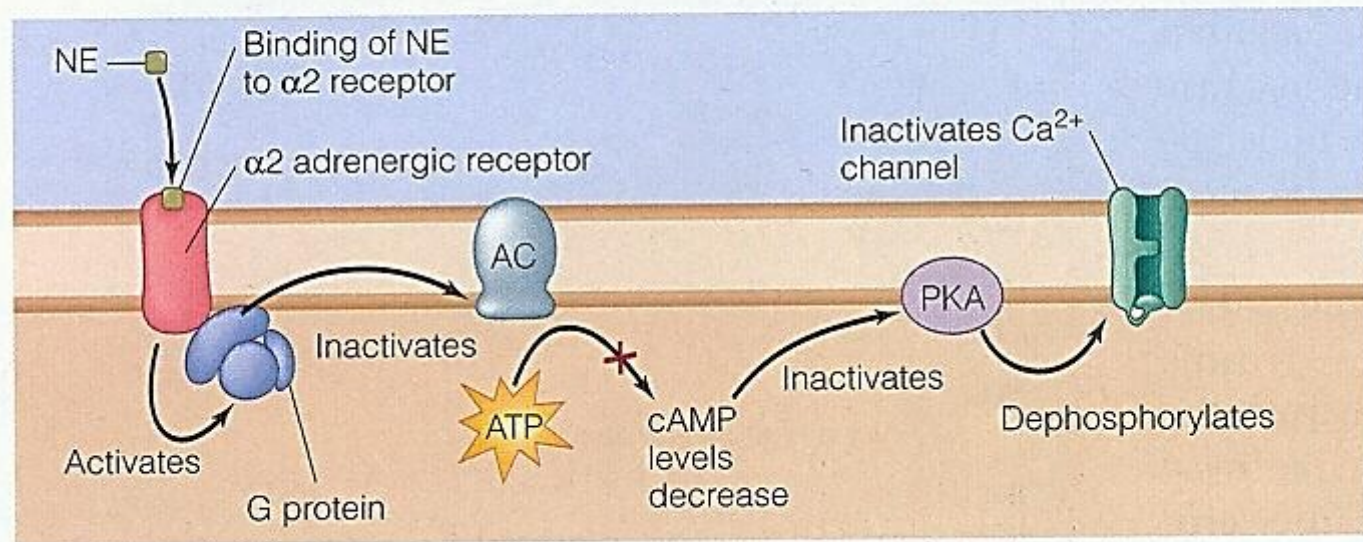

(b) Binding of NE to α_2 adrenergic receptors

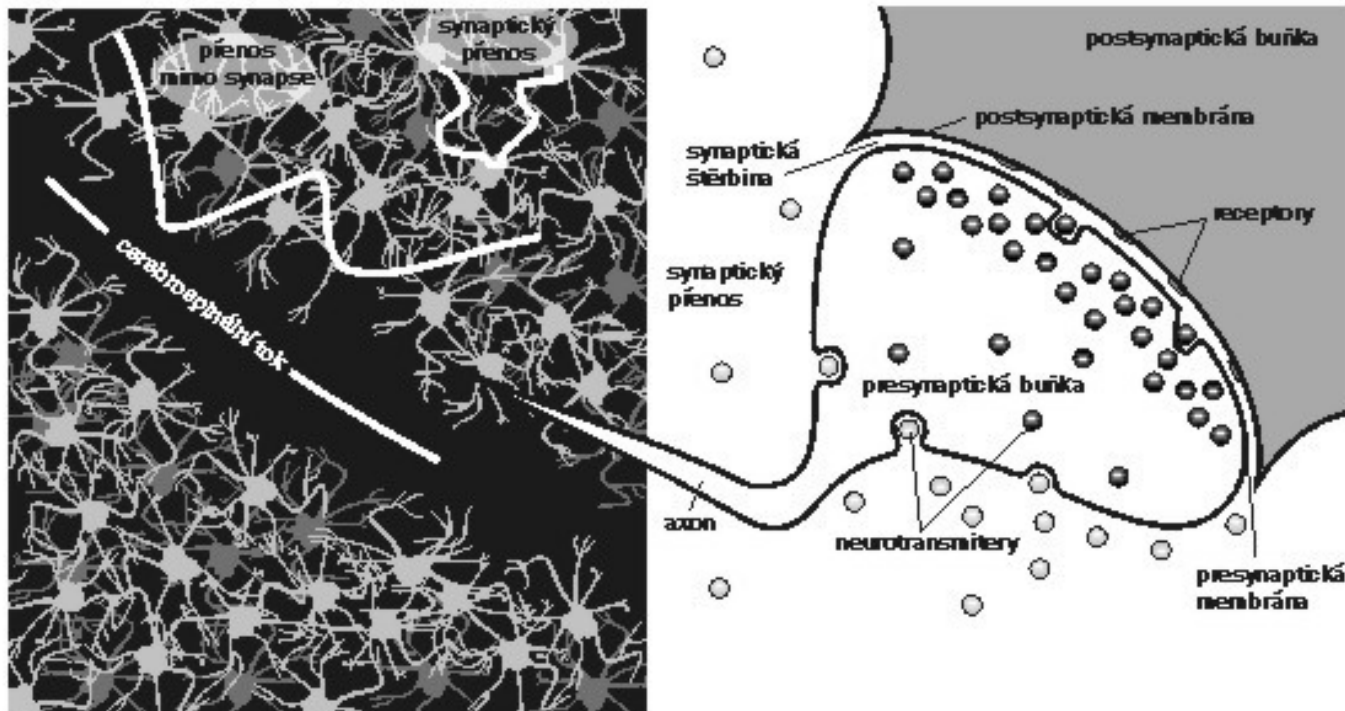

chemický přenos je podobný způsob, jímž se k svým cílům dostává

Table 4-4 ■ Comparison of Classical Neurotransmitters and Neuropeptides

Characteristic	Classical Neurotransmitters	Neuropeptides
Size	Small; one amino acid or similar chemical	Large: 2 to 40 amino acids in length
Site of synthesis	Cytosol of synaptic knob	Endoplasmic reticulum and Golgi complex in cell body; travel to synaptic knob by axonal transport
Site of storage	In small synaptic vesicles in axon terminal	In large dense-core vesicles in axon terminal
Site of release	Axon terminal	Axon terminal; may be cosecreted with neurotransmitter
Speed and duration of action	Rapid, brief response	Slow, prolonged response
Site of action	Subsynaptic membrane of postsynaptic cell	Nonsynaptic sites on either presynaptic or postsynaptic cells at much lower concentrations than classical neurotransmitters
Effect	Usually alter potential of postsynaptic cell by opening specific ion channels	Usually enhance or suppress synaptic effectiveness by long-term changes in neurotransmitter synthesis or postsynaptic receptor sites

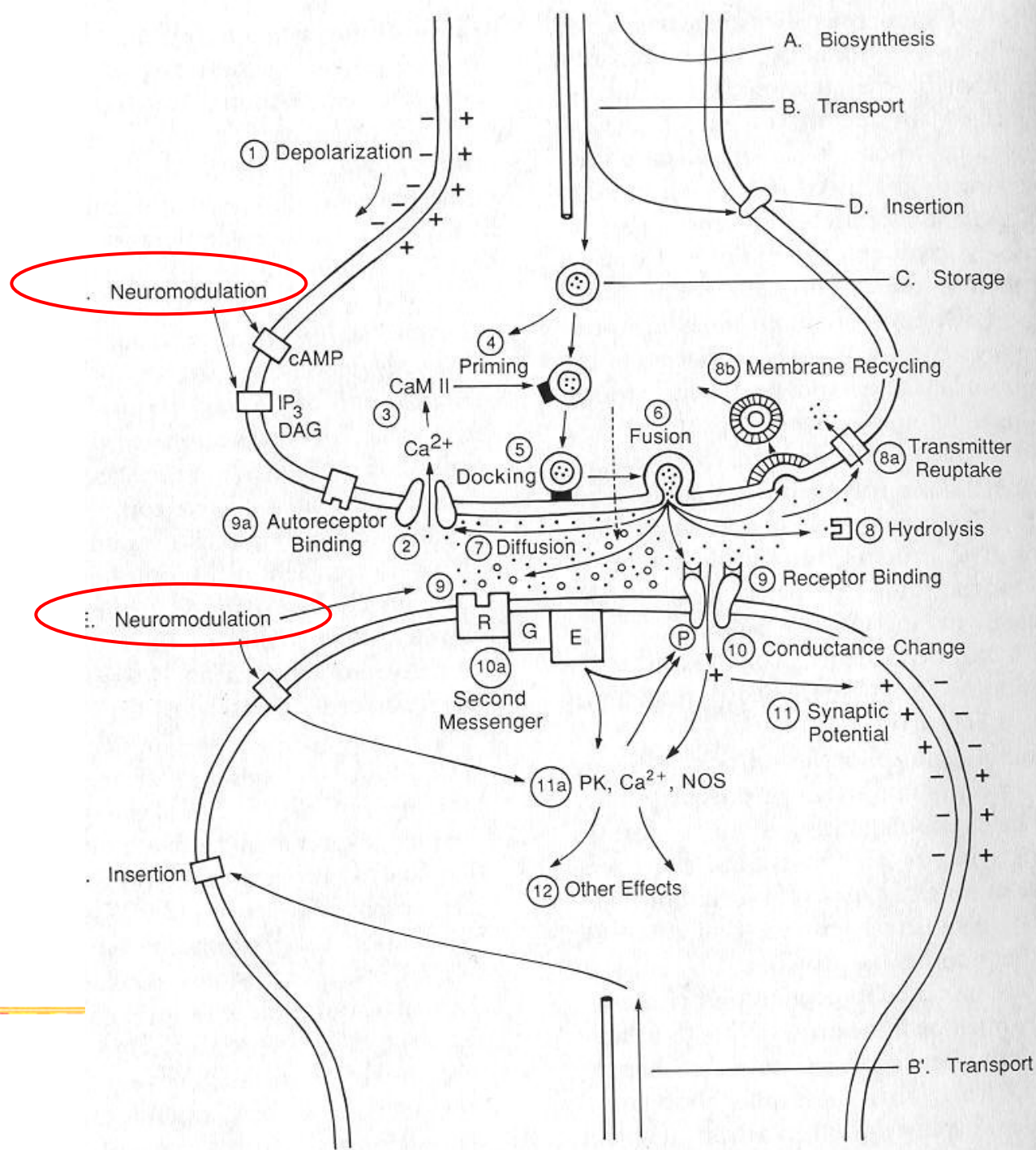

A

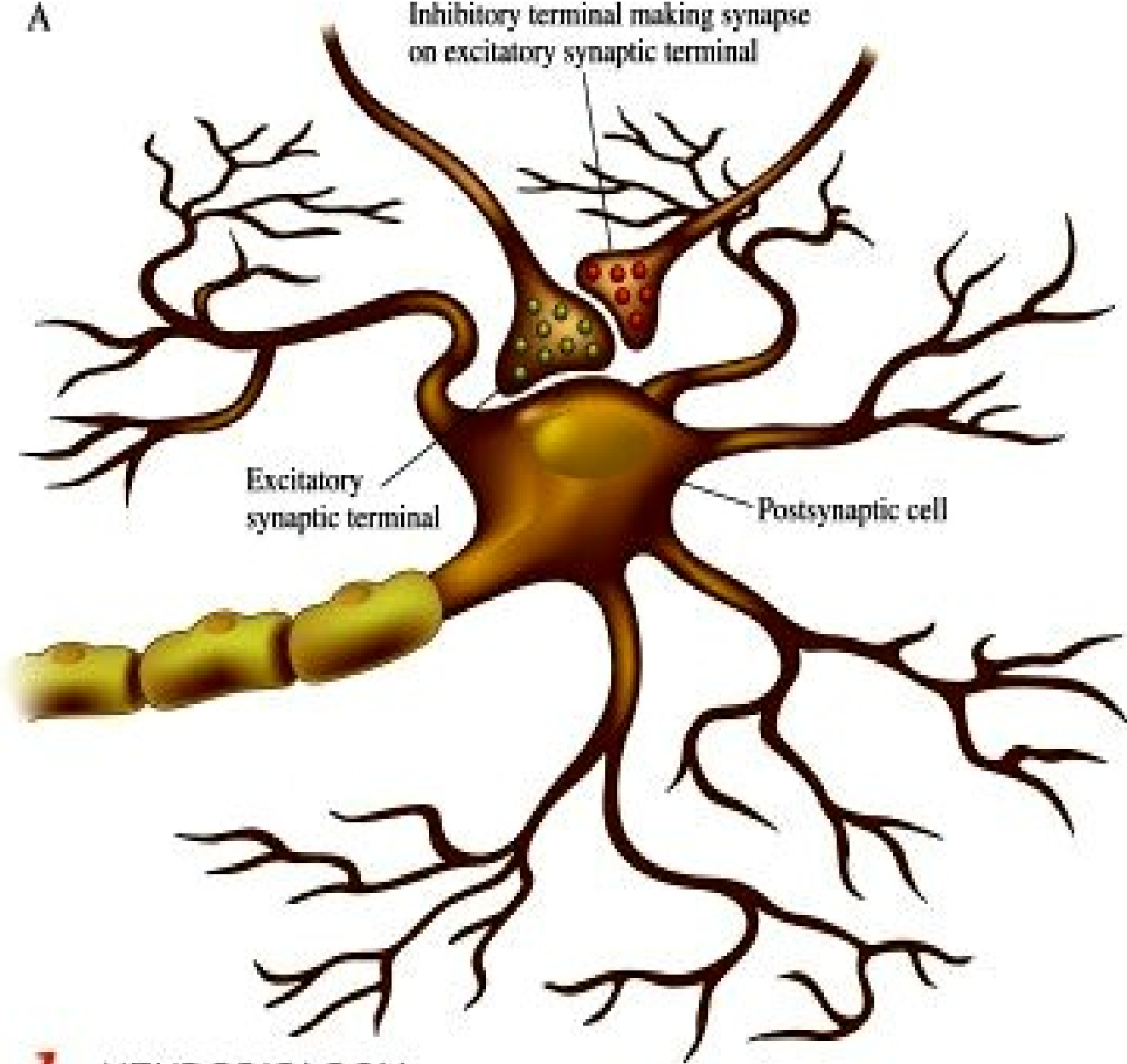

b

NEUROBIOLOGY
Gary G. Matthews

Blackwell
Science

Účinky neurotransmitterů prostřednictvím synaptického přenosu

neurotransmitter		dostupnost (aktivita neurotransmiteru)	lék
serotonin	snížena ↓ ↑ zvýšena	deprese	antidepresivum
acetylcholin		Alzheimerova nemoc	inhibitory acetylcholinesterázy, která odbourává acetylcholin
g-aminomáselná kyselina (GABA)		úzkost (tzv. generalizovaná)	anxiolytika (usnadňují účinek kyseliny g-aminomáselné)
dopamin		pozitivní příznaky schizofrenie	antipsychotika (blokuje účinek dopaminu)

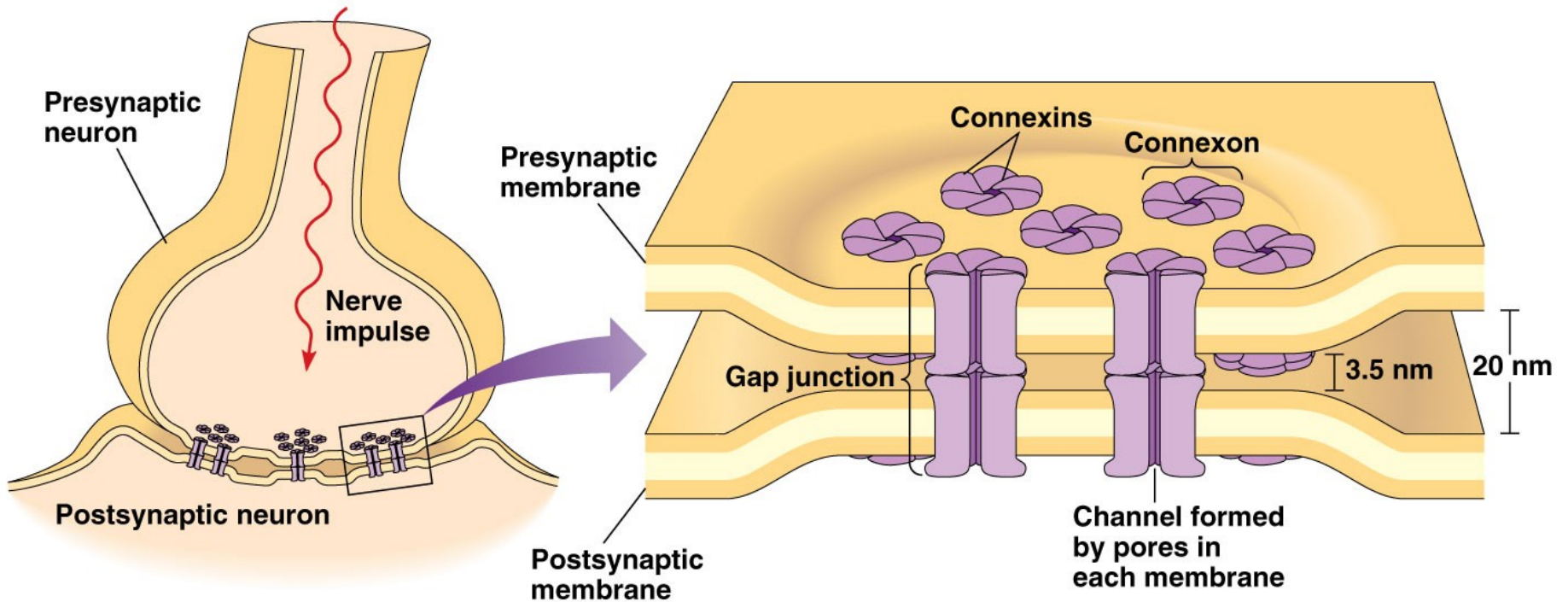

(a) An electrical synapse

(b) Gap junctions





a Chemical synapse

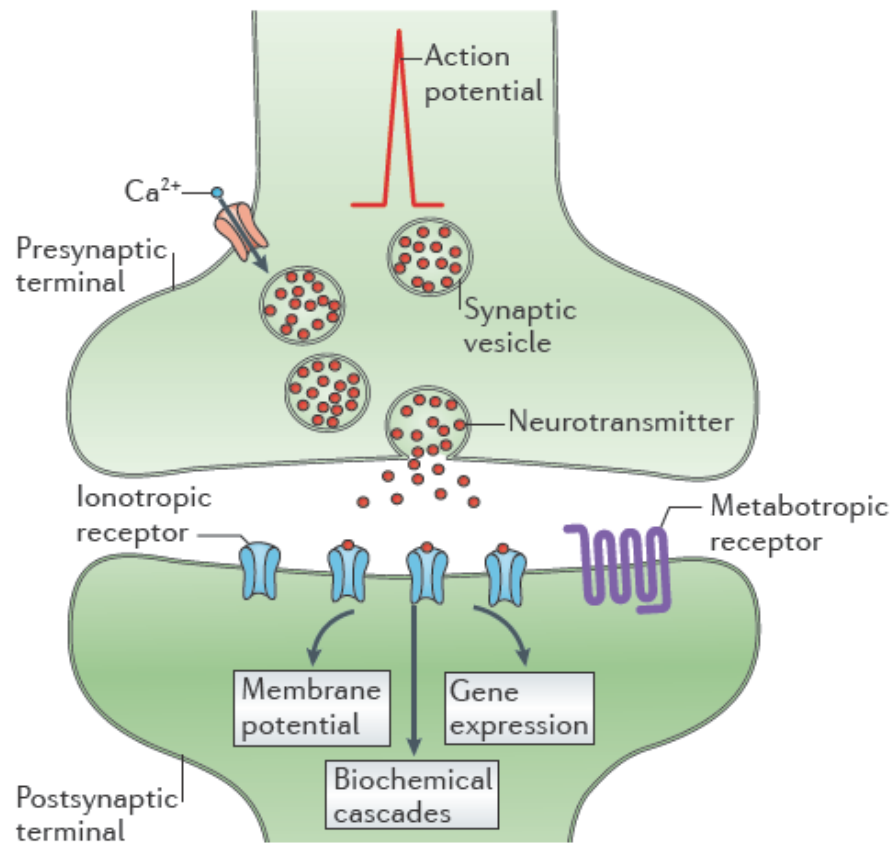

b Electrical synapse

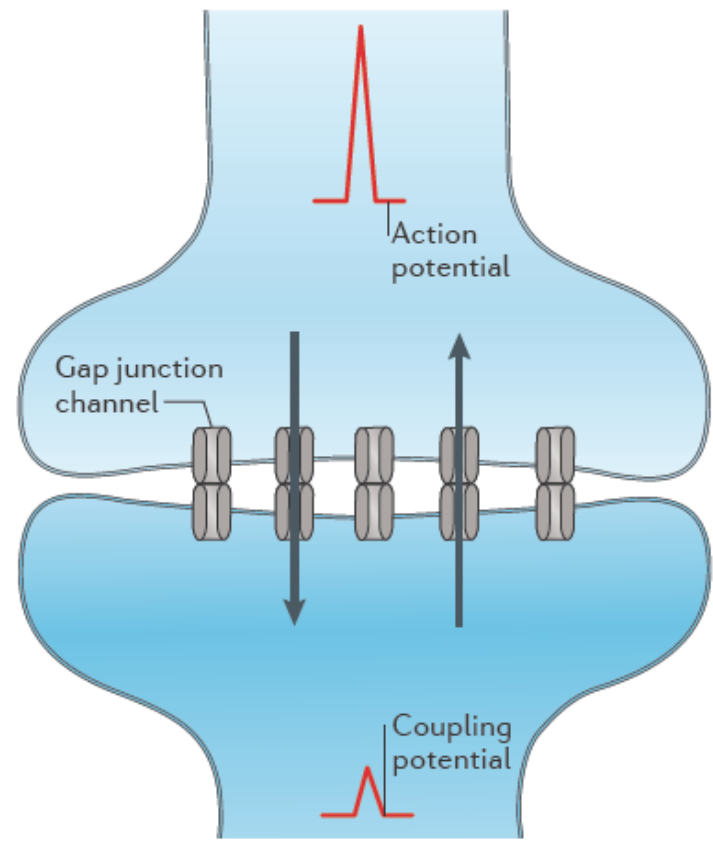
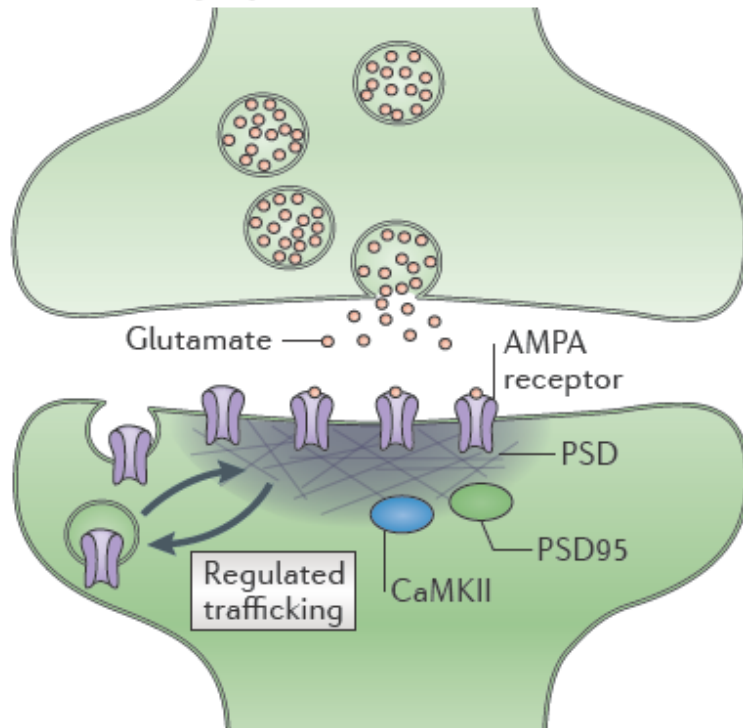

Figure 1 | **The two main modalities of synaptic transmission.** **a** | Chemical transmission requires sophisticated presynaptic molecular machinery that regulates neurotransmitter release in a probabilistic manner upon depolarization of the presynaptic terminal — in this case, by the arrival of an action potential — which leads to the activation of voltage-gated calcium channels (VGCCs). Similarly complex postsynaptic molecular machinery is also required. This includes the presence of ionotropic and metabotropic receptors that are capable of detecting and translating the presynaptic message (neurotransmitters) into various postsynaptic events, ranging from changes in resting membrane potential to gene expression, thus amplifying the presynaptic signal. **b** | Electrical transmission is mediated by clusters of intercellular channels called gap junctions that connect the interior of two adjacent cells, and thereby directly enable the bidirectional passage of electrical currents carried by ions (arrows) as well as intracellular messengers and small metabolites (not illustrated here). Electrical synapses are bidirectional in nature: when a presynaptic action potential propagates to the postsynaptic cell, the membrane resting potential of the postsynaptic cell simultaneously propagates to the presynaptic cell.

a Chemical synapse



b Electrical synapse

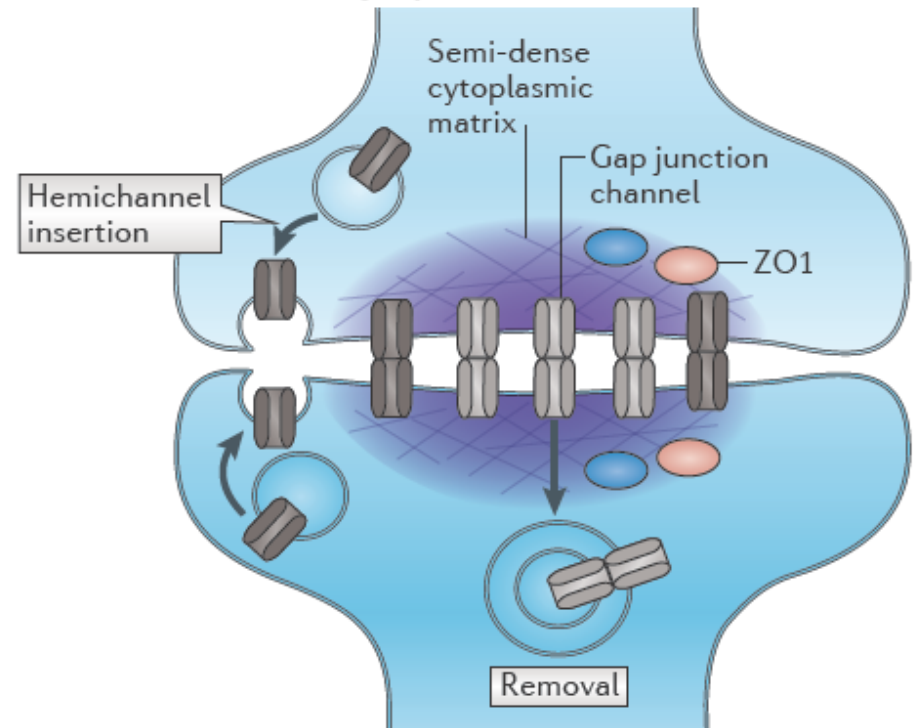

Figure 2 | **Trafficking of channels at chemical and electrical synapses.** **a** | Ionotropic glutamate receptors are trafficked in and out of synapses. Postsynaptic densities (PSDs) provide a scaffold that helps to regulate this trafficking. PSD95 and calcium/calmodulin-dependent protein kinase II (CaMKII) are both abundant components of PSDs. Regulated trafficking of AMPA receptors is thought to underlie the modification of synaptic strength at glutamatergic synapses. **b** | There is turnover of gap junction channels at electrical synapses. New connexons are trafficked as unpaired hemichannels to the membrane in vesicles, where they are inserted at the periphery of the gap junction plaque and dock with hemichannels in the apposing membrane. They are internalized as small clusters of entire channels (light grey) into either of the coupled cells from regions near the centre of the plaque. Various proteins make up the 'semi-dense cytoplasmic matrix', which acts as a scaffold for these channels. Zonula occludens protein 1 (ZO1) is a structural component of this scaffold. By contrast, CaMKII (not shown) seems to be a non-obligatory component of the macromolecular complex, with functions that might be similar to those at PSDs of chemical synapses.

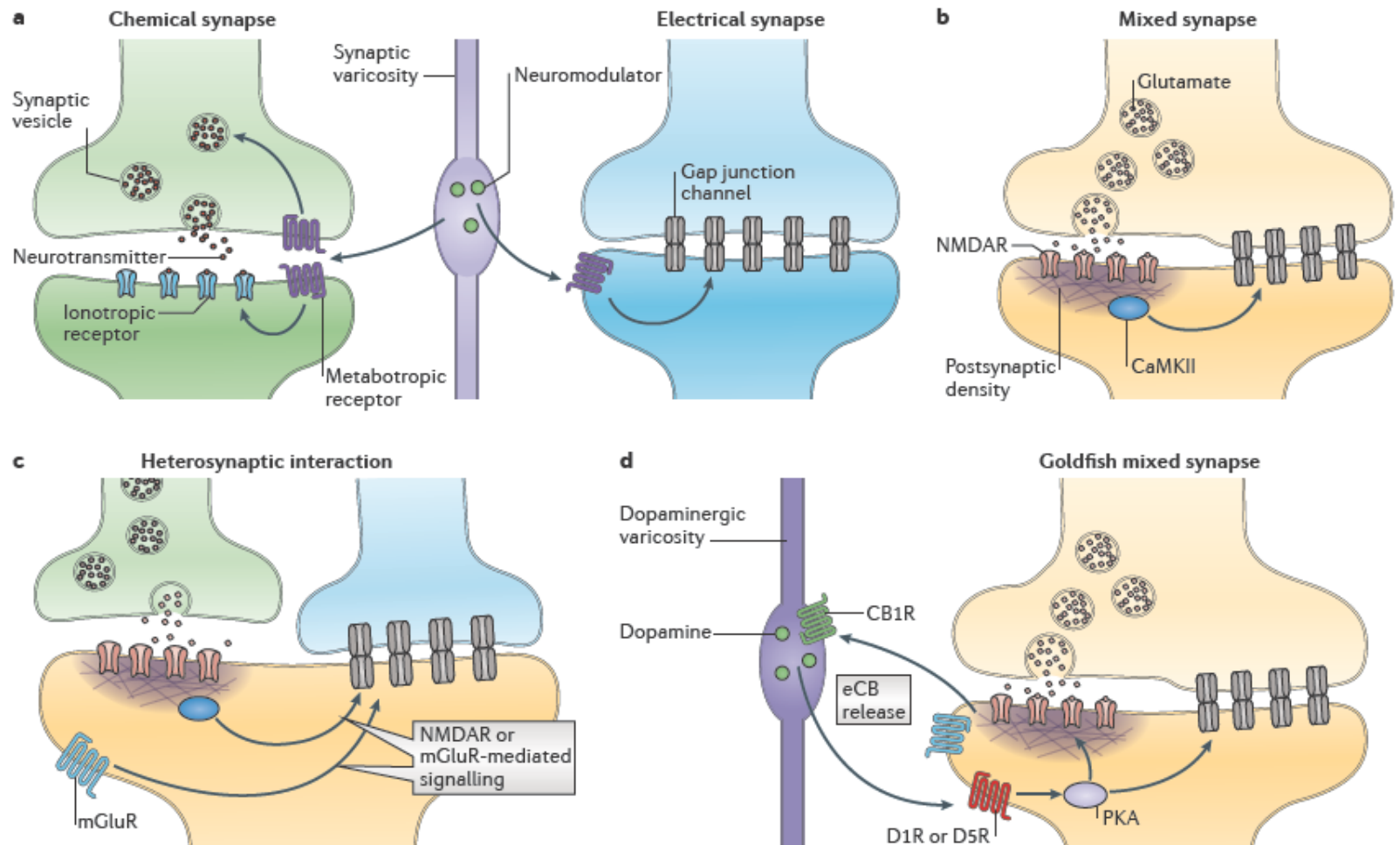
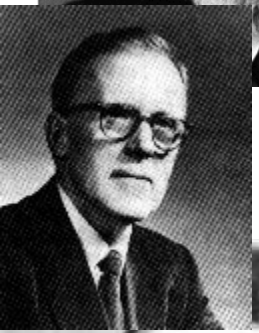
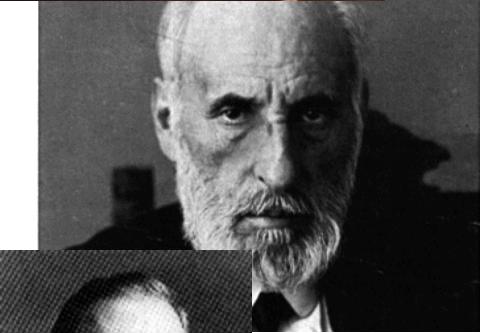

Figure 4 | Types of interactions between electrical and chemical synapses in the adult nervous system.

a | Neurotransmitter modulators released by nearby synaptic terminals (purple) regulate the synaptic strength of chemical and electrical synapses through activation of G protein-coupled metabotropic receptors. Regulation at chemical synapses could occur pre- or postsynaptically. **b** | Electrical and chemical synapses coexist at mixed synapses. Glutamatergic synapses regulate the strength of electrical synapses by a postsynaptic mechanism that includes the activation of NMDA receptors (NMDARs) and calcium/calmodulin-dependent protein kinase II (CaMKII). **c** | Regulation of electrical synapses by glutamatergic transmission could also be heterosynaptic. Nearby glutamatergic synapses can regulate electrical transmission through NMDAR or metabotropic glutamate receptor (mGluR) activation. **d** | Another mechanism of interaction at goldfish mixed synapses results when synaptic activity leads to mGluR activation, which in turn triggers endocannabinoid (eCB) release from the postsynaptic cell, and activates cannabinoid type 1 receptors (CB1Rs) on nearby dopaminergic fibres. CB1R activation leads to dopamine release that, by activating postsynaptic dopamine D1 receptors



some learning history

Descartes (1596-1650): "When the mind wills to recall something, this volition causes the little gland (the pineal), by inclining successively to different sides, to impel the animal spirits towards different parts of the brain, until they come upon that part where the traces are left of the thing it wishes to remember."

Ramón y Cajal (1894) "... mental exercise facilitates a greater development of the protoplasmic apparatus and of the nervous collaterals in the part of the brain in use. In this way, pre-existing connections between groups of cells could be reinforced by multiplication of the terminal branches of protoplasmic appendices and nervous collaterals."

D.O. Hebb (1949) "coincident activity" initiates the growth of new synaptic connections as part of long-term memory storage. "reverberatory circuit" for short-term memory.

Lashley (1963) Lesioning rat brains, trained to negotiate a maze. No evidence of localization of memory, memory deficits were related to the extent of the lesions. Lead to his theory of mass action

idea: molecules contain memory (transfer of molecule transfers memory)

Holger Hyden: new specific RNA is created for each memory. Hyden's hypothesis implied that the patterns of stimulation activated by learning could introduce changes in RNA.

(current interpretation: long term learning requires protein synthesis)

G Unger: memory specific peptide scotophobin. Could inject/transfer fear of the dark from rat to mouse. (Turned out to inhibit melatonin synthesis in pineal gland, and somehow that creates scotophobic behavior)

McConnell (1966). Classical conditioning of flatworms. Feed trained worms to untrained ones. Untrained ones show conditioned response (or learned faster). Same for T-maze experiments. But: random shocks had same effect than conditioning.

•

•

•



(a) Plasticity in a neural chain

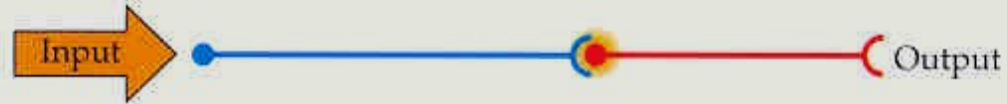

(b) Plasticity in a superordinate circuit

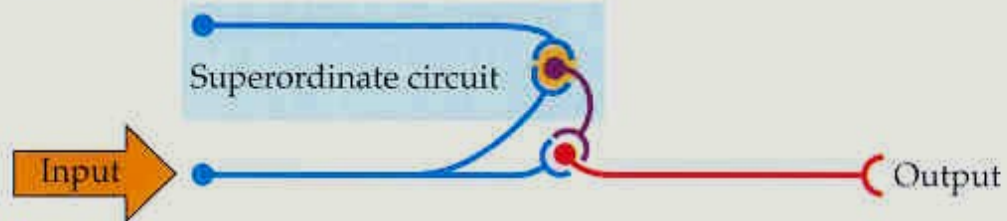

(c) Plasticity in a cell assembly



18.1 Sites of Synaptic Plasticity in Neural Networks

Changes at sites of synaptic plasticity—such as the sites shown here (highlighted in orange) in a neural chain (a), a superordinate circuit (b), and a cell assembly (c)—may underlie memory storage.

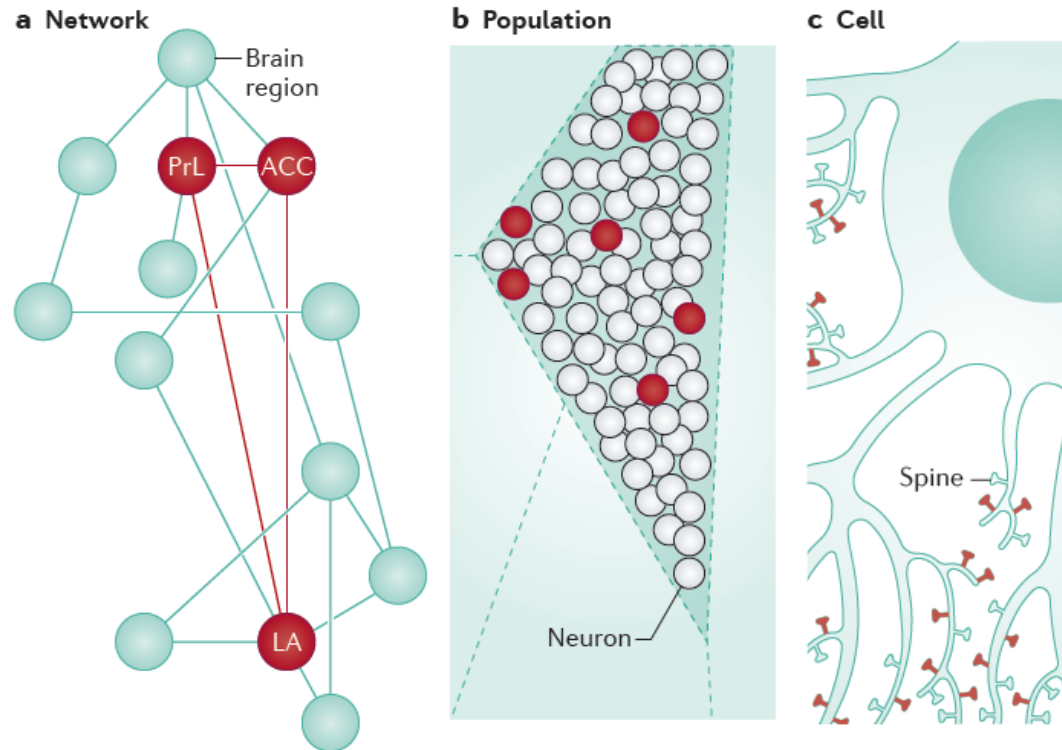

d Synapse

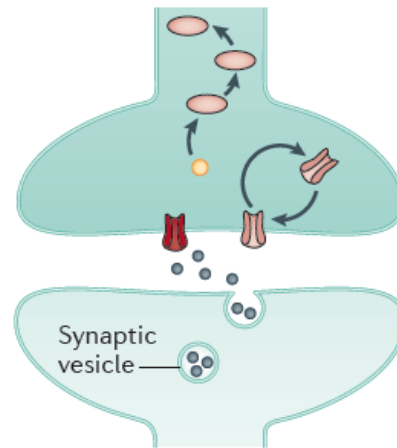

e Nucleus

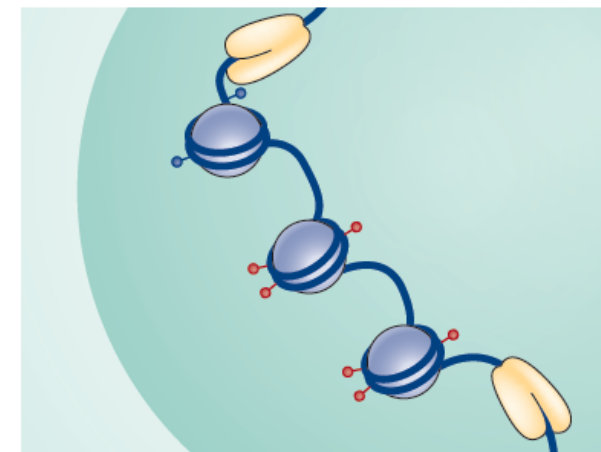

Ca ²⁺	Intracellular signalling molecule	DNA	Transcriptional machinery
Receptor	Neurotransmitter	Histone modification	Histone

Figure 2 | Multiple levels of analysis of an engram. Although engrams are thought to involve strengthening of connections between neurons (neuronal ensembles) widely distributed throughout the brain, the engram can be probed at different scales and levels of analysis. This schematic depicts the components of a hypothetical fear engram (shown in red) at different levels of analysis, from a brain network to a neuronal nucleus. **a** | At the brain network level, a subset of brain regions may be involved in this engram. Red lines depict functional connections between these engram brain regions. Cyan lines depict underlying anatomical connections between brain regions. **b** | At the neuronal population level, subsets of neurons within a brain region may be involved in this engram. **c** | With the formation of each engram, changes occur at the level of individual neurons (for example, changes in the pattern of connectivity). **d** | Changes can also occur at subsets of synapses (for example, synaptic strengthening). **e** | At the nuclear level, the engram can be reflected in transcriptional and epigenetic changes. ACC, anterior cingulate cortex; LA, lateral amygdala; PrL, prelimbic cortex.

Before training

After training

(a) Changes involving synaptic transmitters

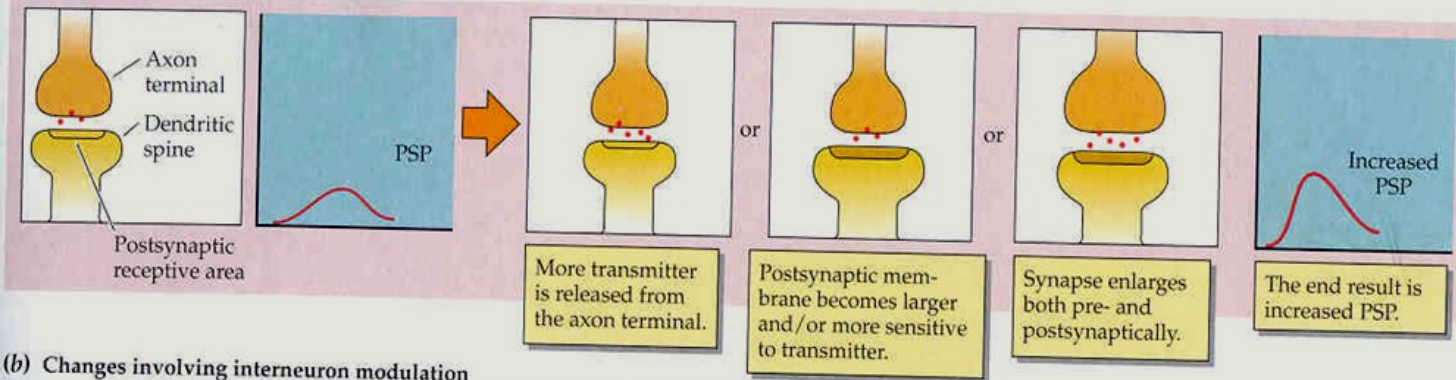

(b) Changes involving interneuron modulation

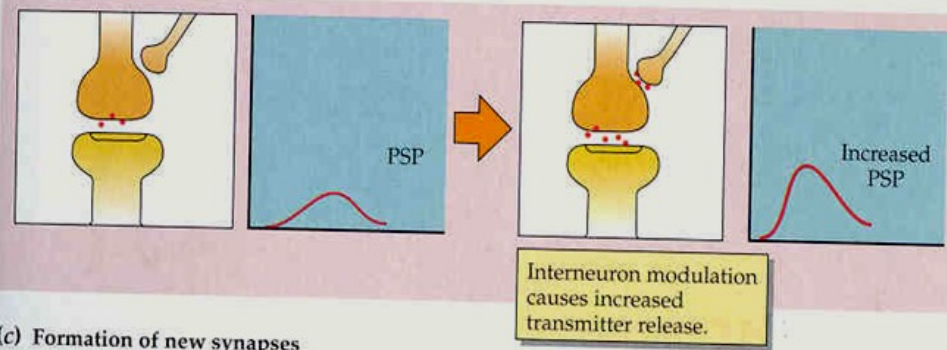

(c) Formation of new synapses

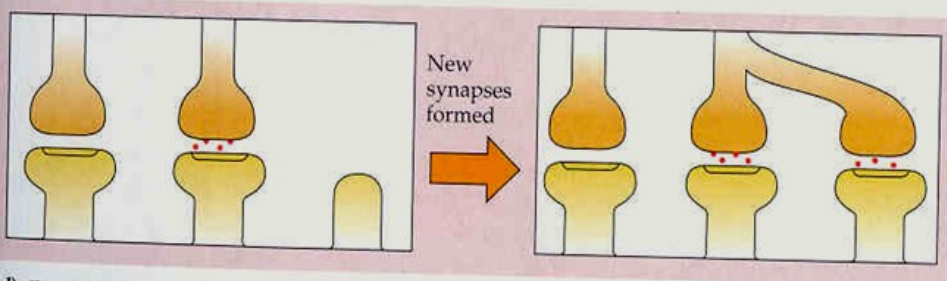

(d) Rearrangement of synaptic input

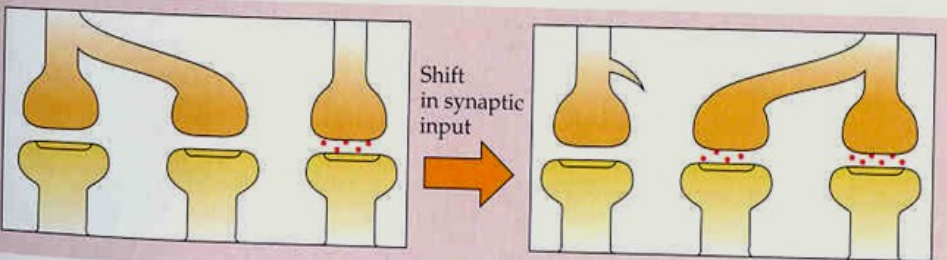

18.2 Synaptic Changes That May Store Memories After training, each action potential in the relevant neural circuit causes increased release of transmitter molecules (red dots). The postsynaptic potential (PSP) therefore increases in size (as indicated by the graphs). (a) An increase in size of the postsynaptic receptor membrane causes a larger response to the same amount of transmitter release. (b) An interneuron modulates the polarization of the axon terminal and causes the release of more transmitter molecules per nerve impulse. (c) A neural circuit that is used more often increases the number of synaptic contacts. (d) A more frequently used neural pathway takes over synaptic sites formerly occupied by a less active competitor.

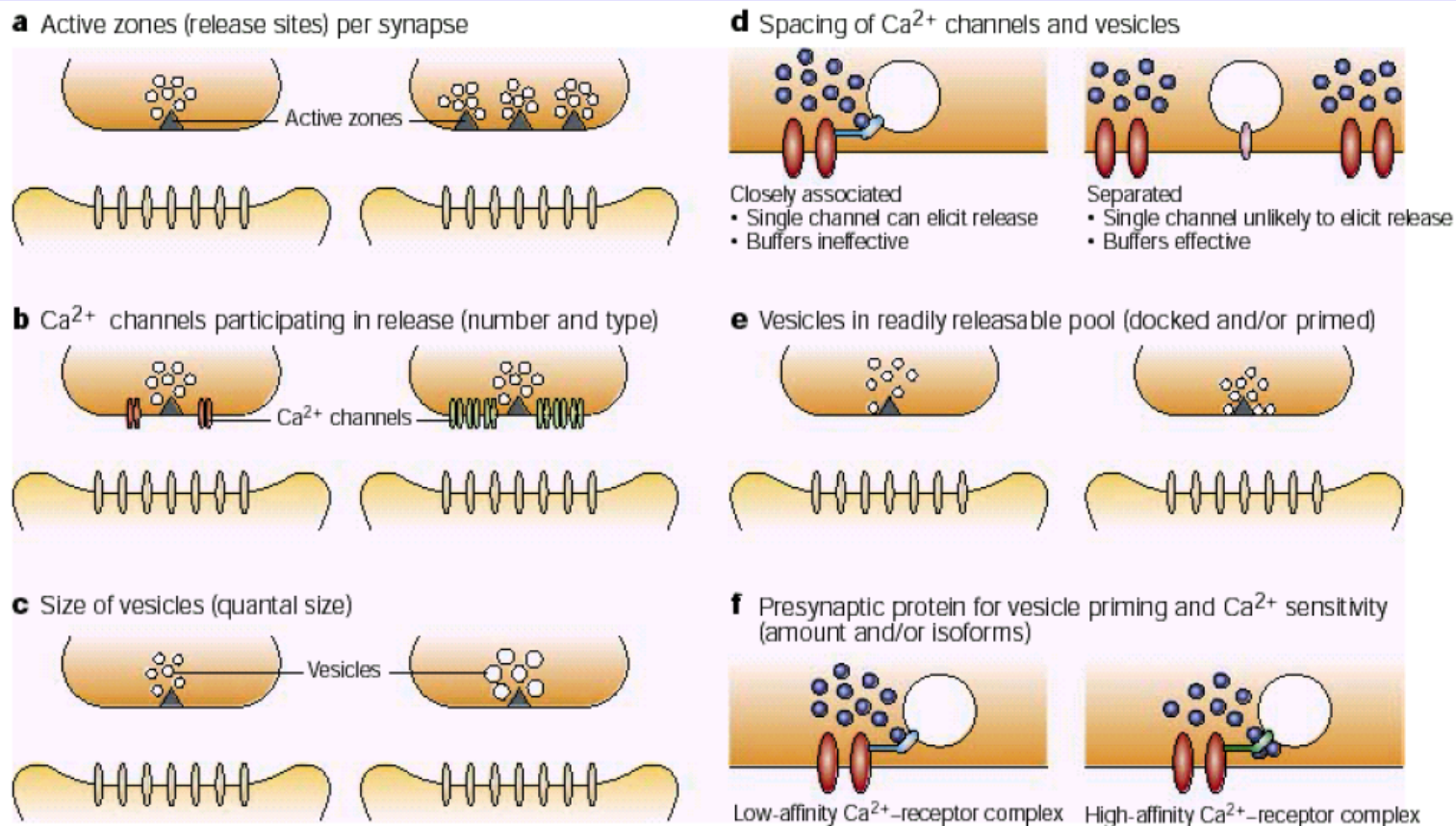
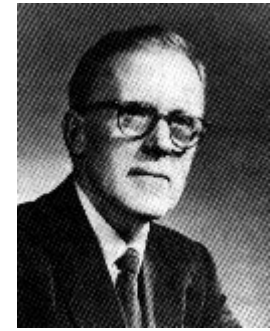
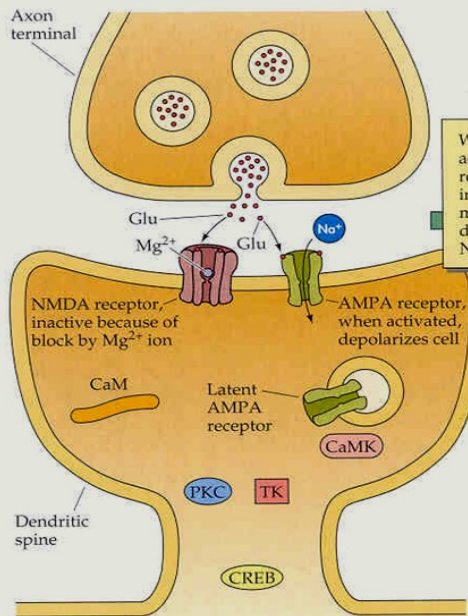

Figure 3 | Presynaptic determinants of synaptic strength. Several hypothetical mechanisms are illustrated. **a** | Individual synapses have different numbers of release sites (active zones). An extreme example is the calyx of Held in the mammalian auditory pathway. **b** | Voltage-dependent Ca^{2+} channels at individual active zones differ in number and/or type, allowing more Ca^{2+} to enter at some active zones after a nerve impulse, eliciting the fusion of more synaptic vesicles. **c** | Synaptic vesicles differ in size, generating correspondingly different quantal units that depend on their transmitter content. **d** | The effectiveness of individual Ca^{2+} channels to cause vesicle fusion depends on channel-vesicle spacing. Intracellular buffers have a more significant influence on transmission when channels and vesicles are more separated. **e** | Synaptic vesicles that are available for release (close to or docked at the synaptic membrane, and appropriately primed) are more numerous at some synapses. **f** | Qualitative and quantitative differences in presynaptic proteins impart different properties to the Ca^{2+} receptors, affecting the probability of vesicular fusion after Ca^{2+} entry.



(a) Normal synaptic transmission



(b) Induction of LTP

With repeated activation of AMPA receptors, the change in postsynaptic membrane potential drives Mg²⁺ out of NMDA channel.

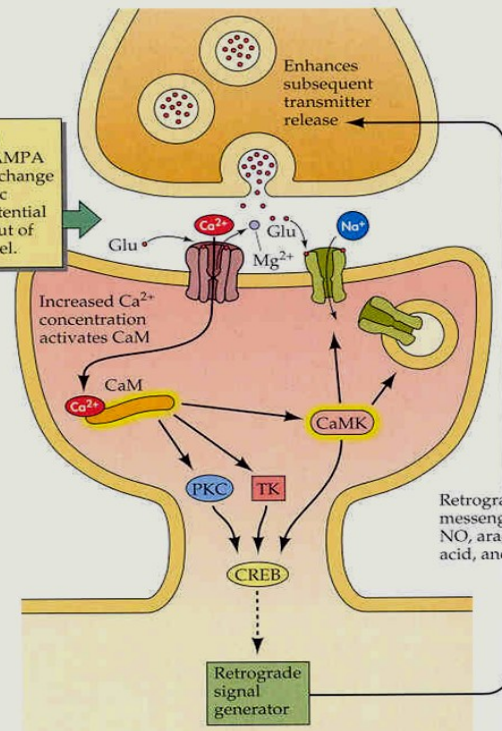

(c) Enhanced synapse, after induction of LTP

These changes make the synapse more responsive.

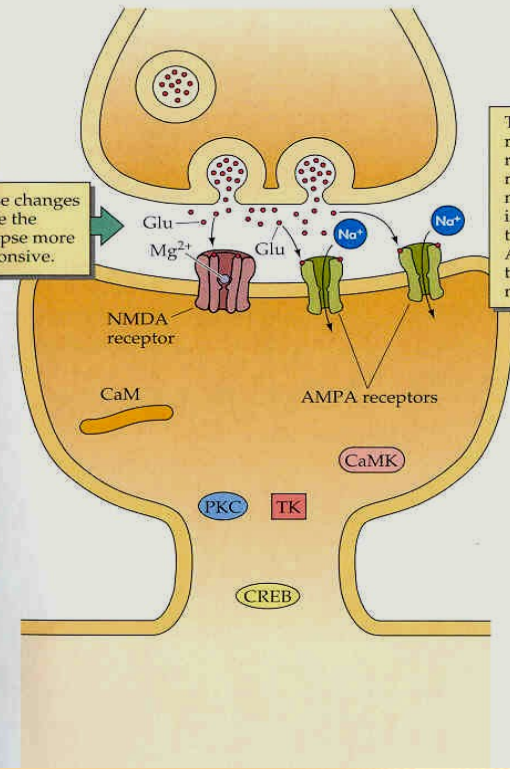

The synapse is now ready to give more-rapid and stronger response, because more transmitter is released and there are more AMPA receptors in the postsynaptic membrane.

Presynaptic action potentials

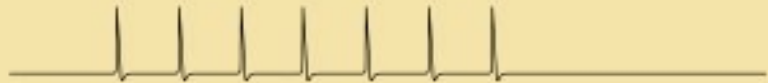

A. Summation

Postsynaptic E_m

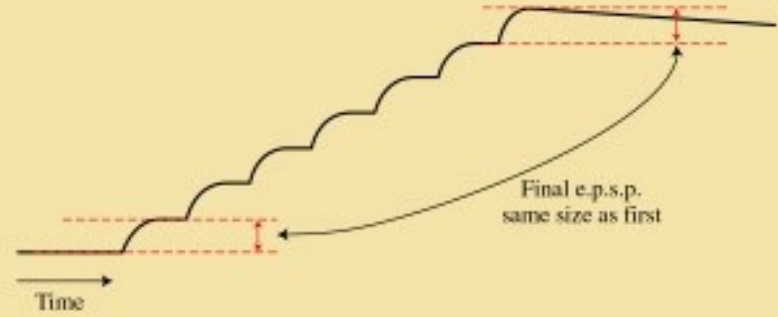

B. Facilitation

Postsynaptic E_m

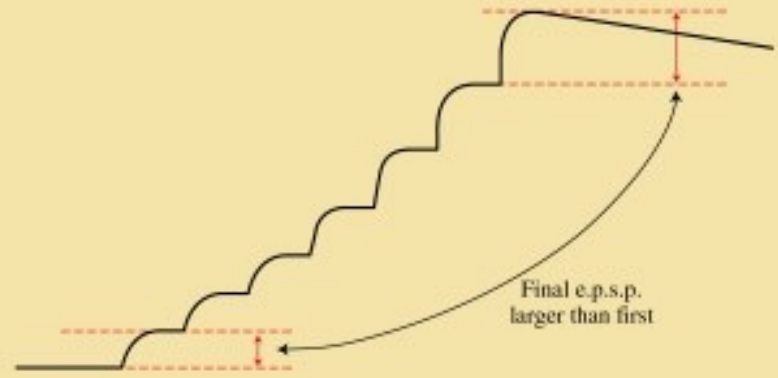

C. Depression

Postsynaptic E_m



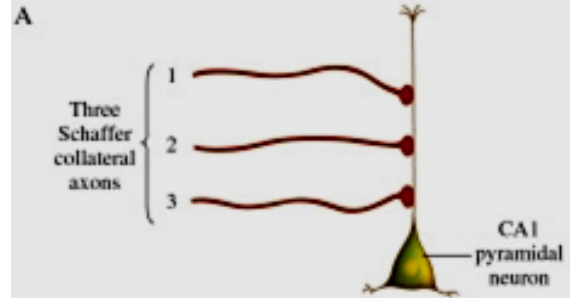

B. Before potential

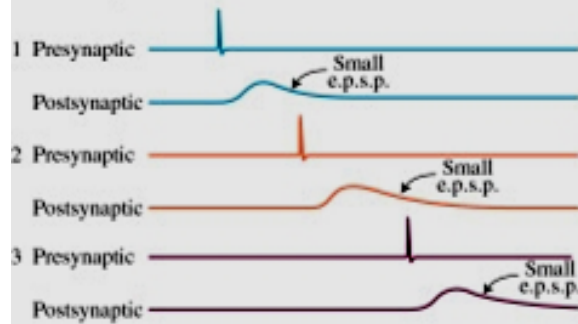

C. Potentiation stimulus

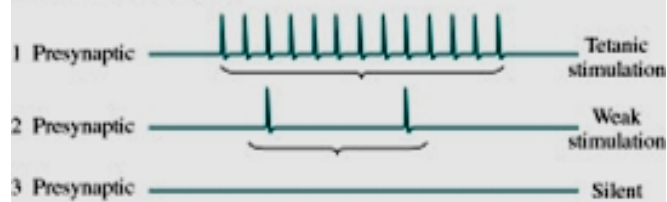

D. Test response 1 hour later

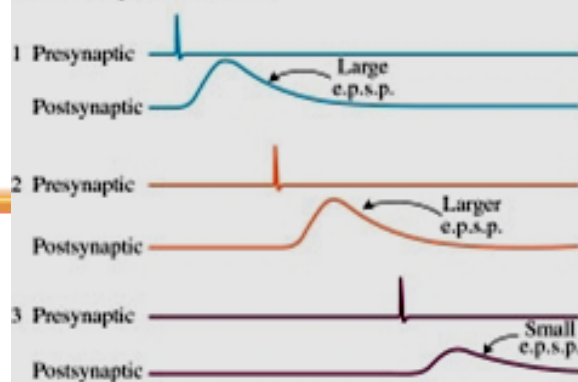

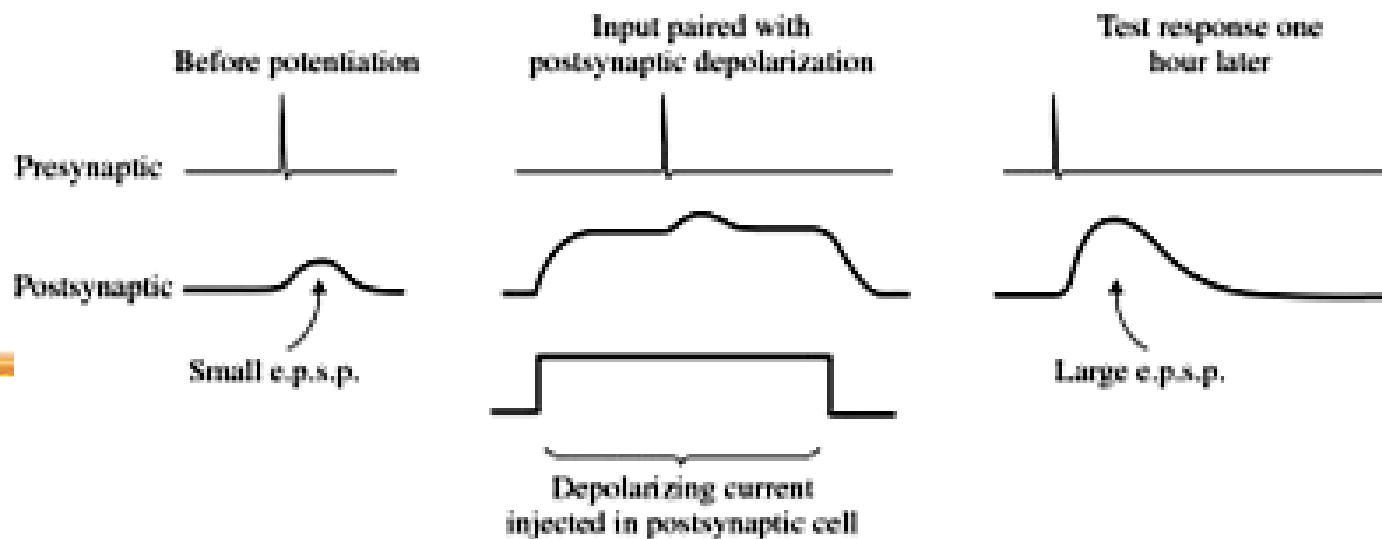
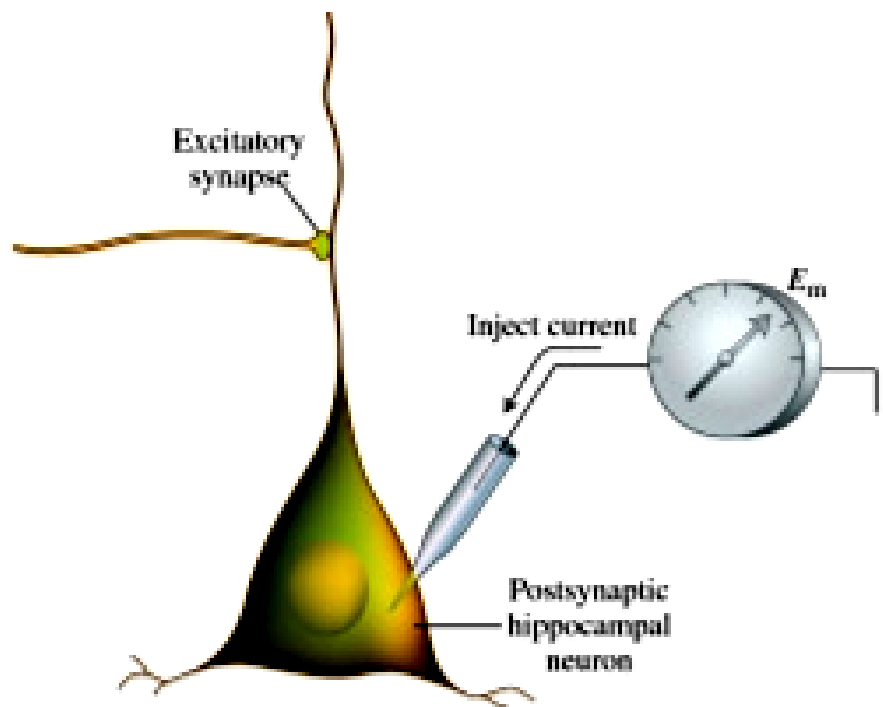

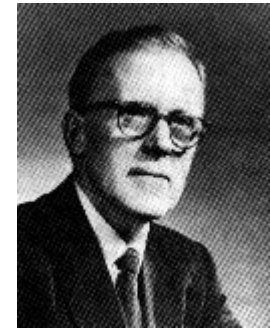

(a) Normal synaptic transmission

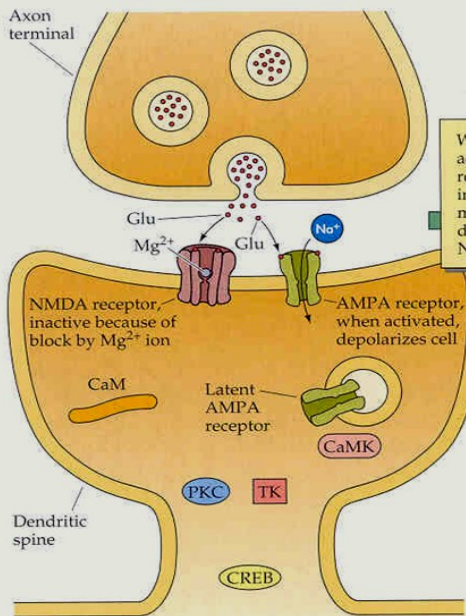

(b) Induction of LTP

With repeated activation of AMPA receptors, the change in postsynaptic membrane potential drives Mg^{2+} out of NMDA channel.

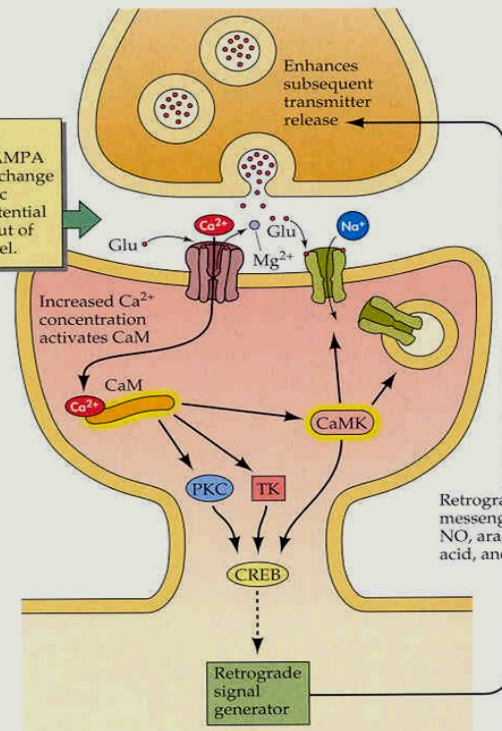

(c) Enhanced synapse, after induction of LTP

These changes make the synapse more responsive.

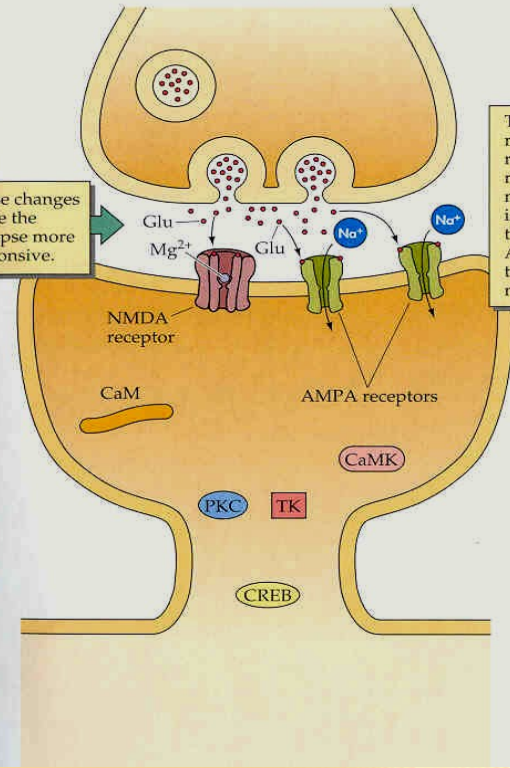

The synapse is now ready to give more-rapid and stronger response, because more transmitter is released and there are more AMPA receptors in the postsynaptic membrane.

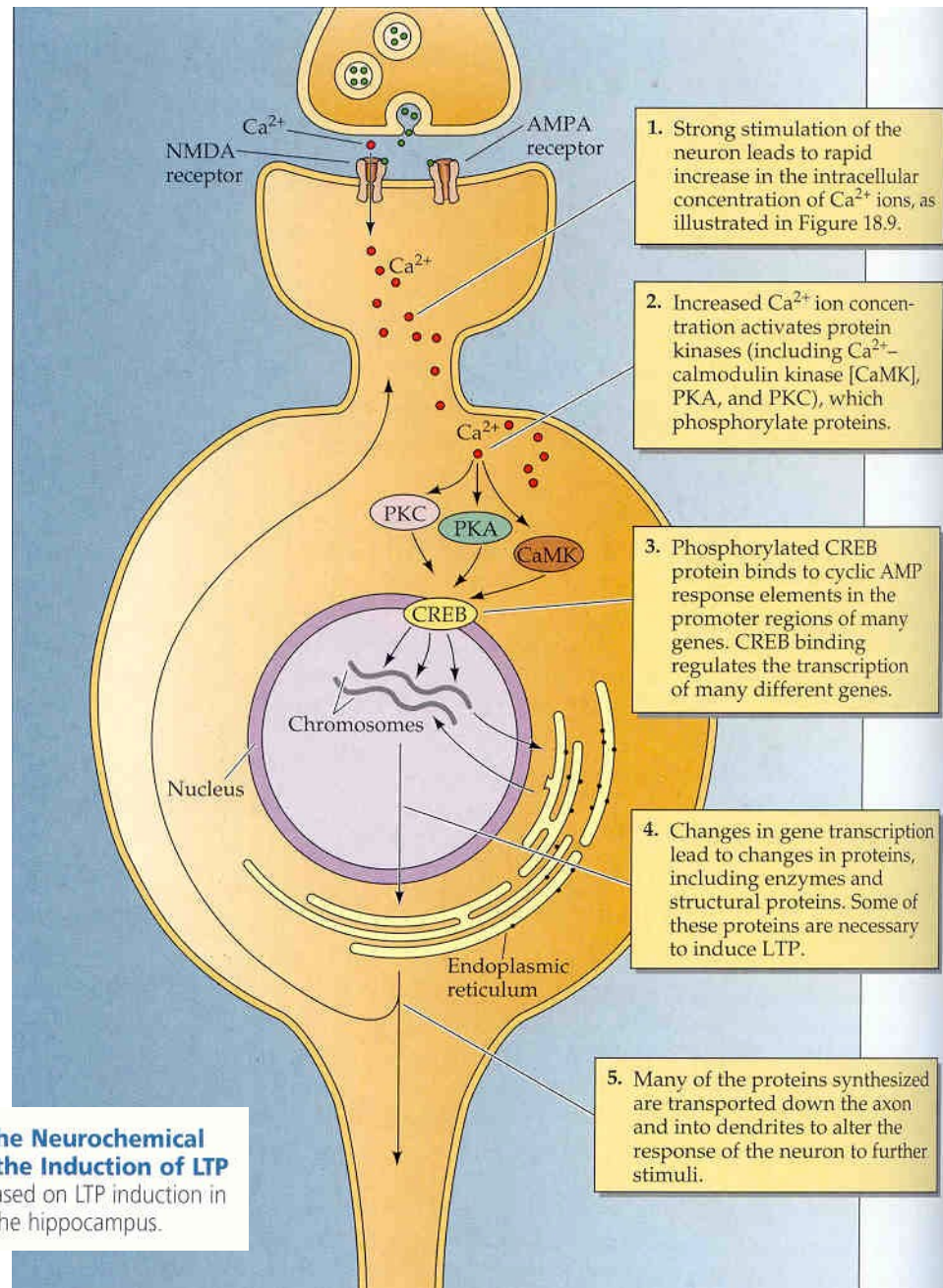

18.10 Steps in the Neurochemical Cascade during the Induction of LTP

This illustration is based on LTP induction in the CA1 region of the hippocampus.



Molecular Biology of Memory Storage:

The Persistence of Memory



The Study of Memory Has Two Parts:

(1) The *Systems* Problem of Memory:

Where in the brain is memory stored?

(2) The *Molecular* Problem of Memory:

How is memory stored at each site?

There are Two Major Forms of Long-Term Memory

Explicit (Declarative)

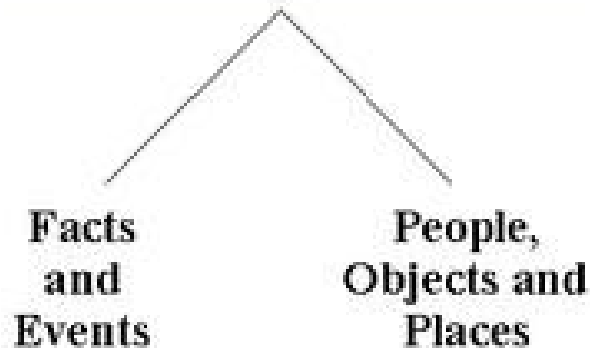

Medial Temporal Lobe
Hippocampus

Requires Conscious Attention

Implicit (Procedural)

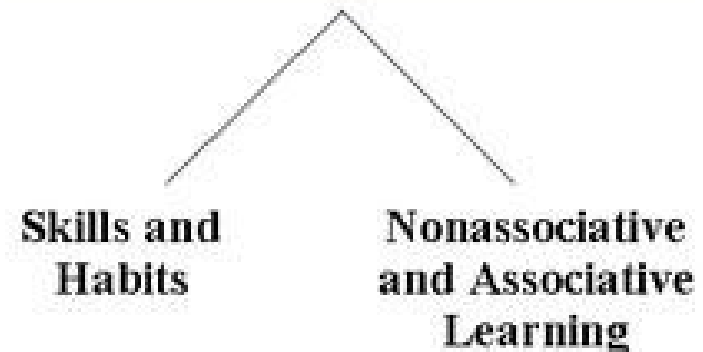

Amygdala, Cerebellum,
Reflex Pathways

Does Not Require Conscious Attention

There are Two Major Forms of Long-Term Memory

Explicit (Declarative)



**Place:
Spatial Memory**

**Medial Temporal Lobe
Hippocampus**

Requires Conscious Attention

Implicit (Procedural)



**Nonassociative Learning:
Learned Fear (Sensitization)**

Reflex Pathways

Does Not Require Conscious Attention

Implicit and Explicit Memory Share 3 Features in Common

1 There are Stages to Memory Storage

2 Repetition Converts Short- to Long-Term Memory

3 Long-Term Memory Requires New Protein Synthesis

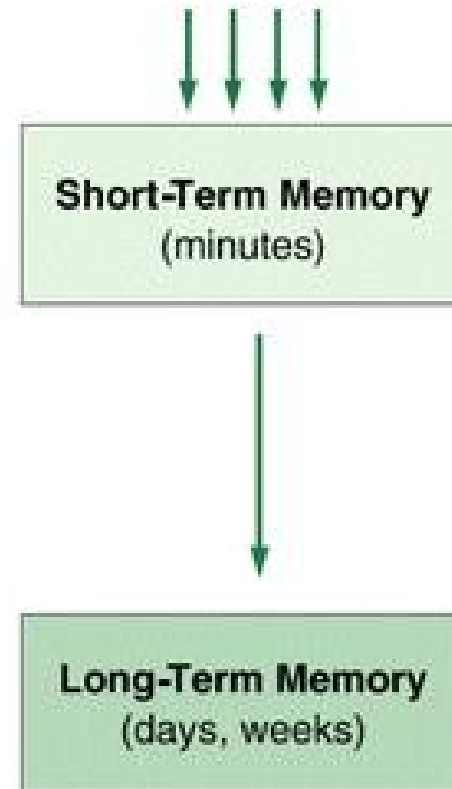

**The Human Brain
is complex:
 10^{12} Neurons**

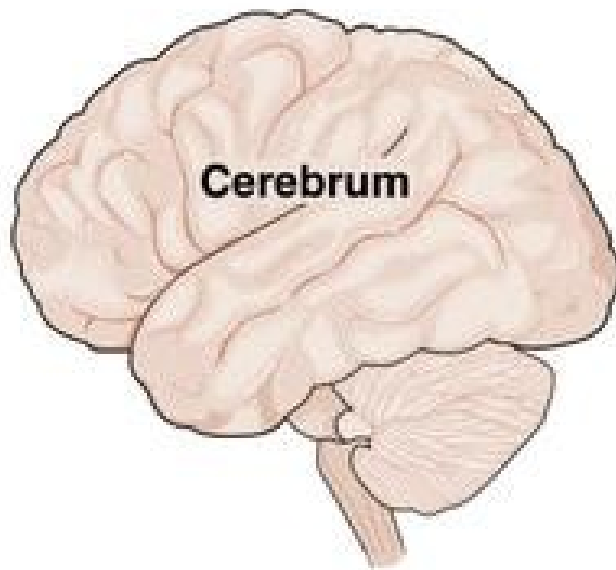

**The *Aplysia* Brain
is simple:
 2×10^4 Neurons**

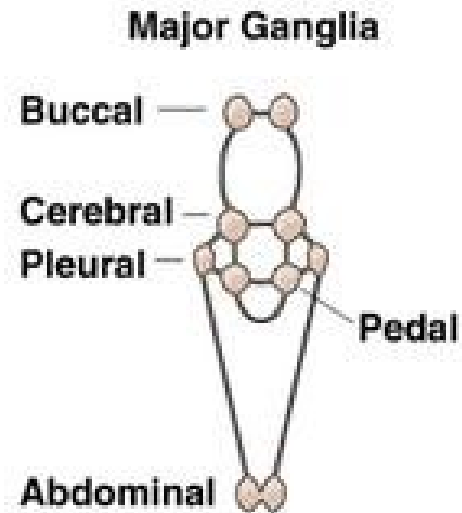

**The Gill Withdrawal Reflex has a Simple Stereotypical Neural Circuit.
Repetition of Sensitization Training Leads to Altered Gene Expression
and the Growth of New Synaptic Connections.**

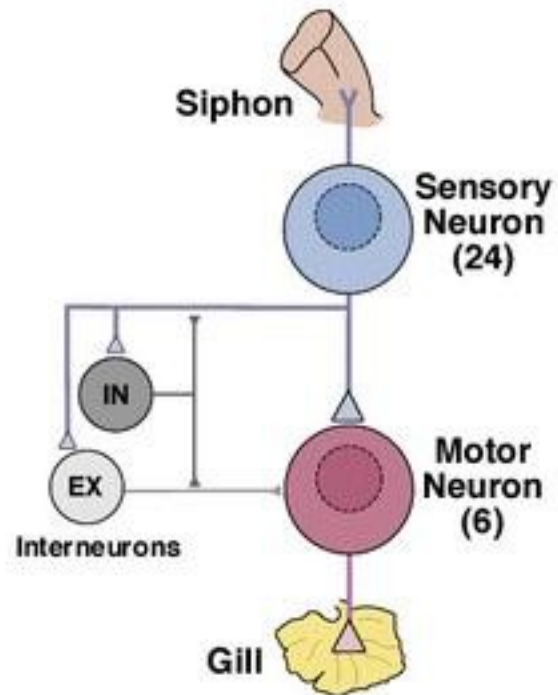

**The Gill Withdrawal Reflex has a Simple Stereotypical Neural Circuit.
Repetition of Sensitization Training Leads to Altered Gene Expression
and the Growth of New Synaptic Connections.**

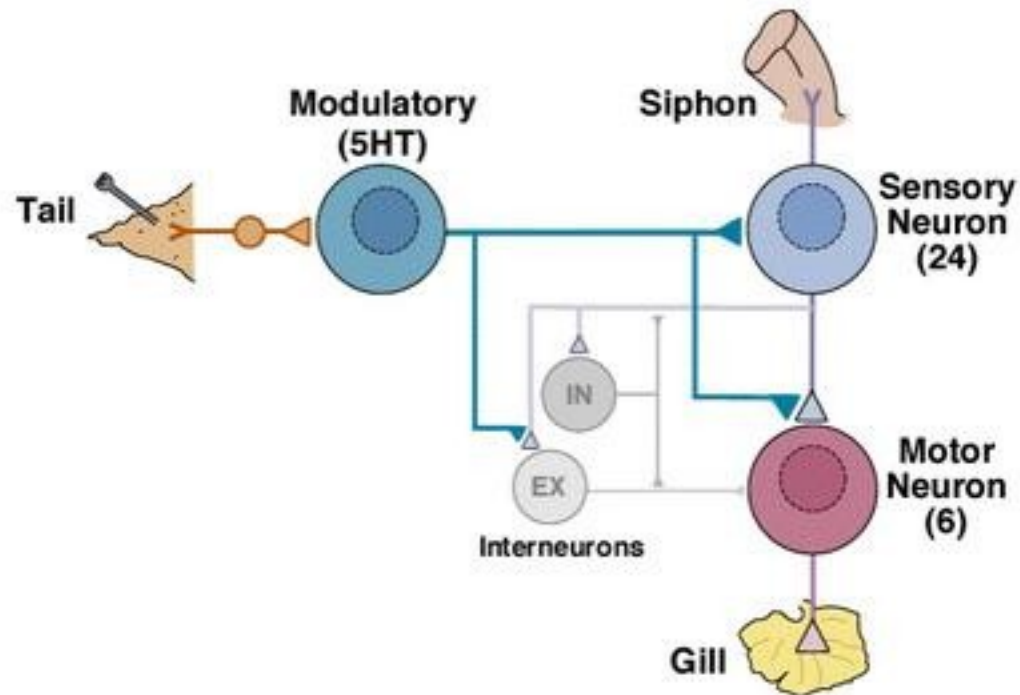

**The Gill Withdrawal Reflex has a Simple Stereotypical Neural Circuit.
Repetition of Sensitization Training Leads to Altered Gene Expression
and the Growth of New Synaptic Connections.**

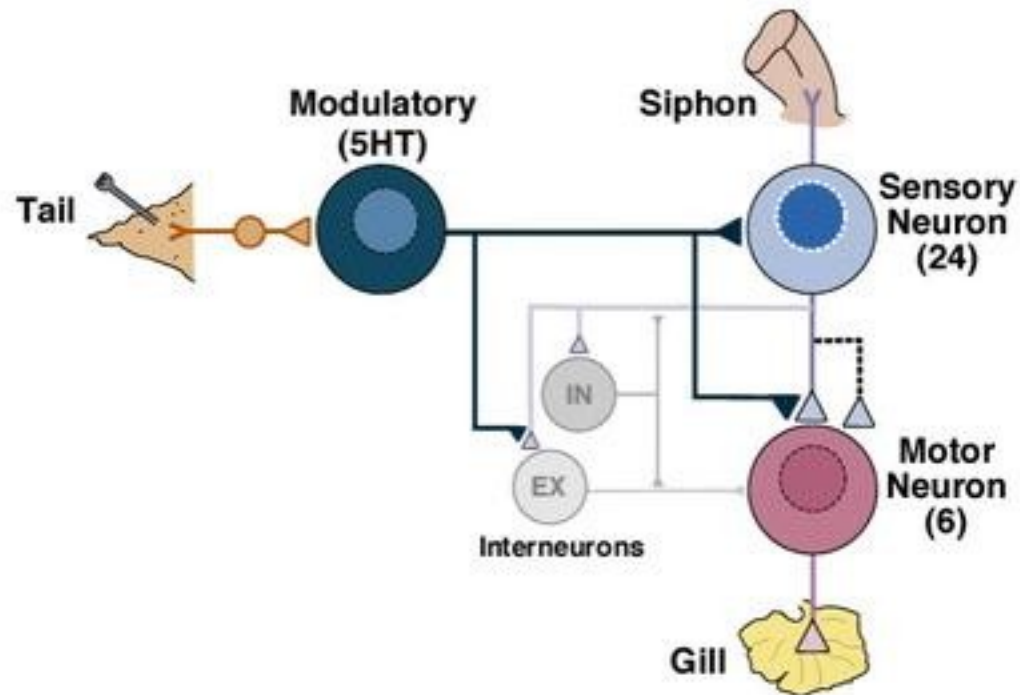



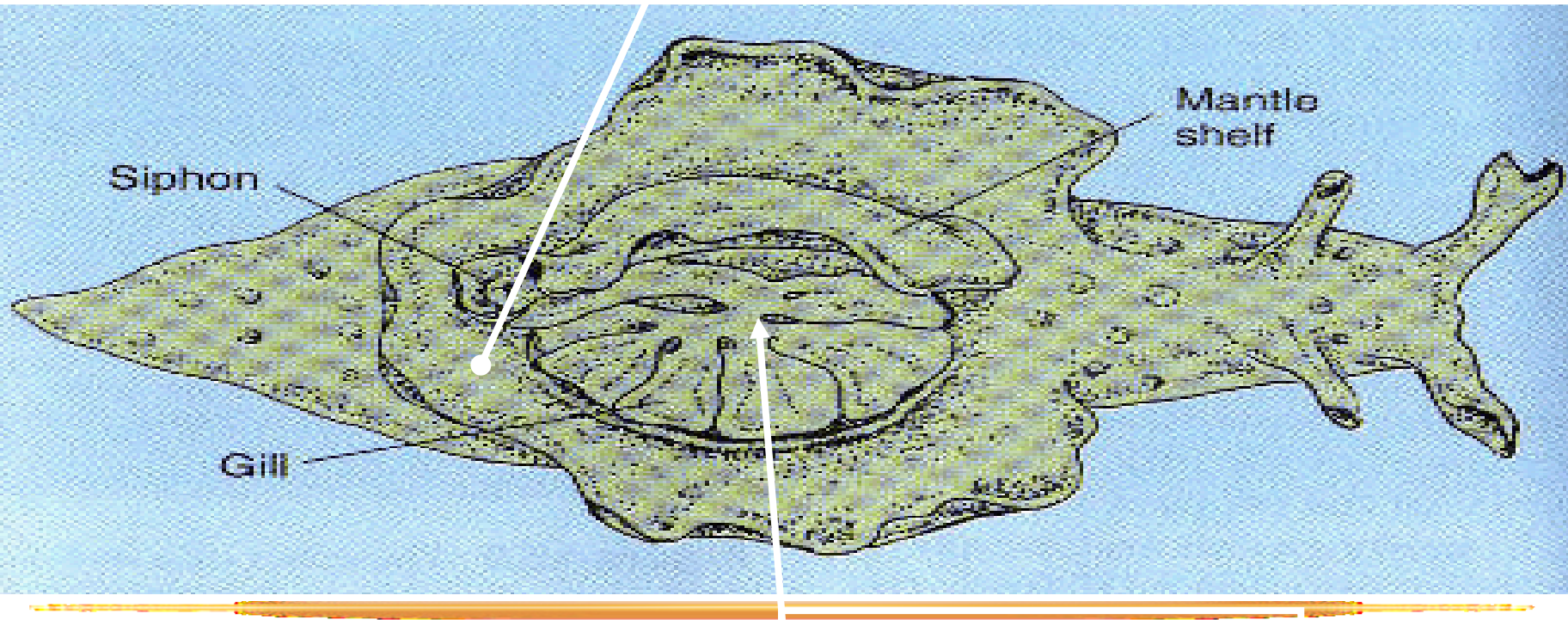

Siphon

Mantle shelf

Gill

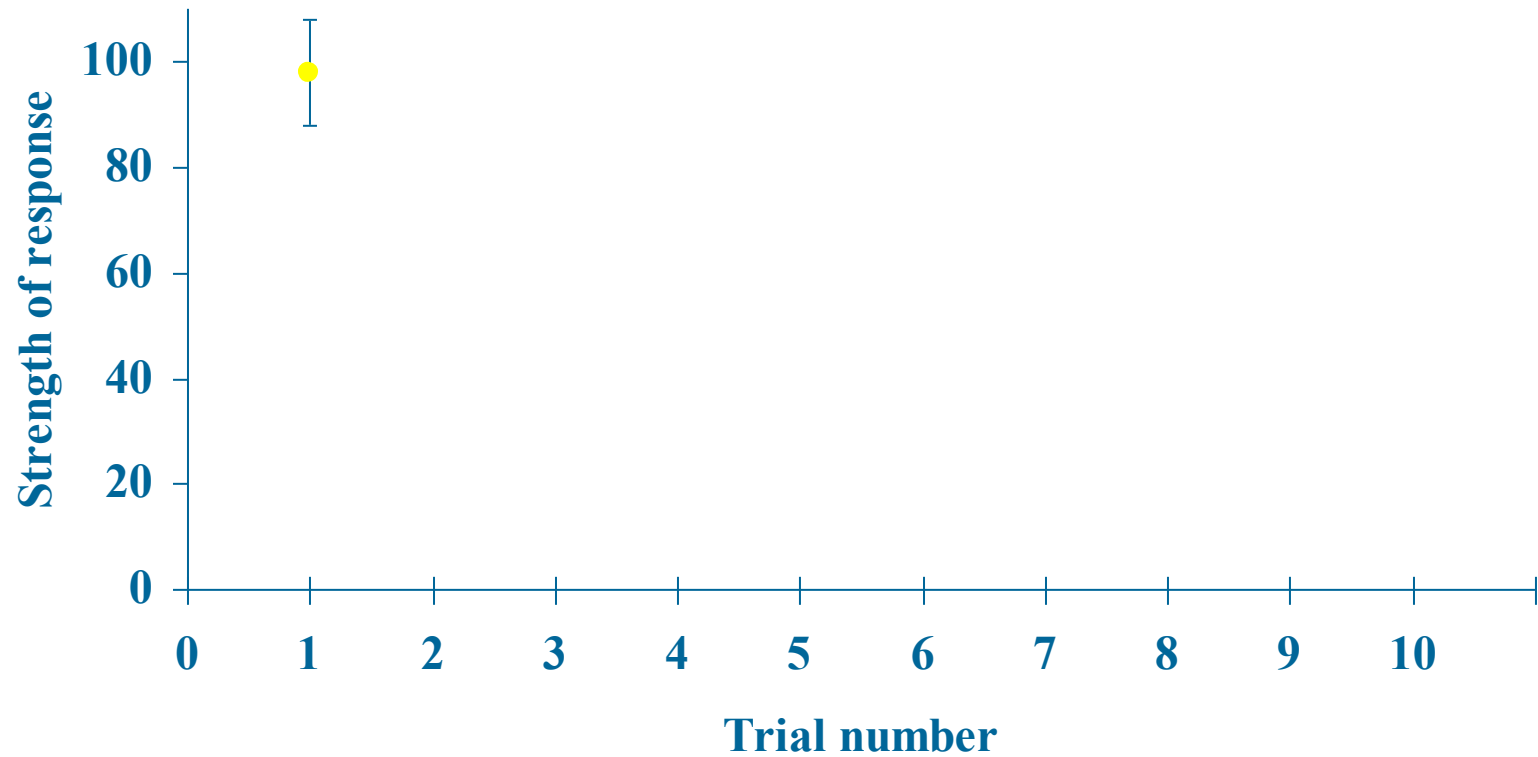

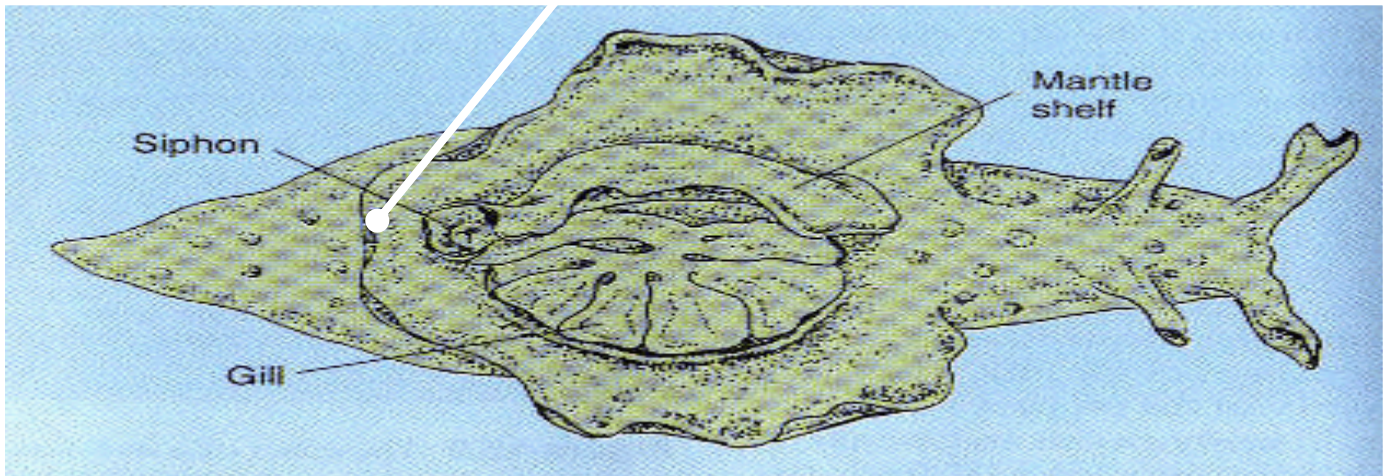

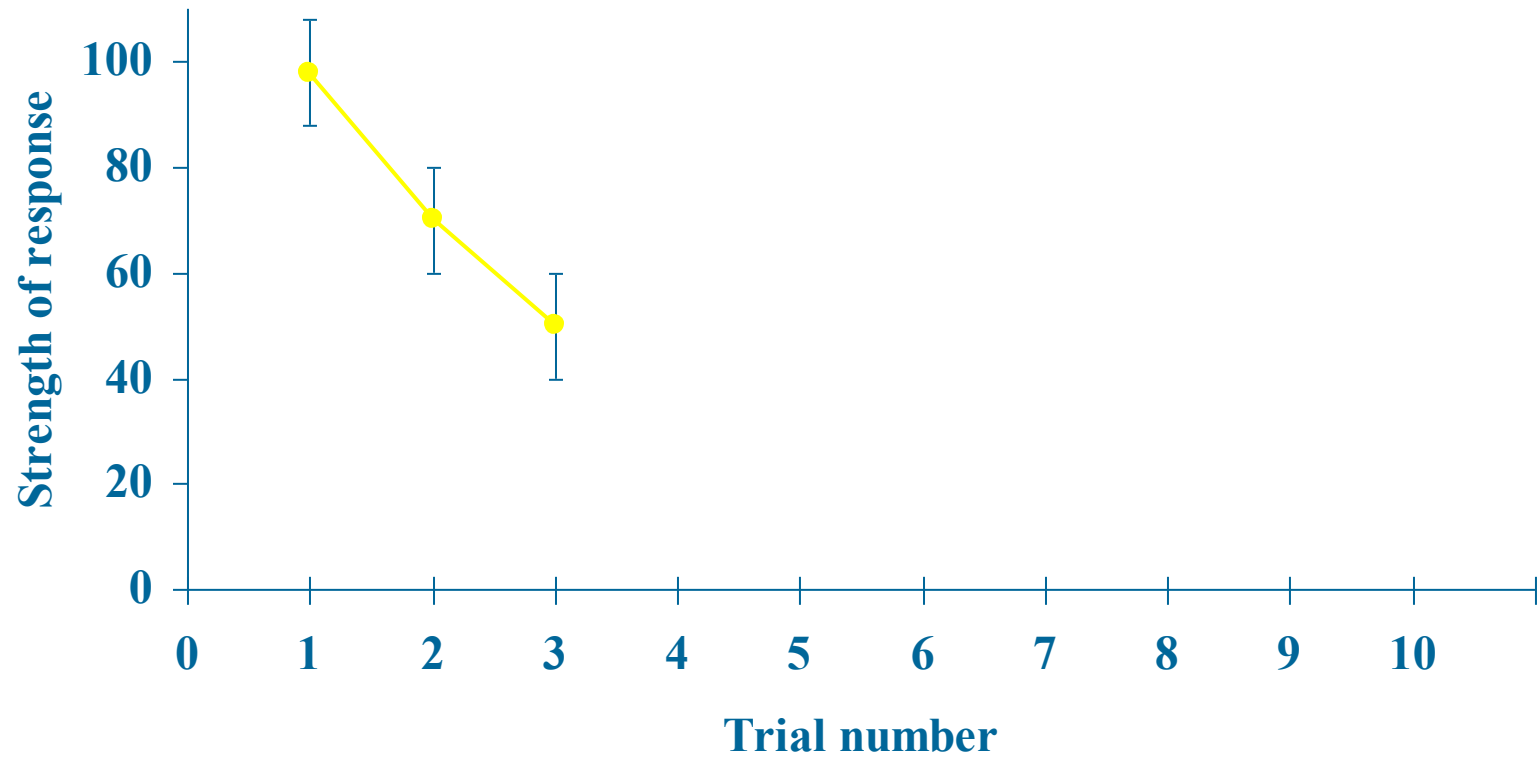

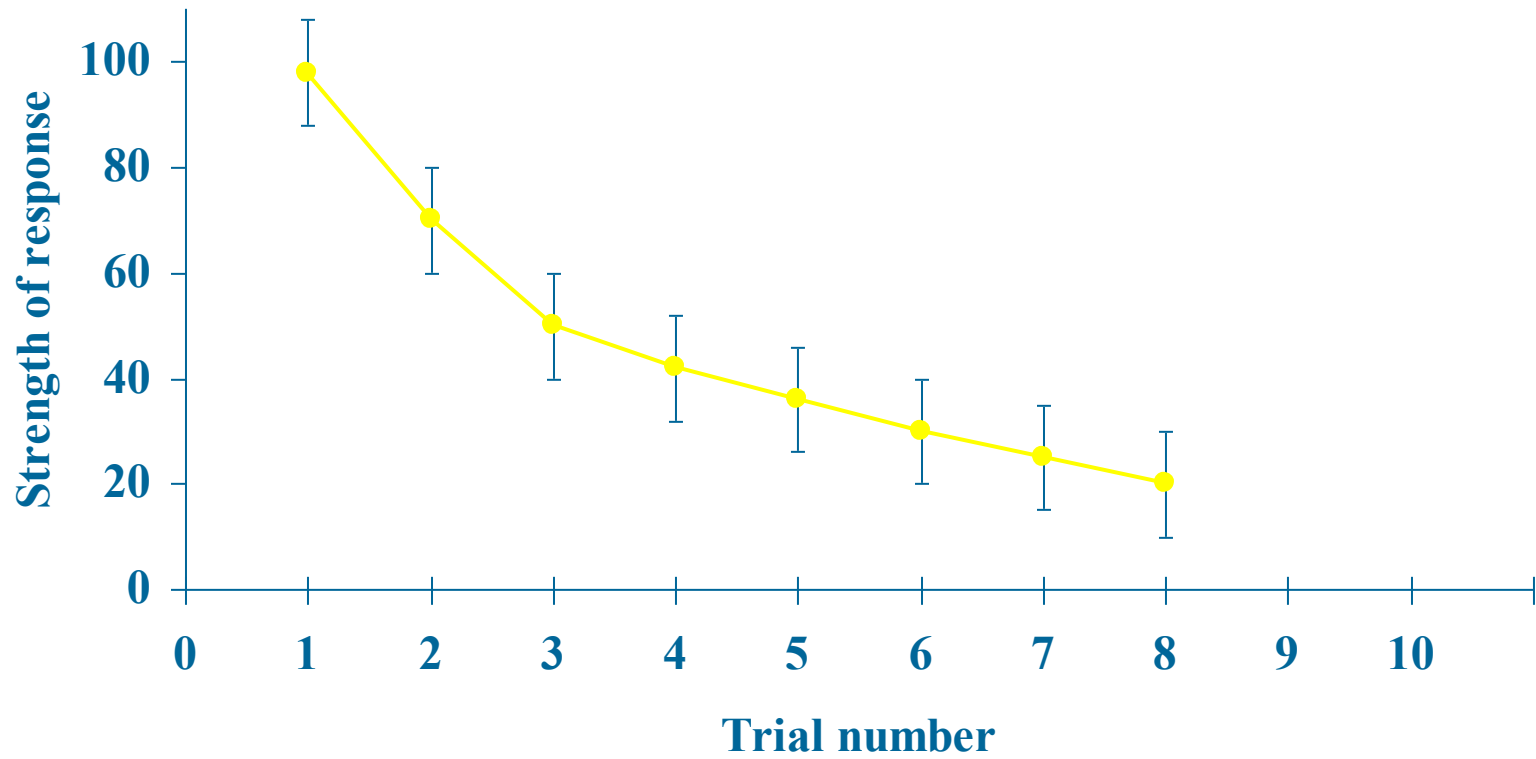

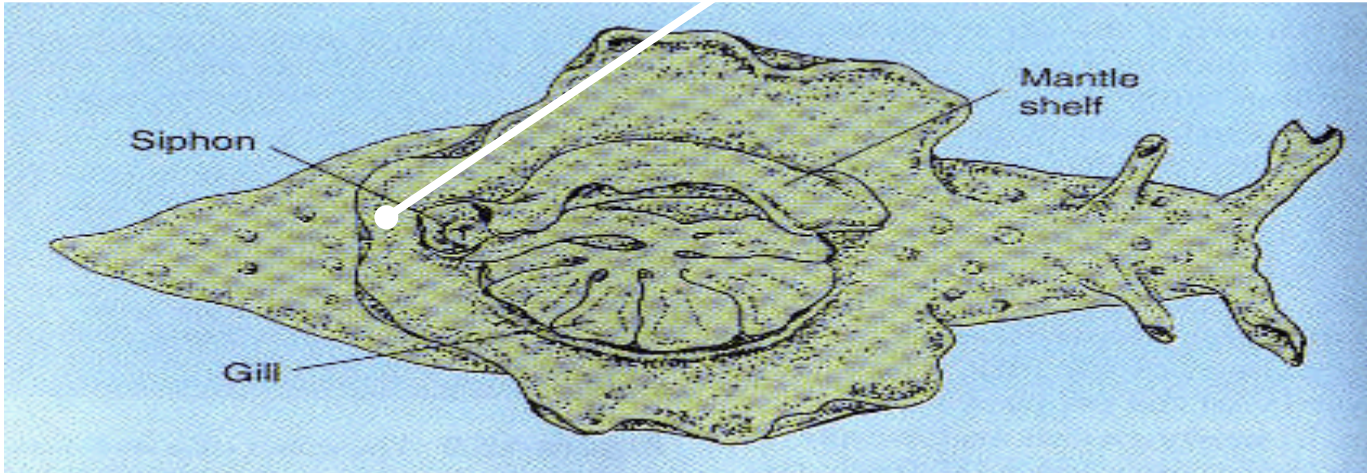

habituation - measuring the effectiveness of synaptic transmission
decrease of number of transmitter vesicles from the presynaptic
sensory neuron

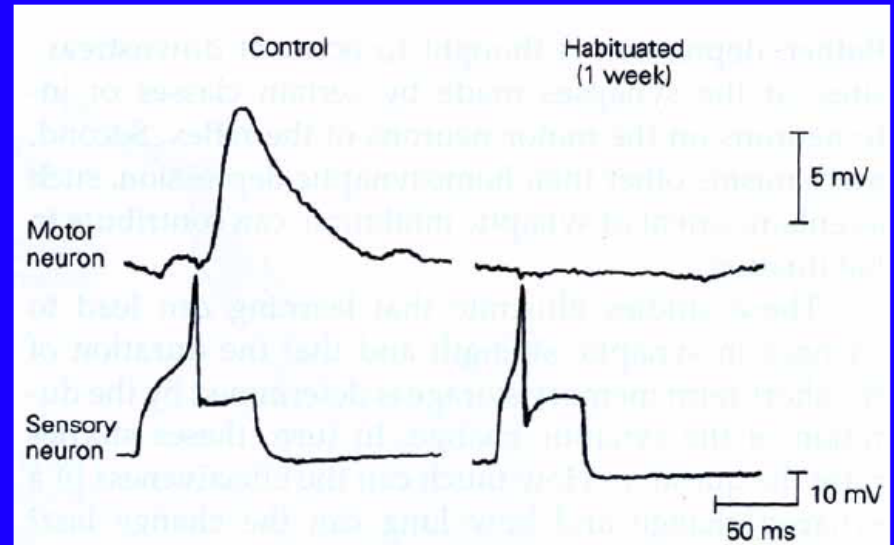
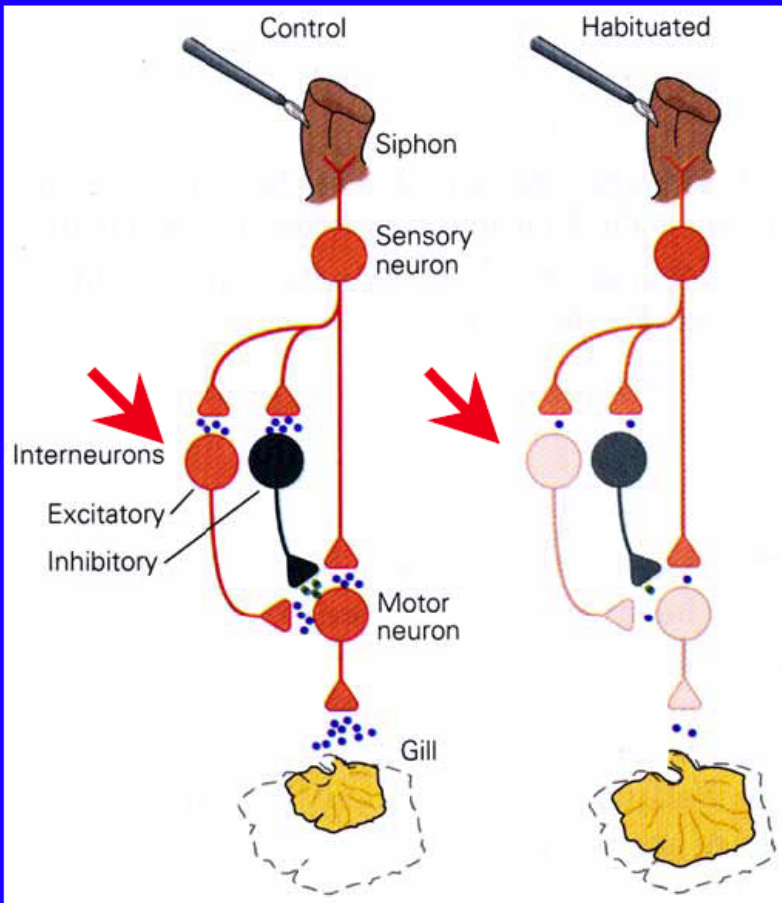

short-term habituation (1×10
stimuli): synaptic depression
long-term habituation (4×10
stimuli over hours or days):
reduction of synaptic contacts

from: Kandel, Schwartz, Jessell: Principles of Neural Science

Reconstruction of the Gill Withdrawal Reflex in Tissue Culture

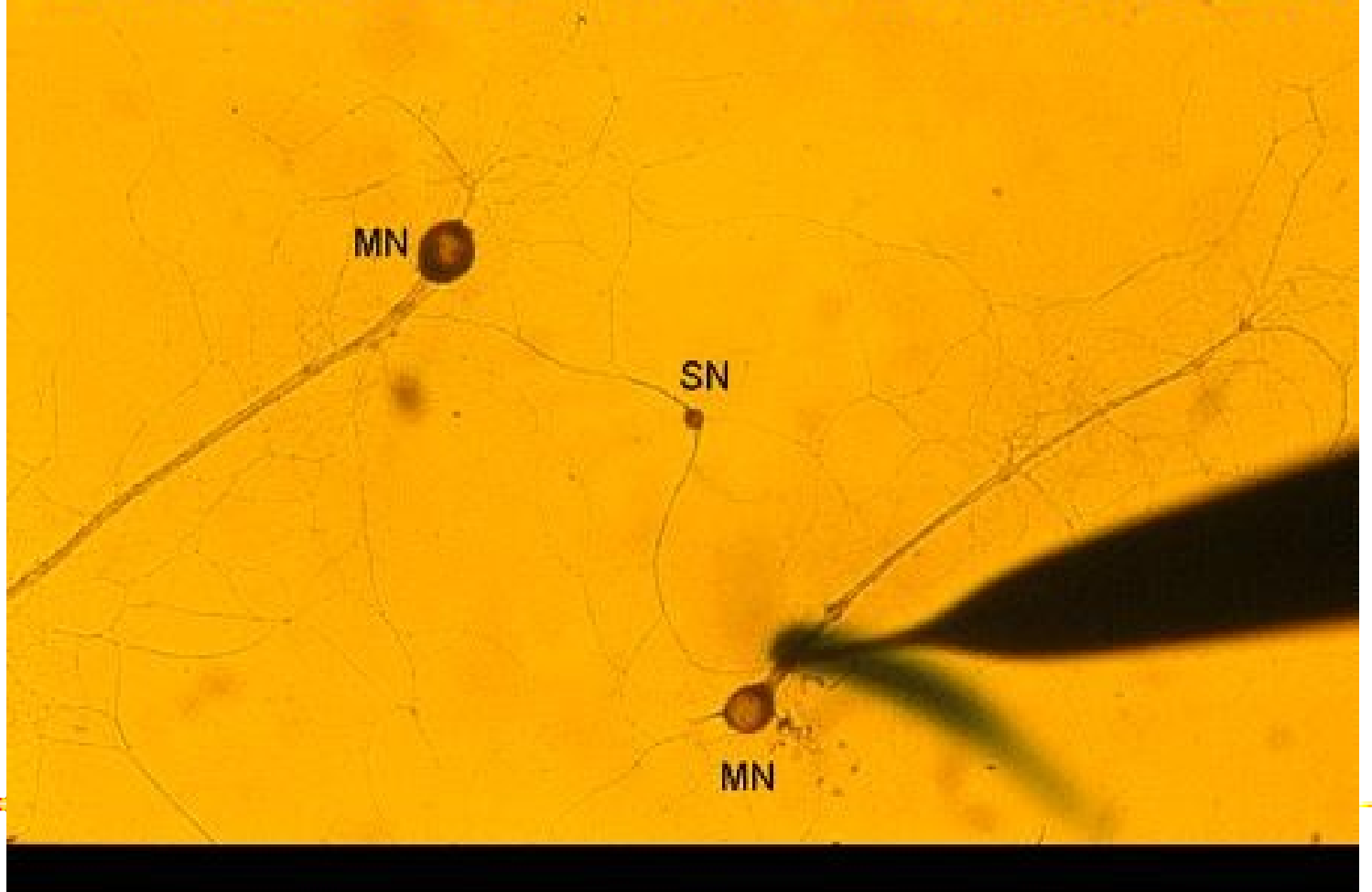

(A)

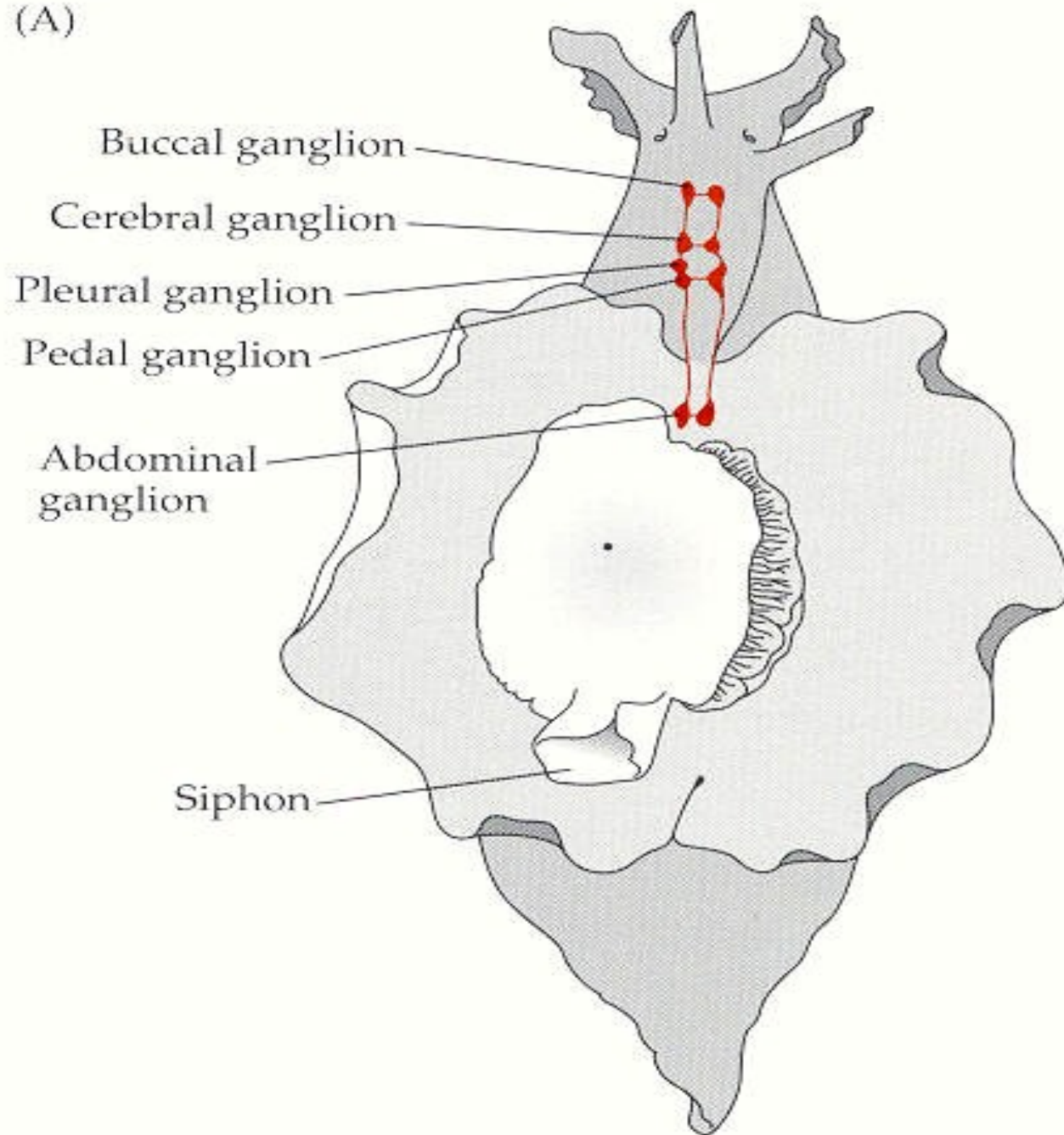

Habituace



SIFON

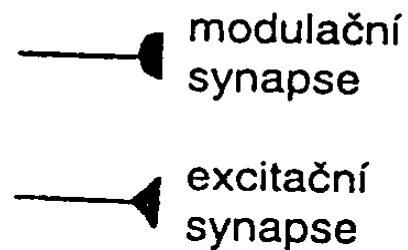
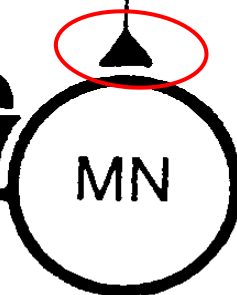
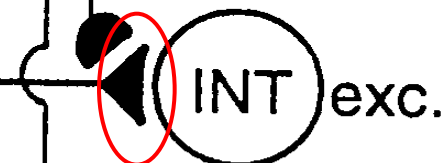
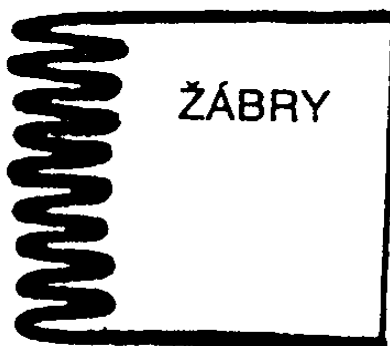
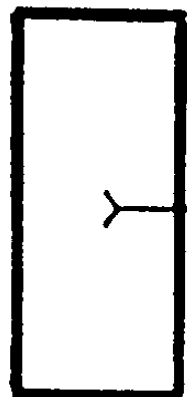

A. THE REFLEX BEHAVIOR

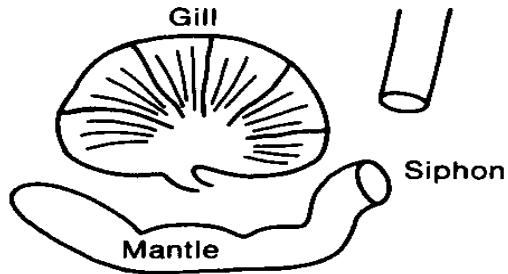

1. Normal, Unstimulated

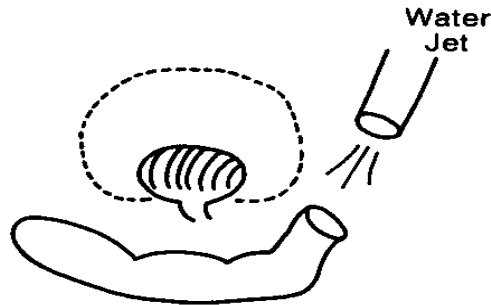

2. Initial Withdrawal

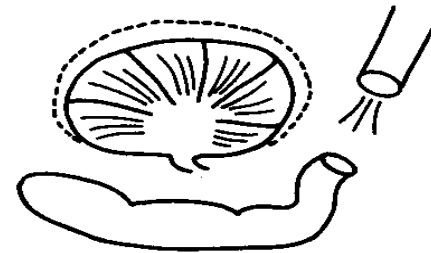

3. Withdrawal after Habituation

B. ELECTROPHYSIOLOGICAL ANALYSIS

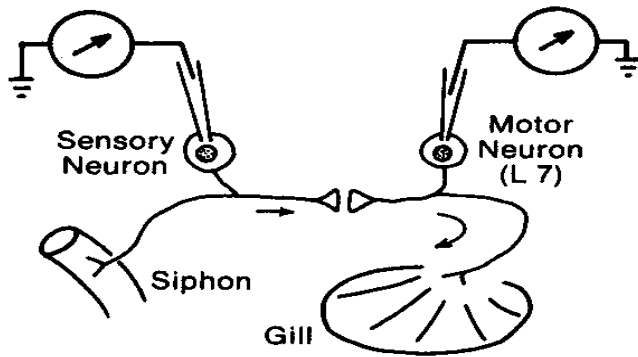

Experimental Set-up

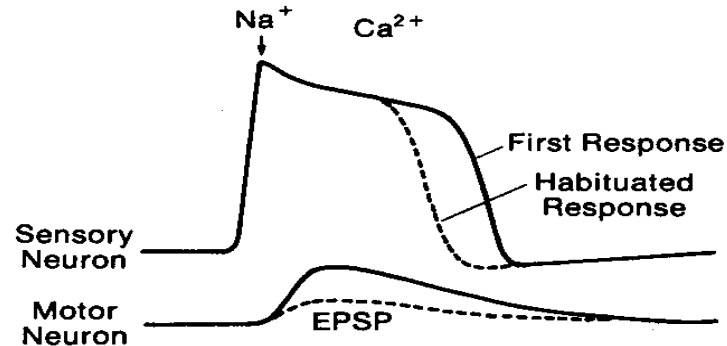

Recordings Before and After Habituation

Krátkodobá habituace díky inaktivaci Ca kanálů.

C. CONCEPTUAL MODELS

SHORT-TERM HABITUATION

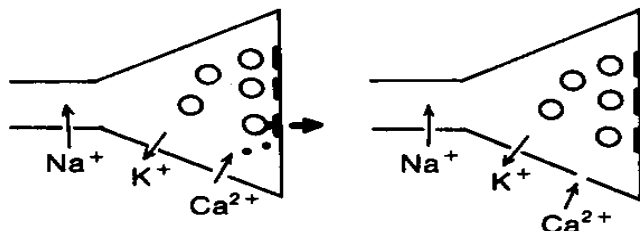

Normal

Habituated

LONG-TERM HABITUATION

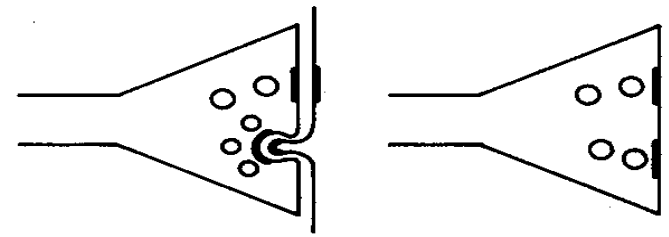

Normal

Habituated

A. THE REFLEX BEHAVIOR

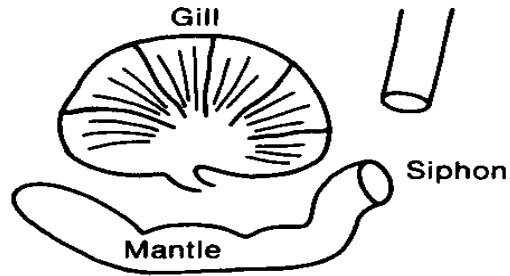

1. Normal, Unstimulated

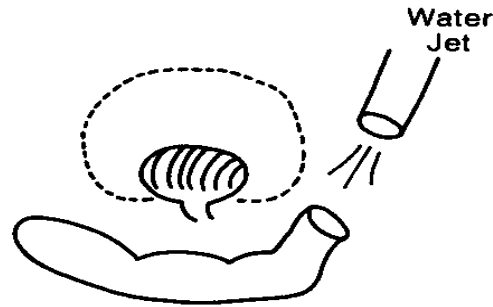

2. Initial Withdrawal

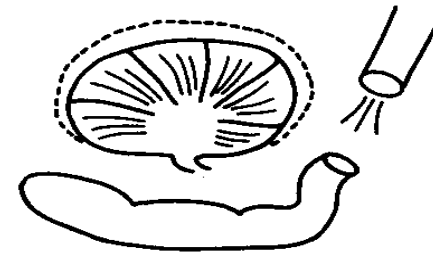

3. Withdrawal after Habituation

B. ELECTROPHYSIOLOGICAL ANALYSIS

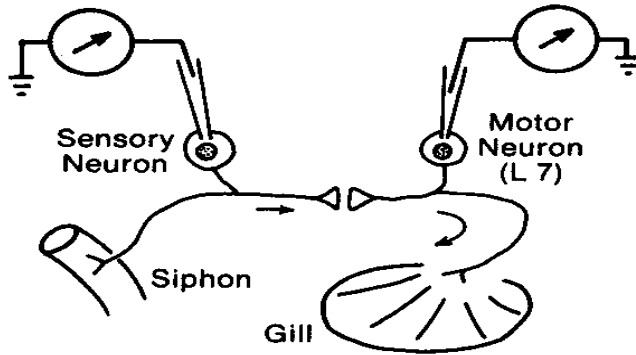

Experimental Set-up

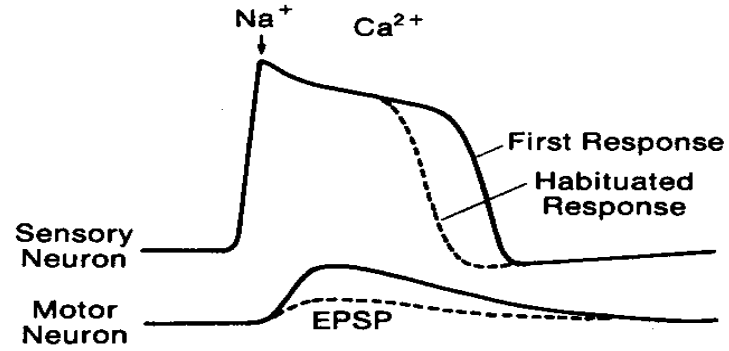

Recordings Before and After Habituation

DLouhodobá habituace díky přestavbě synapse.

C. CONCEPTUAL MODELS

SHORT-TERM HABITUATION

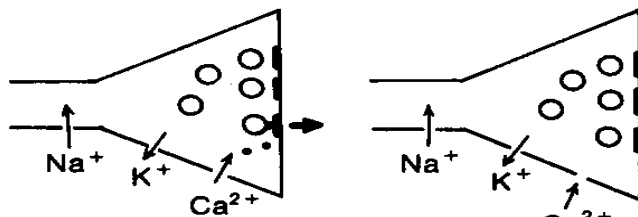

Normal

Habituated

LONG-TERM HABITUATION

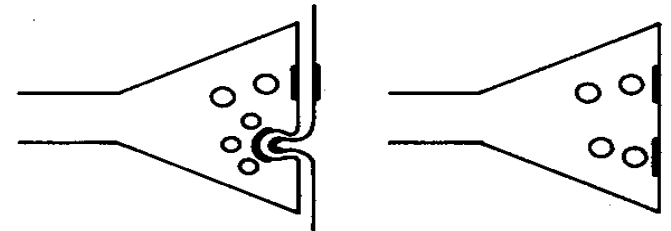

Normal

Habituated

zvýšení



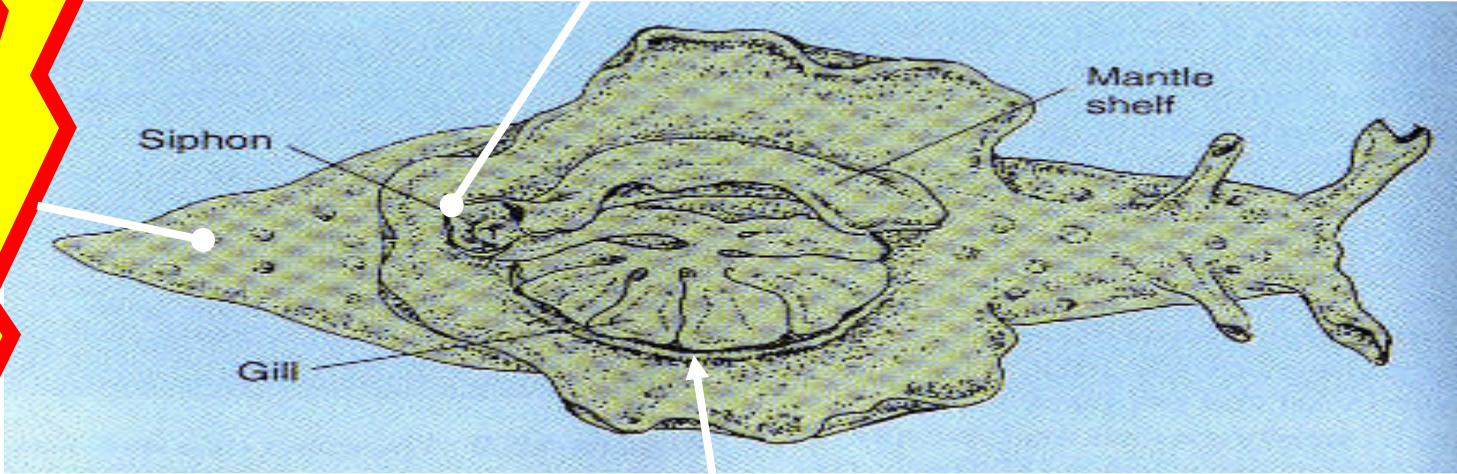

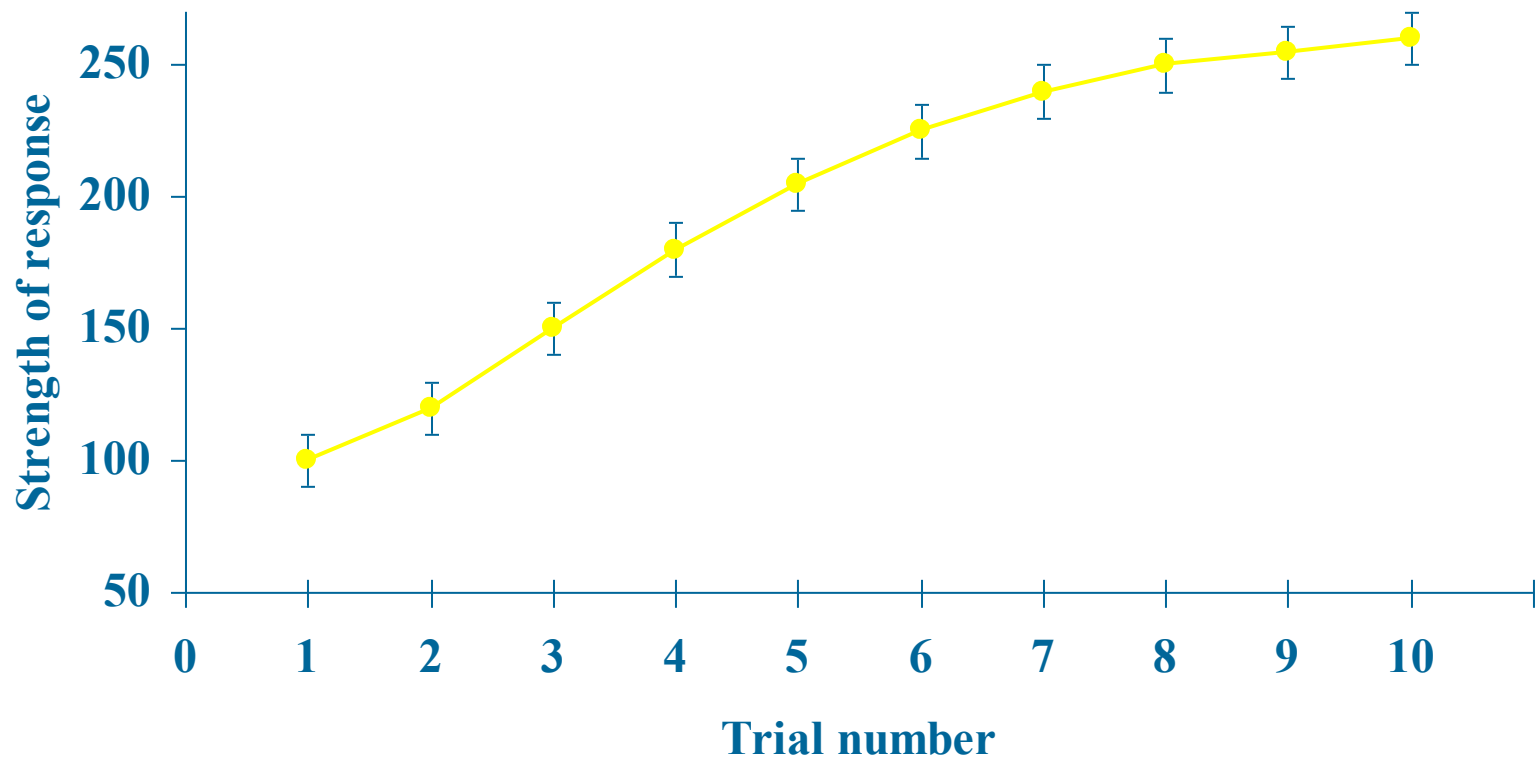

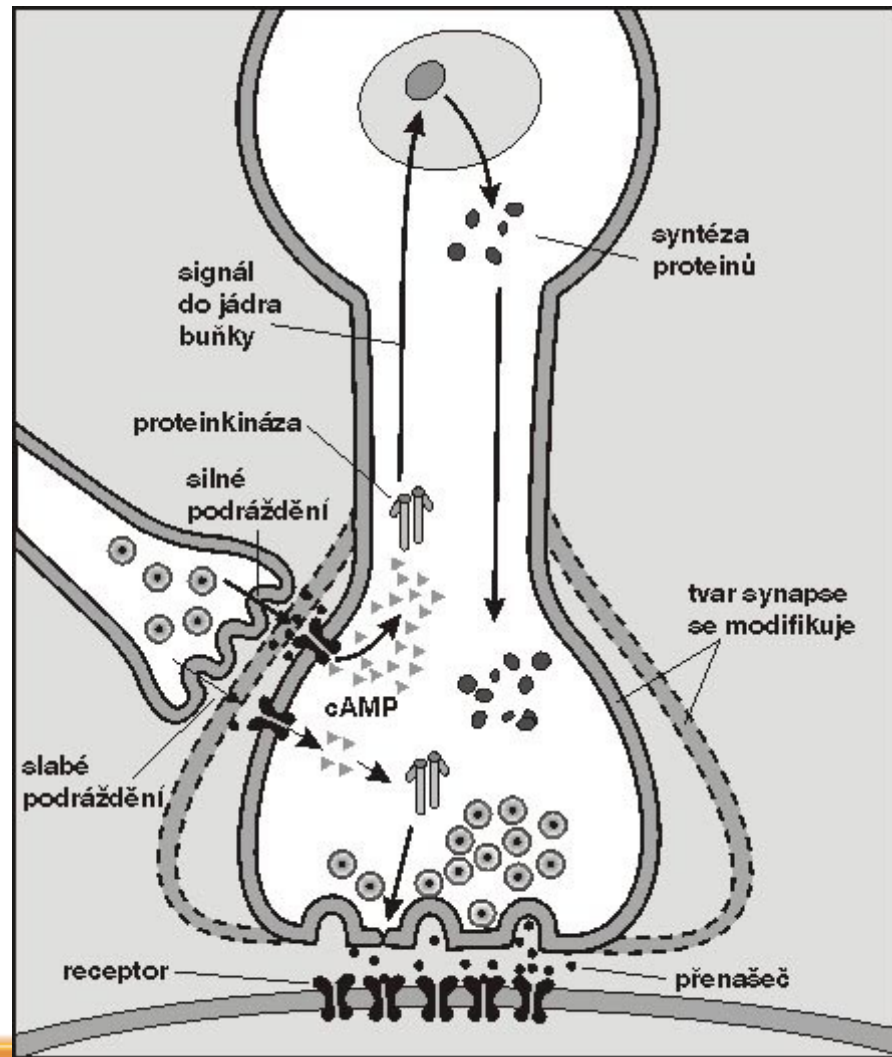

A. EXPERIMENTAL SET-UP DEMONSTRATING SENSITIZATION

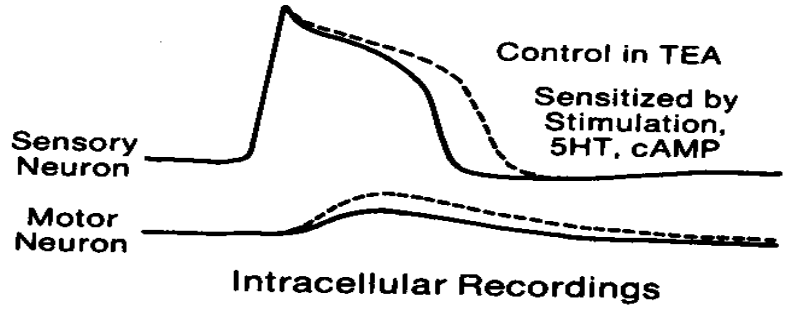
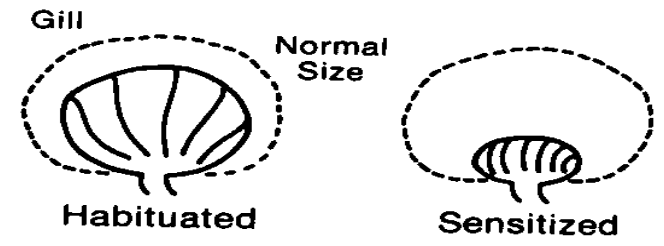
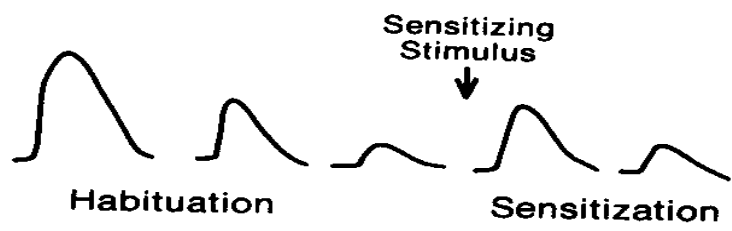
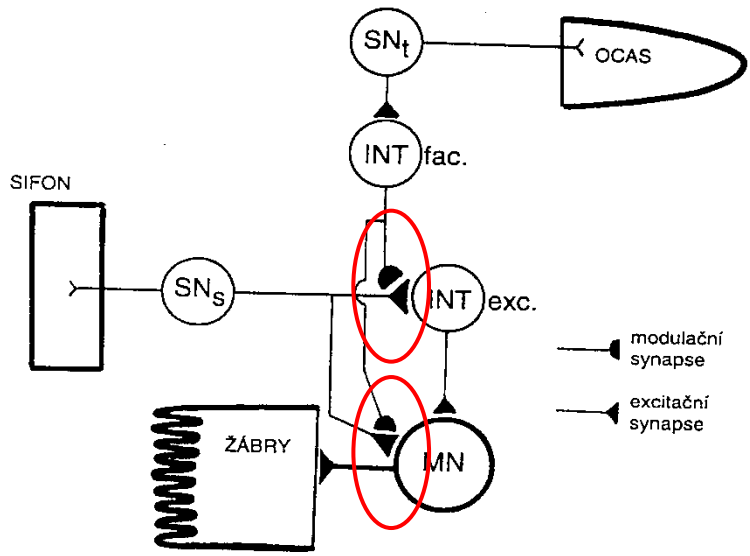

C. CONCEPTUAL MODELS

SHORT-TERM SENSITIZATION

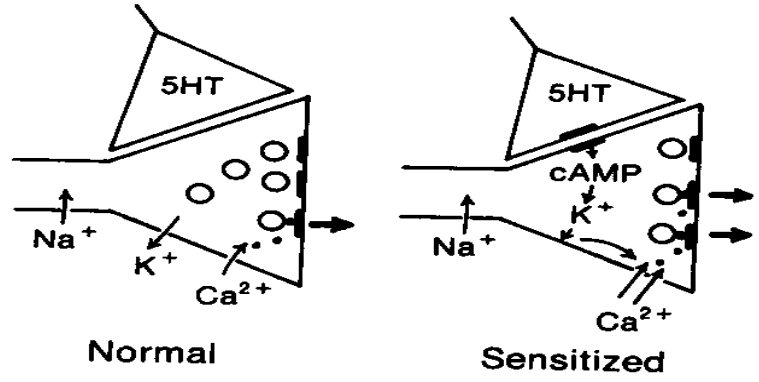

LONG-TERM SENSITIZATION

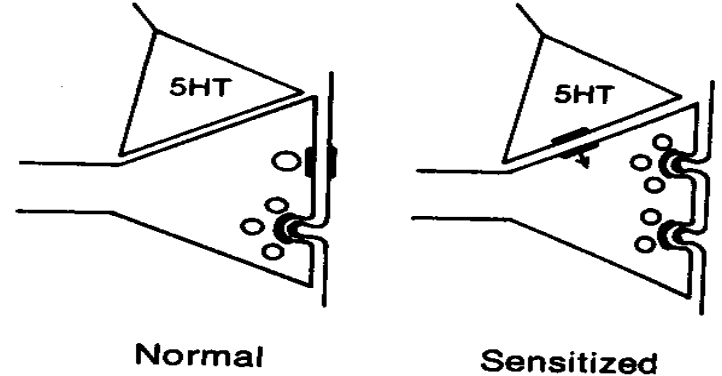

•

•

•

•

•

•



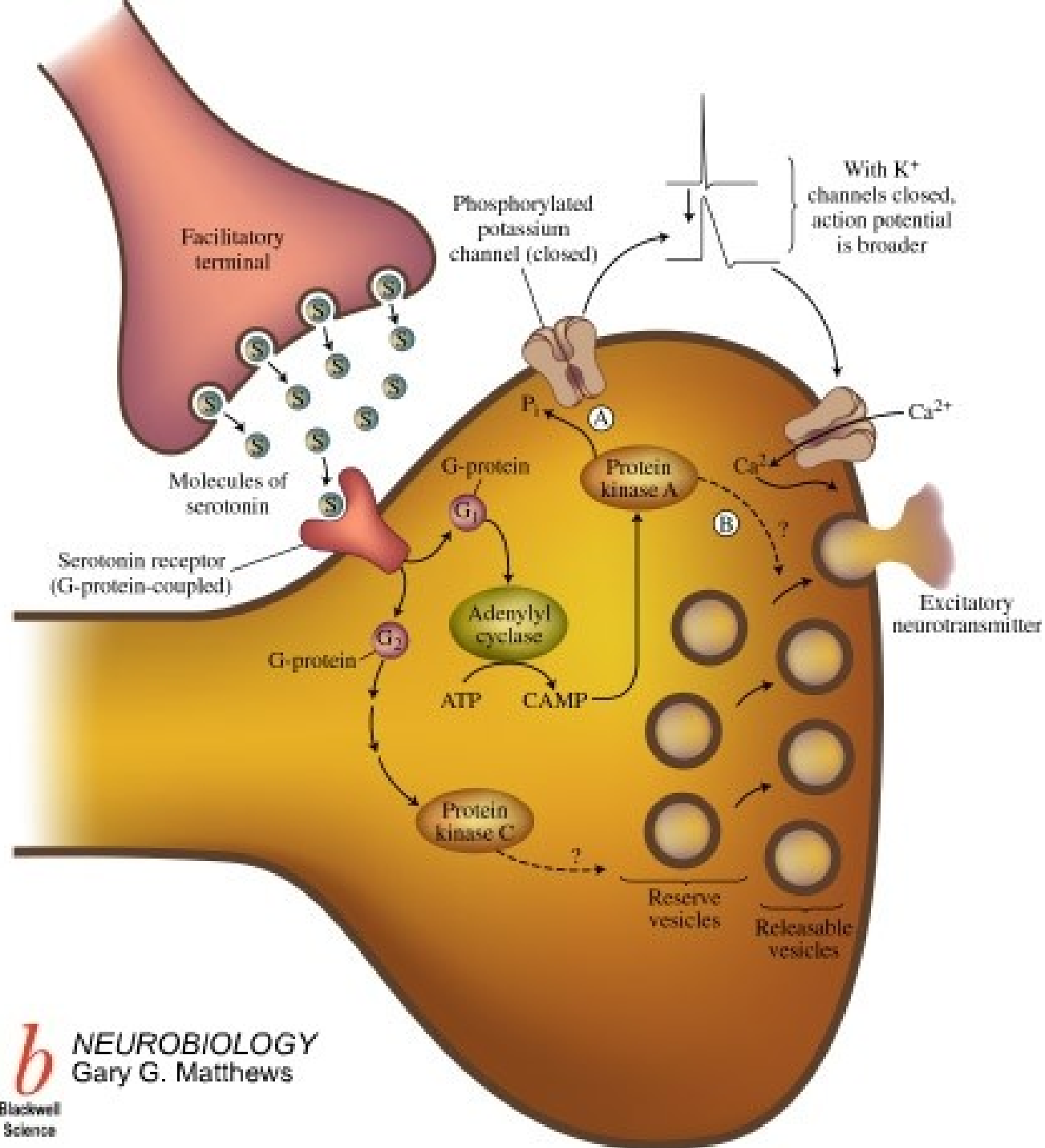

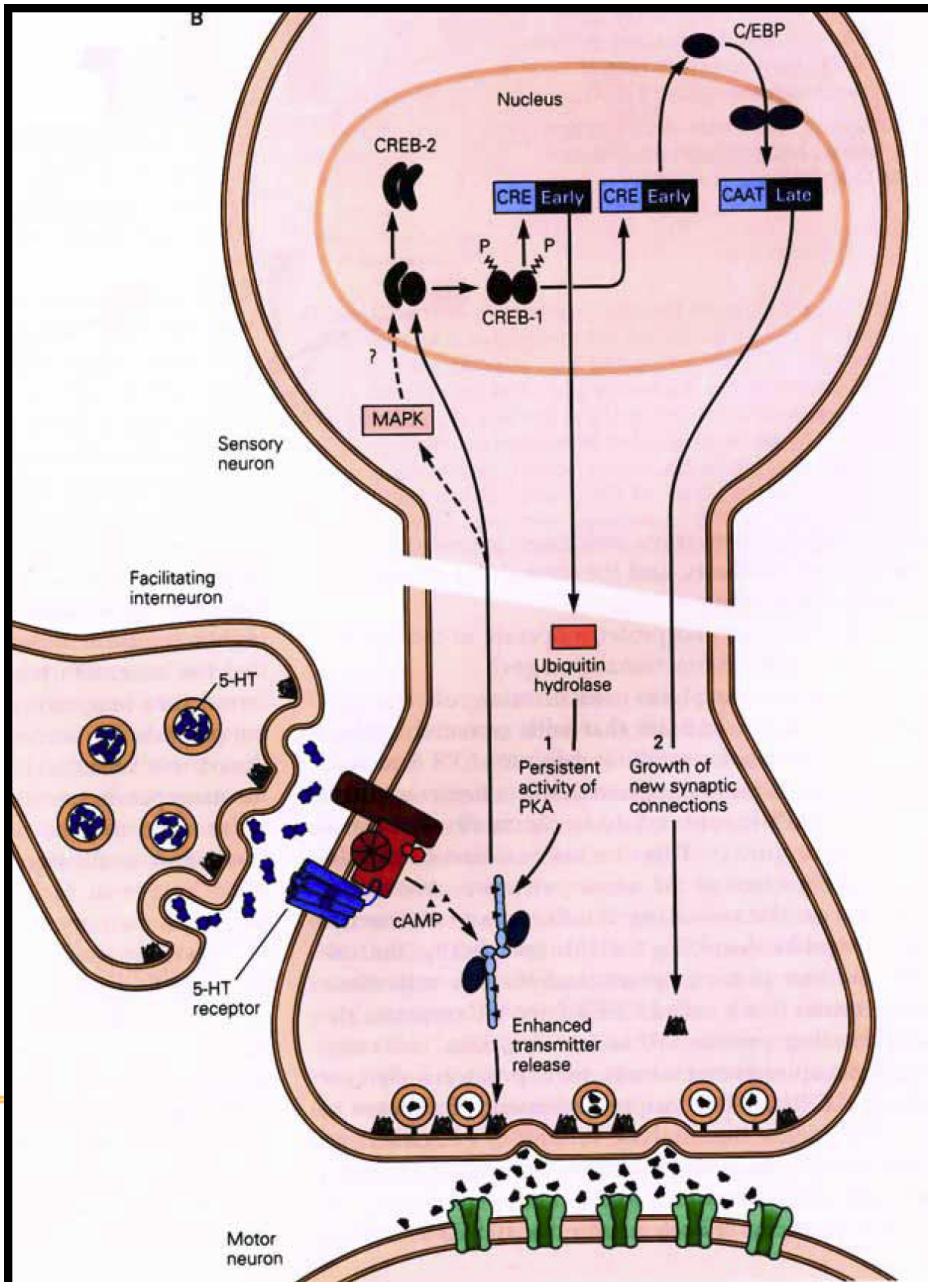

long-term sensitization/memory

persistent activity of sensory cell

a PKA+MAPK translocate to nucleus

a PKA phosphorylates CREB-1 (activator of transcription)

a MAPK inhibits CREB-2 (inhibitor of transcription)

a Ubiquitin hydrolases proteolyses regulatory PKA subunit

a PKA persistently active

Sensitization Produces Both Pre- and Postsynaptic Structural Changes in the Intact Animal (HRP)

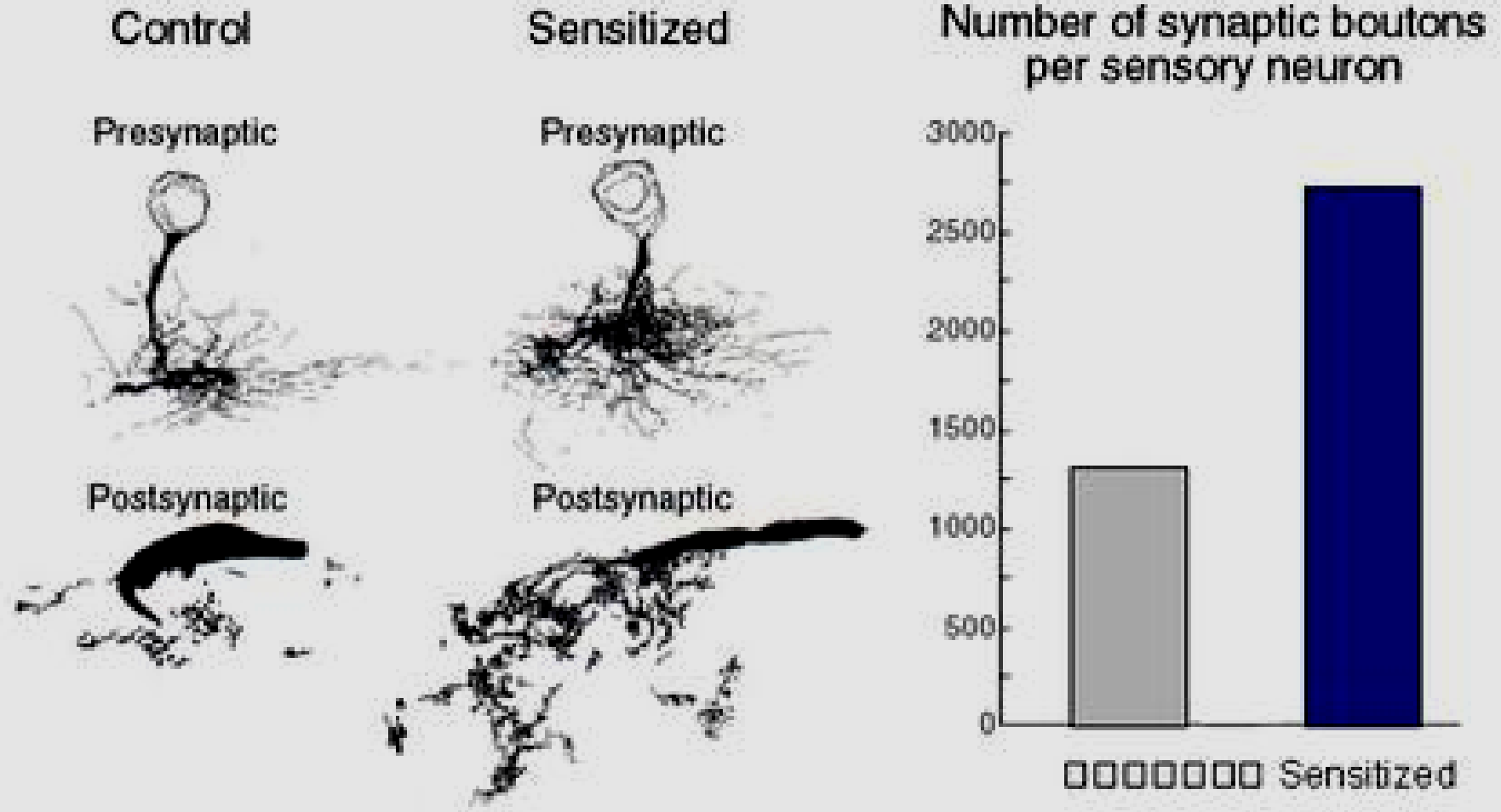



1. Klasické podmiňování

(A)

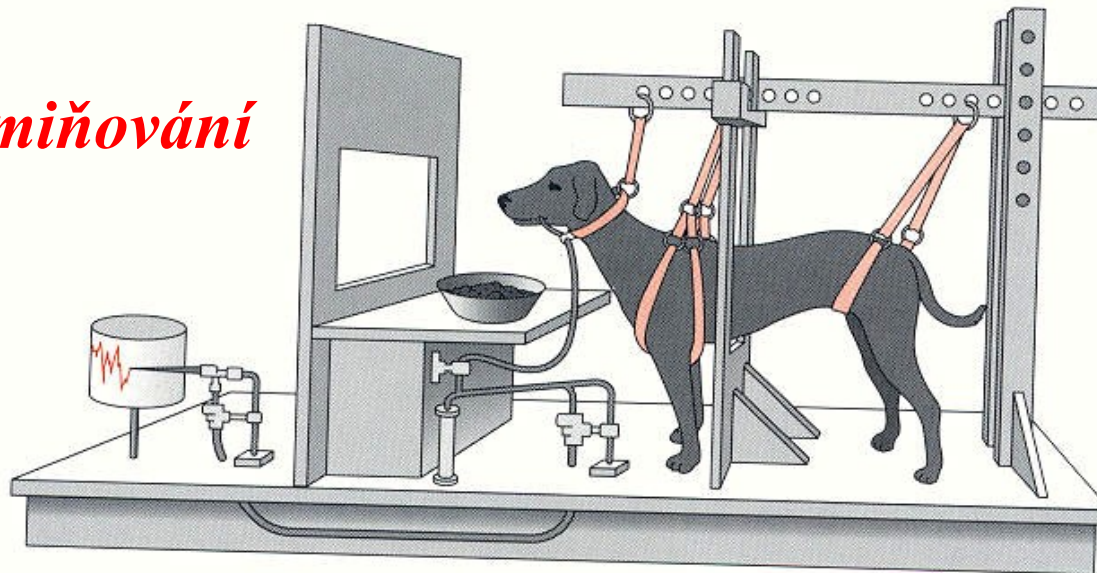

(B)

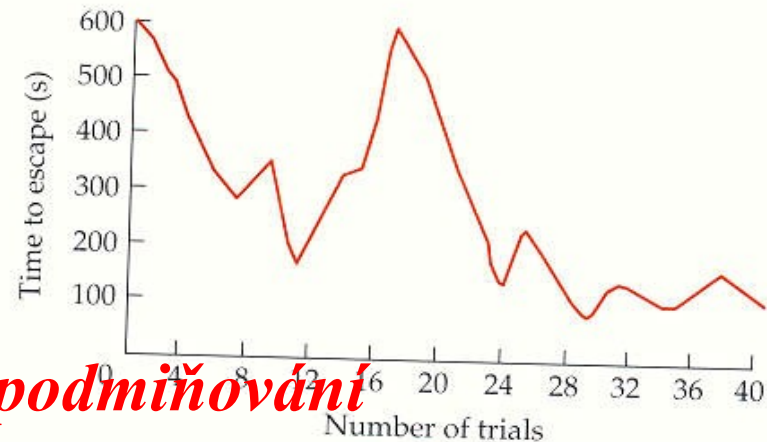
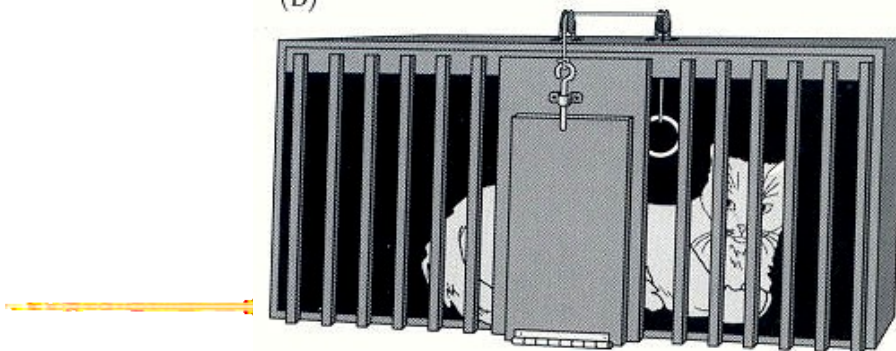

2. Instrumentální (operantní) podmiňování

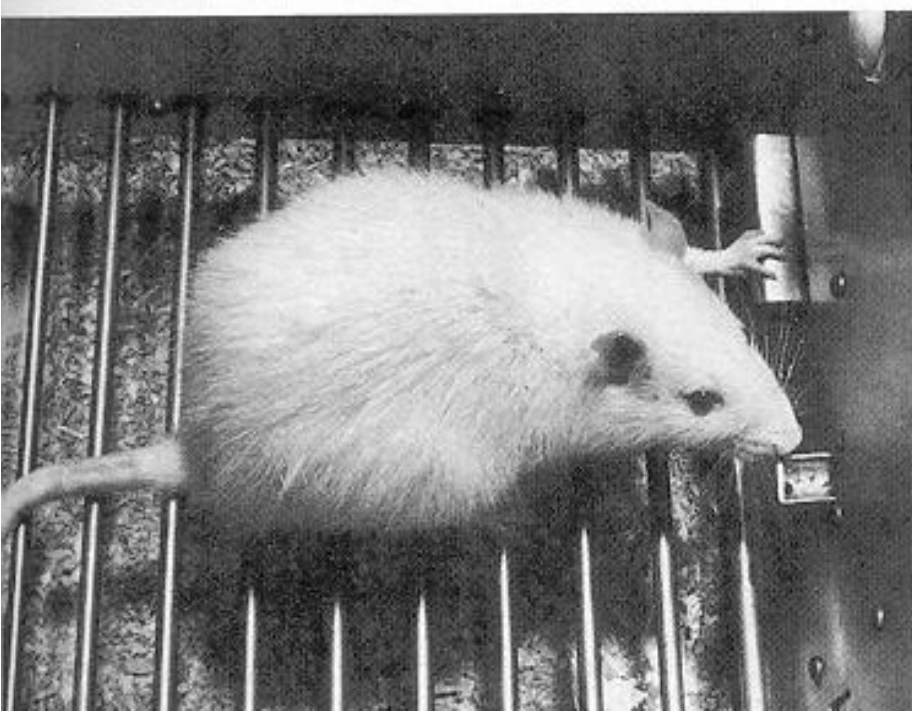
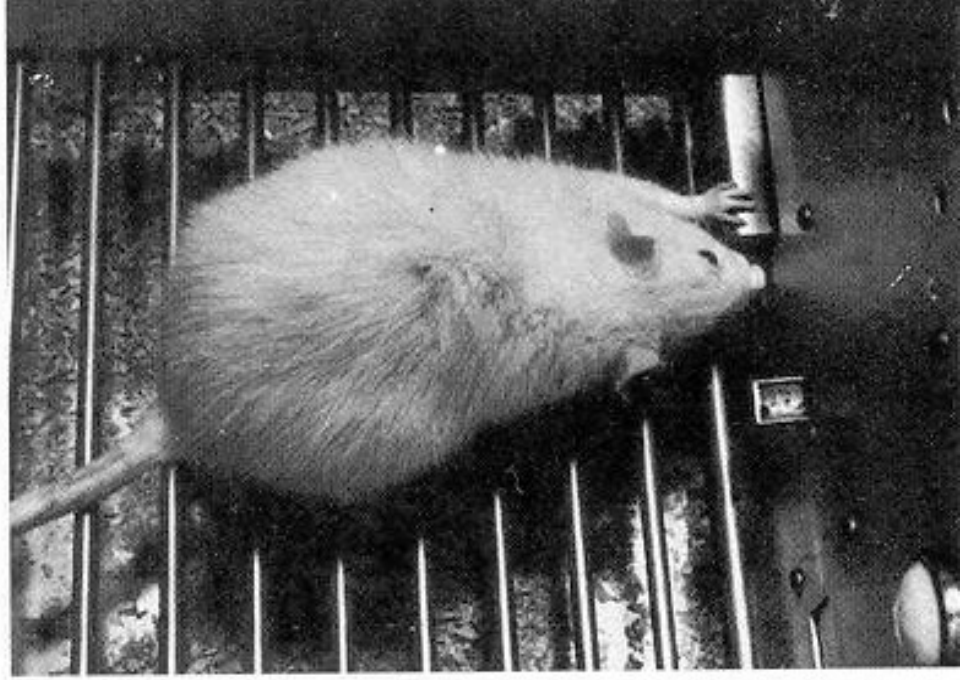

Olfactory aversive conditioning and testing

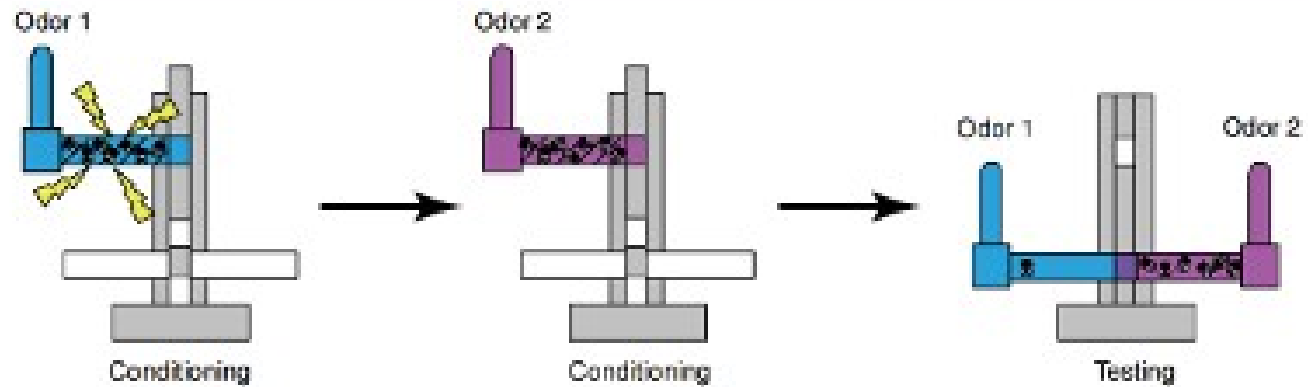

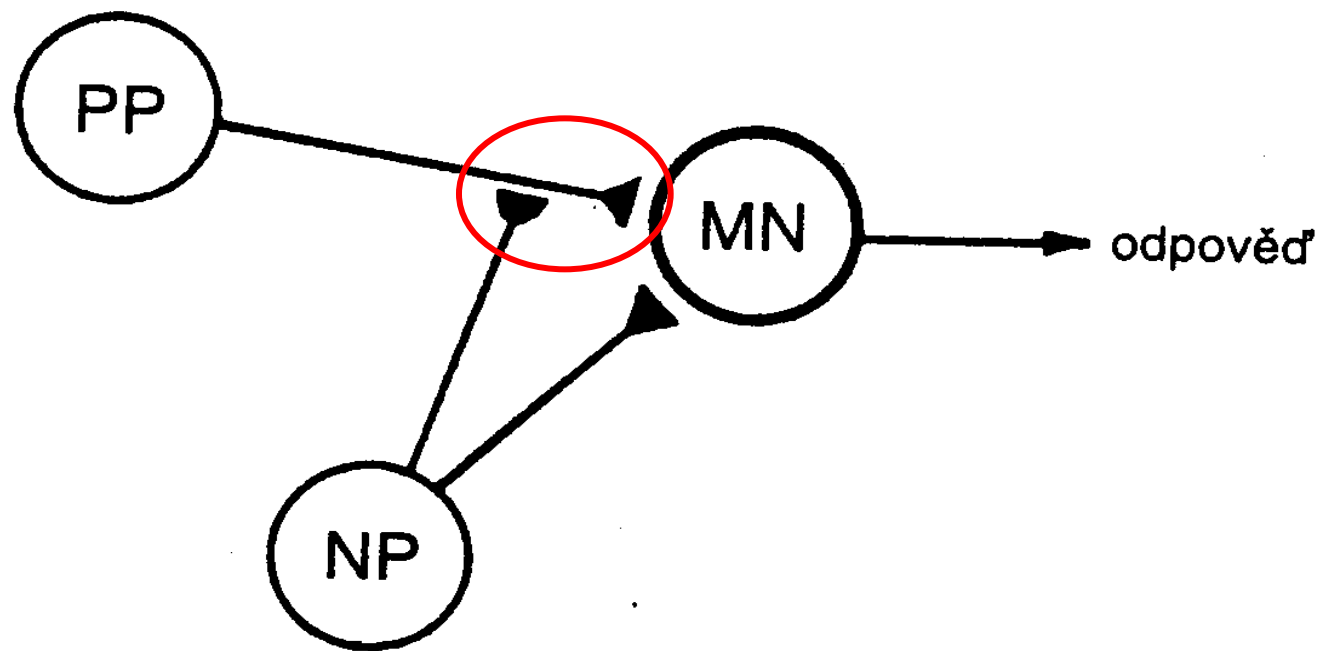

excitační
synapse

modulační
synapse

OBR. 11D

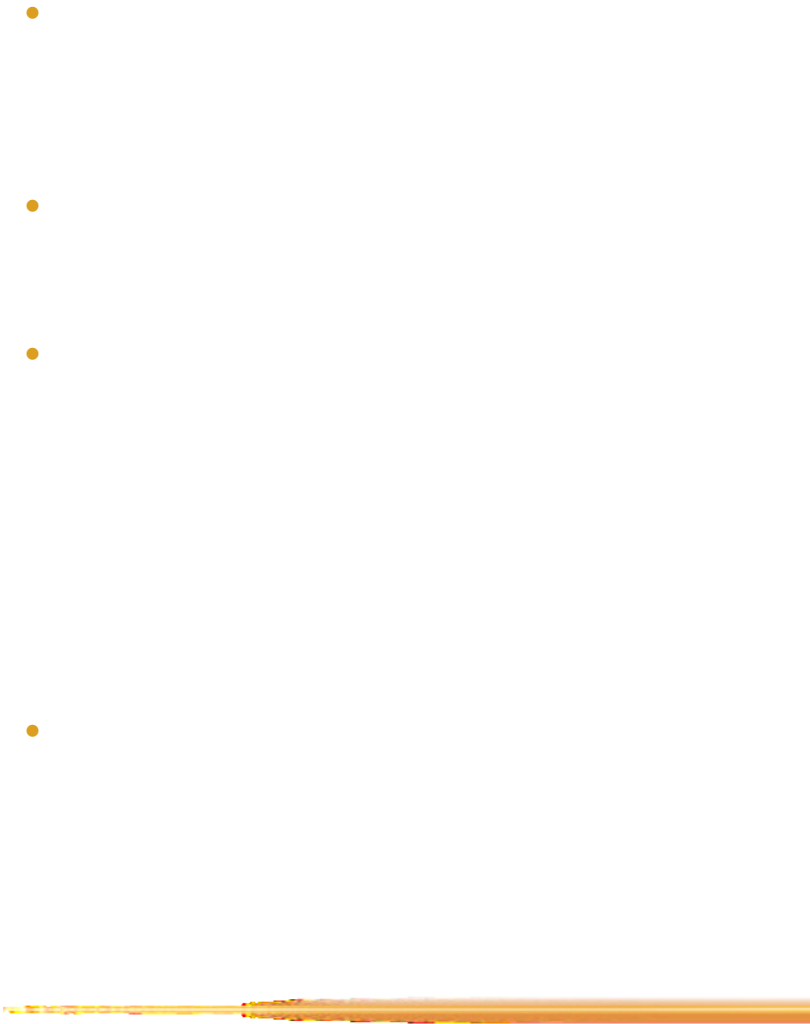

—▶ excitační synapse
—▶ modulační synapse

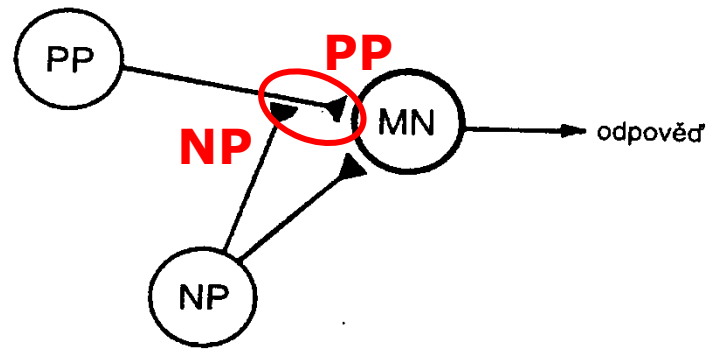

OBR. 11D

(B) Classical conditioning

CS+ PATHWAY (preceding activity)

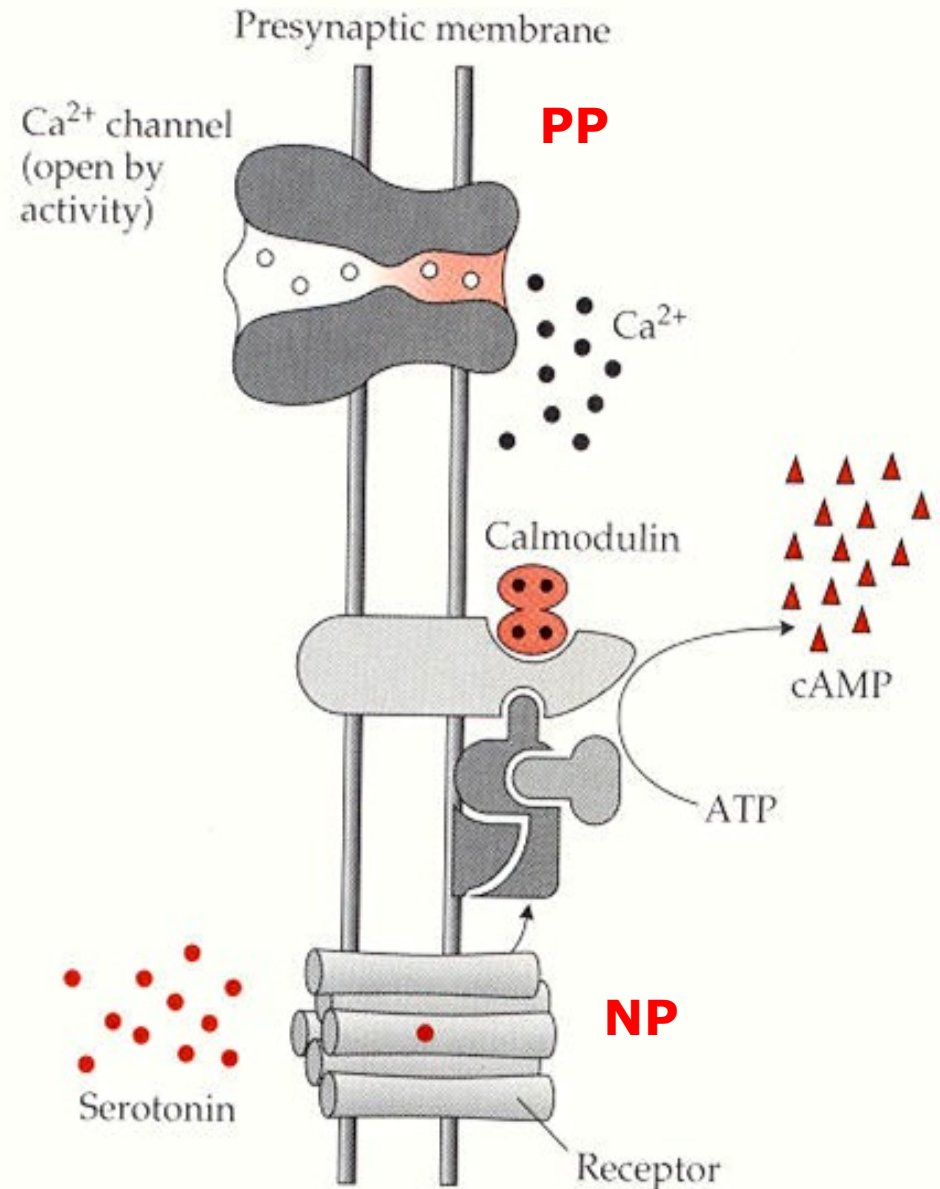

1. Po aktivaci PP zvýšená hladina Ca^{2+}
2. Aktivace kalmodulinu
3. Kalmodulin stimuluje adenylcyklasu
4. Vyšší hladina cAMP
5. Serotonin z modulační s. také stimuluje ACyklázu

6. cAMP aktivuje PKC
7. Blokace K^{+} kanálů
8. Delší depolarizace
9. Delší influx Ca^{2+}
10. Větší výlev mediátoru

NP

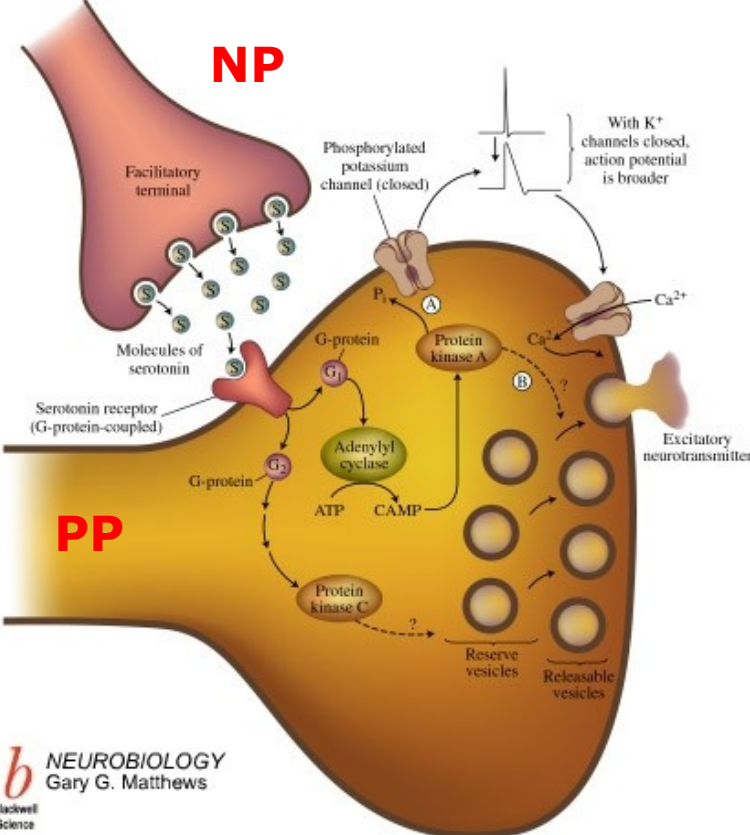

membrána

NEAKTIVOVANÝ PP NEURON

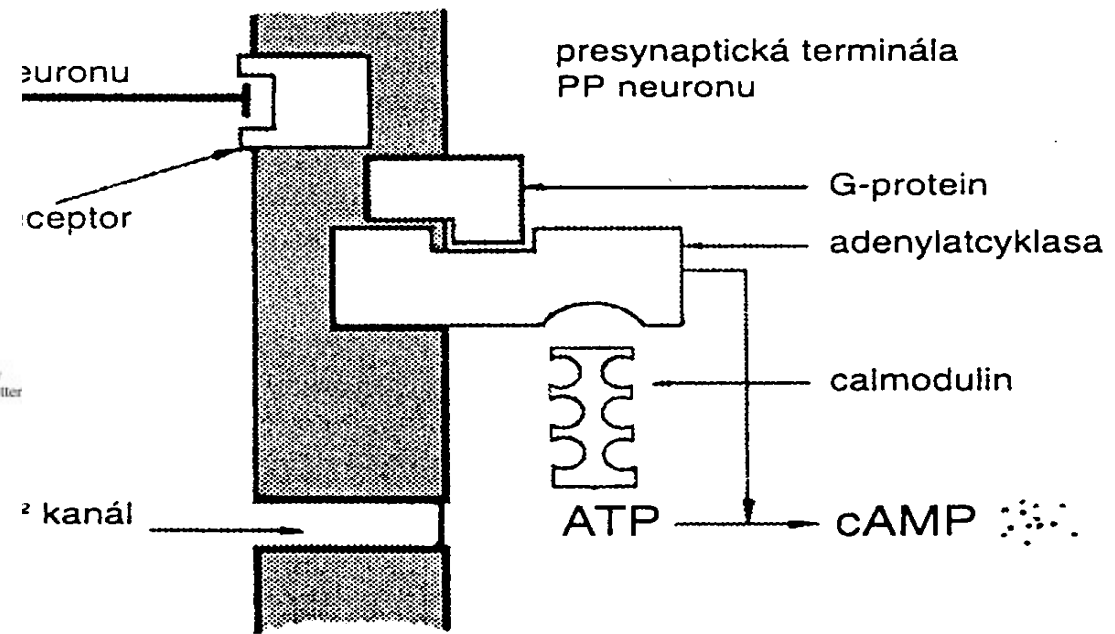

PŘEDCHÁZEJÍCÍ AKTIVACE PP NEURONU

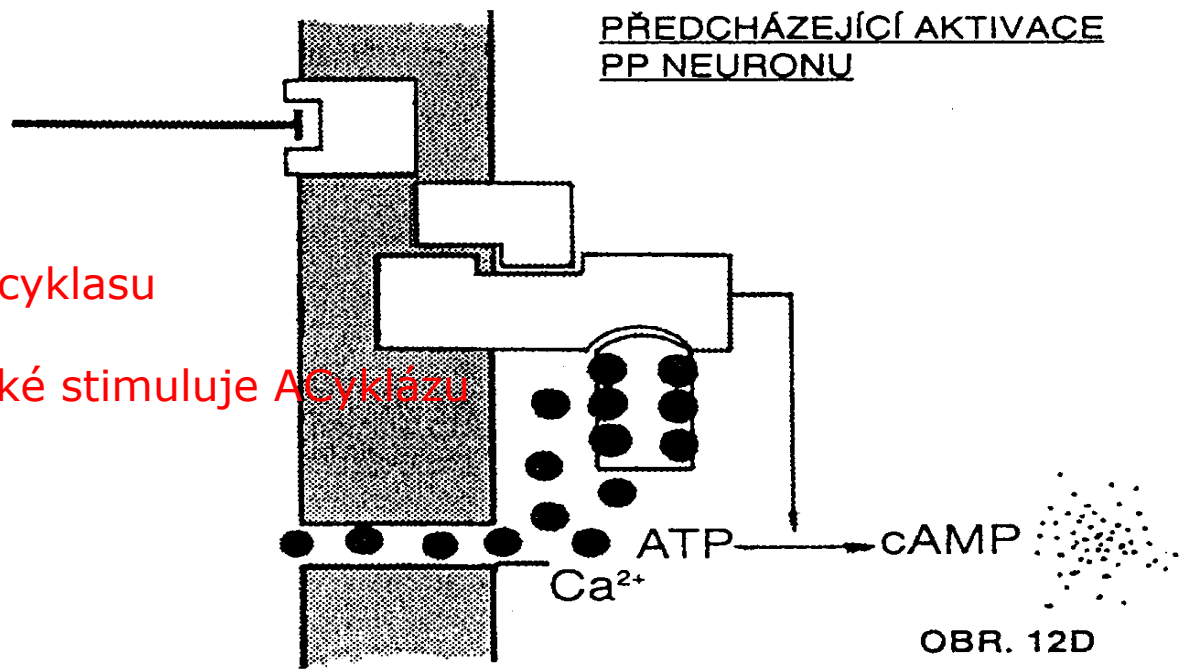

NEUROBIOLOGY
Gary G. Matthews
Blackwell Science

1. Po aktivaci PP zvýšená hladina Ca⁺
2. Aktivace kalmodulinu
3. Kalmodulin stimuluje adenylylcyklasu
4. Vyšší hladina cAMP
5. Serotonin z modulační s. také stimuluje ACyklázu
6. cAMP aktivuje PK7
7. Blokace K⁺ kanálů
8. Delší depolarizace
9. Delší influx Ca⁺
10. Větší výlev mediátoru

Classical conditioning

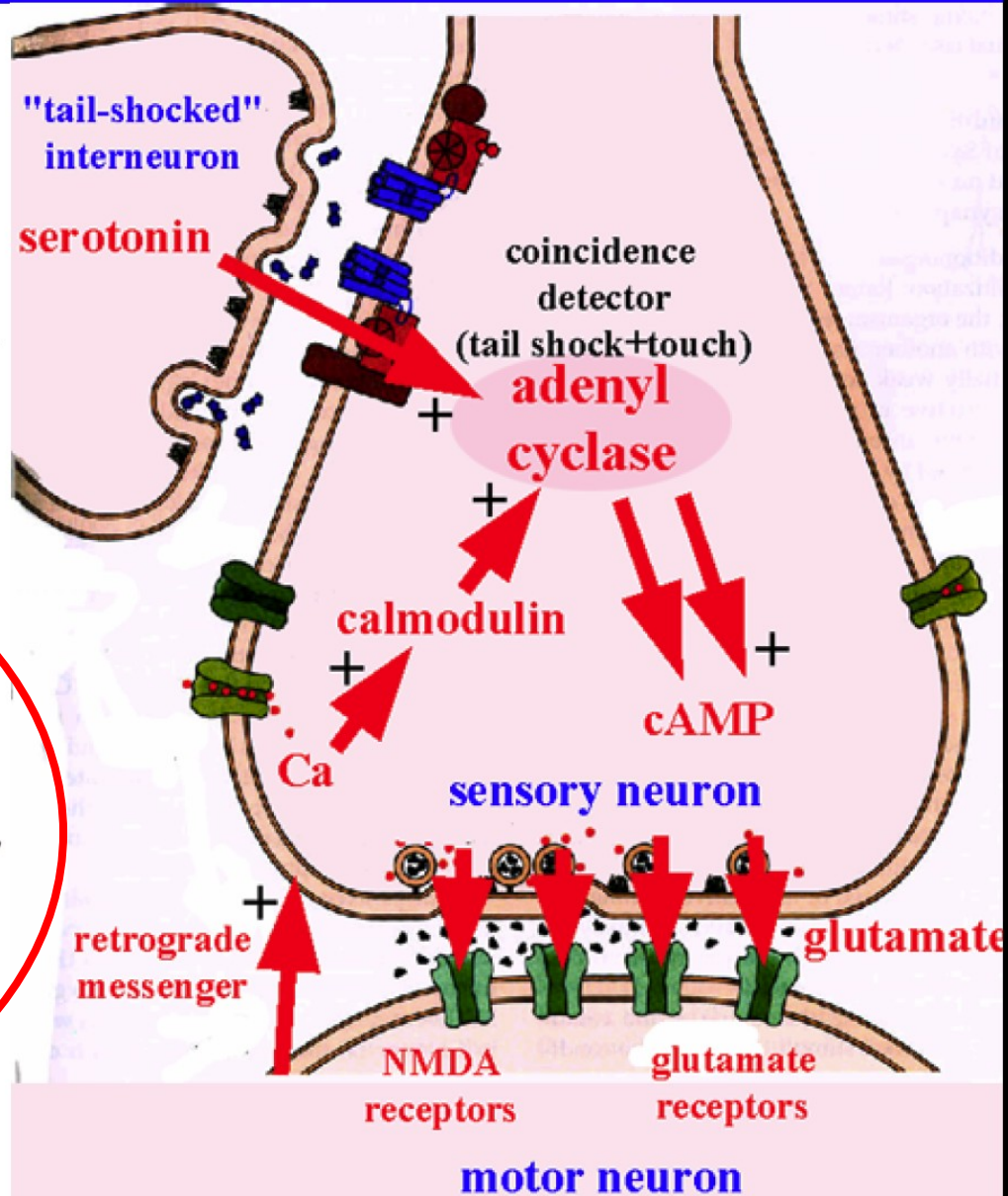
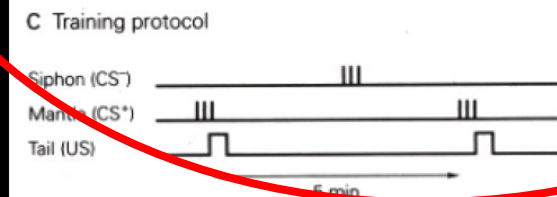
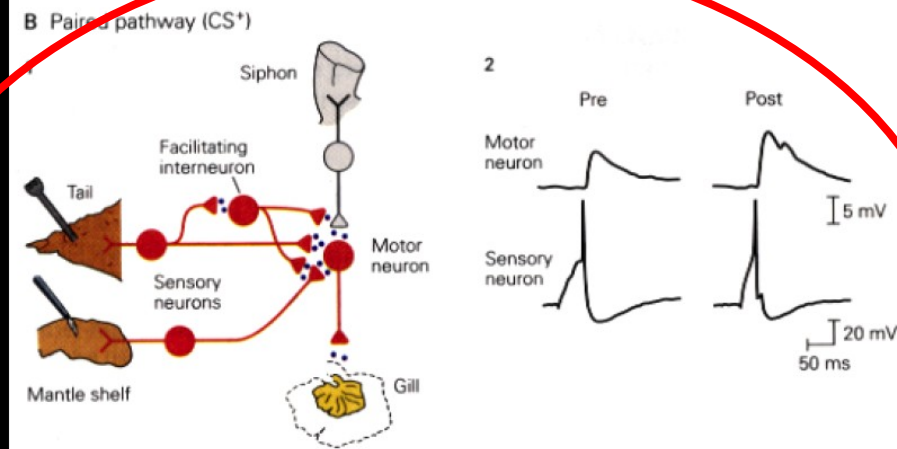
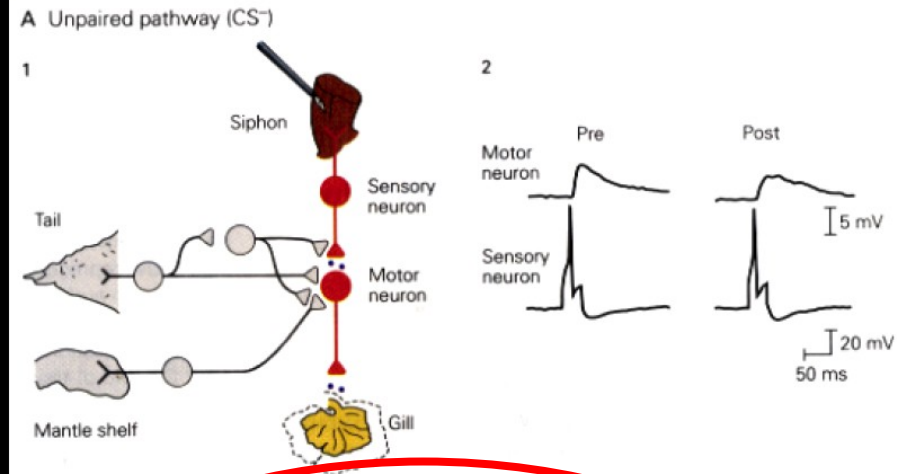

coincidence detection

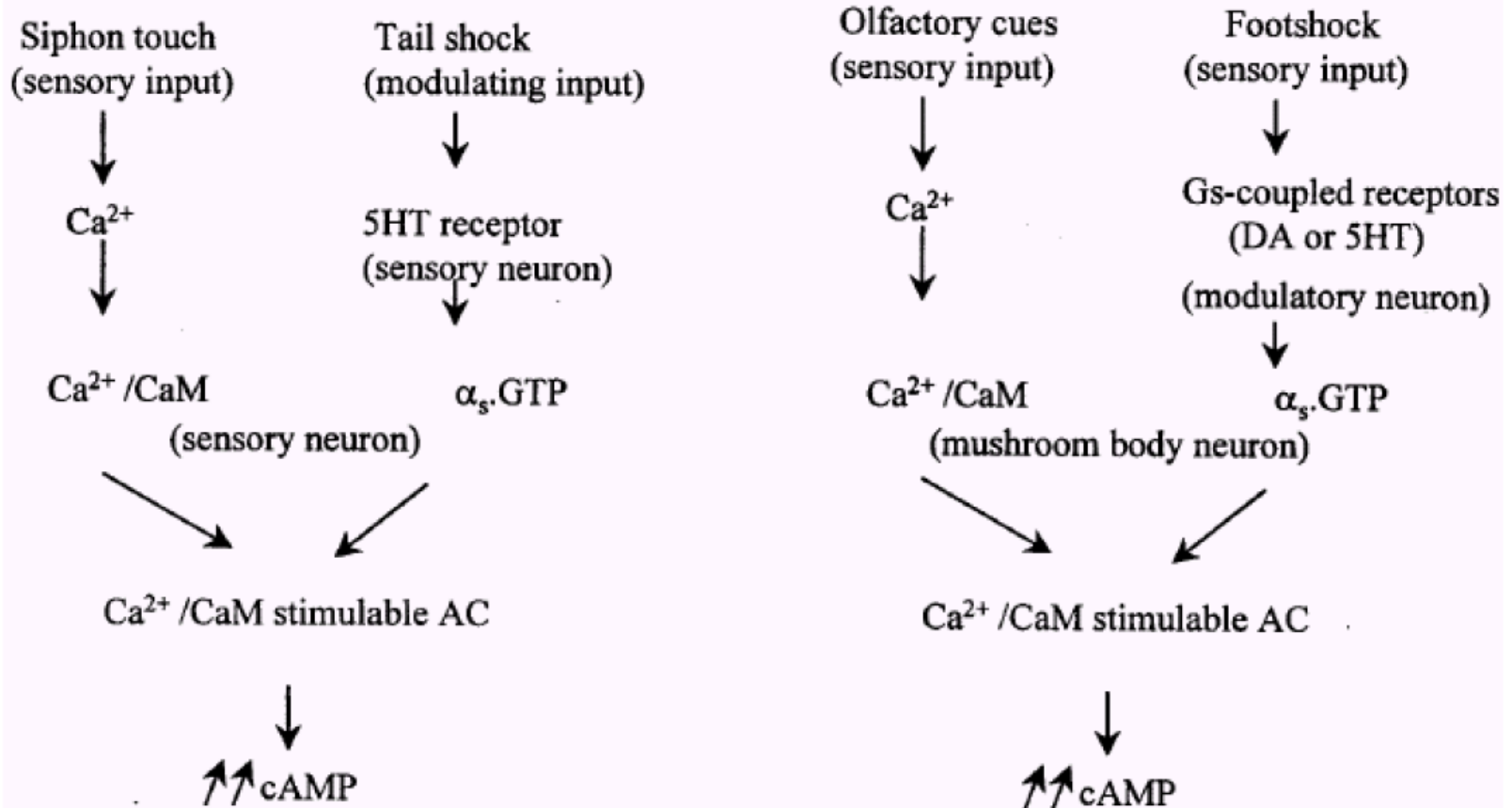

Depolarization of the sensory neurons prior to exposure to 5HT increases levels of cAMP over those seen when CS and US are unpaired. It has been suggested that Ca^{2+} influx resulting from CS could converge upon Ca^{2+} -calmodulin sensitive-AC and increase the cAMP level produced by 5HT. In this case, the *Aplysia* adenylyl cyclase is activated by both Ca^{2+} -calmodulin and GTPGs (a GTP analog that acts by binding to α_s), and therefore acts as a coincidence detector that is sensitive to the timing and order of stimuli.

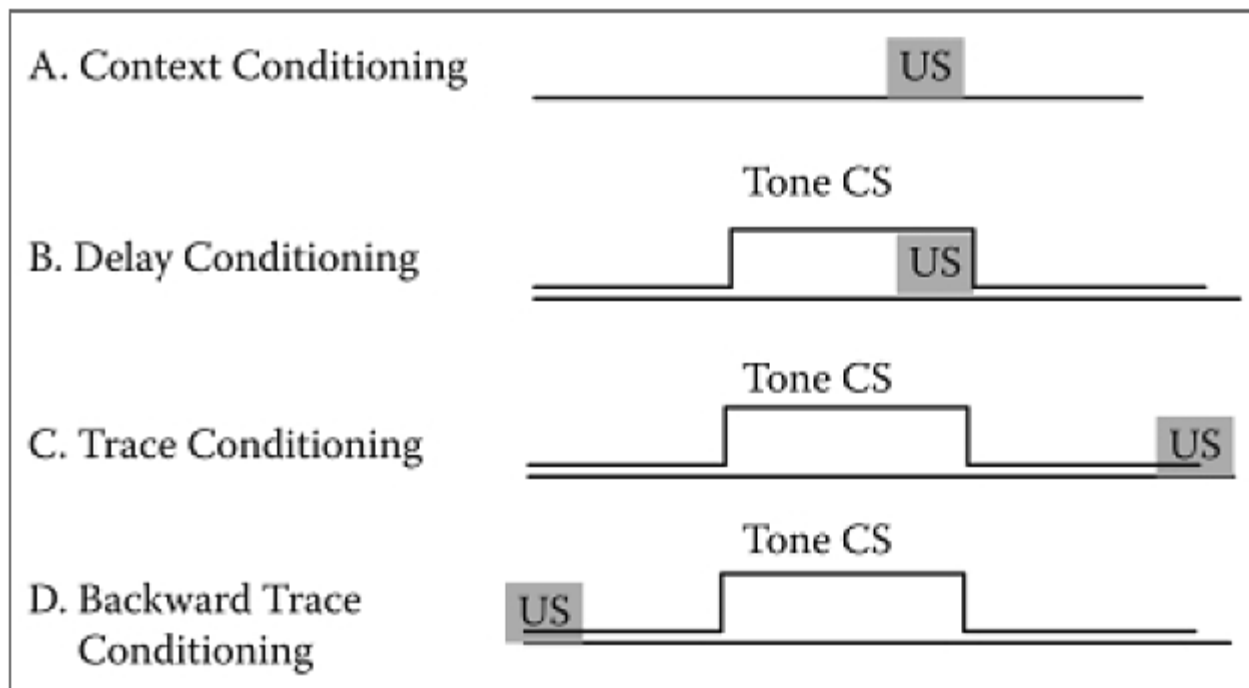

FIGURE 2.1

Four basic conditioning paradigms illustrating the timing of US (aversive stimulus) presentation.

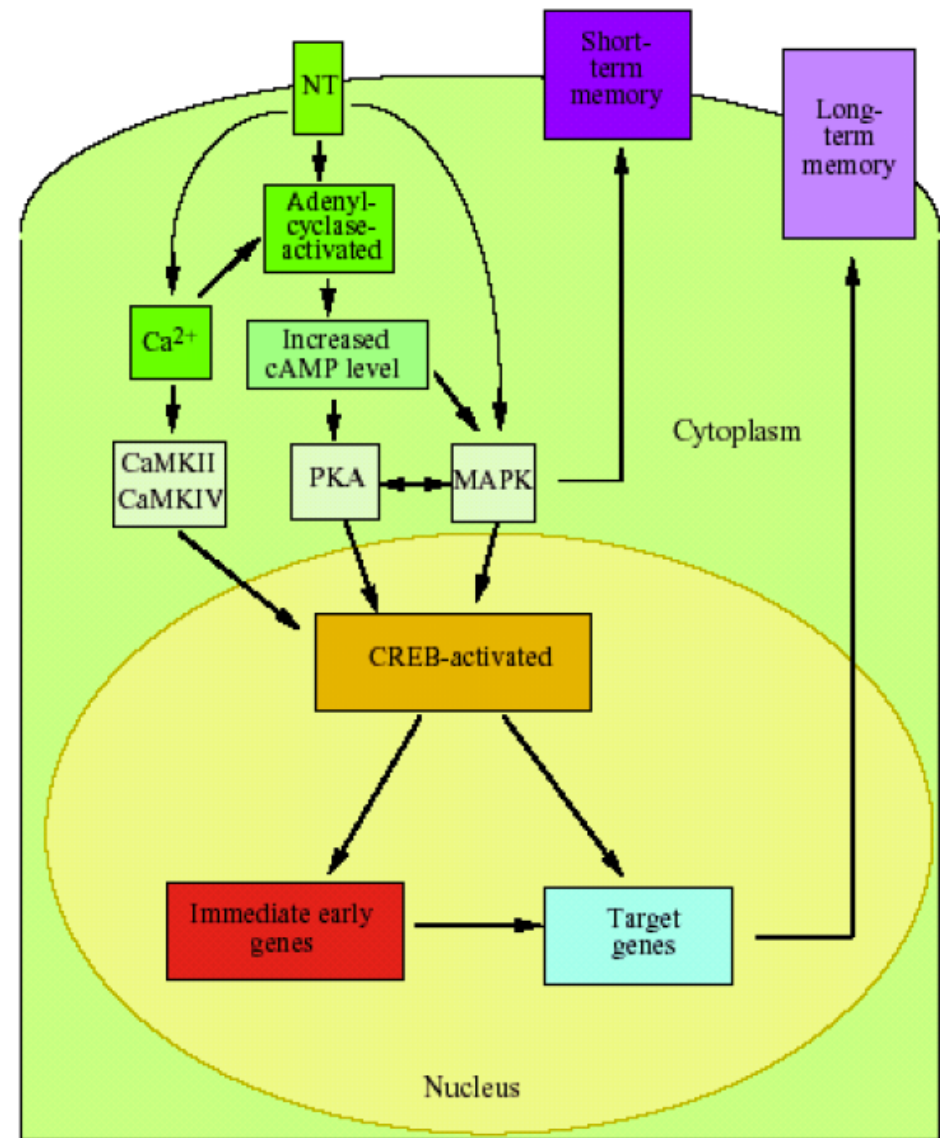
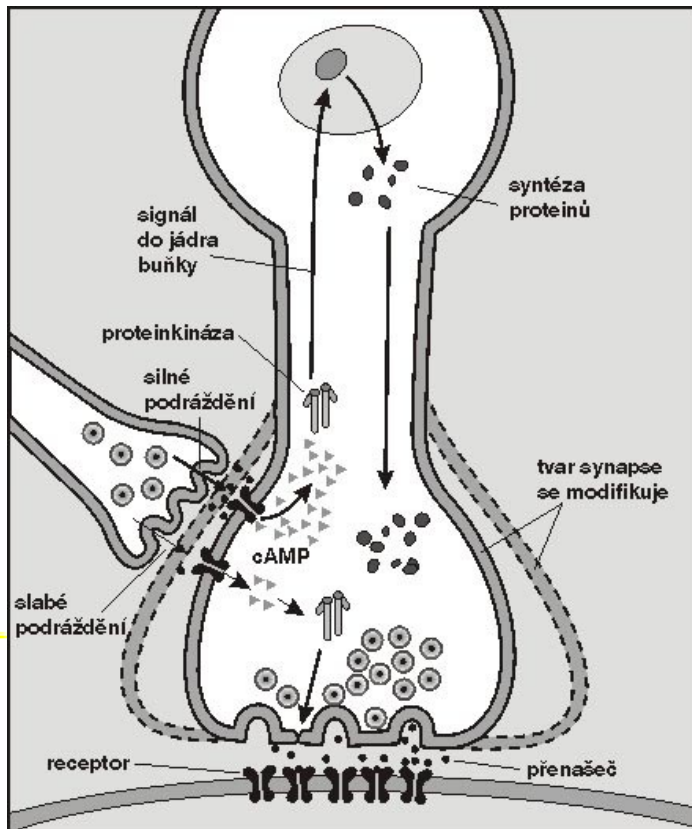
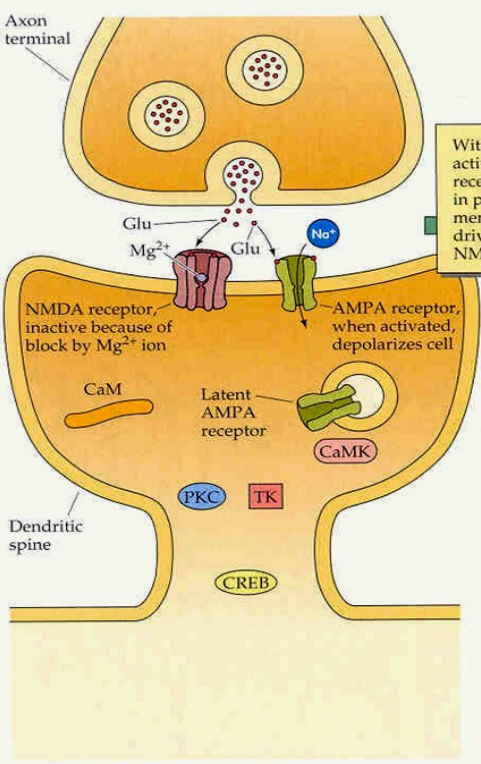
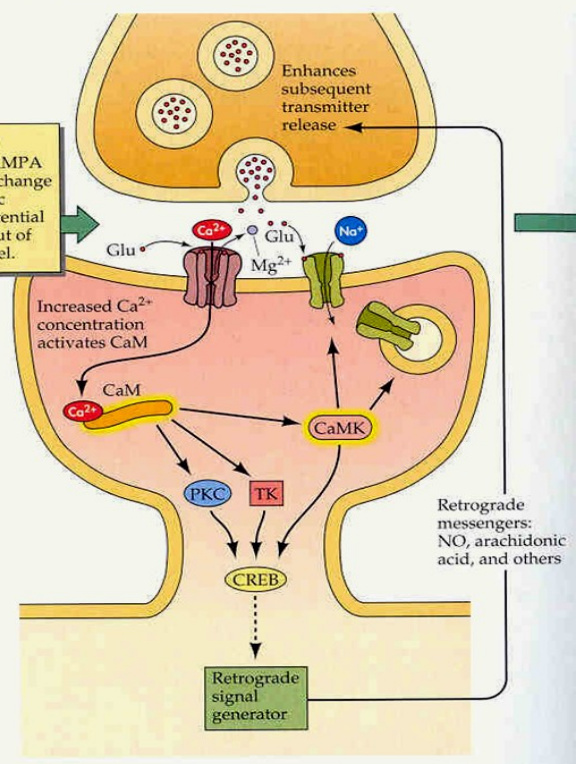

Fig. 1. Schematic representation summarizing the molecular events leading to short and long-term memory. CaMKII, CaMKIV, calcium-calmodulin-dependent kinases II and IV; CREB, cAMP response element binding protein; MAPK, mitogen activated protein kinase; PKA, cAMP-dependent protein kinase; NT, neurotransmitter.

(a) Normal synaptic transmission



(b) Induction of LTP



(c) Enhanced synapse, after induction of LTP

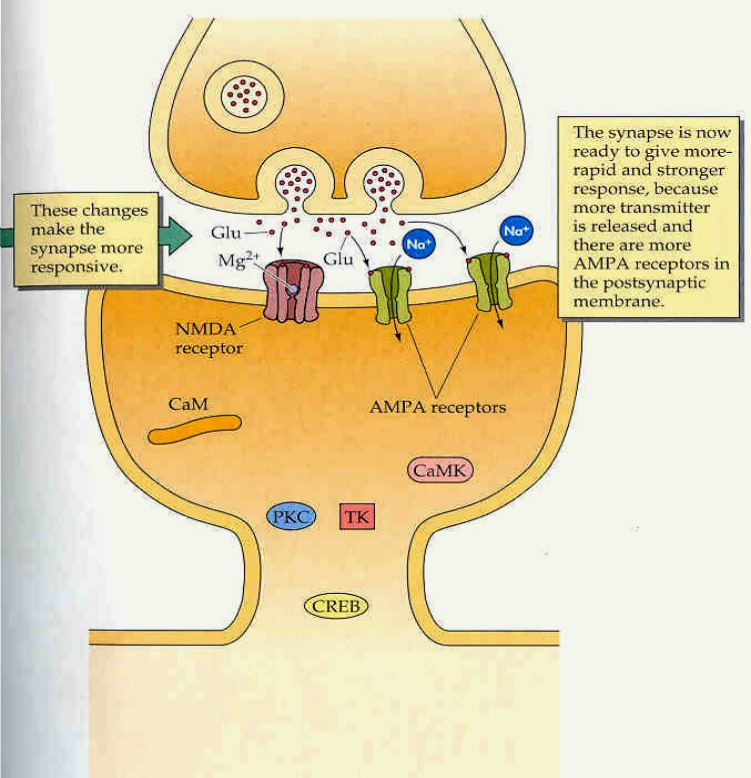

Modulatory Transmitters Activate Transcription by Means of a Signal to the Nucleus and Initiate and Perpetuate the Growth of New Synapses with 2 Local Marking Signals

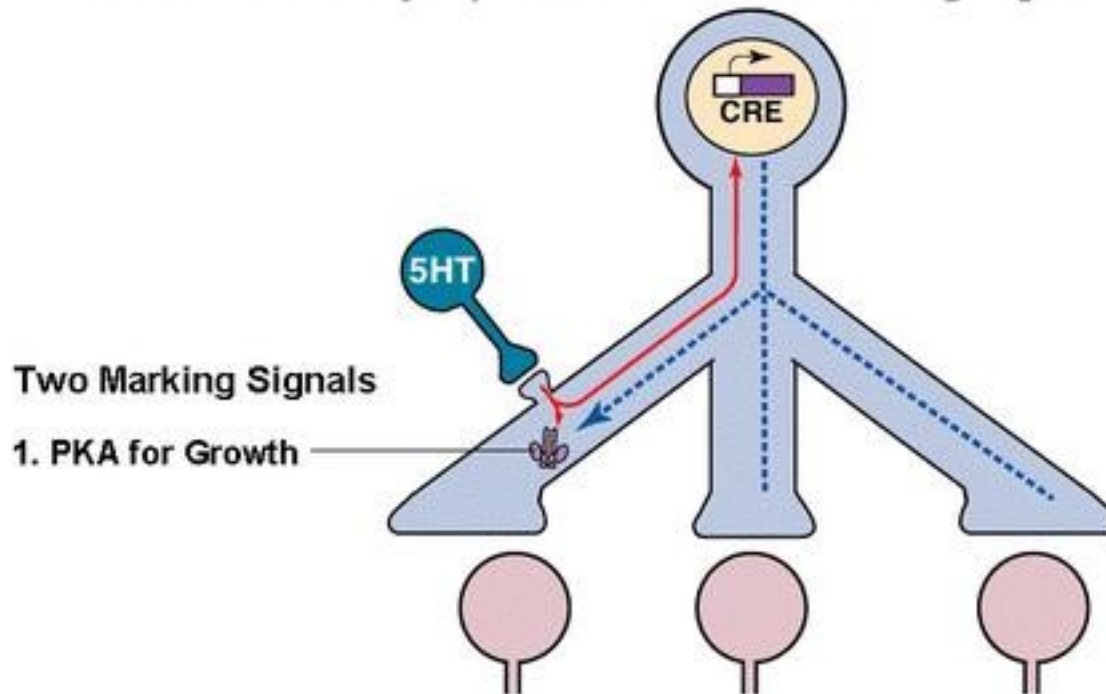

Modulatory Transmitters Activate Transcription by Means of a Signal to the Nucleus and Initiate and Perpetuate the Growth of New Synapses with 2 Local Marking Signals

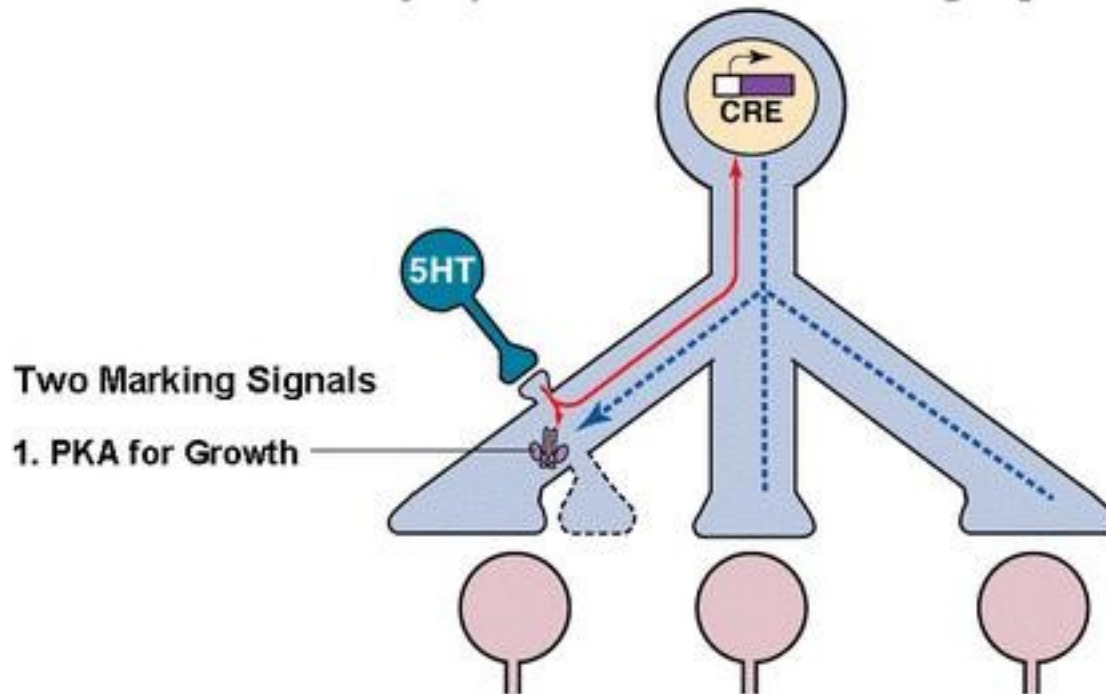

Modulatory Transmitters Activate Transcription by Means of a Signal to the Nucleus and Initiate and Perpetuate the Growth of New Synapses with 2 Local Marking Signals

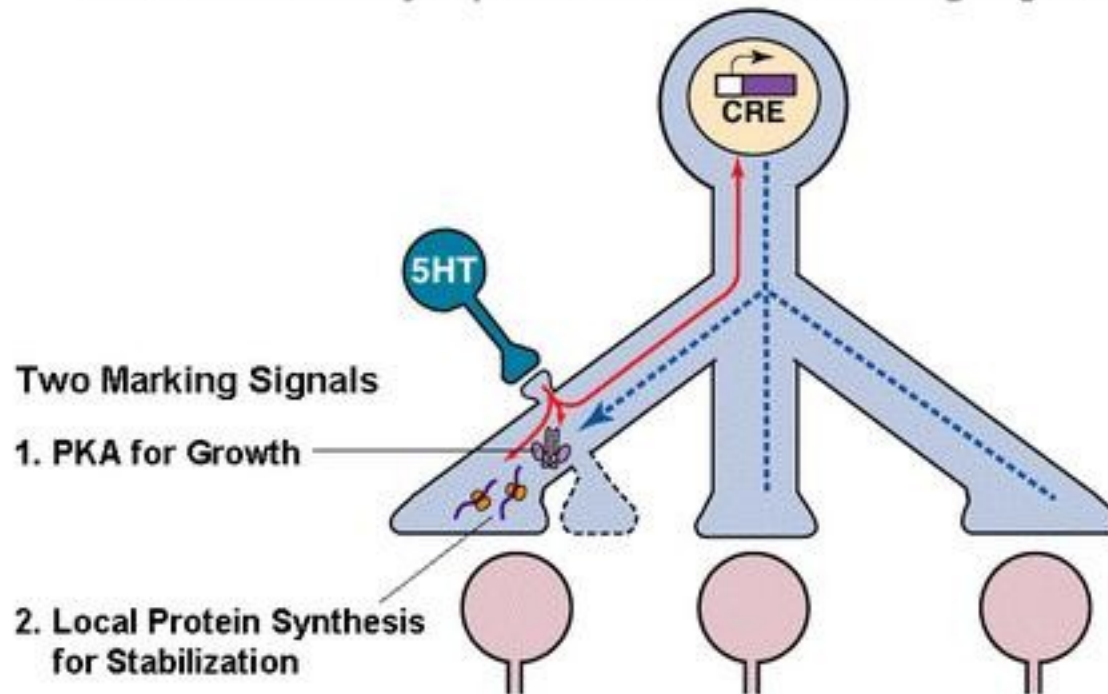

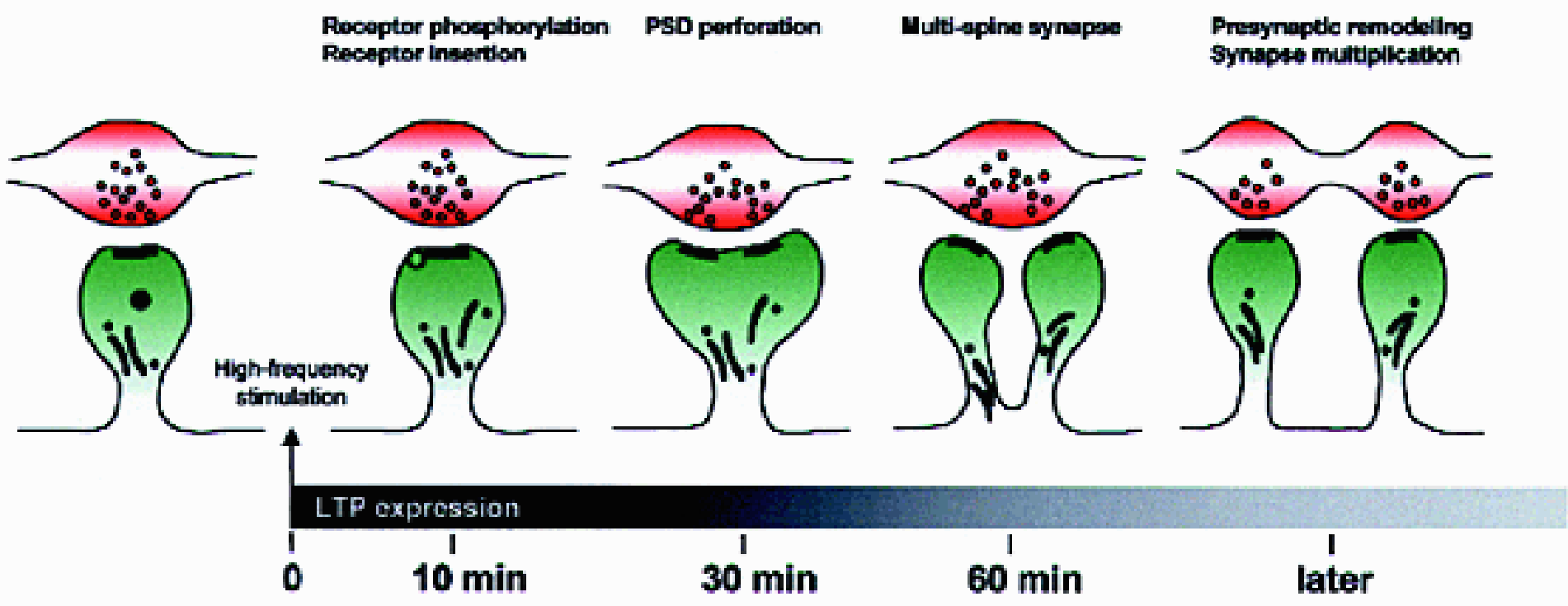

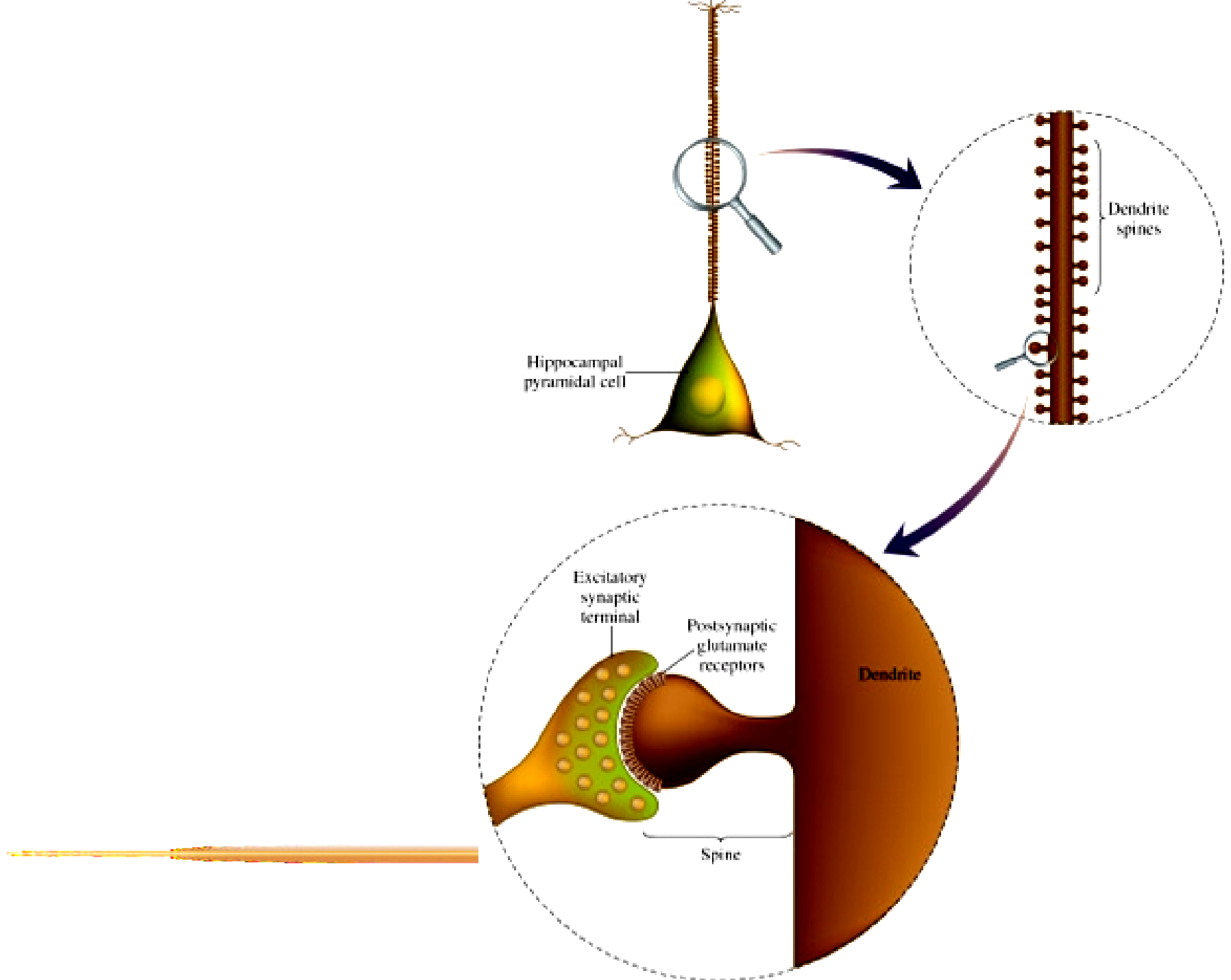

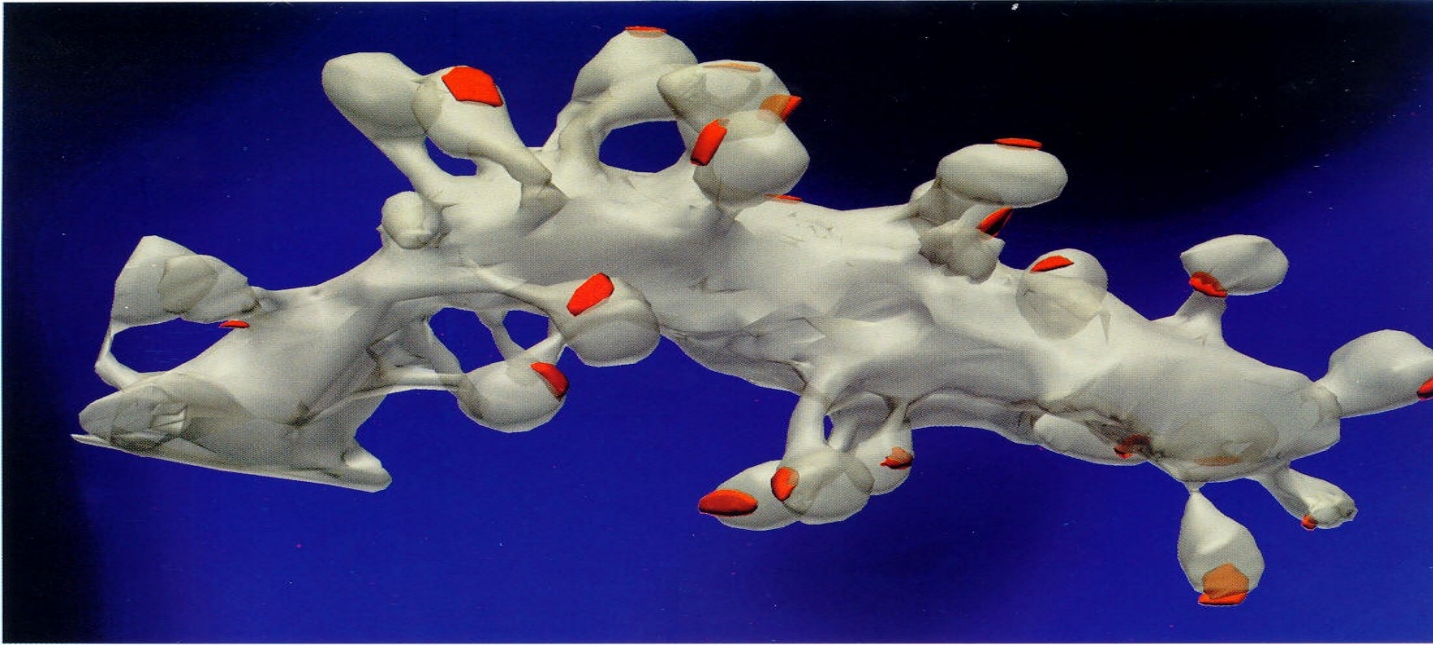

Modulatory Transmitters Serve as Salience Signals to Stabilize Synaptic Plasticity and Behavior for Both Implicit and Explicit Memory

Is the mechanism for maintenance also general?

**Implicit Memory:
Sensitization in Aplysia**

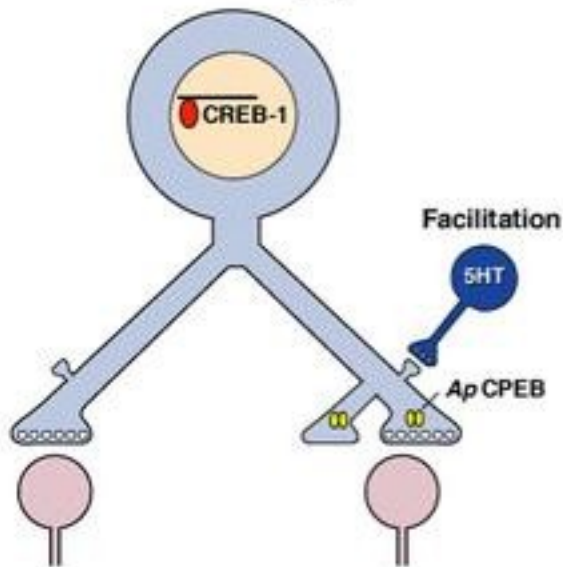

**Explicit Memory:
Spatial Memory in the Mouse**

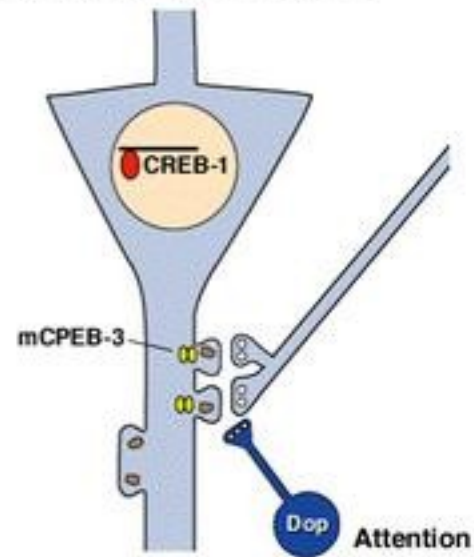

a Encoding and tagging

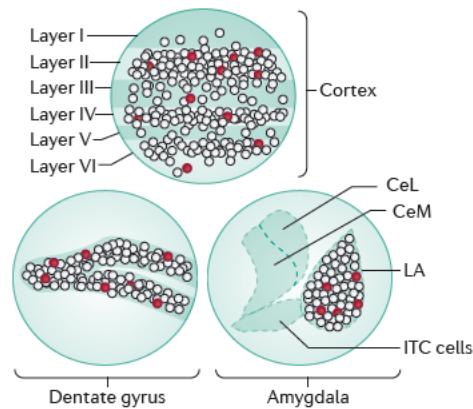

Context 1

b Storage

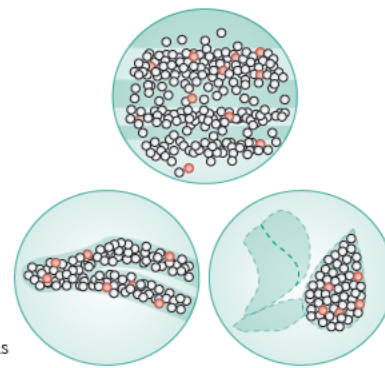

Home cage



c Retrieval

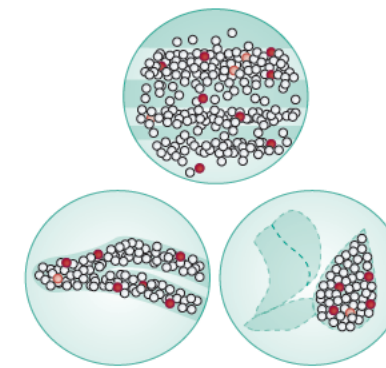

Context 1



d Opsin-induced inhibition

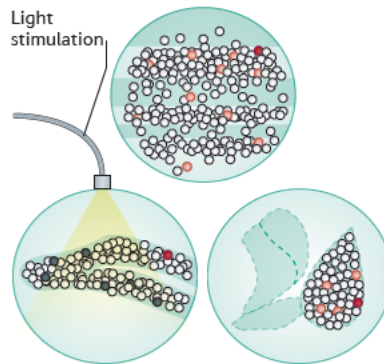

Context 1



e Opsin-induced excitation

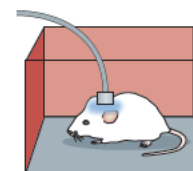
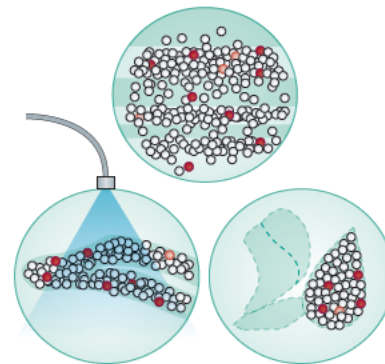

Context 2

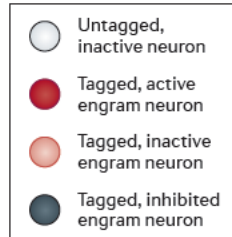
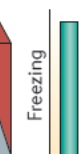

Figure 3 | The tag-and-manipulate approach to finding the engram. In this approach, transgenic mice are generated in which neurons that are active during a memory-encoding event are captured and tagged. Through the use of immediate-early gene promoters, these tagged neurons express genetically encoded modulators of neuronal activity (for example, inhibitory or excitatory opsins), allowing them to be silenced or activated at later times. ■ | During training for contextual fear conditioning, a mouse is placed in context 1 and given a footshock. This activates widely distributed neuronal ensembles in the dentate gyrus, cortex and lateral amygdala (LA) and these engram neurons are tagged. ■ | Following training, mice are returned to their home cage (where they do not freeze). The engram is consolidated, and tagged engram neurons become inactive. ■ | When returned to context 1, the mouse shows conditioned fear

(freezing behaviour), showing successful retrieval. This successful retrieval is associated with above chance reactivation of engram neurons. ■ | If tagged neurons in the dentate gyrus are optogenetically silenced when the mouse is returned to context 1, then successful memory retrieval is blocked, and mice show reduced conditioned fear. Inhibiting engram neurons in the dentate gyrus is sufficient to decrease reactivation of tagged neurons in the cortex and amygdala. ■ | Conversely, artificially activating tagged engram neurons in the dentate gyrus alone is sufficient to act as a memory retrieval cue such that mice now freeze in a third, unique context (context 2). Activating dentate engram neurons is sufficient to induce reactivation of tagged neurons in the cortex and amygdala. CeL, central nucleus of the amygdala lateral division; CeM central nucleus of the amygdala, medial division; ITC cells, intercalated cells.



Switching between remembering and forgetting

In this model, different SYT isoforms with different Ca^{2+} affinities (8) determine whether GluA2 receptors should be added to synapses, which strengthens them (LTP), or removed, which weakens them (LTD). This contributes at the synaptic level to the decision in the brain of whether a memory should be encoded or forgotten.

