



Research centre
for toxic compounds
in the environment

Ecotoxicology

New topics and future issues

Ludek Blaha + ecotox colleagues

cecoen



EUROPEAN UNION
EUROPEAN REGIONAL DEVELOPMENT FUND
INVESTING IN YOUR FUTURE



OP Research and
Development for Innovation



Take home messages from this presentation

- Traditional (eco)toxicity testing (based on simple standardized bioassays) and related chemical risk assessment is likely to change in this century
- ... towards the use of mechanistic data (omics), that is translated this into mechanistic knowledge (Adverse Outcome Pathways, AOPs) and mathematical models
 - The paradigm shift is strongly promoted by influential players – OECD, US EPA, European Commission (example shown – OECD AOPWiki)
 - Also in line with minimizing use of animals and implementation of „3R“ policies (examples shown)
 - Toxicological predictions = computational (AI) models are becoming more and more advanced

Current approaches

(black box of apical endpoints)

VS

Future

(mechanistic understanding & AOPs)

Hazard assessment

Traditionally – Evaluation of adverse effects using the whole organism models

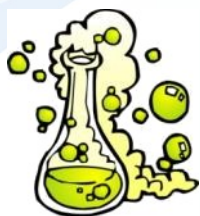

Chemical



Organism



Adverse Effects
Death
Altered Reproduction
Inhibition of Growth

Tumorigenicity
Skin irritation

...



**REGULATORY FOCUS
(APICAL ENDPOINTS)**

Hazard assessment

Traditionally – Evaluation of adverse effects using the whole organism models

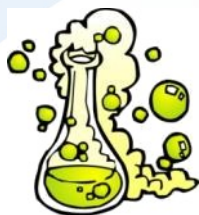

Chemical



Organism



Adverse Effects
Death
Inhibition of Growth
Altered Reproduction
Tumor
Skin irritation
...



New – Ex vivo / in vitro / In chemico / In silico Methods



10^4 Chemicals

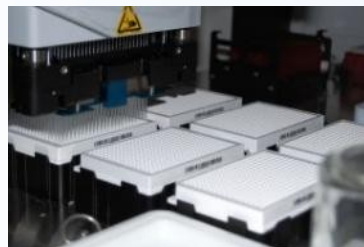

HTS
High-Throughput-Screening

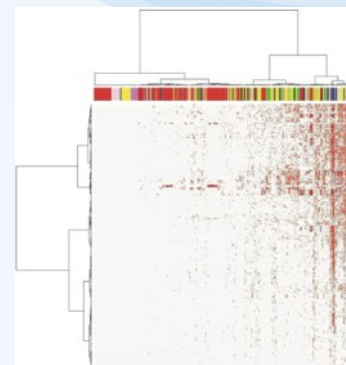

**Chemical-biological interactions,
Mechanistic Toxicological Data**

Key task/question:

How to link MECHANISTIC INFORMATION with APICAL ENDPOINTS ?

MoA and omics are supported by strategic documents

Toxicity Testing in the 21st Century: A Vision and a Strategy

US National Academies of Sciences

<http://www.nap.edu/catalog/11970.html>

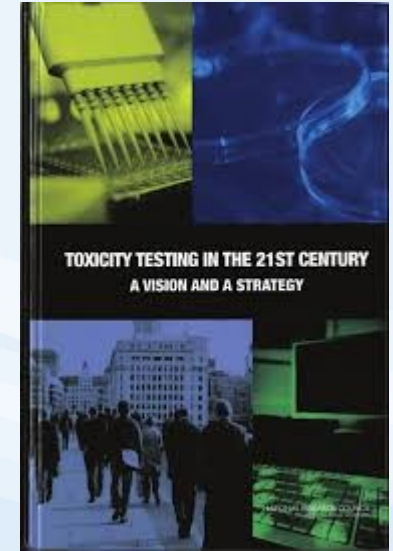

LEARN THE ISSUES | SCIENCE & TECHNOLOGY | LAWS & REGULATIONS | ABOUT EPA

Computational Toxicology Research

You are here: [EPA Home](#) » [Research & Development](#) » [CompTox](#) » [ToxCast™](#)

Key Links

- | | | |
|-----------------------------------|------------------------------------|---|
| CompTox Home | Research Projects | R |
| Basic Information | Chemical Databases | S |
| Organization | CompTox Events | C |

ToxCast™

Screening Chemicals to Predict Toxicity Faster and Better

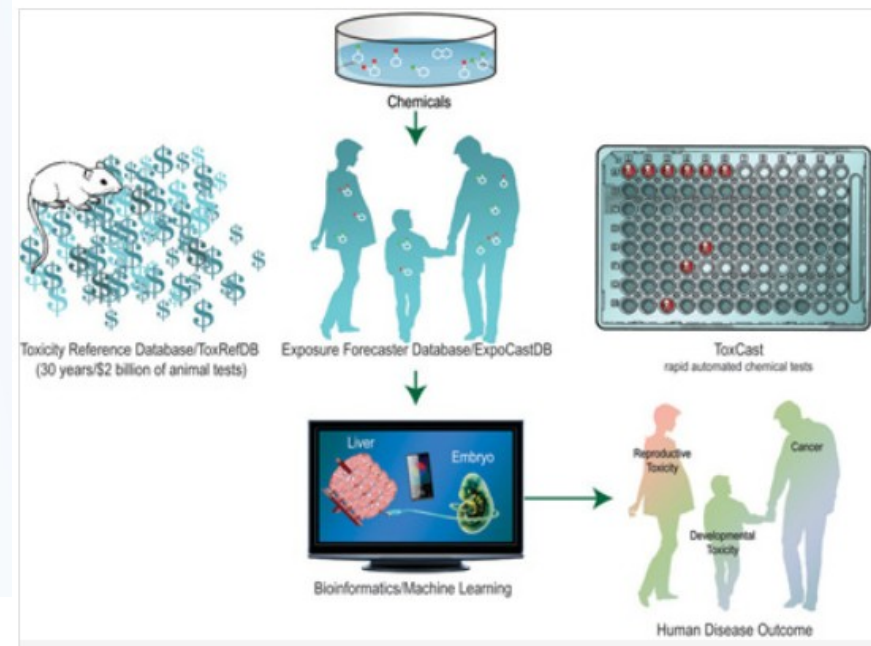

How ToxCast Fits Into CompTox Research



Adverse Outcome Pathways

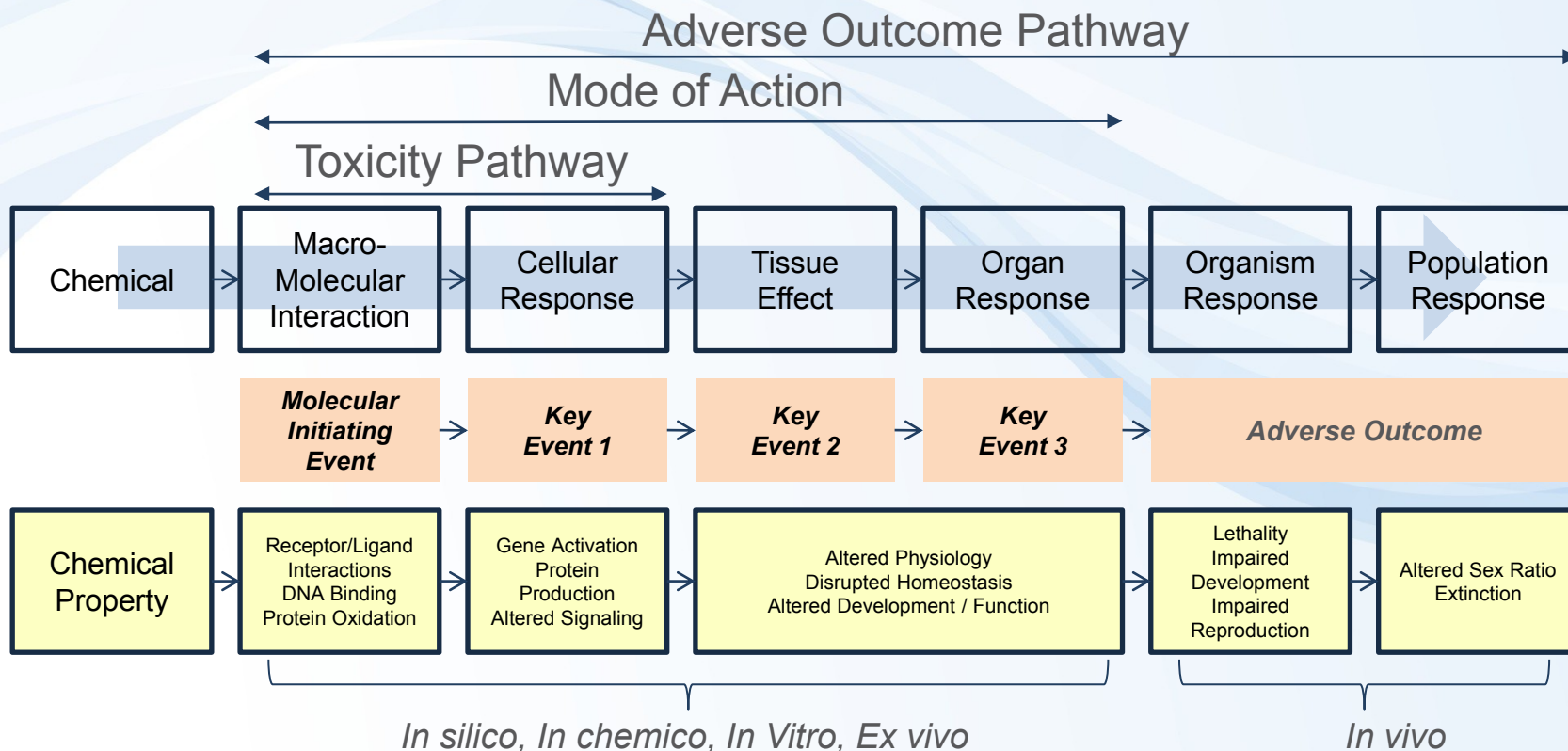

The **EXISTING KNOWLEDGE** is used **to link the** two anchor points: **Molecular Initiating Event (MIE)** and **Adverse Outcome (AO)** **via a series** of intermediate steps: **Key Events**

AOP = Global strategy with support from OECD, EU, USA



OECD.org

Data

Publications

More sites

News

Job vacancies



> A to Z

Search oecd.org



OECD Home

About

Countries

Topics

> Français

[OECD Home](#) > [Chemical safety and biosafety](#) > [Testing of chemicals](#) > Adverse Outcome Pathways, Molecular Screening and Toxicogenomics

> Testing of chemicals

> Assessment of chemicals

> Risk management of chemicals

> Chemical accident prevention, preparedness and response

> Pollutant release and transfer register

> Safety of manufactured nanomaterials

> Agricultural pesticides and biocides

> Biosafety - BioTrack

Adverse Outcome Pathways, Molecular Screening and Toxicogenomics

WHAT'S NEW

SURVEY ON ADVERSE OUTCOME PATHWAYS (AOPS) TO IDENTIFY DEVELOPMENT PRIORITIES

The OECD has launched a survey to explore the utility of AOPs for regulatory assessment of chemicals and to identify development priorities. The objective is to collect feedback on how the AOP concept and/or existing AOPs are already being used for regulatory purposes, to understand where they fall short regarding their utility, and to identify what directions and priorities future AOP development work should embrace to increase their impact on regulatory toxicology and chemical risk assessment.

The survey is mainly for chemical safety regulators who are experiencing a transition in their work towards an increased use of 'alternative' methods and AOPs. However, stakeholders that come from the regulated community and environmental NGOs are also welcome to participate.

> **The survey is now closed. Thank you for your submissions.**

<http://www.oecd.org/chemicalsafety/testing/projects-adverse-outcome-pathways.htm>



cetocoen



EUROPEAN UNION
EUROPEAN REGIONAL DEVELOPMENT FUND
INVESTING IN YOUR FUTURE



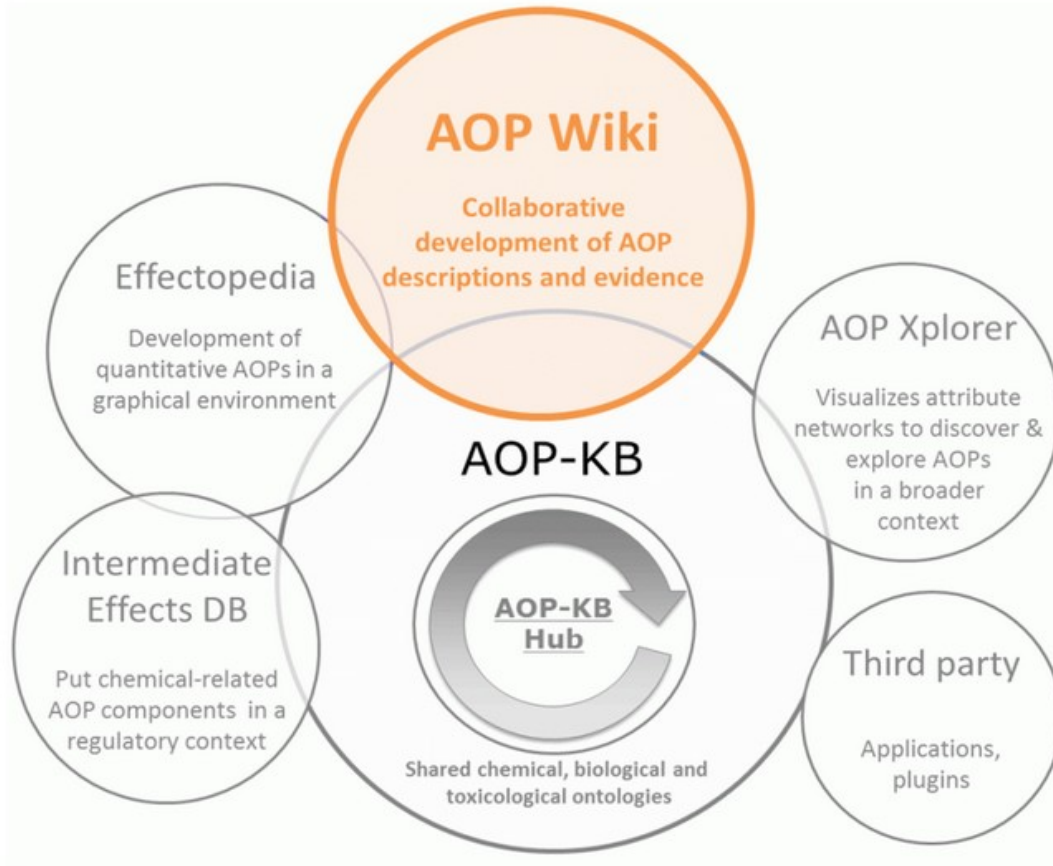

Please click on any of the AOP-KB elements you want to use.
Please note that the AOP-KB is work in progress and more elements will become available over time.

<http://aopkb.org/>

Key documents

OECD Guidance document and a template for developing and assessing adverse outcome pathways (Series No. 184, Series on Testing and Assessment)

Handbook for AOP developers

AOP Wiki

- https://aopkb.org/aopwiki/index.php/Main_Page
- Wiki-based platform for development of AOPs
- Only members of an OECD AOP development project can create / edit AOPs



What AOPs are now in AOP Wiki (spring 2019)



OECD Endorsed (WNT and TFHA)	7	1x ecotoxicology: Aromatase inhibition leading to reproductive dysfunction (in fish)
EAGMST Approved	3	1x Ecotox - Androgen receptor agonism leading to reproductive dysfunction
Other OECD status	40	
Under Development	241	

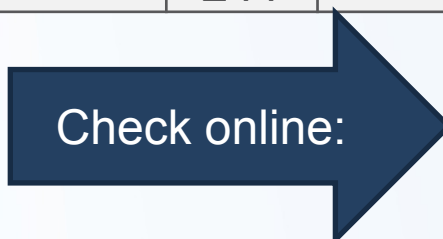

<https://aopwiki.org/aops>

- OECD Extended Advisory Group on Molecular Screening and Toxicogenomics (EAG MST)
- The Working Group of the National Coordinators of the Test Guidelines Programme (WNT)

AOP Example: MIE aromatase inhibition

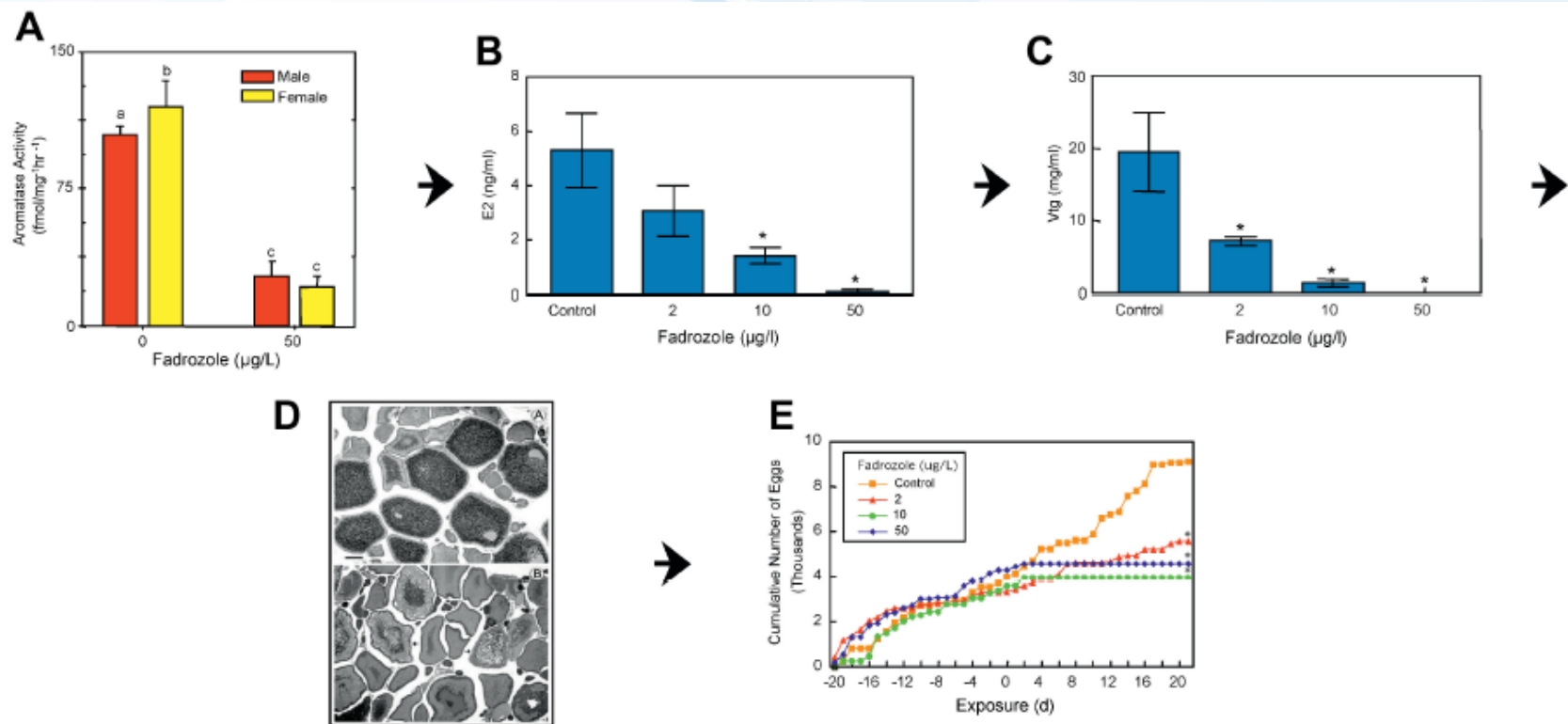
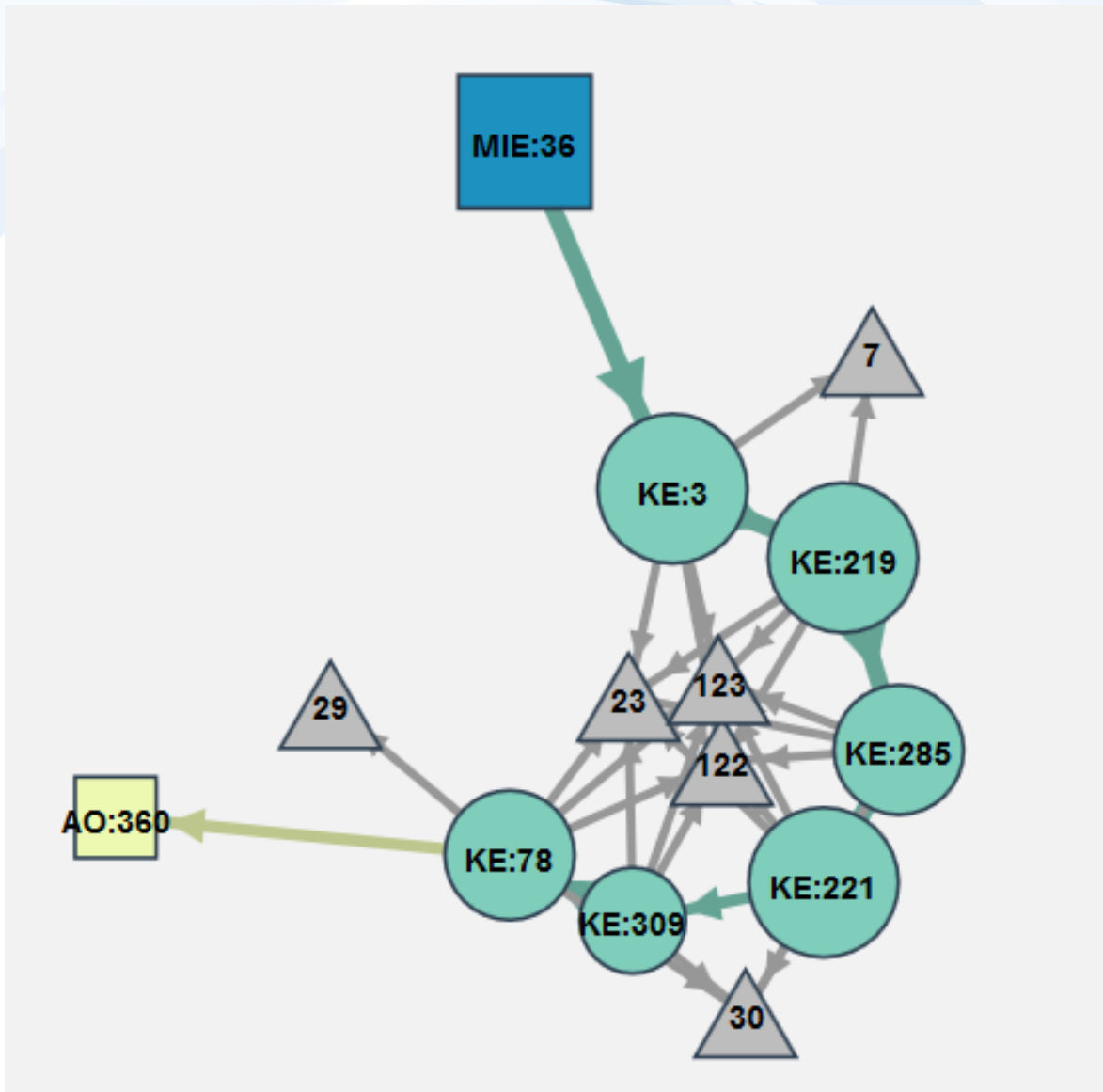







Fig. 3. An adverse outcome pathway in fish [2,50]. Aromatase inhibitor example. (A) Aromatase inhibition by fadrozole; (B) Reduction in circulating estradiol; (C) Reduction in circulating vitellogenin (Vtg); (D) Histopathology of ovarian tissue, top panel normal ovary, bottom panel fadrozole treated; note oocyte atresia; (E) Adverse outcome on egg production–fecundity (© Elsevier, Used with permission,)

Environmental Toxicology and Chemistry, Vol. 30, No. 1, pp. 64–76, 2011

Aromatase inhibition leading to reproductive dysfunction (in fish)

<https://aopwiki.org/wiki/index.php/Aop:25>



MIE		MIE:1
KE		KE:2
AO		AO:3
Other AOP including this KE		57
Indirect relationship		
Direct relationship		
*Size of node reflects essentiality of event		
*Width of line reflects strength of evidence for relationship		

AOP Example from RECETOX: Modulation of RAR/RXR → developmental toxicity in fish

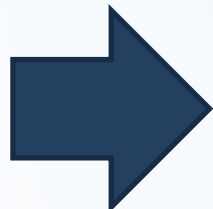
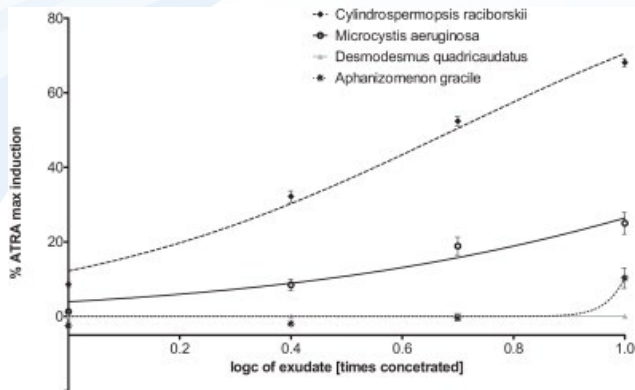

Activation of RAR/RXR

in P19/A15 cells by atRA and cyanobacterial metabolites

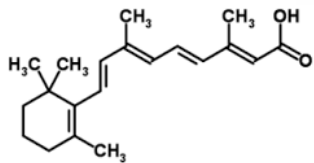

atRA

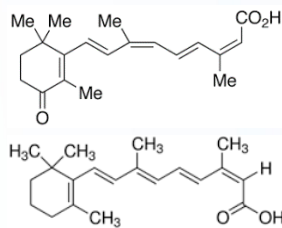

other RAs in cyanos

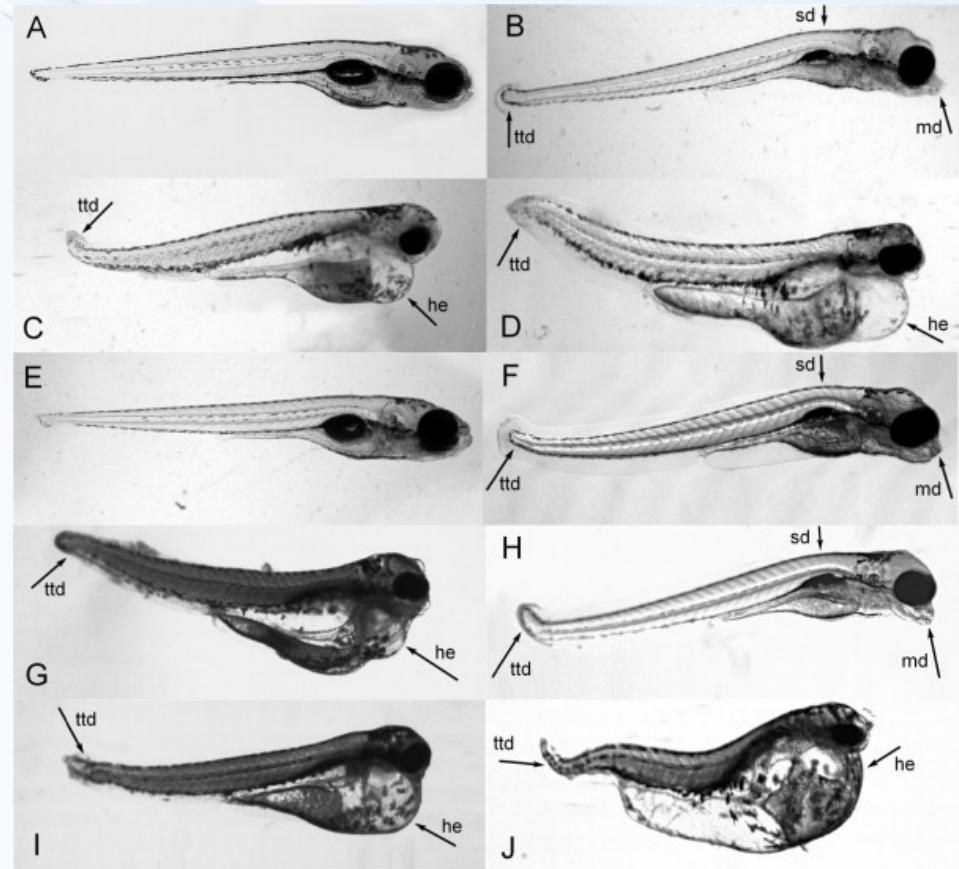

ZF exposed to ATRA and cyanobacterial (120 hpf) - Control (A), exudates of *C. raciborskii* 3.3 (B) and 10 (C), *M. aeruginosa* 10 (D) and *D. quadricaudatus* 17 (E). ATRA 4 µg/L (13.3 nM) (F), 12 µg/L (40 nM) ((G) and (H)), 36 µg/L (I) and 108 µg/L (J).



International QSAR Foundation

Effectopedia

The Online Encyclopedia of Adverse Effect Pathways

- <http://www.effectopedia.org/> -> link to program download
- Visually Expresses AOPs in their **biological context**:
 - Life-stage, Taxonomy, Gender, Time-to-effect..
- **Quantitative Relationships**
- **ADME** (Absorption, Distribution, Metabolism, Excretion)
- Open-knowledge, crowd-sourcing
- Formal approval not required to enter / modify
- Credit to authors / reviewers
- Even fragments of information are welcome (any contribution)
- Export<->Import from/to AOP Wiki & others

Related Projects & Studies & Databases

- **TOXNET** - <http://toxnet.nlm.nih.gov/>
 - searching databases on toxicology, hazardous chemicals, environmental health, and toxic releases
- **Tox21** - <http://www.epa.gov/ncct/Tox21/>
 - 10,000 chemicals
 - 14 concentrations, 4 logs, 3 replicates
 - 1536 well plates, 2-8 uL volumes
 - 50+ assays
- **ToxCast** - <http://www.epa.gov/ncct/toxcast/>
 - App. 2000 chemicals
 - 700+ assay, 300 signaling pathways
 - DATA AVAILABLE iCSS Dashboard
 - <http://actor.epa.gov/dashboard>
 - <http://ww.epa.gov/ncct/toxcast/data.html>



Related Projects & Studies & Databases

- **ToxRefDB (Toxicity Reference Database)**
 - *in vivo* toxicological data
 - <http://actor.epa.gov/toxrefdb/faces/Home.jsp>
- **ExpoCast**
 - information on human exposures
 - <http://www.epa.gov/ncct/expocast/>
- **Human Toxome Project**
 - information on human exposures
 - <http://www.ewg.org/sites/humantoxome/>
- **Agriculture Health Study**
 - Occupational Exposure to Pesticides – a cohort study
 - <http://aghealth.nih.gov/>

Summary

- **Toxicology is about doses**

- The goal is LD(LC)50 or NOAEL/NOEC



- **Legislation defines**

... what assays and how to do them

- About 30 assays
- The most widely used standard - OECD Guidelines for Testing of Chemicals



- **Replacing „black box“ in traditional testing**

- Synthesis of mechanistic and omics data
- Adverse Outcome Pathways
- Strategically supported by OECD, EU, USA



Do we need testing with animals?

Are there alternatives



3Rs

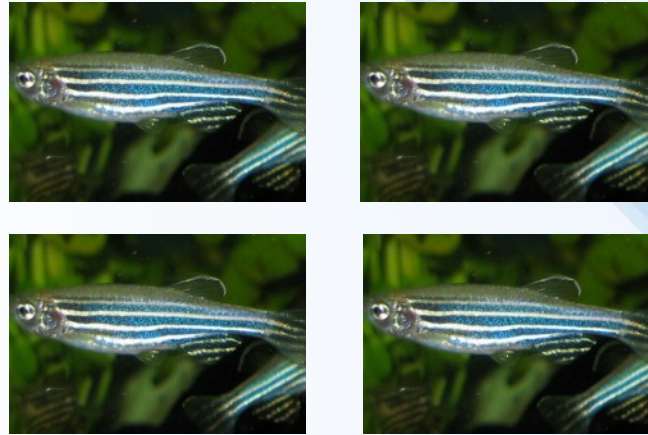

REPLACEMENT



REDUCTION



Online Computer Simulations and Applications



cetocoen



REFINEMENT



European Policies on 3Rs



ENVIRONMENT

DIRECTIVE 2010/63/EU OF THE EUROPEAN PARLIAMENT AND OF THE COUNCIL of 22 September 2010 on the protection of animals used for scientific purposes

Figure 1.1
Percentages of animals used by classes in the Member States

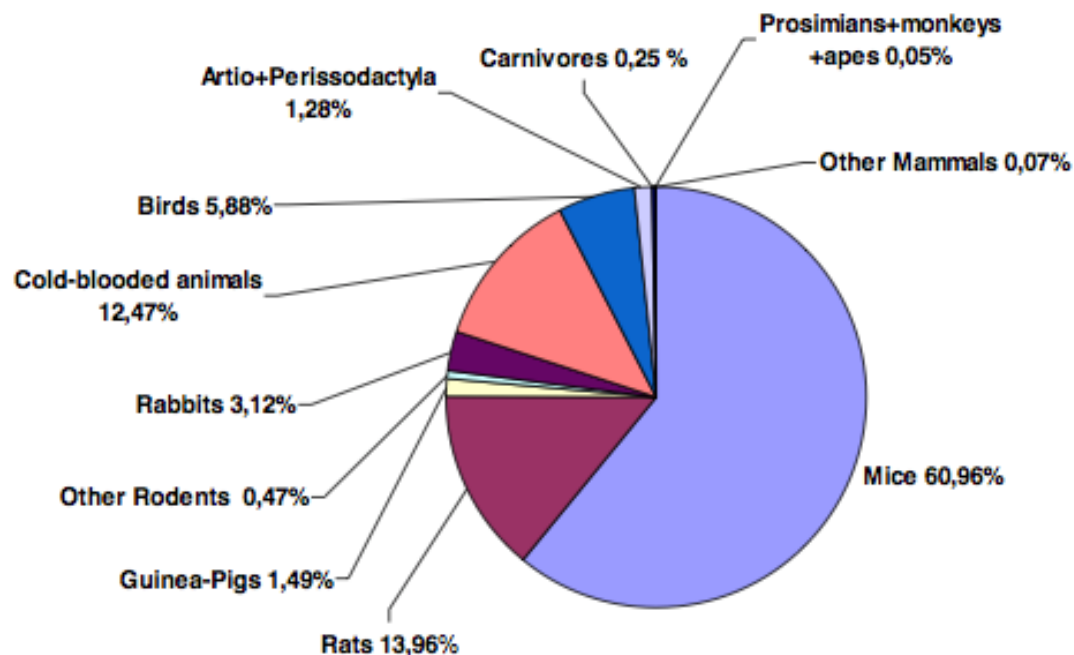

Use of animals in EU (2011)

Table 1.0: Changes in species number and proportion between 2008 and 2011

Species	Number of animals in EU 27	Number of animals in EU 27	Change since 2008	% change by species	
	2008	2011			
1.a	Mice (<i>Mus musculus</i>)	7122188	6999312	-122876	-1,73
1.b	Rats (<i>Rattus norvegicus</i>)	2121727	1602969	-518758	-24,45
1.c	Guinea-Pigs (<i>Cavia porcellus</i>)	220985	171584	-49401	-22,35
1.d	Hamsters (<i>Mesocricetus</i>)	32739	25251	-7488	-22,87
1.e	Other Rodents (other Rodentia)	39506	28465	-11041	-27,95
1.f	Rabbits (<i>Oryctolagus cuniculus</i>)	333213	358213	25000	7,50
1.g	Cats (<i>Felis catus</i>)	4088	3713	-375	-9,17
1.h	Dogs (<i>Canis familiaris</i>)	21315	17896	-3419	-16,04
1.i	Ferrets (<i>Mustela putorius furo</i>)	3208	2540	-668	-20,82
1.j	Other Carnivores	2853	4982	2129	74,62
1.k	Horses, donkeys and cross-breeds (<i>Equidae</i>)	5976	6686	710	11,88
1.l	Pigs (<i>Sus</i>)	92813	77280	-15533	-16,74
1.m	Goats (<i>Capra</i>)	3840	2907	-933	-24,30
1.n	Sheep (<i>Ovis</i>)	30190	28892	-1298	-4,30
1.o	Cattle (<i>Bos</i>)	33952	30914	-3038	-8,95
1.p	Prosimians (<i>Prosimia</i>)	1261	83	-1178	-93,42
1.q	New World Monkeys (<i>Ceboidea</i>)	904	700	-204	-22,57
1.r	Old World Monkeys (<i>Cercopithecoidea</i>)	7404	5312	-2092	-28,25
1.s	Apes (<i>Hominoidea</i>)	0	0	0	0,00
1.t	Other Mammals (other Mammalia)	5704	7888	2184	38,29
1.u	Quail (<i>Coturnix coturnix</i>)	9626	5614	-4012	-41,68
1.v	Other birds (other Aves)	754485	669451	-85034	-11,27
1.w	Reptiles (<i>Reptilia</i>)	4101	3824	-277	-6,75
1.x	Amphibians (<i>Amphibia</i>)	61789	29583	-32206	-52,12
1.y	Fish (<i>Pisces</i>)	1087155	1397462	310307	28,54
1.z	TOTAL	12001022	11481521	-519501	-4,33



JOINT RESEARCH CENTRE

Tracking System for Alternative methods towards Regulatory acceptance (TSAR)

European Commission > EU Science Hub > EURL ECVAM > TSAR

Advanced Search



TRACKING SYSTEM FOR ALTERNATIVE METHODS TOWARDS REGULATORY ACCEPTANCE

TSAR tracks the progress of alternative, non-animal methods, for testing chemicals or biological agents such as vaccines towards acceptance as a recognised test method for use in various sectors



FEATURED TEST METHODS

KeratinoSens assay for the testing of skin sensitizers

Test Method Number:	TM2010-03 (EU)	Stage of Submission:	Assessment finalised
Short Name of TM:	KeratinoSens	Stage of Validation:	Finalised
Responsible Organisation:	EURL ECVAM - European Union	Stage of Peer-review:	Finalised
DB-ALM Protocol No.:	155	Stage of Recommendation:	Published
General Comments:	The validation was performed externally between 2009 and 2010	Stage of Regulatory acceptance/Standards:	Adopted



Monocyte Activation Test

Test Method Number:	TM2016-06 (BRA)	Stage of Validation:	Ongoing
Short Name of TM:	MAT	Stage of Regulatory acceptance/Standards:	Drafting of new regulatory standard/guideline
Responsible Organisation:	BraCVAM - Brazil		

- >60 3Rs Tests submitted to ECVAM since 2008 (update 01/2015)
- 10 validated or ongoing validation => Prioritisation!

Alternative Methods – R&D to Implementation

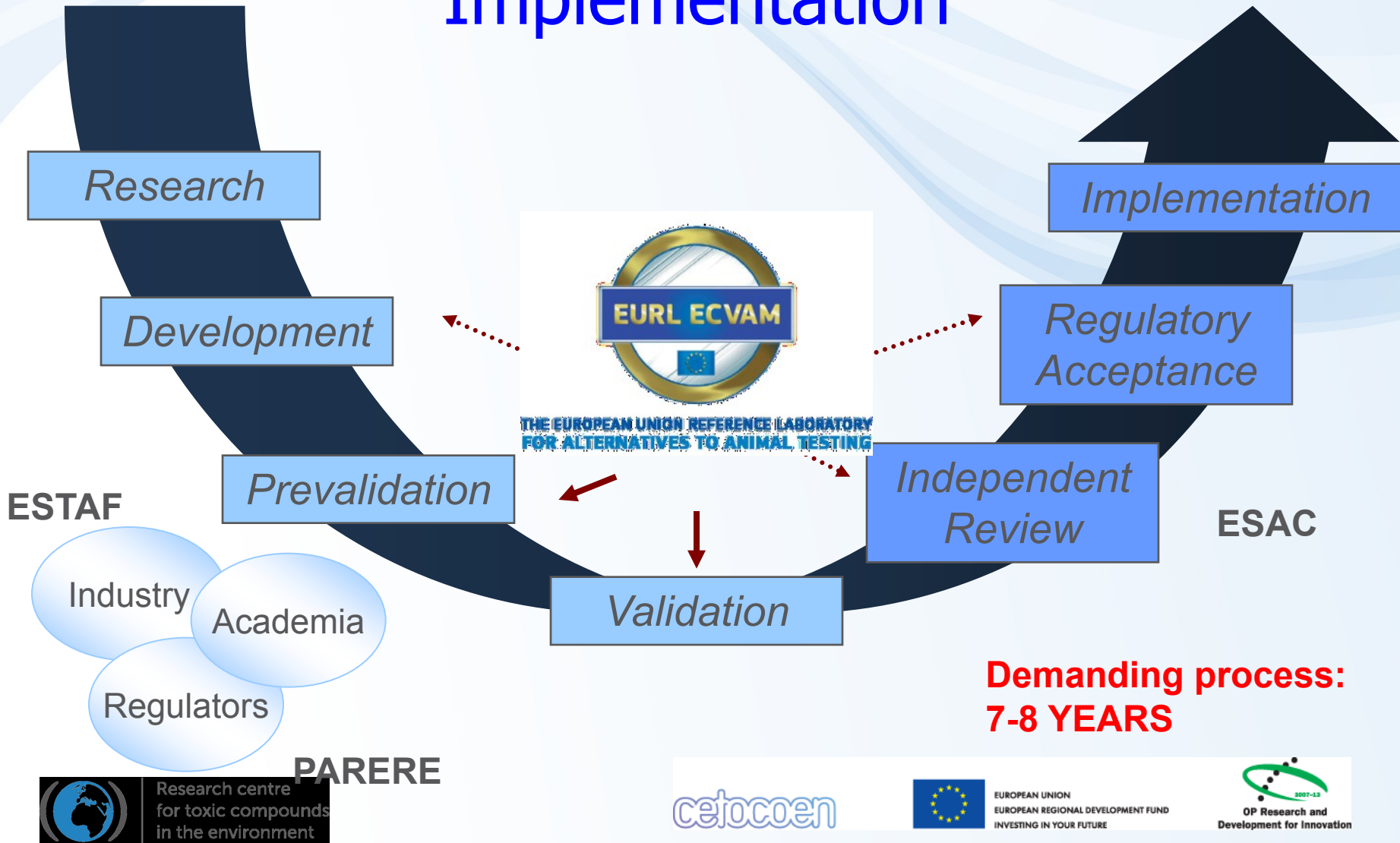

COMPUTATIONAL (ECO)TOXICOLOGY



PBPK models

PBPK (PBTK)

Physiologically based pharmacokinetic (toxicokinetic) models

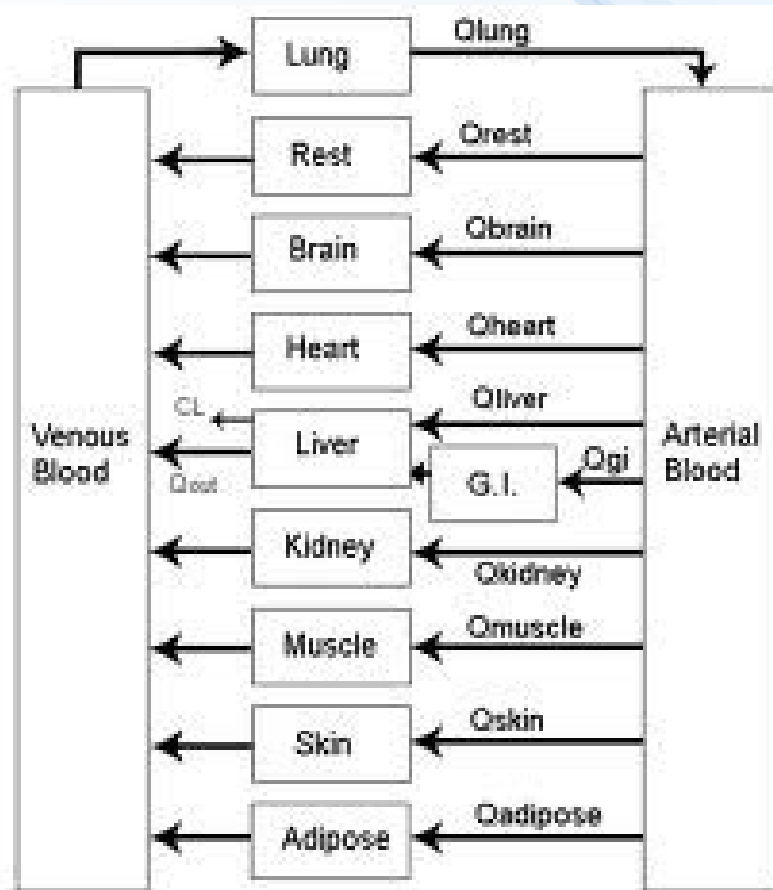
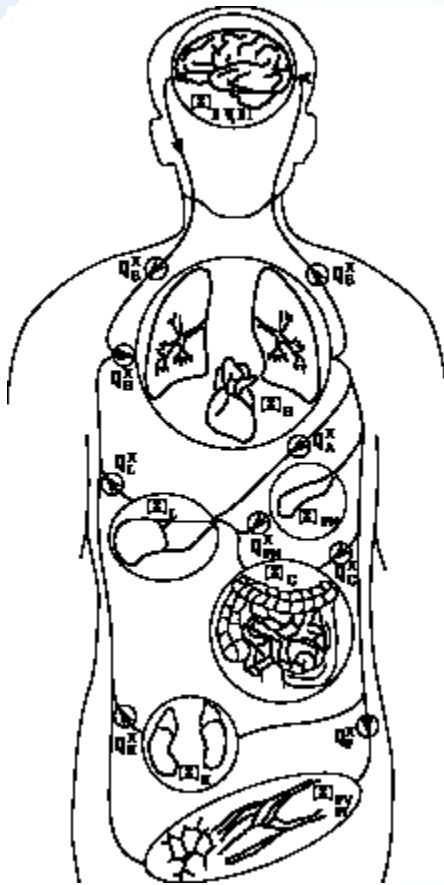

Fragmentation of a complex system to „boxes“

→ All Processes described by arrows (mathematical equations)

Example – computational toxicology for EDCs

Li et al. *BMC Systems Biology* 2011, 5:63
<http://www.biomedcentral.com/1752-0509/5/63>



RESEARCH ARTICLE

Open Access

A computational model of the hypothalamic - pituitary - gonadal axis in female fathead minnows (*Pimephales promelas*) exposed to 17α -ethynylestradiol and 17β -trenbolone

Zhenhong Li¹, Kevin J Kroll², Kathleen M Jensen³, Daniel L Villeneuve³, Gerald T Ankley³, Jayne V Brian⁴, María S Sepúlveda⁵, Edward F Orlando⁶, James M Lazorchak⁷, Mitchell Kostich⁷, Brandon Armstrong⁸, Nancy D Denslow² and Karen H Watanabe^{1*}

Li (2011) BMC Systems Biology

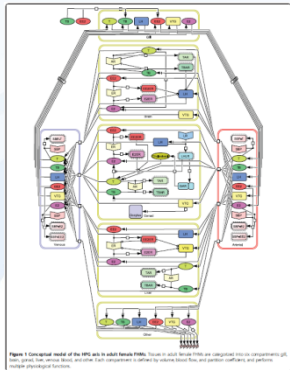
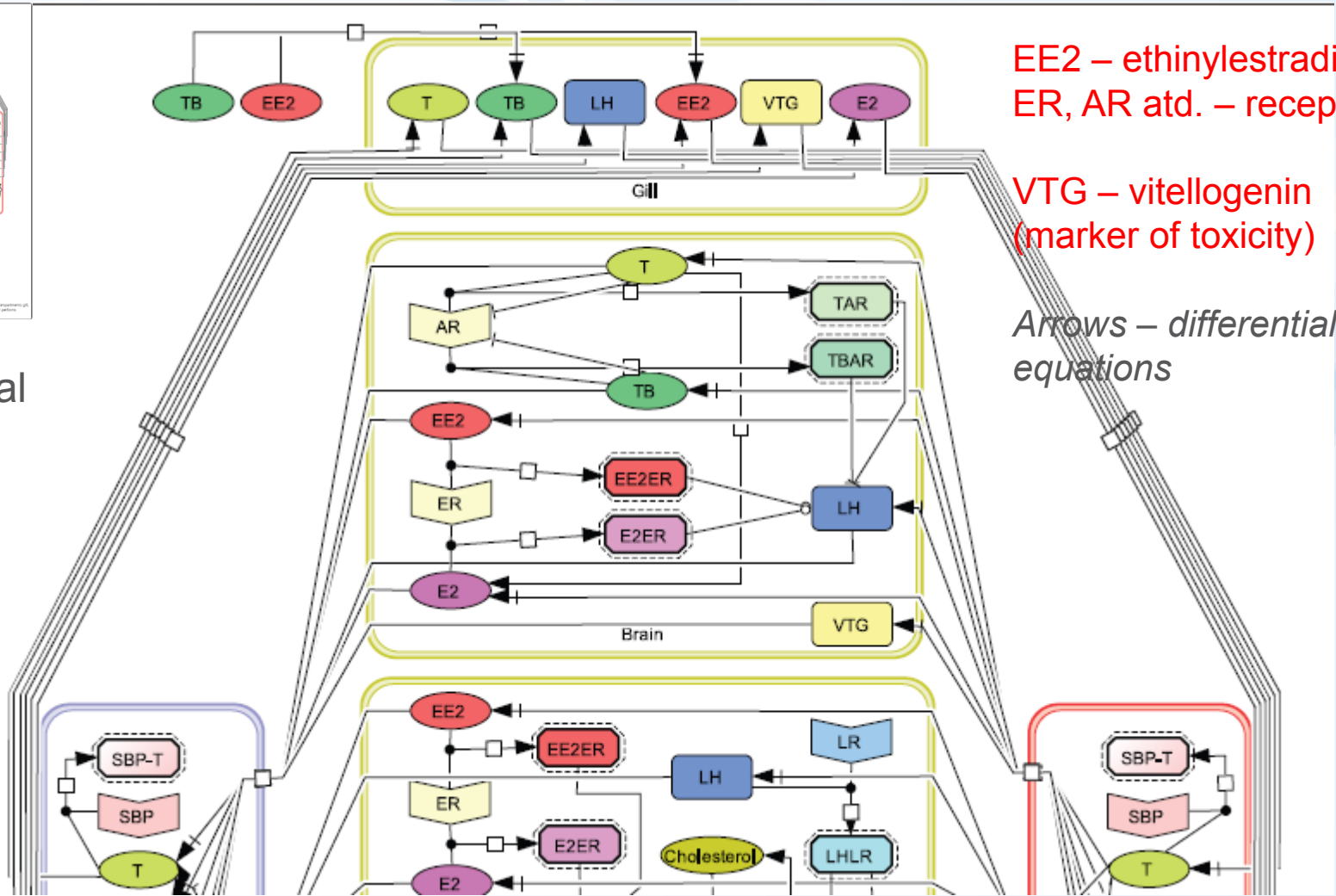

Figure 1 Conceptual model of the HPG axis in adult female F0 fish. The model is a network of signaling molecules and receptors. The model is divided into sections for Gill, Brain, and other tissues, showing how these hormones and receptors interact within and between these systems.

Conceptual model



EE2 – ethinylestradiol
ER, AR atd. – receptors

VTG – vitellogenin
(marker of toxicity)

Arrows – differential equations

Li (2011) BMC Systems Biology

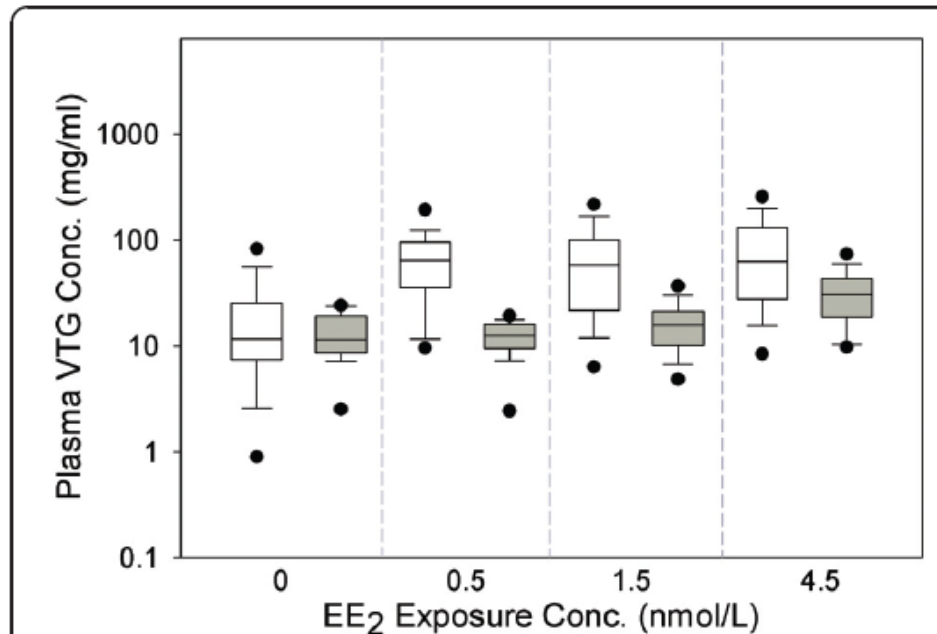

Figure 6 Comparison of model predictions with measured data in female FHM_s exposed to EE₂. $n = 28$ at each sampling time.

White boxes represent model predictions, and grey boxes represent measured data [42]. The x-axis represents EE₂ concentrations in ng/L. The solid line within the box marks the median; the boundary of the box farthest from zero indicates the 75th percentile; the boundary of the box closest to zero indicates the 25th percentile; the whisker (error bar) farthest from zero marks the 90th percentile; whisker (error bar) closest to zero marks the 10th percentile; the circle farthest from zero marks the 95th percentile; and the circle closest to zero marks the 5th percentile.

Results:

MODELLED (white)
Vs
MEASURED (grey)

...good comparable



Update – quantitative mechanistic/computational toxicology

 OPEN ACCESS  PEER-REVIEWED

RESEARCH ARTICLE

A Computational Model of the Rainbow Trout Hypothalamus-Pituitary-Ovary-Liver Axis

Kendall Gillies, Stephen M. Krone, James J. Nagler, Irvin R. Schultz 

Published: April 20, 2016 • <https://doi.org/10.1371/journal.pcbi.1004874>

4 Save	1 Citation
1,656 View	4 Share

Article	Authors	Metrics	Comments	Related Content
				

[Download PDF](#) 

[Print](#) [Share](#)

 Check for updates

[Abstract](#)

[Author Summary](#)

[Introduction](#)

[Methods](#)

Abstract

Reproduction in fishes and other vertebrates represents the timely coordination of many endocrine factors that culminate in the production of mature, viable gametes. In recent years

Subject Areas



EUROPEAN UNION
EUROPEAN REGIONAL DEVELOPMENT FUND
INTEGRITY IN RESEARCH



Update – quantitative mechanistic/computational toxicology

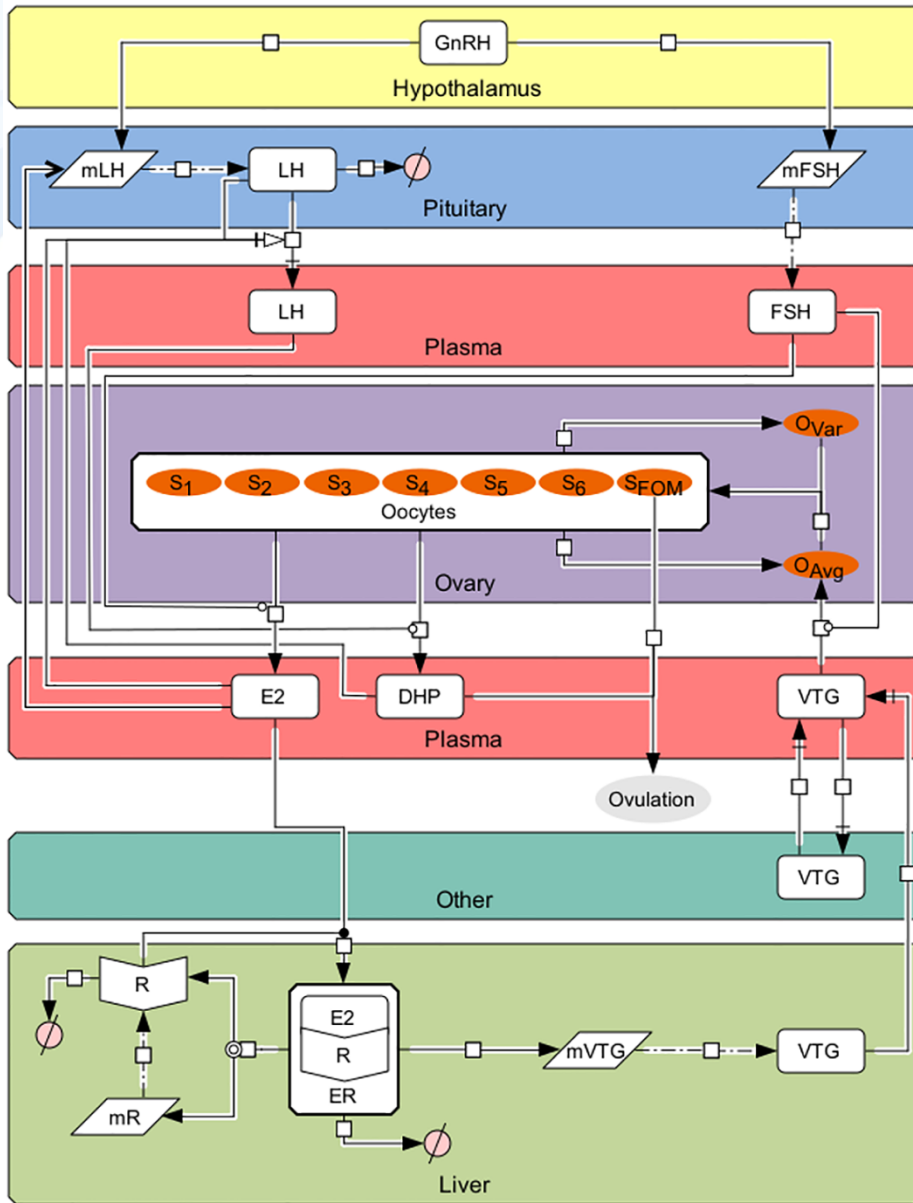
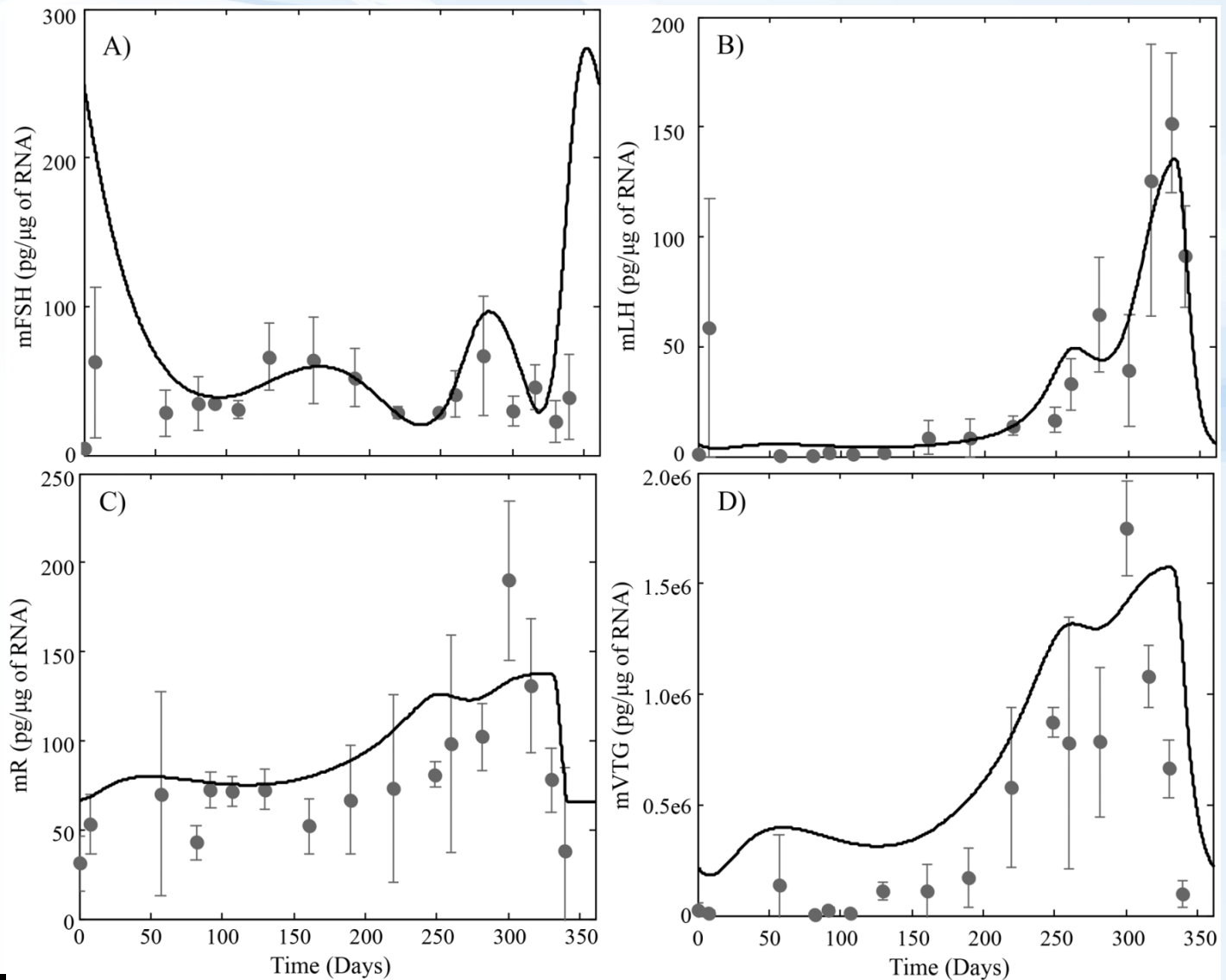

Fig 1. The HPO signaling network in rainbow trout as formulated in our model.

Arrows and symbols on graph follow CellDesigner vs. 4.4 notation (www.celldesigner.org). GnRH is secreted from the hypothalamus into the pituitary stimulating the production of mFSH and mLH, which then leads to formation of FSH and LH, respectively. FSH, which is being continuously secreted from the pituitary, travels to the ovaries to stimulate production of E2. E2 then travels to the liver to bind with E2 receptors (R; translated from mR) to form ER. ER then stimulates the production of mVTG, which produces VTG_L. Secreted VTG then travels from the liver to the ovaries via the plasma (VTG_P) where it is absorbed by follicles in stages 3 through 6 (the proportion of follicles in these stages are denoted by S_j, j = 3, 4, 5, and 6) during vitellogenesis, the rate of which is affected by FSH_P, to promote oocyte growth (O_{AvG}). Oocyte growth then progresses the oocytes through the stages using a Weibull distribution created from O_{AvG} together with O_{Var}. In the later stages LH_P stimulates the oocytes to produce DHP. Finally, oocytes undergo final maturation (S_{FOM}) and combined with DHP, determine when the fish ovulates

Update – quantitative mechanistic/computational toxicology

Fig 3. HPOL **model predictions** for (A) pituitary levels of FSH $_{\beta}$ subunit mRNA, (B) pituitary levels of LH $_{\beta}$ subunit mRNA, (C) Hepatic levels of E2 receptor mRNA and (D) Hepatic levels of VTG mRNA
Observed data (dark grey circles; mean TG mRn = 3)



Global Climate Change

INTERACTIONS BETWEEN CHEMICAL AND CLIMATE STRESSORS: A ROLE FOR MECHANISTIC TOXICOLOGY IN ASSESSING CLIMATE CHANGE RISKS

MICHAEL J. HOOPER,^{*,†} GERALD T. ANKLEY,[‡] DANIEL A. CRISTOL,[§] LINDLEY A. MARYOUNG,^{||}
 PAMELA D. NOYES,[#] and KENT E. PINKERTON^{††}

[†]U.S. Geological Survey, Columbia Environmental Research Center, Columbia, Missouri

[‡]U.S. Environmental Protection Agency, Office of Research and Development, National Health and Environmental Effects Research Laboratory

[§]Institute for Integrative Bird Behavior
^{||}Department of
[#]Nicholas Sc
^{††}Center for Health

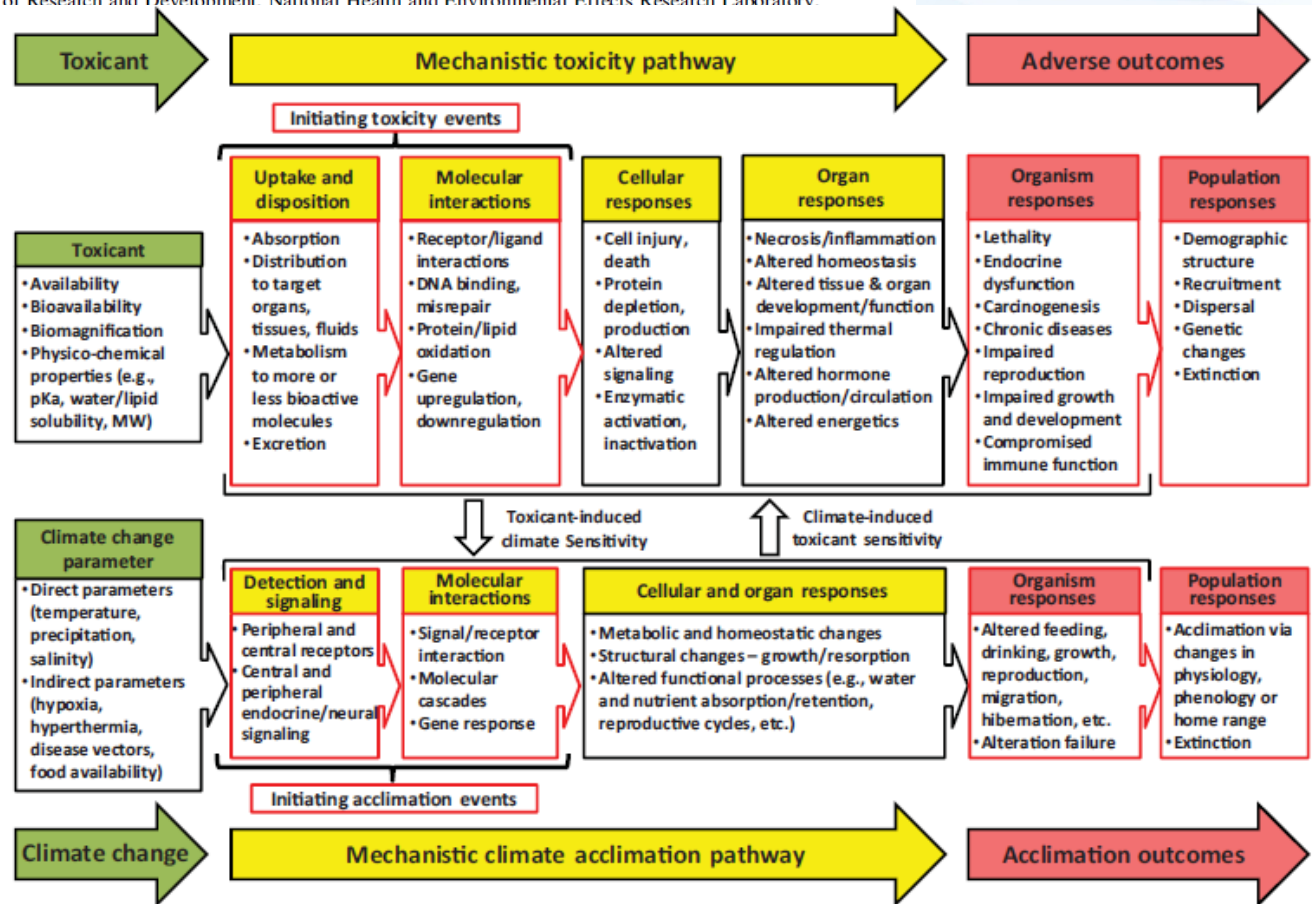

Global Climate Change

INTERACTIONS BETWEEN CHEMICAL AND CLIMATE STRESSORS: A ROLE FOR MECHANISTIC TOXICOLOGY IN ASSESSING CLIMATE CHANGE RISKS

MICHAEL J. HOOPER,*† GERALD T. ANKLEY,‡ DANIEL A. CRISTOL,§ LINDLEY A. MARYOUNG,||
 PAMELA D. NOYES,# and KENT E. PINKERTON††

†U.S. Geological Survey, Columbia Environmental Research Center, Columbia, Missouri

‡U.S. Environmental Protection Agency, Office of Research and Development, National Health and Environmental Effects Research Laboratory, Mid-Continent Ecology Division, Duluth, Minnesota

§Institute for Integrative Bird Behavior Studies, Department of Biology, The College of William and Mary, Williamsburg, Virginia, USA

||Department of Environmental Sciences, University of California, Riverside, California, USA

#Nicholas School of the Environment, Duke University, Durham, North Carolina, USA

††Center for Health and the Environment, University of California at Davis, Davis, California, USA

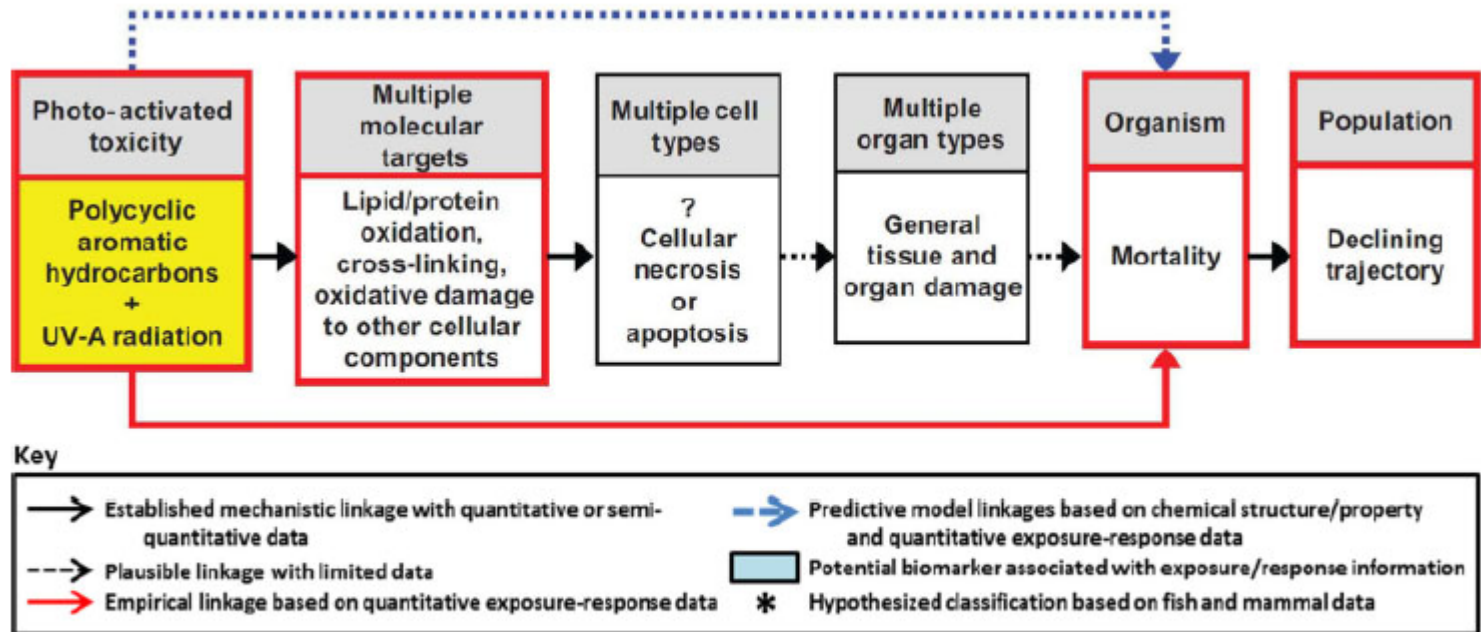

Fig. 2. Adverse outcome pathway of the interaction of ultraviolet radiation with polycyclic aromatic hydrocarbons. With permission from Ankley et al. [14]. [Color figure can be seen in the online version of this article, available at wileyonlinelibrary.com.]



Closing remarks

- Ecotoxicology is exciting **science!**
- **Interface**: science and society
- Many **opportunities**
- Sometimes **hard work**
10% inspiration and 90% „perspiration“



- Be **creative**: move frontiers
- **Keep the purpose** in mind
- **Be critical**: do not accept perceptions as facts
- **Speak up**: you have something to say!